

# ELECTRICAL COMMUNICATION

*Technical Journal of the  
International Telephone and Telegraph Corporation  
and Associate Companies*

•

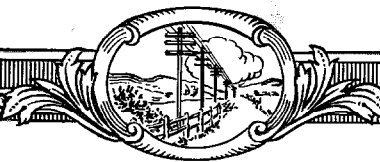
CENTRALIZED SUPERVISION FOR A 65-KILOVOLT POWER NETWORK  
TELEGRAPH RELAYS WITH RADIO-INTERFERENCE SUPPRESSORS  
GAIN EQUALIZATION OF LINEAR SERVOMECHANISMS  
COMPANDOR SYSTEM FOR SHORT-HAUL CARRIER TELEPHONY  
TRICON INTERLOCK SYSTEM FOR RAILROAD SWITCHING  
LOSS FORMULAS FOR SECOND-ORDER HOMOGENEOUS GRADINGS



Volume 35

1958

Number 1



# ELECTRICAL COMMUNICATION

*Technical Journal of the  
International Telephone and Telegraph Corporation  
and Associate Companies*

H. P. WESTMAN, Editor  
J. E. SCHLAIKJER, Assistant Editor

## EDITORIAL BOARD

G. H. Brodie H. G. Busignies R. S. Caruthers G. Chevigny A. G. Clavier E. M. Deloraine  
F. R. Furth G. Goudet J. A. Henderson B. C. Holding J. Kruithof W. P. Maginnis  
A. W. Montgomery E. D. Phinney G. Rabuteau P. C. Sandretto C. E. Scholz T. R. Scott  
C. E. Strong F. R. Thomas H. B. Wood

Published Quarterly by the  
**INTERNATIONAL TELEPHONE AND TELEGRAPH CORPORATION**  
67 BROAD STREET, NEW YORK 4, NEW YORK, U.S.A.

Edmond H. Leavey, President  
C. Douglas Webb, Secretary

Subscription, \$2.00 per year; single copies, 50 cents  
Copyrighted © March, 1958 by International Telephone and Telegraph Corporation

Volume 35

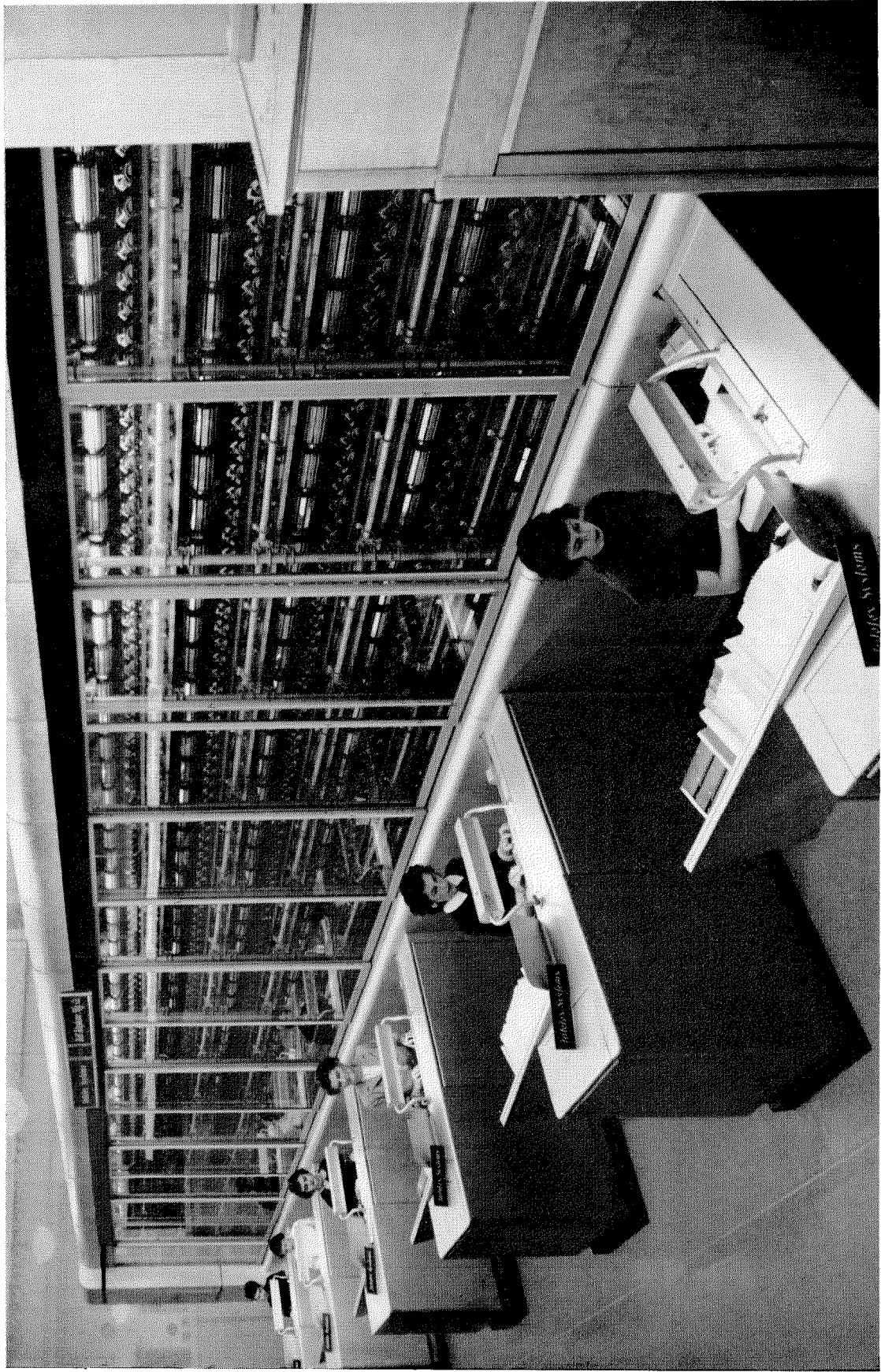
1958

Number 1

## CONTENTS

|  |    |
|--|----|
| CENTRALIZED SUPERVISION OF A 65-KILOVOLT POWER NETWORK .....   | 3  |
| <i>By Lucien R. Gillon</i>   |    |
| TELEGRAPH RELAYS WITH BUILT-IN RADIO-INTERFERENCE SUPPRESSORS .....  | 13 |
| GAIN EQUALIZATION OF LINEAR SERVOMECHANISMS THAT SOLVE NONLINEAR EQUATIONS .....                                 | 15 |
| <i>By Guy E. Adams</i>   |    |
| COMPANDOR SYSTEM Z6NC FOR SHORT-HAUL CARRIER TELEPHONY .....   | 28 |
| <i>By L. Christiansen, F. Buchholtz, and W. Zaiser</i>   |    |
| TRICON, AN ELECTRIC-DIAGRAM INTERLOCK SYSTEM FOR RAILROAD SWITCHING  | 47 |
| <i>By Wilhelm Schmitz</i>  |    |
| LOSS FORMULAS FOR HOMOGENEOUS GRADINGS OF THE SECOND ORDER IN TELEPHONE SWITCHING EMPLOYING RANDOM HUNTING ..... | 57 |
| <i>By Jakob Kruithof</i>   |    |
| UNITED STATES PATENTS ISSUED TO INTERNATIONAL TELEPHONE AND TELEGRAPH SYSTEM, AUGUST-OCTOBER 1957 .....          | 69 |
| RECENT TELECOMMUNICATION DEVELOPMENTS—   |    |
| AWARD FOR PLANAR-GRID DISC-SEAL TRIODE .....   | 46 |
| FUNDAMENTAL PRINCIPLES OF TRANSISTORS (BOOK) .....   | 46 |
| CONTRIBUTORS TO THIS ISSUE .....   | 71 |





The trend toward automation now includes postal operations. The automatic letter sorter pictured above has been installed in the main post office in Washington, D. C. by Intelix Systems Incorporated; the equipment was designed and manufactured by Bell Telephone Manufacturing Company, Antwerp, Belgium. Operators man six positions of the

machine, which can distribute 18 000 pieces of mail per hour to 300 different destination bins. The operators send each letter to its proper destination bin by merely pressing three buttons on a keyboard corresponding to a destination code. The employment of the machine doubles the efficiency of sorting operations over manual sorting methods.

# Centralized Supervision of a 65-Kilovolt Power Network

By LUCIEN R. GILLON

*Compagnie Générale de Constructions Téléphoniques; Paris, France*

**W**ARTIME destruction stimulated a modernization program of the 65-kilovolt electricity production and distribution system used by several coal mines under control of the Groupe des Houillères du Bassin de Lorraine in the Lorraine region of France. This is the first high-voltage network operated by a European coal or steel pool to be successfully put under remote supervision

prevent any power failures. The power equipment and distribution system have been designed to ensure uninterrupted operation and where such might be needed, emergency installations have been provided. Information on the entire system is transmitted to supervisory operating centers at Saint Avold and Petite Rosselle, from which immediate action can be taken to correct any abnormal condition that may arise.

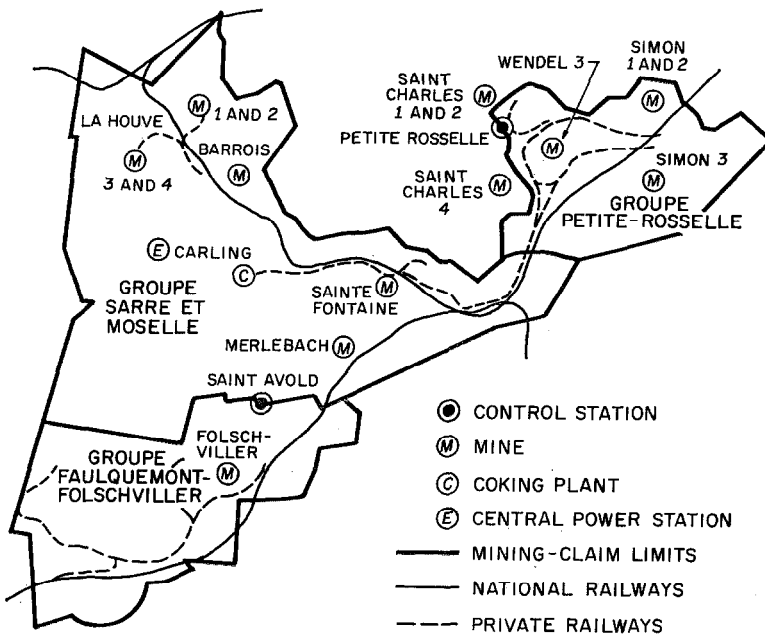


Figure 1—Lorraine coal fields.

## 1. Distribution Network

The system takes power from the generating station at Carling and distributes it at 65 kilovolts to 19 transformer stations, the secondary voltages being either 3000 or 5000 volts. There are two control centers, one in Saint Avold for the western sector and the other in Petite Rosselle for the eastern sector. The locations of these control and transformer stations are shown in Figure 2.

The transformer stations are in the vicinity of the operating or ventilating shafts of the mines. As is usual, several stations will be supplied over a loop that permits power to be

transmitted in either direction in case of a fault.

The few stations not on these loops have duplicate lines to ensure continued operation. Power is also available from the national power network and arrangements are under consideration for a connection to the Sarre system and for duplicate lines between the two control stations. Each transformer station has two sets of incoming busbars to which the transformers may be connected either to ensure operation in case of damage to part of the station or for maintenance work.

through the use of telephone-type apparatus. From 1946 to 1954, coal production was increased from 7 to 13 million tons chiefly as a result of increased mechanization. In addition, plants have been built to produce coke and other coal derivatives that now process nearly a quarter of the coal production. These not only increased substantially the requirements for electric power but existing transformer stations had to be modernized and new ones installed. The major facilities are shown in Figure 1.

The output of these mines and plants is so important that every effort has been made to



## 2. Centralized Control

The design is based on the use of operators at the central control stations to decide and initiate changes that are effected by suitable equipment in the transformer stations. Previously, in-

but great damage could result if the wrong transformer station should receive certain orders intended for another station. Safety is therefore the predominant feature underlying the design of remote-control systems for power networks.

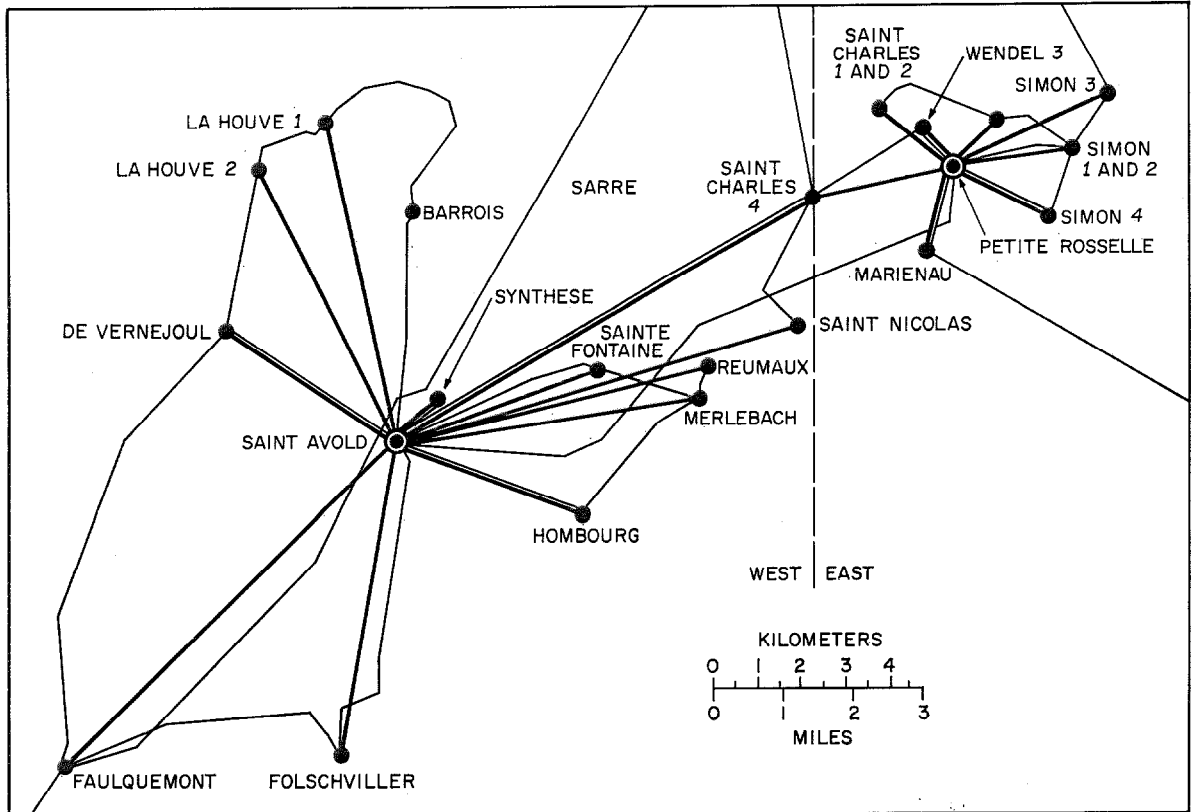


Figure 2—The heavy lines show the direct control connections between each transformer station and its control station. The light lines are the power-distribution circuit.

formation was reported by operators in each transformer station to the central control station by telephone and instructions received were put into effect by these operators. Thus, the new system replaces the human operators in the transformer stations with apparatus for both reporting conditions and executing orders.

The reporting of information and the transmission of instructions over substantial distances immediately brings to mind the effectiveness of telephone switching systems for such purposes; the calling of one subscriber by another is an exercise of remote control. The important difference is that of reliability. Wrong telephone calls are not serious unless there are many of them

## 3. Reliability

To insure reliable operation, the design must conform to a number of principles.

Orders for each elementary operation must be confirmed and no action must be taken until the preceding operation has been completed correctly. This permits the system to detect abnormal conditions and to stop any action until the abnormality is corrected.

All apparatus is to be of simple design to avoid malfunctioning. It must have long life, infrequently require servicing, and be capable of operating over wide ranges of input voltages and under varying ambient conditions. The signaling system or code should be simple and errorproof.

The geographical arrangement of the network made it convenient to connect each transformer station to its control station so that signals need not be relayed through tandem stations.

#### 4. Controlled Elements

The types of apparatus to be controlled are circuit breakers, section switches, and similar devices that may occupy one of two positions, either *on* or *off*. The positions of these switches must be reported to the control station. In addition, information must also be supplied on faults such as abnormal grounding or overheating and these reports are either *normal* or *fault*. Thus, for control purposes, each of these individual elements is in effect a two-position device.

#### 5. Operation

To change the operating condition of any equipment at one of the transformer stations, the operator at the control station, working from the control desk for that particular transformer station, turns a bar switch that is mounted in a mimic diagram and that corresponds to the device to be controlled. A lamp in the center of the bar switch then lights and the operator presses the button, which in turn is mounted on another switch.

The order is transmitted by an individual relay switch associated with the button through a connecting relay to the coding and supervising equipment (Figure 3), which performs the signal transmission.

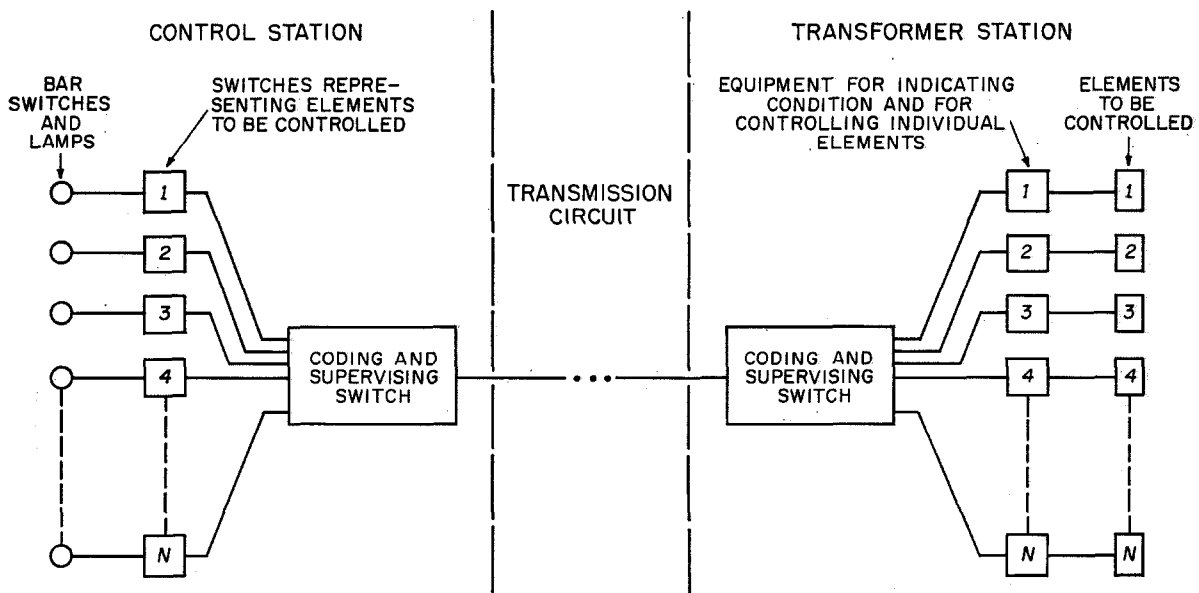


Figure 3—Diagram of controlling and signaling system.

It is therefore required to provide a system that will connect without error of any kind an indicator at the control station with the reporting and controlling mechanisms for the equipment that it represents at the transformer station. Regardless of the number of pieces of equipment that must be controlled at each transformer station, only two pairs of wires for bidirectional signaling are available between that station and the control station. Such an arrangement is shown in Figure 3.

As all the bar switches corresponding to an equipment in a given transformer station can be connected to the coding and supervising switch, which is connected to the transformer station by the transmission circuit, no further transformer-station selection is needed.

A calling code pulse is then automatically transmitted to the finder-selector switch at the transformer station through which the line is connected to the supervisory equipment associated with the individual device to be controlled.

It would now be possible to order the new condition but the correctness of the connection must first be confirmed. This is done by having the connected supervisory equipment transmit its identifying call back to the control station. If this return call corresponds to the original call, the new order will be initiated by the change in the bar switch from its previous position. This transmits the order code to the transformer station and, when the necessary operations have been performed, the new position will be reported by a supervision code to the control station and will extinguish the lamp in the bar switch.

The transformer station will report to the control station any change in conditions that may occur. A control contact on the equipment that has changed condition will initiate a call to the control station and through the coding and supervising switches, each of which actually have both functions, will light the lamp of the corresponding fault indicator on the control board.

## 6. Code

Information is transmitted by the use of a code in which square-wave pulses are separated by intervals of time approximately equal to the length of the pulses. Pulses are either transmitted or suppressed to distinguish one message or address from all others.

If  $n$  is the number of time intervals reserved for pulses and the pulse may assume either of 2 conditions, on or off, the possible number of combinations will be  $2^n$ . In this installation, 10 time intervals are available, so  $2^{10} = 1024$  possible combinations. As the message is either of two conditions, the code provides 9 pulse positions for 512 addresses.

The fact that the code consists of a series of pulses and spaces of equal duration permits random disturbances to be rejected because they do not occur at the time intervals set by the code.

### 6.1 SYNCHRONIZING

Each transmitting station sends two signals. One of these is a synchronizing signal  $A$  (Figure

4) and the other  $B$  contains the address and message.

At the receiving end, the  $A$  and  $B$  signals must be separated from each other. This can be done in several ways. The  $A$  signal may be sent over

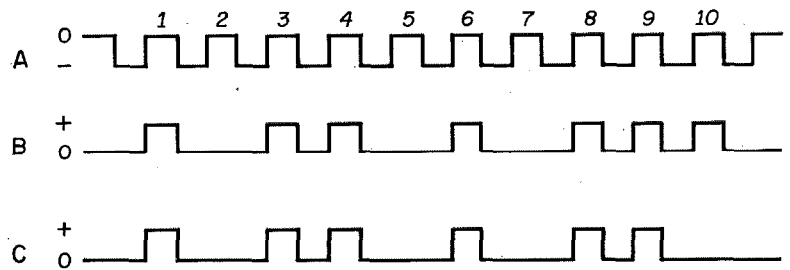


Figure 4—Sample code transmissions.  $A$  is the synchronizing signal of negative polarity.  $B$  is an address and message signal of positive polarity with the transmitted pulses occurring during the intervals between the  $A$  pulses. The first 9 pulse intervals are for the address.  $C$  differs from  $B$  only in the 10th pulse position, which indicates the condition of or order to the addressed element.

one pair of wires and the  $B$  signal over another pair. This requires a minimum of three wires if earth return is not used. Another method would reverse the polarity of a direct current sent over a single pair of wires, using only one polarity of transmission at a time to avoid the two transmissions canceling each other. A third method would employ alternating currents of different frequencies. The second method is used in this installation.

When a call is initiated at the control station, the first pulse of the synchronizing signal  $A_c$  is transmitted to the transformer station. It causes the transformer station to reply with its synchronizing signal  $A_t$ , the receipt of which at the control station stops the transmission of the first pulse of  $A_c$ . As the transformer station no longer receives  $A_c$ , it stops its transmission of  $A_t$ . There now being no signal in either direction, the cycle is started over again by the transmission of  $A_c$ . It is evident that the duration of transmission of each pulse from each station is not rigidly defined but will depend on the time required for the equipments to respond and also on the characteristics of the transmission circuits.

### 6.2 ADDRESS AND MESSAGE

As already mentioned, the address and message, which make up signal  $B$ , are transmitted during 10 pulse intervals that occur between the

synchronizing pulses *A*. They are distinguished from the synchronizing pulses by being of the opposite polarity. The synchronizing pulses are under the alternate control of both stations, the message of only the sending station.

Each code group is checked to ensure that only one pulse is received during each of the 20 time intervals for the pulses for synchronizing, address, and message. Each group is checked for the proper number of synchronizing pulses. In addition, the address of the transmission must be that of the called device before a message will be accepted. These checks are made for transmissions in either direction between the central control station and a transformer station.

The elapsed time from depressing the push button in the bar switch on the control desk to the extinction of the lamp, which signifies that the order has been filled, but not including the time required to change the condition of the individual element in the transformer station, is between 2 and 3 seconds.

### 7. *Transmission Circuits*

The maximum distance between a control station and transformer station is 17 kilometers (10.6 miles). This permits the use of 24-volt direct-current signaling.

The power lines, some of which operate at 220 kilovolts, may under fault conditions induce substantial voltages in the signaling circuits, which are in some cases quite close to the power lines. To protect against these conditions, the transmission relays are tested to insure that they will withstand 10 kilovolts between coils, contacts, and ground. The power supplies for the transmission system are insulated to withstand 10 kilovolts to ground. One supply is installed at each central control station. Relays and a power supply may be seen in Figure 5.

### 8. *Design of Equipment*

The equipment is of the all-relay type. The supervisory apparatus for each individual element in a transformer station is mounted on a removable base that can be replaced by personnel having limited skills. Repairs and adjustments can then be made by trained workers in a repair shop. Each unit is protected by a dust cover.

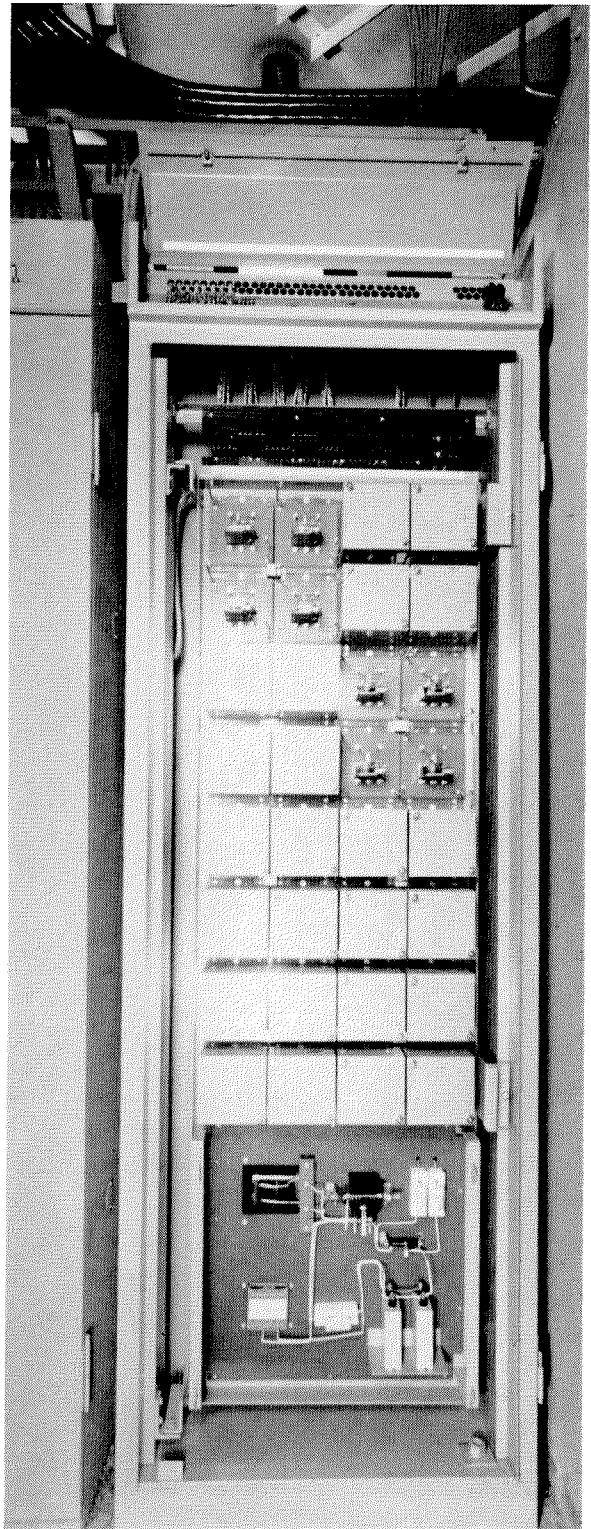


Figure 5—Cabinet mounting signaling relays and power supply, all of which are insulated to withstand 10-kilovolt faults.



## 8.1 STATION CAPACITIES

Table 1 gives the number of individual devices that must be controlled and the number on which reports of condition may be required. It will be noted that Saint Charles 4 is partly controlled from each of the central control stations.

TABLE 1  
INDIVIDUAL ELEMENTS REQUIRING CONTROL  
AND REPORTS OF CONDITIONS

| Transformer Stations  | Individual Elements to be Controlled | Individual Elements on Which Reports Are Made |
|-----------------------|--------------------------------------|---|
| Synthèse*             | 24                                   | 71  |
| Barrois               | 7                                    | 36  |
| Houve 1               | 12                                   | 45  |
| Houve 2               | 12                                   | 42  |
| de Vernejoul*         | 21                                   | 49  |
| Faulquemont*          | 19                                   | 45  |
| Folschviller          | 10                                   | 41  |
| Hombourg              | 10                                   | 41  |
| Sainte Fontaine       | 12                                   | 47  |
| Merlebach*            | 41                                   | 49  |
| Réumaux               | 26                                   | 36  |
| Saint Nicolas         | 26                                   | 36  |
| Saint Charles 4 West  | 15                                   | 38  |
| Saint Charles 4 East* | 25                                   | 56  |
| Wendel 3*             | 39                                   | 49  |
| Saint Charles 1,2     | 14                                   | 49  |
| Simon 1,2*            | 49                                   | 71  |
| Simon 3               | 10                                   | 39  |
| Simon 4               | 11                                   | 30  |
| Marienau*             | 39                                   | 46  |

\* Maximum capacity is 128 individual elements. All others have maximum capacities of 64 individual elements.

The types of controls and of reports on conditions that may occur in the transformer stations are as follows.

### CONTROLS AND POSITION REPORTS

- Line cutoff switches
- Busbar cutoff switches
- Ground cutoff switches
- Line-protecting circuit breakers
- Transformer-protecting circuit breakers
- Voltage and current measurements
- Unlocking of protective devices.

### FAULT REPORTS

- Line release for current overload
- Line release for interphase fault
- Line release for phase-to-ground fault
- Transformer release for current overload

- Transformer high-temperature alarm
- Transformer release for overheating
- Transformer Buchholz alarm
- Transformer Buchholz release
- Air-blower failure
- Air-compressor failure
- Air-compressor overheating
- Excessive pressure from air compressor
- Inadequate pressure from air compressor
- Circuit breaker locked for lack of air pressure
- Failure of section direct current
- Failure of general direct current
- Failure of low-voltage alternating current
- Opening of station doors
- Local controlled stations
- Remote measurement fault
- Wiring trouble
- Remote-control trouble

Standard equipments are available for 14, 32, 64, and 128 individual elements. Immediate and possible future requirements of transformer stations resulted in the choice of either 64 or 128 elements as shown in Table 1. Figure 6 shows an installation for 128 individual elements. The cabinet at the right will accommodate up to 50 terminal relays; only the number required for the particular transformer station is installed. Others may be added as needed.

## 8.2 INSULATION OF EQUIPMENT

Telephone-type equipment designed for operation on 24 volts would normally be designed to withstand a test at 500 root-mean-square volts to ground. To permit the use of this equipment in an installation such as this, it is only necessary that the equipment associated directly with the lines subjected to the effects of the power circuits have increased insulation.

There are two points at which the supervisory equipment may be exposed to higher voltages derived from the power system. One is where the supervisory equipment is connected to the circuits that control the power apparatus. The contacts of these relays have been insulated to withstand 2000 volts to ground. The other is where the supervisory equipment is connected to the lines that connect it to the control stations. Here the relay coils and contacts are insulated to withstand 10 kilovolts to ground and to each other.

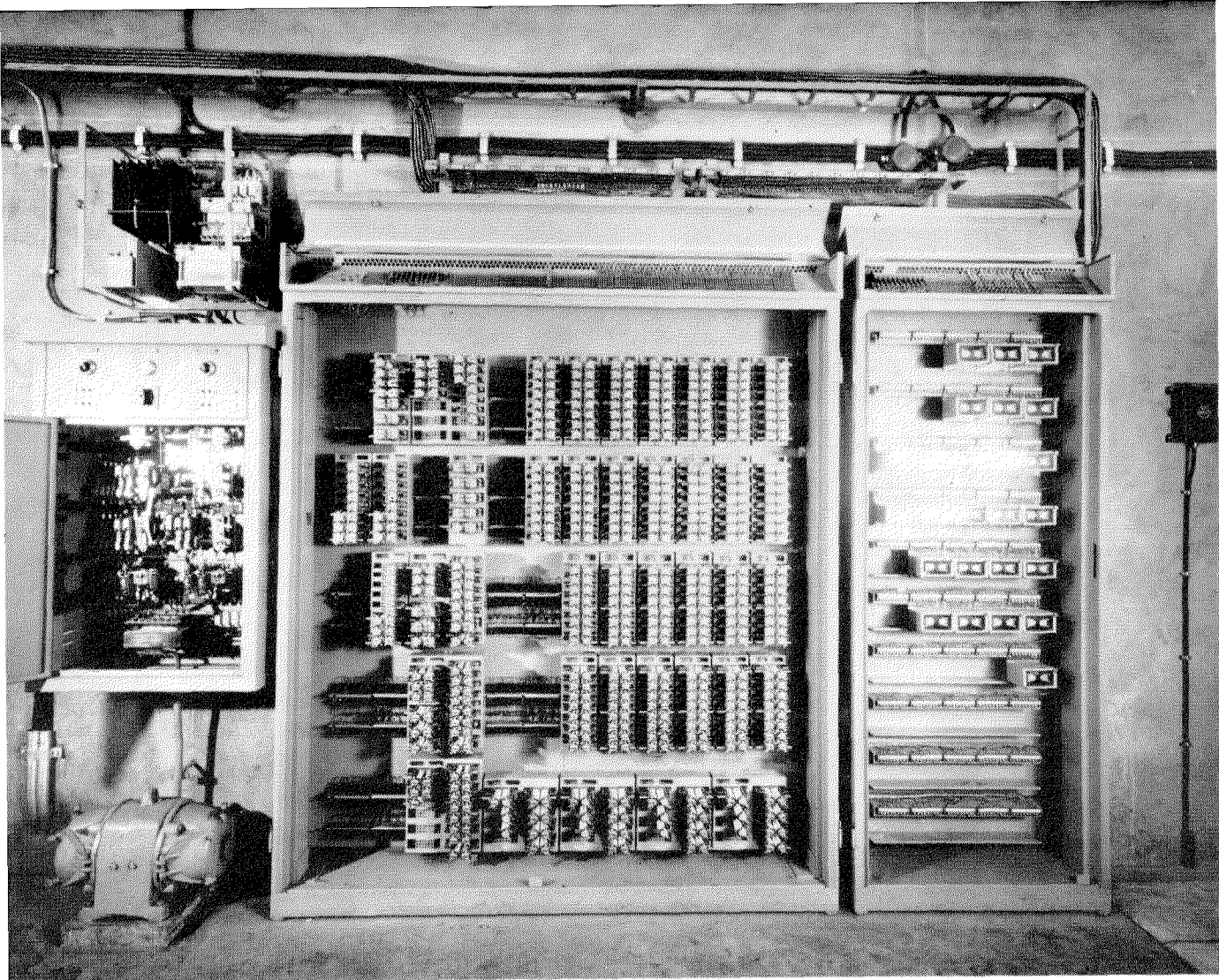


Figure 6—Typical transformer-station installation. The cabinet doors and the covers for the relay groups have been removed. The cabinet at the right will accommodate 50 relays.

### 8.3 INSTALLATION AND TESTING

To simplify the installation of supervisory equipment, the design permits it to be tested completely within the transformer station and independently of the control station. The connections between the wiring to the controlling mechanisms that operate on the power equipment are made through removable U-shaped connectors to the circuits leading to the control station. The removal of the connector will isolate the individual element in the transformer station from all other circuits and permit testing in either direction.

The female contacts into which the U-shaped connectors are plugged are arranged in a standard pattern so that a test set may be plugged in

to replace the U connector. For an individual element that requires reports on its conditions as well as control of its adjusting equipment, the test set provides the following facilities.

- A. Check of the continuity of the circuits set up by the control station to open the individual element. This is indicated by two signal lamps.
- B. Check of the continuity of the circuits set up by the control stations to close the individual element. This is indicated by two signal lamps.
- C. A cutoff and changeover switch on the test set that replaces the contacts of the transformer station power apparatus that reports its condition to the control station. It may be adjusted to report either of the two possible conditions.



Figure 7—Control desk at Petite Rosselle.

All the circuits may be checked with this test set before cutover, which is instituted by inserting the U-shaped connecting links.

In case of trouble, the faulty circuit can be quickly identified by using the test set regardless of whether the fault may be in the transformer station or in the circuits between it and the control station.

### **9. Control-Station Desks**

Great emphasis is placed on reducing the size of the components mounted on the control-station desks so as to permit the operator to have immediate access to the largest number of equipment controls. The desk of the control station at Petite Rosselle is shown in Figure 7.

#### **9.1 SWITCHES AND LAMPS**

Three components have been designed into a miniature unit referred to as a turn-and-push

button. It is made up of a position key in the form of a bar switch, control push button, and indicator lamp. The push button has to be large enough to be found quickly and pressed by the operator without danger of its being mistaken for an adjacent unit. Inserted in the mimic diagram of the power system, the bar-switch position key may be turned to indicate the desired condition of the individual element in the transformer station that it represents. The push button mounted in the center of the position key has a Plexiglas window through which the indicator lamp shines.

#### **9.2 FAULT INDICATORS**

The fault indicators that identify the various messages are photographic films mounted in Plexiglas frames and illuminated from behind.



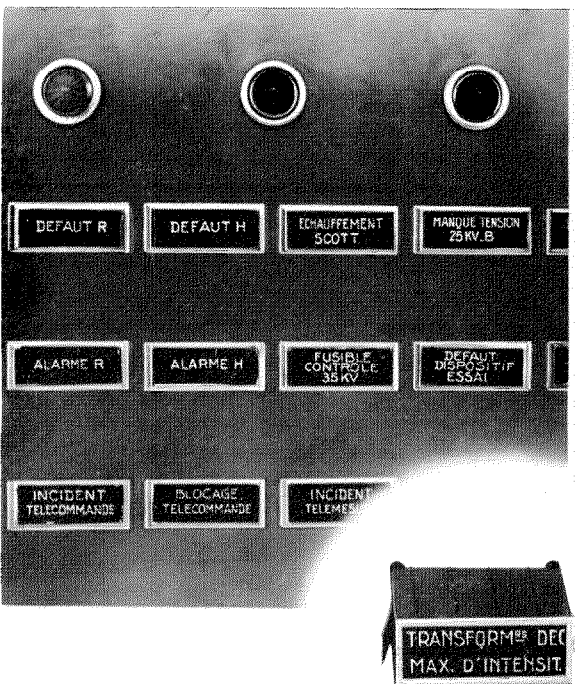


Figure 8—Control-desk fault indicators.

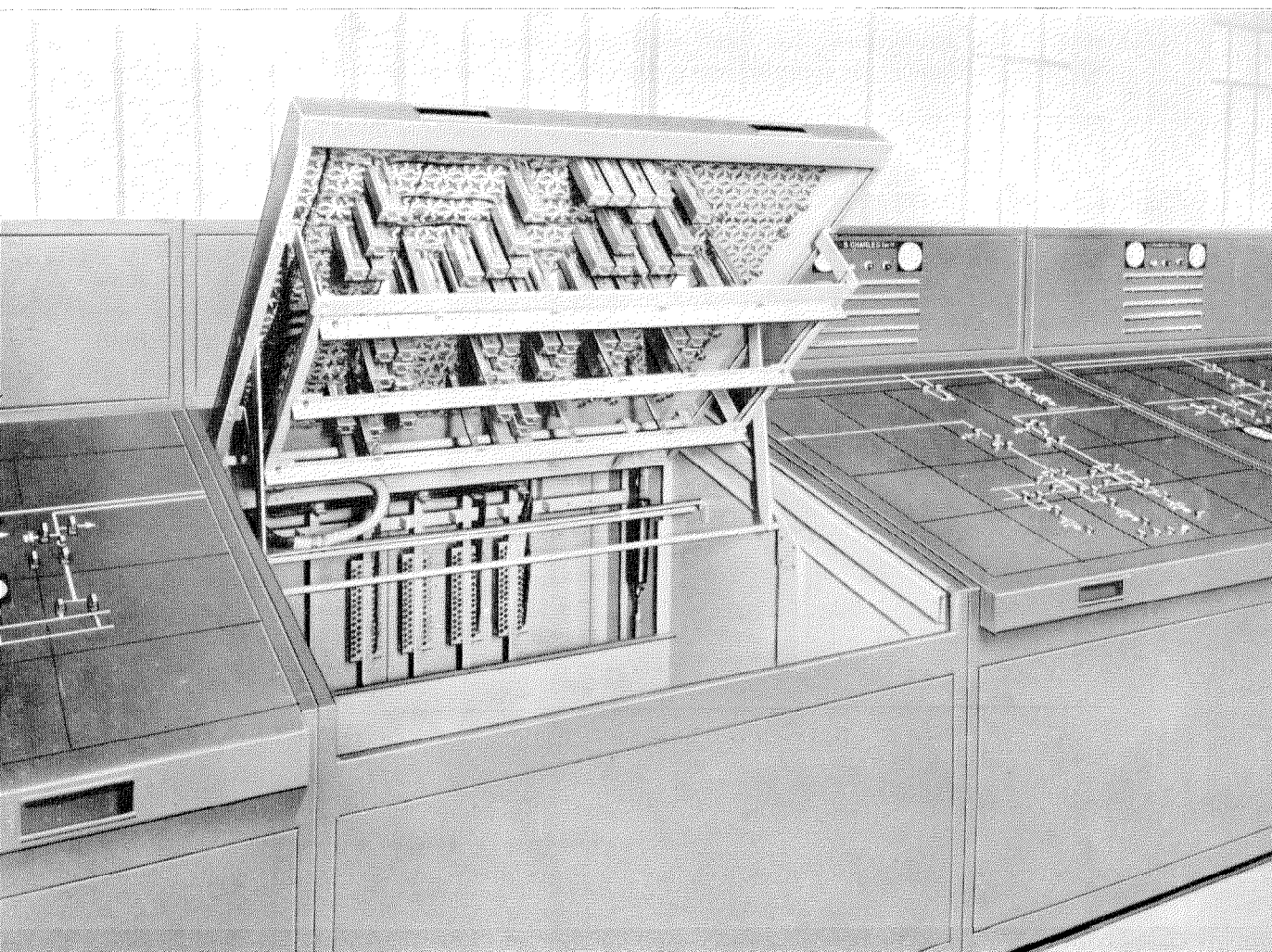
They are shown in Figure 8. The lamps are mounted on removable bars for convenience in replacing them. The films also may be readily replaced.

### 9.3 DESKS

Each control desk is an independent unit that controls one transformer station. The units are mounted next to each other to preserve the continuity of the mimic diagram of that part of the system under the supervision of the particular control station.

The slanting panel of each desk, as shown in Figure 9, mounts the turn- and push-button units for the individual elements of that transformer station. They are arranged as parts of the mimic diagram and are mounted on standardized panels to allow for modification and expansion. These 200-millimeter (7.9-inch) square panels are perforated to mount any of the

Figure 9—Typical control desks. Each desk is for one transformer station and the control units are mounted as parts of the mimic diagram.





standard units that make up the mimic diagram. They are not changed when modifying the diagram. Front panels are provided for each type of unit and also carry the corresponding mimic-diagram markings.

The desk top is pivoted and may be held open by springs to permit inspection, servicing, and replacement of indicating lamps. The vertical panel behind the sloping desk top support the fault indicators shown in Figure 8 and the measuring instruments. A removable cover gives access to the back of the desk and to the connecting cables.

### 10. Recorder

The various types of faults and alarms are reported by the illumination of the corresponding indicator on the vertical panel at the back of the control desk. This lamp is extinguished when the fault is corrected. Records are required of the occurrence and correction of some of these faults and alarms such as those for the air blowers, air compressors, and the opening and closing of the doors of the transformer station.

To avoid the necessity of providing a separate recorder for each device and operating it constantly, an arrangement has been developed whereby any fault to be recorded sets a common

mechanism in operation. The recorder hunts over the circuits until it finds the one indicating a fault, notes which circuit it is, the time the fault appeared, and the time it disappeared. This information is recorded on tape by a standard teleprinter of the type shown in Figure 10.

### 11. Telemetering

It is important for the control operation to know under certain conditions such things as the voltages, active and reactive powers on the transformer-station lines, and current supplied by the transformers. These values may be requested by the operator and will be transmitted to the control station and indicated on the measuring instruments mounted on the vertical panel with the fault indicators.

### 12. Conclusion

This installation uses about 10 000 relays for the supervision of some 1300 individual elements in the 20 transformer stations. Normally, each transformer station requires a team of 3 operators or 60 persons in all. A central control station with a mimic diagram and connecting telephone lines to each transformer station would also be required.

Remote control has eliminated the need for transformer-station personnel; a crew of 4 control operators is able to supervise the low-voltage as well as the high-voltage systems. The supervisory methods are such that they could be extended to many other equipments, such as pumps, ventilators, and elevators and would require connecting lines equivalent only to poor-quality telephone channels.

The use of telephone-type equipment, the reliability of which has been well established, permits great flexibility in design, small size, low power consumption, and operation over distances of several hundreds of kilometers to provide full supervision of a great variety of equipment.

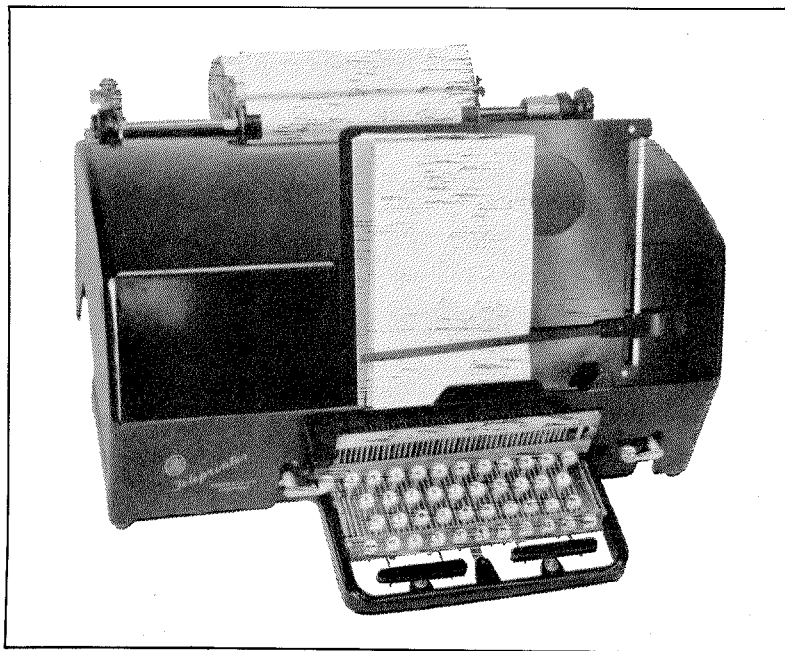


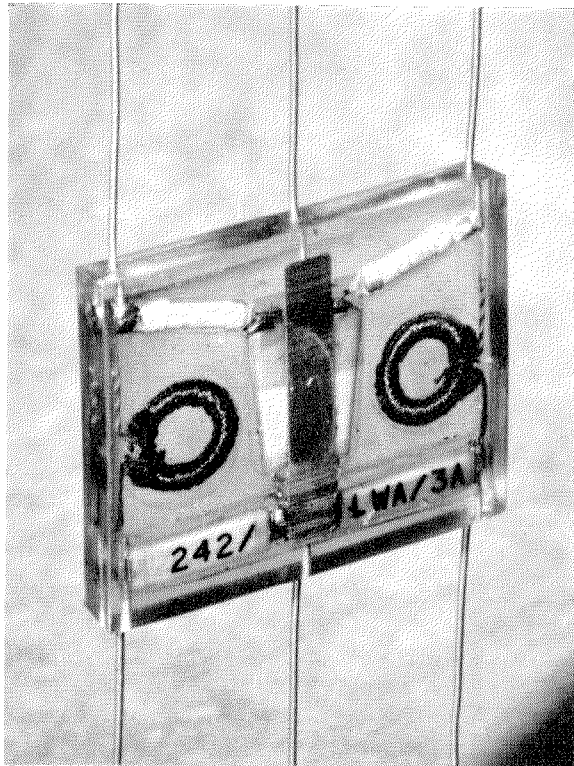
Figure 10—Teleprinter used for recording faults.

# Telegraph Relays with Built-In Radio-Interference Suppressors

AS IS WELL KNOWN, the square-wave voltage normally transmitted by the armature of a polarized relay reproducing telegraph signals is rich in harmonics extending well into the radio-frequency range. For example, the Fourier analysis of a 25-cycle-per-second square-wave signal of 80 volts peak (that is, a continuously repeated polar signal of alternate 1-unit marks and 1-unit spaces at 50 bauds from a telegraph battery of 80-0-80 volts), shows that this signal contains voltages of approximately 85 to 5000 microvolts in the frequency band 30 megacycles to 500 kilocycles per second. This is quite an appreciable signal strength to a radio receiver and consequently, when telegraph and radio equipments are used in close proximity, it is desirable to suppress the radio frequencies without materially deteriorating the effective squareness of the signal as far as the telegraph equipment is concerned.

The basic circuit for such a suppressor (developed by Standard Telephones and Cables, Limited, of London, England) is a low-pass filter and the circuit used is shown in Figure 1; it is intended primarily for relays transmitting polar (double-current) signals. The resistors  $R1$

and  $R2$  are to reduce the surge currents that occur when capacitors  $C1$  and  $C2$  discharge through the relay contacts and which would otherwise cause contact sparking. It should be stressed that the suppressor supplements the normal spark-quench circuit and is not intended



Type-242/J.W.A./3A suppressor.

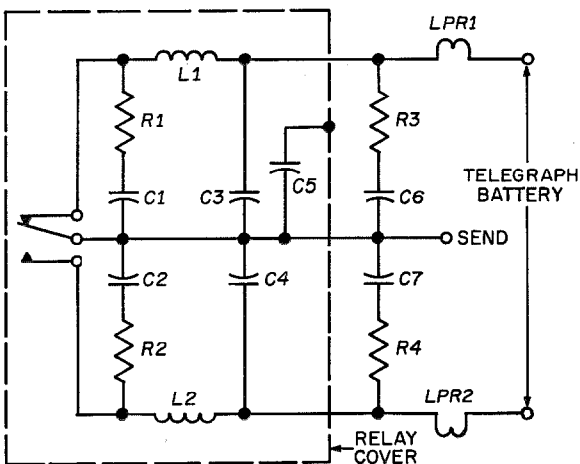
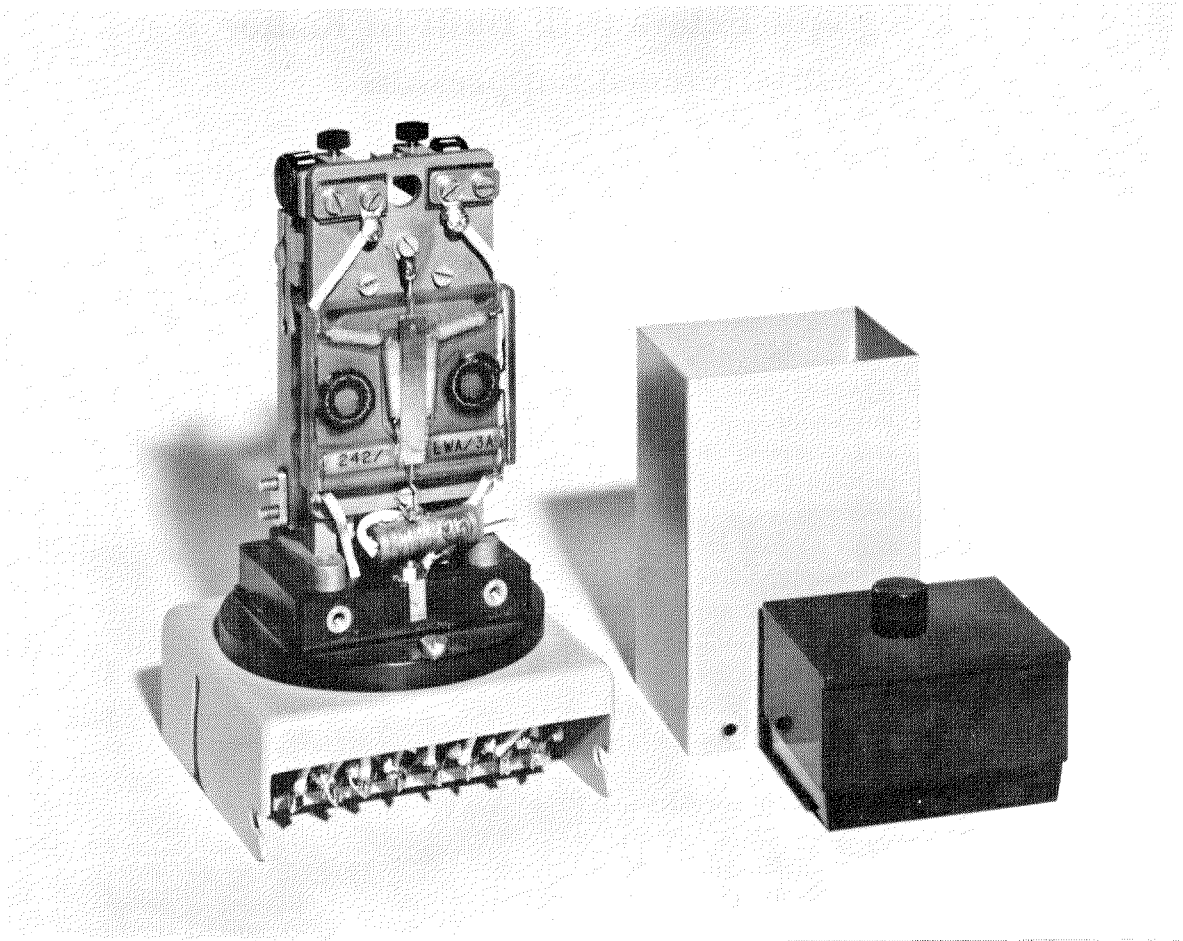


Figure 1—Schematic diagram of the interference suppressor.  $R1 = R2 = 1000$  ohms.  $C1$  through  $C5 = 0.01$  microfarad.  $L1 = L2 = 1$  millihenry. The usual spark-suppressor circuit consists of  $R3 = R4 = 1500$  ohms and  $C6 = C7 = 0.5$  microfarad.  $LPR1$  and  $LPR2$  are protective lamps.

to replace it. The spark-quench circuit itself will give some radio-interference suppression, chiefly at the lower end of the frequency spectrum. The coils are "Carbonyl" dust-cored toroids and are capable of withstanding the full fault current should a ground or a short-circuit occur.

The components for the suppressor unit are encapsulated in "Stantelene V," which is a plasticized epoxy-type resin, so as to form a rigid assembly whose overall dimensions can be controlled. The assembly can then be mounted and wired within the relay cover right up against the interfering source, just where it ought to be.



Type-4191 relay fitted with 242/LWA/3A suppressor.

Two forms of suppressor are made; one for a "Standard" 4191-type relay in which all components for the suppressor are moulded into one unit (coded 242-LWA-3A) and mounted at the back of the relay framework; the other for the "Standard" 4192-type relay in which space is more restricted and the components are therefore moulded into two equal units (coded 242-LWA-4A), one unit being mounted on each side of the relay framework (the 5th capacitor is wired on separately). With each type of suppressor, the units are within the relay covers and

the rigidity of the mouldings and of the wires is sufficient to keep them in position without having to add fixing holes and screws.

These suppressors, when assembled within the relay framework, give a suppression of at least 50 decibels in the range 0.5 to 30 megacycles per second *when measured directly at the base of the relay*; panel wiring and panel dust-covers will give a further improvement in suppression.

The sizes and weights of the suppressor units are:

|            | Length |             | Width  |             | Thickness |             | Weight |       |
|------------|--------|-------------|--------|-------------|-----------|-------------|--------|-------|
|            | Inches | Centimeters | Inches | Centimeters | Inches    | Centimeters | Ounces | Grams |
| 242-LWA-3A | 1.562  | 3.96        | 1.875  | 4.76        | 0.265     | 0.67        | 0.780  | 22.2  |
| 242-LWA-4A | 1.375  | 3.49        | 0.875  | 2.22        | 0.25      | 0.63        | 0.3    | 8.7   |

# Gain Equalization of Linear Servomechanisms that Solve Nonlinear Equations

By GUY E. ADAMS

*Farnsworth Electronics Company, a division of International Telephone and Telegraph Corporation; Fort Wayne, Indiana*

**L**INEAR servomechanisms are frequently used to solve nonlinear equations. Gain equalization of the servomechanism loop may be required to achieve adequate accuracy and stability. This paper presents a method wherein the error equation is differentiated with respect to the output rotation to determine the required gain equalization function. Several examples of the application of this method are given. The method is also applied to a multiple-loop system that solves three nonlinear equations.

• • •

Servomechanisms are used to solve linear equations in most of the applications. In such cases, it is desired that the input and the controlled output be equal or vary according to a constant relation; that is, the steady-state output may be described by multiplying the input by a constant. The basic open-loop servomechanism is considered to be linear.

Servomechanisms may also be used to solve continuous single-valued nonlinear equations. The closed-loop servomechanism becomes nonlinear even though the basic open-loop system is linear; in this paper the open-loop system is treated as being linear and damped sufficiently for stability at the nominal gain-equalized sensitivity. The servomechanisms referenced by this paper may contain the nonlinear element as any part of the loop; however, in equation-solving systems, the computing element may be considered to be either the error-sensing device or part of the feedback path. Gain-equalization methods described by this paper apply equally well when the nonlinear device is part of the forward path; however, the forward-path location generally corresponds to an undesirable system characteristic.

It will be shown that the nonlinear-equation-solving servomechanism has variable loop gain,

which may result in inconsistent or variable system performance. If the amplifier gain is adjusted for some average value, the loop gain at one extreme of the range may be too high and the gain at the other too low. The well-known effects of too-high gain are various forms of instability such as:

- A. Oscillation or limit cycles.
- B. Gear chatter.
- C. Hum caused by resolution limitations in the follow-up member.
- D. Excessive amplification of noise and disturbance signals.
- E. Excessive power consumption.

Too-low gain may result in sluggishness and inaccurate follow-up. Conditionally stable servomechanisms are especially susceptible to gain variations.

## 1. Theory of Gain Equalization

Gain equalization is a solution for the undesirable effects of variable loop gain. The method described in this paper utilizes the derivative with respect to the output of the input-output-error equation to equalize the servomechanism loop gain. The gain is equalized by a controller gain function that is approximately proportional to the reciprocal  $1/(d\epsilon/d\theta_0)$  of the error sensitivity.

The gain error in using the reciprocal error sensitivity function is generally small in practical cases because the variations in output position of the servomechanism about the required position are small. The derivative  $d\epsilon/d\theta_0$  may be approximated accurately by the ratio  $\Delta\epsilon/\Delta\theta_0$  in such cases.



The amount of gain variation that is tolerable without gain equalization is beyond the scope of this paper. Generally, gain equalization would be used only where loop-gain variations were fairly high, say 10 decibels or more.

The gain equivalent circuit of Figure 1A is shown in Figure 1B, which represents the system for small values of error, small changes in input, and small changes in output. This circuit may be obtained by using the following deriva-

Figure 1—Servomechanism with gain equalizer for solving nonlinear equations.

For A,

$$R \gg R_p$$

$$\epsilon = E - x\theta_o$$

= error-detector equation

$$\theta_o = \frac{E}{x} \Big|_{\epsilon=0}$$

= computer equation

$$|d\epsilon'/d\theta_o| = EA$$

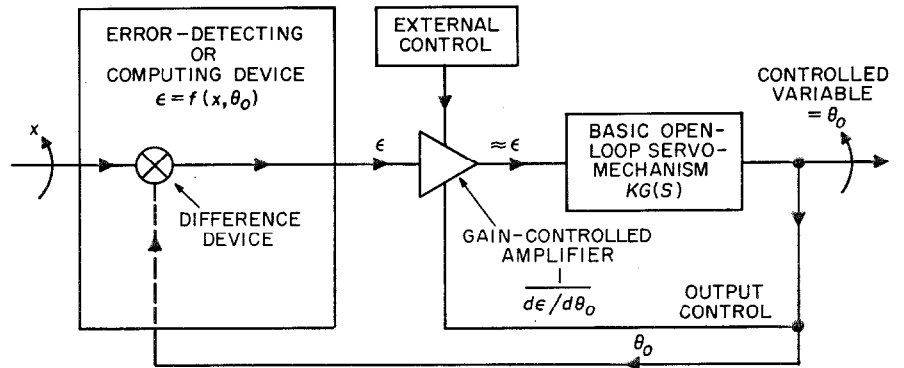
= gain-equalized error-detector sensitivity.

For B,

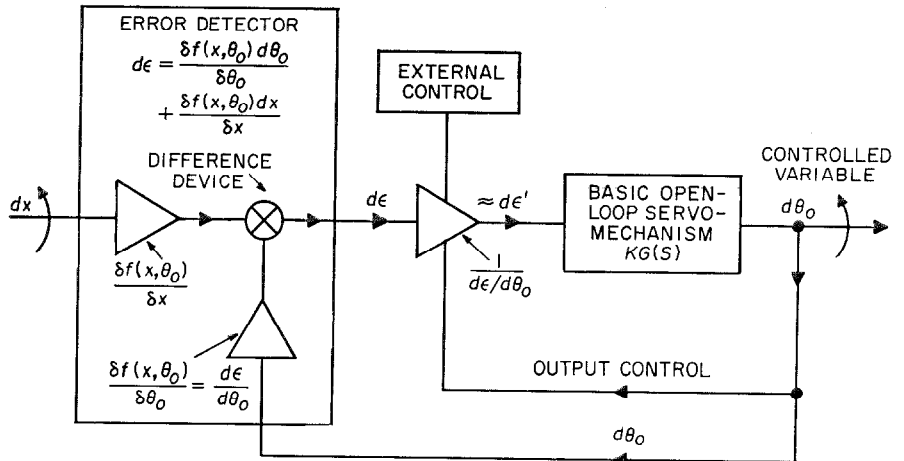
$$\frac{\epsilon'}{\epsilon/2} = + \frac{A_2}{1 + A_2x}$$

$$\approx + \frac{1}{x} \text{ when } A_2x \gg 1$$

$$\frac{d\epsilon'}{d\theta_o} = \frac{d\epsilon}{d\theta_o} \cdot \frac{\epsilon'}{\epsilon/2} \approx 1.$$



A. BASIC SYSTEM



B. GAIN-EQUIVALENT SYSTEM

The basic scheme of nonlinear-equation solving and gain equalization is illustrated by the servomechanisms of Figure 1. The error detector in Figure 1A produces an error  $\epsilon$  that is a desired function of the input variable  $x$  and the controlled variable  $\theta_o$ . A gain-controlled amplifier accepts the error voltage  $\epsilon$  and produces a gain-equalized error voltage  $\epsilon'$  that is a linear function of  $\theta_o$ . The equalized error voltage is applied to the input of an ordinary open-loop system. The gain-controlled amplifier has a gain proportional to  $1/(d\epsilon/d\theta_o)$ . The gain might be controlled by the output position, or by an external means that is some function of the input variable, or by both of these.

tion: Assume that (1) in functional notation describes the input, output, and error relations of the system.

$$\epsilon = f(x, \theta_o). \quad (1)$$

Differentiating (1),

$$d\epsilon = \frac{\delta f(x, \theta_o)}{\delta \theta_o} d\theta_o + \frac{\delta f(x, \theta_o)}{\delta x} dx. \quad (2)$$

The differential error relation can be represented by the error detector in Figure 1B. The differential input  $dx$  is amplified by  $\delta f(x, \theta_o)/\delta x$  in a fictitious amplifier and is then applied to a difference device. The incremental output,  $d\theta_o$ ,

is amplified by  $\delta f(x, \theta_o) / \delta \theta_o$  in a second fictitious amplifier and is applied to the same difference device. The differential error  $d\epsilon$  is applied to the gain-equalizing amplifier. The error sensitivity is  $\delta f(x, \theta_o) / \delta \theta_o$  and is independent of the magnitude of  $dx$ . The equation for  $d\epsilon'$ , the error with gain equalization, is

$$\left. \begin{aligned} d\epsilon' &= \frac{d\epsilon}{d\epsilon/d\theta_o} \\ &= d\theta_o + \frac{[\delta f(x, \theta_o) / \delta x] dx}{\delta f(x, \theta_o) / \delta \theta_o} \end{aligned} \right\} (3)$$

Equation (3) shows that the gain has been equalized because  $d\epsilon' / d\theta_o = 1$  with  $dx = 0$ ; it also shows that the change in output  $d\theta_o$  as a result of an input  $dx$  is the same as without the equalizing network.

The remainder of this paper is devoted to demonstrating how this method of gain equalization has been applied to several different servomechanisms that solve nonlinear equations, so that the rather-wide range of application from simple to moderately difficult problems can be demonstrated.

## 2. Reciprocal Computer

A diagram of a gain-equalized servomechanism to provide a rotation that is the reciprocal of the input command is shown in Figure 2. The equation for the error  $\epsilon$  is

$$\epsilon = E - x\theta_o. \quad (4)$$

The equation is solved when  $\epsilon = 0$ ; the output rotation is the reciprocal of the input voltage:

$$\theta_o = -E/x. \quad (5)$$

The error sensitivity may be found by differentiating (4) with respect to  $\theta_o$ .

$$d\epsilon/d\theta_o = -[x + \theta_o(dx/d\theta_o)]. \quad (6)$$

Since the input is not a function of the output rotation, (6) simplifies to

$$d\epsilon/d\theta_o = -x. \quad (7)$$

The desired relation for error sensitivity is obtained by substituting the value for  $x$  from (5):

$$d\epsilon/d\theta_o = -E/\theta_o. \quad (8)$$

The required gain-equalizing function becomes

$$1/(d\epsilon/d\theta_o) = -\theta_o/E. \quad (9)$$

The gain-equalizing circuit consists of an isolation amplifier having a gain of  $2A$  and a linear voltage divider positioned by the output shaft. The voltage-divider output is a voltage proportional to  $\theta_o$  as required by (9). The over-all gain of the error detector and the gain-equalizing circuit for a small variation in output is

$$d\epsilon'/d\theta_o = (-E/\theta_o)(A_1\theta_o) = -EA_1, \quad (10)$$

which is the product of the error-detector sensitivity and the gain of the equalizing circuit. Equation (10) shows that the loop gain has been linearized since an error variation and an output variation differ only by a multiplying constant.

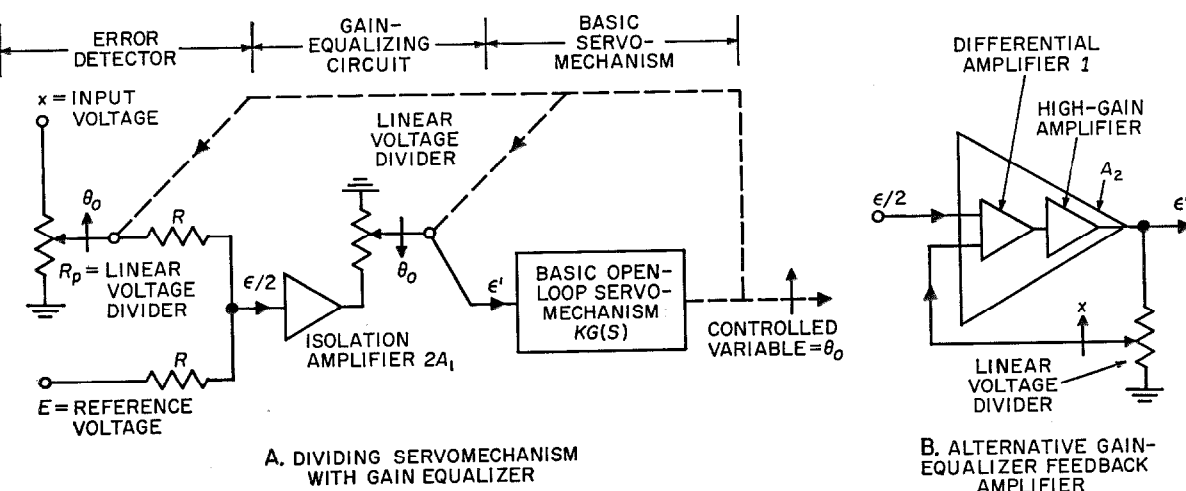


Figure 2—Gain-equalized servomechanism for determination of reciprocals.

If a certain value of combined error-detector and gain-equalizer sensitivity is desired, it may be calculated using (10): In this case, the required  $A_1$  is

$$A_1 = (d\epsilon'/d\theta_o)/E. \quad (11)$$

If a voltage-divider rotation proportional to the input  $x$  is available, the sensitivity of the gain-equalizing circuit can be controlled as a function of the input. Referring to (7), the gain can be controlled by a factor proportional to  $1/x$  and the alternative gain-equalizing circuit of Figure 2B (a high-gain feedback amplifier) may be used.

### 3. Arc-Tangent Computer

A second example of gain equalization is used in a servomechanism that provides a rotation

ating (12). The sensitivity becomes, treating  $x$  and  $y$  as constants,

$$d\epsilon/d\theta_o = -Ey \sin \theta_o - Ex \cos \theta_o. \quad (14)$$

By the use of a trigonometric identity, (14) may be written as

$$d\epsilon/d\theta_o = -Ex/\cos \theta_o. \quad (15)$$

The gain required from the equalizing circuit is proportional to

$$1/(d\epsilon/d\theta_o) = -(\cos \theta_o)/Ex. \quad (16)$$

The gain-equalizing amplifier of Figure 3 has the required gain function. An amplifier having a feedback factor proportional to  $x$ , which is obtained by using a linear voltage divider and an  $x$  rotation, provides a gain at its output of  $1/x$ . The output of the amplifier is applied to a

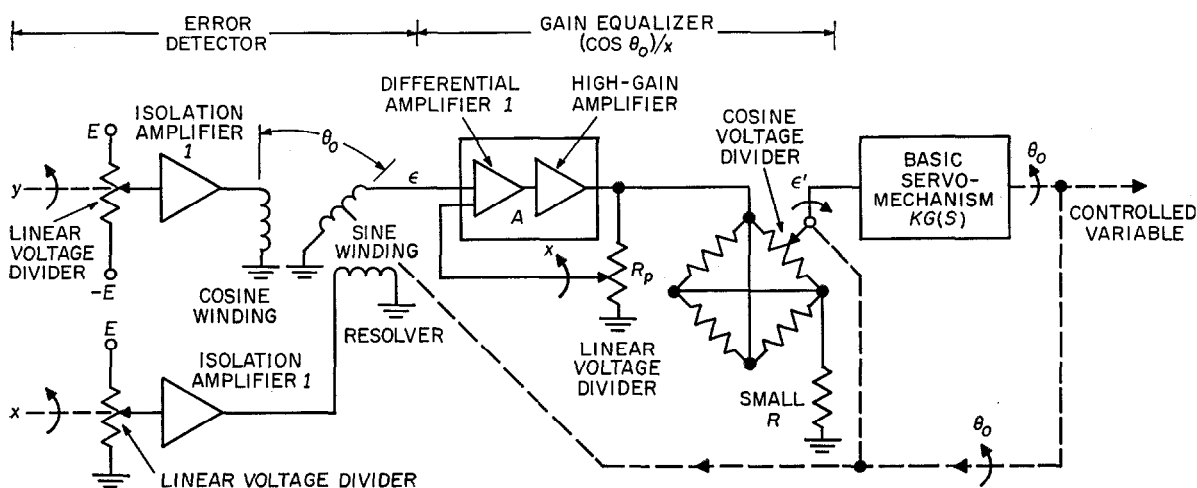


Figure 3—Gain equalization of servomechanism for computing  $\tan^{-1}(y/x)$ .

$$\epsilon = Ey \cos \theta_o - Ex \sin \theta_o \text{ and } \theta_o = \tan^{-1} \frac{y}{x} \Big|_{\epsilon=0}^{+90} \Big|_{-90}$$

proportional to  $\tan^{-1}(y/x)$ , Figure 3. The equation for the error voltage is

$$\epsilon = E(y \cos \theta_o - x \sin \theta_o), \quad (12)$$

where  $x$  and  $y$  are fractional parts of  $E$ .

This equation can be solved for the output rotation  $\theta_o$  when the error becomes zero.

$$\theta_o = \tan^{-1}(y/x). \quad (13)$$

The error sensitivity may be found by differenti-

cosine voltage divider positioned by the servomechanism output shaft. The gain of the entire equalizing circuit is the quantity  $-(\cos \theta_o)/x$ .

The circuit and servomechanism have several limitations. The maximum gain of the feedback amplifier is  $A$ , although infinite gain is required in (16) for  $x = 0$ . A small resistor can be used in series with the cosine voltage divider to prevent the gain from becoming zero at the  $\pm 90$ -degree positions; the servomechanism could become

“stuck” at these positions if precautions were not taken.

It can be shown that (13) also can be written

$$d\epsilon/d\theta_o = E(x^2 + y^2)^{1/2}. \quad (17)$$

A voltage proportional to this quantity can be obtained from the output winding on the resolver in quadrature with the error-voltage winding. The alternating voltage so obtained can be

applied to control the output of the power-supply circuit, which furnishes the voltage-divider voltage  $E$ . Voltage  $E$  is controlled so that the quantity  $E(x^2 + y^2)^{1/2}$  from the resolver remains constant; the principle of operation is similar to automatic gain control. This circuit has the disadvantage that the error sensitivity  $\epsilon$  would generally be considerably less than that of Figure 3 because of power output limitations of

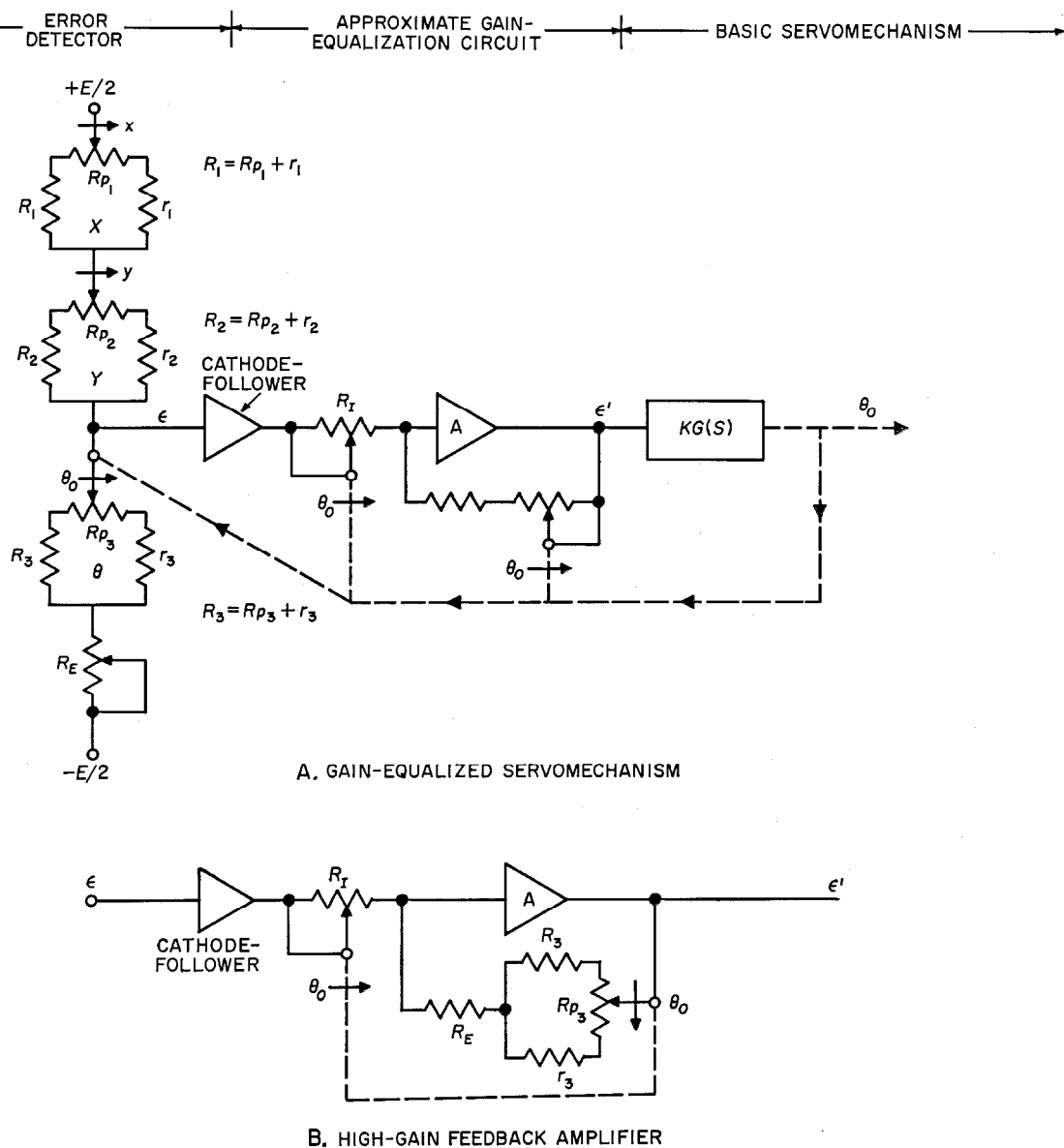


Figure 4—Diagram of square-root computer. In B,

$$\frac{\epsilon'}{\epsilon} = \frac{R_E + R_3/2 - \theta_o^2/2}{\theta_o R_1} \quad \text{where} \quad R_1 \theta_o \gg \frac{R_T \theta_o + R_E + R_3/2 - \theta_o^2/2}{A}$$



the gain-controlled power supply and power dissipation limitations of the  $X$  and  $Y$  input voltage dividers. It can be shown that the error voltage sensitivity at the equalized output in Figure 3 is higher by a factor  $1/(x^2 + y^2)^{1/2}_{\min}$  than that using the gain-controlled alternating-current power supply.

#### 4. Square-Root Computer

The third example of gain equalization is that required by a servomechanism providing a rotation proportional to the square root of the sum of the squares of the input variables. The system of Figure 4 extracts the square root of the sum of two squares.

The impedance of the  $X$  element is

$$Z_x = \frac{(R_1 + x)(R_{p1} + r_1 - x)}{(R_1 + R_{p1} + r_1)}. \quad (18)$$

Let

$$R_1 = R_{p1} + x; \quad (19)$$

then,

$$\left. \begin{aligned} Z_x &= (R_1^2 - x^2)/2R_1 \\ &= R_1/2 - x^2/2R_1. \end{aligned} \right\} (20)$$

If the corresponding relation is true in the  $Y$  and  $\theta$  elements, the error voltage  $\epsilon$  is

$$\epsilon = - \frac{E(Z_x + Z_y - Z_\theta - R_E)}{Z_x + Z_y + Z_\theta + R_E}. \quad (21)$$

In (20), it may be seen that a typical element  $Z_x$  consists of a constant resistance and a variable resistance. Assuming  $x$ ,  $y$ ,  $\theta$ , and  $\epsilon$  are zero, the constant resistances must have the relation

$$R_E + R_3/2 = R_1/2 + R_2/2. \quad (22)$$

Substituting in (21), the error becomes

$$\epsilon = - \frac{E(Z_x + Z_y - R_E - R_3/2 + \theta_0^2/2R_3)}{Z_x + Z_y + R_E + R_3/2 - \theta_0^2/2R_3}. \quad (23)$$

The error sensitivity is

$$\left. \begin{aligned} \frac{d\epsilon}{d\theta_0} &= - \frac{E[(Z_x + Z_y + R_E + R_3/2 - \theta_0^2/2R_3)(\theta_0/R_3) + (Z_x + Z_y - R_E - R_3/2 + \theta_0^2/2R_3)(\theta_0/R_3)]}{(Z_x + Z_y + R_E + R_3/2 - \theta_0^2/2R_3)^2} \\ &= - \frac{2E(\theta_0/R_3)(Z_x + Z_y)}{(Z_x + Z_y + R_E + R_3/2 - \theta_0^2/2R_3)^2} \end{aligned} \right\} (24)$$

Recalling that at balance,

$$Z_x + Z_y = R_E + R_3/2 - \theta_0^2/2R_3, \quad (25)$$

the error sensitivity simplifies to

$$\frac{d\epsilon}{d\theta_0} = - \frac{(E/2)\theta_0/R_3}{R_E + R_3/2 - \theta_0^2/2R_3}. \quad (26)$$

Equation (23) is an approximation because of the balance condition assumed in obtaining (26) from (24), but it is sufficiently accurate for gain-equalization purposes.

The equation shows that the error sensitivity is directly proportional to  $\theta_0$  and inversely proportional to a parabolic function of  $\theta_0$ . The sensitivity becomes zero for  $\theta_0 = 0$ . The variation in the denominator may be comparatively small, because  $\theta_0$  is always less than  $R_3$ .

The inverse function, (27), is needed for gain equalization.

$$\frac{1}{d\epsilon/d\theta_0} = - \frac{R_E + R_3/2 - \theta_0^2/2R_3}{2E\theta_0/R_3}. \quad (27)$$

The high-gain feedback amplifier circuit of Figure 4B provides a close approximation to (27). A feedback resistance identical with the  $\theta$  and  $R_E$  elements of the error detector can be used to supply the term in the numerator. A cathode-follower and a voltage divider having a resistance proportional to  $\theta_0$  are the input elements. The cathode-follower is needed to provide a low output impedance for  $R_f$ ; the additional series resistance in the form of amplifier output impedance is a source of inaccuracy.

The approximate gain-equalization circuit shown in Figure 4A provides circuit simplification by linearizing the numerator. Linearization as used in one application caused a maximum gain error of about  $-2.5$  decibels. In this case, relative circuit values were

$$\begin{aligned} R_3 &= 1.07 R_{p3} \\ r_3 &= 0.07 R_{p3} \\ R_E &= 0.225 R_{p3}. \end{aligned}$$

Linearization was accomplished by fitting to the end points of the numerator function. The required gain equalization becomes

$$\left. \begin{aligned} \frac{1}{d\epsilon/d\theta_0} &= -\frac{2R_{ps}(0.225+0.535-\theta_0^2/2.14)}{E\theta_0/1.07} \\ &\doteq -\frac{2R_{ps}(0.76-0.466\theta_0)}{E\theta_0/1.07} \end{aligned} \right\} (28)$$

The curves shown in Figure 5 show the theoretically exact and the approximate values of

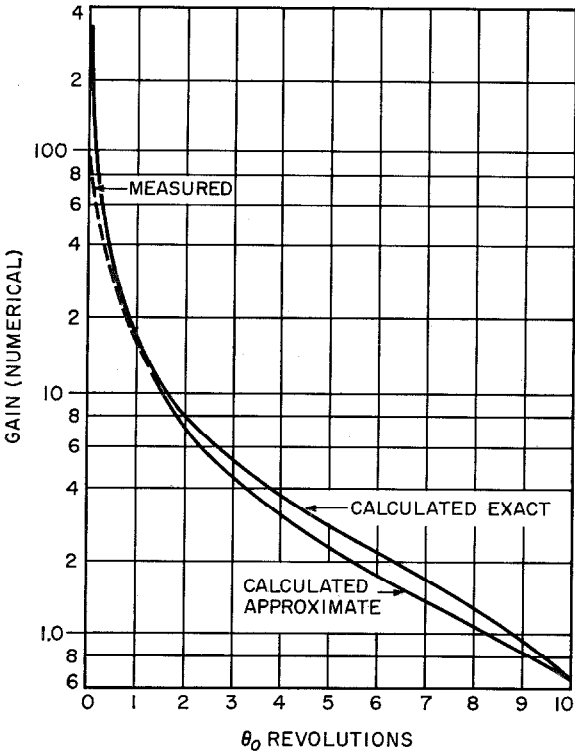


Figure 5—Gain-equalization curve.

gain equalization required. The dotted line indicates the measured divergence of the equalizing circuit from the theoretically approximate curve using an amplifier having an open-loop gain of about 75 decibels. In this case, the gain was limited by the output impedance of the cathode-follower. The maximum gain ratio (maximum gain/minimum gain) of the closed-loop amplifier was 200:1.

Another method that has been used for gain equalization of the computer in Figure 4 is to control the magnitude of the computer supply voltage. A characteristic of this method is that

the computer supply voltage (having the same form as Figure 5) is required to be small over most of the range of operation to prevent excessive power dissipation in the computer elements near the zero end of the range. Several disadvantages result:

- A. Low error sensitivity requires a higher-gain amplifier.
- B. Complicated balanced-to-ground computer power supply circuits are required.
- C. Power-supply balance poses a problem, particularly during high slewing rates near the zero end of the range.

### 5. Discussions on Simple Systems

The method outlined for determining error-sensitivity and gain-equalization requirements generally produces satisfactory results. In each of the three foregoing servomechanism computers, the gain-equalization circuits produced the desired results; that is, frequency response, degree of stability, and angular accuracy were found to remain constant over the range of operation except as noted where extremely high gain was required from the gain-equalization circuit. In reviewing the method of determining error sensitivity and of using the reciprocal error-sensitivity function for gain equalization, one sees that the function  $d\theta_0/d\epsilon'$  in Figure 1B is a constant; therefore, positional accuracy and stability are constant. On the other hand, if gain equalization is not applied, the positional accuracy, assuming a small amount of static friction, is proportional to the reciprocal of the error sensitivity.

These methods have been applied successfully to a variety of simple servomechanism computers that solved trigonometric, logarithmic, and algebraic equations. In addition, a multiple-loop nonlinear computer has been gain equalized, but with less-satisfactory results. The principal problem in gain equalizing a multiple-loop nonlinear servomechanism is that equalization can be applied as a general rule only to the error-voltage path of each system and not to principal data-transmission paths; therefore, other expedients may have to be employed to secure stability.

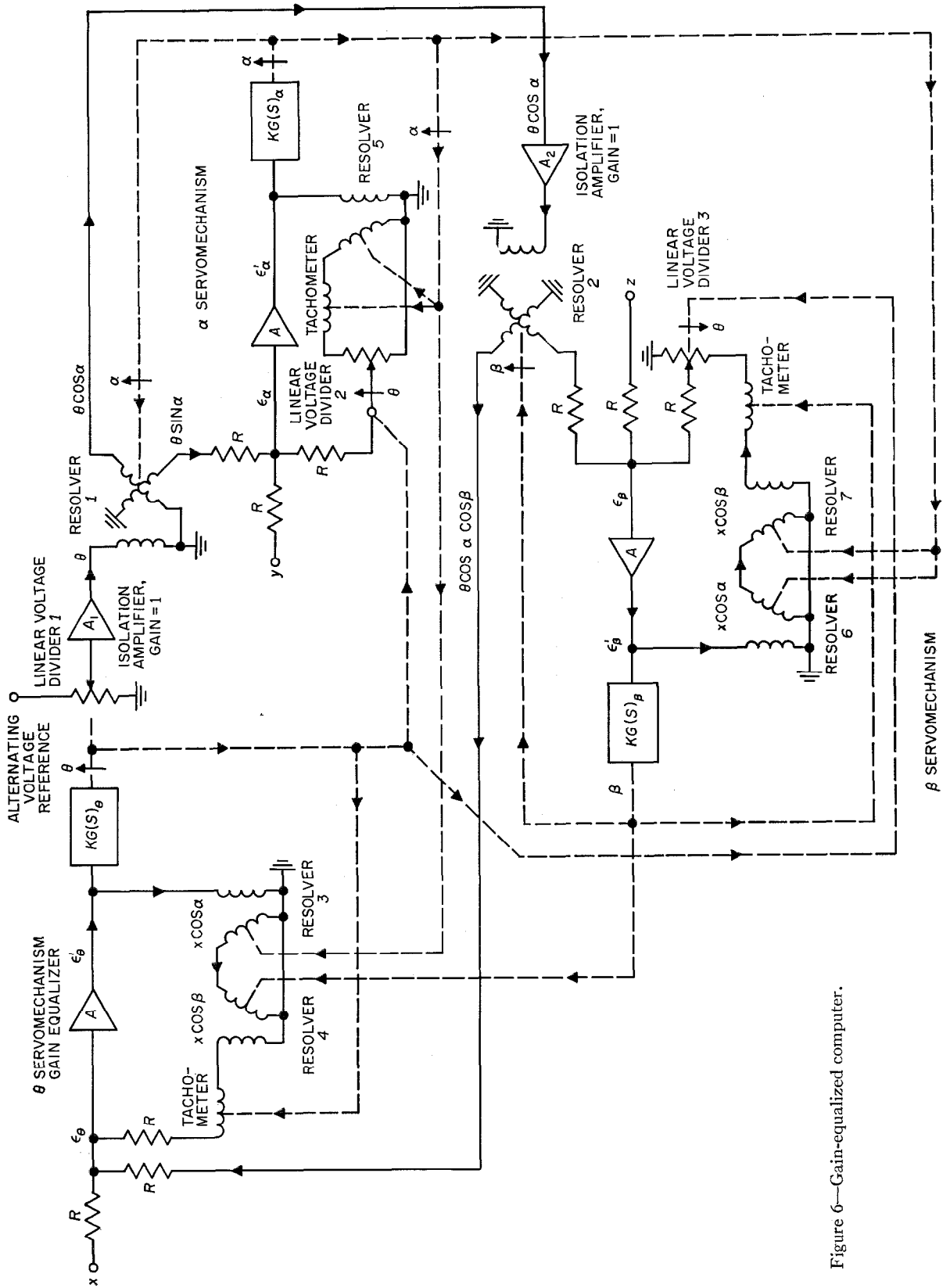


Figure 6—Gain-equalized computer.

Feedback amplifier gain-equalizing methods are often superior to other methods because:

- A. The signal level at the output is generally higher.
- B. Accurate elements may be used to control the gain.
- C. Gain-equalization accuracy is high.
- D. Method is probably simpler than other methods.

### 6. Multiple-Loop Nonlinear Computer

The multiple-loop nonlinear computer, Figure 6, was built for the purpose of finding the hypotenuse of a solid triangle and two of the associated angles. It contained three servomechanisms that solved three nonlinear equations. The purpose of presenting this system is to indicate the problems encountered in trying to gain equalize a multiple-loop nonlinear computer and to demonstrate the method used. Gain equalization was needed for high positional accuracy over the operating range.

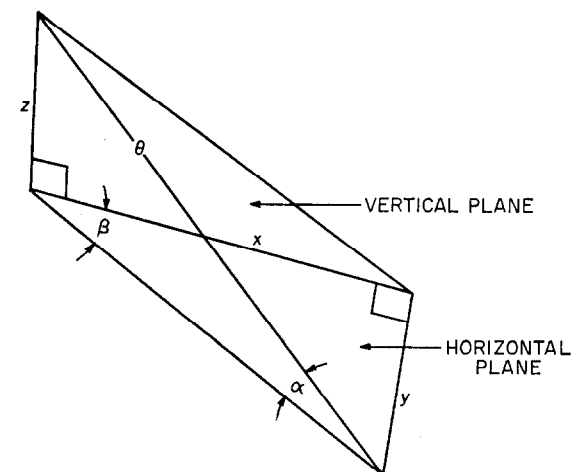


Figure 7—Vector diagram.

Referring to Figure 7, the equations solved, written to indicate the error, were

$$x - \theta \cos \alpha \cos \beta = \epsilon_\theta \quad (29)$$

$$y - \theta \sin \alpha = \epsilon_\alpha \quad (30)$$

$$z - \theta \cos \alpha \sin \beta = \epsilon_\beta \quad (31)$$

The inputs to the equations are the quantities  $x$ ,  $y$ , and  $z$ . The servomechanism outputs are  $\theta$ ,  $\alpha$ , and  $\beta$ . It may be seen that in general,  $\alpha$ ,  $\beta$ , and  $\theta$  all respond to any input of  $x$ ,  $y$ , or  $z$ . Therefore the error sensitivity of the  $\theta$  servomechanism, for example, involves  $\alpha$  and  $\beta$  in addition to  $\theta$ . But  $\alpha$  and  $\beta$  are time functions. Consideration must be given both to the gains as determined from the foregoing equations and to the stability.

The procedure used is first to find the derivatives in (26), (27), and (28) from which a gain equivalent circuit can be made. The equivalent circuit is studied to determine what steps are necessary for gain equalization and system stability.

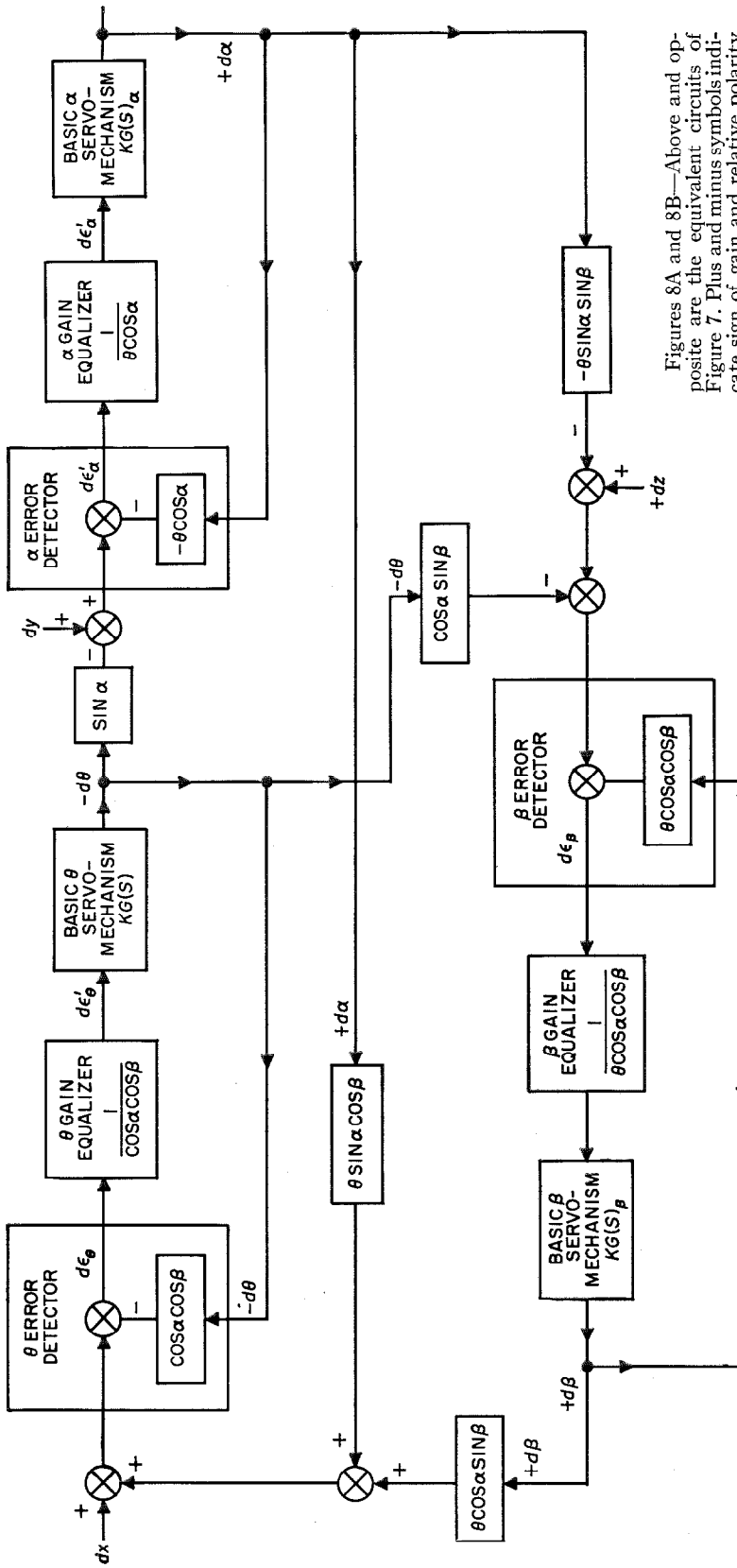
The first step in obtaining the equivalent circuit is to trace out and understand the basic operation of the computer. Considering first the primary signal path, a voltage proportional to the rotation  $\theta$  is obtained from the  $\theta$  servomechanism and applied to a linear voltage divider, the output of which is an alternating voltage proportional to  $\theta$ . The  $\theta$  voltage is applied by isolation amplifier  $A_1$  to resolver 1, which is positioned by the  $\alpha$  servomechanism at angle  $\alpha$ . The outputs are voltages  $\theta \cos \alpha$  and  $\theta \sin \alpha$ .

The  $\theta \cos \alpha$  voltage is applied to isolation amplifier  $A_2$ . The output of  $A_2$  is applied to resolver 2, which is positioned at angle  $\beta$  by the  $\beta$  servomechanism. The voltages appearing at the resolver output windings are  $\theta \cos \alpha \cos \beta$  and  $\theta \cos \alpha \sin \beta$ .

Voltages proportional to  $x$  and  $\theta \cos \alpha \cos \beta$  are subtracted at the input to the  $\theta$  servomechanism by the two adding resistors to form the error voltage  $\epsilon_\theta$ . The  $\theta$  servomechanism maintains the error voltage  $\epsilon_\theta$  at zero by controlling the  $\theta$  quantity in the  $\theta \cos \alpha \cos \beta$  voltage from resolver 2.

The  $\alpha$  servomechanism operates similarly. The input  $y$  and the feedback quantity,  $\theta \sin \alpha$  from resolver 1, are subtracted by two adding resistors to form the error voltage  $\epsilon_\alpha$ . The  $\alpha$  servomechanism positions resolver 1 to control the magnitude of  $\theta \sin \alpha$ . Equation (30) is thereby solved.

The  $\beta$  servomechanism solves (31). The input to the  $\beta$  servomechanism is voltage  $z$ , and the



Figures 8A and 8B—Above and opposite are the equivalent circuits of Figure 7. Plus and minus symbols indicate sign of gain and relative polarity of signals.

feedback quantity is voltage  $\theta \cos \alpha \sin \beta$ . These two voltages are subtracted by the adding resistors to form error voltage  $\epsilon_\beta$ . The  $\beta$  servomechanism positions resolver 2 to maintain  $\epsilon_\beta$  at zero.

Circuits for gain equalization and damping will be described after consideration of gain equalization requirements.

Taking the derivatives of (29), (30), and (31), one obtains

$$d\epsilon_\theta = dx - \cos \alpha \cos \beta d\theta + \theta \sin \alpha \cos \beta d\alpha + \theta \cos \alpha \sin \beta d\beta \quad (32)$$

$$d\epsilon_\alpha = dy - \sin \alpha d\theta - \cos \alpha d\alpha \quad (33)$$

$$d\epsilon_\beta = dz - \cos \alpha \sin \beta d\theta + \theta \sin \alpha \sin \beta d\alpha - \theta \cos \alpha \cos \beta d\beta. \quad (34)$$

Equations (32), (33), and (34), with the aid of Figure 7, may be combined as an equivalent circuit, Figure 8A. The individual servomechanisms of Figure 8A are gain equalized within themselves by assuming that the feedback paths from the other servomechanisms are opened.

Referring to the gain-equalized  $\theta$  servomechanism, which has a feedback factor  $\cos \alpha \cos \beta$  within the error detector, the zero-frequency output-input response is

A. GAIN-EQUIVALENT CIRCUIT WITH INDIVIDUAL SERVOS EQUALIZED

$$\left. \begin{aligned} \frac{d\theta_o}{d\theta_i} &= \frac{\frac{KG(s)\theta}{\cos \alpha \cos \beta}}{1 + \frac{KG(s)\theta}{\cos \alpha \cos \beta}} \\ &= \frac{KG(s)\theta}{\cos \alpha \cos \beta + KG(s)\theta} \\ &= 1/(\cos \alpha \cos \beta)/w = 0. \end{aligned} \right\} (35)$$

(30) and (31). The responses are

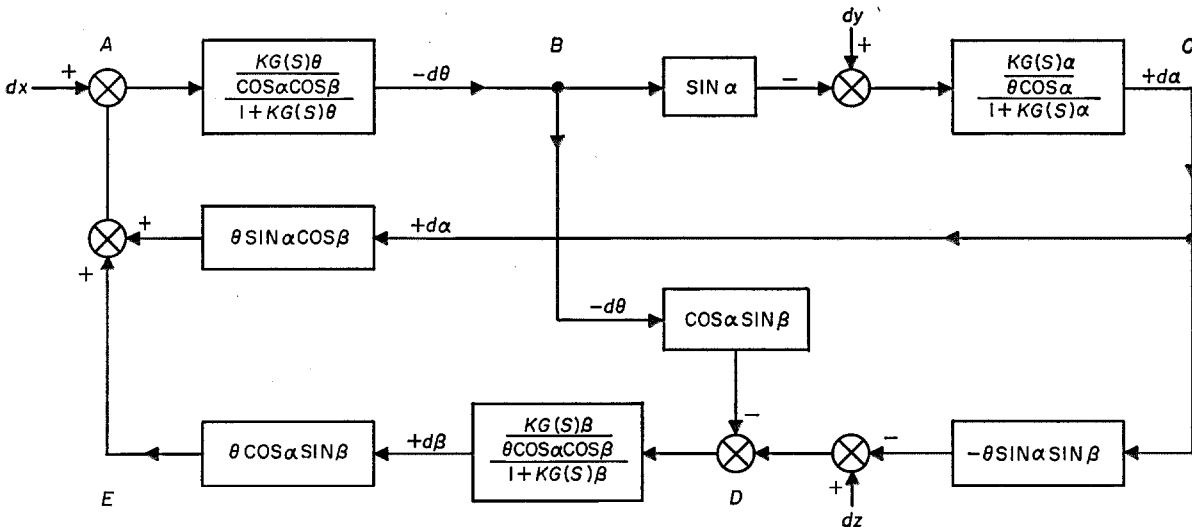
$$\frac{d\alpha_o}{d\alpha_i} = \frac{\frac{KG(s)\alpha}{\theta \cos \alpha}}{1 + \frac{KG(s)\alpha}{\theta \cos \alpha}} = 1/(\theta \cos \alpha)/w = 0, \quad (36)$$

$$\frac{d\beta_o}{d\beta_i} = \frac{\frac{KG(s)\beta}{\theta \cos \alpha \cos \beta}}{1 + \frac{KG(s)\beta}{\theta \cos \alpha \cos \beta}} = 1/(\theta \cos \alpha \cos \beta)/w = 0. \quad (37)$$

The loop gain, before gain equalization, is proportional to  $\cos \alpha \cos \beta$  if it is assumed that the other servomechanisms are disabled. This may be determined by inspection of (32) in which  $dx$ ,  $d\alpha$ , and  $d\beta$  would become zero. The reciprocal of this function is  $1/(\cos \alpha \cos \beta)$ , the required gain-equalization function.

In the  $\theta$  servomechanism loop, the gain equalization is provided by feedback around a

The gain-equalization factors, as determined from (33) and (34), are included in (36) and (37). The factors are the reciprocals of the error sensitivities,  $1/(\theta \cos \alpha)$  for the  $\alpha$  servomechanism and  $1/(\theta \cos \alpha \cos \beta)$  for the  $\beta$  servomechanism, with the other servomechanisms disabled in each case. In the  $\alpha$  system, the feedback factor is obtained by using a high-gain amplifier and feed-



B. FIRST SIMPLIFIED GAIN-EQUIVALENT CIRCUIT

Figure 8B.

high-gain amplifier. The feedback factor  $\cos \alpha \cos \beta$  is obtained from resolvers 3 and 4. The induction generator (tachometer), the output of which is in series with the output of resolver 4, provides variable damping proportional to  $1/(\cos \alpha \cos \beta)$ . The need for this is explained later. In this instance it is intended that  $KG(s)\theta$  represent an undamped open-loop servomechanism.

The output-input responses of the  $\alpha$  and  $\beta$  servomechanisms are similarly determined from

back proportional to  $\theta \cos \alpha$  from resolver 5 and voltage divider 2. Similarly in the  $\beta$  system, requiring a feedback factor  $\theta \cos \alpha \cos \beta$ , the feedback is obtained using resolvers 6 and 7 and voltage divider 3. The outputs of the tachometers are connected in the feedback loop in a manner such that the damping gain is proportional to  $1/\cos \alpha$  for the  $\alpha$  system and  $1/(\cos \alpha \cos \beta)$  for the  $\beta$  servomechanism. (This is true because at the point of application of the tachometric feedback, the equalizing voltage divider is in

the forward path and the equalizing resolvers are in the feedback path.)

The gain equalization and stability of the entire system may be studied by considering Figure 8B in which each circuit of Figure 8A has been combined into a single transfer function. Studying the zero-frequency response and stability of the system can be done with the aid of Figure 8B and (32), (33), and (34). Expressions for zero-frequency gain can be found that may be converted simply into time functions when frequency response is studied.

The gain of parallel paths  $(BD + BCD)$  in series with path  $DE$  is

$$\begin{aligned} \text{gain } (BD + BCD)DE &= \left( \cos \alpha \sin \beta + \frac{\theta \sin^2 \alpha \sin \beta}{\theta \cos \alpha} \right) \\ &\quad \times \frac{\theta \cos \alpha \sin \beta}{\theta \cos \alpha \cos \beta} \quad (38) \\ &= \frac{\sin \beta (\cos^2 \alpha + \sin^2 \alpha)}{\cos \alpha} \times \frac{\sin \beta}{\cos \beta} \\ &= \frac{\sin^2 \beta}{\cos \alpha \cos \beta}. \end{aligned}$$

The gain of path  $BCE$  is

$$\begin{aligned} \text{gain } (BCE) &= \left. \begin{aligned} &\frac{\sin \alpha \theta \sin \alpha \cos \beta}{\theta \cos \alpha} \\ &= \frac{\sin^2 \alpha \cos \beta}{\cos \alpha} \end{aligned} \right\} \quad (39) \end{aligned}$$

The entire system loop gain is that of path  $AB$  in series with parallel paths  $[(BD + BCD)DE + BCE]$ .

$$\begin{aligned} \text{System gain} &= \left( \frac{\sin^2 \beta}{\cos \alpha \cos \beta} + \frac{\sin^2 \alpha \cos \beta}{\cos \alpha} \right) \\ &\quad \times \frac{1}{\cos \alpha \cos \beta} \quad (40) \\ &= \frac{\tan^2 \beta + \sin^2 \alpha}{\cos^2 \alpha} \\ &= \sec^2 \alpha \tan^2 \beta + \tan^2 \alpha. \end{aligned}$$

Equation (40) indicates that the system gain is infinite for  $\alpha$  or  $\beta = \pm 90$  degrees; this is not true because the gain of each servomechanism is zero at these points due to limited equalizer gain. The system gain actually reaches some maximum as  $\alpha$  and  $\beta$  tend to  $\pm 90$  degrees, but becomes

zero at  $\pm 90$  degrees. However, the zero-frequency loop gain is negative for all loops; this may be seen from Figure 8B in which the sign of all quantities is indicated. For example, a negative change  $(-d\theta)$  at point  $B$  results in positive quantities arriving at  $A$  to compensate the change.

The system stability may now be considered. Assume the angle  $\beta$  is zero as a result of the  $z$  input being zero. The system gain from (40) is

$$\text{gain} = \tan^2 \alpha. \quad (41)$$

This quantity becomes very high as  $\alpha$  tends to  $\pm 90$  degrees because of the gain equalization. Consider a viscous-damped second-order servomechanism. The output-input ratio at the natural frequency is

$$\frac{\theta_o}{\theta_i}(j\omega_N) = \frac{1}{2c} / -90^\circ. \quad (42)$$

The servomechanisms in Figure 6 have variable damping such that for the three servomechanisms the damping factors are

$$c_\theta = c / (\cos \alpha \cos \beta) \quad (43)$$

$$c_\alpha = c / \cos \alpha \quad (44)$$

$$c_\beta = 1 / (\cos \alpha \cos \beta). \quad (45)$$

The loop gain at the natural frequency is of interest in (41). Since the total phase shift of the  $\theta$  and  $\alpha$  servomechanisms is  $-180$  degrees,  $\omega_N$  would be the frequency at which the system would oscillate. Considering (41), (42), (43), and (44), equation (41) may be rewritten

$$\begin{aligned} \text{gain } \theta_\alpha &= \tan^2 \alpha \cdot (1/2c_\theta) \cdot (1/2c_\alpha) / -180^\circ \\ &= (\sin^2 \alpha) / 4c^2 / -180^\circ. \end{aligned} \quad (46)$$

Equation (46) shows that for  $c > 0.5$  the system is stable for  $\alpha = \pm 90$  degrees since the gain is less than unity.

Similarly if  $\alpha$  is zero, the gain using variable damping is

$$\text{gain } (\theta_1\beta) = (\sin^2 \beta) / 4c^2 / -180^\circ. \quad (47)$$

The path  $ABCDE$  is closed during combined input conditions. This path has three servomechanisms in series and hence represents the most-unstable situation. Ignoring other paths,



the direct-current gain is

$$\left. \begin{aligned} \text{gain } (ABCDE) &= \frac{\sin^2 \alpha \sin^2 \beta}{\cos^2 \alpha \cos^2 \beta} \\ &= \tan^2 \alpha \tan^2 \beta. \end{aligned} \right\} \quad (48)$$

Here as before the loop gain tends to a maximum, being limited by the servomechanism gain of zero at  $\pm 90$  degrees. If the damping term  $c$  of each loop is increased to 0.707 or more, the frequency of greatest gain is zero and the minimum loop gain is

$$\text{gain } (ABCDE)_{\max} = \sin^2 \alpha \sin^2 \beta \cos \alpha. \quad (49)$$

The maximum value of (49) is 0.577 occurring for  $\alpha = 55$  degrees and  $\beta = 90$  degrees.

The computer as first constructed was unstable in ranges greater than  $\alpha$  or  $\beta = 45$  to 60 degrees. Instability was characterized by large, fairly low-frequency oscillations. This was due in part to velocity saturation of the  $\theta$  servomechanism. Application of variable damping permitted increases of  $\alpha$  and/or  $\beta$  to 70 or 75 degrees before instability would occur. The loop gain with, say,  $\beta = 0$  is proportional to  $\tan^2 \alpha$ , which was increased by factors ranging from 2.5:1 to 14:1 by use of variable damping. Overdamping in individual servomechanisms, al-

though not desirable, generally was not serious because  $\alpha, \beta$ , were usually small quantities in the intended application of the system.

## 7. Symbols Used

|             |   |
|-------------|---|
| $A$         | = gain  |
| $c$         | = damping factor                                      |
| $E$         | = reference voltage                                   |
| $KG(s)$     | = basic open-loop servomechanism transfer function    |
| $R$         | = resistance  |
| $R_p$       | = voltage-divider resistance                          |
| $s$         | = Laplace transform variable                          |
| $x$         | = input variable                                      |
| $y$         | = input variable                                      |
| $z$         | = input variable                                      |
| $\alpha$    | = output rotation                                     |
| $\beta$     | = output rotation                                     |
| $\epsilon$  | = error produced by error detector                    |
| $\epsilon'$ | = error produced by gain equalizing circuit           |
| $\theta_i$  | = input rotation                                      |
| $\theta_o$  | = output rotation                                     |
| $\theta_0$  | = rotation as fractional portion of total resistance. |

Subscripts  $o$  and  $i$  refer to output and input, respectively.

# Compandor System Z6NC for Short-Haul Carrier Telephony\*

By L. CHRISTIANSEN, F. BUCHHOLTZ, and W. ZAISER

*Standard Central Laboratories; a division of Standard Elektrik A.G. (now Standard Elektrik Lorenz A.G.); Stuttgart, Germany*

**E**LECTRICAL and constructional details of the Z6NC system are briefly described. Based on diagrams, the description gives the special features of the Z6NC system: compandor properties; effect of compressed, normal, and expanded speech on crosstalk; level control; and other features. In conclusion, the most-important system properties for application to cable and open wire line are given.

. . .

Six telephone calls can be transmitted on a two-wire system by the Z6NC compandor carrier-telephone system. Each channel has its own compandor, improving transmission quality by lessening the effects of noise and crosstalk. Net loss stability is better than that specified by recommendations of the Comité Consultatif International Téléphonique since automatic level control is incorporated in each channel. The system permits transmission of dialing or metering pulses with small time delay and low distortion. Considerable simplification in design is obtained by utilization of the compandor, which also permits simultaneous carrier transmission on both side and phantom circuits. In addition to the usual application to cables, the system can be applied to open wire lines since automatic level control is provided in both channel and group equipments and in the repeaters.

## 1. Introduction

The Z6NC carrier system may be regarded as a further development of the Z6NT system introduced in 1952,<sup>1</sup> which also transmits six carrier-frequency calls on a two-wire line in deloaded or nonloaded symmetrical-core cable and is designed primarily for the lower network, the arrangement of lines between the end office

\* Reprinted from *FTZ*, volume 8, pages 502-511; September, 1955.

<sup>1</sup> L. Christiansen, "Nahverkehrs-Sechskanal-Trägerfrequenz-System Z6NT," *SEG-Nachrichten*, volume 2, pages 4-12; 1953.

and the primary center. However, the newer system is further suitable for application to open wire lines or aerial cables.

There are three points in which the Z6NC system is superior to the older system. These are:

- A. Improved signal-to-noise ratio.
- B. Incorporates signal transmission circuits.
- C. Greater stability of net loss.

Development of the Z6NC was carried out with close adherence to specifications for short-haul systems issued by the Deutsche Bundespost.

## 2. Circuit Applications

The introduction of a compandor<sup>2</sup> permits telephone operation under very-unfavorable noise and crosstalk conditions. Moreover, the compandor with its improvement of signal-to-noise ratio by 2.6 nepers\* enables simultaneous use of the side and phantom circuits of star-twisted and multiple-twin cables enabling transmission of 18 calls on a quad. Even in marginal cases, simultaneous utilization of side and phantom circuits can be secured by inexpensive phase shifters inserted in the carrier generator at the terminal.<sup>3</sup> Crosstalk compensation in lines with normal crosstalk, even in lines of older types, is unnecessary.

The system carries signals with satisfactory speech immunity, permitting transmission of dialing and metering pulses during conversation. Due to level control, the signal distortion is at a minimum.

The automatic level regulation for each channel maintains the specified toll-circuit net loss despite attenuation variations of  $\pm 1$  neper.

<sup>2</sup> M. Jänke, E. Prenzel, and W. Speer, "Dynamikpresser und -dehner für Fernsprecherbindungen," *FTZ*, volume 6, pages 459-469; October, 1953.

\* 1 neper = 8.686 decibels.

<sup>3</sup> W. Hofmann, "Nebensprechausgleich bei Zweiseitenbandsystemen," *FTZ*, volume 8, pages 555-558; October, 1955.

In addition to the level regulation of each channel, level regulation for the over-all group can be switched in. This permits utilization of the system over open wire lines with or without cable lead-ins or over aerial cables. In these cases, attenuation variations of up to approximately 4 nepers at the highest frequency can be compensated. The compandor also permits utilization of open wire lines with a high amount of interfering noise (for instance, interfering radio trans-

Compatibility with *Z6N*, *Z12N*, and *Z12K* systems operated on adjacent circuits, for instance in the same cable, is easily established by shifting the lower transmission band by 2 kilocycles per second. The carrier frequencies of the *Z6NC* system then coincide with the zero frequencies of the other systems.

The equipment is produced in the new mechanical design of the Deutsche Bundespost with plug-in panels.

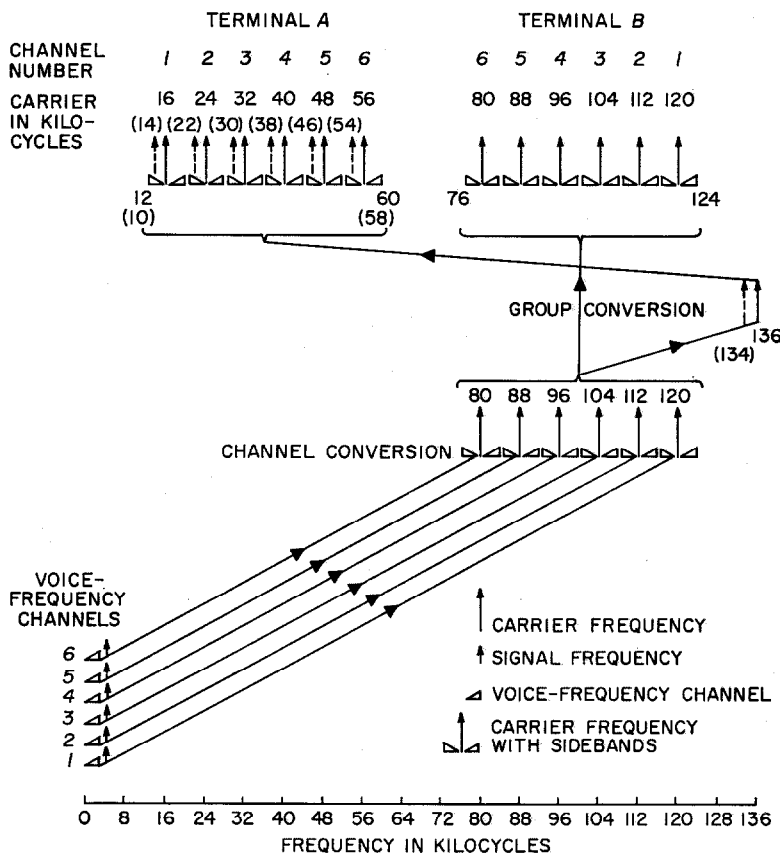


Figure 1—Modulation scheme. Substitution of the 136-kilocycle group conversion carrier by 134 kilocycles drops the lower hand by 2 kilocycles for compatibility with other systems.

mitters). It may be stressed here that no special rearrangement within the system is necessary for application to open wire lines; it is ready for operation after changing a few connections.

Automatic level regulation or, if necessary, group frogging can be applied in *Z6NC* repeaters that are suitable both for cable and open wire operation.

The transmitting and receiving paths are shown in Figure 2. Only the essential points of these circuits will be pointed out here. A dynamic compressor is located at the channel input and a dynamic expander at the output. These form the previously mentioned compandor. The signal and speech circuits are combined before channel modulation. The filter usually found in the output

### 3. Electrical Details

#### 3.1 TERMINAL EQUIPMENT

##### 3.1.1 Modulation Scheme

Figure 1 shows the modulation scheme of the transmitting terminals. Voice-frequency channels 1 through 6 and the accompanying signal frequencies are modulated with carriers of 80 through 120 kilocycles and thus appear in the desired frequency band at terminal B. The group carrier frequency of 136 or 134 kilocycles translates the high band into the desired low-frequency band for terminal A.

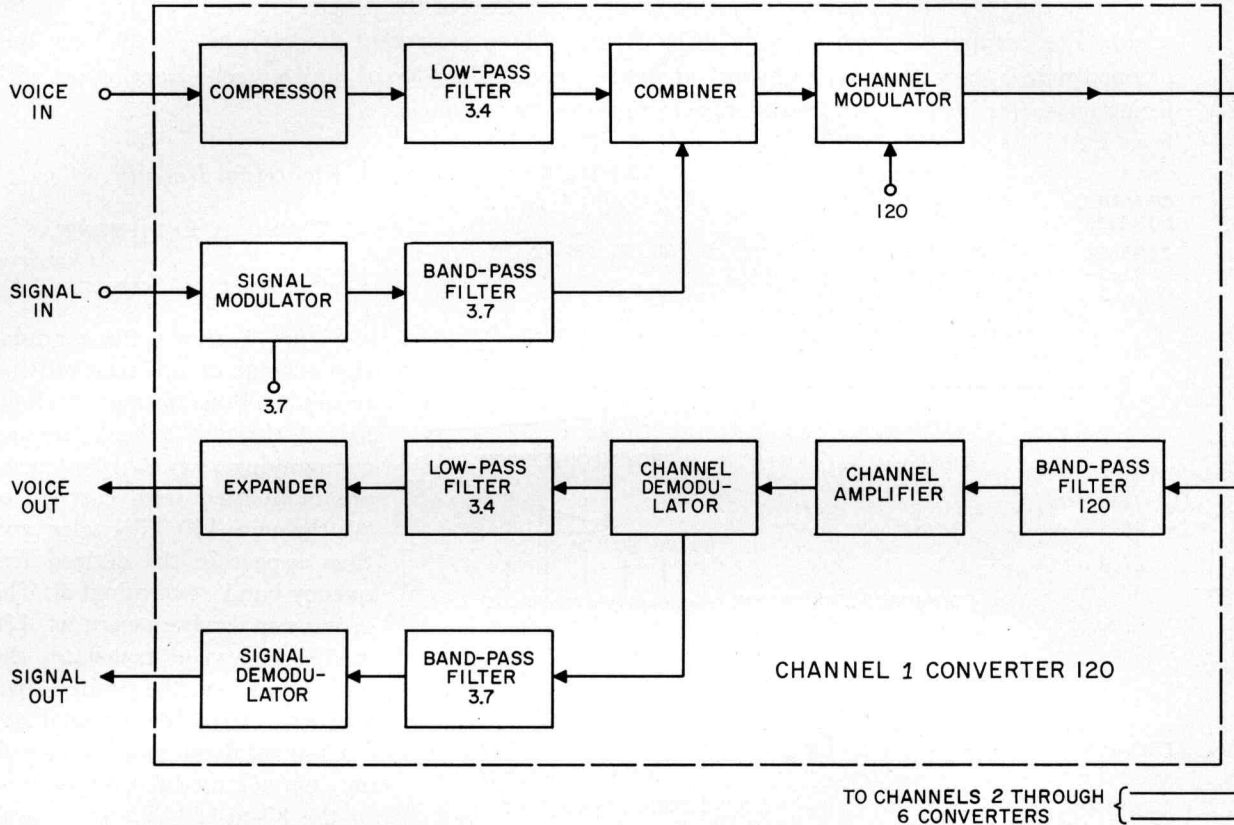
Channel demodulation as well as channel modulation is done in the 80-to-120-kilocycle band. At the receiver, the individual carrier-frequency channels are separated by simple band-pass filters, amplified, and demodulated by full-wave rectification.

##### 3.1.2 Transmitting and Receiving Paths

circuit of the channel modulator has been omitted owing to sufficient decoupling and to the action of the compander. The signal modulator passes the signal frequency of 3.7 kilocycles when the signal input conductor is grounded. The signal spectrum generated by this keying is

amplifier. (If necessary, the level of the transmitted high band can be increased to  $1.5 \pm 0.3$  nepers.)

The receiving carrier level must be between  $+0.5$  and  $-8.6$  nepers at 120 kilocycles. In the receiving path, the incoming frequency band



limited by the band-pass filter. The channel modulator output contains the carrier frequency plus all sidebands produced by the voice and signal frequencies. The depth of modulation of the carrier is about 35 to 45 percent for both the signal and speech currents when zero level (1 milliwatt in 600 ohms) is applied to the channel input.

The six channels, decoupled by attenuators, are merged before group translation. The low-pass filter at the converter input attenuates the higher-order modulation products to a sufficiently low value. The group modulator translates the high band into the low band. The individual carriers at the output of the directional filter have a power level of 0.5 neper, variable by  $\pm 0.3$  neper in steps of 0.1 neper in the transmitting

(16 to 124 kilocycles in the case shown in Figure 2) is applied to an equalizer, pad, and receiving preamplifier so that all carrier levels are of equal magnitude. Due to the double-sideband transmission, the requirement of accurate equalization is not too stringent here. The main receiving amplifier next in line has a gain independent of frequency and a low internal resistance; the incoming carrier levels can be measured at its output, where a jack is provided. The individual channels are separated by band-pass filters; the only constructional units in which the channels differ. The channel amplifier is automatically gain-regulated, this regulation responding to the magnitude of the carrier level. The carrier is demodulated next. The direct current obtained from the channel demodulator

has a magnitude dependant on the carrier level; it operates a control relay indicating absence of carrier or any other discontinuity in the transmission path. The (compressed) voice-frequency band obtained by demodulation is applied via a low-pass filter to the expander, where the dy-

the carrier frequencies of 80 to 120 kilocycles required for channel modulation. The oscillator generating 3.7 kilocycles for a signal modulator has no crystal. The group carrier frequency of 136 (or 134) kilocycles is again obtained from a crystal oscillator, the change from 136 to 134

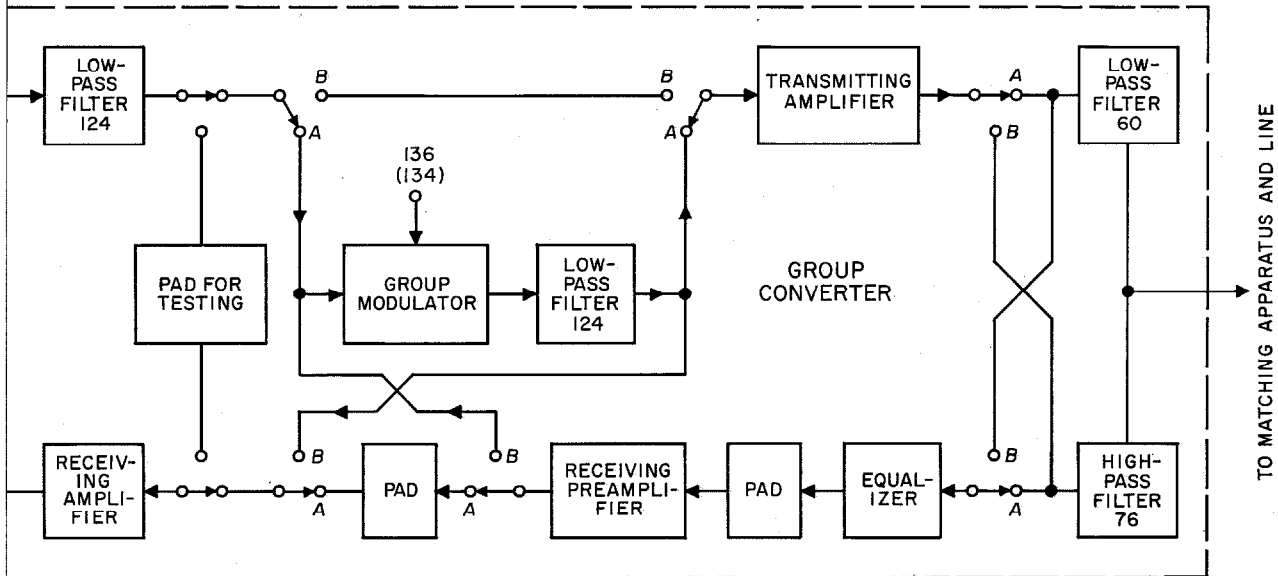


Figure 2—Block diagram of Z6NC terminal equipment. The unlabeled numbers indicate frequencies in kilocycles. Connections A are made when the low band is transmitted and the high band received, and B are made when the high band is transmitted and the low band received.

amic range is enlarged. The output amplitude of the speech channel can be varied by a control in the expander. The range of this adjustment is  $\pm 0.35$  neper, the adjustment being stepless. If a signal is sent from the far-end terminal station, the incoming signal current passes successively through the signal band-pass filter, a rectifier demodulator circuit, and is finally applied to a polarized relay; the contact of the latter grounds the output signal conductor.

Measurements of the channel modulator can be taken by connecting the test pad in the group converter.

For the transmission of voice-frequency carrier telegraph, the compandor is rendered ineffective by simple switching means.

### 3.1.3 Carrier Generator

The fundamental frequency, produced by an 8-kilocycle crystal oscillator, is converted into a pulse train supplying, through band-pass filters,

kilocycles being accomplished by exchanging crystals. The carrier-supply capacity is so dimensioned that four terminal stations making up one bay can be furnished with the carrier voltages required. The group carrier generator can also supply energy for 8 repeaters that can be accommodated in a bay of the same size.

### 3.1.4 Power Supply and Tube Complement

The power for a complete bay with four terminal stations is supplied by the mains or partly by batteries. The power supply unit is therefore included in the bay; its power consumption amounts to approximately 670 volt-amperes. The tube complement for four terminals including carrier power supply consists of 97 tubes (C3m pentodes with a guaranteed life of 10 000 hours of operation).

## 3.2 REPEATER

The Z6NC repeater is provided for amplification of the 12-to-60- (or 10-to-58-) and 76-to-

124-kilocycle frequency bands, transmitted in two-wire operation. To avoid feedback of cross-talk through other circuits, the incoming transmission bands are interchanged at the repeater output. The frequency-dependent attenuation of short-haul cables up to values of 8.3 nepers at 124 kilocycles (corresponding to 33 kilometers, or 21 miles of 1.4-millimeter copper conductor) can be compensated by the repeater. The equipment can be operated as a two-wire repeater without group frogging also, and can operate as a four-wire repeater with or without frogging.

In Figure 3, the incoming band is equalized by an equalizer, pad, and preamplifier. Subsequently, the band is translated. The band thus obtained is amplified in the main amplifier with a large amount of feedback and appears across the toll line via the low- or high-pass part of the output directional filter and the toll-line transformer.

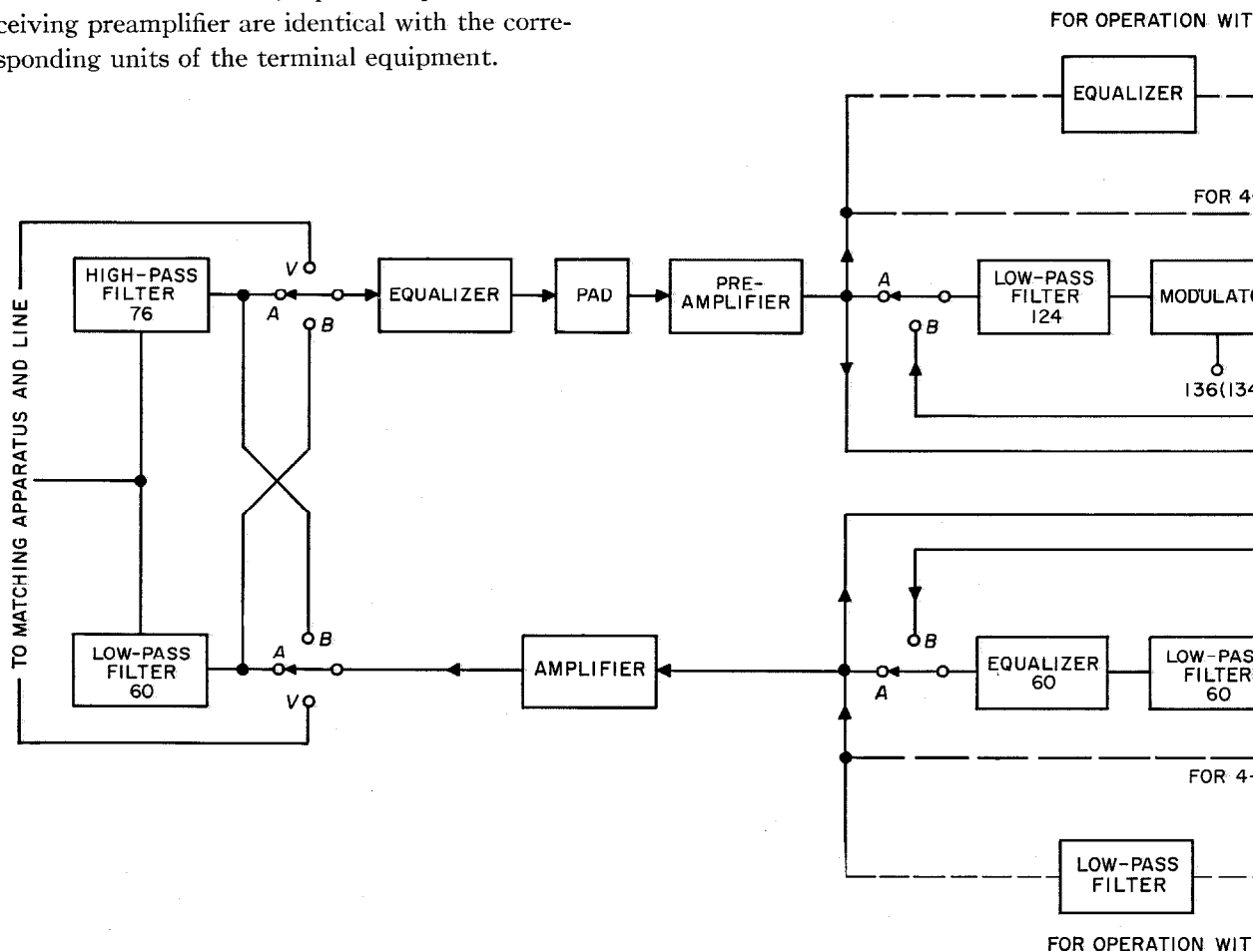
The directional filter, equalizer, pad, and receiving preamplifier are identical with the corresponding units of the terminal equipment.

#### 4. Mechanical Construction

The Z6NC system is mounted in exchangeable plug-in panels in bays with lock and key according to the mechanical design of the Deutsche Bundespost.

The standard bay generally takes four complete terminal equipments each comprising three channel-converter panels (for two channels each) and a group-converter panel. The carrier supply consists of one panel and a unit accommodated on the operator's board. This, as well as the panel with heater-power and signaling-current supply and the panel with the plate-current ( $B+$ ) supply, are provided centrally and are so dimensioned that a fully equipped bay with four terminals can be supplied with power.

Figure 4 shows an opened cabinet with 24 channels. The bay is so wired that terminals alone or repeaters alone or both arbitrarily mixed



can be accommodated. When fully equipped, the bay will take 8 repeaters.

Constructional details of the channel modulator panel are shown in Figure 5. The photograph shows the complete panel and several subunits.

The control jack strips of the panels comprise level and other measuring jacks and circuit-breaker plugs. Signals indicate any breakdown of operational voltages, fuses, or tubes.

The bay is about 2600 millimeters (102 inches) high, 600 millimeters (24 inches) wide, and 222 millimeters (9 inches) deep. The weight of a fully equipped bay is about 330 kilograms (726 pounds). If only one or two *Z6NC* terminals or repeaters are required for the completion of a line, they can be mounted in a halfbay 1500 millimeters (59 inches) high, with width and depth as for the normal bay. The weight of the halfbay is about 180 kilograms (396 pounds).

## 5. Technical Innovations

### 5.1 COMPANDOR

#### 5.1.1 General

The introduction of compandors in various international systems (for instance, the *N1*, *45A*, *ON*, and *O* systems) aims at improvement of transmission properties without substantially increasing the cost.

Various publications<sup>2,4,5</sup> contain detailed descriptions of the effect of the compandor, its properties, and its performance when handling speech or sinusoidal signals.

In the following, an attempt is made to describe briefly the most important properties of such equipment.

The two components of the compandor; that is, the compressor and the expander; are electrically so designed that no difference in the speech

<sup>4</sup> R. S. Caruthers, "N-1 Carrier System," *Bell System Technical Journal*, volume 30, pages 5-32; January, 1951.

<sup>5</sup> G. Hässler, "Sprachübertragung mit Dynamikkompensation," *FTZ*, volume 12, pages 659-664; December, 1954.

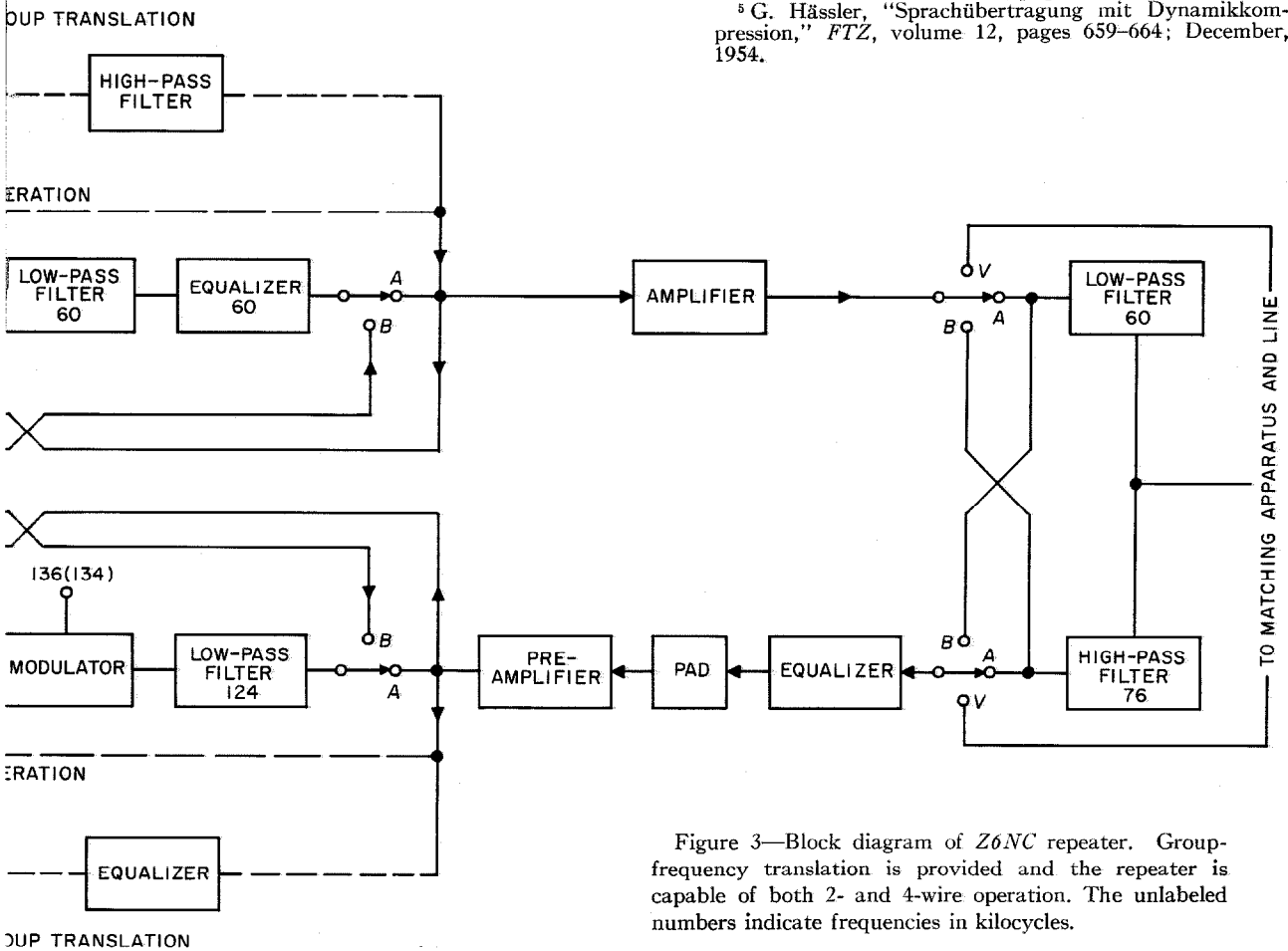


Figure 3—Block diagram of *Z6NC* repeater. Group-frequency translation is provided and the repeater is capable of both 2- and 4-wire operation. The unlabeled numbers indicate frequencies in kilocycles.



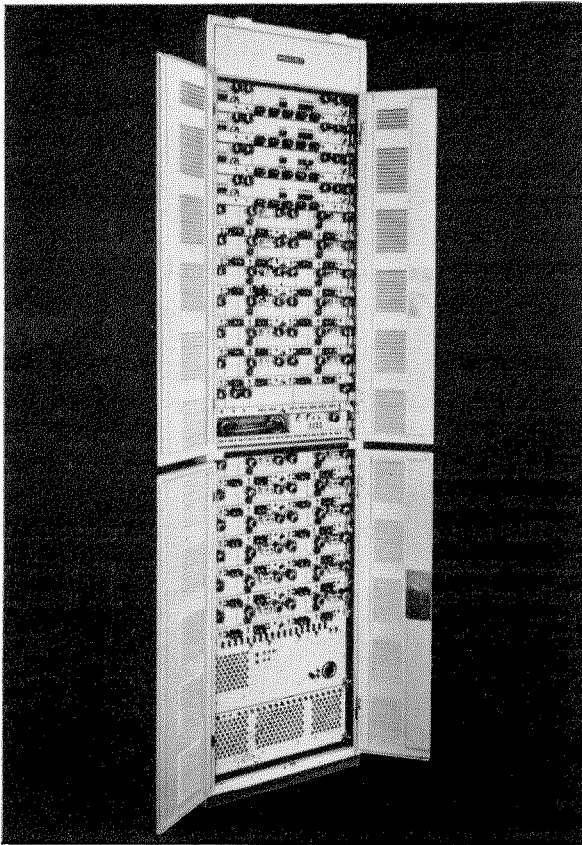


Figure 4—Front view of Z6NC bay equipped with 4-terminal equipment.

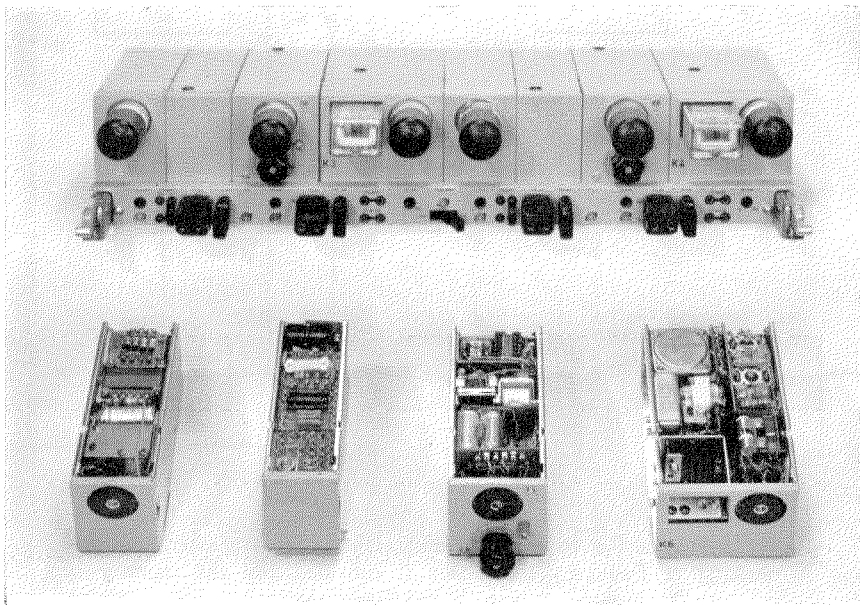


Figure 5—Channel converter panel with subassemblies.

signals between the system input and output can subjectively be found.

Even when 10 compandors are connected in series, the loss of speech quality is not deleterious. The intelligibility at the output of a system depends both on the noise component superimposed on syllabic speech and on the noise level during the intersyllabic periods. Both of these conditions are affected advantageously by the compandor.

During conversation, the compressor emphasizes low-volume syllables. Hence, transmission on the toll line is done at a higher average level; the low-volume syllables ride above the noise level in which they would be drowned in a similar system without a compandor. This alone leads to speech of better quality.

Between speech intervals, the expander causes considerable suppression of interfering noise (standard value of about 2.6 nepers); speech following a quiet interval thus becomes more intelligible due to a peculiarity of the human ear, which adapts itself to higher sensitivity during a quiet interval.

With respect to equipment design, the following advantages are obtained by the use of the compandor: Lower requirements on linearity of amplifiers and modulators. Reduced requirements with respect to the blocking properties of filters in speech and signal circuits. Elimination of channel transmitting filters. More compact construction because of the reduced danger of mutual interference between components.

#### 5.1.2 Electrical Characteristics of Compandor

The block diagram of Figure 6 shows the action of the compressor and expander with the characteristics below. The expander characteristic is used directly to derive the value of the expander gain (Figure 7), which depends on the

noise level. Due to the germanium diodes employed in compressor and expander, the characteristics are to a small degree dependent on temperature. A large portion of the development work was devoted to this problem. No noticeable change of the characteristics described is caused by ambient temperatures of +10 to +35 degrees centigrade.

The stability of short-haul systems depends on the maintenance of a defined net loss. Since the net loss in a compandor system depends somewhat on the input signal amplitude, an increase of net loss will be observed at the edges of the channel transmission band (frequency dependence) and with decreasing signal amplitudes (amplitude dependence). Figure 8 shows typical amplitude dependence for a compressor-expander system. These properties result, for the case of nonmodulated carriers and at the rated noise level, in an important improvement of the singing margin as shown in Figure 9.

A typical median characteristic of the frequency-dependent net loss for 12 channels in both transmission directions, measured with the nominal level, is plotted in Figure 10. Actual conditions are much more favorable because the effective control current for compressors and expanders is determined by the total energy

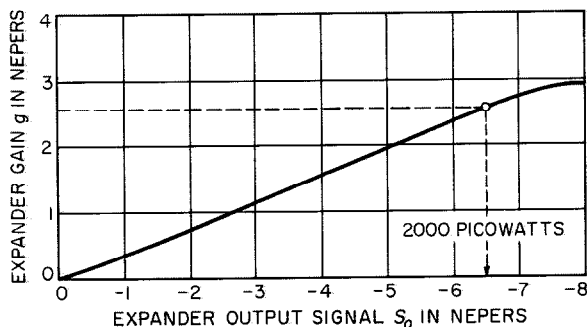


Figure 7—Expander gain characteristic. The dashed lines show the limit set by noise.

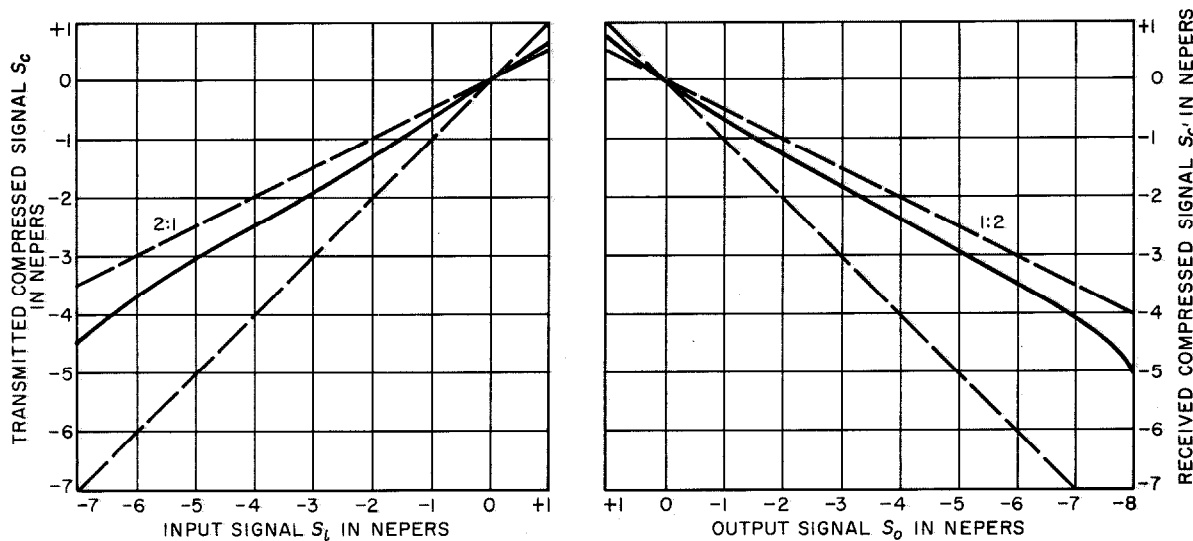
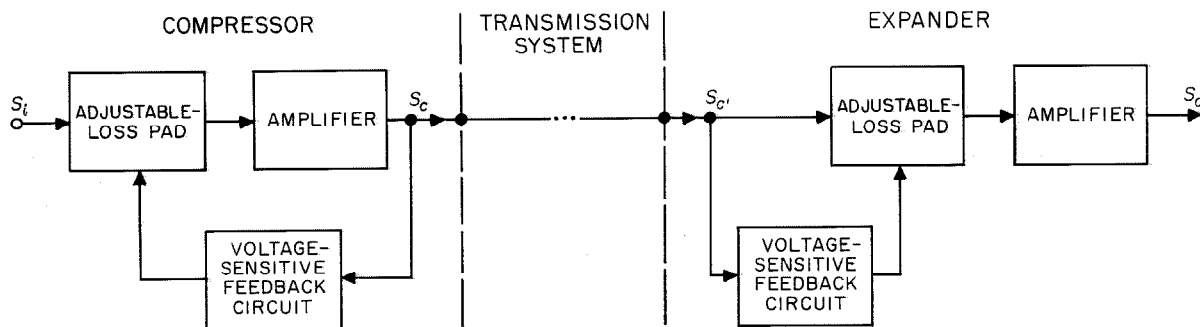


Figure 6—The compandor circuit and its characteristics with respect to relative zero level.

concentration of human speech in the range from 500 to 1000 cycles. Therefore, the net-loss variations to be expected are within 20 percent of the tolerance specification of the Comité Consultatif International Téléphonique.

### 5.1.3 Effect of Compressor on Perturbances

As long as the line noise equally affects both sidebands of the transmitted carrier, an expander gain as in Figure 7 becomes effective during the speech intervals. Since the voltages of the two sidebands are added, while the powers of the noises are added, the sideband-level-to-noise ratio on the toll line may be smaller by  $(0.35 \text{ neper} + \text{expander gain } g)$  than the desired signal-to-noise ratio in the output.

For selective disturbers affecting one sideband only, the signal-to-noise ratio in the output is larger by  $(0.7 \text{ neper} + g)$  than the ratio on the line.

Figure 11 is a comparison of the *Z6NC*, *Z12N*, *Z6N*, *Z12K*, and *Z6NT* systems with respect to signal-to-noise ratio in the output, assuming that line lengths are equal and noise level is constant. The comparison shows in each case a gain in signal-to-noise ratio for the *Z6NC* system. In addition, the transmission level of the high band (the band of interest here) of the *Z6NC* system can be increased to about 1.5 nepers for operation between two terminals; an additional reserve is thus available for lines greatly affected by noise.

When the crosstalk of adjacent line circuits is considered, a difference should be made between compressed and normal speech, and between speech expanded and not expanded in the receiving system. Typical cases can thus be derived as described in the legend of Figure 12.

Figure 12 is a comparison of crosstalk between

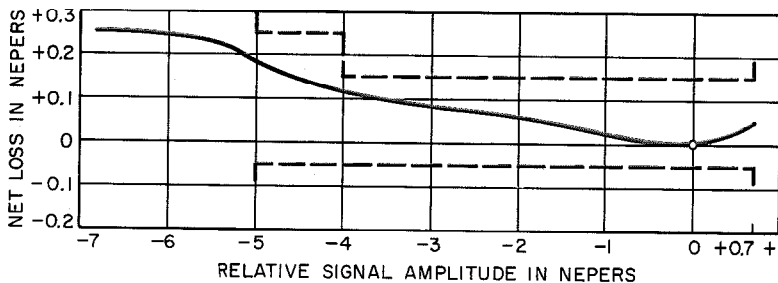


Figure 8—Compressor amplitude dependence. Dashed lines give the tolerance.

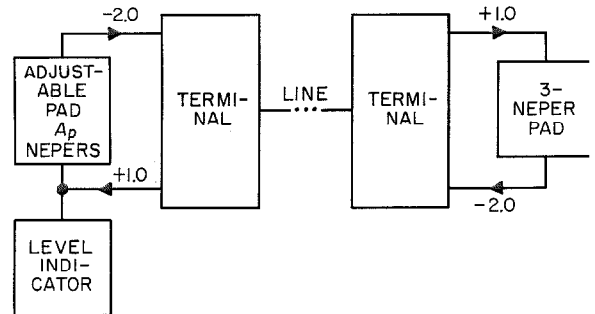
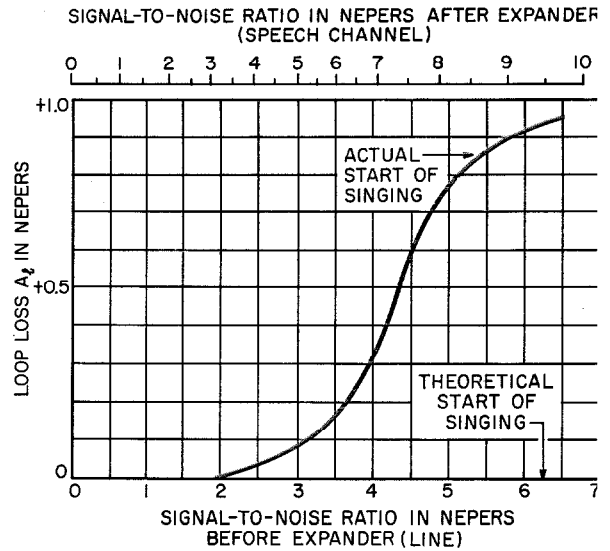


Figure 9—Loop loss as a function of noise level. Input and output levels in nepers are shown on the block diagram: Loop loss,  $A_i = 3 - A_p$  nepers.

the *Z6NC* and some other well-known systems. Better intelligibility of compressed speech involves an increase in crosstalk attenuation  $A_c$ . For this effect (which depends on the degree of compression) various values (0.57 to 0.8 neper) are shown<sup>6,7</sup> in the literature. Subjective ob-

<sup>6</sup> F. S. Boxall and R. S. Caruthers, "Miniature Compressor for General Use in Wire and Radio Communication Systems," *Transactions of the American Institute of Electrical Engineers*, volume 72, part 1, pages 804-811; January, 1954.

<sup>7</sup> A. J. Aikens and C. S. Thaler, "Control of Noise and Crosstalk on N1 Carrier Systems," *Transactions of the American Institute of Electrical Engineers*, volume 72, part 1, pages 605-610; January, 1954.

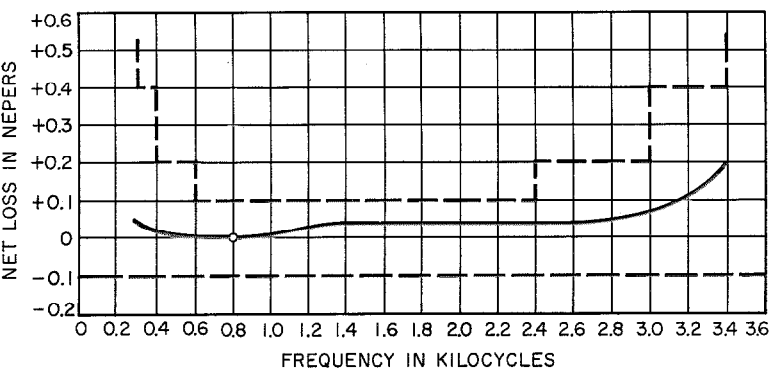


Figure 10—Net loss as a function of voice modulation frequency. The upper dashed line is the 40-percent tolerance of the Comité Consultatif International Téléphonique.

servation of German talkers has shown that  $A_c$  with compressed speech must be higher by about 0.6 neper to create the same crosstalk sensation as with uncompressed (normal) speech; this value was taken as the basis for the representations in Figure 12.

## 5.2 SIGNAL TRANSMISSION

As is the case in many of the newer<sup>4</sup> carrier-frequency systems, the Z6NC system transmits

|  | Z6NC<br><i>m</i> = 40 Percent   | Z12N (Z6N)                                  | Z12K  | Z6NT<br><i>m</i> = 50 Percent   |
|--|---|---|---|---|
| Signal and Noise Level on Line in 3100-Cycle Bandwidth |   |   |   |   |
| $A_c$<br>Signal-to-Noise Ratio for Background Noise    | $A_c = (-1.1 + 0.7)$ $- (A + 0.6)$ $- (P_n + 0.35) + g$ $= (-P_n - A)$ $- 1.35 + g$ $= (-P_n - A) + 1.25$ | $A_c = 0.8 - A - P_n$ $= (-P_n - A) + 0.8$  | $A_c = +0.5 - A - P_n$ $= (-P_n - A) + 0.5$ | $A_c = (-0.4 + 0.7)$ $- (A + 0.6)$ $- (P_n + 0.35)$ $= (-P_n - A) - 0.65$ |
|  | $A_c = K_1$   | $A_c = K_1 - 0.45$                          | $A_c = K_1 - 0.75$                          | $A_c = K_1 - 1.9$   |
| $A_i$<br>Signal-to-Noise Ratio for Interfering Signals | $A_i = (-1.1 + 0.7)$ $- (A + 0.6) - P_i + g$ $= (-P_i - A)$ $- 1.0 + g$ $= (-P_i - A) + 1.6$              | $A_i = +0.8 - A - P_i$ $= (-P_i - A) + 0.8$ | $A_i = +0.5 - A - P_i$ $= (-P_i - A) + 0.5$ | $A_i = (-0.4 + 0.7)$ $- (A + 0.6) - P_i$ $= (-P_i - A) - 0.3$             |
|  | $A_i = K_2$   | $A_i = K_2 - 0.8$                           | $A_i = K_2 - 1.1$                           | $A_i = K_2 - 1.9$   |

Figure 11—Effective ratio  $A_c$  of signal to line noise and to interfering signals for the most unfavorable channels of 4 carrier systems operated over equal line lengths. For equal signal level and equal noise level at the systems outputs.  $m$  = percentage of modulation.  $P_i$  is an interfering signal;  $P_n$  is the background noise level. For Z12N, Z6N, Z12K, transmission loss =  $A$  (108 kilocycles). For Z6NC and Z6NT, transmission loss =  $A + 0.6$  (120 kilocycles) all figures are in nepers. Expander gain  $g = 2.6$  nepers.

Figures 12A and 12B—Above and on the facing page are shown a crosstalk-ratio comparison between Z6NC and other systems. Crosstalk attenuation  $A_c$  figures in the table are given in nepers. The relative zero level for each system is  $S_0$ . In the sketch of compander operation at the left, normal speech in range  $a$  is of normal intelligibility; in range  $b$ , normal speech gives poorer-than-normal intelligibility. Compressed speech in range  $a$  gives better-than-normal intelligibility and gives normal intelligibility in range  $b$ .

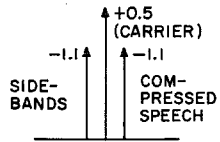
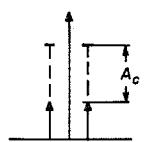
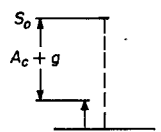
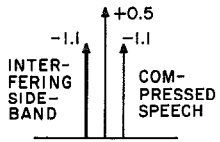
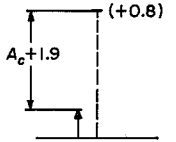
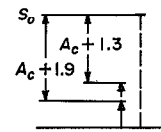
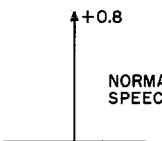
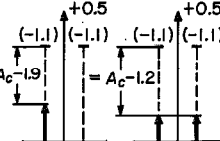
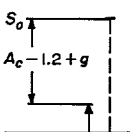
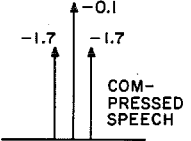
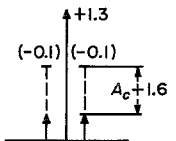
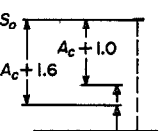
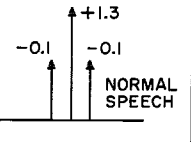
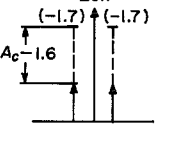
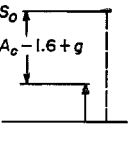
|   | CARRIER AND SIDE-BAND LEVEL OF TRANSMITTING SYSTEM  | CARRIER AND SIDE-BAND LEVEL OF RECEIVING SYSTEM CARRIER-FREQUENCY SIDE  | SIGNAL AND NOISE LEVELS OF RECEIVING SYSTEM OUTPUT  | REMARKS   |
|---|---|---|---|---|
| A | Z6NC ( $m=40$ PERCENT)<br>   | Z6NC<br>                     | Z6NC<br>   | In range $a$ , Crosstalk audible as compressed speech<br>In range $b$ , Crosstalk audible as normal speech  |
| B | Z6NC ( $m=40$ PERCENT)<br>   | Z12N<br>                     | Z12N<br>   | 1. Due to the better intelligibility of compressed speech, $A_c$ decreases subjectively about 0.6 neper<br>2. Same ratios apply to Z6N<br>3. Z12K with +0.5 neper carrier and Z6NC with reduced carrier (+0.2 neper) give same values |
| C | Z12N<br>                   | Z6NC<br>                   | Z6NC<br> | 1. With expander gain of 2.6 nepers, effective $A_c$ rises 1.4 nepers (compare $S_0$ for case B)<br>2. Same ratios apply to Z6N<br>3. Also for Z12K with +0.5 neper carrier and for Z6NC with -0.2 neper carrier                      |
| D | Z6NC ( $m=40$ PERCENT)<br> | Z6NT ( $m=50$ PERCENT)<br> | Z6NT<br> | 1. Due to better intelligibility (0.6 neper), effective $A_c$ rises 1.0 neper<br>2. Z6NT with higher carrier (1.3 nepers) and Z6NC with lower carrier (-0.1 neper)  |
| E | Z6NT ( $m=50$ PERCENT)<br> | Z6NC<br>                   | Z6NC<br> | 1. Z6NT with higher carrier (1.3 nepers) and Z6NC with lower carrier (-0.1 neper)<br>In range $a$ , Crosstalk audible as normal speech<br>In range $b$ , Crosstalk audible as expanded speech   |

Figure 12A.

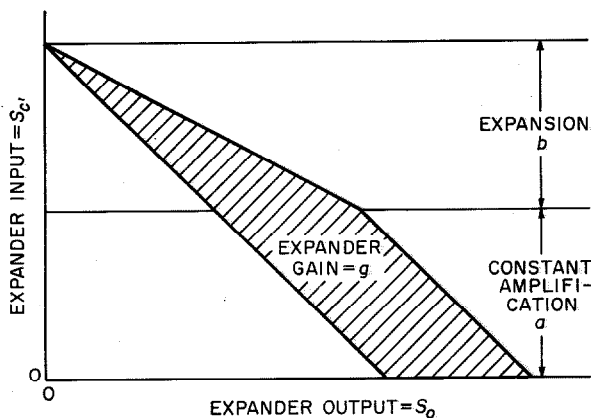


Figure 12B.

dialing signals and metering pulses during conversation through a special path in each speech channel. In signal transmission of this type, the delay time of the signals should be very short and signal distortion must be kept within certain limits. Loud speech or disturbances such as whistles must not generate undesired signal pulses. Noise in the speech channels during signal transmission must be below a definite limit.

In the system under discussion, the frequency of 3.7 kilocycles has been selected as the best compromise for out-of-band signal transmission. The requirements of negligible signal noise in speech channels, shortest signal delay times, and least signal distortion contradict each other; any rounding-off of the transmitted signal pulses for noise considerations will lengthen the delay time. The noise-suppressing effect of the expander requires only limited rounding of the pulses; this results in very-short delay times (less than 12 milliseconds). The driving current in the signaling relay is to all practical purposes independent of attenuation variations on the toll line, these variations being reduced by a factor of 12 by the channel amplifier. For instance, when the attenuation of the toll line varies by  $\pm 1$  neper, the signal distortion remains within  $\pm 1$  millisecond with a signal pulse frequency of 50/50 or 20/20 milliseconds on/off ratio.

Contact chatter of the signal relay is prevented by a special circuit causing an increase of relay current at the proper instant.

Spurious pulses caused by loud speech or

whistling can be avoided with proper attenuation characteristics of the speech-channel low-pass and the signal-receiver band-pass filters. In the case of the Z6NC system, the specifications for these filters could be relaxed because the speech levels are reduced by a ratio of about 2 by the compressor. The curve for speech immunity (Figure 13) shows that in the most-unfavorable case a level of 1.9 nepers above relative zero level will cause a spurious signal pulse, but only in a very-narrow range of 3450 to 3550 cycles.

Dialing noise in adjacent channels with signal pulses of 50/50- or 20/20-milliseconds duration is below 0.5 millivolt measured at the system output; this is equivalent to a signal-to-noise ratio of 8.3 nepers. When the signal-modulator input is grounded, the continuous tone audible in the related channel is at least 7 nepers down; measured by a psophometer, it is 8.2 nepers down.

### 5.3 LEVEL REGULATION

#### 5.3.1 Gain-Controlled Channel Amplifier

The gain-controlled amplifier of the channel balances attenuation variations in carrier-frequency transmission by regulating the carrier level. Figure 14 shows the basic circuit of the amplifier. The feedback to the amplifier is varied by the direct plate current  $I_p$  flowing through

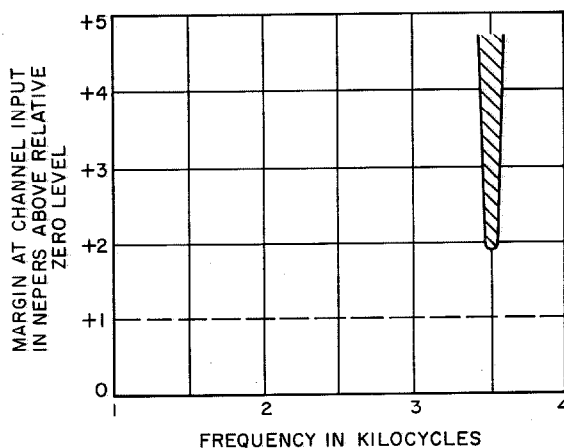


Figure 13—Speech immunity of signaling path for a channel. Shaded area is the operating region of the signal receiver; the dashed line is the specified limit. Speech immunity is the overload level applied to a speech channel at an arbitrary frequency that just fails to generate a spurious signal pulse.

a thermistor in a bridge connection. A regenerative sample of the signal in the amplifier output circuit is applied across the bridge and, depending on the bridge state of balance, a portion appears at the amplifier input in series

this type and the variation of plate direct current are shown in Figure 15.

### 5.3.2 Gain-Controlled Group Amplifier

The channel regulation will balance all attenuation variations occurring when the system is operated over cables. Additional variations that may be expected, for instance, on open wire lines, are compensated by additional regulation in the group amplifier. A thermistor is again used<sup>4</sup> as shown in Figure 16. When thermistor *A* is suitably preheated, a temperature-change-compensated regulation characteristic as shown in Figure 17 is obtained.

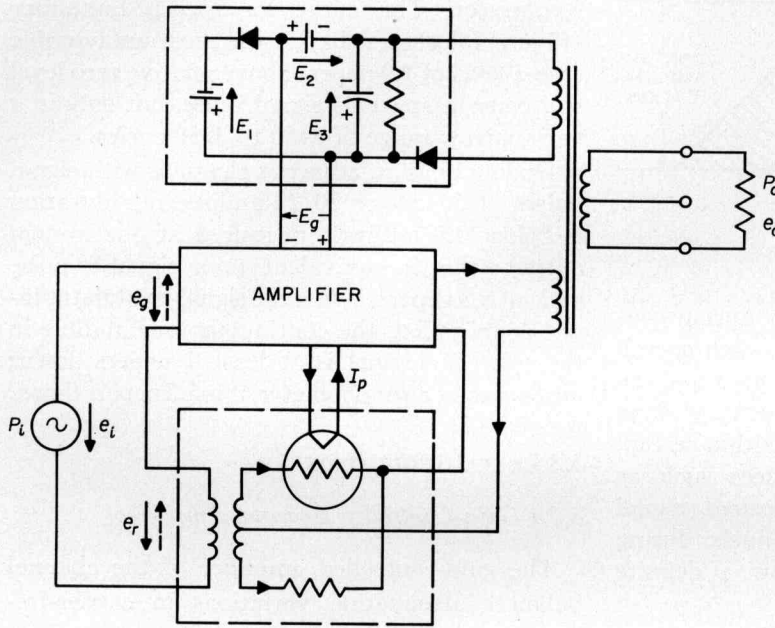


Figure 14—Variable-gain channel amplifier. Before start of control,  $E_g = -E_1$  and control starts when  $E_1 + E_2 = E_3$ .

with input signal,  $e_i$ , as  $e_g$ . When the input level is small, the balance of the bridge is such that a regenerative voltage  $e_r$  appears at the amplifier input, the amplifier grid bias  $E_g$  being equal to  $E_1$  and the plate current at maximum. When, with increasing input and consequently higher output voltages,  $E_3$  reaches and exceeds the sum of  $E_1$  and  $E_2$ , regulation begins. Grid bias  $E_g$ , when further increased, causes the plate direct current to drop and, hence, the thermistor resistance to increase. This increasing resistance changes feedback voltage  $e_r$  in the sense of increasing negative feedback. The regulation characteristic of an amplifier of

The controlled-gain group amplifier then has gain  $GA$  and, as will be readily seen, the output levels of all channels are the same (only

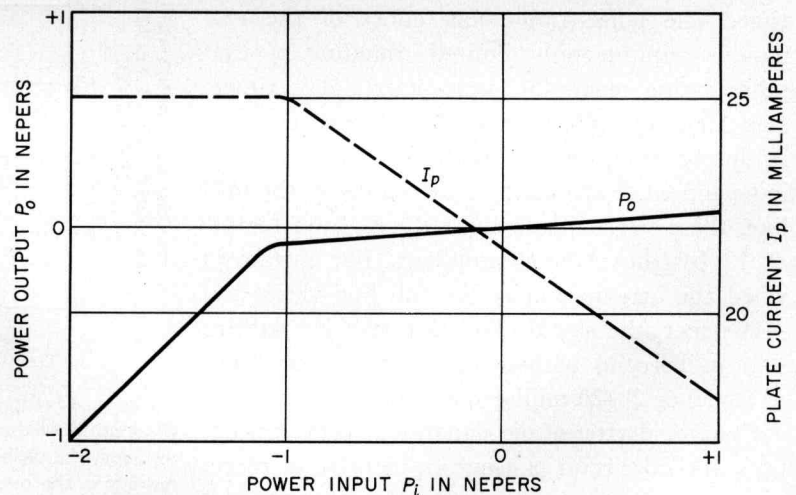


Figure 15—Characteristics of variable-gain channel amplifier.



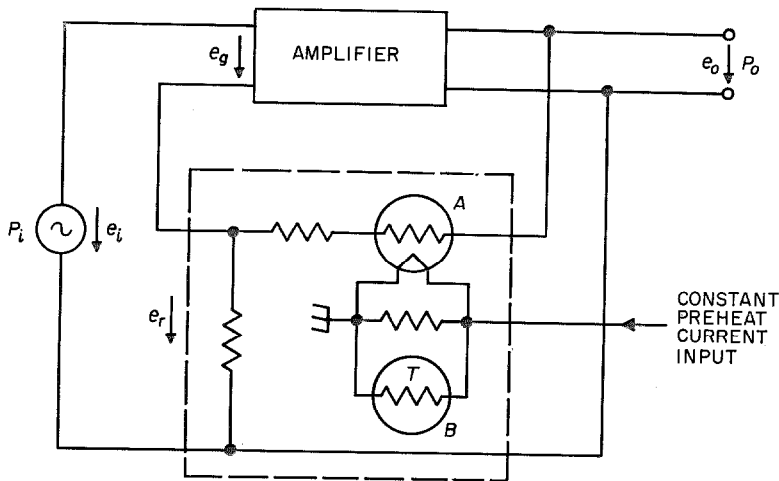
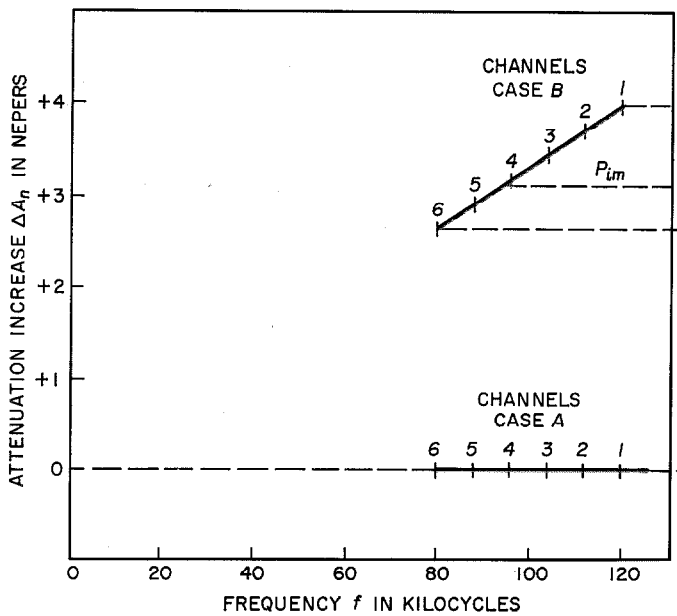
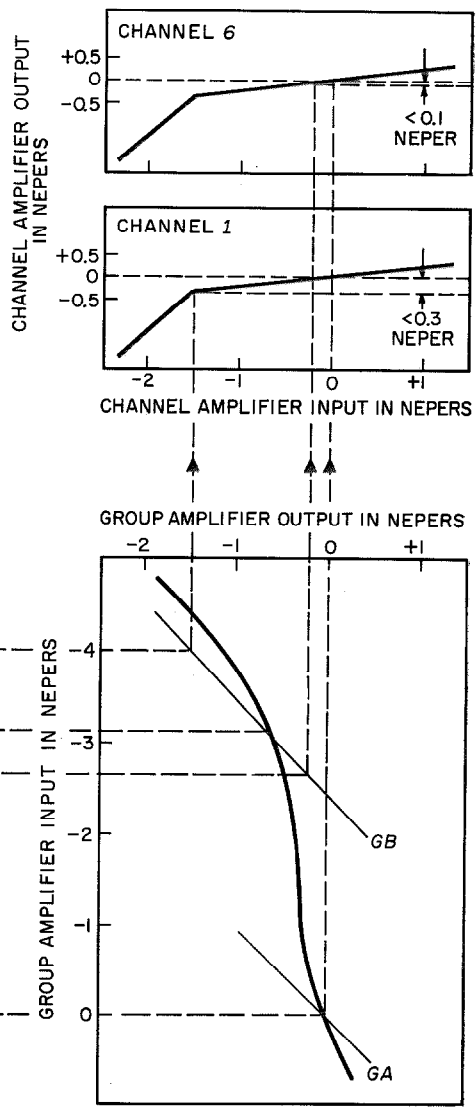


Figure 16—Basic circuit of controlled-gain group amplifier. Thermistor *A* determines the control characteristic and *B* the temperature balance. Amplification  $G = (e_o/e_i) \sim (e_o/e_r)$ .

Figure 17—Interaction of channel and group regulation. In the event of fair weather (case *A*), inputs to and outputs from group and channel amplifiers are the same for all 6 channels; the channel amplifier outputs are all  $P_{om}$ . In case *B* (foul weather), an increase in attenuation  $\Delta A_n$  of 4 nepers at 120 kilocycles with a slope down to about 2.6 nepers at 80 kilocycles. The gain  $GB$  of the group amplifier in this case is determined by the median  $P_{im}$  of the levels of the 6 channels. As shown at the upper right, the equalization and regulation maintain the channel-amplifier output within 0.3 neper of the desired value.

channels 1 and 6 are shown).

Whenever weather conditions cause the open-wire-line attenuation to increase, carrier levels of different magnitudes corresponding to unequal attenuation increases appear at the group amplifier input. The limiting case *B* is shown in Figure 17. The gain of the group amplifier is determined by the sum of the powers of all carriers appearing at its input.



The regulation characteristic shows the dependence of output level on input level referred to one channel. Hence, the gain  $GB$  of case  $B$  is determined by the median level  $P_{im}$ . It will be seen from the diagram that the output levels of individual channel amplifiers barely change despite a large decrease of carrier level on the line. The level difference in channel 6 is under 0.1 neper; in channel 3, about 0.3 neper.

### 5.3.4 Levels with Regulated Repeaters

Figure 17 refers to operation on open wire lines between terminals. When repeaters are employed having controlled gain exactly like that of the terminal gain-controlled group amplifier, the effect of group frequency translation must be taken into account.

Figure 18 shows the conditions existing when open-wire-line operation includes two repeaters.

The minimum (fair-weather) line attenuation is compensated by the repeater and receiving-terminal preamplifiers. The levels shown at various points of transmission direction  $B$ -to- $A$  refer to an attenuation in each line section of 4 nepers at 120 kilocycles. It will be seen that the original carrier level is restored after passing through two repeaters. The conditions for the  $A$ -to- $B$  direction are analogous. The conditions prevailing in terminal  $A$  are described by the levels shown in Figure 17, case  $B$ .

Irrespective of attenuation conditions in individual sections of the open wire line, variations are always compensated as long as the levels in the last line section do not exceed the limiting case  $B$  of Figure 17.

In open-wire-line operation, the system behavior is of particular interest when rapid attenuation changes occur. Figure 19 shows some typical cases. An interesting feature is the fact

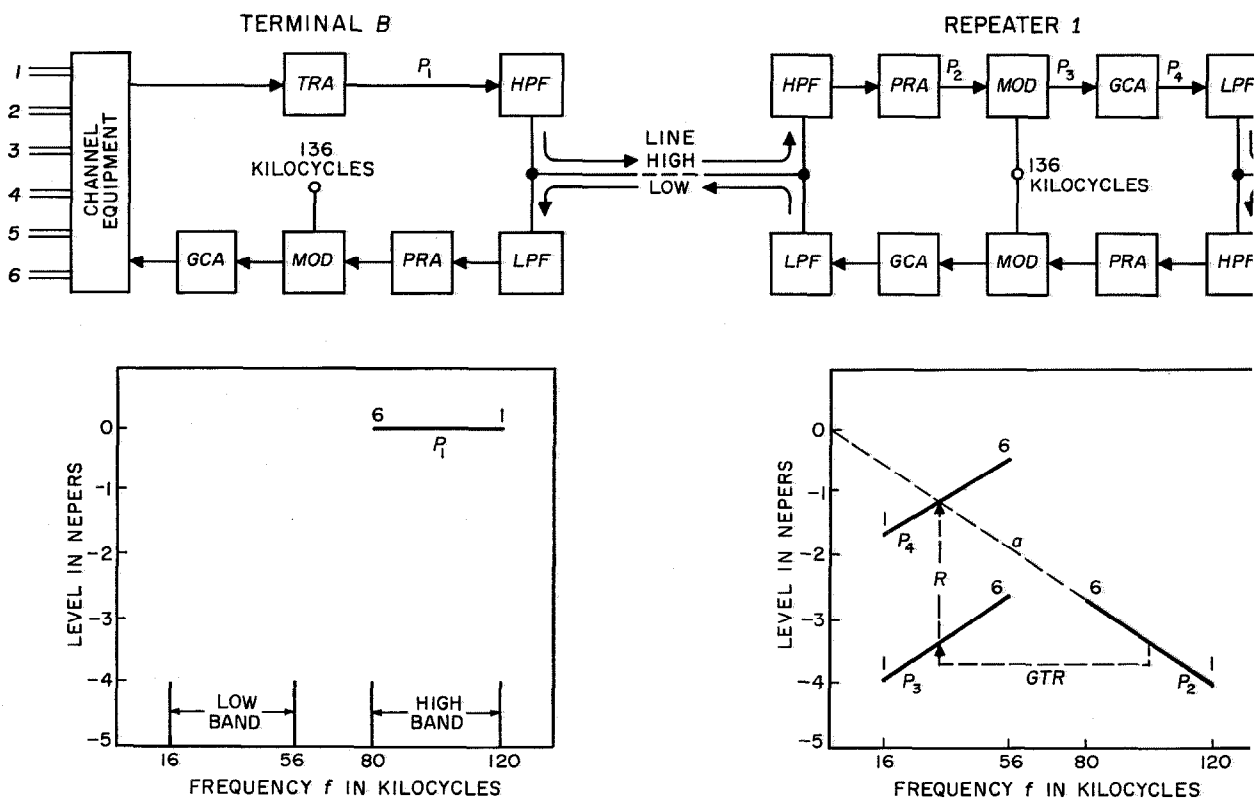


Figure 18—Level conditions with gain-controlled repeaters and group translation over open wire lines. The frequency characteristics of the line under fair-weather conditions are compensated by pads that are adjusted when the equipment is first installed but the poor-weather

line-attenuation variations must be compensated by gain-controlled amplifiers in the repeaters and the receiving-terminal equipment.

In the graphs, a line attenuation versus frequency increase  $a$  having a slope of 4 nepers at 120 kilocycles under

that the process of regulation is relatively slow when attenuation increases but regulation is fast when attenuation decreases. This behavior is caused by the thermistors in the negative-feedback paths of the amplifiers.

### 6. Transmission Properties

The *Z6NC* system was developed assuming that with normal operational conditions and a line length of 100 kilometers (three sections with two repeaters), a noise power of 0.002 microwatt at reference level in a channel will be exceeded with a temporal probability of only 1 percent. The noise power was apportioned as follows.

0.001 microwatt for noise through crosstalk couplings.

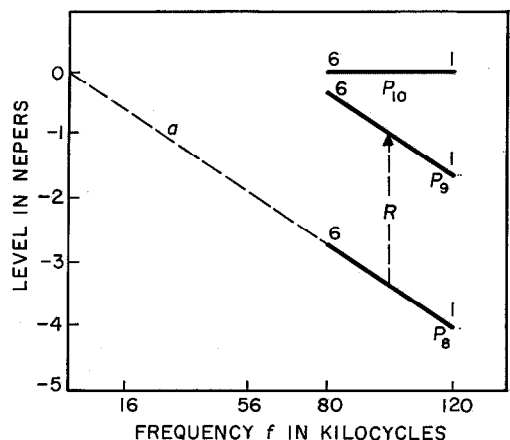
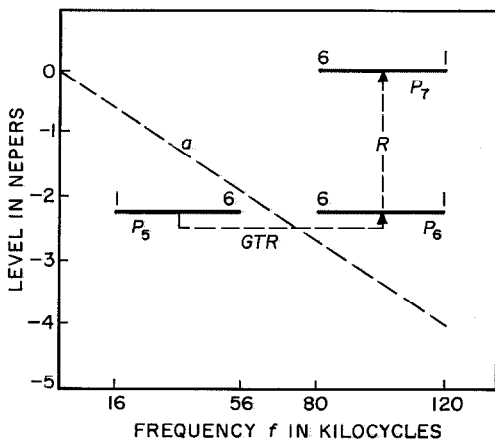
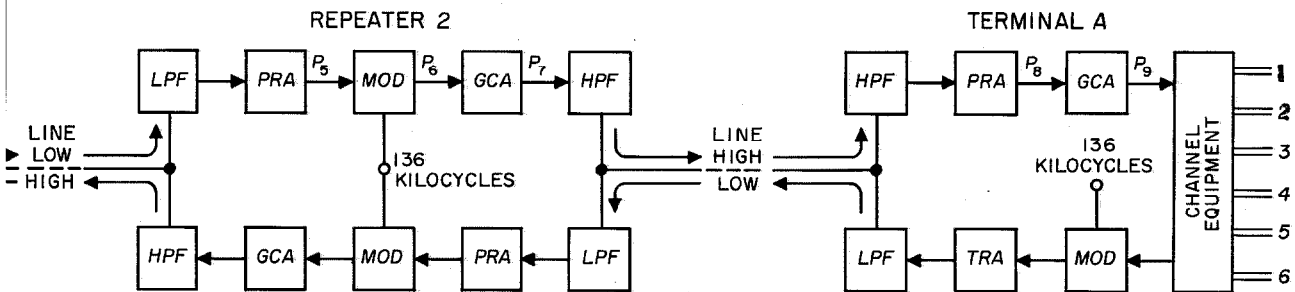
0.001 microwatt for background noise and nonlinear distortions, including here, 500 picowatts for nonlinear distortion in the transmitting and receiving circuits of a terminal.

The most-essential data of the compandor system listed below are in accordance with recommendations of the Comité Consultatif International Téléphonique.

#### 6.1 TRANSMISSION OVER CABLES

##### 6.1.1 Voice-Frequency Specifications

|  |   |
|--|---|
| Transmitted band                           | 0.3 to 3.4 kilocycles   |
| Net loss tolerance, effective median value | ≤ 20 percent of Comité Consultatif International Téléphonique specification |



poor-weather conditions is assumed. The compensation between  $P_9$  and channel outputs  $P_{10}$  is accomplished in the channel receiving amplifier.

*TRA* = transmitting amplifier, *GCA* = gain-controlled amplifier, *MOD* = modulator, *PRA* = preamplifier, *HPF*

= high-pass filter, *LPF* = low-pass filter, and *GTR* = group-frequency translation and inversion between high and low bands. The compensating range of the gain-controlled amplifiers is indicated by *R*.

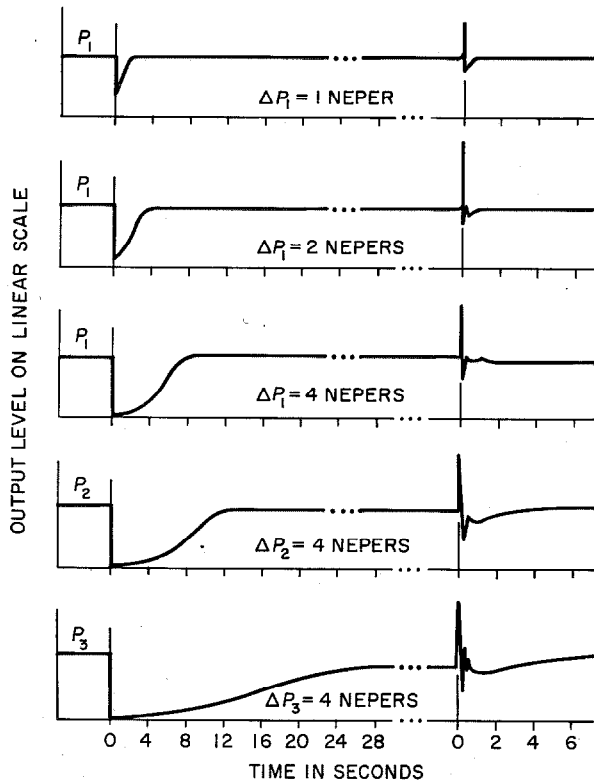
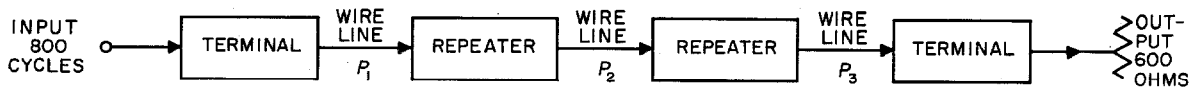


Figure 19—Response of level-regulating system to sudden increase in attenuation at various points in the line followed by a sudden return of attenuation to original value.

Total harmonic distortion at 800 cycles  
 With expected level < 3 percent  
 With level increased by 0.7 neper < 6 percent  
 With level increased by 1.4 neper < 15 percent

Signal-to-intelligible-crosstalk ratio > 8.5 nepers

Signal-to-unintelligible-crosstalk ratio (buzzer tone of zero relative level imposed on any two channels) > 8 nepers

Signal-to-background-noise ratio > 8 nepers

Noise voltage in any other channel when one channel is overloaded by a 1.4-neper-level signal keyed at 50-milliseconds on, 50-milliseconds off < 1.2 millivolts\*

Noise voltage in any other channel when one channel receives periodic voltage peaks of 60 volts at relative zero level (discharge of 2-microfarad capacitor through 600 ohms) < 1.2 millivolts\*

\* Measured at a point having a +1.0-neper relative level.

### 6.1.2 Signal Transmission

|   |  |
|---|--|
| Signal delay time   | <12 milliseconds                         |
| Signal distortion with line attenuation variations of $\pm 1$ neper                             | < $\pm 1$ millisecond                    |
| Speech immunity   |  |
| Maximum overload level not generating spurious signal   | $\leq 1.9$ nepers at relative zero level |
| Noise in adjacent channels with signal transmission of 50/50 or 20/20 milliseconds on/off ratio | <0.5 millivolts*                         |
| Noise voltage of continuous signal tone in the related channel                                  | <0.6 millivolts*                         |

### 6.1.3 Carrier-Frequency System

|   |  |
|---|--|
| Carrier transmitter level   | +0.5 neper (adjustable in steps of 0.1 neper to $\pm 0.3$ neper) |
| Carrier transmitter level in <i>B</i> terminal can be switched to | +1.5 nepers  |
| Depth of modulation on toll line (for rated level)                | 35 to 45 percent   |

### Attenuation

|                   |                                     |
|-------------------|-------------------------------------|
| Between terminals | 0 to 9.3 nepers (at 124 kilocycles) |
| With repeaters    | 0 to 8.3 nepers (at 124 kilocycles) |

Transmission range with deloaded toll cable (1.4-millimeter copper core or 1.8-millimeter aluminum core)

|                   |               |
|-------------------|---------------|
| Between terminals | 37 kilometers |
| With repeaters    | 33 kilometers |

### 6.2 TRANSMISSION OVER OPEN WIRE LINE

The transmission properties quoted for cable circuits are also applicable to the case of open wire lines except that the values for crosstalk are somewhat less favorable; however, this is unimportant when compared with the greater effects of noise on open wire lines.

The limits for automatic level correction due to attenuation variations are given by the conditions existing in the last section of the open wire line in the direction of transmission:

|   |             |
|---|-------------|
| Maximum increase of attenuation   | 4 nepers    |
| Maximum slope in the transmission band, for carrier-frequency levels at 120/80 and 56/16 kilocycles | 1.35 nepers |

The above transmission properties are maintained at ambient room temperatures of 10 to 35 degrees centigrade and 80 percent humidity. However, the equipment still operates satisfactorily in the range of 0 to 40 degrees centigrade.

## Award For Planar-Grid Disc-Seal Triode

THE BRITISH Royal Commission on Awards to Inventors has made a joint *ex gratia* award of the sum of £2500 for the invention of the planar-grid disc-seal triode to E. H. Ullrich of Standard Telephones and Cables Limited and his coinventors J. Foster, C. N. Smyth, and S. G. Tomlin, also of that company at the time of the invention.

The first disclosure, as far as is known, of a tube of this type took place in April 1941 when Standard Telephones and Cables Limited demonstrated to the British Admiralty a 600-megacycle-per-second radar echo amplifier incorporating a CV16 tube, fully engineered for production to the inventors' design, that reduced the noise factor of the best receivers then known by 9

decibels and produced an average increase in service radar range of about 35 percent at that frequency. The tube was designed for grounded-grid operation with the electrodes so disposed as to form parts of coaxial-line circuits. Experimental oscillator tubes made at that time on the same principles but with suitable modifications operated near 2700 megacycles; that is, at a frequency about four times as high as had previously been achieved with triodes.

The planar-grid disc-seal triode has been further refined by numerous workers and today is used the world over for both amplification and oscillation in the ultra- and super-high-frequency bands.

---

## Fundamental Principles of Transistors

DR. J. EVANS of Standard Telecommunications Laboratories, Enfield, has recently published a book entitled "Fundamental Principles of Transistors." It is divided into 11 chapters, 3 appendixes, and a bibliography covering the following subjects.

Chapter 1—Introduction  
Chapter 2—Basic Theory of Semiconductors  
Chapter 3—Measurement of Semiconductor Parameters  
Chapter 4—The P-N Junction: Theory  
Chapter 5—The P-N Junction: Method of Preparation  
Chapter 6—Junction Transistors  
Chapter 7—Point-Contact Transistors

Chapter 8—Measurement of Transistor Parameters  
Chapter 9—Manufacture of Transistors  
Chapter 10—Special Types of Transistors  
Chapter 11—Silicon and Other Transistor Materials  
Appendix 1—Teaching Transistor Physics  
Appendix 2—Parameters of Some Commercial Transistors  
Appendix 3—Identification of Mixed Impurities

The book is  $5\frac{3}{4}$  by  $8\frac{3}{4}$  inches (15 by 22 centimeters) and contains 255 pages and 140 figures. It is available from Heywood and Company, Limited, of 9 Kingsway, London, W.C.2, at 45 shillings. The book can also be obtained from D. Van Nostrand Company, 120 Alexander Street, Princeton, New Jersey, at \$6.75 per copy.



# Tricon, an Electric-Diagram Interlock System for Railroad Switching\*

By WILHELM SCHMITZ

*C. Lorenz A.G. (now Standard Elektrik Lorenz A.G.); Stuttgart, Germany*

**D**IAGRAMMATIC interlock control systems for the operation of railroad track switches have been employed in Germany for the past decade and are designated *Dr* by the Deutsche Bundesbahn (German railroads). This designation refers to the push-button keys arranged within the diagram. The outstanding characteristic of such systems is the increasing use of electric relays. While such devices were used in the former lever-interlock systems, they depended chiefly on mechanical interlocking and couplings between lever parts, like snap switches and armature stops of switch-point levers. The conversion from mechanical to electric interconnections has introduced a remarkable degree of freedom in the arrangement of operating keys, which can now be mounted directly in a track diagram. The utilization of small uniform push-button keys permits a substantial reduction in the size of the control desks.

ing, and maintaining such interlock systems had to be considered. The obvious necessity of locating trouble and repairing it quickly and of being able to modify and expand installations without interrupting service suggested the subdivision of the interlock system into uniform assemblies of commonly used components with corresponding relay sets. This plan was very effective for the relatively simple tasks like the setting of switchpoints or signals. The combining of several of these actions to form a routing, however, was hardly possible with the standardized components because every railroad switch-tower has its own peculiar structural and its operational conditions. A mixed construction has resulted in which the greater part consists of standard relay sets and the smaller part is planned and constructed for the individual interlock tower. This so-called "individual wiring" still occupies 30 to 40 percent of the total circuit

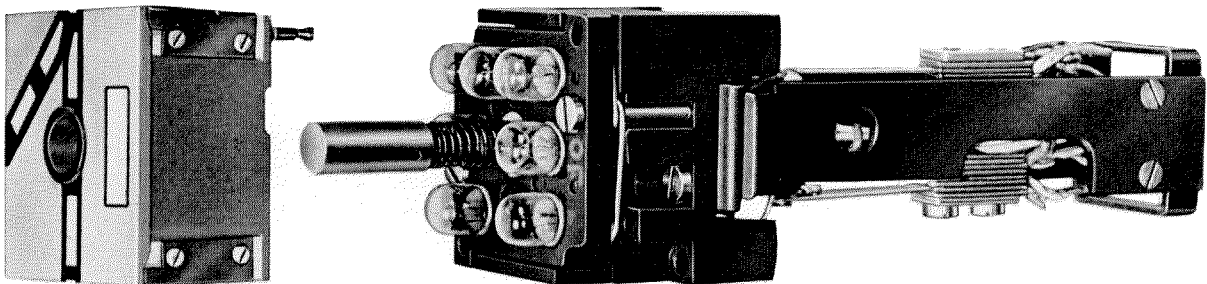


Figure 1—Track-diagram element with its cover removed. The operating push button is in the center and its contacts are in the shank of the structure. Identifying colors and graphical symbols are provided by the cover and are not affected by changing a burned-out lamp.

On the other hand, the number of relays and switching circuits is increased considerably, which is to be expected.

The design of such an electrical system required not only means of economically manufacturing the extensive circuit components, but the practical requirements of planning, inspect-

diagram. The new relay-operated interlock system makes use of a circuit in which the switching action for routing also is standardized. This system has the designation *Sp Dr* in the terminology of the German railroads, while the trade name is Tricon.

## 1. Track-Diagram Desk

The push-button keys for the operation of the interlock system are mounted in an illuminated

\* Presented at a meeting of the German Railroad Engineers Society in Stuttgart on May 16, 1955. Reprinted from *Der Eisenbahningenieur*, volume 6, number 9; September, 1955.

model track diagram. To facilitate factory production and subsequent modification of any track diagram, the diagram is composed of elements not unlike the tiles in a mosaic. The elements are squares with 35-millimeter (1.38-

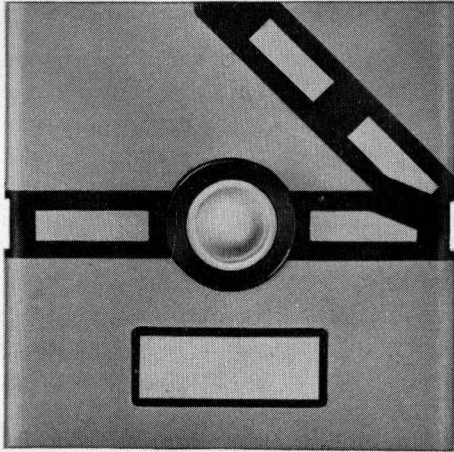


Figure 2—Top view of the cover for a single switch element. The track for which the switch is set is indicated by illumination of the corresponding graphical symbol. The identification of the switch appears in the rectangular nameplate.

inch) sides and consist of a small chassis mounting 9 electric lamps or 8 lamps with a push button mounted in the center. This chassis is screwed to longitudinal bars.

The top or cover of each mosaic element is a sheet of Plexiglas, the bottom surface of which is painted to show the desired graphical symbol of a switchpoint, signal, et cetera, illuminated as desired by electric lamps mounted in the chassis. Erroneous interchanging of colors is prevented by the use of clear glass bulbs, the colors being applied to Plexiglas caps attached to the cover. When the cover is replaced, every bulb is covered by a cap of the required color.

Figure 1 shows one of these mosaic elements with its cover removed. In Figure 2, the symbol of a switchpoint may be seen in greater detail. In the center is the push button and below it is a number plate that can be illuminated. Corresponding to each track section of the switch element are two small illuminated panels. The illumination of these two panels indicates the position of the switchpoint. While the points are being switched, a flashing light is visible on the panel corresponding to the new switch position. Occupancy of a track section by a train will be detected by insulated sections of track and will cause a red light to show in the corresponding track panels. The number plate shows a red flashing light when the switch is trailed. These mosaic elements are available with all types of symbols, such as derailleurs, signals, lines, and line blocks. They differ only in the symbols

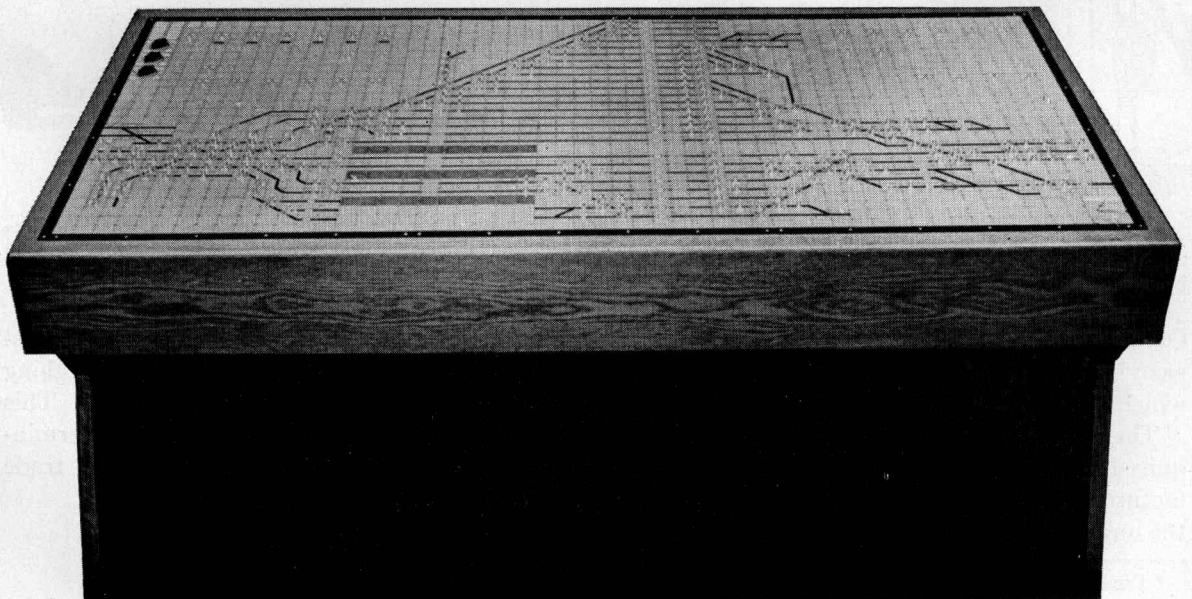


Figure 3—Typical track-diagram control desk consisting of 1512 mosaic elements.

painted on the Plexiglas covers and in the complement of lamps and colored caps.

These mosaic elements can be used to assemble track diagrams of the most diverse railroad switchtowers. Figure 3 shows a track-diagram control desk for a tower with 109 switchpoints. The number of elements making up the total picture is  $28 \times 54 = 1512$ , of which 385 have

single switches. Based on the *N-X* principle, in the electrical routing arrangement, the pressing of any push button will make conductive every path from it through which a train can pass and will open all electrical circuits to tracks over which a train cannot pass.

The most-common operating system of a push-button diagram desk is the *N-X* system. In it,

the operating is done by pressing two buttons, one on the entrance side and the other on the exit side of the route that is to be set. In Figure 4, the route from track 4 East to track 1 West will be set by the operation of push buttons 4 East and 1 West. As shown in Figure 4A, the path finding begins at the exit point. Originating on a contact of push-button 1 West, the pathfinding comes then to switch A where it finds two possible paths, one to switch B and the other to track 1 East. Since the reverse (turn-out) path of switch B is taken, the normal (straight) way that could not be traversed by a train is cut away. In switch C it goes two ways, to track 2 East and switch D, and so on. The pathfinding ends with access to all four East tracks. Since at the exit, push-button 4 is operated, the pathfinding will be reflected electrically from this point as shown in Figure 4B. At switch E, the normal way to track 3 East, will be cut away, similarly in switch C to track 2 East, and so on. The reflecting pathfinding ends at the originating point 1 West. This produces an

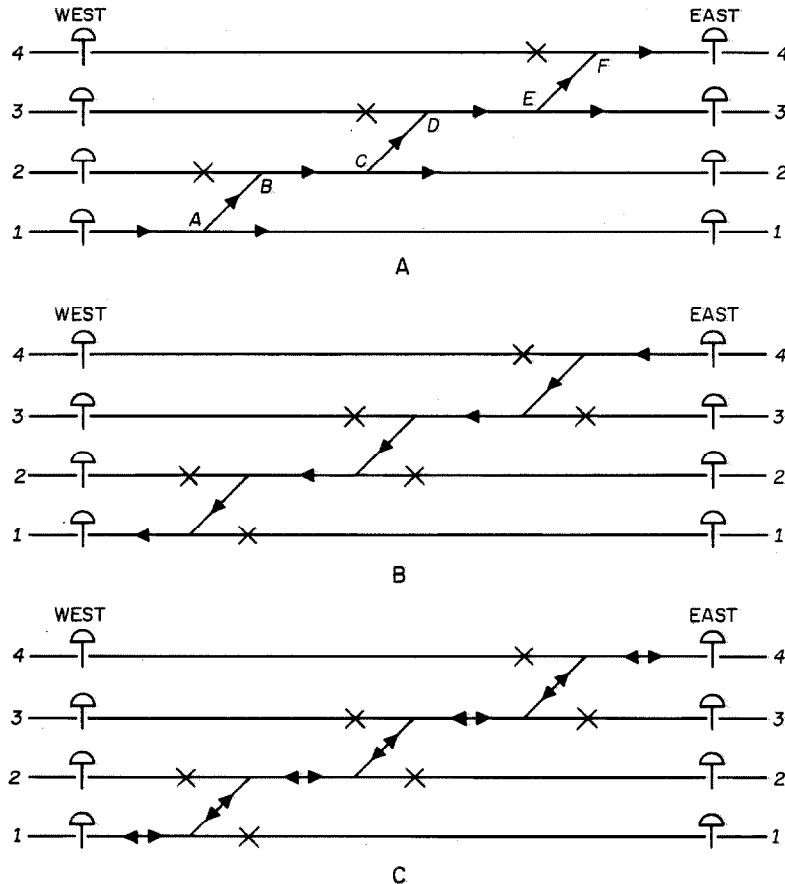


Figure 4—Arrangement of tracks and switches to illustrate route selection by pressing a push button at each end of the system. At A, the routes permitted are indicated by arrows and those prohibited are marked by crosses when pushbutton 1 WEST is operated. B is for depressing 4 EAST and C is the resultant of both being operated.

electrical connections. The diagram is 1890 millimeters (74 inches) long and 980 millimeters (38 inches) wide.

## 2. Routing

Figure 4 will demonstrate the principles of determining a route between two ends of a trackage system. It represents 4 tracks and 6

electrical channel between the entrance and the exit point, as shown in Figure 4C. Now it is not difficult to set the switches and signals as needed over this electrical channel.

## 3. Shunting Route

A shunting route will serve as an example of the operation of the system. As is well-known,

the difference between shunting and through routes is that for shunting, only the track switches over which the train will pass need be set and locked before the clear signal can be set; while for the through route, it is necessary to set switches and safety switches and to detect the entire line before the signal shows *clear*. To ensure greatest flexibility of the interlock system and to be able to release the separate route sections quickly, each switch is released as soon as its detector track is unoccupied. That means that the system retains a temporary switching route for the shortest necessary time, making the trackage available for other uses without delay.

Figure 5 shows a simple track diagram with control push buttons and shunting signals. Below the track diagram, the operating desk is seen. Below the latter are the corresponding sets of relays; that is, for 4 switches and 4 shunting signals. The sequence of operations of the relay sets are diagrammed in the 8 columns underneath the corresponding switches and signals. To set a shunting movement from the *stop* condition of signal *2B* to the shunting signal *1C*, the signalman depresses the push buttons of these two signals in the desk, thus energizing the associated relays in the relay sets of signals *2B* and *1B*. It should be noted that the signal relay in relay set *1B* is energized although push button *1C* is depressed. It is necessary that an impulse be released in the relay sets associated with the points of the route switches; the two ends of this route can be controlled only by these two relays.

Now the process of routing begins. Each switch relay set has three *KS* relays. The *KS±* relay is set if the current comes from the points of the switch, *KS+* if from the normal of the switch, and *KS-* if from the reverse side of the switch. For the example under consideration, the *KS±* relay is energized in the relay set of switch 4. As the pulse comes from the switchpoint, a train might travel along the straight track or over the shunt or turnout route. From the point of the switch, the pulse is transmitted along the main line to switch 1, where relay *KS+* is energized to signify that only the straight route may be traversed as a train cannot be shunted from the reverse side of the switch. The pulse then goes to the relay set of shunting signal *1A* where a route control relay *KC* is energized. Also from the point of switch 4, a connection to the siding of

switch 3 is made where *KS-* is energized, allowing only the reverse route to be taken. *KS+* of switch 2 will be energized, and finally route control relay *KC* in relay set *2B* is operated. Since the push-button relay *KSR1* is already energized here, another relay *KDI* is operated, determining the directional setting at this end; later this shunting signal is set to *clear*.

Now the process called echo is initiated. Switches 2 and 3 are taken facing the points and relays *KS±* are each put in the energized condition. At switch 4, only the siding may be traversed, *KS-* blocking the main line to signal *1A* previously permitted. The echo reaches its end by energizing relay *KC* in the relay set of signal *1B*. The latter causes the directional-setting relay *KDO* to indicate that the route ends here, that is, that the shunting signal *1B*, must not be set to *clear*. Moreover, the indicator lamp is lighted in the number plate of shunting signal *1C*, informing the signalman that the desired route is electrically formed.

Now the signalman releases the push buttons so that the push-button relays are released. This causes a pulse to be transmitted from switch to switch along the channel formed by the *KS* relays, reversing or controlling the switch position relays *KP* so that they assume the position determined by the *KS* relays. If necessary, the switchpoints are controlled by the *KP* relays. When in the correct positions, all switches are locked by route locking relays *KL*. The *KL* relay next to signal relay set *1B* connects into the circuit route release relay *KR*, which is used later for the release of the route. Checking the stop signal of the shunting signal *1B*, the switch positions, and the switch locking, a current impulse is now transmitted through all switches to the shunting signal-setting relay *KIS* in the signal relay set *2B*, which sets the shunting signal to *clear*.

The ensuing events, beginning with the shunting movement, are represented by Figure 6. As soon as the train in the shunting movement enters the detector track section of switch 2, the associated track relay *KT* drops. When the shunting movement advances to include switch 3 also, this track relay is also reversed. Switch 2 is then freed as the train has passed beyond it. The track relay of switch 2 is set to the *clear* position. This causes relay *KR* in the signal relay

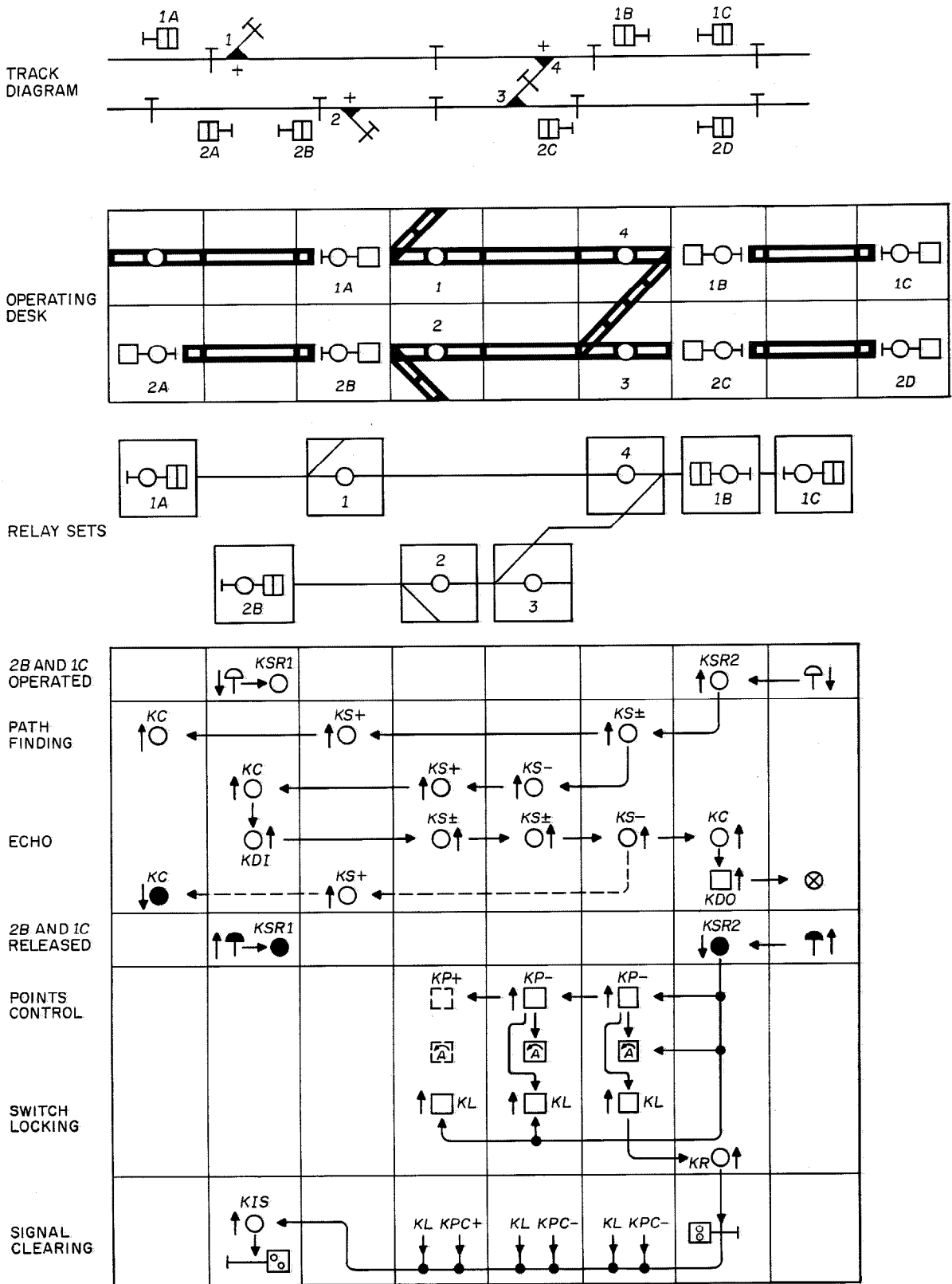


Figure 5—Track diagram, operating desk, relay sets, and sequence chart of operation to set up a shunting track connection from 2B to 1C. The symbols are identified in the appendix, section 7.

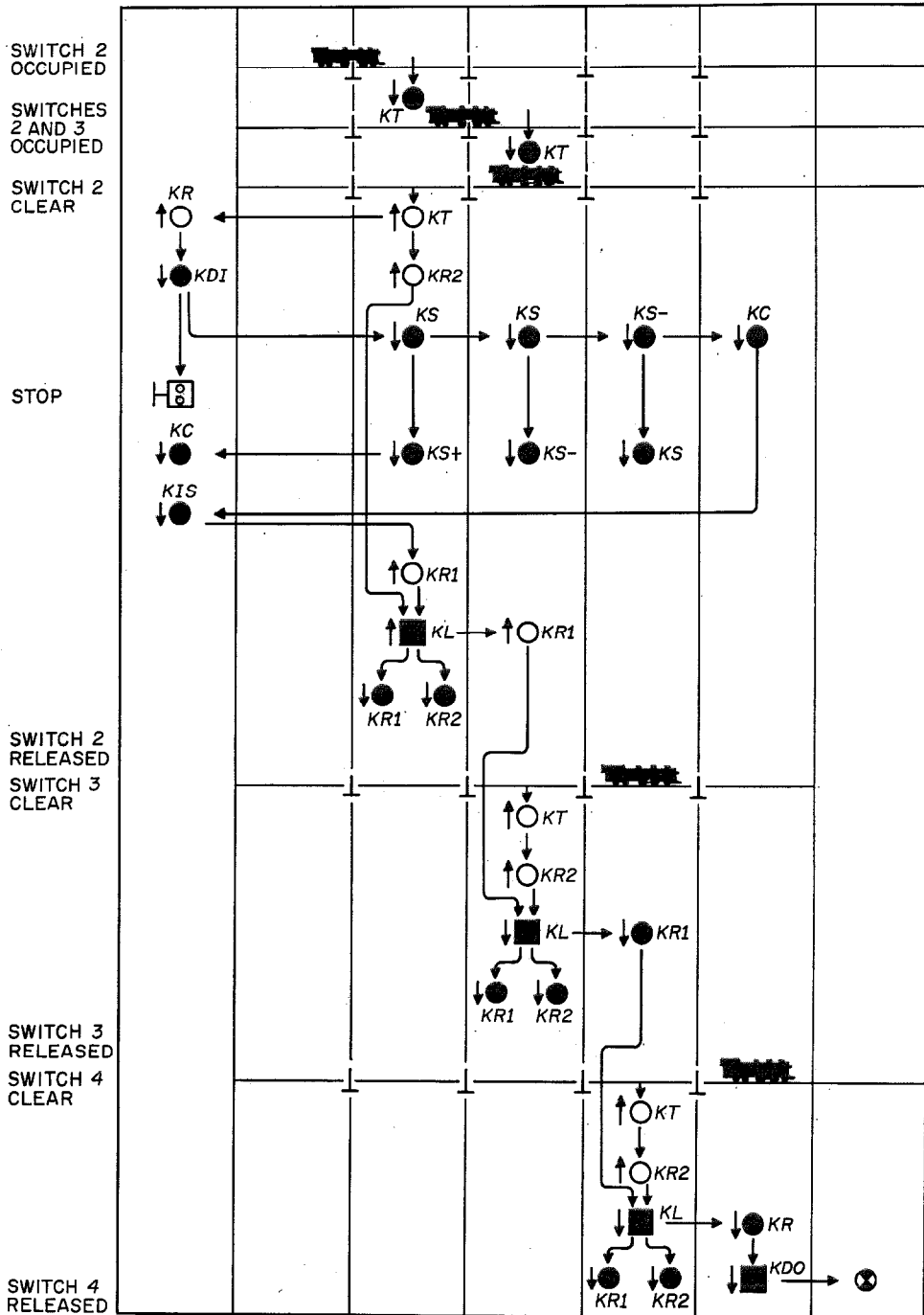
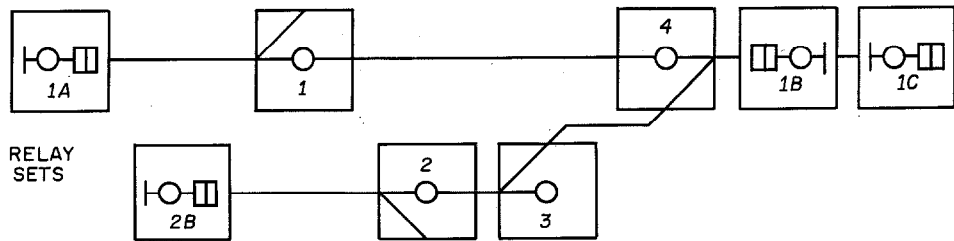


Figure 6—Release of switching elements after train has traversed the shunting route of Figure 5.

set *2B* to be energized together with relay *KR2* in the switch relay set. Relay *KDI* in the signal relay set drops, the signal thus again assuming the *stop* position. Moreover, *KDI* releases sequentially the chain of *KS* relays for the switches,

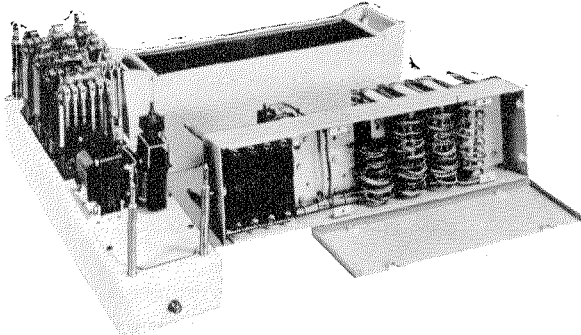


Figure 7—Typical relay arrangement.

which release the *KC* relays in both signal relay sets, and relay *KIS* drops back to its original position. This causes relay *KR1* of switch *2* to be operated. Both relays *KR1* and *KR2* reverse the position of holding relay *KL*, which disconnects relays *KR1* and *KR2* and energizes relay *KR1* of switch *3*. When the train in the shunting movement runs over the detector track circuit of switch *4*, its track relay is set for the occupied condition. As soon as the detector track section of switch *3* is freed, this switch is released in the same way as described before. The same process repeats itself when the detector track section of switch *4* is freed; through reversal of the switch locking relay, relays *KR* in the signal relay set of the route end as well as relay *KDO* is released to normal

position so that the key indicator lamp of the route-end or exit push button is switched off.

It will be clear now that the switching operation proceeds from one relay set to the next set on the track diagram without any connections needed among relay sets that are not adjacent to each other on the track diagram. The same procedure is also used for through movements, in which cases it is supplemented by flank protection and clear-route detection.

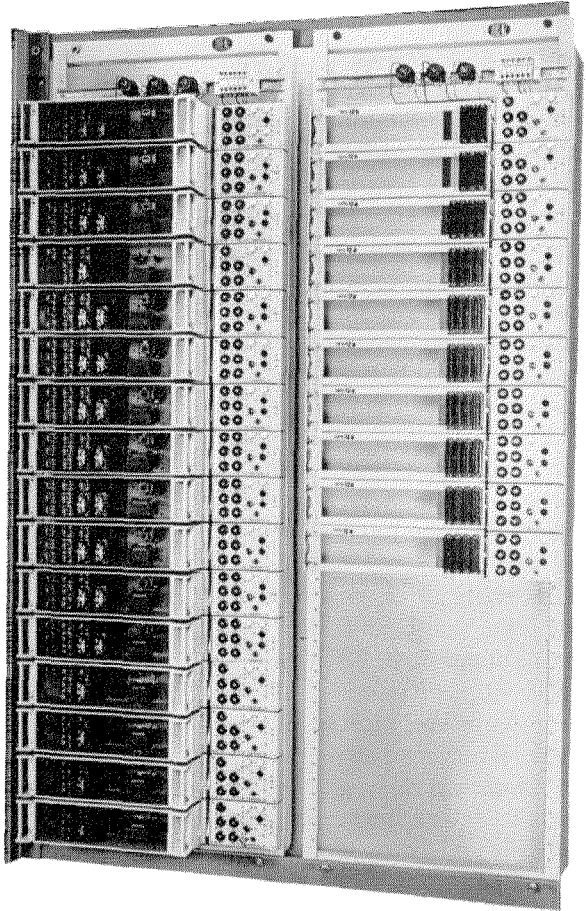


Figure 9—Relay rack with fuses and signal lamps at the right.

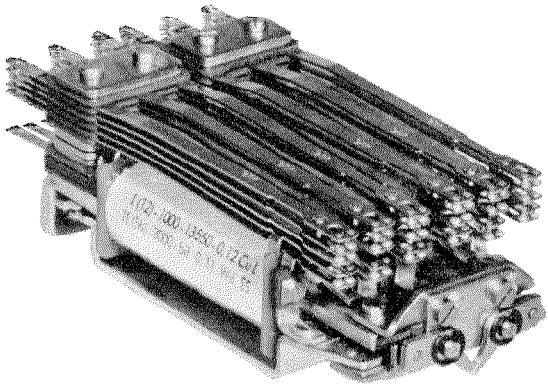


Figure 8—Interlocking type of relay pairs.

**4. Constructional Details**

The relays are mounted on panels, the connections to which are made through terminal strips. Figure 7 shows a set of relays that are mounted with other switching components on a chassis. At the rear are the wiring and the terminal strips. The wiring is covered by the plate visible in front of the chassis at the right.



Behind this chassis is the protecting hood with a Plexiglas window. A relay set of the same type is shown to the left.

Interlocked relays are shown in Figure 8. They consist of two relays, the armatures of which are mechanically coupled by locking pawls. The release of either armature will provide mechanical support for the operation of the other armature.

A complete relay rack is shown in Figure 9, the relays having been removed from the right half of the rack. To the right of each relay set is a switchboard mounting fuses and lamps according to special requirements for that particular relay set. The lamps indicate the same operating states as are indicated at the control desk and include one lamp each for normal control, reverse control, switch occupancy, and switch locking.

Figure 10 is a schematic circuit diagram for two track switches. The track-switch symbols at the top correspond to two associated relay sets, each with three connections for the point and the two paths of a switch. Each switch relay set is connected to a corresponding mosaic element of the control desk. Every two switch relay sets are connected to a common relay set connected to two insulated rails to detect the presence of a train that would provide an electric circuit across the rails. Cables lead from these relay sets to the insulated rails and to the switch machines. The designation of this interlock system, TRICON, is derived from the TRIPLE CONNECTION of the switch relay set that makes it suitable for any track diagram. It should be noted that a route in its outmoded sense is no longer in existence and that no route relay set is needed. Each relay set for switches, signals, et cetera, comprises all components required for a route. Each switch, as long as it has its own detector track circuit, is released separately and is equipped with all circuit components that are required. For instance, each

switch has its own arrangements for flank protection, regardless of whether they are needed or not.

### 5. Outdoor Equipment

The signal lights used are of the standard type employed by the German railroads.

The tracks circuits are supplied with alternating current of 220 volts. The voltage is

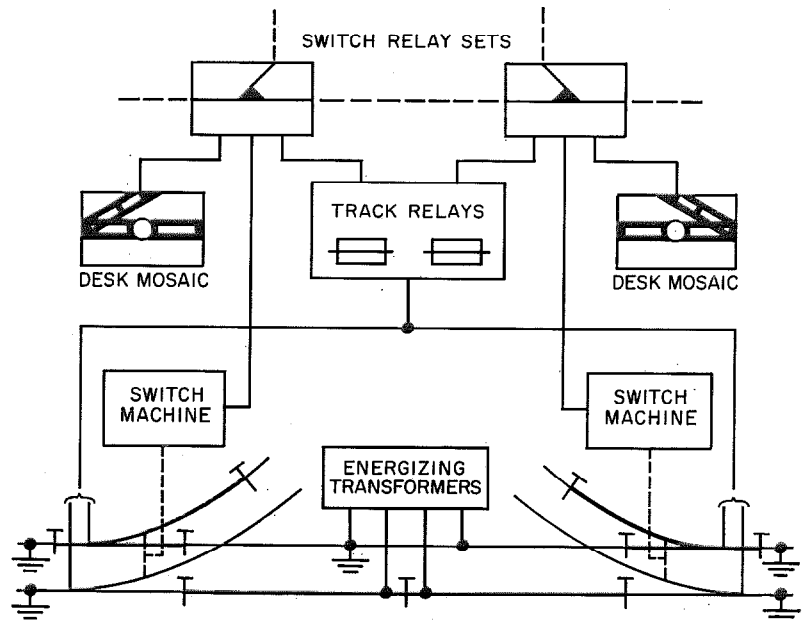


Figure 10—Schematic arrangement of switching system. Heavy lines indicate insulated sections of track, all others being grounded.

stepped down by a transformer at the supply end and stepped up in the interlock tower at the relay end, where it is applied to the grid of a vacuum tube to control two relays alternately. If the normal-clear relay is operated and the occupancy relay is released, it indicates that the track circuit is not occupied. If, on the other hand, the normal-clear relay is released and the occupancy relay operated, the track circuit is occupied. If both relays are operated or released simultaneously, this indicates trouble.

A new type of switch machine is shown in Figure 11. Through a coupling, the motor drives a speed-reducing pair of gears having a worm gear on the output shaft. The worm gear engages a toothed segment that operates an arm below the housing of the drive. This arm is coupled via rodding to the track switch. The control contacts



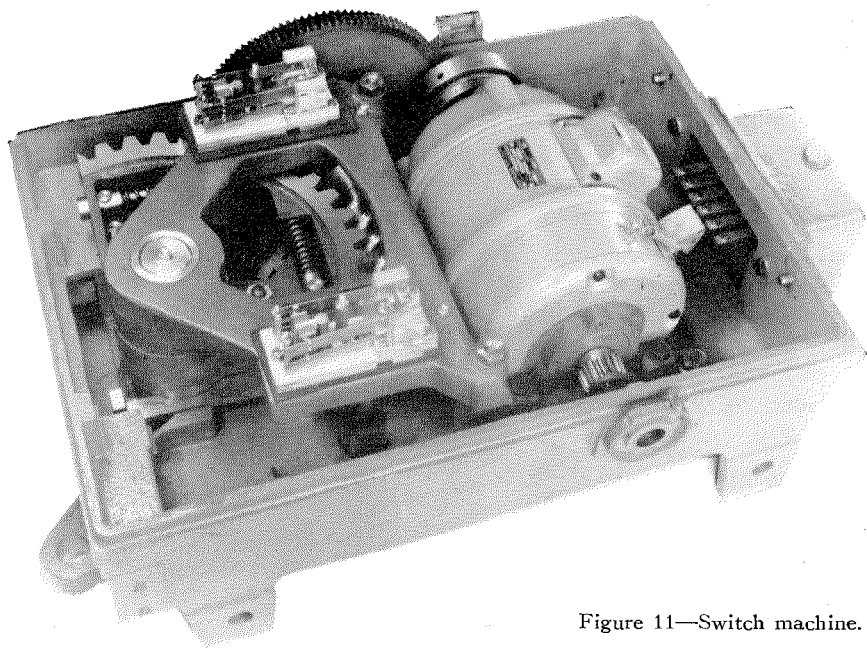


Figure 11—Switch machine.

The greatest advantage, however, will become apparent when interlock systems in operation have to be enlarged at a later date. If, for instance, a new switch with a siding is to be added in a route of switchpoints already in existence, the new siding being provided for through traffic also, then only the connection between the existing adjacent switch relay sets need be broken to insert a new factory-wired relay set together with a signal relay

are mounted on a large casting that supports the main bearing of the drive. The point-detector slides are mounted in the drive housing to the left. A circular opening visible in the front side of the case permits the insertion of a cranking handle acting on the motor shaft through a pinion gear. When the handle is inserted, the machine is electrically disconnected by a lever.

### 6. Advantages of Tricon

Except for the wiring diagrams for the relay sets, no other diagrams are needed at the interlock towers. The wiring is totally standardized. This enables data for orders to be processed in the workshop much sooner than for custom designs. In manufacture, there is a noteworthy advantage in the omission of individual wiring for single-interlock towers, which previously made up a considerable portion of the work. The mounting is greatly simplified. Since the connections between relay sets have to be wired rather schematically according to the track diagram, they are soldered to prenumbered cables on the construction site.

Particular advantages have been noted in the process of inspecting and placing a completed interlock system in service. A new testing method is being developed for the system.

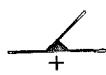
set for the departure signal; these two sets are then connected by indoor cables according to the track diagram, and the new switchpoint is automatically connected to all routes. The new signal is properly inserted with respect to all existing switch relay sets, including the blocking of all conflicting routes.

Even if the circuit investment is in some cases greater than for other systems, in which switches do not serve as protecting switches, this interlock system offers so many advantages that the slightly greater investment is easily outweighed. This system will enable railroads to complete the construction of interlock towers promptly and will accelerate the movement of rolling stock.

### 7. Appendix

The graphical symbols used in the drawings and the sequence-diagram symbols are defined in this section. It is supposed that readers of *Electrical Communication* may not be familiar with railway symbols.









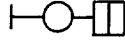

#### 7.1 GRAPHICAL SYMBOLS










Track switch normally set for straight normal route.



Track switch normally set for reverse route.

|   |   |   |  |
|---|---|---|--|
|  | Insulated rail joint to detect presence of car.   |  | Shunting signal lamps displaying red and white signals, respectively.            |
|  | Signal post.  |  | Switch machine. Arrow indicates operation to reverse position.                   |
|  | Sign for shunting signal.   |  | Direction of circuit action or of traffic.                                       |
|  | Push button.  |  | Direction of initiated operation. Actuation of relay or release of push button.  |
|  | Signal post, push button for the shunting signal, and signal sign. Push button may be operated as the entrance or exit point for setting up a shunting route. |  | Direction of initiated operation. Release of relay or depression of push button. |

## 7.2 SEQUENCE-DIAGRAM SYMBOLS

|  |   |   |  |
|--|---|---|--|
|   | Push buttons in open- and closed-circuit conditions, respectively.    |  | Condition of relay to control track switch for straight route.   |
|   | Push-button indicator lamps, dark and illuminated, respectively.      |  | Condition of relay to control track switch for reverse position route.   |
|   | Relays in up and down conditions, respectively.                       |  | Relay to control track switch for either straight or turnout route. This relay operates if the route search approaches a track switch from its point side. |
|  | Interlocked relays in released and operated conditions, respectively. |   |  |

# Loss Formulas for Homogeneous Gradings of the Second Order in Telephone Switching Employing Random Hunting

By JAKOB KRUTHOF

*Bell Telephone Manufacturing Company; Antwerp, Belgium*

PROBABILITIES for the occurrence of specific traffic patterns and consequently the equation stating the grade of service rendered by a certain grading arrangement can in principle be established by the application of the well-known theory advanced by Erlang. This theory of the so-called "statistical equilibrium" is based on the fact that for random traffic the various probabilities for the occurrence of specific traffic patterns do not depend on time. It leads to a system of equations of the type

$$(sy + c) p[c] = \sum y f(c) p[c - 1] + \sum F(c) p[c + 1] \quad (1)$$

where

$y$  = average traffic offered to each split of the grading

$s$  = number of multiple splits

$c$  = number of calls in progress

$p[c]$  = probability of occurrence of a certain call pattern comprising  $c$  calls

$p[c - 1]$  = probability of occurrence of derived patterns having one call fewer

$p[c + 1]$  = probability of occurrence of derived call patterns having one more call

$f(c)$ ,  $F(c)$  = numerical functions of  $c$ , depending on the type of grading chosen and the mode of hunting, but independent of  $y$ .

The application of this method to the computation of the expressions for the different probabilities appears to be a laborious task, especially for gradings of appreciable size as the equations rapidly reach a great number.

Since it was demonstrated by extensive and systematic tests with the rotary traffic machine<sup>1</sup>

<sup>1</sup>J. Kruthof, "Rotary Traffic Machine," *Electrical Communication*, volume 23, pages 192-211; June, 1946.

that gradings based on outlets connected to the same number of splits in a cyclic manner rendered improved efficiency, and since it has been shown in practice that such gradings are less sensitive to an unbalanced load, they have aroused increasing interest both on the part of the telephone administrations and the manufacturers of switching equipment.

These gradings, which we termed "homogeneous gradings," have become of great interest compared with gradings of a mixed order, as their efficiency does not depend appreciably on the mode of hunting. With several modern telephone switching systems, the hunting of a selector starts from a random point; with others, the switches are provided with a home position and hunting always commences from the same point from which the outlets are searched in a definite sequential manner.

Tests with the traffic machine have demonstrated that gradings of mixed order have poor efficiency when subjected to random hunting. Such gradings are, therefore, unsuitable for systems using nonhoming switches, while homogeneous gradings are apposite.

This paper deals exclusively with homogeneous gradings of the second order that are composed of complete cyclic arrangements of groups of outlets. It is desirable to develop exact methods that do not require the solving of an extensive system of equations.

Figure 1 is a general illustration of the homogeneous type of grading.

A symmetrically loaded, complete, homogeneous grading of the second order is fully defined by its number of splits and its number of outlets per subgroup. A subgroup includes those outlets that are common to any two specific multiple splits. The number of subgroups, therefore,

amounts to  $\binom{s}{2}$ . Further,

$$N = n \binom{s}{2}$$

$$a = n(s - 1)$$

where

$N$  = total number of outlets to which the grading provides access.

$n$  = number of outlets of one subgroup

$a$  = accessibility or availability, that is, the number of outlets to which the switches of a split provide access.

The accessibility  $a$  is the same for all splits.

The traffic offered to the various splits is assumed equal, as balanced traffic distribution is

the same number of simultaneous calls, the following types of expressions are found.

$$\left. \begin{aligned} P(1) &= (sy) P(o) \\ P(2) &= \frac{(sy)^2}{2!} P(o) \\ &\dots \\ P(a) &= \frac{(sy)^a}{a!} P(o). \end{aligned} \right\} \quad (2A)$$

$$\left. \begin{aligned} P(a+1) &= k_{a+1} \frac{(sy)^{a+1}}{(a+1)!} P(o) \\ P(a+2) &= k_{a+2} \frac{(sy)^{a+2}}{(a+2)!} P(o) \\ &\dots \\ P(N) &= k_N \frac{(sy)^N}{N!} P(o). \end{aligned} \right\} \quad (2B)$$

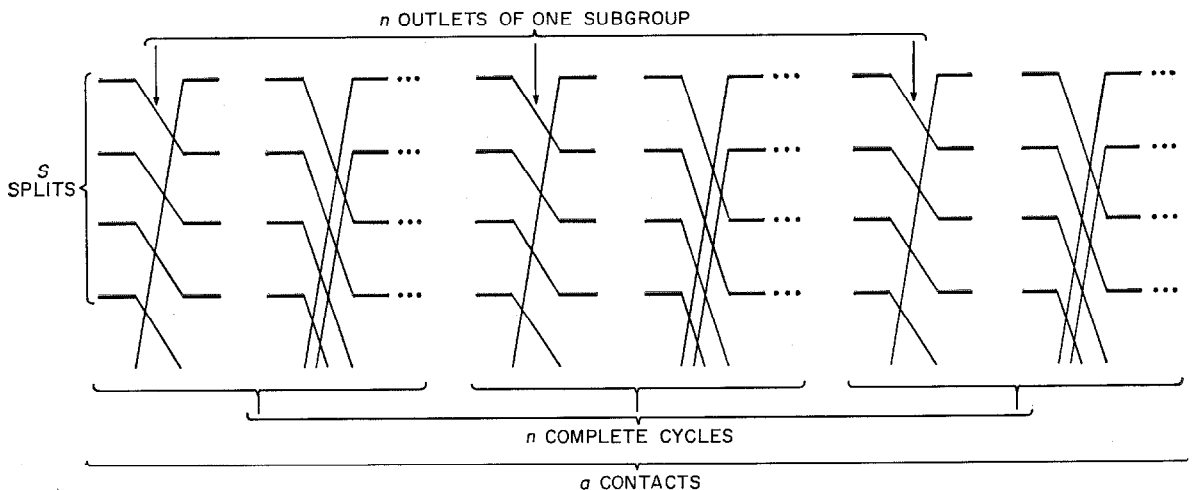


Figure 1—General illustration of homogeneous grading.

a principal aim when planning telephone exchange equipment. Unsymmetrical traffic distribution, although occurring in practice, remains an undesirable exception.

### 1. Examination of Probabilities

The solution of the system of (1) provides expressions for the various individual probabilities  $p$  relating to specific and definite traffic patterns. It appears that each of these can be written as a product of three factors:  $p(o)$ ,  $(sy)^i/i!$ , and a fraction of which both the numerator and the denominator are polynomials in  $y$  and of equal degree.

For the sum  $P$  of the probabilities relating to

That is, after the summation of the  $p$ 's, the sums of the fractional factors appear to be equal to unity for values of  $i \leq a$ , as could be expected. For the probabilities  $P$  for traffic patterns having more than  $a$  simultaneous calls, a coefficient  $k < 1$  remains.<sup>2</sup>

<sup>2</sup> M. Van den Bossche and J. Kruithof, "Some Notes on the Mathematical Treatment of Homogeneous Gradings," Memorandum MSW 83, International Telephone and Telegraph Corporation. In this office memorandum, the writers raise several objections against the mathematical treatment of the grading problem developed in the paper by A. Elldin, "On the Congestion in Gradings with Random Hunting," that appeared in *Ericsson Technics*, number 1; 1955. Section 1 of the present paper repeats their point of view as regards the correct reasons and conditions why and when (1) may be separated into two incompatible systems of equations.

These coefficients  $k$  are similar to those mentioned for the  $p$ 's and consist of a fraction of which both the numerator and the denominator are polynomials in  $y$  and of equal degree. The expressions for these coefficients depend on the type of grading chosen, the mode of hunting, and the traffic offered to the grading.

A few arbitrarily chosen coefficients follow.

In the exact solution of the probabilities  $P(5)$  and  $P(6)$  for a three-split homogeneous grading having two outlets per subgroup ( $s=3, n=2$ ) the coefficients  $k$  include the fraction

$$A = \frac{6561 y^3 + 19\,197 y^2 + 20\,628 y + 7900}{297 y^3 + 871 y^2 + 938 y + 360}$$

where  $y$  is the average traffic offered to each split.

In the exact solution for a four-split homogeneous grading having one outlet per subgroup ( $s=4, n=1$ ), the probability  $P(4)$  of finding any call pattern with four simultaneous calls, includes the coefficient

$$B = \frac{43\,776 y^4 + 128\,784 y^3 + 146\,668 y^2 + 77\,421 y + 16\,080}{46\,848 y^4 + 138\,000 y^3 + 157\,344 y^2 + 83\,136 y + 17\,280}$$

while the coefficients of  $P(5)$  and  $P(6)$  contain the fraction

$$C = \frac{34\,560 y^4 + 101\,520 y^3 + 115\,440 y^2 + 60\,840 y + 12\,615}{46\,848 y^4 + 138\,000 y^3 + 157\,344 y^2 + 83\,136 y + 17\,280}$$

It will be agreed that, even for the above two simple examples of gradings, the coefficients have a somewhat complicated appearance.

Similar coefficients are always found in conjunction with probability problems of limited accessibility. Their values vary between two limits determined<sup>3</sup> by  $y=0$  and  $y=\infty$ .

The coefficients, however, that relate to the homogeneous gradings that are dealt with in this paper show a remarkable property. It appears that the limiting values for the coefficients lie very close together. Table 1 gives the limiting values for the above three fractions.

The difference between the corresponding values of the above two columns appears not to exceed approximately 1 percent. This convergence increases with the values of  $s$  and  $n$  and permits considerable simplification of (1).

<sup>3</sup> H. A. Longley, "Efficiency of Gradings," *Post Office Electrical Engineers Journal*, volume 41; April and July, 1948.

As already stated, the probabilities  $p(c)$  relating to specific traffic patterns having  $c$  simultaneous calls consists of a factor  $y^c$  and a coefficient similar to those of the  $P$ 's. Consequently (1) includes two types of terms, the one type having  $y^c$  as a factor and the other  $y^{c+1}$ . For  $y=0$ , the terms including  $y^{c+1}$  disappear; and, for  $y=\infty$ , the terms containing  $y^c$  disappear. Thus the following two incompatible systems of recurrent equations<sup>2</sup> are obtained.

$$c p[c] = \sum y f(c) p[c-1], \quad \lim y \rightarrow 0. \quad (3A)$$

$$s y p[c] = \sum F(c) p[c+1], \quad \lim y \rightarrow \infty. \quad (3B)$$

The solution of each of these two systems of equations provide two limiting values for the probabilities  $p$  relating to specific call patterns.

Either system may be used for obtaining a very close approximation of the wanted probabilities.

In the following, use will be made of only the system of equations valid for  $y \rightarrow \infty$  because it

provides more-convenient results and also includes a small safety margin.

For symmetrically loaded homogeneous gradings consisting of twos exclusively, the complete system of equations for (3B) is

$$\begin{aligned} s y p[{}_1c_2, {}_2c_3 \cdots {}_1c_3, {}_2c_4 \cdots] \\ = ({}_1c_2 + 1) p[{}_1c_2 + 1, {}_2c_3 \cdots {}_1c_3, {}_2c_4 \cdots] \\ + ({}_2c_3 + 1) p[{}_1c_2, {}_2c_3 + 1 \cdots {}_1c_3, {}_2c_4 \cdots] \\ + \cdots \end{aligned} \quad (4)$$

The suffixes relate to the splits. Therefore,  ${}_1c_2$  indicates the number of busy outlets of the 1-2

TABLE 1  
LIMITING VALUES OF COEFFICIENTS

| Coefficient | $y=0$   | $y=\infty$ |
|-------------|---------|------------|
| A           | 21.9444 | 22.0909    |
| B           | 0.9304  | 0.9344     |
| C           | 0.7300  | 0.7377     |

subgroup, that is, the number of the outlets common to splits 1 and 2.

The sum of the  $c_j$  for all subgroups is equal to  $c$ .

The number of  $c$ 's appearing in the above equation is equal to the number of subgroups, that is,  $\binom{s}{2}$ .

## 2. General Loss Equation

The lost traffic equals the traffic offered to the grading reduced by the traffic carried by the connected outlets.

$$sy - [P(1) + 2P(2) + 3P(3) + \dots + (N-1)P(N-1) + NP(N)].$$

Introducing the values of (2), there is obtained for the grade of service<sup>2</sup>

$$W = \frac{(1 - k_{a+1}) \frac{(sy)^a}{a!} + (k_{a+1} - k_{a+2}) \frac{(sy)^{a+1}}{(a+1)!} + \dots + k_N \frac{(sy)^N}{N!}}{1 + sy + \frac{(sy)^2}{2!} + \dots + \frac{(sy)^a}{a!} + k_{a+1} \frac{(sy)^{a+1}}{(a+1)!} + \dots + k_N \frac{(sy)^N}{N!}} \quad (5)$$

As a point of later importance, it should be noted that the relation given in (6) exists between the coefficients of the terms appearing in the numerator.

$$n=1$$

$$s=2 \left\{ \frac{(2y)}{1+(2y)} \text{ (Erlang)}. \right.$$

$$s=3 \left\{ \frac{\frac{(3y)^2}{2!} [1+(2y)]}{3 \left[ 1+(3y) + \frac{(3y)^2}{2!} + \frac{2(3y)^3}{3!} \right]} \right.$$

$$s=4 \left\{ \frac{\frac{(4y)^3}{3!} \left[ \sum_0^2 \frac{(3y)^i}{i!} + \frac{2(3y)^3}{3!} \right]}{4 \left[ \sum_0^3 \frac{(4y)^i}{i!} + \frac{57(4y)^4}{61 \cdot 4!} + \frac{45(4y)^5}{61 \cdot 5!} + \frac{45(4y)^6}{122 \cdot 6!} \right]} \right.$$

$$s=5 \left\{ \frac{\frac{(5y)^4}{4!} \left[ \sum_0^3 \frac{(4y)^i}{i!} + \frac{57(4y)^4}{61 \cdot 4!} + \frac{45(4y)^5}{61 \cdot 5!} + \frac{45(4y)^6}{122 \cdot 6!} \right]}{305 \left[ \sum_0^4 \frac{(5y)^i}{i!} + \frac{33268(5y)^5}{33573 \cdot 5!} + \frac{32048(5y)^6}{33573 \cdot 6!} + \frac{29120(5y)^7}{33573 \cdot 7!} + \frac{39424(5y)^8}{55955 \cdot 8!} + \frac{129024(5y)^9}{279775 \cdot 9!} + \frac{258048(5y)^{10}}{1398875 \cdot 10!} \right]} \right.$$

$$(1 - k_{a+1}) + (k_{a+1} - k_{a+2}) + \dots + k_N = 1. \quad (6)$$

The polynomial of the numerator consists of a total of  $(N+1-a) = n \binom{s-1}{2} + 1$  terms; the denominator has  $(N+1) = n \binom{s}{2} + 1$  terms, the first  $(a+1) = n(s-1) + 1$  of which have a coefficient 1.

The number of coefficients amounts to  $(N-a) = n \binom{s-1}{2}$ .

## 3. Loss Equations for a Few Specific Homogeneous Gradings ( $y \rightarrow \infty$ )

Starting from  $s=2$ , that is, an ideal group, we have calculated in accordance with (4) the

equations for the grade of service for a number of cases that employ complete cyclic arrangements. For the  $s=2$  cases, the  $B$  equation of Erlang applies.

$n=2$

$$s=2 \left\{ \frac{(2y)^2}{2!} \right. \quad (\text{Erlang}).$$

$$a=2 \left. \frac{(2y)^2}{1+(2y)+\frac{(2y)^2}{2!}} \right.$$

$$s=3 \left\{ \frac{(3y)^4}{4!} \sum_0^2 \frac{(2y)^i}{i!} \right.$$

$$a=4 \left. \frac{11 \left[ \sum_0^4 \frac{(3y)^i}{i!} + \frac{10}{11} \frac{(3y)^5}{5!} + \frac{20}{33} \frac{(3y)^6}{6!} \right]}{11 \left[ \sum_0^4 \frac{(3y)^i}{i!} + \frac{10}{11} \frac{(3y)^5}{5!} + \frac{20}{33} \frac{(3y)^6}{6!} \right]} \right.$$

$$s=4 \left\{ \frac{(4y)^6}{6!} \left[ \sum_0^4 \frac{(3y)^i}{i!} + \frac{10}{11} \frac{(3y)^5}{5!} + \frac{20}{33} \frac{(3y)^6}{6!} \right] \right.$$

$$a=6 \left. \frac{10\,343 \left[ \sum_0^6 \frac{(4y)^i}{i!} + \frac{10\,311}{10\,343} \frac{(4y)^7}{7!} + \frac{10\,143}{10\,343} \frac{(4y)^8}{8!} + \frac{9\,639}{10\,343} \frac{(4y)^9}{9!} + \frac{8\,505}{10\,343} \frac{(4y)^{10}}{10!} + \frac{25\,515}{41\,372} \frac{(4y)^{11}}{11!} + \frac{25\,515}{82\,744} \frac{(4y)^{12}}{12!} \right]}{32 \left[ \sum_0^6 \frac{(4y)^i}{i!} + \frac{10\,311}{10\,343} \frac{(4y)^7}{7!} + \frac{10\,143}{10\,343} \frac{(4y)^8}{8!} + \frac{9\,639}{10\,343} \frac{(4y)^9}{9!} + \frac{8\,505}{10\,343} \frac{(4y)^{10}}{10!} + \frac{25\,515}{41\,372} \frac{(4y)^{11}}{11!} + \frac{25\,515}{82\,744} \frac{(4y)^{12}}{12!} \right]} \right.$$

$n=3$

$$s=2 \left\{ \frac{(2y)^3}{3!} \right. \quad (\text{Erlang}).$$

$$a=3 \left. \frac{(2y)^3}{1+(2y)+\frac{(2y)^2}{2!}+\frac{(2y)^3}{3!}} \right.$$

$$s=3 \left\{ \frac{(3y)^6}{6!} \sum_0^3 \frac{(2y)^i}{i!} \right.$$

$$a=6 \left. \frac{43 \left[ \sum_0^6 \frac{(3y)^i}{i!} + \frac{42}{43} \frac{(3y)^7}{7!} + \frac{112}{129} \frac{(3y)^8}{8!} + \frac{224}{387} \frac{(3y)^9}{9!} \right]}{43 \left[ \sum_0^6 \frac{(3y)^i}{i!} + \frac{42}{43} \frac{(3y)^7}{7!} + \frac{112}{129} \frac{(3y)^8}{8!} + \frac{224}{387} \frac{(3y)^9}{9!} \right]} \right.$$

$n=4$

$$s=2 \left\{ \frac{(2y)^4}{4!} \right. \quad (\text{Erlang}).$$

$$a=4 \left. \frac{\sum_0^4 \frac{(2y)^i}{i!}}{\sum_0^4 \frac{(2y)^i}{i!}} \right.$$

$$s=3 \left\{ \frac{(3y)^8}{8!} \sum_0^4 \frac{(2y)^i}{i!} \right.$$

$$a=8 \left. \frac{521 \left[ \sum_0^8 \frac{(3y)^i}{i!} + \frac{518}{521} \frac{(3y)^9}{9!} + \frac{500}{521} \frac{(3y)^{10}}{10!} + \frac{440}{521} \frac{(3y)^{11}}{11!} + \frac{880}{1563} \frac{(3y)^{12}}{12!} \right]}{3 \left[ \sum_0^8 \frac{(3y)^i}{i!} + \frac{518}{521} \frac{(3y)^9}{9!} + \frac{500}{521} \frac{(3y)^{10}}{10!} + \frac{440}{521} \frac{(3y)^{11}}{11!} + \frac{880}{1563} \frac{(3y)^{12}}{12!} \right]} \right.$$

#### 4. Conclusions

It appears from the calculations in section 3, that the numerators as well as the denominators consist of two factors.

A numerator always includes the factor  $(sy)^a : a!$  and a polynomial. A denominator always includes a polynomial and a factor  $K$ . For  $s = 2$ , the polynomial of the numerator and the factor  $K$  are equal to 1.

It will be noted that a relation exists between the two equations corresponding to consecutive

gradings. The polynomial of the denominator of a grading determined by  $n = n_1$  and  $s = s_1$  corresponds to the polynomial of the numerator of the grading determined by  $n = n_1$  and  $s = s_1 + 1$ .

This phenomenon is general and provides a key to the equation for any wanted homogeneous grading. From the Erlang formula for a grading  $(n, s = 2)$ , the equation for the grading  $(n, s = 3)$  is derived. From the latter, that for the grading  $(n, s = 4)$  can be found, et cetera.

Once the polynomial of the numerator of the wanted equation is known, the calculation of the factor  $K$  follows from (6) and, from the product of this polynomial, and the factor  $(sy)^a : a!$ . By simple deduction, the factor  $K$  is equal to a polynomial similar to the one found for the numerator but in which the factors  $(s-1)y$ ,  $[(s-1)y]^2 : 2!$ ,  $[(s-1)y]^3 : 3!$ , et cetera are replaced by

$$\frac{s-1}{s} \binom{a+1}{1}, \quad \left(\frac{s-1}{s}\right)^2 \binom{a+2}{2},$$

$$\left(\frac{s-1}{s}\right)^3 \binom{a+3}{3}, \quad \text{et cetera.}$$

The coefficients  $k_{a+1}$ ,  $k_{a+2}$ , et cetera, of the polynomial of the denominator can be derived from the found coefficients of the numerator, that is, from  $(1 - k_{a+1})$ ,  $(k_{a+1} - k_{a+2})$ , et cetera.

That a relation exists between the equations of consecutive gradings also appears from the fact that a grading determined by  $n = n$ , and  $s = s_1 + 1$  and in which all outlets of one split happen to be occupied, behaves like a grading determined by  $n = n$ , and  $s = s_1$ . The average traffic offered to each split equals  $y$  for both cases.

As a conclusion, it can be stated that the loss equation for any wanted, complete, homogeneous grading of the second order and for the limit  $y \rightarrow \infty$  can be found by the application of a recurrent method. The  $B$  formula of Erlang serves as a starting point.

### 5. Application

To calculate the equation indicating the grade of service for a homogeneous grading typified by  $(n = 3, s = 4)$ , the equation for the grading  $(n = 3, s = 3)$  is used as a starting point (see section 3).

The polynomial of the numerator of the wanted equation can be written immediately as

$$\sum_0^6 (3y)^i : i + \frac{42}{43} \frac{(3y)^7}{7!} + \frac{112}{129} \frac{(3y)^8}{8!} + \frac{224}{387} \frac{(3y)^9}{9!}.$$

The numerator further includes the factor  $(4y)^9 : 9!$  as for  $s = 4$ ,  $a = n(s-1) = 9$ . The factor  $K$  is found by replacing in the above polynomial  $(3y)^i : i!$  by  $\left(\frac{3}{4}\right)^i \binom{a+i}{i}$ , as follows

$$K = \sum_0^6 \left(\frac{3}{4}\right)^i \binom{9+i}{i} + \frac{42}{43} \left(\frac{3}{4}\right)^7 \binom{16}{7}$$

$$+ \frac{112}{129} \left(\frac{3}{4}\right)^8 \binom{17}{8} + \frac{224}{387} \left(\frac{3}{4}\right)^9 \binom{18}{9}.$$

The coefficients  $k_{a+1}$  et cetera of the polynomial of the denominator are determined by

$$k_{a+1} = \frac{K-1}{K}$$

$$k_{a+2} = \frac{K-1 - \frac{3}{4} \binom{10}{1}}{K}$$

$$k_{a+3} = \frac{K-1 - \frac{3}{4} \binom{10}{1} - \left(\frac{3}{4}\right)^2 \binom{11}{2}}{K}$$

...

### 6. General Loss Equation for Complete 3-Split Homogeneous Gradings of the Second Order for $y \rightarrow \infty$

The polynomial of the numerator consists, as already stated, of  $n \binom{s-1}{2} + 1$  terms. Of these,  $n(s-2) + 1$  have the following general appearance.

$$[(s-1)y]^i : i!$$

and  $n \binom{s-2}{2}$  the appearance of

$$f_i [(s-1)y]^i : i!,$$

where  $f_i$  is a numerical factor. For three-split gradings, the latter group lapses, which fact permits the establishment of a general equation for three-split gradings.

The numerator contains first of all the factor

$$(sy)^a : a! = (3y)^{2n} : (2n)!$$

as for  $s = 3$ ,  $a = 2n$ .

The numerator further includes the polynomial

$$\sum_0^n (2y)^i : i!.$$

The denominator includes the numerical factor

$$K = \sum_0^n \left(\frac{2}{3}\right)^i \binom{2n+i}{i}$$



and the polynomial

$$\sum_0^{2n} (3y)^i \cdot i! + k_{2n+1} (3y)^{2n+1} \cdot (2n+1)! + \dots + k_{3n} (3y)^{3n} \cdot (3n)!$$

the coefficients of which are known by

$$k_{2n+1} = \sum_1^n \left(\frac{2}{3}\right)^i \binom{2n+i}{i} : K, \quad k_{2n+2} = \sum_2^n \left(\frac{2}{3}\right)^i \binom{2n+1}{i} : K \dots$$

The complete equation for the wanted grade of service for gradings with  $s = 3$ , therefore, is

$$W = \frac{\frac{(3y)^{2n}}{(2n)!} \sum_0^n \frac{(2y)^i}{i!}}{\sum_0^n \left(\frac{2}{3}\right)^i \binom{2n+i}{i} \times \sum_0^{2n} \frac{(3y)^i}{i!} + \sum_{j=1}^{j=n} \left[ \frac{(3y)^{2n+j}}{(2n+j)!} \sum_{i=j}^{i=n} \left(\frac{2}{3}\right)^i \binom{2n+i}{i} \right]} \quad (7)$$

Figure 2—Relation between two consecutive gradings *A* and *B*. Only one complete cycle is shown. ( $n = 1$ .)

### 7. General Recurrent-Loss Equation ( $y \rightarrow \infty$ )

From the groups of equations appearing in section 3, the following general loss equation for homogeneous gradings of the second order having  $s$  splits and  $n$  outlets per subgroup valid for the limit  $y \rightarrow \infty$ , can readily be derived.

$$W_{n,s}(sy) = \frac{{}_N P_{n,s}(sy)}{{}_{N-a} P_{n,s-1} [(s-1)y]}, \quad (9)$$

where  ${}_N P_{n,s}(sy)$  represents the probability of finding all  $N$  outlets of the considered grading occupied, that is

$${}_N P_{n,s}(sy) = \frac{{}_N k_{n,s}(sy)^N : N!}{\sum_0^a (sy)^i \cdot i! + \sum_{a+1}^N i k_{n,s}(sy)^i \cdot i!} \quad (10)$$

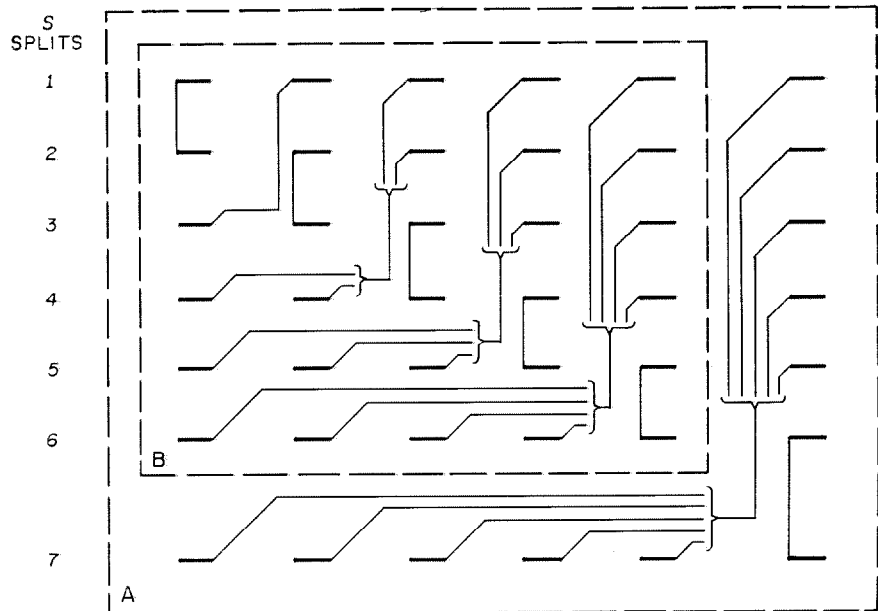
The relation between two consecutive gradings, *A* and *B* in  $s$  is illustrated in Figure 2.

The same equation can also be written in a form more similar to the expressions used in the preceding sections.

$$W_{n,s}(sy) = \frac{A_{n,s-1} [(s-1)y]}{A_{n,s}(sy)} \times \frac{(sy)^a \cdot a!}{K_{n,s-1}}, \quad (11)$$

where

$$\sum_0^a (sy)^i \cdot i! + \sum_{a+1}^N i k_{n,s}(sy)^i \cdot i! = A_{n,s}(sy). \quad (12)$$



$$\sum_0^{a-n} \left(\frac{s-1}{s}\right)^i \binom{a+i}{i} + \sum_{a-n+1}^{N-a} ik_{n,s-1} \left(\frac{s-1}{s}\right)^i \binom{a+i}{i} = K_{n,s-1}. \quad (13)$$

$$\left. \begin{aligned} \left[ \sum_1^{a-n} \left(\frac{s-1}{s}\right)^i \binom{a+i}{i} + \sum_{a-n+1}^{N-a} ik_{n,s-1} \left(\frac{s-1}{s}\right)^i \binom{a+i}{i} \right] \frac{1}{K_{n,s-1}} &= {}_{a+1}k_{n,s} \\ \left[ \sum_2^{a-n} \left(\frac{s-1}{s}\right)^i \binom{a+i}{i} + \sum_{a-n+1}^{N-a} ik_{n,s-1} \left(\frac{s-1}{s}\right)^i \binom{a+i}{i} \right] \frac{1}{K_{n,s-1}} &= {}_{a+2}k_{n,s} \\ \left[ \sum_{a-n+1}^{N-a} ik_{n,s-1} \left(\frac{s-1}{s}\right)^i \binom{a+i}{i} \right] \frac{1}{K_{n,s-1}} &= {}_{2a-n+1}k_{n,s} \\ \left[ {}_{N-a}k_{n,s-1} \left(\frac{s-1}{s}\right)^{N-a} \binom{N}{N-a} \right] \frac{1}{K_{n,s-1}} &= {}_Nk_{n,s} \end{aligned} \right\} \quad (14)$$

$$n = 1, 2, 3 \dots \quad s = 3, 4 \dots \quad a = n(s-1) \quad N = n \binom{s}{2}.$$

### 8. Traffic Emanating from Limited Number of Sources

By analogy with similar problems, it may be concluded that in case the traffic emanates from a limited number of sources the above equations are valid but that the probabilities of the Poisson type should be replaced by those of the Bernoulli type.

### 9. Traffic Tables

The computation of the data contained in the following tables was performed in the electronic computer developed by the Bell Telephone

Manufacturing Company for the Institut de Recherche Scientifique pour l'Industrie et l'Agriculture and for the Fonds National de la Recherche Scientifique, two Belgian research centers. It is operated by the Centre d'Etude et d'Exploitation des Calculateurs Electroniques and this program was prepared by Miss M. Lietaert.

The values shown in the tables represent  $y$ , that is, the traffic offered to each split of a number of homogeneous gradings expressed in erlangs. The results are given in floating-decimal form, the last digit of each entry being the power of 10 by which the mantissa has to be multiplied.

$n = 1$

| $\frac{W}{s}$ | 0.0001 |       | 0.001 |       | 0.002 |       | 0.005 |       | 0.01  |       | 0.02  |       | 0.05  |       |
|---------------|--------|-------|-------|-------|-------|-------|-------|-------|-------|-------|-------|-------|-------|-------|
|               | 3      | 0.819 | -02   | 0.261 | -01   | 0.372 | -01   | 0.596 | -01   | 0.856 | -01   | 0.124 | -00   | 0.208 |
| 4             | 0.531  | -01   | 0.117 | -00   | 0.149 | -00   | 0.206 | -00   | 0.266 | -00   | 0.347 | -00   | 0.505 | -00   |
| 5             | 0.148  | -00   | 0.273 | -00   | 0.329 | -00   | 0.425 | -00   | 0.519 | -00   | 0.640 | -00   | 0.867 | -00   |
| 6             | 0.292  | -00   | 0.481 | -00   | 0.562 | -00   | 0.695 | -00   | 0.821 | -00   | 0.980 | -00   | 0.126 | 01    |
| 7             | 0.476  | -00   | 0.730 | -00   | 0.834 | -00   | 0.100 | 01    | 0.115 | 01    | 0.135 | 01    | 0.169 | 01    |
| 8             | 0.695  | -00   | 0.101 | 01    | 0.113 | 01    | 0.133 | 01    | 0.152 | 01    | 0.174 | 01    | 0.214 | 01    |
| 9             | 0.944  | -00   | 0.132 | 01    | 0.146 | 01    | 0.169 | 01    | 0.190 | 01    | 0.215 | 01    | 0.260 | 01    |
| 10            | 0.121  | 01    | 0.165 | 01    | 0.181 | 01    | 0.207 | 01    | 0.230 | 01    | 0.258 | 01    | 0.306 | 01    |
| 11            | 0.151  | 01    | 0.199 | 01    | 0.218 | 01    | 0.246 | 01    | 0.271 | 01    | 0.302 | 01    | 0.354 | 01    |
| 12            | 0.182  | 01    | 0.235 | 01    | 0.256 | 01    | 0.286 | 01    | 0.313 | 01    | 0.346 | 01    | 0.403 | 01    |

$n = 2$

| $\frac{W}{s}$ | 0.0001 |     | 0.001 |     | 0.002 |     | 0.005 |     | 0.01  |     | 0.02  |     | 0.05  |     |
|---------------|--------|-----|-------|-----|-------|-----|-------|-----|-------|-----|-------|-----|-------|-----|
|               |        |     |       |     |       |     |       |     |       |     |       |     |       |     |
| 3             | 0.139  | -00 | 0.255 | -00 | 0.308 | -00 | 0.399 | -00 | 0.489 | -00 | 0.605 | -00 | 0.828 | -00 |
| 4             | 0.455  | -00 | 0.697 | -00 | 0.798 | -00 | 0.959 | -00 | 0.111 | 01  | 0.130 | 01  | 0.164 | 01  |
| 5             | 0.911  | -00 | 0.127 | 01  | 0.141 | 01  | 0.163 | 01  | 0.184 | 01  | 0.209 | 01  | 0.253 | 01  |
| 6             | 0.146  | 01  | 0.193 | 01  | 0.211 | 01  | 0.239 | 01  | 0.264 | 01  | 0.294 | 01  | 0.347 | 01  |
| 7             | 0.209  | 01  | 0.266 | 01  | 0.287 | 01  | 0.320 | 01  | 0.348 | 01  | 0.383 | 01  | 0.445 | 01  |
| 8             | 0.277  | 01  | 0.343 | 01  | 0.367 | 01  | 0.404 | 01  | 0.436 | 01  | 0.475 | 01  | 0.544 | 01  |
| 9             | 0.350  | 01  | 0.424 | 01  | 0.450 | 01  | 0.491 | 01  | 0.526 | 01  | 0.569 | 01  | 0.644 | 01  |
| 10            | 0.428  | 01  | 0.509 | 01  | 0.536 | 01  | 0.580 | 01  | 0.618 | 01  | 0.664 | 01  | 0.745 | 01  |
| 11            | 0.511  | 01  | 0.598 | 01  | 0.625 | 01  | 0.671 | 01  | 0.712 | 01  | 0.760 | 01  | 0.846 | 01  |

$n = 3$

| $\frac{W}{s}$ | 0.0001 |     | 0.001 |     | 0.002 |     | 0.005 |     | 0.01  |    | 0.02  |    | 0.05  |    |
|---------------|--------|-----|-------|-----|-------|-----|-------|-----|-------|----|-------|----|-------|----|
|               |        |     |       |     |       |     |       |     |       |    |       |    |       |    |
| 3             | 0.433  | -00 | 0.665 | -00 | 0.760 | -00 | 0.917 | -00 | 0.106 | 01 | 0.125 | 01 | 0.159 | 01 |
| 4             | 0.113  | 01  | 0.154 | 01  | 0.170 | 01  | 0.195 | 01  | 0.217 | 01 | 0.245 | 01 | 0.294 | 01 |
| 5             | 0.204  | 01  | 0.259 | 01  | 0.280 | 01  | 0.312 | 01  | 0.341 | 01 | 0.376 | 01 | 0.438 | 01 |
| 6             | 0.306  | 01  | 0.375 | 01  | 0.400 | 01  | 0.438 | 01  | 0.472 | 01 | 0.514 | 01 | 0.587 | 01 |
| 7             | 0.418  | 01  | 0.498 | 01  | 0.526 | 01  | 0.571 | 01  | 0.609 | 01 | 0.655 | 01 | 0.737 | 01 |
| 8             | 0.533  | 01  | 0.626 | 01  | 0.657 | 01  | 0.705 | 01  | 0.748 | 01 | 0.799 | 01 | 0.891 | 01 |
| 9             | 0.659  | 01  | 0.757 | 01  | 0.793 | 01  | 0.844 | 01  | 0.890 | 01 | 0.945 | 01 | 0.104 | 02 |
| 10            | 0.780  | 01  | 0.890 | 01  | 0.932 | 01  | 0.985 | 01  | 0.103 | 02 | 0.109 | 02 | 0.119 | 02 |
| 11            | 0.904  | 01  | 0.102 | 02  | 0.107 | 02  | 0.112 | 02  | 0.114 | 02 | 0.124 | 02 | 0.134 | 02 |

$n = 4$

| $\frac{W}{s}$ | 0.0001 |     | 0.001 |    | 0.002 |    | 0.005 |    | 0.01  |    | 0.02  |    | 0.05  |    |
|---------------|--------|-----|-------|----|-------|----|-------|----|-------|----|-------|----|-------|----|
|               |        |     |       |    |       |    |       |    |       |    |       |    |       |    |
| 3             | 0.842  | -00 | 0.118 | 01 | 0.131 | 01 | 0.153 | 01 | 0.173 | 01 | 0.198 | 01 | 0.243 | 01 |
| 4             | 0.198  | 01  | 0.253 | 01 | 0.273 | 01 | 0.305 | 01 | 0.334 | 01 | 0.369 | 01 | 0.432 | 01 |
| 5             | 0.336  | 01  | 0.407 | 01 | 0.433 | 01 | 0.473 | 01 | 0.509 | 01 | 0.553 | 01 | 0.630 | 01 |
| 6             | 0.488  | 01  | 0.573 | 01 | 0.604 | 01 | 0.650 | 01 | 0.692 | 01 | 0.743 | 01 | 0.833 | 01 |
| 7             | 0.649  | 01  | 0.747 | 01 | 0.781 | 01 | 0.833 | 01 | 0.880 | 01 | 0.936 | 01 | 0.103 | 02 |
| 8             | 0.818  | 01  | 0.925 | 01 | 0.963 | 01 | 0.102 | 02 | 0.107 | 02 | 0.113 | 02 | 0.124 | 02 |
| 9             | 0.994  | 01  | 0.110 | 02 | 0.114 | 02 | 0.120 | 02 | 0.126 | 02 | 0.133 | 02 | 0.145 | 02 |
| 10            | 0.120  | 02  | 0.128 | 02 | 0.133 | 02 | 0.138 | 02 | 0.144 | 02 | 0.153 | 02 | 0.164 | 02 |

$n = 5$

| $\frac{W}{s}$ | 0.0001 |    | 0.001 |    | 0.002 |    | 0.005 |    | 0.01  |    | 0.02  |    | 0.05  |    |
|---------------|--------|----|-------|----|-------|----|-------|----|-------|----|-------|----|-------|----|
|               |        |    |       |    |       |    |       |    |       |    |       |    |       |    |
| 3             | 0.133  | 01 | 0.177 | 01 | 0.194 | 01 | 0.221 | 01 | 0.245 | 01 | 0.276 | 01 | 0.331 | 01 |
| 4             | 0.293  | 01 | 0.359 | 01 | 0.384 | 01 | 0.422 | 01 | 0.457 | 01 | 0.499 | 01 | 0.574 | 01 |
| 5             | 0.479  | 01 | 0.564 | 01 | 0.595 | 01 | 0.642 | 01 | 0.684 | 01 | 0.735 | 01 | 0.826 | 01 |
| 6             | 0.681  | 01 | 0.780 | 01 | 0.816 | 01 | 0.870 | 01 | 0.918 | 01 | 0.977 | 01 | 0.108 | 02 |
| 7             | 0.894  | 01 | 0.100 | 02 | 0.104 | 02 | 0.110 | 02 | 0.115 | 02 | 0.122 | 02 | 0.134 | 02 |
| 8             | 0.111  | 02 | 0.122 | 02 | 0.126 | 02 | 0.133 | 02 | 0.138 | 02 | 0.146 | 02 | 0.160 | 02 |
| 9             | 0.133  | 02 | 0.145 | 02 | 0.149 | 02 | 0.156 | 02 | 0.163 | 02 | 0.172 | 02 | 0.190 | 02 |

$n = 6$

| $\frac{W}{s}$ | 0.0001 |    | 0.001 |    | 0.002 |    | 0.005 |    | 0.01  |    | 0.02  |    | 0.05  |    |
|---------------|--------|----|-------|----|-------|----|-------|----|-------|----|-------|----|-------|----|
|               |        |    |       |    |       |    |       |    |       |    |       |    |       |    |
| 3             | 0.187  | 01 | 0.240 | 01 | 0.261 | 01 | 0.292 | 01 | 0.321 | 01 | 0.357 | 01 | 0.421 | 01 |
| 4             | 0.395  | 01 | 0.472 | 01 | 0.500 | 01 | 0.544 | 01 | 0.584 | 01 | 0.632 | 01 | 0.718 | 01 |
| 5             | 0.629  | 01 | 0.727 | 01 | 0.761 | 01 | 0.815 | 01 | 0.862 | 01 | 0.921 | 01 | 0.102 | 02 |
| 6             | 0.883  | 01 | 0.993 | 01 | 0.103 | 02 | 0.109 | 02 | 0.114 | 02 | 0.121 | 02 | 0.133 | 02 |
| 7             | 0.115  | 02 | 0.127 | 02 | 0.130 | 02 | 0.137 | 02 | 0.144 | 02 | 0.151 | 02 | 0.165 | 02 |
| 8             | 0.143  | 02 | 0.155 | 02 | 0.159 | 02 | 0.166 | 02 | 0.175 | 02 | 0.181 | 02 | 0.197 | 02 |

$n = 7$

| $\frac{W}{s}$ | 0.0001 |    | 0.001 |    | 0.002 |    | 0.005 |    | 0.01  |    | 0.02  |    | 0.05  |    |
|---------------|--------|----|-------|----|-------|----|-------|----|-------|----|-------|----|-------|----|
|               |        |    |       |    |       |    |       |    |       |    |       |    |       |    |
| 3             | 0.246  | 01 | 0.307 | 01 | 0.331 | 01 | 0.367 | 01 | 0.400 | 01 | 0.441 | 01 | 0.514 | 01 |
| 4             | 0.502  | 01 | 0.589 | 01 | 0.621 | 01 | 0.670 | 01 | 0.714 | 01 | 0.768 | 01 | 0.865 | 01 |
| 5             | 0.787  | 01 | 0.894 | 01 | 0.932 | 01 | 0.991 | 01 | 0.104 | 02 | 0.110 | 02 | 0.122 | 02 |
| 6             | 0.109  | 02 | 0.121 | 02 | 0.125 | 02 | 0.132 | 02 | 0.138 | 02 | 0.145 | 02 | 0.159 | 02 |
| 7             | 0.141  | 02 | 0.155 | 02 | 0.159 | 02 | 0.166 | 02 | 0.173 | 02 | 0.181 | 02 | 0.197 | 02 |
| 8             | 0.176  | 02 | 0.188 | 02 | 0.194 | 02 | 0.202 | 02 | 0.212 | 02 | 0.218 | 02 | 0.236 | 02 |

$n = 8$

| $\frac{W}{s}$ | 0.0001 |    | 0.001 |    | 0.002 |    | 0.005 |    | 0.01  |    | 0.02  |    | 0.05  |    |
|---------------|--------|----|-------|----|-------|----|-------|----|-------|----|-------|----|-------|----|
|               |        |    |       |    |       |    |       |    |       |    |       |    |       |    |
| 3             | 0.308  | 01 | 0.378 | 01 | 0.404 | 01 | 0.444 | 01 | 0.482 | 01 | 0.526 | 01 | 0.608 | 01 |
| 4             | 0.612  | 01 | 0.708 | 01 | 0.744 | 01 | 0.798 | 01 | 0.847 | 01 | 0.906 | 01 | 0.101 | 02 |
| 5             | 0.948  | 01 | 0.106 | 02 | 0.110 | 02 | 0.117 | 02 | 0.122 | 02 | 0.129 | 02 | 0.142 | 02 |
| 6             | 0.130  | 02 | 0.143 | 02 | 0.147 | 02 | 0.155 | 02 | 0.161 | 02 | 0.169 | 02 | 0.184 | 02 |
| 7             | 0.169  | 02 | 0.182 | 02 | 0.186 | 02 | 0.195 | 02 | 0.203 | 02 | 0.211 | 02 | 0.228 | 02 |
| 8             | 0.209  | 02 | 0.220 | 02 | 0.229 | 02 | 0.238 | 02 | 0.249 | 02 | 0.254 | 02 | 0.274 | 02 |

$n = 9$

| $\frac{W}{s}$ | 0.0001 |       | 0.001 |       | 0.002 |       | 0.005 |       | 0.01  |       | 0.02  |       | 0.05  |       |
|---------------|--------|-------|-------|-------|-------|-------|-------|-------|-------|-------|-------|-------|-------|-------|
|               | 3      | 0.373 | 01    | 0.450 | 01    | 0.479 | 01    | 0.523 | 01    | 0.564 | 01    | 0.614 | 01    | 0.703 |
| 4             | 0.727  | 01    | 0.830 | 01    | 0.868 | 01    | 0.927 | 01    | 0.980 | 01    | 0.104 | 02    | 0.116 | 02    |
| 5             | 0.111  | 02    | 0.123 | 02    | 0.128 | 02    | 0.135 | 02    | 0.141 | 02    | 0.148 | 02    | 0.163 | 02    |
| 6             | 0.152  | 02    | 0.165 | 02    | 0.170 | 02    | 0.179 | 02    | 0.185 | 02    | 0.193 | 02    | 0.210 | 02    |

$n = 10$

| $\frac{W}{s}$ | 0.0001 |       | 0.001 |       | 0.002 |       | 0.005 |       | 0.01  |       | 0.02  |       | 0.05  |       |
|---------------|--------|-------|-------|-------|-------|-------|-------|-------|-------|-------|-------|-------|-------|-------|
|               | 3      | 0.440 | 01    | 0.524 | 01    | 0.555 | 01    | 0.604 | 01    | 0.648 | 01    | 0.702 | 01    | 0.799 |
| 4             | 0.843  | 01    | 0.955 | 01    | 0.996 | 01    | 0.105 | 02    | 0.111 | 02    | 0.118 | 02    | 0.131 | 02    |
| 5             | 0.127  | 02    | 0.141 | 02    | 0.145 | 02    | 0.153 | 02    | 0.160 | 02    | 0.168 | 02    | 0.183 | 02    |
| 6             | 0.174  | 02    | 0.188 | 02    | 0.193 | 02    | 0.203 | 02    | 0.210 | 02    | 0.218 | 02    | 0.236 | 02    |

$n = 11$

| $\frac{W}{s}$ | 0.0001 |       | 0.001 |       | 0.002 |       | 0.005 |       | 0.01  |       | 0.02  |       | 0.05  |       |
|---------------|--------|-------|-------|-------|-------|-------|-------|-------|-------|-------|-------|-------|-------|-------|
|               | 3      | 0.509 | 01    | 0.601 | 01    | 0.633 | 01    | 0.686 | 01    | 0.733 | 01    | 0.792 | 01    | 0.896 |
| 4             | 0.961  | 01    | 0.108 | 02    | 0.112 | 02    | 0.119 | 02    | 0.125 | 02    | 0.132 | 02    | 0.146 | 02    |
| 5             | 0.144  | 02    | 0.158 | 02    | 0.163 | 02    | 0.171 | 02    | 0.178 | 02    | 0.187 | 02    | 0.203 | 02    |
| 6             | 0.195  | 02    | 0.210 | 02    | 0.216 | 02    | 0.225 | 02    | 0.233 | 02    | 0.244 | 02    | 0.261 | 02    |

$n = 12$

| $\frac{W}{s}$ | 0.0001 |       | 0.001 |       | 0.002 |       | 0.005 |       | 0.01  |       | 0.02  |       | 0.05  |       |
|---------------|--------|-------|-------|-------|-------|-------|-------|-------|-------|-------|-------|-------|-------|-------|
|               | 3      | 0.580 | 01    | 0.677 | 01    | 0.713 | 01    | 0.769 | 01    | 0.820 | 01    | 0.882 | 01    | 0.993 |
| 4             | 0.108  | 02    | 0.120 | 02    | 0.125 | 02    | 0.132 | 02    | 0.139 | 02    | 0.146 | 02    | 0.161 | 02    |
| 5             | 0.161  | 02    | 0.175 | 02    | 0.181 | 02    | 0.189 | 02    | 0.197 | 02    | 0.206 | 02    | 0.223 | 02    |

$n = 13$

| $\frac{W}{s}$ | 0.0001 |       | 0.001 |       | 0.002 |       | 0.005 |       | 0.01  |       | 0.02  |       | 0.05  |       |
|---------------|--------|-------|-------|-------|-------|-------|-------|-------|-------|-------|-------|-------|-------|-------|
|               | 3      | 0.650 | 01    | 0.755 | 01    | 0.794 | 01    | 0.853 | 01    | 0.907 | 01    | 0.973 | 01    | 0.109 |
| 4             | 0.120  | 02    | 0.133 | 02    | 0.138 | 02    | 0.145 | 02    | 0.152 | 02    | 0.161 | 02    | 0.176 | 02    |
| 5             | 0.178  | 02    | 0.192 | 02    | 0.199 | 02    | 0.207 | 02    | 0.215 | 02    | 0.225 | 02    | 0.245 | 02    |

$$n = 14$$

| $\frac{W}{s}$ | 0.0001 |    | 0.001 |    | 0.002 |    | 0.005 |    | 0.01  |    | 0.02  |    | 0.05  |    |
|---------------|--------|----|-------|----|-------|----|-------|----|-------|----|-------|----|-------|----|
|               |        |    |       |    |       |    |       |    |       |    |       |    |       |    |
| 3             | 0.725  | 01 | 0.834 | 01 | 0.875 | 01 | 0.937 | 01 | 0.994 | 01 | 0.106 | 02 | 0.119 | 02 |
| 4             | 0.133  | 02 | 0.146 | 02 | 0.151 | 02 | 0.160 | 02 | 0.167 | 02 | 0.174 | 02 | 0.191 | 02 |
| 5             | 0.195  | 02 | 0.209 | 02 | 0.217 | 02 | 0.225 | 02 | 0.234 | 02 | 0.244 | 02 | 0.266 | 02 |

# United States Patents Issued to International Telephone and Telegraph System; August-October 1957

**B**ETWEEN August 1 and October 31, 1957, the United States Patent Office issued 49 patents to the International System. The names of the inventors, company affiliations, subjects, and patent numbers are listed below.

- A. H. W. Beck, Standard Telecommunication Laboratories (London), Electron Discharge Apparatus, 2 810 853.
- W. Berthold, C. Lorenz A. G. (Stuttgart), Gun System for Cathode-Ray Tubes, 2 802 139.
- E. M. Bradburd, Federal Telecommunication Laboratories, Tuned High-Frequency Amplifier, 2 803 710.
- A. E. Brewster, Standard Telecommunication Laboratories (London), Regenerative Telegraph Repeaters, 2 802 052.
- J. H. Bryant, Federal Telecommunication Laboratories, Radio-Frequency Matching Devices, 2 803 777.
- H. Burr, Standard Telephones and Cables (London), Electric Cables, 2 810 011.
- K. W. Cattermole, Standard Telecommunication Laboratories (London), Electric Pulse Generators Employing Semiconductors, 2 807 719.
- D. W. Davis, Farnsworth Electronics Company, Cathode-Ray Amplifier, 2 808 526.
- R. C. Davis and E. B. Moore, Federal Telephone and Radio Company, Combination Automatic-Gain-Control and Silencer Amplifier, 2 802 099.
- C. L. Day, Capehart-Farnsworth Company, Vacuum-Tube Element, 2 802 126.
- E. de Faymoreau, Federal Telecommunication Laboratories, Servomotor Control System, 2 810 874.
- M. J. Di Toro, W. Graham, and S. M. Schreiner, Federal Telecommunication Laboratories, Compressed-Frequency Communication System, 2 810 787.
- E. L. Earle, Kellogg Switchboard and Supply Company, Armature Keeper for Electromagnetic Relay, 2 811 681.
- H. F. Engelmann, Federal Telecommunication Laboratories, Attenuators, 2 810 891.
- P. F. M. Gloess, Le Matériel Téléphonique (Paris), Sounding Device Using Electromagnetic Waves, 2 807 016.
- F. P. Gohorel, Compagnie Générale de Constructions Téléphoniques (Paris), Automatic Telephone Systems, 2 810 018.
- A. N. Gulnick, Federal Telecommunication Laboratories, Delayed Action Switch, 2 810 797.
- T. F. S. Hargreaves, H. T. Prior, and W. F. S. Chittleburgh, Standard Telephones and Cables (London), Voice-Frequency-Signal Receivers, 2 806 903.
- E. J. Hasney, Capehart-Farnsworth Company, Shaft Coupling Assembly, 2 801 531.
- A. Q. Hislop and W. Q. Leysath, Capehart-Farnsworth Company, Stroboscopic Device, 2 802 145.
- L. Holik and H. Nowotny, Vereinigte Telephon- und Telegraphenfabriks, A. G., Czeija, Nissl & Co. (Vienna), Electrolytic Capacitors, 2 806 982.
- J. F. Houdek, Jr., Kellogg Switchboard and Supply Company, Selective Gong Damper for Dual-Gong Ringer, 2 808 019.
- T. M. Jackson and A. D. Odell, Standard Telephones and Cables (London), Electrical Circuits Using Multigap Cold-Cathode Gas-Filled Tubes, 2 810 861.
- A. G. Kandoian, Federal Telephone and Radio Company, Antenna Couplings, 2 807 713.
- W. Keilig, Mix & Genest (Stuttgart), Edgewise Conveyor System, 2 809 741.
- M. Kenmoku, Nippon Electric Company (Tokyo), Traveling-Wave Tube, 2 807 742.

- E. Labin and D. D. Grieg, Federal Telephone and Radio Company, Indicating and Calibrating Means, 2 802 179.
- G. X. Lens, Bell Telephone Manufacturing Company (Antwerp), Combined Code Recorder and Selector, 2 807 376.
- A. Lesti, Federal Telecommunication Laboratories, Decoder for Pulse-Code-Modulation Systems, 2 807 715.
- A. Lieb, C. Lorenz A. G. (Stuttgart), Electronic Controlling Device, 2 807 738.
- F. Malsch, C. Lorenz A. G. (Stuttgart), Tuning Indicator Valve, 2 802 128.
- A. W. McEwan, C. E. Anderson, and C. V. Daniels, Federal Telecommunication Laboratories, Traveling-Wave Electron Discharge Device, 2 806 973.
- E. M. S. McWhiter, Intelx Systems Incorporated, Document Jacketing and Encoding Machine, 2 806 335.
- R. B. Odden, Capehart-Farnsworth Company, Wave-Selecting and Synchronizing System, 2 802 105.
- S. B. Pickles and M. A. Karpeles, Federal Telecommunication Laboratories, Radio Navigation Receiver, 2 803 821.
- W. H. P. Pouliart and J. P. H. Vandevenne, Bell Telephone Manufacturing Company (Antwerp), Electrical Information Storage Arrangement, 2 807 004.
- H. T. Prior and W. F. S. Chittleburgh, Standard Telephones and Cables (London), Synchronizing Arrangements in Electric Telegraph Systems, 2 802 051.
- F. Schmidt, Mix & Genest (Stuttgart), Circuit Arrangement to Improve Impulsing and Supply in Stations with Long Subscribers' Lines, 2 806 085.
- W. Sindzinski, Mix & Genest (Stuttgart), Unloader for Edgewise Conveyor System, 2 810 469.
- W. Sindzinski, Mix & Genest (Stuttgart), Coacting Belt Conveyor System, 2 806 582.
- W. Sindzinski and M. Muller, Mix & Genest (Stuttgart), Conveying Device, 2 801 725.
- A. T. Starr, H. Grayson, R. A. G. Dunkley, and T. H. Walker, Standard Telecommunication Laboratories (London), Electromagnetic Switches, 2 802 170.
- E. Stein and F. H. Numrich, Federal Telecommunication Laboratories, Protective Circuit, 2 810 858.
- K. Steinbuch, Mix & Genest (Stuttgart), Circuit Arrangement to Change Characteristic Curve of Multielectrode Tubes, 2 806 154.
- H. K. J. Strosche, Süddeutsche Apparatefabrik (Nürnberg), Method of Producing Selenium Rectifiers, 2 807 762.
- I. R. Taylor, Federal Telecommunication Laboratories, Antenna Structure, 2 805 414.
- F. A. Termini and J. M. Rafalko, Federal Telecommunication Laboratories, Apparatus for Printed-Circuit Solder Coating, 2 803 216.
- S. H. Towner and L. R. Hatch, Standard Telephones and Cables (London), Electromagnetic Light-Current Contact-Making Relays, 2 802 156.
- T. H. Walker, Standard Telecommunication Laboratories (London), Electric Trigger Circuits, 2 806 153.

***Sounding Device Using Electromagnetic Waves***

2 807 016

P. F. M. Gloess

This basic patent covers plan-position-indicator radar. The invention covers broadly the arrangement for deriving directly from reflected radar pulses information including the angular position of the reflecting object and the distance to the object, this combined information being displayed on a single indicator.

***Document Jacketing and Encoding Machine***

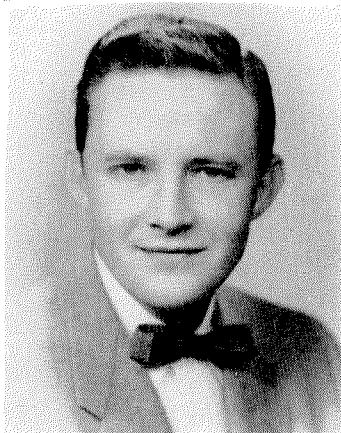
2 806 335

E. M. S. McWhirter

This invention covers the conveyor and jacketing machine for use in automatic bank accounting machines.



## Contributors in This Issue



GUY E. ADAMS

GUY E. ADAMS holds the B.S.E.E. and B.S.M.E. degrees from Purdue University and has attended its graduate school. He has had extensive experience in control systems for drone aircraft. During the past several years he has been engaged in the analysis, design, and development of control systems and computers for missile control, fire control, bombing systems, and simulators. As a senior engineer in the electromechanical section at Farnsworth Electronics Company, he prepared the paper in this issue on servomechanisms.

At the present time, Mr. Adams is systems section head in the inertial



F. BUCHHOLTZ

systems department, mechanical division, of General Mills, Incorporated. He is a Senior Member of the IRE.

• • •

F. BUCHHOLTZ was born in Braunschweig in Germany on June 4, 1923. His engineering education was received at the State College in Dortmund.

After working as a development engineer for various organizations, he joined Mix & Genest, now a division of Standard Elektrik A.G., in 1951.

His particular responsibility is the development of amplifiers and repeaters for carrier-operated telephone systems and he is head of that laboratory within Standard Central Laboratories in Stuttgart. Mr. Buchholtz reports on the Z6NC carrier telephone system in this issue.

• • •

LEOPOLD CHRISTIANSEN was born in Kiev, Russia, on December 2, 1913. He studied at the Technical University of Stuttgart, at the Rensselaer Polytechnic Institute of Troy, New York, and at the Technical University of Dresden, where he received his diploma and his doctorate.

He worked first at the Institute of Electrical Engineering of the Technical University of Dresden. In 1948, he joined Mix & Genest, now a division of Standard Elektrik A.G. Since that time, he has been engaged in the development of various carrier-frequency telephony systems, and is now head of the wire and cable transmission laboratories.

In this issue, he is coauthor of the paper on the Z6NC carrier-frequency telephone system.

• • •

LUCIEN R. GILLON was born in Saint-Maur-des-Fossés, France, on February 21, 1920. He graduated in 1940 as an engineer from the Ecole Nationale d'Arts et Métiers of Paris.

He joined the Compagnie Générale de Constructions Téléphoniques in



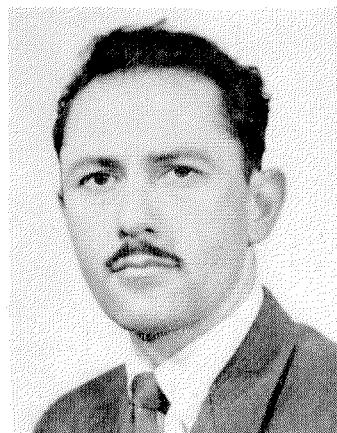
LEOPOLD CHRISTIANSEN

February 1941 and was assigned to the remote-control division of the technical department. Mr. Gillon has been the head of this division since 1953. He is the author of the paper in this issue on the supervision equipment for a 65-kilovolt power network.

• • •

JAKOB KRUIHTOF was born in Rotterdam, Netherlands, on November 6, 1894. He received the degree of Electro-Technical Engineer from Delft Technical High School in Holland in 1922 and of Doctor in Applied Sciences from Ghent University in Belgium in 1945.

Dr. Kruithof is Technical Development Administrator of Bell Telephone



LUCIEN R. GILLON



JAKOB KRUTHOF

Manufacturing Company in Antwerp, Belgium, and Assistant Technical Director of the International Standard Electric Corporation. He reports in this issue on homogeneous gradings for telephone switching systems.

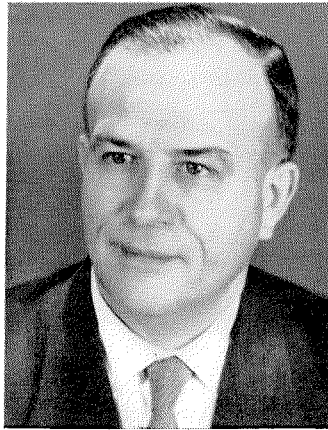
• • •

WILHELM SCHMITZ was born in Honnef on the Rhine in Germany on April 14, 1902. He received a diploma from the Technical College of Aachen

in 1926, a doctor of engineering degree from the Technical College of Berlin in 1932, and, from the same college, a doctor of engineering license in 1939.

After working for Siemens and Halske from 1927 to 1949, he joined C. Lorenz A.G. and is now director of the laboratory for railroad safety systems.

Dr. Schmitz holds a large number of patents and has published his work extensively. His paper in this issue describes the Tricon railroad interlock system.



WILHELM SCHMITZ



W. ZAISER

W. ZAISER was born on July 27, 1912 in Boeblingen, Germany. He received a doctorate from the Technical College of Stuttgart.

After several years with Allgemein Elektrizitäts Gesellschaft, he joined Mix and Genest, now a division of Standard Elektrik A.G., in 1951. He is now in charge of the laboratory for the development of multichannel telephone carrier systems of Standard Central Laboratories in Stuttgart. Dr. Zaiser is coauthor of the paper on the Z6N carrier system.

# INTERNATIONAL TELEPHONE AND TELEGRAPH CORPORATION

## Principal U. S. Divisions and Subsidiaries

|                  |   |                     |  |
|------------------|---|---------------------|--|
| <b>DIVISIONS</b> | Components Division, Clifton, N. J.<br>Kuthe Laboratories, Inc., Newark, N. J.<br>Farnsworth Electronics Company, Fort Wayne, Ind.<br>Federal Telecommunication Laboratories, Nutley, N. J.<br>Federal Telephone and Radio Company, Clifton, N. J.<br>Industrial Products Division, San Fernando, Calif.<br>Kellogg Switchboard and Supply Company, Chicago, Ill. | <b>SUBSIDIARIES</b> | American Cable & Radio Corporation, New York, N. Y.<br>All America Cables and Radio, Inc., New York, N. Y.<br>Commercial Cable Company, The, New York, N. Y.<br>Mackay Radio and Telegraph Company, New York, N. Y.<br>Federal Electric Corporation, Paramus, N. J.<br>Intelix Systems Incorporated, New York, N. Y.<br>Airmatic Systems Corporation, Rochelle Park, N. J.<br>International Telephone Building Corporation, New York, N. Y.<br>Kellogg Credit Corporation, New York, N. Y.<br>Royal Electric Corporation, Pawtucket, R. I. |
|------------------|---|---------------------|--|

### and . . . International Standard Electric Corporation, New York, N. Y. whose principal research, manufacturing, and sales affiliates are:

|                  |  |                       |  |
|------------------|--|-----------------------|--|
| <b>ARGENTINA</b> | Capehart Argentina S.A.I.C. (50% owned),<br>Buenos Aires<br>Compañía Standard Electric Argentina, S.A.I.C.,<br>Buenos Aires  |                       | Mix & Genest Werke (division), Stuttgart<br>Schaub Werk (division), Pforzheim  |
| <b>AUSTRALIA</b> | Standard Telephones and Cables Pty. Limited, Sydney<br>Austral Standard Cables Pty. Limited<br>(50% owned), Melbourne<br>Silovac Electrical Products Pty. Limited, Sydney<br>Standard Telephones and Cables (Qld.) Pty.<br>Limited, Brisbane | <b>IRAN</b>           | Standard Elektrizitäts-Gesellschaft Iran A.G.,<br>Teheran  |
| <b>AUSTRIA</b>   | Standard Telephon und Telegraphen<br>Aktiengesellschaft, Czeija, Nissl & Co., Vienna   | <b>ITALY</b>          | Fabbrica Apparecchiature per Comunicazioni<br>Elettriche Standard S.p.A., Milan  |
| <b>BELGIUM</b>   | Bell Telephone Manufacturing Company, Antwerp  | <b>MEXICO</b>         | Industria de Telecomunicación, S.A. de C.V.<br>(50% owned), Mexico City<br>Standard Eléctrica de México, S.A., Mexico City   |
| <b>BRAZIL</b>    | Standard Eléctrica, S.A., Rio de Janeiro   | <b>NETHERLANDS</b>    | Nederlandsche Standard Electric Maatschappij N.V.,<br>The Hague  |
| <b>CANADA</b>    | Standard Telephones & Cables Mfg. Co. (Canada), Ltd.,<br>Montreal  | <b>NEW ZEALAND</b>    | New Zealand Electric Totalisators Limited,<br>Wellington   |
| <b>CHILE</b>     | Compañía Standard Electric, S.A.C., Santiago   | <b>NORWAY</b>         | Standard Telefon og Kabelfabrik A/S, Oslo  |
| <b>CUBA</b>      | Equipos Telefónicos Standard de Cuba, Havana<br>International Standard Products Corporation, Havana  | <b>PORTUGAL</b>       | Standard Eléctrica, S.A.R.L., Lisbon   |
| <b>DENMARK</b>   | Standard Electric Aktieselskab, Copenhagen   | <b>PUERTO RICO</b>    | Standard Electric Corporation of Puerto Rico, San Juan   |
| <b>FINLAND</b>   | Oy Suomen Standard Electric AB, Helsinki   | <b>SPAIN</b>          | Standard Eléctrica, S.A., Madrid   |
| <b>FRANCE</b>    | Compagnie Générale de Constructions Téléphoniques,<br>Paris<br>Les Téléimprimeurs, Paris<br>Laboratoire Central de Télécommunications, Paris<br>Le Matériel Téléphonique, Paris  | <b>SWEDEN</b>         | Standard Radio & Telefon AB, Stockholm   |
| <b>GERMANY</b>   | Standard Elektrik Lorenz A.G., Stuttgart<br>Bauelemente Werk S.A.F. (division), Nuremberg<br>Informatikwerk (division), Stuttgart<br>Kabelwerk (division), Stuttgart<br>Lorenz Werke (division), Stuttgart                                   | <b>SWITZERLAND</b>    | Standard Téléphone et Radio S.A., Zurich   |
|                  |  | <b>TURKEY</b>         | Standard Electric Türk Limited Sirketi, Ankara   |
|                  |  | <b>UNITED KINGDOM</b> | Creed & Company, Limited, Croydon<br>Standard Telephones and Cables Limited, London<br>Kolster-Brandes Limited, Sidcup<br>Standard Telecommunication Laboratories<br>Limited, London |
|                  |  | <b>VENEZUELA</b>      | Standard Telecommunications C.A., Caracas  |

## Overseas Telecommunication Companies

|                  |  |                       |  |
|------------------|--|-----------------------|--|
| <b>ARGENTINA</b> | Compañía Internacional de Radio, S.A., Buenos Aires<br>Sociedad Anónima Radio Argentina (subsidiary<br>of American Cable & Radio Corporation),<br>Buenos Aires | <b>CUBA</b>           | Cuban American Telephone and Telegraph<br>Company, (50% owned), Havana<br>Cuban Telephone Company, Havana<br>Radio Corporation of Cuba, Havana |
| <b>BOLIVIA</b>   | Compañía Internacional de Radio Boliviana, La Paz  | <b>PERU</b>           | Compañía Peruana de Teléfonos Limitada, Lima   |
| <b>BRAZIL</b>    | Companhia Rádio Internacional do Brasil,<br>Rio de Janeiro<br>Companhia Telefônica Nacional, Curitiba and Pôrto Alegre   | <b>PUERTO RICO</b>    | Porto Rico Telephone Company, San Juan<br>Radio Corporation of Puerto Rico, San Juan   |
| <b>CHILE</b>     | Compañía de Teléfonos de Chile, Santiago<br>Compañía Internacional de Radio, S.A., Santiago  | <b>SPAIN</b>          | Compañía Radio Aérea Marítima Española, S.A., Madrid   |
|                  |  | <b>UNITED KINGDOM</b> | International Marine Radio Company Limited, Croydon  |

## Associate Licensees for Manufacture and Sales

|               |  |              |   |
|---------------|--|--------------|---|
| <b>FRANCE</b> | Lignes Télégraphiques et Téléphoniques, Paris        | <b>JAPAN</b> | Nippon Electric Company, Limited, Tokyo<br>Sumitomo Electric Industries, Limited, Osaka |
| <b>ITALY</b>  | Società Italiana Reti Telefoniche Interurbane, Milan | <b>SPAIN</b> | Marconi Española, S.A., Madrid  |