



ELECTRICAL COMMUNICATION

*Technical Journal of the
International Telephone and Telegraph Corporation
and Associate Companies*

**BEYOND-THE-HORIZON PROPAGATION
IN
MICROWAVE RADIO SYSTEMS**



Volume 33

JUNE, 1956

Number 2

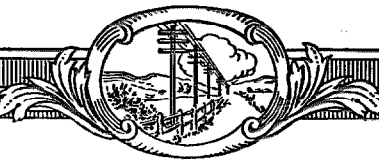

ELECTRICAL COMMUNICATION

*Technical Journal of the
International Telephone and Telegraph Corporation
and Associate Companies*

H. P. WESTMAN, Editor
J. E. SCHLAIKJER, Assistant Editor

EDITORIAL BOARD

H.G. Busignies H.H. Buttner G. Chevigny A. G. Clavier E. M. Deloraine B. C. Holding H. L. Hull
J. Kruithof W. P. Maginnis A. W. Montgomery E. D. Phinney G. Rabuteau P. C. Sandretto
N. H. Saunders C. E. Scholz T. R. Scott C. E. Strong F. R. Thomas H. B. Wood

Published Quarterly by the
INTERNATIONAL TELEPHONE AND TELEGRAPH CORPORATION
67 BROAD STREET, NEW YORK 4, NEW YORK, U.S.A.

Edmond H. Leavey, President
Geoffrey A. Ogilvie, Vice President and Secretary

Subscription, \$2.00 per year; single copies, 50 cents
Copyrighted © 1956 by International Telephone and Telegraph Corporation

Volume 33

JUNE, 1956

Number 2

CONTENTS

MICROWAVES TRAVEL BEYOND THE HORIZON	106
MICROWAVE COMMUNICATION BEYOND THE HORIZON	108
<i>By André G. Clavier</i>	
BEYOND-THE-HORIZON 3000-MEGACYCLE PROPAGATION TESTS IN 1941	117
<i>By André G. Clavier and V. A. Altovsky</i>	
INVESTIGATION OF VERY-HIGH-FREQUENCY NONOPTICAL PROPAGATION BETWEEN SARDINIA AND MINORCA	133
<i>By José Maria Clara and Albino Antinori</i>	
900-MEGACYCLE PULSE-TIME-MODULATION BEYOND-THE-HORIZON RADIO LINK	143
<i>By Frederick J. Altman, Richard E. Gray, Armig G. Kandoian, and William Sichak</i>	
SIMPLIFIED DIVERSITY COMMUNICATION SYSTEM FOR BEYOND-THE-HORIZON LINKS	151
<i>By Frederick J. Altman and William Sichak</i>	
CONFIGURATIONS FOR BEYOND-THE-HORIZON DIVERSITY SYSTEMS	161
<i>By Frederick J. Altman</i>	
DESIGN CHART FOR TROPOSPHERIC BEYOND-THE-HORIZON PROPAGATION	165
<i>By Frederick J. Altman</i>	
RANGE OF MULTICHANNEL RADIO LINKS BETWEEN 30 AND 10 000 MEGACYCLES	168
<i>By Helmut Carl</i>	
UNITED STATES PATENTS ISSUED TO INTERNATIONAL TELEPHONE AND TELEGRAPH SYSTEM: NOVEMBER, 1955-JANUARY, 1956	174
IN MEMORIAM—WILLIAM HENRY HARRISON	176
CONTRIBUTORS TO THIS ISSUE	178





TROPOSPHERE

Microwaves Travel

MICROWAVE radio communication over line-of-sight paths is now accepted as being quite conventional. Its extension substantially beyond the optical horizon, once thought to be impracticable, is now receiving much attention. A great deal of laboratory work has been done on the development of microwave apparatus, and experimentation with it in the field has disclosed that nature provides means for scattering microwaves to places far beyond the direct optical horizon of the transmitter.

The troposphere and ionosphere are layers of the gaseous blanket that envelops the earth. These particularly identified regions are about 10 and 100 miles above the surface of the earth, respectively. Unlike an optical mirror, they are not sharply defined surfaces that remain fixed in space but are broad regions from which electromagnetic waves are scattered in an irregular pattern that varies from moment to moment.

Ionospheric scatter occurs over distances of the order of a thousand miles at frequencies between 25 and 60 megacycles per second. At this time, it seems to be limited to bandwidths suitable for telegraphy and telephony.

Tropospheric scatter, occurring relatively close to the earth, produces useful signals over distances of a few hundred miles. It is applicable to a wide range of frequencies

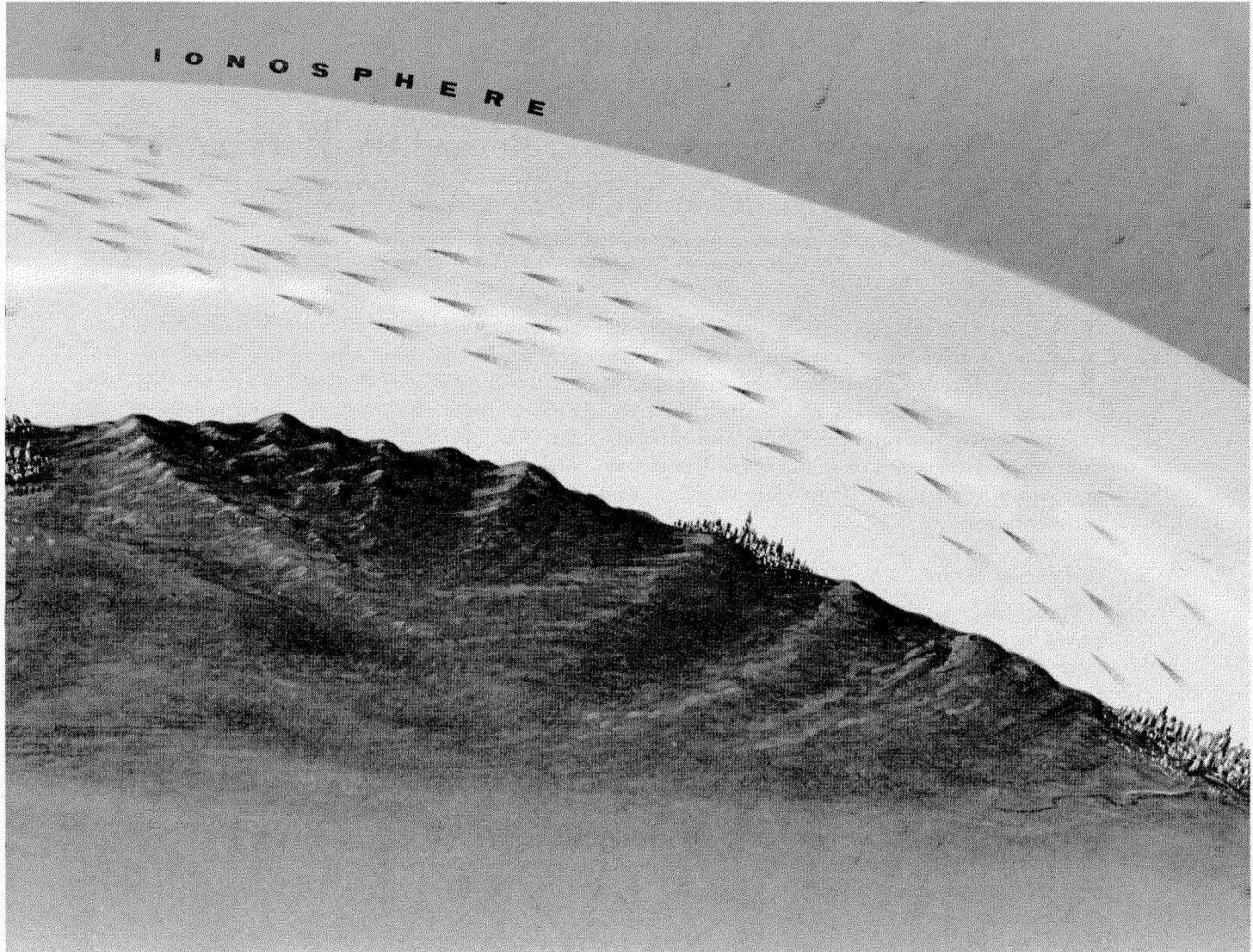

IONOSPHERE

Beyond the Horizon

and, therefore, offers a large number of channels that may be used for such wide-band communication services as multichannel telephony and television.

In general, a single transmission over one of these beyond-the-horizon microwave paths is too greatly affected by short-term fading to be of adequate commercial value. By operating two or more such transmissions in parallel and by selecting the strongest signal at each moment at the receiving end, commercial reliability can be attained.

The effective radiated power must, however, be very great so that not only are the transmitters of maximum ratings but extremely high-gain antennas must be used to concentrate the radiated waves into thin pencil-like beams that are aimed toward the receiving antennas, which are out of sight around the bulge of the earth.

The cost of such a system is high, but the prize is another new and useful communication channel wrested from nature's stockpile of mysteries.

The International System has a long history of successful research, development, and application of microwaves to communication systems. This issue of Electrical Communication is devoted entirely to its work on beyond-the-horizon microwave propagation.

Microwave Communication Beyond the Horizon

By ANDRÉ G. CLAVIER

Federal Telecommunication Laboratories, a division of International Telephone and Telegraph Corporation; Nutley, New Jersey

PERHAPS the most important advance in microwave communication in recent years was the discovery that the attenuation of signal strength beyond the horizon was not so large as was generally predicted from theoretical considerations and from the limited evidence previously available on "near-line-of-sight" experimentation.

1. Line of Sight

When early in 1931 the application of microwaves to radio communication was experimentally demonstrated¹ across the English Channel from Escalles in France to Saint Margaret's Bay in England, it was thought that the best condition would obtain when an unhampered line of sight was available between the transmitting and receiving antennas. It was even expected that the losses in the transmission path across the troposphere would remain quite stable and that this radio-communication system would in effect justify its early name of "Hertzian Cable," which is still sometimes used to suggest its similarities with propagation through physical waveguides and the attendant stability of losses. Though this hope was soon disappointed, particularly on the rather unfavorable path over the English Channel, as illustrated by Figure 1, the use of frequency diversity² brought at least a partial cure.

The pioneering enthusiasm of the group of engineers on the job has been amply justified by

¹ "Micro-ray Radio," *Electrical Communication*, volume 10, pages 20-21; July, 1931; Also, A. G. Clavier and L. C. Gallant, "Anglo-French Micro-Ray Link Between Lympe and St. Inglevert," *Electrical Communication*, volume 12, pages 222-228; January, 1934.

² A. G. Clavier, "Propagation Tests with Micro-Rays," *Electrical Communication*, volume 15, pages 211-219; January, 1937.

the extent to which microwave relay links have blossomed all over the world based on substantially the same ideas developed for the Calais-Dover experiments. In its annual report for 1955, the Federal Communications Commission mentions, for instance, that at the end of 1954, some 6 million miles of telephone circuits in the United States was by microwaves, these facilities also serving for the relaying of radio and television programs. There is no doubt that these systems have markedly increased in 1955 and will continue to expand in the future. These line-of-sight installations will remain the major

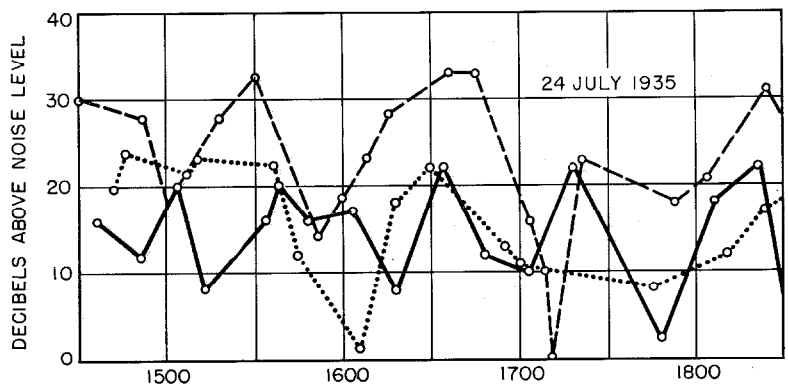

Figure 1—Record of disturbed transmission across the English Channel for a 4-hour period. The solid-line curve is for 18 centimeters (1667 megacycles), the dashed-line is for 20 centimeters (1500 megacycles), and the dash-dot line is for 29 centimeters (1040 megacycles).

type of microwave application whenever suitable sites and radio frequencies are available, particularly for broadband systems that compete with coaxial cables in the field of heavy-traffic multichannel telephony and intercity television communication.

2. Beyond the Horizon

It was, of course, realized from the beginning that propagation did not stop abruptly at the horizon; nature never acts that way. It was feared, however, that attenuation would increase considerably near and beyond the horizon and

that the establishment of communication under these circumstances would necessitate excessive antenna sizes or unavailable transmitter powers. One particular aspect of beyond-the-horizon propagation was investigated in 1941 by V. Altovsky and the writer. The field strength produced by a 50-watt frequency-modulated transmitter at 3000 megacycles per second was measured aboard a ship on the Mediterranean in trips from Toulon toward the Spanish and Algerian coasts. Due to the unusual circumstances in which these experiments were conducted, the results could not be published. It is believed that they are still of sufficient interest to warrant publication and are the subject of a companion paper³ in this issue.

Since that time, and particularly since 1950, many experimental and theoretical studies have been made and published. Particular credit should be given to the National Bureau of Standards, Lincoln Laboratory of Massachusetts Institute of Technology, and Bell Telephone Laboratories for their experimental investigations of microwave tropospheric propagation beyond the horizon. The striking fact that resulted from these and other researches was that beyond the horizon, at distances of the order of 100 to 500 miles (160 to 800 kilometers) or more, the average signal strength was found to be much larger than was indicated by the previously accepted diffraction theories that assumed a smooth-surface structure of the earth.

The explanation of the mechanism responsible for these results cannot be considered as final at the time this paper is written. Forward scattering, as indicated in Figure 2, due to a granular turbulent troposphere with "blobs" of refractive indexes that differ from the average value has the support of many scientists, who follow the lead of Booker,⁴ Gordon⁵ and others. Partial reflections on various refractive layers have also been indicated as a plausible

cause.⁶ A good summary of the various theses on tropospheric propagation of ultra-short waves beyond the horizon has been given by Ortusi.⁷

The objective of the present paper is not to discuss the validity of these theories. It is to present briefly the major facts underlying the

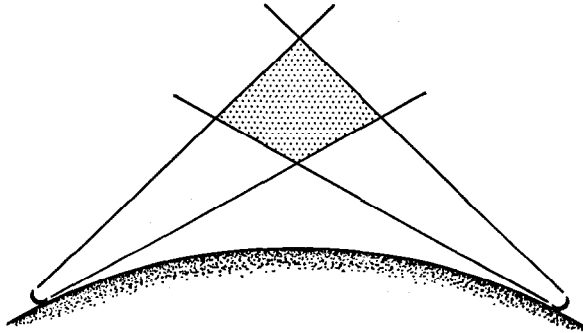

Figure 2—Principles of tropospheric propagation beyond the horizon. The transmitted beam strikes a region that scatters part of the energy in various directions; some of the energy reaches the receiving antenna.

design of equipment to ensure specified performance and reliability. Other papers in this issue will deal with experimental work conducted by the International System and with equipment designed for specific cases. The use of microwaves is a field of communications in which the System has always manifested the liveliest interest and in which it can indeed claim many "firsts," among which are the first public demonstration of ultra-high-frequency communication (Calais-Dover, 1931); the first commercial ultra-high-frequency link (Lympne-Saint Inglevert, 1933); the first public demonstration of pulse-time-modulation multiplex microwave communication (New York City, 1945); and the first television across the English Channel using portable microwave links (Calais-Dover, 1950). The accompanying papers will describe some of the contributions of the International System to the application of tropospheric propagation beyond the horizon for commercial purposes.

³ A. G. Clavier and V. Altovsky, "Beyond-the-Horizon 3000-Megacycle Propagation Tests in 1941," *Electrical Communication*, volume 33, pages 117-132; June, 1956.

⁴ H. G. Booker and J. T. deBettencourt, "Theory of Radio Transmission by Tropospheric Scattering Using Very Narrow Beams," *Proceedings of the IRE*, volume 43, pages 281-290; March, 1955.

⁵ W. E. Gordon, "Radio Scattering in the Troposphere," *Proceedings of the IRE*, volume 43, pages 23-28; January, 1955.

⁶ T. J. Carroll and R. M. Ring, "Propagation of Short Radio Waves in the Normally Stratified Troposphere," presented at the General Assembly of the International Scientific Radio Union (URSI), Commission 2; The Hague, Netherlands: August 23 to September 2, 1954.

⁷ J. Ortusi, "Various Theories on Propagation of Ultra-Short Waves Beyond the Horizon," *IRE Transactions on Antennas and Propagation*, volume 3, pages 86-91; April, 1955.

3. Basic Attenuation Curves

The facts about microwave tropospheric propagation have been very competently explained by Bullington,⁸ the Lincoln Laboratory research group,⁹ Davidson and Poté,¹⁰ and members of the National Bureau of Standards.¹¹

The presentation adopted in Figure 3 follows a coordinate system suggested by Bullington¹² and extends it to the values obtained beyond the horizon. The ordinates are values in decibels below the free-space level, this latter level being calculated between isotropic antennas in free space. The abscissas are the ratio of the clearance of a line of sight over the surface of the earth (either positive for true line of sight or negative for the beyond-the-horizon condition) to the radius of the first Fresnel zone at each distance considered. This radius is a rather convenient yardstick because it measures the dimension of the space where those electromagnetic fields of a plane wave are located that contribute significantly to the strength of the received signal.

The Fresnel theory of diffraction over a knife edge and the signal resulting from complete reflections from a plane surface lead to expressions in terms of the above abscissas that are independent of frequency. In the computation of diffracted fields over a perfectly smooth sphere, the values depend on a parameter that includes antenna heights and frequency. As we are not here specifically interested in that part of the space, the various curves may be replaced by an average one that will serve our present purpose.

⁸ K. Bullington, "Characteristics of Beyond-the-Horizon Radio Transmission," *Proceedings of the IRE*, volume 43, pages 1175-1180; October, 1955.

⁹ G. L. Mellen, W. E. Morrow, A. J. Poté, W. H. Rodford, and J. B. Wiesner, "UHF Long-Range Communication Systems," *Proceedings of the IRE*, volume 43, pages 1269-1289; October, 1955.

¹⁰ D. Davidson and A. J. Poté, "Designing Over-Horizon Communication Links," *Electronics*, volume 28, pages 126-131; December, 1955.

¹¹ J. W. Herbstreit, P. L. Rice, and E. B. Sprecker, "Survey of CRPL Research in Tropospheric Propagation," National Bureau of Standards Report 3520.

¹² K. Bullington, "Propagation of UHF and SHF Waves Beyond the Horizon," *Proceedings of the IRE*, volume 38, pages 1221-1222; October, 1950.

Figure 3—Basic attenuation curve for tropospheric propagation. Region *A* represents the plane-earth assumption with a reflection coefficient of unity. *B* is for the region between a clearance equal to the first Fresnel zone and grazing incidence. *C* is when the diffracted field is controlling. *D* is for tropospheric propagation beyond the horizon based on data by Davidson and Poté.

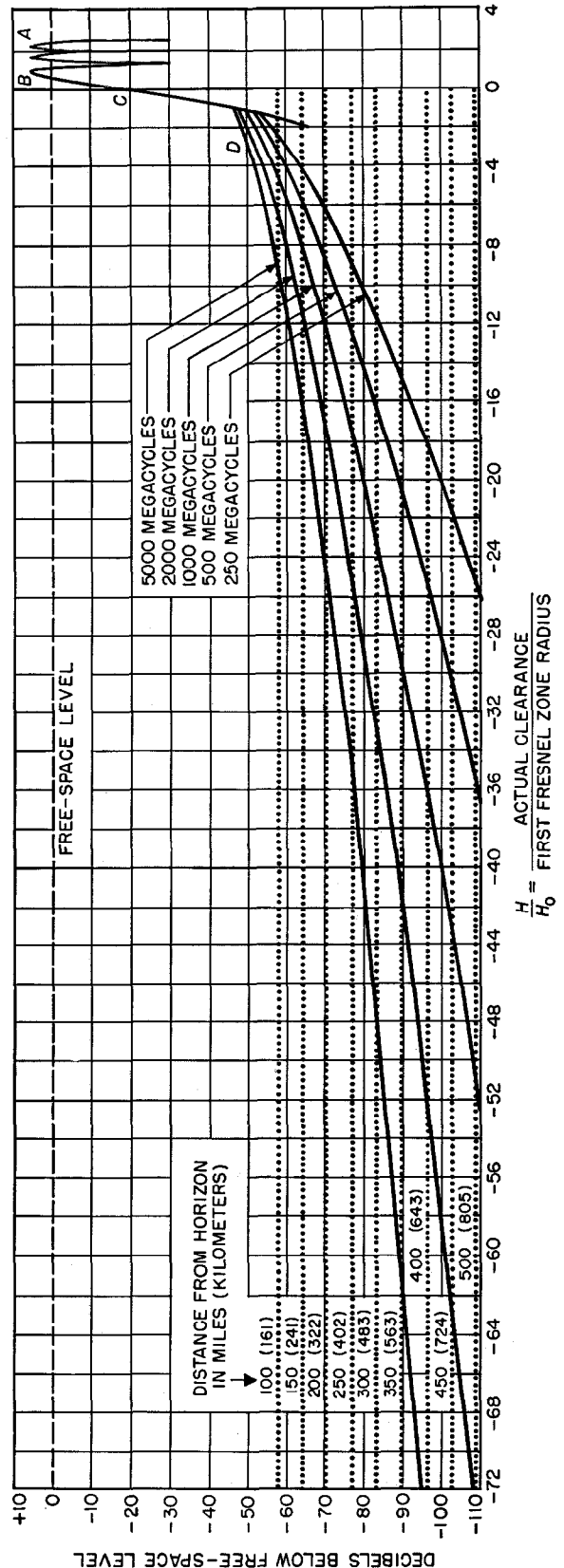

To be more precise, abscissas are determined by the expression

$$x = [H_t - (D^2/8R)]/H_0$$

on the right-hand side of the ordinate axis; on the left-hand side, the negative abscissas are equal to

$$(D^2/8R)/H_0.$$

Here, R is the radius of the earth and H_0 is the radius of the first Fresnel zone at distance D for equal antenna heights, expressed by $(\lambda D)^{1/2}$, where λ is the wavelength. H_t is the clearance of the line of sight over the surface of the earth.

The basic attenuation curve of Figure 3 can be separated into 4 different regions. In region *A*, the field distribution represents the somewhat academic case of the plane-earth-reflection assumption with a reflection coefficient equal to unity. Limits of maximum and minimum levels occur when clearance is equal to the first, second, and so-forth Fresnel radius. The theoretical minimum shows an infinite negative value resulting from exact cancellation of direct and reflected rays. In practice, reflection is not complete and minima, though often noticeable, are much less sharply determined. The spread of the beam due to the convexity of the earth intervenes also and the final result is an undulating curve around the free-space value.

Region *B* starts from the maximum that occurs when the clearance is equal to the first Fresnel zone radius and extends to the grazing incidence. Line-of-sight links are generally established in the vicinity of the maximum. Towards the grazing point, region *B* merges into region *C*, where the diffracted field prevails. The computation there is practically impossible even with the

Figure 4—Basic attenuation curve for tropospheric propagation similar to Figure 3 but using data of Bullington for D , the beyond-the-horizon curves.

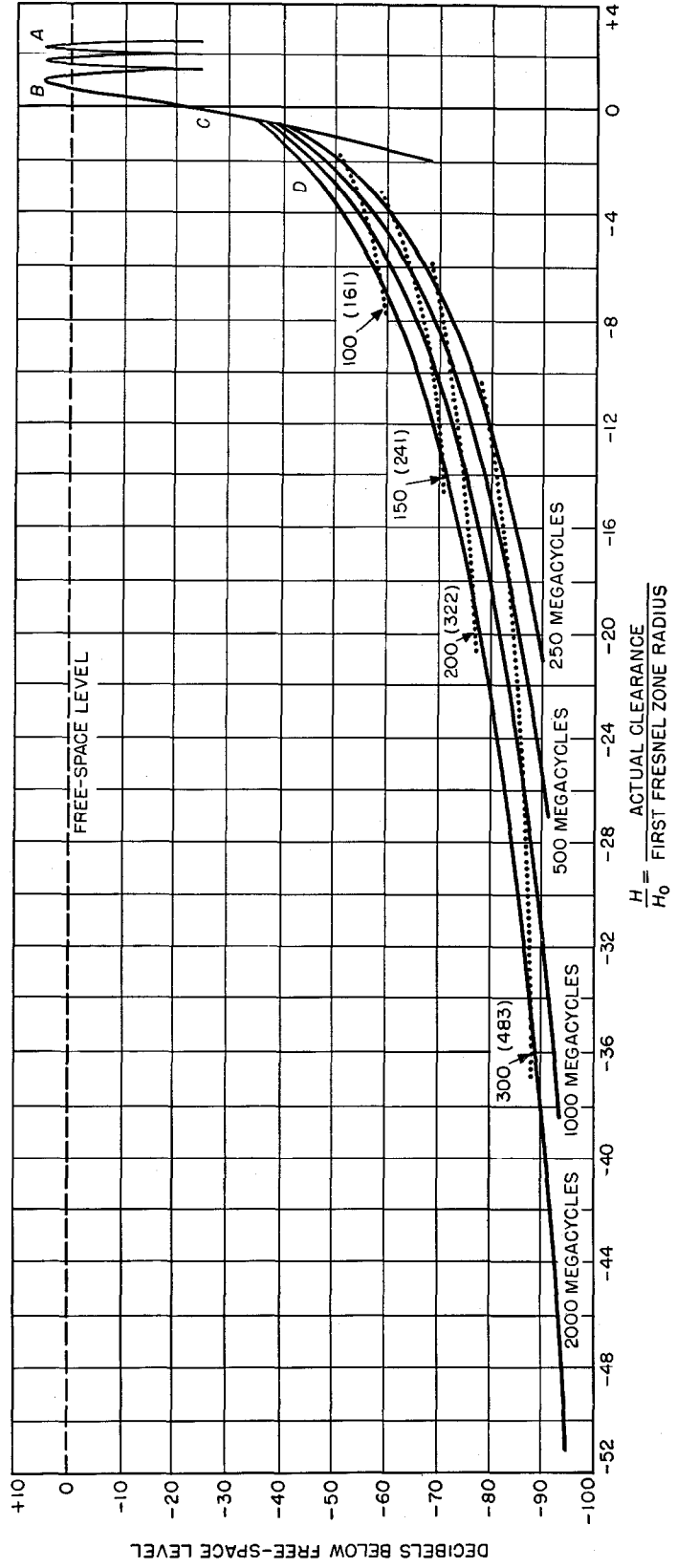

simplified assumption of an infinitely smooth earth. At some distance from the horizon, the task is less arduous and a line can be drawn that represents with a satisfactory approximation those cases in which antenna height is not significant and the earth surface asperities are small compared with the wavelength. Such a line has a steep slope and would lead to very small values of field strength did not another phenomenon intervene. This, however, must be the case as shown by region *D* of Figure 3, where values are plotted according to Davidson and Poté¹⁰ for propagation over midarctic land, as well as by region *D* of Figure 4, where values are plotted according to Bullington.⁸ These values are much larger than the smooth-earth theory would give for the diffracted field. They are closer to the values that the knife-edge theory of Fresnel and Cornu would indicate.

Whatever the final explanation may turn out to be, the experimental results are of such an order of magnitude that the transmitter power and antenna gain necessary to ensure reliable communication on the basis of Figures 3 or 4 become practically acceptable. The difference between the two sets of values in Figures 3 and 4 does not affect the design considerably; Davidson and Poté indicate variations with geographical location that would encompass Bullington's values. The latter, however, show a different dependence on frequency. The amount of available data is not sufficient yet to describe the facts more precisely. The basic attenuation curves of Figure 3 will, therefore, be considered hereafter as providing sufficient information on median values on which to base equipment design as a first approximation, but which, however, it will be advisable to confirm by experimental results on actual sites whenever possible.

4. Slow-Fading Phenomena

For line-of-sight propagation, experimental observations show that in many cases (over land particularly) normal propagation can be described by means of an atmosphere possessing a uniform gradient of refraction coefficient. The radio ray in this case does not propagate along a straight direction, but follows a smoothly curved line. The path can be predicted by assuming straight-line propagation and a corresponding

fictitious change in the radius of the earth. For the normal meteorological conditions in temperate climates, it is considered that this fictitious radius R is nearly equal to $\frac{4}{3}$ of the true radius. It is found, however, that conditions are often quite different, as experimental observations of the angle of arrival of the microwave beam at the receiving site have confirmed. It can be considered that a variation in fictitious radius from $\frac{4}{3}$ to 0.7 of the true radius would seem to be a conservative basis for predicting the amount of slow fading due to the change in refraction gradient.

Such a fading margin can be estimated by means of the basic attenuation curve. The change in fictitious radius corresponds to a change in apparent clearance and to a change in the value of the abscissas of Figure 3. Should, therefore, region *C* be applicable beyond the horizon, the figures given in Table 1 would be obtained.

TABLE 1
FADING MARGIN RELATED TO WAVELENGTH

Wavelength in Centimeters	Frequency in Megacycles	Fading Margin in Decibels	
		30 Miles (48 Kilometers)	48 Miles (77 Kilometers)
300	100	5	10
150	200	7	14
30	1000	15	31
15	2000	21	44
10	3000	26	53
6	5000	34	69

The figures given for 30 miles (48 kilometers) are indeed of the order of magnitude necessary for reliable line-of-sight communication. They can be improved in this case by a suitable choice of clearance for normal conditions, which results in a better location in region *B* of the basic attenuation curve. Such figures, however, would become prohibitive for beyond-the-horizon radio links to be established for distances of several hundreds of miles or kilometers.

If it is assumed that the change in basic refractive-index distribution can be explained in a similar fashion for region *D* of the attenuation curve (scatter propagation), it is found that the slope is so much smaller than in region *C* that the median value of the field should be quite stable. For instance, for 200 miles (320 kilometers) and a frequency of 2000 megacycles, a

change of fictitious earth radius from $\frac{4}{3}$ to 0.7 of the true value means a displacement of abscissa of 12.5 and a variation in signal strength of some 12 decibels. The above is advanced as a possible explanation of the relative stability of the median value of the field obtained beyond the horizon, a fact that has impressed all experimenters and is obviously of very great importance.

5. Rapid-Fading Phenomena—Diversity Reception

While the median value of the received signal remains rather stable, rapid and sometimes large variations are experienced most of the time. The fact has been reported by all experimenters and the following papers in this issue illustrate such conditions abundantly. This would render beyond-the-horizon links much less attractive were it not for the fact that the rate of fading remains of the order of magnitude of a few per second and can be corrected to a considerable extent by means of diversity reception without detrimental effects to the information transmitted. Diversity reception has been used frequently and with great advantage in line-of-sight microwave links, particularly in southern locations close to the sea or in swampy regions. It becomes almost indispensable in the case of microwave links beyond the horizon. This is the reason why the International System has placed particular emphasis on experimentation directed at the improvement of such methods. Companion papers in this issue will describe the results achieved as well as discuss more generally the problems of diversity reception and give an analysis of various possible diversity systems.

6. Transmission Level Versus Frequency

To conclude this brief and rather schematic summary of the various factors involved in the application of microwave propagation beyond the horizon, it is of interest to determine the influence of frequency on the transmission level necessary to achieve practically equal performances. This will now be attempted for the line-of-sight as well as for the beyond-the-horizon cases.

For line of sight, the various factors to be considered are represented in Figure 5. Curve 1 shows the basic variation of power received in free-space propagation versus frequency for

equal transmitted power and with isotropic antennas for both transmission and reception. This curve is derived from

$$P_1/P_2 = 16\pi^2(D^2/\lambda^2),$$

where P_1 and P_2 are the transmitted and received powers, D is the distance, and λ is the wavelength.

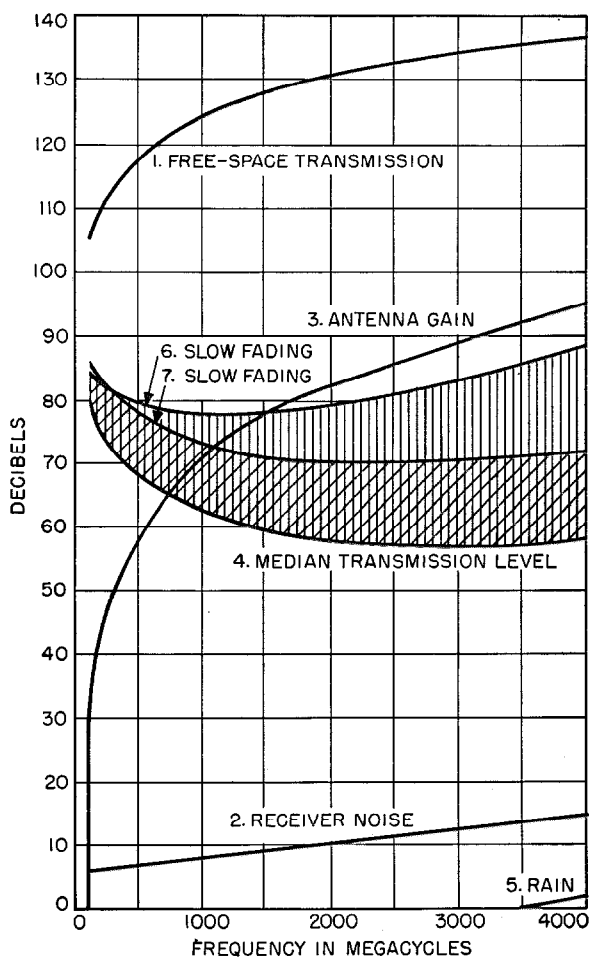

Figure 5—Transmission levels as a function of frequency for equal performance over a free-space line-of-sight 30-mile (48-kilometer) path. Curve 1 is the relative attenuation for transmission between isotropic antennas. Curve 2 gives the average noise figure of the receiver. Curve 3 is the combined gain of 10-foot (3-meter) paraboloidal transmitting and receiving antennas over isotropic antennas. Curve 4 is the median transmission level based on the sum of the effective losses of curves 1, 2, and 5 less the gain of curve 3, the effect of rain being given by curve 5. The margins that should be allowed for slow fading are indicated by curve 6 for the grazing-incidence condition and by curve 7 for the values given by Carl for 99-percent reliability.

Expressing D in miles and F in megacycles, this equation is equivalent to

$$10 \log (P_1/P_2) = 37 + 20 \log F + 20 \log D$$

and this relation leads to curve 1 for $D = 30$ miles (48 kilometers). The relative variation of level versus frequency is, however, obviously independent of the choice of D .

Curve 2 shows the variation of receiver noise figure versus frequency. Receivers with a low noise figure are easier to build at lower frequencies. A linear variation has been assumed between 6 decibels at 100 megacycles and 15 decibels at 4000 megacycles. This is in agreement with results currently achieved in modern receivers. Any improvement of the receiver noise figure at higher frequencies would be of considerable importance.

Curve 3 represents the antenna gain obtainable by means of paraboloidal reflectors over the free-space performance of isotropic antennas. This is established on the basis of equal effective antenna aperture. In fact, curve 3 is based on the computed gain of two identical 10-foot (3-meter) paraboloids with an illumination factor of 0.54. The relative variation of gain would be the same for any pair of such antennas having equal size and illumination factors.

At the extreme range of frequency considered, rain starts producing some attenuation as shown by curve 5. It is still, however, a minor effect. The variation of median transmission level versus frequency, curve 4, is now obtained by adding the ordinates of curves 1, 2, and 5 and subtracting the ordinates of curve 3. Curve 4 is for levels at the antennas and does not include the effect of losses in transmitter or receiver transmission lines or variation in transmitter efficiency. These factors could influence the shape of the curve considerably. They do not, however, represent basic factors of the same kind as those under consideration, inasmuch as technical progress changes them continuously.

Curve 4 shows a broad minimum for microwave frequencies, which is due to the high antenna gain obtainable. To provide a more-practical picture, it is necessary to account for the variation of median level due to the slow-fading phenomenon. This has been done in Figure 5 for two different assumptions; curve 6 provides for fading margins as determined above for

grazing incidence; the other takes values indicated by Carl¹³ as exceeded for only 1 percent of the time and averaged from numerous experimental reports available in the literature. The two resulting curves, 6 and 7, show that the advantage in favor of the higher frequencies tends to disappear in practice for the assumptions adopted.

Similar considerations have been applied in Figure 6 to the case of propagation beyond the horizon. There is nothing to change as regards curve 1, except that it has been plotted arbitrarily for a distance of 200 miles (322 kilometers); curve 2 is the same as before. Curve 3 gives the free-space antenna gain for two 30-foot (9.1-meter) paraboloids illuminated with an efficiency of 54 percent. However, the explanation of beyond-the-horizon transmission by the forward-scattering phenomenon indicates that full antenna gain should cease to be obtainable when the beam becomes so narrow as to limit the tropospheric volume where scattering can be produced. Experimental backing is available, though perhaps not fully convincing. Values of the loss incurred are reproduced on curve 4 as indicated by Davidson and Poté.¹⁰

Curve 5 represents the variation of median transmission level versus frequency for equal performances. To this should be added a margin for slow fading for which the shaded area gives an approximative representation, derived from the above considerations on the basic attenuation curve of Figure 3. There seems to be a slight advantage for frequencies between 1000 and 2000 megacycles with the assumptions taken.

It should be emphasized, however, that the data available at present are far too scanty and imprecise to attribute to these curves any other significance than that of being a starting point for a design that must be subject to experimental tests and verifications. The remark about transmission-line losses and transmitter efficiency is common with the line-of-sight case. The technical considerations involved in the final design differ, however, fundamentally because the

¹³ H. Carl, "Die Grenzen der Reichweite von Richtfunkstrecken für Vielkanallübertragung im Frequenzgebiet von 30...10 000 Mhz," *SEG-Nachrichten*, volume 3, number 4, pages 185-187; 1955; also "Range of Multichannel Radio Links between 30 and 10 000 Megacycles," *Electrical Communication*, volume 33, pages 168-173; June, 1956.

equipment for the line-of-sight conditions is essentially of low power and follows the leading trends of cable transmission engineering. Beyond-the-horizon propagation, though far less demanding in energy than was anticipated, necessitates

nevertheless powers of the order of 10 kilowatts or more. This is due to the beyond-the-horizon loss, which for 200 miles (322 kilometers), for instance, is equal to 70 decibels as shown in Figure 6 and remains substantially constant with frequency according to the basic attenuation curve of Figure 3 and, therefore, does not influence the relative variation of curves 5 or 6. A correction would be needed, however, if the data obtained by Bullington and given in Figure 4 were adopted. The beyond-the-horizon or scattering loss is the reason why much higher transmitter power is required than for line-of-sight propagation. The power demands are closer to those for broadcasting than for short-distance point-to-point systems.

It is, therefore, open to doubt whether the beyond-the-horizon technique will displace any of the present line-of-sight applications. Too many unknowns remain to pass judgment at this time with any degree of certainty, among which interference between links and with established communication systems is prominent. There are cases, however, where beyond-the-horizon propagation is of obvious usefulness. Without mentioning specifically the military applications that have been indicated in the daily press, it is evident that in many cases where line-of-sight transmission is impracticable, beyond-the-horizon propagation provides a new and powerful tool for radio communication.

Succeeding papers in this issue describe some of the experimental installations that have been made both in the United States and in Europe during the past couple of decades to acquire the necessary data on which our designs of commercial equipment for beyond-the-horizon applications are based.

One of these is the experimental link between Nutley, New Jersey, and Southampton, Long Island, that is described by Altman, Gray, Kandoian, and Sichak.¹⁴ Further experimentation over this path is presented by Altman and Sichak.¹⁵ Interesting investigations of nonoptical

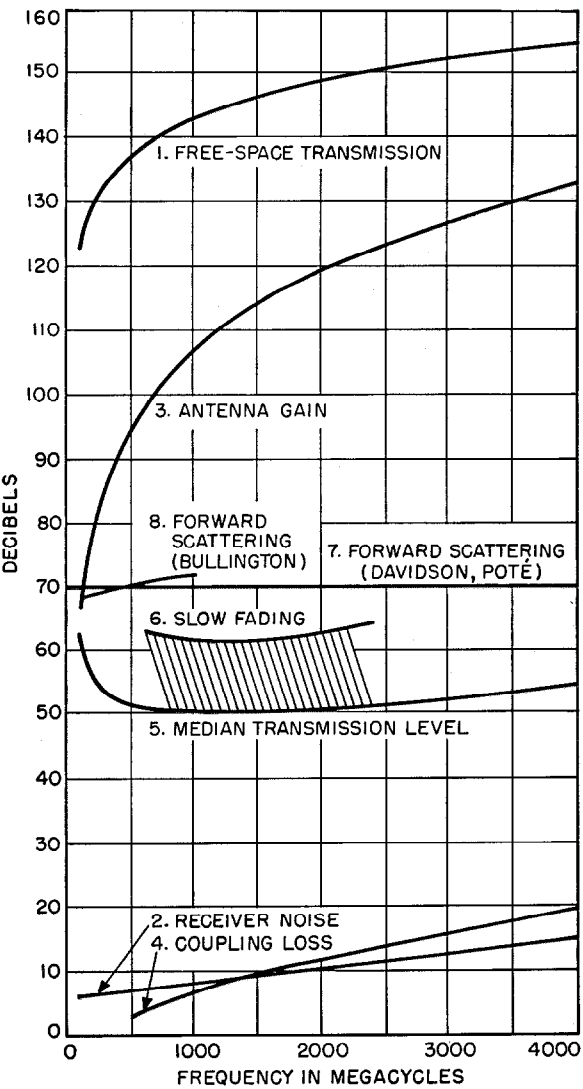

Figure 6—Transmission levels as a function of frequency for equal performance for beyond-the-horizon propagation over a 200-mile (322-kilometer) path. Curve 1 is the relative attenuation for transmission between isotropic antennas. Curve 2 is receiver noise. The antenna gain of curve 3 is for 30-foot (9.1-meter) paraboloids at transmitter and receiver. Curve 4 is the coupling loss between both antenna apertures and the scattering medium. Curve 5 is the median transmission level based on the sum of curves 1, 2, and 4 less the gain of curve 3. The margin for slow fading is given in curve 6. The loss in forward scattering (beyond-the-horizon loss) according to Davidson and Poté is shown by curve 7 and Bullington by curve 8.

¹⁴ F. J. Altman, R. E. Gray, A. G. Kandoian, and W. Sichak, "900-mc PTM Over-the-Horizon Radio Link," *IRE Transactions on Microwave Theory and Techniques*, volume MTT-3, pages 22-26; December, 1955; also *Electrical Communication*, volume 33, pages 143-150; June, 1956.

¹⁵ F. J. Altman and W. Sichak, "Simplified Diversity System for Beyond-the-Horizon Links," *Electrical Communication*, volume 33, pages 151-160; June, 1956.

propagation at very-high frequencies between Sardinia and Minorca in the Mediterranean Sea have been disclosed by Clara and Antinori.¹⁶

Among the commercial projects now being undertaken, particular attention is being directed at the establishment of a beyond-the-horizon link between Miami, Florida, and Havana, Cuba. This is a joint venture of the American Telephone and Telegraph Company and the International Telephone and Telegraph Corporation. The experimental tests reported by Stiles¹⁷ show that in general the expected results were obtained over this path although quite a few data are still incompletely accounted for at this time. The

¹⁶ J. M. Clara and A. Antinori, "Investigation of VHF Nonoptical Propagation Between Sardinia and Minorca," *IRE Transactions on Microwave Theory and Techniques*, volume MTT-3, pages 7-12; December, 1955; also *Electrical Communication*, volume 33, pages 133-142; June, 1956.

¹⁷ R. P. Stiles, "Over-the-Horizon Path-Loss Tests Between Florida and Cuba," presented at Symposium on Scatter Techniques of the Institute of Radio Engineers New York Section in New York, New York, on January 14, 1956.

commercial transmitting equipment is under construction by Federal Telecommunication Laboratories to meet the demands for television service and for a number of telephone channels to be obtained by frequency modulation and frequency-division multiplex operation.

Another important commercial link for which the preliminary propagation tests are now underway will provide communication between Puerto Rico and the Dominican Republic.

Whatever the path and various conditions specified, the importance of diversity reception is, as has been said, a prime consideration. The paper by Altman¹⁸ on the analysis of diversity configurations will, in this respect, be found of interest. The article by Carl¹³ discusses the limit ranges of multichannel radio links beyond the horizon in terms of available equipment and quality requirements.

¹⁸ F. J. Altman, "Configurations for Beyond-the-Horizon Diversity Systems," *Electrical Communication*, volume 33, pages 161-164; June, 1956.

Beyond-the-Horizon 3000-Megacycle Propagation Tests in 1941

By ANDRÉ G. CLAVIER and V. ALTOVSKY

Laboratoire Central de Télécommunications; Paris, France

THEORETICAL and experimental studies of the applications of electromagnetic waves shorter than 20 centimeters (frequencies above 1500 megacycles per second) have been pursued by laboratories of the International System since 1929. In 1931, a demonstration¹ was given between Calais and Dover over the English Channel of a point-to-point line-of-sight 1700-megacycle radiotelephone link. In 1934, a commercial circuit,² the first of its kind, was installed on the same frequency be-

¹ "Micro-Ray Radio," *Electrical Communication*, volume 10, pages 20-21; July, 1931.

² A. G. Clavier and L. C. Gallant, "Anglo-French Micro-Ray Link Between Lypne and St. Inglevert," *Electrical Communication*, volume 12, pages 222-228; January, 1934.

tween the coastal airfields of Lypne in England and Saint Inglevert in France.

The experiments to be described were undertaken by Laboratoire Central de Télécommunications under a contract with the French Department of Defense in 1941 to determine the laws of propagation of centimetric electromagnetic waves. The experiments were conducted around Toulon, in the south of France, from May to December of that year. Circumstances prevented an immediate disclosure, but it is thought that the report remains of sufficient interest to warrant publication at this later date.

Figure 1—The transmitter produced a maximum of about 10 watts of power at 3000 megacycles.

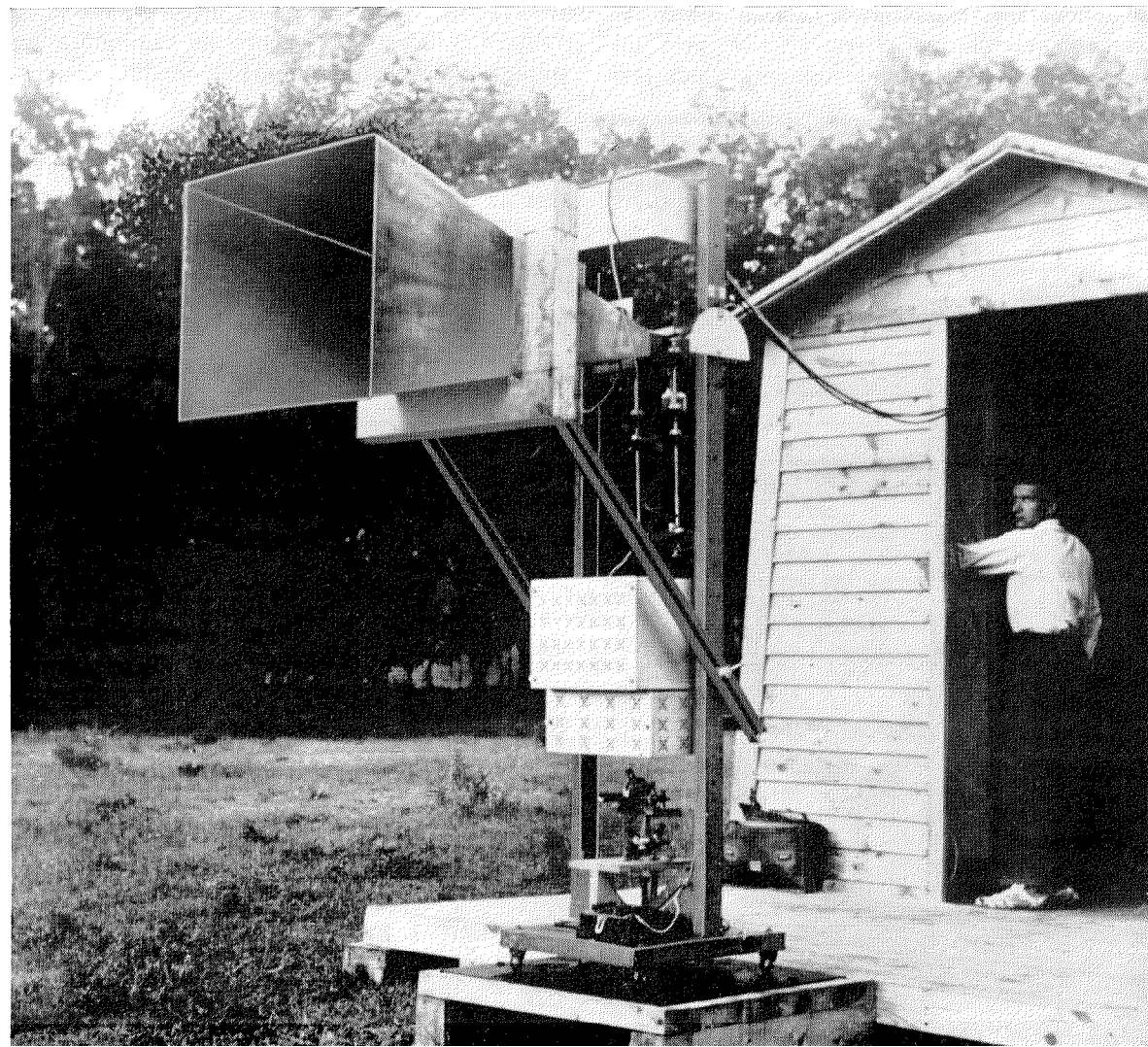

1. Equipment

It was desirable to obtain as much power in the transmitter as was available at the time. The tube utilized was of the klystron type³ and produced a power of the order of 10 watts at 3000 megacycles. The transmitter is shown in Figure 1. The power supply was inside the shack; it provided the required 80 milliamperes at 2000 volts with a voltage regulation within 1 part in 1000. Modulation was obtained by means of an inductance inserted in the klystron plate circuit. The antenna was of the horn type and a small auxiliary dipole associated with a thermocouple and microammeter was provided to check the radiated power. Frequency modulation was adopted as it permitted the use of wide-band frequency deviation to provide a signal-to-noise improvement that would increase the effective experimental range.

Optimum conditions for the frequency modulation of klystrons were investigated. Characteristic curves of radio-frequency output versus anode voltage were plotted. They showed that the most-favorable conditions are found around the top of the characteristic curves where the frequency-modulation characteristics vary linearly with changes in anode voltage without pro-

ducing objectionable amplitude modulation. For example, the curves in Figure 2 show that for a range of ± 70 volts around an operating voltage of 1900, the frequency varies by ± 1.12 megacycles while the amplitude remains constant within ± 1 percent. These curves had to be plotted under dynamic conditions; otherwise, the results were affected by overheating phenomena. Consequently, it was necessary to develop a suitable method of measuring accurately the frequency excursions under dynamic conditions.

In conducting experiments over radio links, it is necessary to ensure that the transmitter continues to operate within suitable limits. An aperiodic detector coupled to the oscillator and capable of responding to amplitude variations was used to check on amplitude modulation. The transmitter was frequency modulated with a 1000-cycle tone and the output of the detector went to an oscilloscope where the residual amplitude modulation could be monitored. With the proper operating point, that is, along the flat region of the amplitude-voltage characteristic curve, the amplitude variations around the operating point are in the same direction for both positive and negative excursions of modulating voltage, the resulting amplitude-modulation frequency obtained at the output of the detector will thus be twice that of the modulating tone. This method of visual indication proved to be very accurate.

³ A. G. Clavier and G. Phelizon, "Paris-Montmorency 3000-Megacycle Frequency-Modulation Radio Link," *L'Onde Electrique*, volume 26, pages 331-344; August-September, 1946; also *Electrical Communication*, volume 24, pages 159-169; June, 1947.

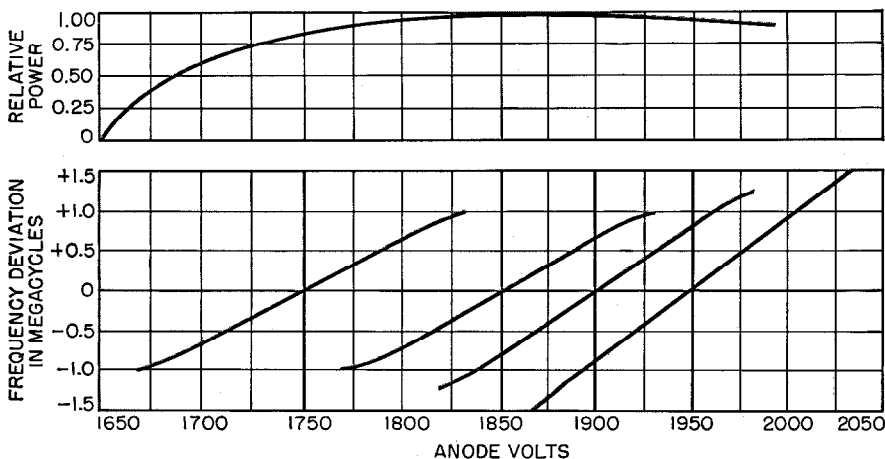

Figure 2—Dynamic characteristic curves for frequency modulating a klystron tube by variation of anode voltage. The upper curve shows power output as a function of anode voltage and the lower curves are for frequency deviation from the operating values of 1750, 1850, 1900, and 1950 volts.

A superheterodyne receiver was used. The input circuits utilized resonant cavities of cylindrical shape. When the inside volume of a cavity is a perfect cylinder, it can be shown theoretically that for certain modes the resonant frequency is entirely controlled by the diameter. Such a cavity behaves like a very-high- Q resonant circuit. If the height of the cylinder is of the same order of

magnitude as the diameter, the values of Q are similar to those obtained with crystals. In addition, the deformation of such a volume obtained by varying the length of a suitably located plunger causes a variation of the resonant frequency without materially affecting the quality of the circuit. With this method, the selectivity characteristics of 3000-megacycle tuned circuits are comparable to those of crystals. The tuning range obtained with the plunger was of the order of 600 megacycles. This construction, shown in Figure 3, may include slots or other openings in the cylinder walls as a convenient means of coupling and constitutes a fundamental element of the microwave circuits.

A special diode mixer was developed. It was a tube of cylindrical structure with a very small

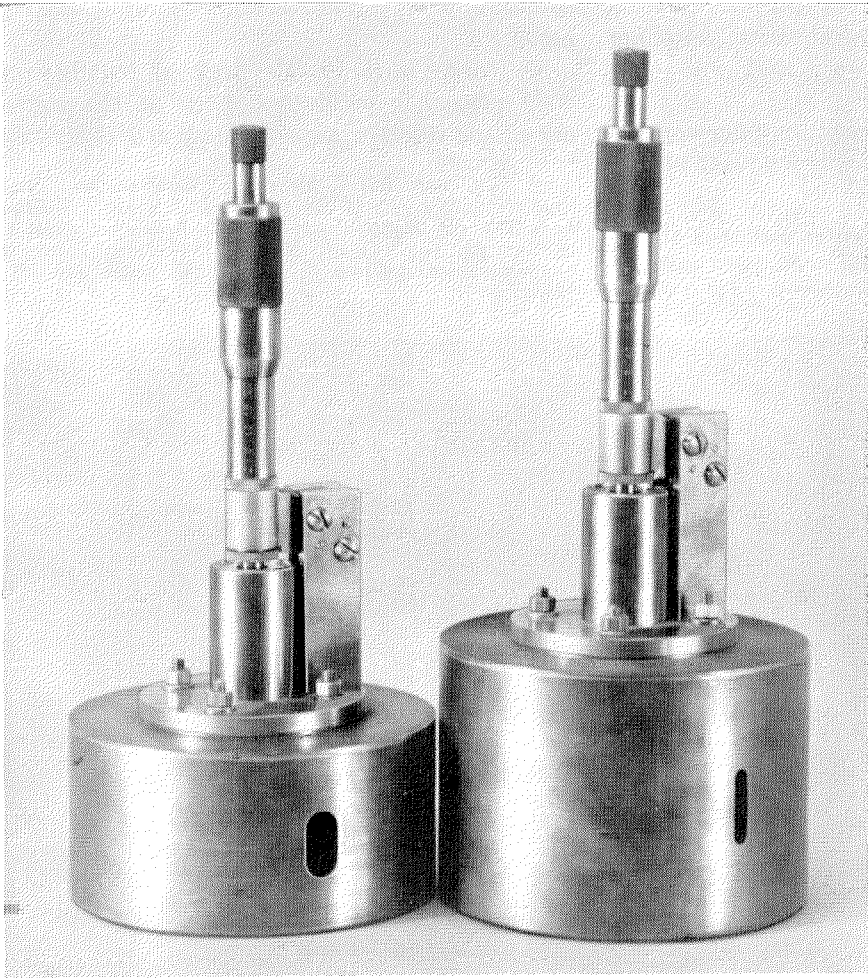

Figure 3—Resonant cavities with adjustable plungers could be tuned over a range of 600 megacycles in the 3000-megacycle regions. The slots in the walls of the cylinders are for coupling.

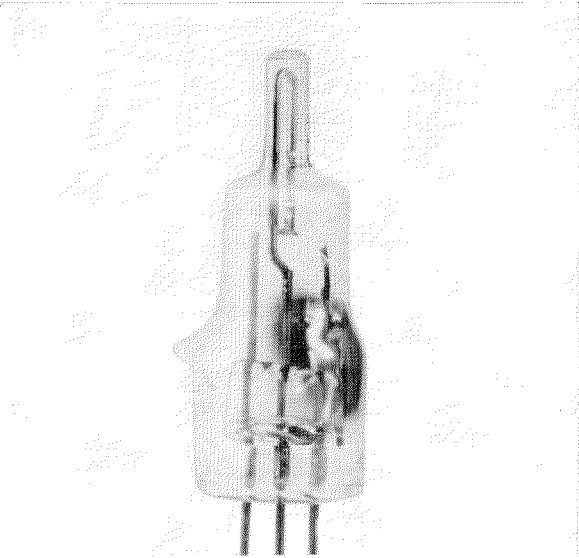

Figure 4—Diode used as a mixer in the receiver. The loop at the top was inserted through the hole in the wall of a resonant cavity to provide coupling.

plate-to-filament spacing to minimize the effect of the electron transit-time as much as possible. It may be seen in Figure 4. This diode also contains 2 transmission lines. The one entirely looped within the upper part of the envelope was specially designed to be coupled to the resonant cavity through the hole in the wall of the cavity. The other, composed of 3 wires, was used for supplying the operating direct voltages to the electrodes as well as the local-oscillator voltage; it also constituted the intermediate-frequency output circuit at 40 megacycles.

The local oscillator was of the positive-grid

type. It was found necessary to improve this oscillator with respect to frequency stability and ease of adjustment. This was achieved by coupling to the positive-grid line a variable-frequency resonant cavity of the type described above.

The previous positive-grid oscillator showed a frequency variation of the order of 1 megacycle for a plate-voltage variation of 1 volt. After the resonant cavity was coupled to the grid line, the frequency variation was reduced by a factor of approximately 60. Furthermore, the frequency was controlled by the mere tuning of the resonant cavity.

The combination of these various elements constituted the frequency converter, which is shown in Figure 5.

The second part of the receiver contained the conventional elements of a frequency-modulation receiver: an intermediate-frequency amplifier chain, limiter, discriminator, and audio-frequency amplifier.

The intermediate-frequency amplifier consisting of a 40-megacycle chain was followed, after a

second conversion, by a 9-megacycle amplifier. Care was exercised to obtain within the band a very constant amplitude response and a linear phase response. This is evident from Figure 6.

The second intermediate-frequency amplifier was followed by a limiter to furnish to the discriminator a constant-amplitude signal independent of the level of the input signal provided it was higher than the operating threshold. As a result, the amplitude variations of the carrier are eliminated as well as the amplitude variations caused by superimposed noise. The dynamic characteristic can be seen in the oscillogram of Figure 7.

The demodulator consisted of a frequency discriminator made up of 2 magnetically coupled circuits. The characteristic reproduced on the oscillogram of Figure 8 shows that it was possible to obtain a very linear section in the operating region.

To compensate for the lack of stability of 3000-megacycle oscillators, both at the transmitter and receiver, a special method of reception⁴

Figure 5—The frequency-converter portion of the receiver. The diode mixer is coupled to the input cavity at the right and to the local-oscillator cavity at the center.

⁴A. G. Clavier and V. Altovsky, "Simultaneous Use of Centimeter Waves and Frequency Modulation," *Bulletin de la Société Française des Electriciens*, Series 6, volume 4, number 35, pages 1-23; March, 1944; also *Electrical Communication*, volume 22, number 4, pages 326-338; 1945.

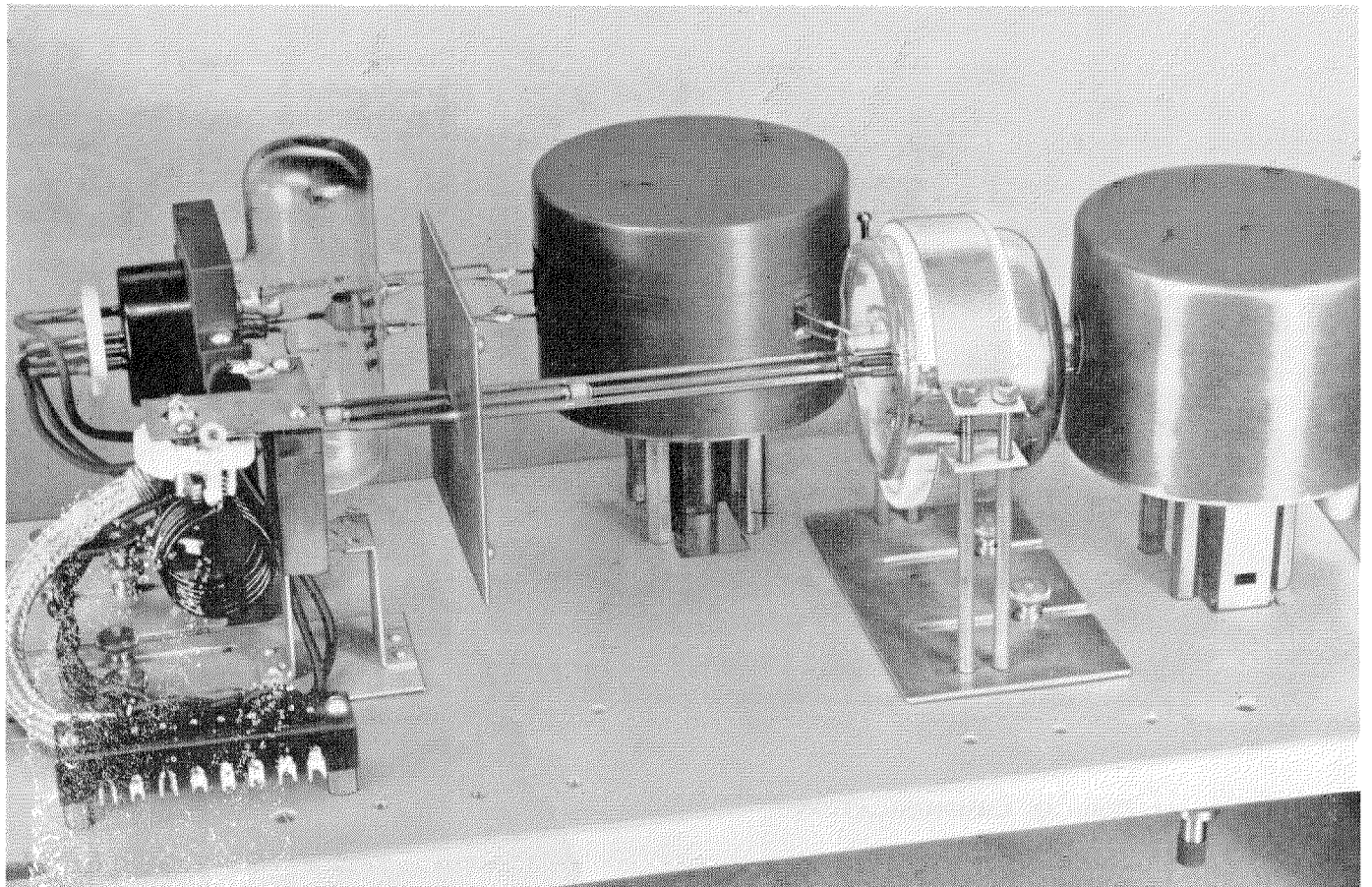

was devised. This method was named "reception by frequency compression." It consists of applying the output of the discriminator after proper

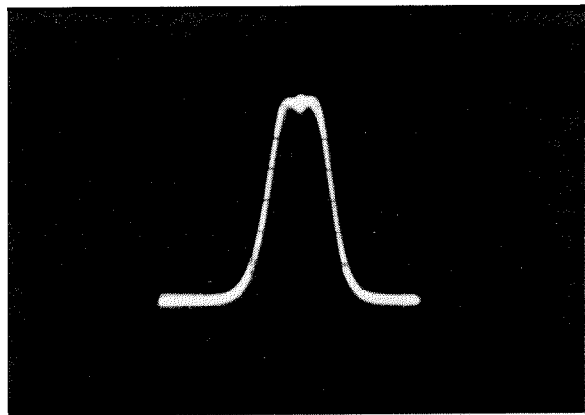

Figure 6—Oscilloscope showing amplitude versus frequency for the intermediate-frequency chains of the receiver.

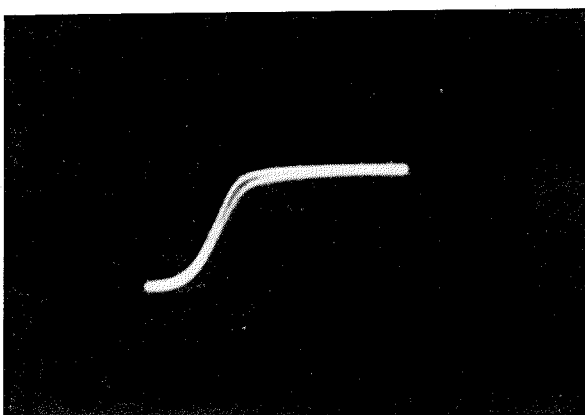

Figure 7—Characteristic of the limiters that followed the 2 intermediate-frequency amplifiers.

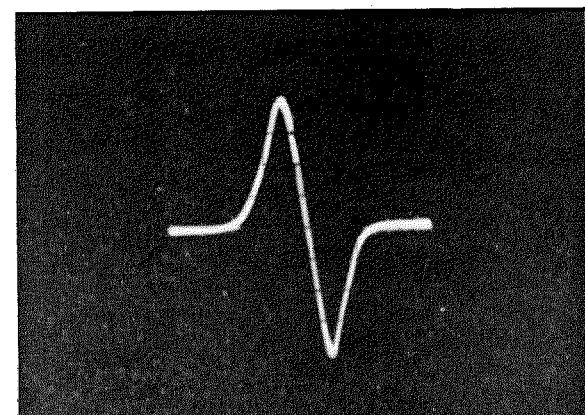

Figure 8—The frequency discriminator provided a highly linear section in the operating region.

amplification to the plate of the positive-grid local oscillator. The frequency delivered by this positive-grid oscillator, even when coupled to a stabilizing cavity, varies with its plate voltage and produces frequency modulation. The intentional frequency modulation of the local oscillator by the discriminator output was applied in opposite phase to the incoming modulation. In this manner, the frequency deviation of the local oscillator was reduced for a given incoming voltage variation. For example, a frequency compression of 10 reduces the deviation from 1 megacycle to 100 kilocycles. The bandwidth of the amplifier can be kept within conventional values and the noise level of the receiver is reduced by the narrowing of the bandwidth.

Care should be exercised, however, to ensure that the modulation voltage applied to the plate of the local oscillator is always in opposite phase with respect to the incoming modulation. If this condition does not obtain, the system loses all stability. The analogy with negative feedback used in many amplitude-modulated amplifiers is a useful guide in determining the optimum operating conditions. The two problems lead to similar types of equations and a transposed Nyquist condition is applicable.

The use of frequency compression resulted in a very great ease in the adjustment of the local oscillator. For a bandwidth of 200 kilocycles, it was possible to vary the local-oscillator frequency by 8 megacycles without losing the incoming signal at the output of the receiver. In addition, the effect of disturbances caused by the movement of surrounding objects including the operators was eliminated even when the shields were removed. Finally, the quality of the transmission benefited from the reduction of distortion.

2. Test Program

The equipment described above was the result of extensive laboratory work. It was mandatory to test it under actual operating conditions to evaluate its merit and to make final adjustments.

2.1. RADIATION PATTERNS OF ELECTROMAGNETIC HORNS

To study the coupling of the transmitter and receiver to their horns, it was necessary to use a flat area sufficiently large and open to be free

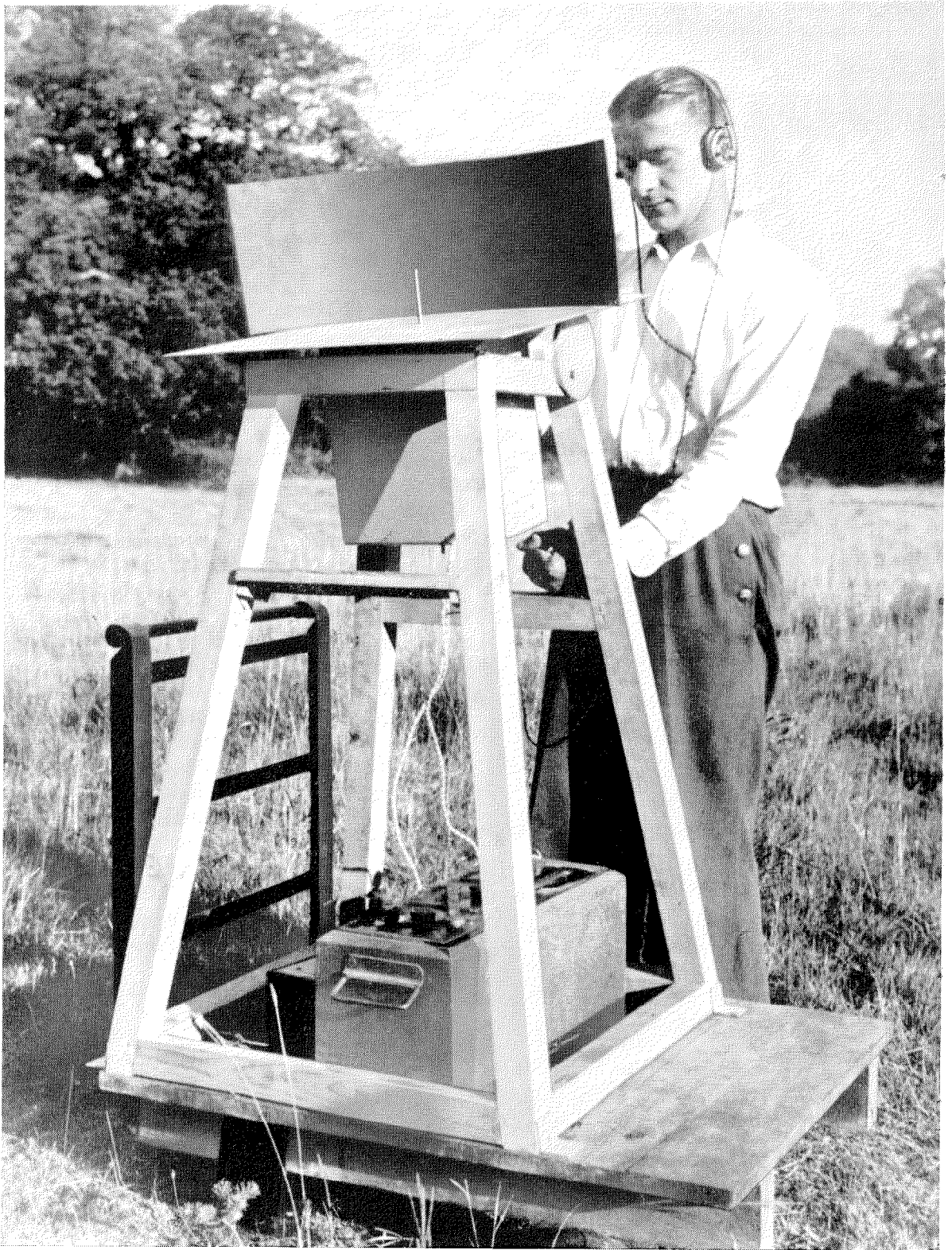

Figure 9—Receiver used for checking the transmitter and its radiating horn.

of interferences caused by reflections from surrounding obstacles. The tests were conducted on the Hyeres golf course from June 24 to July 31, 1941.

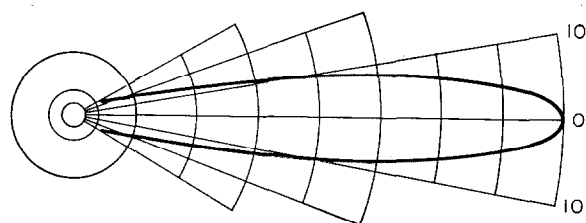

Figure 10—Horizontal-plane radiation pattern of transmitting horn.

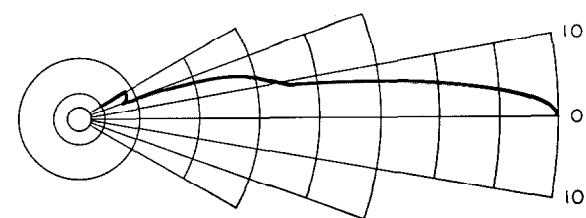

Figure 11—Vertical-plane radiation pattern of transmitting horn.

Figure 9 shows the measuring receiver equipped with a parabolic reflector that protected the receiving antenna from interference caused by the operator. The transmitting horn was built with angles of 25 degrees for the horizontal plane and 23 degrees for the vertical plane. The dimensions of the aperture were 770 by 604 millimeters (30.3 by 23.8 inches). The horizontal-plane diagram of Figure 10 shows a beam width of 14 degrees at the half-power values. The vertical-plane diagram of Figure 11 shows 11.4 degrees. There was no lateral lobe in the horizontal-plane diagram. In the vertical-plane diagram, there were no parasitic lobes, either, but slight bumps were present on the sides.

2.2 RECEIVER ADJUSTMENT

The preliminary tests for adjustments were conducted near Toulon between Fort Coudon, where the transmitter was located, and Fort Saint Louis, where the receiver was installed. The site selected for the transmitter was Fort Coudon, located north of Toulon at an altitude

of 700 meters (2296 feet). One of the rooms in the barracks was fitted for this purpose by the engineers corps of Toulon. The power supply for the transmitter was provided by a diesel-engine-driven generator that may be seen in Figure 12 in its location in an inside court of the fort. The electromagnetic horn of the transmitter can be seen in Figure 13 emerging from one of the windows of the barracks. The orientation of this window



Figure 12—Power supply for the transmitter.

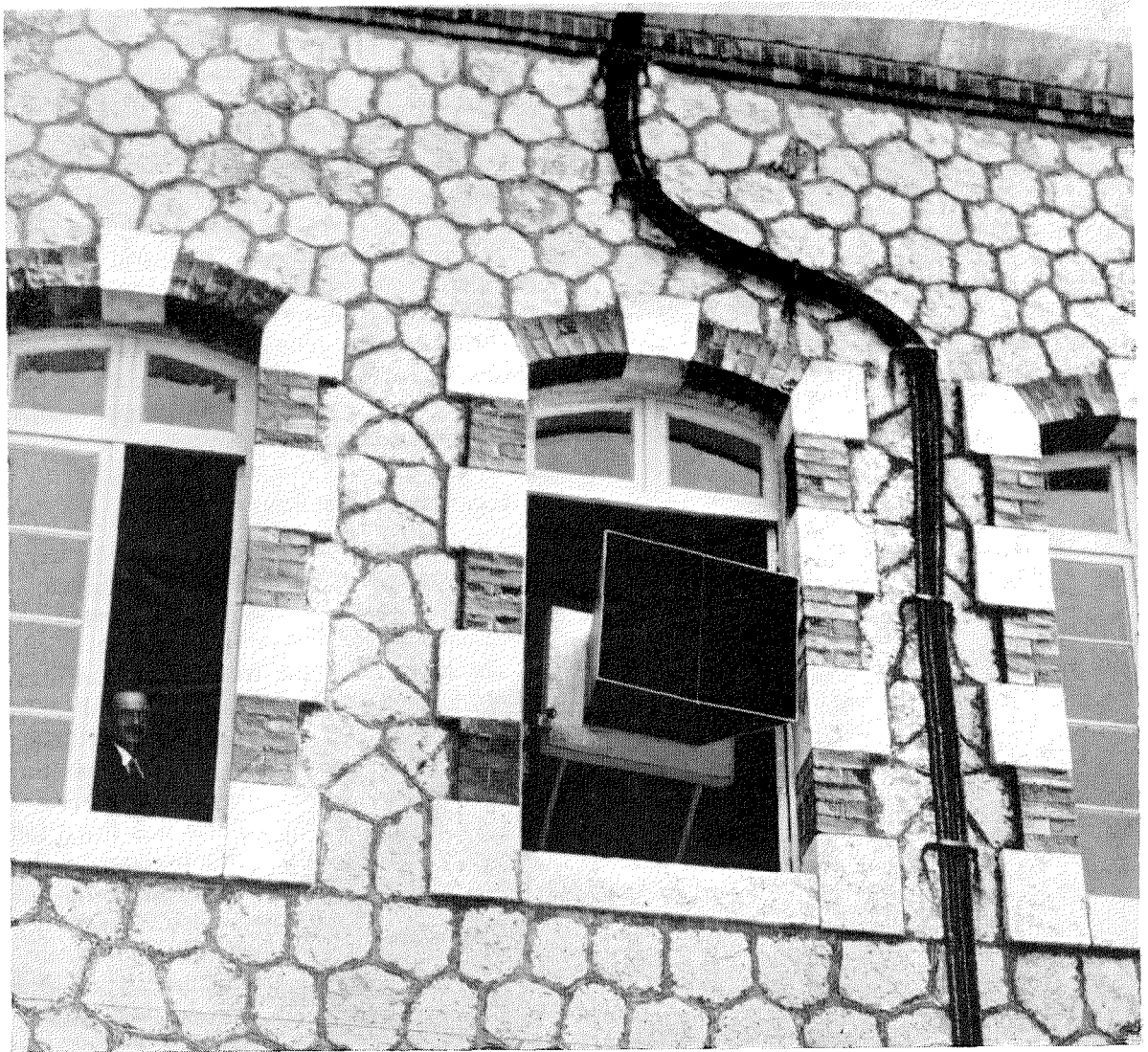

Figure 13—Transmitting horn extending through a window of the barracks at Fort Coudon.

made it possible to direct the beam between azimuthal angles of 218 to 262 degrees.

Figure 14 is a view from Fort Saint Louis with Coudon hill, where the transmitter was located, at the horizon. As the crow flies, the distance from the transmitter to the receiver was approximately 11 kilometers (6.9 miles).

As soon as the frequency-compression receiver was adjusted and its calibration completed (August 2, 1941) the link was put in operation. The results achieved could be considered as a definite step in the development of the centimeter-wave technique that only a year before seemed to be far from any practical application.

The interest found in these experiments was evidenced by numerous visits of officials of the National Defense Services and the Administration of Posts, Telegraphs, and Telephones.

3. Propagation of 10-Centimeter Waves

The length of the experimental link between Coudon and Fort Saint Louis was insufficient to show any influence from meteorological conditions. In fact, no perturbations of this kind were recorded, either as a function of time of day or of good or bad weather during the entire period of tests conducted from August to December of 1941.

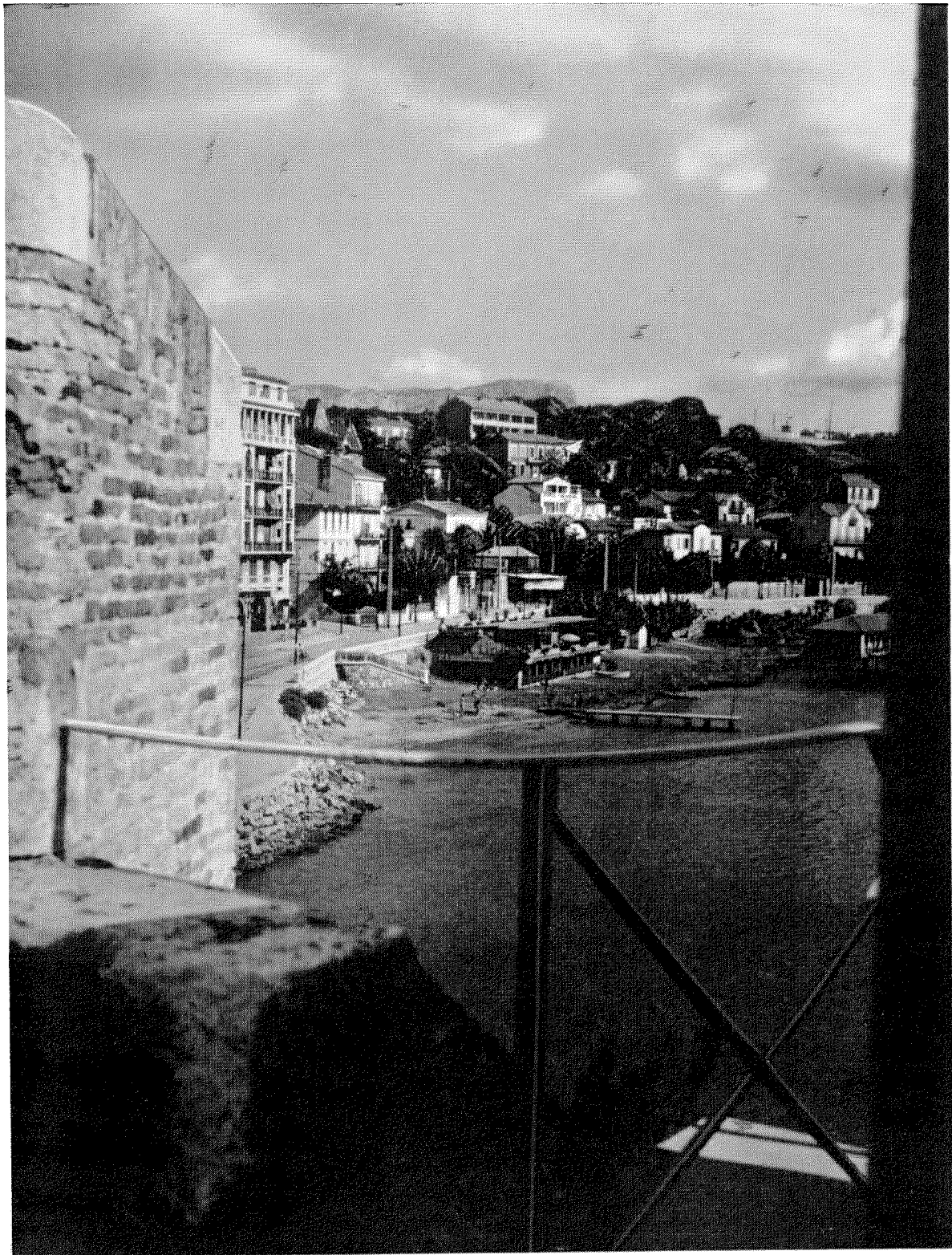

Figure 14—Coudon Hill, where the transmitter was located, is at the horizon as seen from Fort Saint Louis.

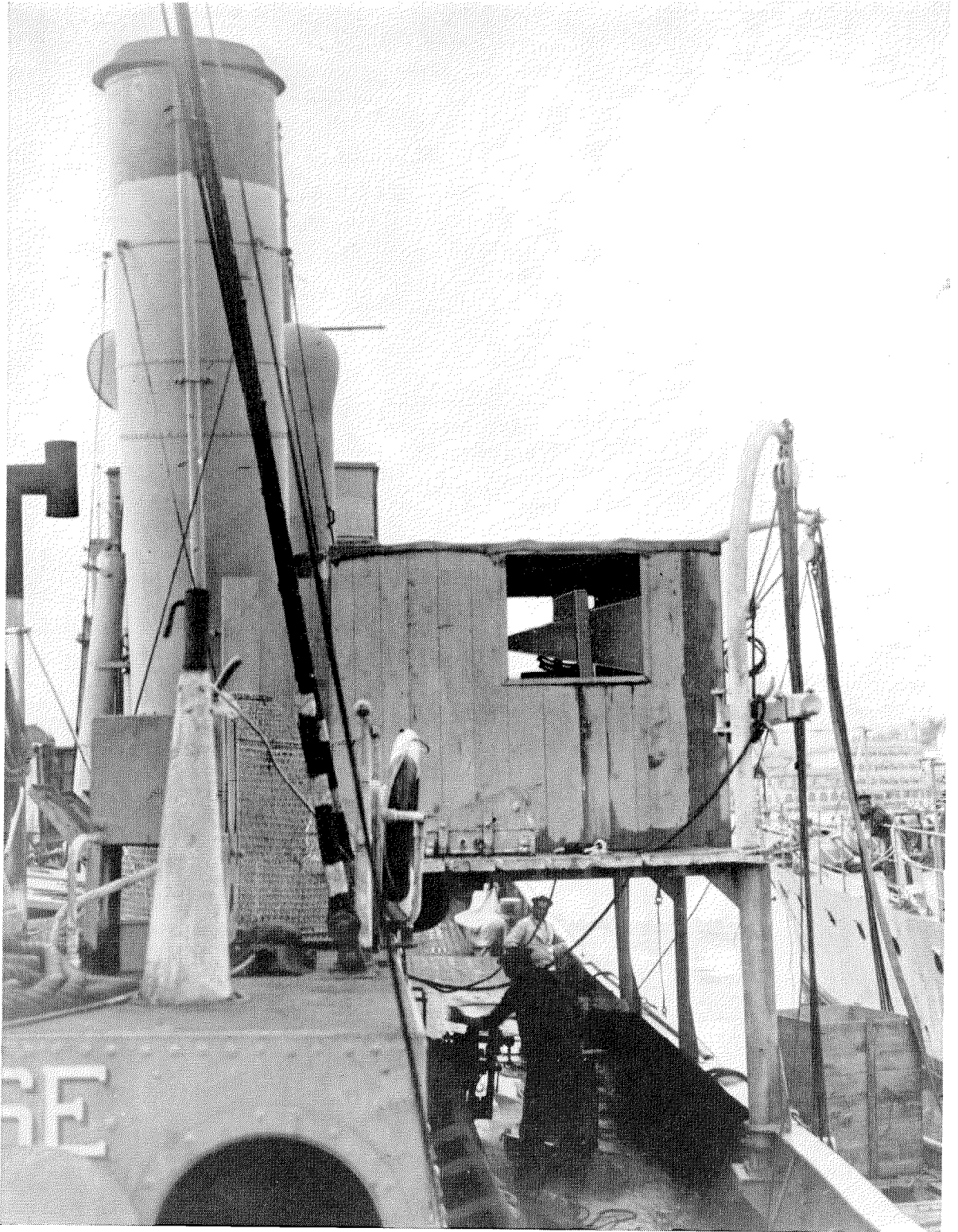

Figure 15—This cabin was built on the *Havraise* to shelter the receiver, the horn of which is visible through the windows. By providing 3 windows, the horn could always “look” at the transmitter.

To study the laws of propagation, it was therefore necessary to operate over a much-longer distance. Experiments were planned to study the propagation between the transmitter at Coudon and locations at sea on or beyond the horizon.

With respect to propagation to the horizon, one could expect that the link would operate without any difficulty as long as line of sight was maintained. This was experimentally verified. During the 6 trips made in September, October, November, and December of 1941, the signal was always received as soon as the beam was intercepted and up to the distance of about 100 kilometers (54 nautical miles) that separates Coudon from the line of horizon. At that distance, the gain margin of the receiver was found to be approximately 35 decibels, an order of magnitude to be expected according to the free-space propagation laws. This gain margin shows that at that distance, the transmitter power could have been reduced by a factor of 2500 under normal conditions or that a range of 5000 kilometers (2700 nautical miles) could be achieved with the power available over a line-of-sight path. It must be pointed out in addition that the use of frequency modulation with large deviation increased the signal-to-noise ratio to a value of approximately 60 decibels up to the maximum range. Such a signal-to-noise ratio ensured a quality comparable to the better telephone circuits. The sizeable gain margin obtained at the horizon made it possible to study the phenomenon of propagation of centimetric waves beyond the horizon. For this purpose, a series of trips aboard various war vessels as well as the cable ship *Ampère* of the Posts, Telegraphs, and Telephones Administration were made.

The receiver was first installed on board the *Havraise* in a cabin specially erected toward the stern. This cabin was provided with openings in 3 of the sides to permit the receiving horn to be directed at the transmitter regardless of the route being sailed. Figure 15 gives an idea of the location of the experimental cabin and its interior arrangement.

The courses of the following 6 trips are shown on Figure 16.

1. On board the *Havraise* from Toulon to the Spanish coast following the 238-degree azimuth from Coudon on September 18, 1941.

2. The return trip over the same azimuth on September 19 and 20, 1941.

3. On board the *Curieuse* from Toulon to Oran following the 236-degree azimuth until loss of contact. This trip took place on October 7, 1941.

4. On board the *Havraise* from Toulon to Port Vendres along the 238-degree azimuth on October 28, 1941.

5. On board the *Havraise* from Port Vendres to Toulon following the 254-degree azimuth on November 7 and 8, 1941.

6. On board the cable ship *Ampère* towards Philippeville in Algeria on the 210-degree azimuth on December 19, 1941.

During these trips, two clearly different types of propagation beyond the horizon were revealed.

For the first trip, the chosen azimuth of 238 degrees toward the Spanish coast pointed at an opening between two hills as seen from Coudon. The distance of more than 250 kilometers (135 nautical miles) to the Spanish coast seemed to constitute an entirely adequate area of operation. The trip took place in good weather, rather warm and with a calm sea, following a period of calm weather. The transmission was started at 1128 hours (11:28 A.M.) in the morning before sailing time and was planned to continue until 2045 hours (8:45 P.M.). Transmission of speech and 1000-cycle tone were alternated. At the receiver, the transmission was monitored with a loud-speaker, while the field variations were read on meters connected before the limiter of the frequency-modulation receiver.

Up to the horizon, the variations of the field were of small amplitude showing approximately the same periodicity as the slow motion of the ship. As soon as a distance of a few miles beyond the horizon was reached, substantial variations were observed with the amplitude of the maximums reaching the same order of magnitude as those measured at the horizon and with marked minimums of short duration. These minimums, however, did not reach the threshold level of the limiter so that the reception was unaffected by these variations and had the same quality as that experienced 10 kilometers (5.4 nautical miles) from the transmitter. However, the amplitude variations of the incoming signal might have seriously deteriorated the performance of an amplitude-modulated signal. The phenomenon of variation was followed on the meters while the

ship continued in her original direction. The results of measurements are shown in Figure 17.

It was verified that by orientating the directive receiving horn it was possible to find the direction of the transmitter both within and beyond the horizon. The measurements were stopped at the time set in the program. The ship was then located at a distance of 190 kilometers (103 miles) from the transmitter and 80 kilometers (43 miles) beyond the horizon, which was passed at 1600 hours (4:00 P.M.). There was still a sizable gain margin of received signal above the noise level. This experiment did not per-

mit an evaluation of the maximum range of transmission.

The following day the return trip (2) took place; the weather was still fair. The ship retraced the path followed on the outbound trip starting from a point as close as possible to the Spanish coast, a distance of 232 kilometers (125 miles) from the transmitter. Contact was established without difficulty at 2030 hours (8:30 P.M.). Variations of the same type as those observed the previous day were recorded until the horizon was reached. The trip was completed at 0800 hours (8:00 A.M.) on September 20, 1941.

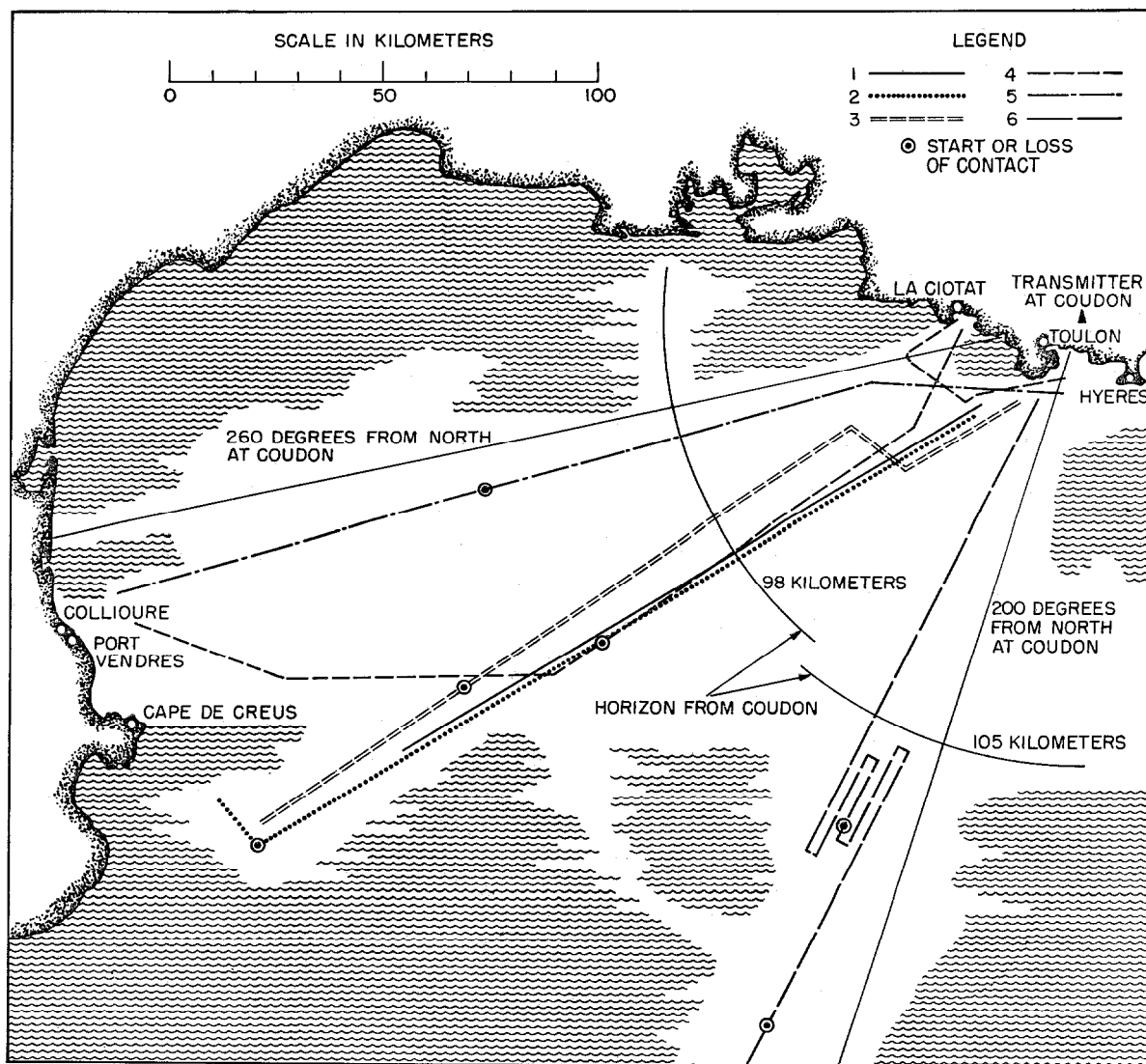

Figure 16—The courses of the 6 trips taken to test propagation from the transmitter at Coudon. The transmitter was moved for the 6th trip and its horizon was increased to 105 kilometers (57 nautical miles).

The results from these first 2 experiments, which were in conflict with what was expected from the theoretical concepts, stimulated great curiosity and led to further tests.

The following trip (3) on board the *Curieuse*, on whose stern a new cabin had been installed, took place on October 17th, starting at 1300

was kept in operation for a long period of time after the disappearance of the signal, no further reception occurred during this trip.

Tests were resumed aboard the *Havraise* on October 28th and on November 7th and 8th. Efforts were made to recreate, as accurately as possible, the same experimental conditions that

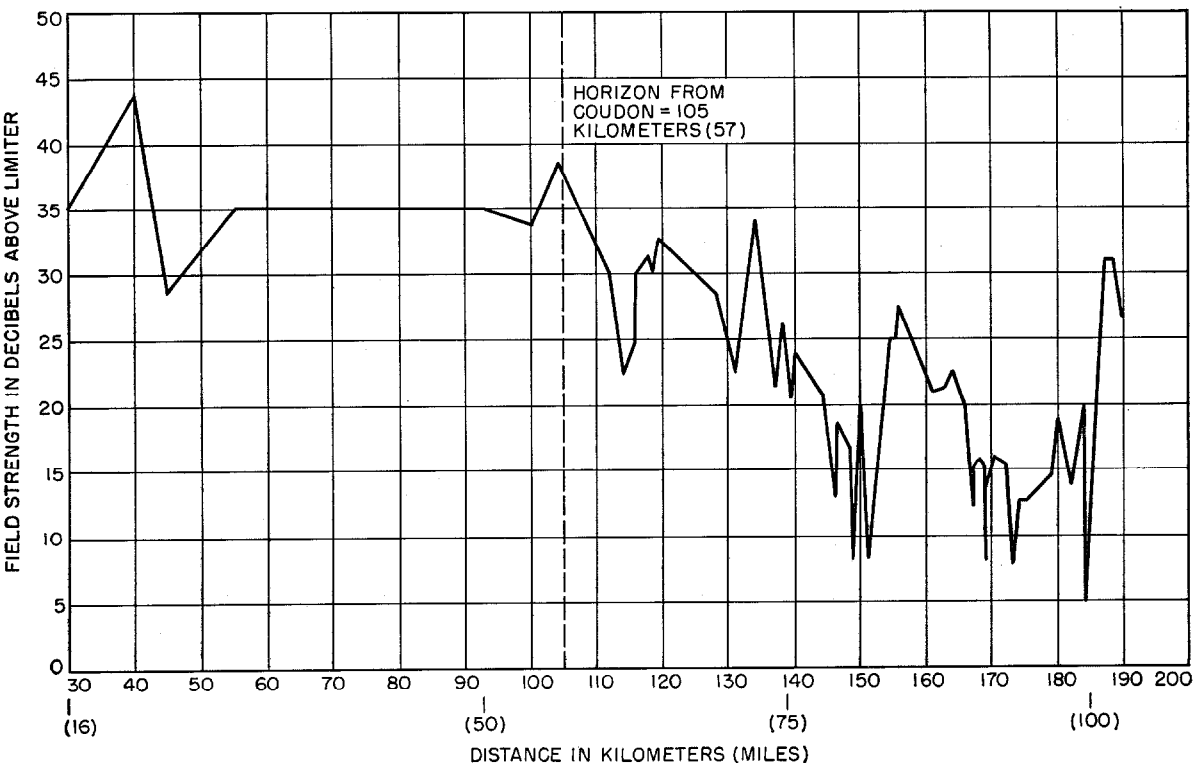

Figure 17—Field strength versus distance on the first of the 6 trips in the series. The distance to the horizon takes into account the height of the shipboard receiving antenna.

hours (1:00 P.M.). The direction followed differed very slightly from that of the previous trips. The long leg of the journey was started at 1630 hours (4:30 P.M.). The weather was far from being fair and the sea was moderately rough. As previously observed, no phenomenon worthy of note occurred until the horizon was reached. Beyond the horizon, however, a steady and comparatively rapid decrease of the signal strength was observed instead of the type of variation recorded on the first round trip. Contact was lost at 2130 hours (9:30 P.M.) at a distance of 170 kilometers (92 miles) from the transmitter. This distance was 60 kilometers (32 miles) beyond the horizon. Although the receiver

prevailed during the first 2 trips with respect to time, route followed, and the shipboard installation. The weather, however, at this time was definitely bad with a mistral wind of such intensity that the ship on the way out had to seek shelter for 24 hours at La Ciotat as shown in Figure 16. Despite these unfavorable conditions, transmission tests were conducted and showed a type of propagation characterized by a steady decrease of signal strength beyond the horizon as experienced aboard the *Curieuse*.

On October 28 at 1405 hours (2:05 P.M.) the radial leg of the trip started. The signal was lost at 2030 hours (8:30 P.M.) at a distance of 138 kilometers (75 miles), which was 40 kilometers

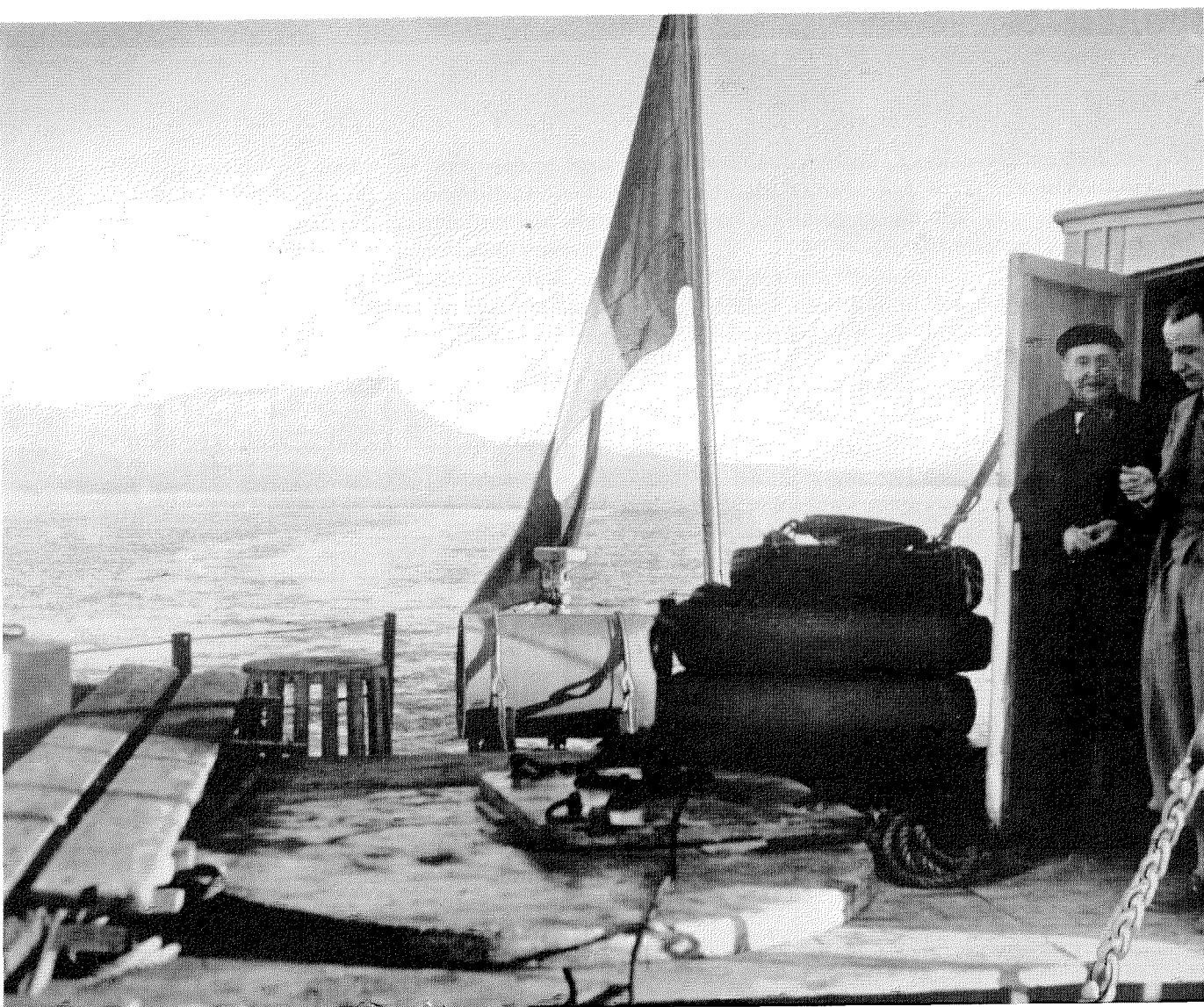

Figure 18—The receiving cabin on the *Ampère*.

(22 miles) beyond the horizon. On November 7, starting from the Spanish coast at 1611 hours (4:11 P.M.), the signal was picked up at 2150 hours (9:50 P.M.) at 148 kilometers (80 miles) from Coudon and 50 kilometers (27 miles) beyond the horizon.

After these 5 trips, it appeared rather probable that two distinct types of propagation, dependent on atmospheric conditions, had been encountered. A last trip was to confirm this view in a particularly interesting manner.

This last trip took place on December 10, 1941, on board the cable ship *Ampère*, which was made available to the experimenters by the Posts, Telegraphs, and Telephones Administration on the occasion of a trip to Phillippeville in Algeria. The receiving cabin shown in Figure 18 was built

at the stern of the cable ship, which was particularly free of obstructions. The transmitter at Fort Coudon was moved to a shack built for the purpose to provide better transmission in the direction of the route to be taken by the *Ampère*.

After a rather stormy period, the weather cleared on the day of the sailing. As usual, the transmission tests were started as soon as the ship left the harbor. The field-strength measurements were made on an automatic recorder. The propagation, which was the first to be recorded beyond the horizon, was of the steadily decreasing type. A technical difficulty in the transmitter interrupted its operation. When word was received that the transmitter was again ready to operate, the ship had approximately reached the

extreme range. It was then decided to turn back and resume the experiment at a few miles from the horizon. Contact was re-established at 10 kilometers (5.4 miles) from the horizon as soon as the ship had turned around. Again, the type of propagation characterized by steady decrease in signal strength was experienced. The general character is shown in Figure 19. The loss of contact took place at 140 kilometers (76 miles) at 1715 hours (5:15 P.M.).

It was then decided to repeat the experiment. In the meantime, the atmospheric conditions had continued to improve both at sea and at the transmitting site, from which was reported a calm sea and no wind. At the same time, conditions of abnormal optical refraction could be

observed on the horizon. As soon as contact was re-established, after the second change of direction, a steady decrease of signal was experienced at first. At a distance at 150 kilometers (77 miles), passed at 2030 hours (8:30 P.M.), however, the field strength started to increase and to evidence variations as shown in Figure 20. These variations, although of the same nature as those experienced on the first two trips of the *Havraise* were of a lesser amplitude. The maxima did not reach the same order of magnitude and loss of contact occurred at 2230 hours (10:30 P.M.) at 80 kilometers (42 miles) beyond the horizon. The general nature of the phenomenon, however, resembled clearly the type of propagation encountered in the first two trips.

This sixth experiment permitted observation of both types of propagation within a few hours. The first type, which might be called normal, takes place in an agitated or turbulent atmosphere resulting in a steady and rather rapid attenuation beyond the horizon; contact was lost between 35 and 55 kilometers (19 and 30 miles) beyond the horizon. The other

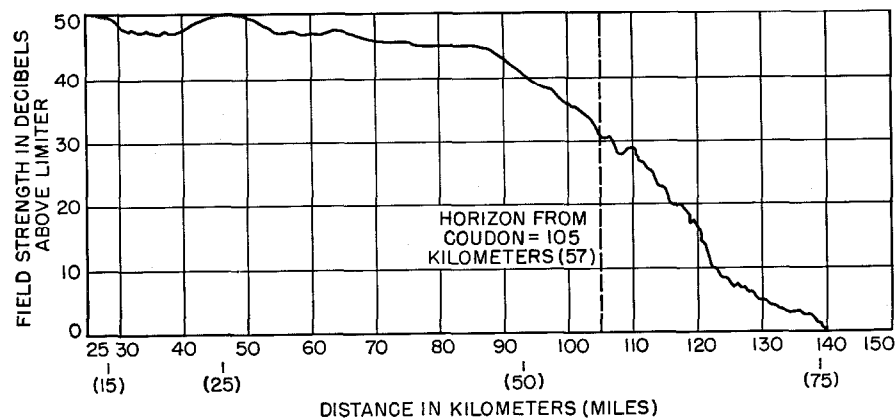

Figure 19—Field strength versus distance on the last trip of the series on the cable ship *Ampère*. An automatic recorder was used. The change in transmitter location increased the distance to the horizon to 105 kilometers (57 nautical miles). During this first part of the trip, the weather was clearing after a stormy period.

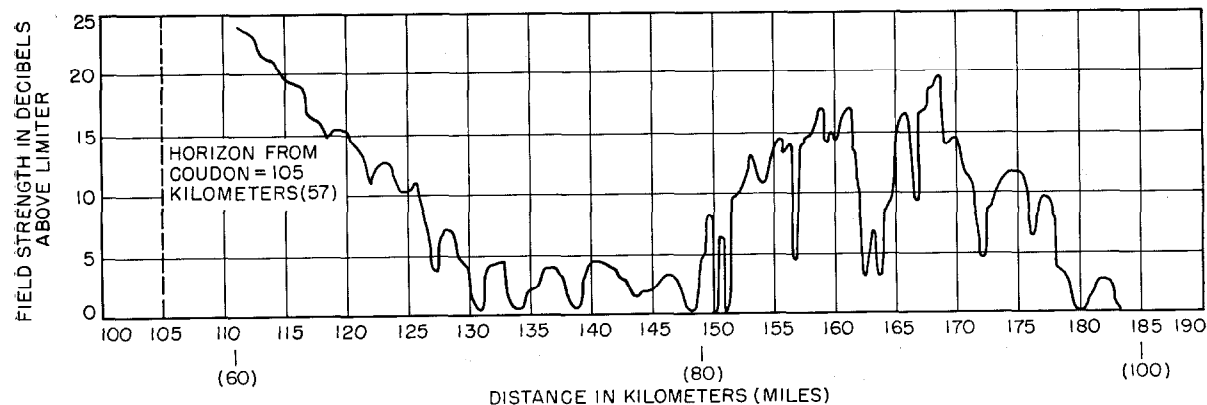

Figure 20—Propagation conditions beyond the horizon during the second part of the trip on the *Ampère*, when the weather had cleared.

type of propagation, which might be called abnormal because it does not follow the theory of propagation in isotropic media, is encountered in calm atmosphere and is characterized by a very substantial increase of range beyond the horizon, combined with large variations of amplitude. This last type of propagation is in all probabilities dependent on the degree of stratification of the atmosphere at the horizon.

It is fortunate that the first experimental trip had been under conditions that produced the type of propagation that we have just considered as being abnormal. This, in fact, encouraged the further observations that confirmed that under certain conditions centimetric waves propagate to considerable distances beyond the horizon. In addition, the observation of the 2 types of propagation within a few hours permitted the assumption, with strong presumption, that the so-called abnormal propagation is due to a localized phenomenon in the lower strata of the atmosphere. Any effect caused by upper strata

of the atmosphere seems to be eliminated by the highly directive characteristics of the transmitting and receiving antennas. The experiments related above clearly brought to light the essential propagation characteristics of 10-centimeter waves and furnished basic information for the practical utilization of these waves in line-of-sight and beyond-the-horizon links.

4. Acknowledgment

The group of experimenters who conducted the work described in this report found their task greatly facilitated by the support they received from so many sources. It is their pleasure, at this time, to renew their expressions of deep gratitude to the French Signal Corps; the Posts, Telegraphs, and Telephones Administration; and Navy. Thanks to the support given, it was possible to overcome the difficulties and dangers of wartime conditions and make a contribution to a technical field that is bound to be of prime importance.

Investigation of Very-High-Frequency Nonoptical Propagation Between Sardinia and Minorca*

By JOSÉ MARIA CLARA

*Compañía Telefónica Nacional
de España; Madrid, Spain*

and ALBINO ANTINORI

*Ministero delle Poste e delle
Telecomunicazioni; Rome, Italy*

ANNOUNCEMENTS that very- and ultra-high-frequency transmission had been found possible over distances considerably greater than classical diffraction theory had predicted aroused considerable interest in Europe. It was felt that if such transmission proved to be reliable, there would be numerous cases where it could provide circuits more conveniently and, perhaps, more economically, than could conventional transmission systems. One such case would be the provision of telephone circuits between Italy and Spain, via Sardinia and Minorca as indicated in Figure 1. Accordingly, the Italian and Spanish administrations decided to set up an experimental link over the longest section of the route, namely, between Sardinia and Minorca. With the collaboration of International System associates in Italy, Spain, and Great Britain, special equipment was manufactured and installed, and a test program was decided on.

In view of the small amount of information published on the depth of fading and the available bandwidth of beyond-the-horizon transmission, it was felt that the object of the experiment should be to collect as much basic data as possible, and not to attempt, at this stage, to

* Reprinted from *IRE Transactions on Microwave Theory and Techniques*, volume MTT-3, pages 7-12; December, 1955. Copyright © 1955 by The Institute of Radio Engineers, Incorporated.

This paper reports on propagation tests made late in 1954 and early in 1955. On the basis of subsequent tests, the International System plans to establish an experimental tropospheric-scatter link between Sardinia and Minorca using frequency diversity and having an initial capacity of 6 telephone channels.

provide an operational telephone link. After consideration of the factors involved, a radio frequency of about 300 megacycles per second was chosen, as it was felt that this frequency afforded the best combination of readily available trans-

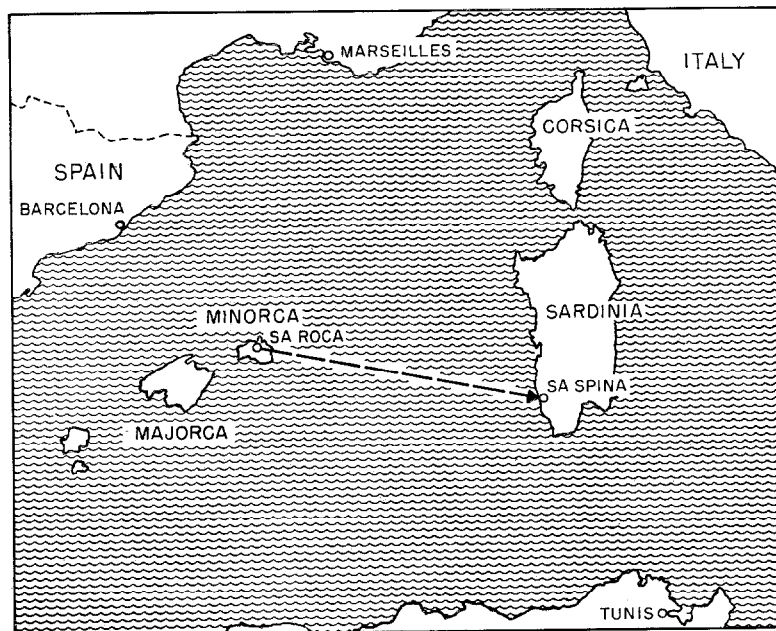

Figure 1—Map of the 240-mile (385-kilometer) link.

mitter power and antenna gain. In this connection it should be remembered that the development of high-power klystrons for frequencies of 800 to 1000 megacycles has not proceeded so rapidly in Europe as it has in the United States, where this development had the apparent incentive of ultra-high-frequency television broadcasting.

To explore the possibilities of wide-band transmission, it was decided to modulate the transmitter with a constant frequency and to provide separate narrow-band receivers for the resulting carrier and first sidebands. Means were then provided to record the amplitude of each sideband, so that any differential fading could be

observed. In addition, the 2 equal frequencies obtained by mixing each received sideband with the carrier were compared in a phase discriminator, so that some idea could be obtained of the group delay distortion over a frequency band.

The equipment was designed so that either 238 or 297 megacycles could be transmitted, and results could be obtained at more than 1 frequency. Similarly, the antenna dipole radiators were designed so that either horizontal or vertical polarization could be used. The test program was arranged so as to change the frequency or the polarization at weekly intervals. For example:

- 1st week, 238 megacycles, horizontal polarization
- 2nd week, 297 megacycles, horizontal polarization
- 3rd week, 297 megacycles, vertical polarization
- 4th week, 238 megacycles, vertical polarization.

1. Description

1.1 SITES

The transmitter is located near the center of the island of Minorca. The site is 656 feet (200 meters) above sea level, and the ground slopes away from the site, giving a clear view of the sea.

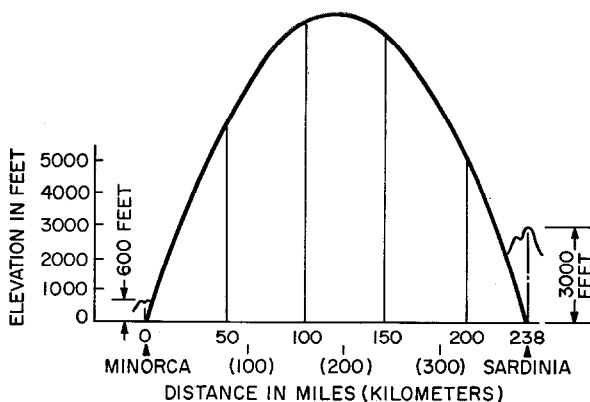

Figure 2—Profile of the radio path.

The receiving site is at Campo Spina near the southwest coast of Sardinia. The site is nearly 3280 feet (1000 meters) above sea level and there is again a clear horizon to the sea. Profile of the radio path is in Figure 2.

1.2 ANTENNAS

Both receiver and transmitter employ paraboloids of 33-foot (10-meter) diameter. They consist of angle-iron framing covered with a wire mesh. The transmitting antenna was manufac-

tured in Spain and its supporting structure differs from the receiving antenna made in Italy.

The paraboloids are illuminated by normal dipoles and it is possible to vary within limits the position of the dipole in the focal plane of the paraboloid, which enables fine adjustments of the radio beam. In addition, both paraboloids have a limited movement in the horizontal and vertical plane.

1.3 RADIO EQUIPMENT

1.3.1 Transmitter

The transmitter (Figure 3) has a carrier output of approximately 1 kilowatt at the frequencies of operation, namely, 238 and 297 megacycles. The carrier is phase-modulated with a modulation index that produces maximum amplitude of the 1st sidebands. With this optimum value of modulation index, the rate of change of sideband amplitude with modulation is a minimum, and is thus the most stable condition of operation.

The radio frequency of the transmitter is governed by a temperature-controlled crystal oscillator of frequency 124 kilocycles, of the type used in a coaxial-cable system, which has a frequency stability of 2 parts in 10^7 . The oscillator is followed by two stages of multiplication that produces a frequency of 2.48 megacycles. This frequency is then multiplied by 4, when the final frequency required is 238 megacycles, and by 5, when the final frequency is 297 megacycles.

The multiplied frequency of 9.92 or 12.4 megacycles is phase-modulated by the crystal-controlled 124-kilocycle signal to produce 2 sidebands of maximum amplitude. This phase-modulated output is then fed to a multiplier ($\times 24$) that produces the final frequencies of 238 and 297 megacycles.

The final frequency is amplified in 3 stages to produce an output of a little over 1 kilowatt. The power in each sideband is approximately 0.5 kilowatt.

1.3.2 Receiver

The receiver employs 3 stages of frequency conversion and the first 2 local-oscillator frequencies are derived from the same type of master oscillator used in the transmitter, thus preserving the same degree of frequency stability in both transmitter and receiver. The re-

ceived frequency after amplification is first converted to an intermediate frequency of 56.544 megacycles and subjected to further amplification. The 2nd converter produces the 2nd intermediate frequency of 2.976 megacycles, which is

amplified in a narrow-band amplifier, and then mixed with a frequency of 2.676 megacycles, produced by a separate crystal oscillator.

The resulting carrier of 300 kilocycles, with sidebands of 424 and 176 kilocycles, are then



Figure 3—The transmitter for the link.

separated by band-pass filters and amplified by separate amplifiers. The outputs of the sideband amplifiers are rectified and fed to 2 movements of a 3-pen continuous recorder.

The 300-kilocycle carrier, after limiting, is mixed with the 2 sideband frequencies in a phase discriminator, the output of which gives a direct indication on the 3rd pen of the 3-pen recorder of the phase difference between the 2 received sidebands.

The 3-pen recorder normally has a paper speed of 6 inches (15 centimeters) per hour, but it is possible to increase this speed by 60 times for short periods. The time constant of the recorder movement is approximately 1 second, which is much longer than any time constant associated with the receiving equipment.

2. Results

The tests have now been in operation for some months, having commenced in November of 1954, but the results so far analyzed relate to winter months only. The results should thus be interpreted with some reservation, as they may not be representative of yearly distribution of signal level. However, it is possible to make some observations on the general characteristics of the received signal.

It was soon realized that at times the signal was below the noise level of the receiver (-125 decibels relative to 1 milliwatt), whereas it could also be of the order of -60 decibels, a range of level of over 60 decibels. The recording circuits of the receiver can accept a variation in signal level of only 40 decibels, but it is possible to center this variation at any particular level by means of an attenuator in the input circuit to the receiver. The normal setting of the attenuator was based on the signal-to-noise ratio required to operate the phase-measuring circuits and with this in view it was decided to set the receiver to operate between -75 and -115 decibels. This range enables a fairly accurate analysis of the distribution of low-signal levels, which are obviously of the greatest importance in assessing the performance of a possible future radio link, over the same radio path.

The type of signal received can be roughly classified into 4 categories (see Figures 5 through 8).

Type 1: A high-median-level of signal of the order of 30 decibels above the median expected, from the information published¹ by Bullington, with occasional short-duration fades sometimes reaching the noise level (-125 decibels). The high-level signal is most likely due to super-refraction, and, referring to Figure 4, it will be seen that a value of K greater than 3.5 could produce a signal that is greater than -70 decibels. The curve assumes diffraction over a smooth sphere.

If the value of K is greater than 6, the path becomes an optical path and the occasional deep fades could be the result of reflection from the sea, especially as the receiver is nearly 3300 feet (1000 meters) above sea level.

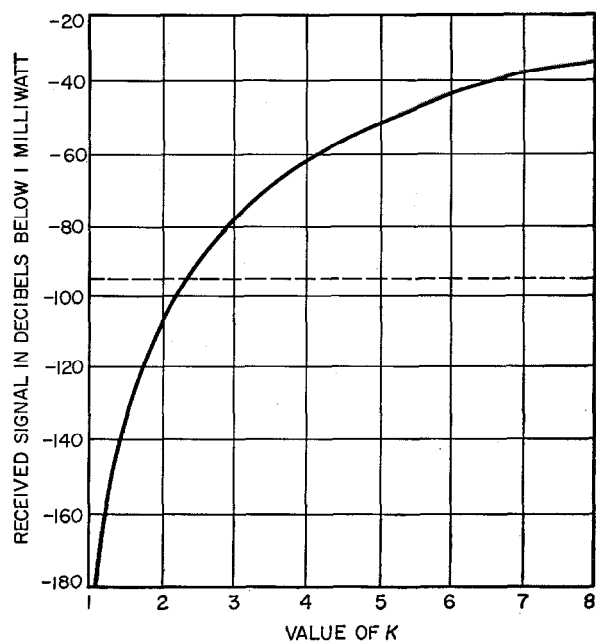

Figure 4—Plot of K versus received signal; K is the ratio of the effective radius of the earth to the actual radius. Dashed line indicates median level.

Type 2: A fairly rapidly fluctuating signal with a median level somewhat lower than expected. The duration of the fades is approximately equal to the period between fades, both being about 1 minute. The peak-to-peak amplitude is of the order of 25–30 decibels.

¹K. Bullington, "Radio Transmission Beyond the Horizon in the 40- to 4,000-Mc Band," *Proceedings of the IRE*, volume 41, pages 132–135; January, 1953.

Type 3: A rapidly fluctuating signal with very-short deep fades extending to the noise level of the receiver. The median value is approximately that expected from scatter propagation.

Type 4: Very-rapidly fluctuating signals, the characteristics of which cannot be resolved by the normal recorder paper speed of 6 inches (15 centimeters) per hour. Increasing the paper speed to 6 inches per minute has shown fading

duration of 1 second, which is the limiting time constant of the recorder, but even-shorter fades may well be present that are masked by the present system of recording.

The median value is that expected from scattering considerations.

The tests have been operating on 2 frequencies and both types of polarization have been used. There does not appear to be any appreciable

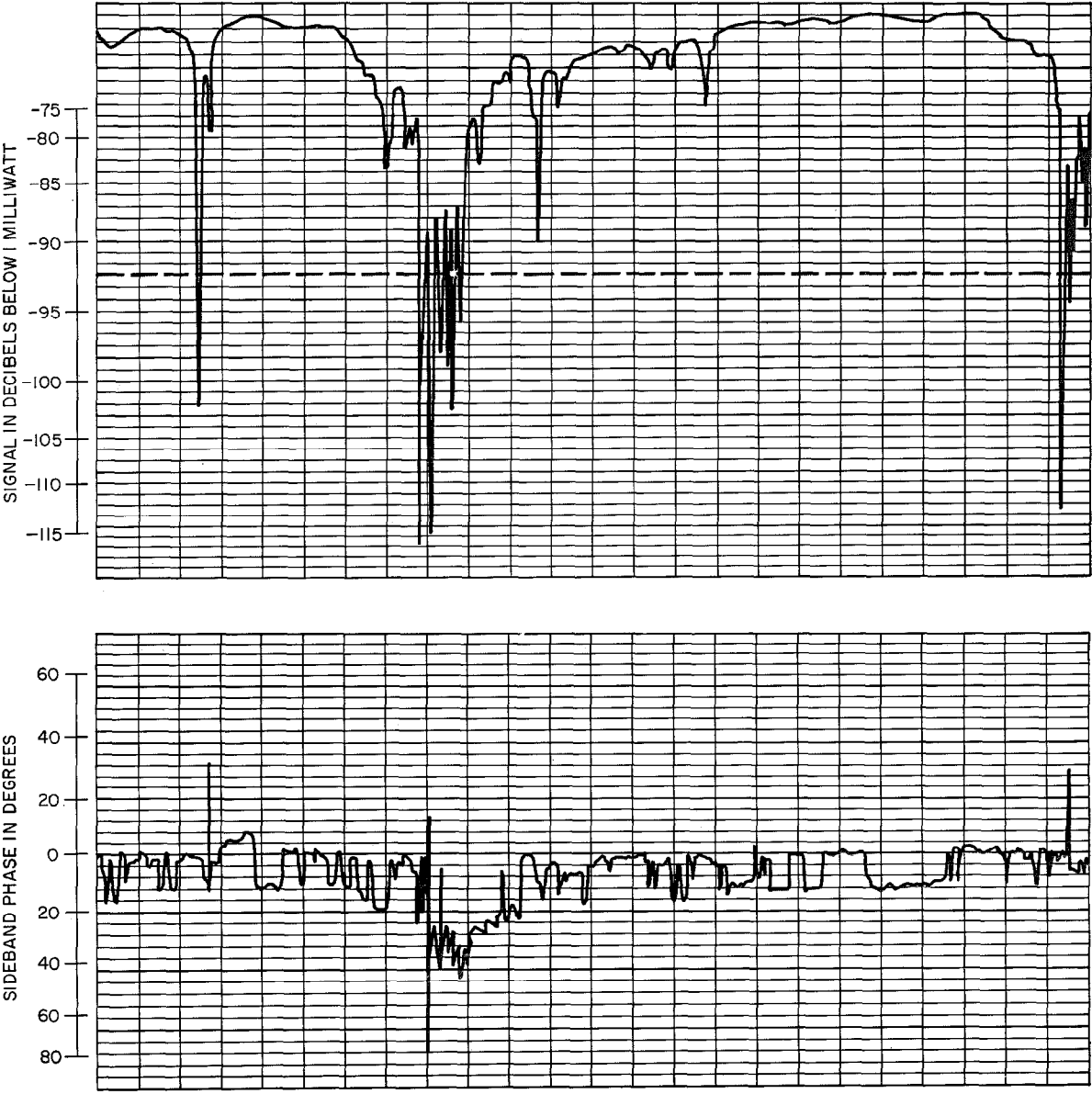

Figure 5—Typical type-1 signals. Dashed line is the calculated median level. Portion of the recording reproduced is of 1-hour duration.

difference in receiving level between the 2 frequencies used; neither is there a more-favorable polarization. Short-period tests have been carried out with the transmitting antenna horizontally polarized and with the receiving antenna vertically polarized, and at all times the signal has been at least 20 decibels lower than normal. The plane of the transmitted polarization thus appears to be well maintained, even when subjected to scattering from the troposphere.

3. Analysis of Results

The first broad analysis of the results concerned the probability of occurrence of the 4 types of signal already noted. This was, very approximately:

- Type 1: 10 percent of the time
- Type 2: 10 percent of the time
- Type 3: 55 percent of the time
- Type 4: 25 percent of the time.

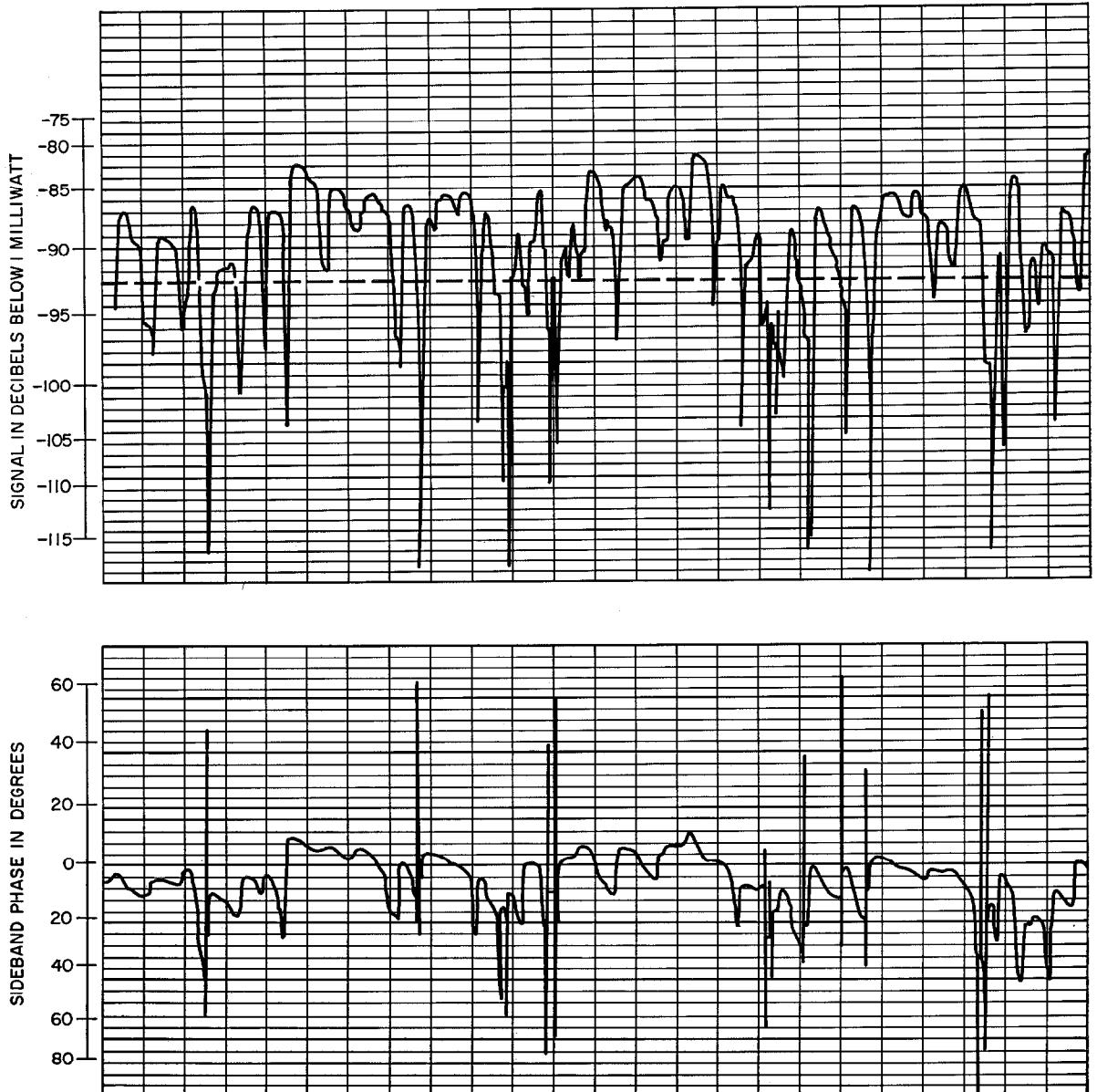

Figure 6—Typical type-2 signals. Dashed line is the calculated median level. Portion of the recording reproduced is of 1-hour duration.

Type 1 appears to be typical of fine still-weather conditions and may be expected to occur more frequently during the summer months. Types 2, 3, and 4 occurred during turbulent weather.

We have devoted most of our attention to the type-3 signal, because of its predominance and because it is not too-rapidly fluctuating to be dealt with by normal methods of analysis. With the normal recorder speed, type 4 defies analysis

and we have not yet sufficient samples of high-speed recording to produce any reliable data.

Figure 9 shows the distribution of the estimated hourly median signal (of all types) for the period for which results are available. As an indication of the variability of the transmission, curves are also given for a good week and a bad week.

It will be seen that the median value of the total distribution is within 2 decibels of that

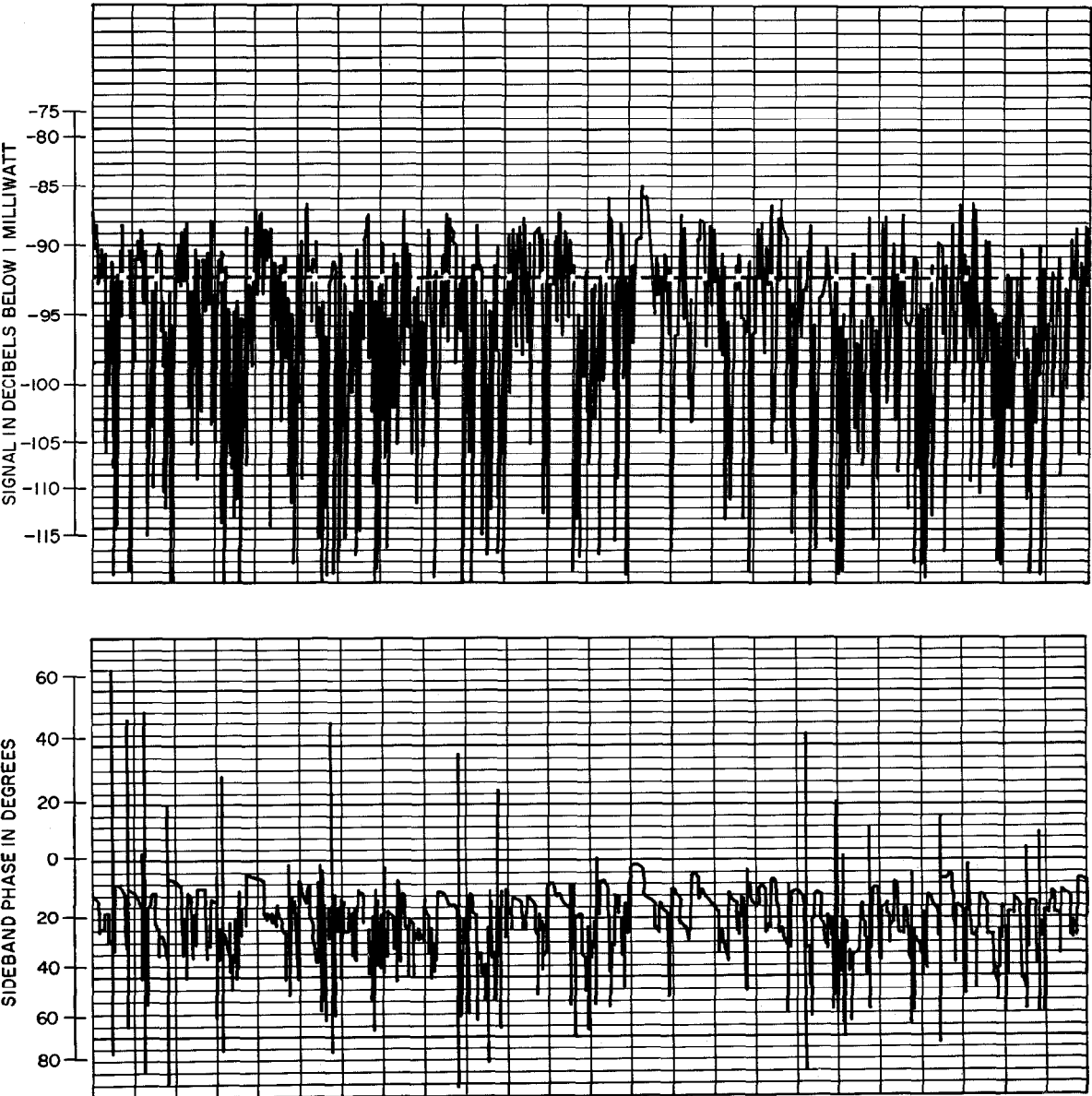

Figure 7—Typical type-3 signals. Dashed line is the calculated median level. Portion of the recording reproduced is of 1-hour duration.

expected from the application of the curves published by Bullington. In view of the wide spread of the weekly median, however, this agreement should be treated with caution.

An analysis has also been made of the distribution of instantaneous values of signal. Such a distribution is shown in Figure 10. This is for a period of 8 hours and is fairly typical of type-3 signals. This curve is probably in error at the low-signal end because of the difficulty of de-

termining, from the somewhat slow recording, the duration of short deep fades. However, the median value agrees well with that of long-term distribution.

No detailed analysis of the phase recording has yet been undertaken. As it will be seen from the examples shown, the deviation from zero phase shift is not usually very large, except during deep fades. Unfortunately, the phase-measuring circuit does not function correctly when the signal-

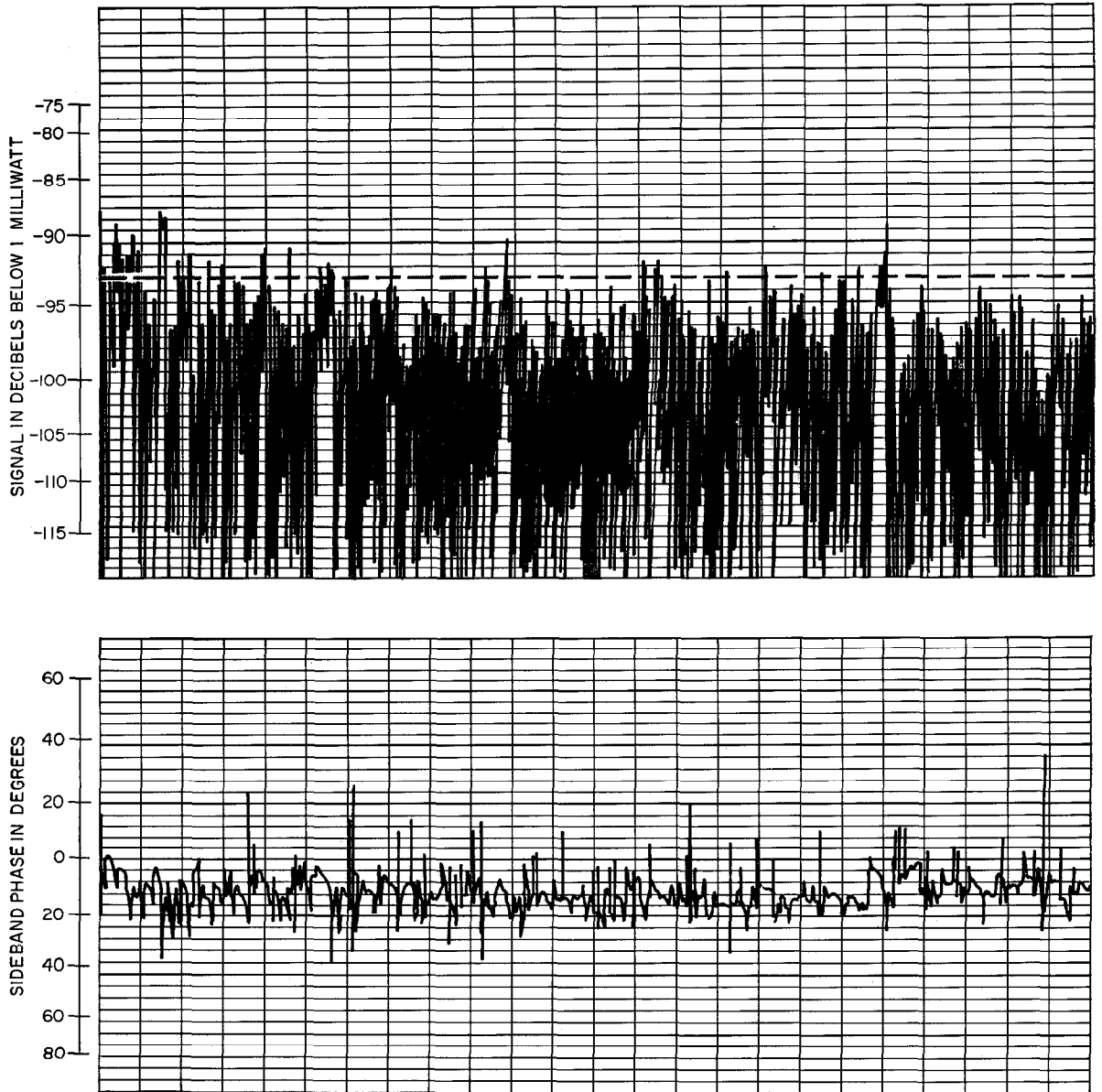

Figure 8—Typical type-4 signals. Dashed line is the calculated median level. Portion of the recording reproduced is of 1-hour duration.

to-noise ratio is low, and most of the apparent large deviations of phase can be neglected as false indications.

Similarly, there are no signs of differential fading of the 2 sidebands, but until the phase measurements are examined in greater detail, it is not possible to predict what bandwidth may be transmitted: however, it would appear that it will be greater than the 250 kilocycles explored in the present experiments.

4. Operational Possibilities

It is, of course, very early to attempt to draw any very-definite conclusions from the small amount of data available at present, but nevertheless it is of interest to consider the possibilities of operational telephony over this route in the light of the test results. Various authorities have stated that path loss is likely to be at its greatest during the winter months, so that, in using results obtained during that period, our esti-

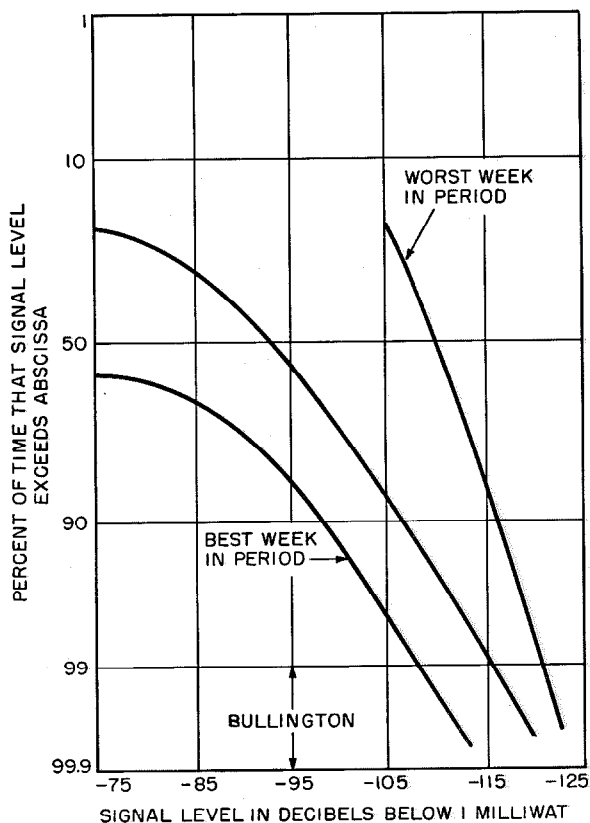

Figure 9—Distribution of estimated hourly median signal.

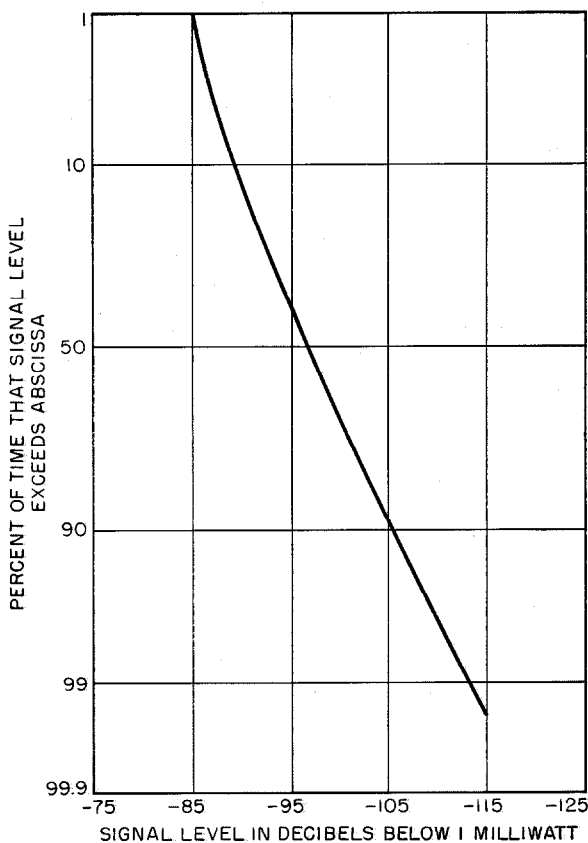

Figure 10—Distribution of instantaneous signal values.

mates of possible performance should not be over-optimistic.

It is immediately apparent that the present experimental link cannot be expected to provide any worthwhile communication facilities. Let us, therefore, assume that we have 10 kilowatts at 1000 megacycles but that we retain the 33-foot (10-meter) dishes. Diversity reception may also be assumed, although it seems probable that the main advantage thereby obtained would be a reduction in the depth of short-period fading, with little or no effect on the longer-term median levels.

From the distribution curve of hourly median levels we find that the level exceeded 99 percent of the time is -118 decibels. Increasing the transmitter power from 0.5 to 10 kilowatts would give a gain of 13 decibels, and increasing the frequency to 1000 megacycles would reduce the path loss by 10 decibels. Thus a total gain of 23 decibels might be expected. However, it is known that for small signals the full plane-wave

gain of a large antenna may not be realized. We have no data on the magnitude of this effect but we will allow 5 decibels, thereby reducing the improvement to 18 decibels. Hence the hourly median signal level exceeded 99 percent of the time would be -100 decibels. It is of interest to note that a similar performance could be obtained at 300 megacycles by using 10 kilowatts and dishes of at least double the area of those now in service. This solution might be more attractive in Europe, owing to the relative scarcity of high-power tubes operating in the 800-to-1000-megacycle band.

We now assume that under these conditions the predetector signal-to-noise ratio is 5 decibels and that the receiver noise factor is 10 decibels, which implies that the intermediate-frequency bandwidth will be 1 megacycle. Let us now consider a 12-channel frequency-division multiplex system, with a base band of 12-to-60 kilocycles. Using straightforward frequency modulation, such a system could be accommodated in the 1-megacycle band with a peak frequency deviation of about ± 400 kilocycles. Thus, frequency-modulation advantage of $20 \log (400/60)$, or 16 decibels can be expected, giving a signal-to-noise ratio of 21 decibels in the base band. Holbrook and Dixon give the peak power of a 12-channel signal as 17.5 decibels at a point of zero relative level, but we will use a figure of 16 decibels. Hence, considering a 3-kilocycle channel, the unweighted noise level will be $21 - 16 + 10 \log (1000/6) = 27$ decibels below a milliwatt at a point of zero relative level. This corresponds to a noise-meter reading of 46 decibels adjusted at -9 -decibel relative level. The over-all median path loss is 23 decibels less than the 99-percent value, so that the yearly median noise level in a telephone channel would be 23 decibels adjusted at -9 -decibel relative level. This last figure may be pessimistic since under median-signal conditions the full antenna gain may be realized, resulting in a 5-decibel improvement.

At first sight, these performance figures seem quite practical, but it must be remembered that they apply to a link of only 240 miles (385 kilometers), and that for 1-percent of the hours of a year, or 88 hours, the performance will be worse than 46 decibels adjusted. It may be very-much worse in fact, because under the 99-percent

conditions, the predetector signal-to-noise ratio is just about at the threshold value and any further deterioration will result in a disproportionate increase in channel noise level. Diversity reception should reduce fading range below 99-percent signal level; there is little doubt complete outage will sometimes occur. Remember also that no allowance for intermodulation distortion has been made.

Admittedly, the performance calculation just carried out is based on insufficient data and a certain amount of estimate, but it is thought that the discrepancy between these performance figures and those expected of a link in a main toll route is too great to permit the use of this type of transmission at present, except under most-difficult circumstances, where physical or financial obstacles preclude the use of more-conventional means of transmission. There is, however, a strong probability that future improvements in technique will modify this rather pessimistic view, and the tests are therefore being continued. It is hoped to add diversity reception to determine what advantages can be gained, and, in order to save time and labor, an automatic signal-strength analyzer will be incorporated in the equipment.

5. Acknowledgment

Several parties have collaborated in these tests. The equipment design was suggested by Standard Telecommunication Laboratories Limited of London, England; the detailed design and manufacture were carried out by Fabbrica Apparecchiatura per Comunicazioni Elettriche Standard, of Milan, Italy, who also carried out installation with the assistance of Società Italiana Reti Telefoniche Interurbane, of Milan, and Standard Eléctrica, of Madrid, Spain. The sites were provided by the Italian and Spanish administrations, who were also responsible for power supplies and other facilities. The transmitter site is staffed by Standard Eléctrica, while the receiver site is staffed by Società Italiana Reti Telefoniche Interurbane, who are also analyzing the records obtained. The coordination of the tests is the responsibility of Standard Telecommunication Laboratories, to whom we are indebted for much of the information in this paper.

900-Megacycle Pulse-Time-Modulation Beyond-the-Horizon Radio Link*

By FREDERICK J. ALTMAN, RICHARD E. GRAY, ARMIG G. KANDOIAN, and WILLIAM SICHAK

Federal Telecommunication Laboratories, a division of International Telephone and Telegraph Corporation; Nutley, New Jersey

AN EXPERIMENTAL beyond-the-horizon radio link has been installed and tested for several months by Federal Telecommunication Laboratories. Its chief purpose has not been to study propagation, although several interesting results may appear, nor to establish a commercially usable communication facility, but rather to study the application of this relatively unexploited type of propagation to multichannel transmission, particularly that using pulse-time modulation (ptm).

1. Sites

With this in view, it was decided to install a 2-way link with the main terminal located at the Nutley, New Jersey,

* This paper originally appeared under the title, "900-mc PTM Over-the-Horizon Radio Link," in *IRE Transactions on Microwave Theory and Techniques*, volume MTT-3, pages 22-26; December, 1955. Copyright © 1955 by The Institute of Radio Engineers, Incorporated.

laboratories for convenience in making measurements, and a repeater point at the Mackay Radio and Telegraph Company receiving station at Southampton, Long Island, New York. Thus there are, in effect, 2 links in cascade. It will be seen from Figure 1 that this path, approximately 91 miles (146 kilometers) long,

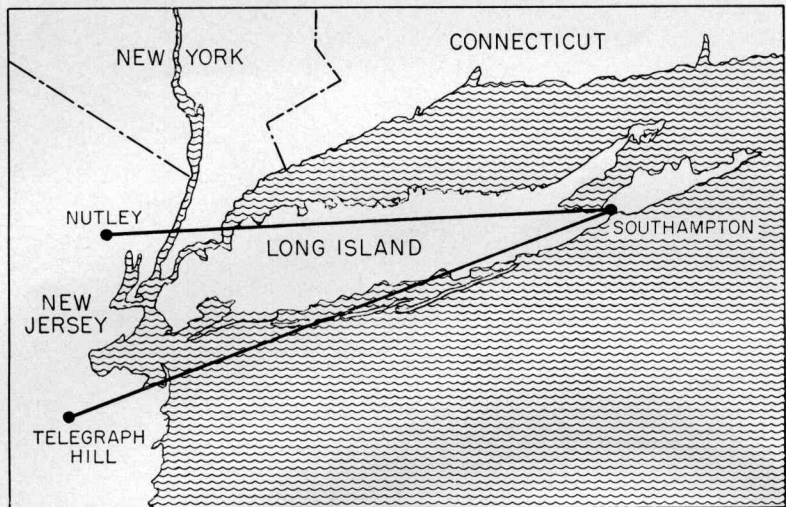

Figure 1—Map showing test locations.

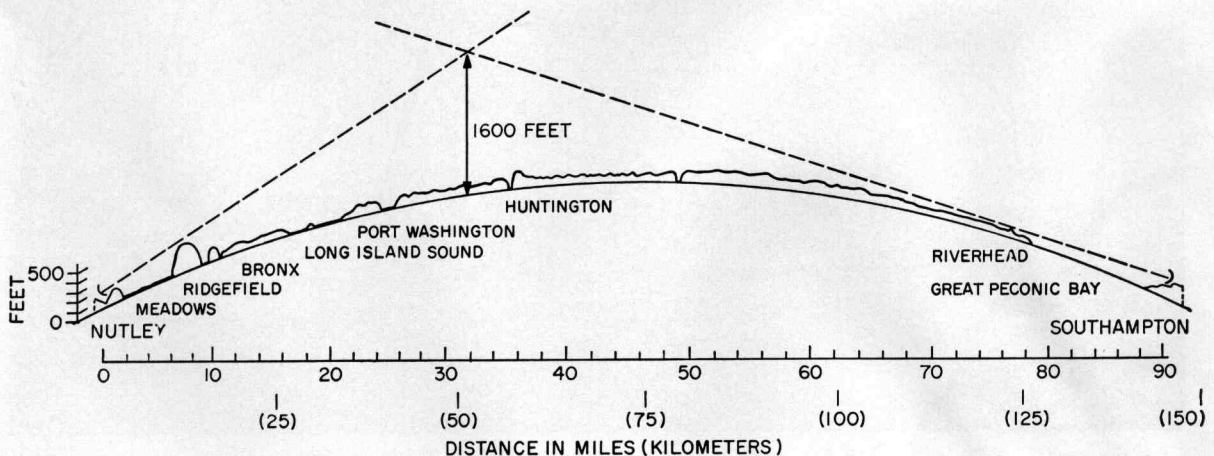

Figure 2—Profile of Nutley-Southampton path.



Figure 3—View of 28-foot (8.5-meter) paraboloidal antenna with dual polarization horn.

is almost entirely over land, including parts of New York City and some of the most heavily traveled airspace to be found anywhere. The path to Telegraph Hill, New Jersey, is shown, as it also is being tested to determine if there is some essential peculiarity on the Nutley path that causes unexpectedly low signals. Figure 2, a profile of the Nutley path, shows the modest antenna heights and particularly that the Nutley beam must be raised by about 0.5 degree to clear the Palisades, a rock ledge along the Hudson River near the George Washington Bridge. This increases the scatter angle, of course, and thus also the path attenuation, by perhaps 6 decibels.

2. Radio-Frequency Equipment

Paraboloidal reflectors 28 feet (8.5 meters) across have been installed at each terminal. Figure 3 shows the reflector and diplexing illuminating horn at Nutley. Vertical polarization is used for transmission, and horizontal for recep-

tion. The cross talk is about 50 decibels and the voltage standing-wave ratio is less than 1.3 from 890 to 940 megacycles. Figure 4 shows the Southampton antenna, temporarily located low on the 50-foot (15-meter) tower, and the equipment trailer. Part of the trailer has been made into a screen room to permit receiver operation a few feet from the 1-kilowatt transmitter. The transmitter room is also shielded and its power lines filtered to eliminate interference with some very-important Mackay Radio international receiving circuits.

Figure 5 is a block diagram of equipment used for most of the tests to date. Frequencies 5 megacycles inside the borders of the 890 to 940-megacycle common carrier band were chosen to permit the use of *FTL-20B* modified ultra-high-frequency television transmitters. These provide 1-kilowatt peak power, up to 6-megacycle bandwidth, frequency drift less than 1 kilocycle, and commercial reliability. They can also be readily adapted to frequency-modulation transmission.

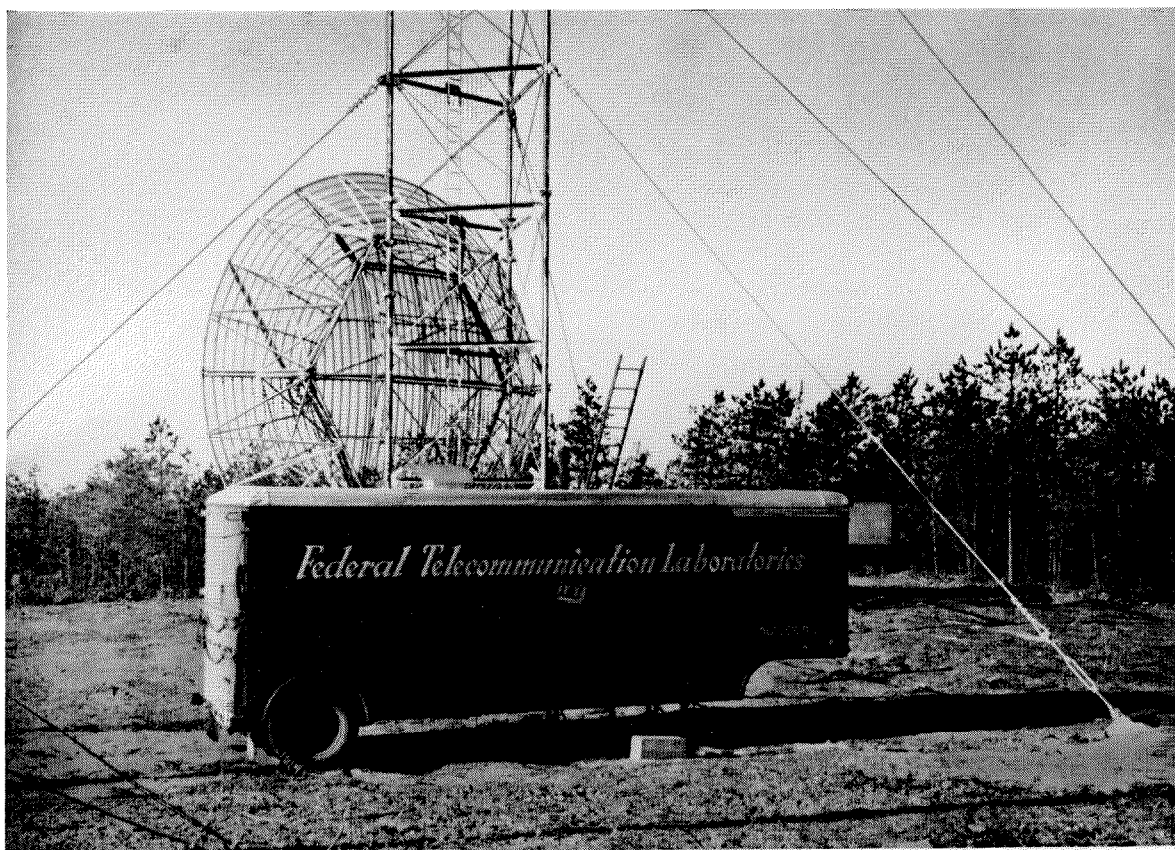

Figure 4—View of Southampton antenna and equipment trailer.

Each receiver (Figure 6) uses a preselector cavity, a radio-frequency amplifier, and a micro-strip mixer to provide a noise figure between 8 and 9 decibels and about 6-megacycle bandwidth. The local-oscillator power is derived by shifting a continuous-wave sample from the associated transmitter by 100 megacycles in a second micro-

ing, the terminal equipment was modified for radio-frequency bandwidth of 170 kilocycles. Four channel pulses, 6 microseconds wide, deviated plus and minus 6 microseconds were used. Appropriate filters were again used to restrict the bandwidth and obtain an improvement in signal to-noise ratio. Figure 8 shows system power

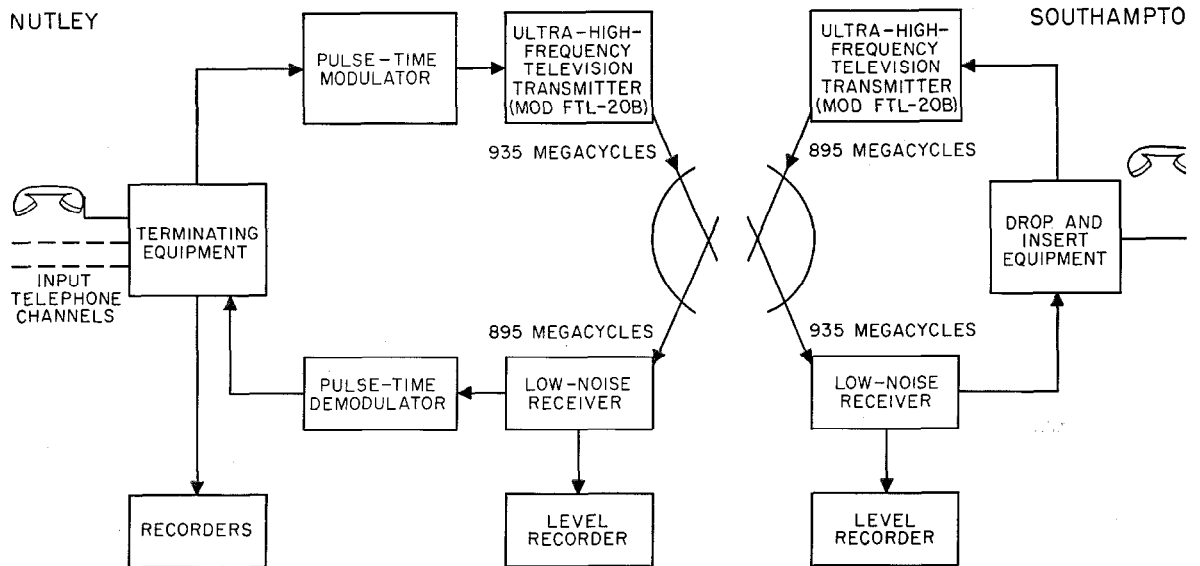

Figure 5—Pulse-time-modulation equipment; block diagram. The paraboloids are of 28-foot (8.5-meter) diameter and cross-polarization is used for duplexing.

strip mixer and then filtering with a single cavity. Figure 6 shows also the 6-pen recorder with associated amplifiers, a rack of test equipment, and the pulse-time-modulation modulator and demodulator bays.

3. Pulse-Time-Modulation Equipment

Most of the tests to date have used *FTR-28B* 23-channel pulse-time-modulation terminal equipment with the radio bandwidth restricted to 1 megacycle by video filters in the transmitter input lines. Receiver noise has been accordingly reduced by filters at intermediate frequency. The resulting loss in pulse-modulation improvement factor has been made up by use of compandors, demonstrating the feasibility of multi-channel pulse-time modulation with reduced bandwidth. This is summarized in Figure 7, which shows minimum bandwidth as a function of number of channels. As a check to see if there are any unexpected lower limits to this narrow-

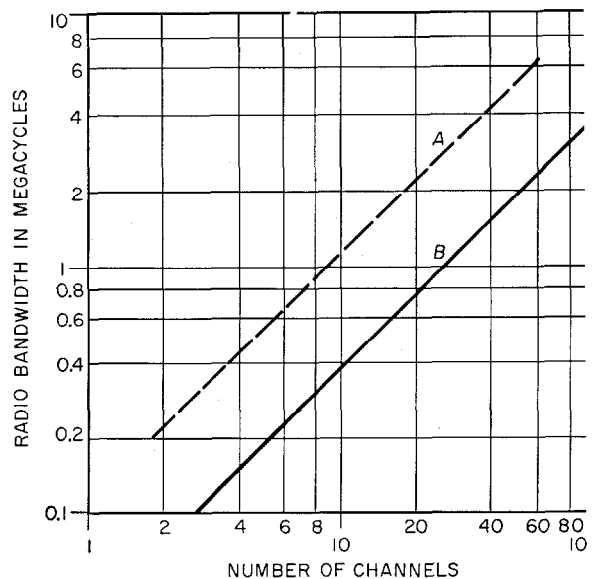

Figure 7—Bandwidth versus number of channels for pulse-time modulation. *A* = Bandwidth for 16-decibel pulse-modulation improvement factor. *B* = minimum bandwidth.

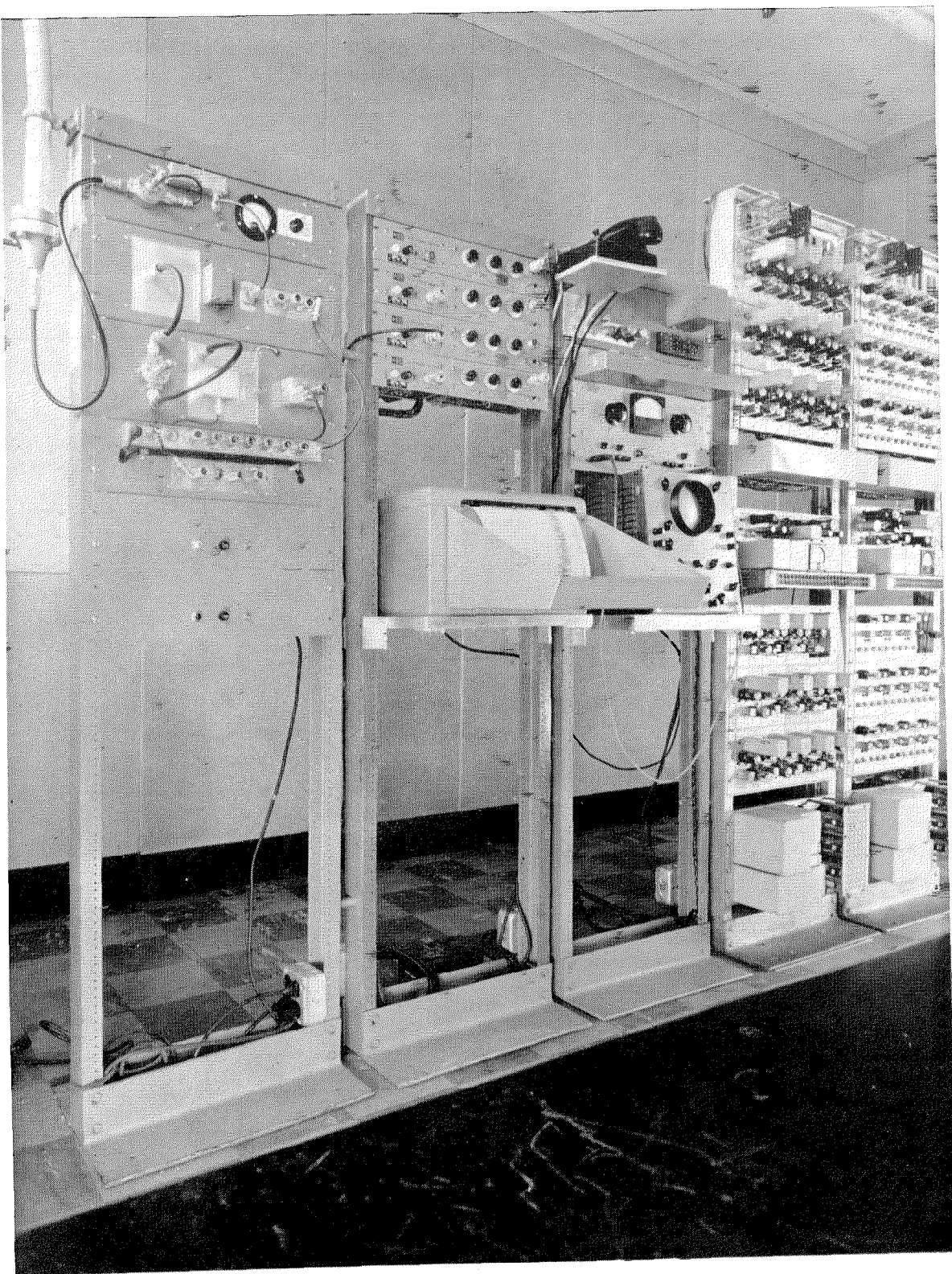

Figure 6—View of receiver, recorder, and multiplex equipment.

levels assuming the median path loss given by Bullington. For the wider-band system, a signal-to-noise ratio of 45 decibels is predicted, and for the narrow-band system, 53 decibels.

narrow-band receiver and simple tone modulation of the transmitter. Results showed that the median path loss is close to that predicted by Bullington.

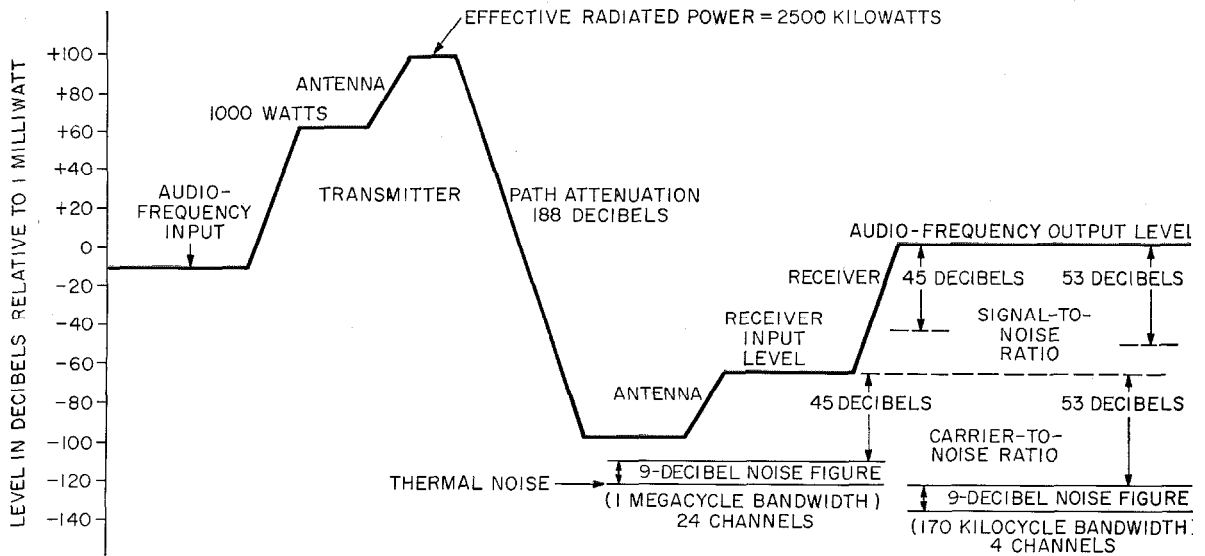

Figure 8—Power-level diagram.

4. Path Loss

Although the signal loop is 182-miles (293-kilometers) long, signal-strength recordings represent 1-way loss because the automatic-gain-control circuit maintains a constant peak output from the repeater transmitter. Signals received have not been as high as expected, as may be seen from Figure 9, a distribution plot covering a typical period. The fact that the signal was worse than about 93 decibels below 1 milliwatt 50 percent of the time, and is some 30 decibels below that predicted, may be partly accounted for by seasonal loss, usually not considered to be more than 10 decibels and partly by the loss due to the ridge mentioned above. There seems to remain, however, an additional loss factor that is suspected to arise from the overland nature of the path, possibly the over-city portion. To check this, an alternative path to Telegraph Hill has been tested with a 10-foot (3-meter) paraboloid and a receiver that were first used for measurements at Nutley. In this way, equipment factors were held constant to bring out the effects of medium and path configuration. Loss in antenna gain was made up for by use of a

5. Signal Recordings

Numerous recordings have been made and some of the more interesting are reproduced here. Figure 10 shows the use of that extraterrestrial noise generator, the sun, for determining antenna beamwidth and receiver performance. Here, as predicted, the quiet sun is 5 decibels above receiver noise at *A*. If it had been equal, that is, 9 decibels above theoretical noise, the trace would have risen to just under the 10-decibel point shown at *B*. The beamwidth checks at about 3 degrees, as expected.

Figure 11 shows at the top a fast recording of variation of signal strength when an airplane

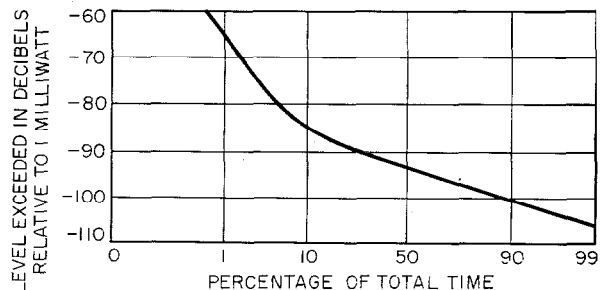

Figure 9—Summary of measured median levels.

crosses the beam. This effect is, of course, familiar to television viewers in poor service areas, but at times may be forgotten by researchers using recorders with long time constants. The typical

an absolute time reference and the recordings in the lower part of Figure 11 made. Lags of 1 microsecond are shown. The time shifts may be seen to correlate with the signal changes at some

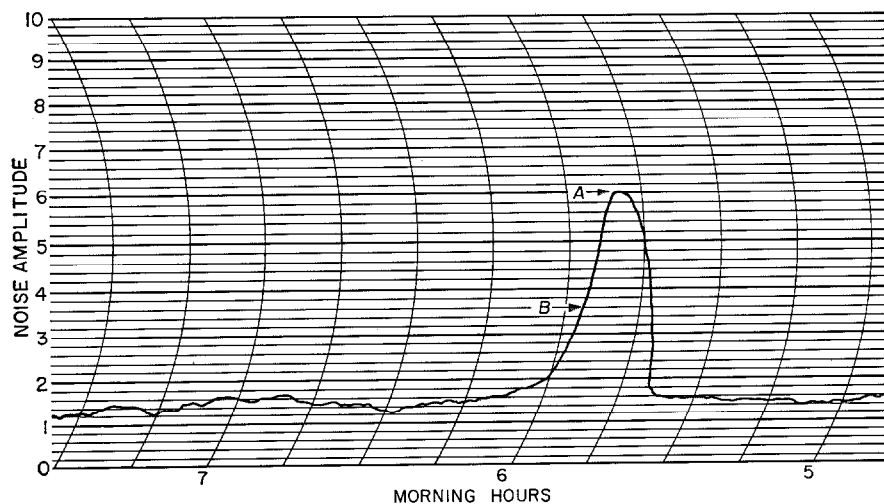

Figure 10—Recording of noise at 900 megacycles received from the sun. Points *A* and *B* are respectively 14 and 10 decibels above *KTB*.

points, but not at all points. In a typical airplane passage, the time shifts are largest at the beam edges, because then the path differences are greatest.

Figure 12 displays simultaneous recordings made with 2 receivers and 2 sizes of receiving antenna. The upper track from the smaller, 10-foot (3-meter) paraboloid shows the airplane doppler signal for a longer time than does that for the 28-foot (8.5-meter) antenna.

fast-slow-fast doppler frequency variation is clearly evident. During this, an effect on pulse shape and position may also be noted by oscilloscopic observation. No photographs of this were taken, but it was realized that the pulse-time demodulator makes an ideal instrument for studying the time shift of the effective leading edge of the pulse. Accordingly, the normal synchronizing circuits were modified to provide

Again, the rapid signal changes are clearly shown by the high-speed recorder. Each strip is about 20 seconds long, presenting detail which is completely suppressed on normal long-term recordings made with a time constant of 20 seconds. Even with no airplanes in the beam, fades of 15 decibels in 0.5 second have been noted. The correlation between the signals from antennas about 40-feet (12-meters) apart is of

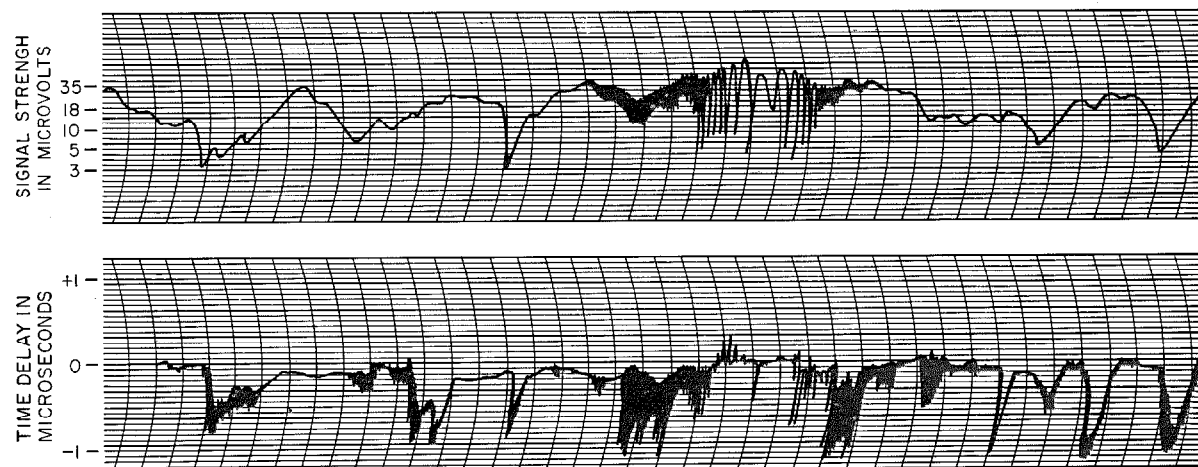

Figure 11—Recordings showing effect of airplane reflection on received signal and time delay.

interest. It is evident at some times and absent at others.

It should be mentioned in passing that ignition noise has been noticed occasionally. This is not usually a problem at ultra-high frequencies, but the high gain of the antennas used here makes it of some importance when there are roads in front of the receiving antenna.

6. Conclusion

In conclusion, it has been found that pulse-time modulation retains its known properties when applied to over-the-horizon propagation. Certain details appear to require further study, but these are functions of the medium and not of the modulation method.

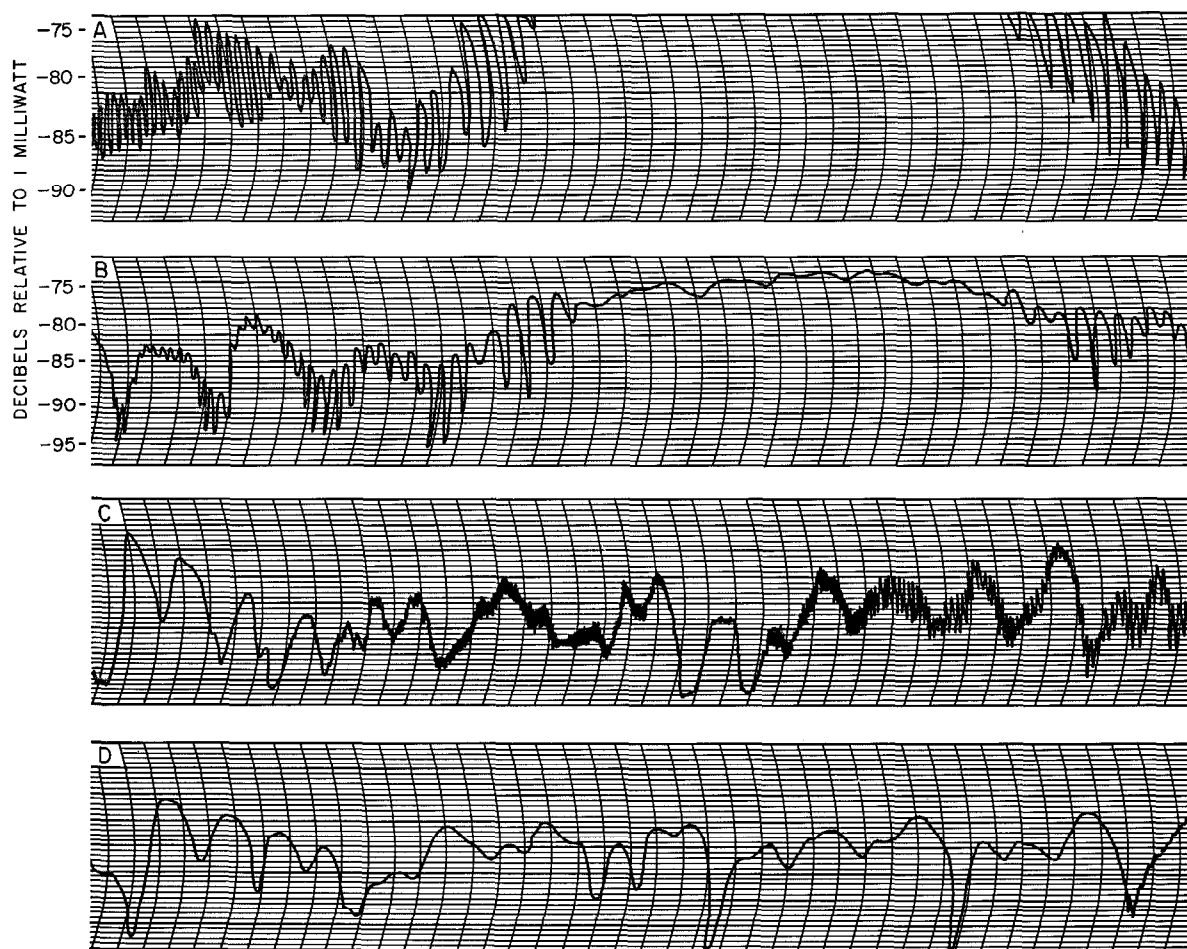
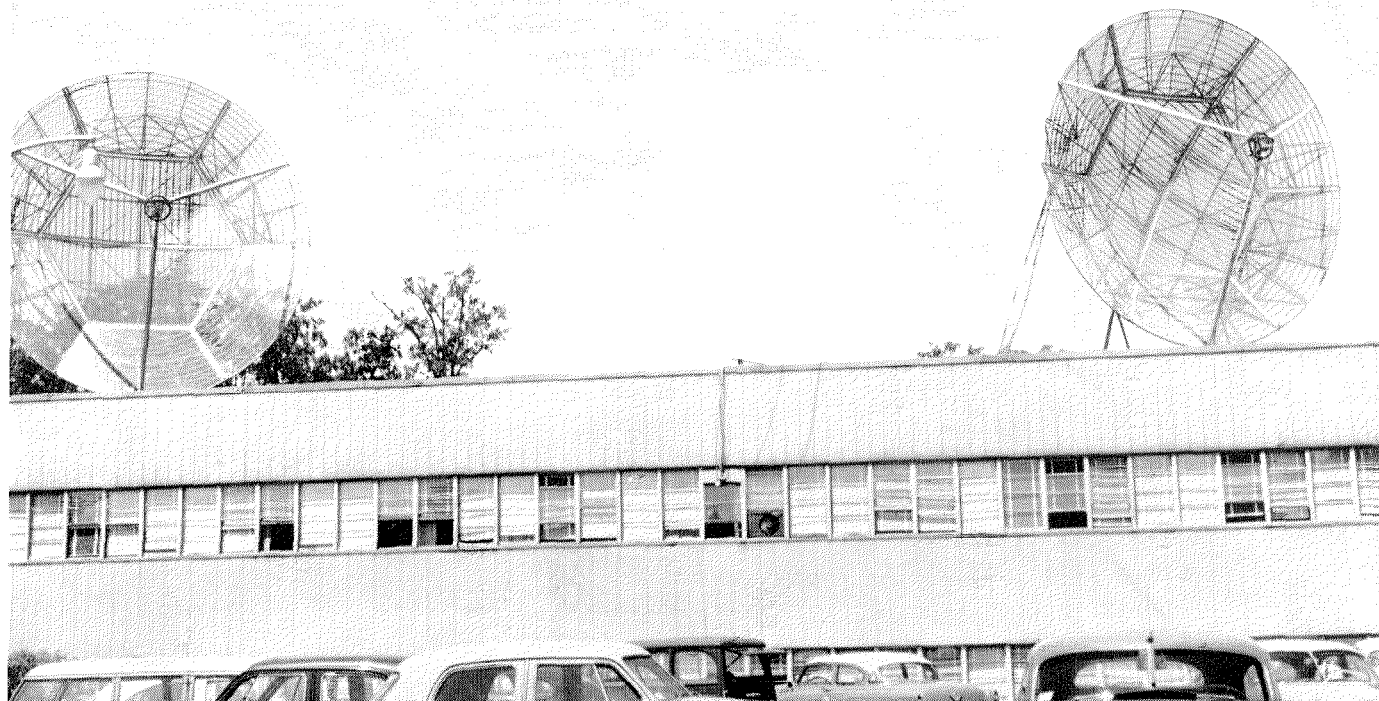

Figure 12—Recordings showing effect of airplane reflection when using, *A* and *C* = wide-beam 10-foot (3-meter) antenna, *B* and *D* = narrow-beam 28-foot (8.5-meter) antenna. Horizontal time scale = 2 divisions per second.



Diversity system consisting of two 28-foot (8.5-meter) paraboloidal antennas each having a dual-polarization horn.

Simplified Diversity Communication System for Beyond-the-Horizon Links*

By FREDERICK J. ALTMAN and WILLIAM SICHAK
Federal Telecommunication Laboratories, a division of International Telephone and Telegraph Corporation; Nutley, New Jersey

FOR NEARLY A YEAR, a 900-mega-cycle-per-second beyond-the-horizon two-way link has been in operation between Nutley, New Jersey, and Southampton, Long Island, New York. Early results using pulse-time modulation have already been reported.¹ Briefly, an annual median path loss some 20 decibels greater than that predicted by Bullington was found, but the bandwidth was adequate for pulse modulation. Since then, frequency modulation, frequency-division multiplex, and diversity

reception have been employed. This report covers the present system, with special emphasis on equipment economies achieved and an analysis of diversity combining methods.

1. Description of System

1.1 SYSTEM PARAMETERS

The system parameters are summarized in the power and frequency diagram of Figure 1. Type-9H2 carrier equipment provides 6 channels plus an order wire within a 36-kilocycle band. Three channels are used in the west-east direction as shown. Modulator output levels are set to equalize signal-to-noise ratios for all channels. The transmitters are modified type-20-B ultra-high-frequency television aural units with 500 watts output. The antennas are 28-foot (8.5-

* Reprinted with revisions from *IRE Transactions on Communication Systems*, volume CS-4, pages 50-55; March, 1956. Copyright © 1956 by The Institute of Radio Engineers, Incorporated.

¹F. J. Altman, R. E. Gray, A. G. Kandoian, and W. Sichak, "900-mc PTM Over-the-Horizon Link," *IRE Transactions on Microwave Theory and Techniques*, volume MTT-3, pages 22-26; December, 1955; also, *Electrical Communication*, volume 33, pages 143-150; June, 1956.

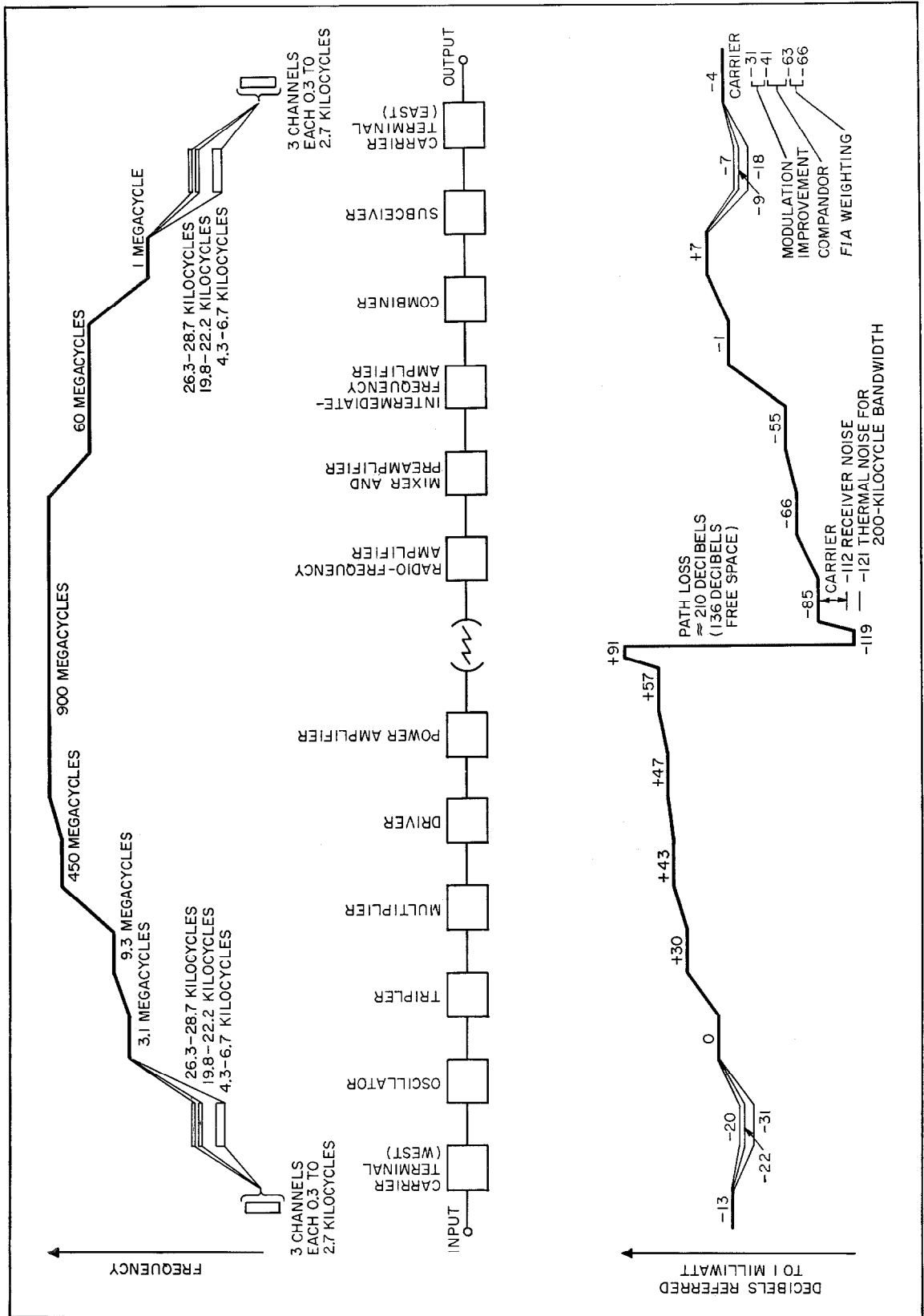

Figure 1—Power and frequency diagram of the link.

meter) paraboloids with about 34 decibels gain. The annual median path loss is shown as 210 decibels. The receiver will be discussed in some detail. Type-NUS-3079 companders are used to provide an apparent signal-to-noise improvement of 22 decibels when the carrier is above threshold. Cross talk is down some 55 decibels.

1.2 ANTENNA ARRANGEMENTS

To obtain diversity reception without installing a second 28-foot (8.5-meter) paraboloid and a 45-foot (13.7-meter) tower at Southampton,

a 3-antenna system was devised as indicated in Figure 2. East-to-west communication is conventional, but west-to-east is able to use the same paths by splitting the transmitter power and transmitting in both vertical and horizontal electric-field polarization planes so that independently received signals may be derived from a single antenna. The power split introduces a 3-decibel loss in one direction, but this is a small price in view of the antenna saved and the diversity gain achieved. Figure 3 is the complete block diagram showing the diplexers required to isolate transmitters and receivers.

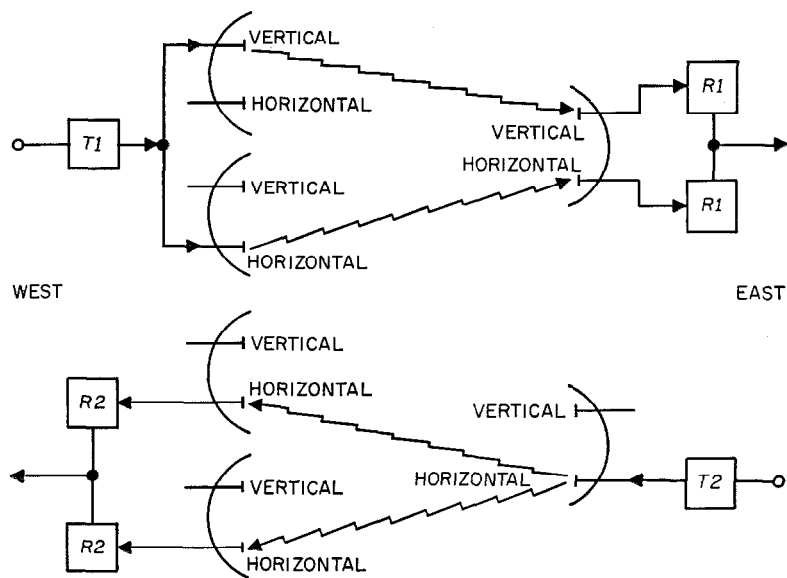

Figure 2—Method of obtaining 2-way diversity using only 3 large paraboloidal antennas.

If, now, this power-splitting feature is made symmetrical, 4-fold diversity may be obtained by adding only another antenna and the necessary receivers as in Figure 4. In fact, as will be shown shortly, considerably less than complete receivers are required. This scheme might be said to combine the usual or receiver diversity with the new or transmitter diversity. That is, each transmitter sends from 2 points to 2 receivers. The system is now symmetrical and can provide a total diversity gain of as much as 27 decibels according to Figure 15.

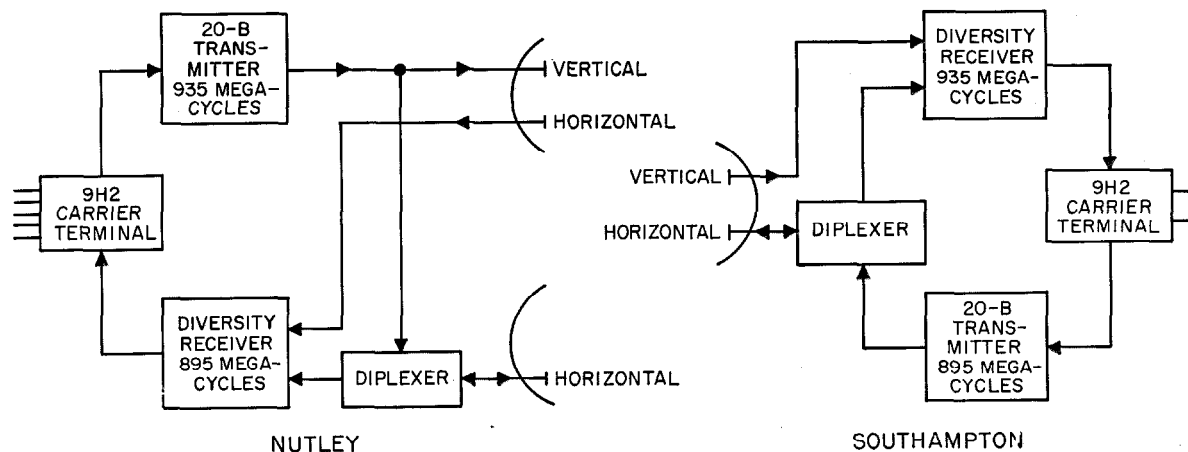

Figure 3—Block diagram of the link. The paraboloids are 28 feet (8.5 meters) in diameter.

1.3 SIMPLIFIED RECEIVER

A diversity system uses, of necessity, several similar receiving channels. It is of interest to study the possibility of eliminating duplication

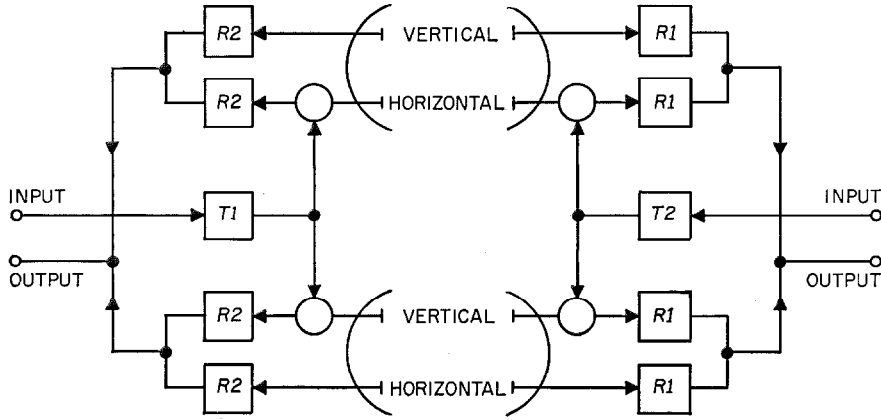

Figure 4—By using 4 paraboloids and 2 polarizations, 4-fold diversity may be obtained. Each transmitting paraboloid irradiates both receiving paraboloids. The small circles indicate diplexers.

of similar elements. To combine before detection, however, the signals must all be phased together. For phase control, fairly large control signals of the order of 1 volt are preferred, so it seems appropriate to combine at about this level to avoid duplicate signal and control chains. The block diagram of such a receiver is shown in Figure 5.

The nonduplicated element is, of course, the sub-carrier frequency-modulation receiver, complete with limiters, wide-band detector, and low-distortion base-band amplifier. The phase error is detected as shown and a

proportional voltage is used to control one of the 61-megacycle oscillators. This arrangement has worked very well, but it is being improved and extended in its application. Data taken with a totalizing recorder indicate that during conditions when the signal strength obeys the Rayleigh distribution, the diversity gain derived below is realized.

2. Statistical Evaluation of Combining Systems

2.1 DEFINITIONS

Diversity systems have long been used, but there appears to be a need for clarification of terminology, exposition of characteristics, and

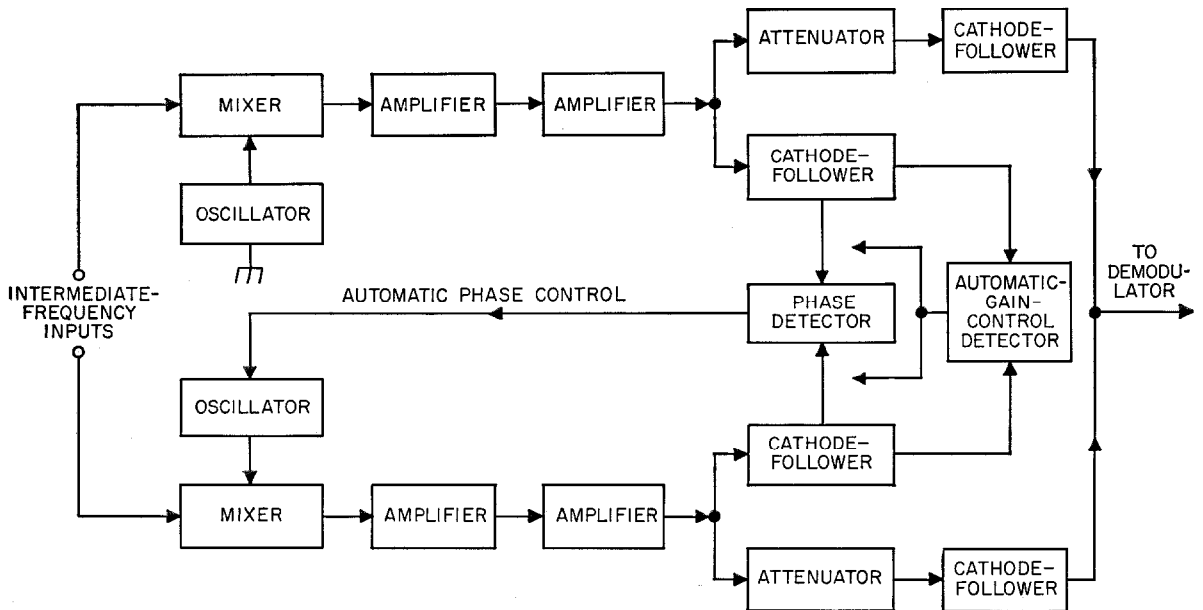

Figure 5—Type of diversity receiver employed.

statistical evaluation of performance. This is attempted below.

A combiner is here defined as a means that combines 2 or more diversity signals into 1.

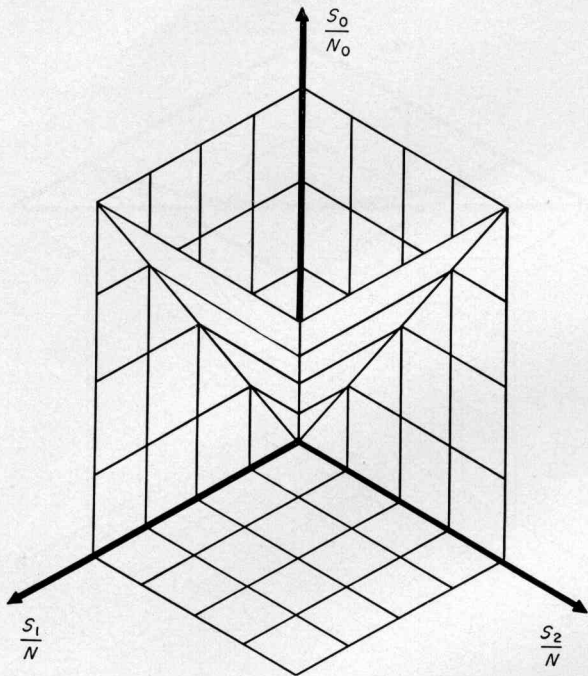

Figure 6—Three-dimensional characteristic of selector combiner.

Three different types are defined in accordance with their laws of operation: selector, linear adder, and ratio squarer. The selector determines the largest input and connects it to the output. The linear adder sums the signals and may be simply a connection of the inputs to the output. Presence or absence of common automatic gain control for the input devices is irrelevant. The ratio squarer² squares the inputs before addition.

2.2 CHARACTERISTICS FOR 2 SIGNALS

The characteristics of the 3 basic types of combiners may be summarized quite briefly, but it appears advisable for clarity to develop them in some detail. It is assumed in all cases that the 2 channels have the same noise figure and gain, that is, their average noise input powers are equal ($N_1 = N_2 = N$).

² L. R. Kahn, "Ratio Squarer," *Proceedings of the IRE*, volume 42, page 1704; November, 1954.

The selector method of combining acts at any given time as a single receiver whose output signal-to-noise ratio (S_o/N_o) is, therefore, that of the channel with the highest signal. This may be seen in the 3-dimensional representation of Figure 6. If the first-channel signal S_1 is zero, the characteristic is a line of unity slope in the $S_o - S_2$ plane. As S_1 increases, it does not at first affect this result for S_o/N_o remains a function of only S_2/N , so the characteristic becomes a plane perpendicular to the $S_o - S_2$ plane. As S_1 becomes greater than S_2 , there is, of course, a sharp transition to the plane corresponding to S_1 alone, and we thus find the complete characteristic of this type, the surface determining the output for arbitrary inputs.

For the linear combiner with one signal alone, the line in the $S_o - S_2$ plane has a slope of $1/(2)^{1/2}$, as 2 noise powers are being added at all times. These are not coherent, so the powers add linearly. The 2 signals, however, when phased alike, add voltages, so we find

$$\begin{aligned} S_o/N_o &= (S_1 + S_2)/(N^2 + N^2)^{1/2} \\ &= (S_1 + S_2)/(2)^{1/2}N. \end{aligned}$$

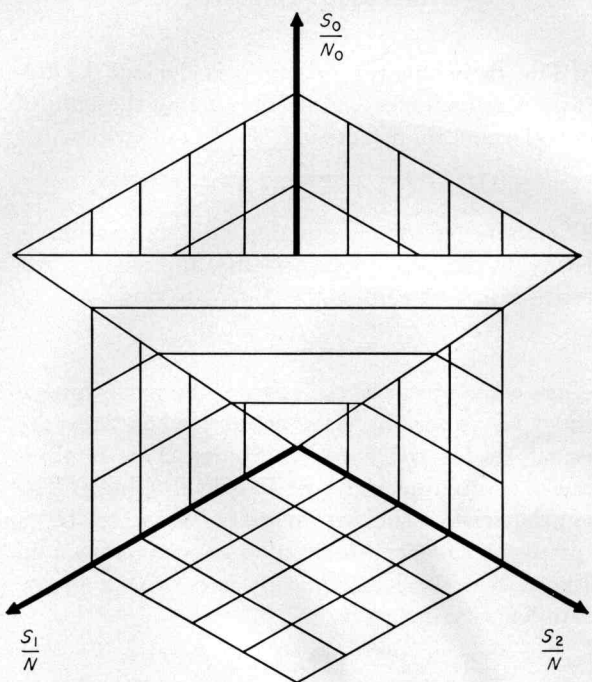

Figure 7—Three-dimensional characteristic of linear combiner.

Thus for constant S_o/N_o , the characteristic is a projection of a straight line in the $S_1 - S_2$ plane, and the operating plane of Figure 7 is derived.

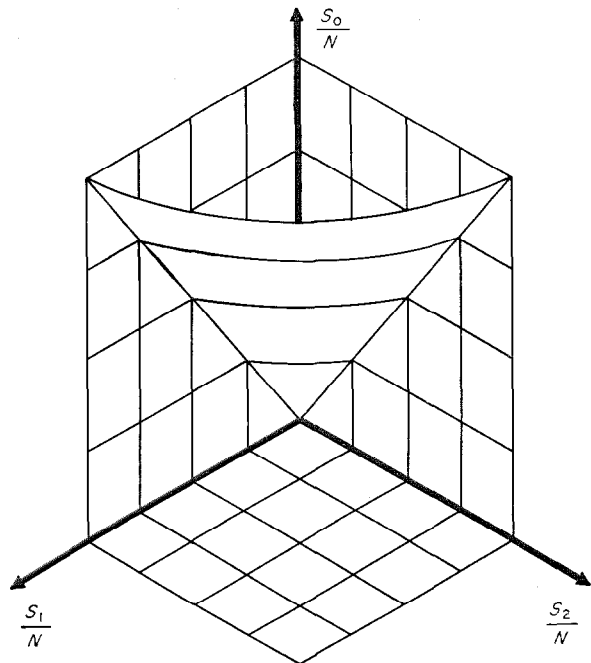

Figure 8—Three-dimensional characteristic of ratio-squaring combiner.

all slices perpendicular to the S_o axis will be similar except for scale factor. Therefore, all the essential characteristics may be summarized as in Figure 10, the loci of the input signals corre-

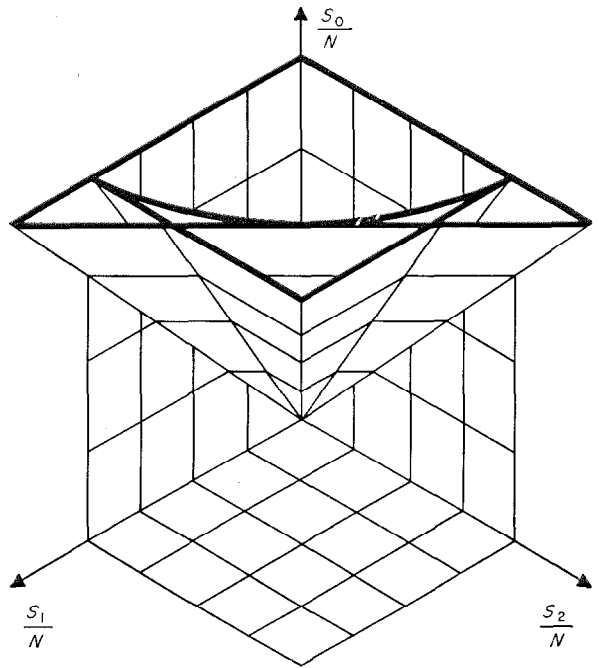

Figure 9—Combiner characteristics of Figures 6, 7, and 8 in one drawing.

The ratio-squarer principle is derived as follows. Let us, before addition, change the gain of one channel by a factor K , so that

$$S_o/N_o = (S_1 + KS_2)/(N^2 + K^2N^2)^{1/2}$$

The value of K maximizing this expression is easily found, by differentiating and setting the result equal to zero, to be S_2/S_1 , so now

$$S_o/N_o = (S_1^2 + S_2^2)^{1/2}/N$$

Thus when either signal is zero, the performance must be as for the selector, and when they are equal, as for the linear combiner. This is obviously combining the best features of both. The characteristic surface may be seen to be a quadrant of a right circular cone as shown in Figure 8 if the last equation is rewritten in the familiar circular form

$$(S_o/N_o)^2 = (S_1/N)^2 + (S_2/N)^2$$

The 3 surfaces that have been derived are shown together in Figure 9. It is apparent that

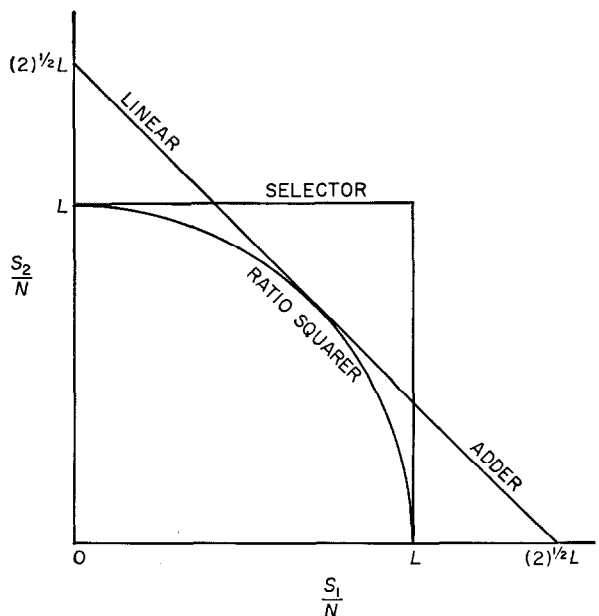

Figure 10—Characteristics of diversity combiners for an output signal-to-noise ratio of L .

sponding to a given output signal-to-noise ratio. This shows still more clearly the optimum nature of the ratio squarer, as a given output signal-to-noise ratio is achieved for the lowest input values, that is, nearest the origin.

2.3 PERFORMANCE FOR 2 SIGNALS

To evaluate the relative efficiencies of, for instance, the selector and the linear adder, one must consider the nature of the input signals. Clearly, if their ratio is near unity most of the

time, the linear adder is more desirable, and vice versa. To obtain a quantitative measure of performance, the probability of occurrence of a combination of signals corresponding to any region on the plane must be derived, and then integrated over the area within a locus. The mathematical details are presented in the appendix in section 3, but some physical pictures again seem appropriate.

The instantaneous distribution of the amplitudes of the envelope of the signal is usually assumed to follow the Rayleigh law as it is ordinarily a result of scattering; that is, the sum of random vector components. This density function is portrayed at the left of Figure 11, while the Gaussian or normal function is at the right. These curves may be more familiar to the reader as the probability densities of envelopes of noise voltage and noise-plus-signal, respectively.³ In the case of interest here, there are 2 inputs and the 2-dimensional Rayleigh distribution is required, Figure 12. The volumes must now be found by integration as in the appendix. The results for the case of most interest, weak signals near the receiver threshold, are graphically portrayed in Figure 13. From this it may be seen that in this important case, the

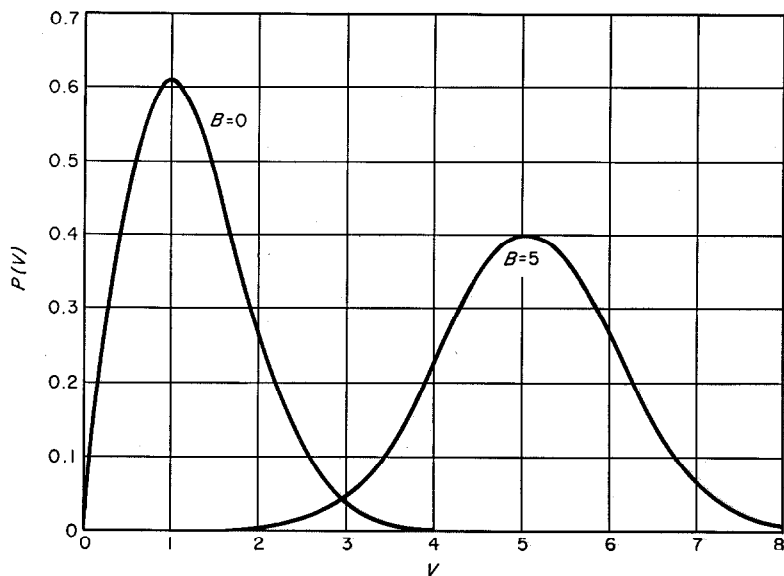

Figure 11—Probability density of envelope amplitudes of the sum of fixed and random components. $V = (\text{peak value of envelope})/(\text{root-mean-square value of the random component})$. $B = (\text{peak value of the fixed component})/(\text{root-mean-square value of the random component})$.

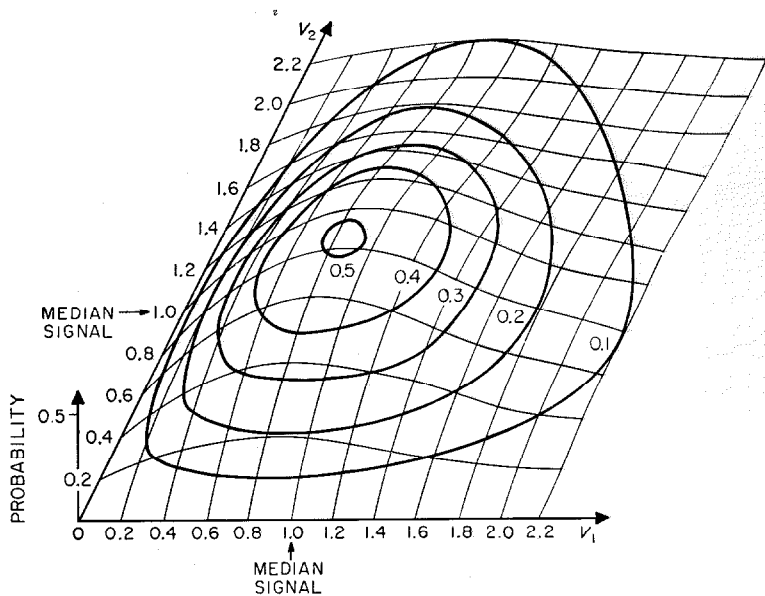

Figure 12—Two-dimensional Rayleigh distribution.

$$dp = 1.38 V_1 \exp(-0.69 V_1^2) dV_1 = 1.38 V_2 \exp(-0.69 V_2^2) dV_2$$

³ S. O. Rice, "Mathematical Analysis of Random Noise," *Bell System Technical Journal*, volume 24, pages 46-156; January, 1945.

3.2 TWO SIGNALS

where

$$Q = 1/(2\pi)^{1/2} \int_0^{(2)^{1/2}aL} \exp(-x^2/2) dx$$

= probability integral.

3.2.1 Selector

For 2 uncorrelated signals of the same median value, the probability that both signal-to-noise ratios are equal to or less than L is

$$p = [1 - \exp(-a^2L^2)]^2.$$

This approaches a^4L^4 for small values of aL .

3.2.2 Linear Addition

The probability that the sum of the 2 signal-to-noise ratios is equal to or less than

$$p = \int_0^{(2)^{1/2}L} \exp(-a^2x^2) 2a^2x dx$$

$$\times \int_0^{(2)^{1/2}L-x} \exp(-a^2y^2) 2a^2y dy$$

$$= 1 - \exp(-2a^2L^2) - 2\pi^{3/2}aL \exp(-a^2L^2)Q,$$

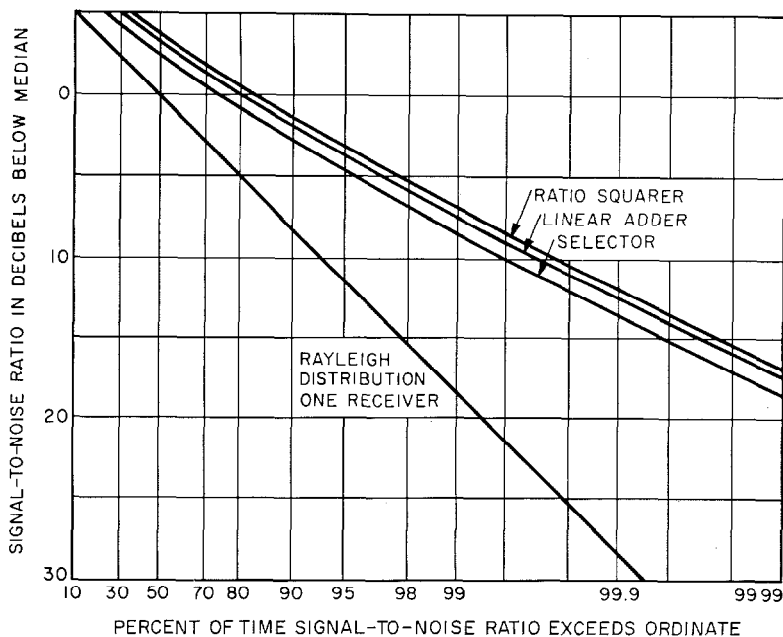

Figure 14—Signal-to-noise distribution for dual diversity using various combining methods.

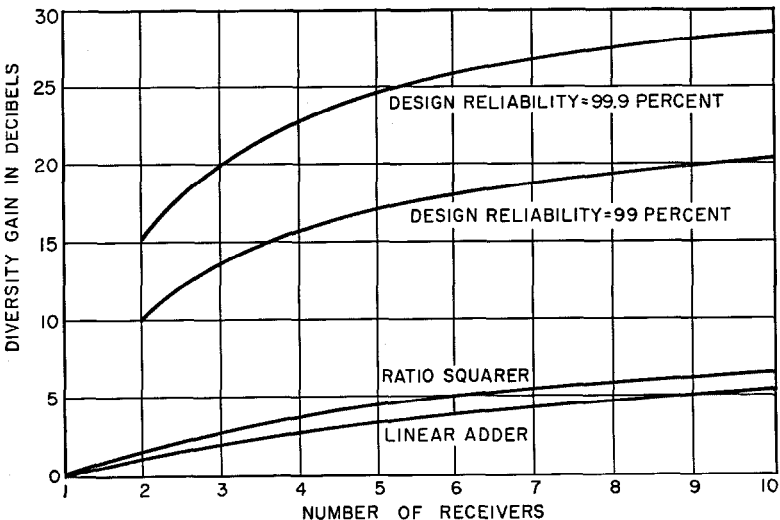

Figure 15—Diversity gain as a function of the number of receivers. The design reliability curves are based on selector combining and the lower curves give the additional improvement obtained with the other two combining methods.

For small values of aL , p approaches $(2/3) a^4L^4$. Power goes as L^2 , so the ratio of this power to that for the selector is $(2/3)^{1/2}$, or 0.9 decibel less signal required.

3.2.3 Ratio Squarer

The probability that the 2 signal-to-noise ratios fall within or on a circle of radius L is

$$p = \int_0^L \exp(-a^2x^2) 2a^2x dx$$

$$\times \int_0^{(L^2-x^2)^{1/2}} \exp(-a^2y^2) 2a^2y dy$$

$$= 1 - (1 + a^2L^2) \exp(-a^2L^2).$$

For small values of aL , this

approaches $a^2L^4/2$, corresponding to a gain over the selector of 1.5 decibels.

3.3 N SIGNALS

By using the same method given above, the probability distributions for N antennas can be calculated. Thus, for 3 antennas, the probability distribution for 1 antenna is used for the first integration, while the probability distribution for 2 antennas is used for the second integration.

For the selector, the result for the 2 signals above merely needs to be generalized. For the ratio squarer, the integrations can be performed exactly. For the linear-addition case, however, integrals in closed form could not be obtained. An approximate solution (accurate for levels as least as high as the median on 1 antenna) was obtained by expanding the probability distributions before integrating.

3.3.1 Selector

$$p = [1 - \exp(-a^2L^2)]^N = (aL)^{2N} \text{ for } aL \ll 1.$$

3.3.2 Linear Addition

$$p \approx [2^N/(2N!)](aL)^{2N}.$$

3.3.3 Ratio Squarer

$$\begin{aligned} p &= 1 - \{1 + (aL)^2 + [(aL)^4/2] + \dots \\ &\quad + [(aL)^{2(N+1)}/(N-1)!]\} \exp(-a^2L^2) \\ &= \{[(aL)^{2N}/N!] + [(aL)^{2(N+1)}/(N+1)!] + \dots\} \\ &\quad \times \exp(-a^2L^2). \end{aligned}$$

The gain due to the combining method is the ratio of the signal to noise at a given probability to the signal to noise at the same probability with the selector method. The gain for the ratio-squarer method is thus $(N!)^{1/N}$. The gain for the linear-addition method is $[(2N)!]^{1/N}/2N$. These gains are plotted on the lower part of Figure 15. It may be seen that the linear-adder performance is within 1 decibel of that of the ratio squarer.

The gain G , due to the order of diversity on a selector basis, is found from (2). Solving for a^2L^2 , we have

$$-a^2L_N^2 = \log(1 - p^{1/N}).$$

Similarly,

$$-a^2L_1^2 = \log(1 - p).$$

Thus,

$$\begin{aligned} G &= L_N^2/L_1^2 \\ &= \log(1 - p^{1/N})/\log(1 - p). \end{aligned}$$

The gain so computed is shown by the upper curves of Figure 15.

Configurations for Beyond-the-Horizon Diversity Systems

By **FREDERICK J. ALTMAN**

Federal Telecommunication Laboratories, a division of International Telephone and Telegraph Corporation; Nulley, New Jersey

DIVERSITY receivers having different locations, frequencies, or polarizations¹ may receive signals whose amplitude or fading characteristics are sufficiently uncorrelated so that a combination of two or more signals fades less and so is much more reliable than the individual signals. This is true, in particular, of high-frequency ionospheric circuits and of beyond-the-horizon links using tropospheric scatter propagation.² In the latter, it is especially valuable because of the unusually high path losses of the order of 200 decibels. Diversity improves the signal-to-noise ratio to make possible one or more of the following: longer hops, wider bandwidths, reduced transmitter powers, smaller antennas, better signals, or increased reliability during equipment malfunctioning or the unfavorable meteorological conditions existing in some climates and seasons.

The recent application to beyond-the-horizon links³ of the dual-polarization method of exciting antennas has introduced a hitherto unexploited parameter to provide many as yet unused configurations. A systematic classification and nomenclature is described, and 26 systems, including those already well known, are derived from the elementary forms shown in Figure 1.

1. Classification

Consideration of a large number of configurations has led to a system of classification based on three factors: the number of polarizations P used for each frequency, the number of receiving antennas R , and the number of frequencies F .

¹ J. L. Glaser and S. H. Van Wanbeck, "Evaluation of Polarization Diversity Performance," *Proceedings of the IRE*, volume 41, pages 1774-1778; December, 1953.

² C. L. Mack, "Diversity Reception in UHF Long-Range Communications," *Proceedings of the IRE*, volume 43, pages 1281-1289; October, 1955.

³ F. J. Altman, R. E. Gray, A. G. Kandoian, and W. Sichak, "900-mc PTM Over-the-Horizon Radio Link," *IRE Transactions on Microwave Theory and Techniques*, volume MTT-3, pages 22-26; December, 1955; also *Electrical Communication*, volume 33, pages 143-150; June, 1956.

$P = 1$ and R and F are here arbitrarily limited to 1 or 2. Thus, a typical designation is 121. Figure 2 shows examples from 111 to 222. It may be noted that there are several variations of some of the classes. The class designation is in general applied to the member with the maximum order of symmetry; other members are characterized as redundant ('), degenerate (-), or alternative (a, b). Use of the dual-excited horn antenna with both horizontal and vertical polarizations is shown by the semipictorial representation \underline{IRF} . Its use is required for all forms 2RF, so the underline is not needed.

FORM	BASIC	REDUNDANT	
		SINGLE PRIME (')	DOUBLE PRIME ('')
A VERTICAL OR HORIZONTAL			
B ALL VERTICAL OR ALL HORIZONTAL			
C			
D			

Figure 1—Basic form of diversity systems. T = transmitter, V = vertical polarization of the electric field, and H = horizontal polarization.

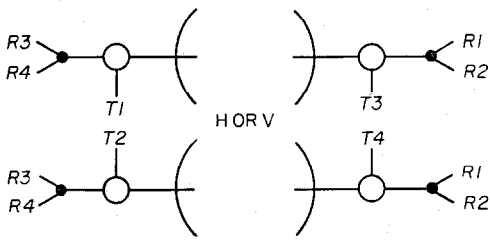

122

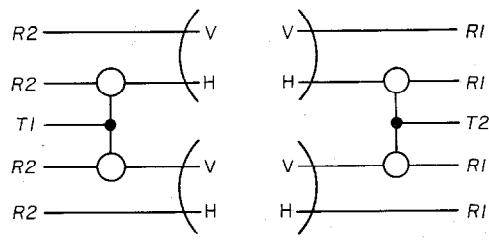

221

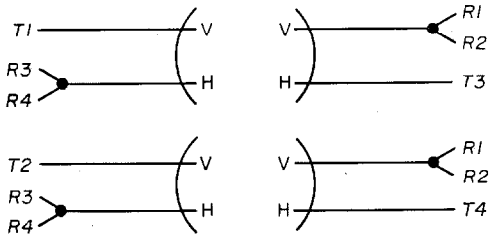

122a

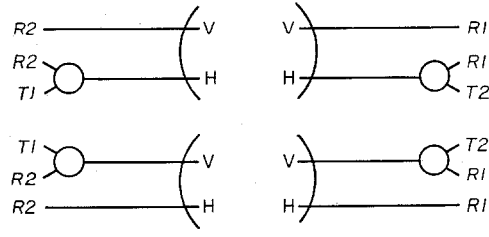

221'

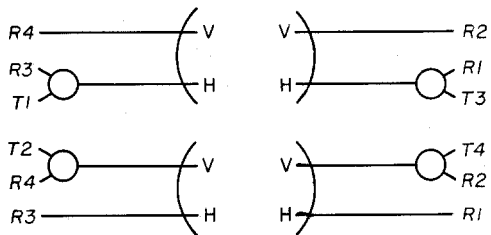

122b

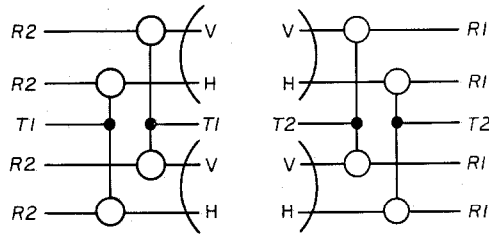

221a

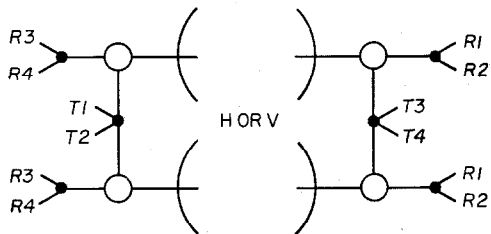

122a

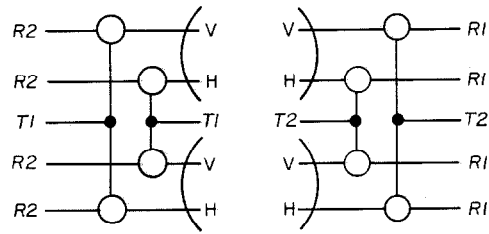

221b

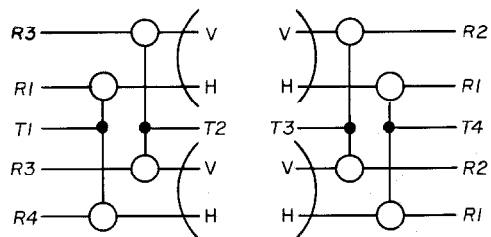

122

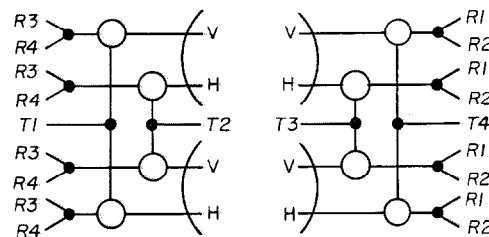

222

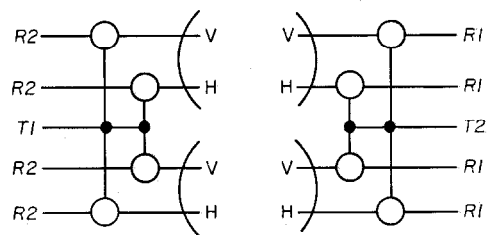

221a

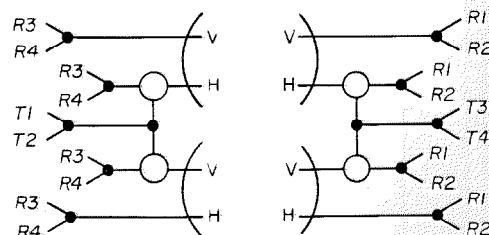

222a

antenna excitation is indicated by underscoring the first number. Redundant systems are indicated by a prime after the number, alternative by a letter, and degenerate systems by a minus sign. The circles indicate duplexers.

2. Basic Forms

Preliminary to deriving the final forms, the elementary transmitter configurations of Figure 1 are considered. The four arrangements in the left-hand column are basic; those in the right-hand columns are considered to be redundant forms and are identified as being single- or double-prime variations. Only a few redundant examples are listed later, none double primed, as these are obvious in formation and application. Form *A* is, of course, trivial and is included for completeness. Form *B* is used particularly in the single-primed form for reliability. As seen from the receiving position, this form radiates like a single antenna supplied with full transmitter power. There is no lobe structure from interference between two sources because of the incoherent reradiation of the medium. Form *C* is used only in the special configuration 211. Form *D* is valuable because it permits transmission over two independent paths to a single receiving antenna equipped for dual-polarized reception.

3. Combined Forms

The basic forms may be combined into the 26 types shown in Figures 2A and 2B. Transmitters are denoted by *T*, receivers by *R*, frequencies by numbers, and diplexers by small circles. Type

111 uses form *A* in both directions. Its analog with dual-feed horn for polarization diplexing is $\underline{111}$. Type 112 uses *A* on each of two frequencies in both directions. There are two analogs, $\underline{112}$ and $\underline{112a}$. Full diplexers are not required for 112 because the signals to be isolated are at similar power levels and the dual horn provides 40 to 50 decibels of isolation. Three-antenna space diversity, 211, uses *C* from right to left and *D* from left to right. Type 211*a* is another mixed type; it uses forms *A* and *D*. Double the number of frequencies yields 212. Types 121- and $\underline{121}$ - use form *A*; types 121 and $\underline{121}$ use form *B*, and types 121' and $\underline{121}'$ use form *B'*. Using two frequencies in each direction, the three analogs, 122, $\underline{122a}$, and $\underline{122b}$ are obtained from *A*. Similarly, 122*a* and 122 are obtained from *B*. If polarization is exploited instead of frequency, 221 and 221' are derived from *D* and *D'*. Type 221'*a* may be considered as of form *B''* and 221'*b* as *D''*, but they are both equivalent to 221*a*. All three will provide 4-fold diversity only when the transmitter feed-line lengths are so related that the two antennas on one side emit orthogonally, that is with the vertical-horizontal resultants in perpendicular planes or of opposite screw sense, et cetera. Type 222 and the alternative 222*a* use both frequency and polarization to produce forms that may be characterized as *D''*.

Design Chart for Tropospheric Beyond-the-Horizon Propagation

By FREDERIK J. ALTMAN

Federal Telecommunication Laboratories, a division of International Telephone and Telegraph Corporation; Nutley, New Jersey

A SUMMARY of several well-known factors and of propagation data available at this time is given in Figure 1 to facilitate the selection of equipment and for computing the carrier-to-noise ratio for tropospheric propagation beyond the horizon. Three sample computations are given in Table 1 to demonstrate the use of the appropriate curves to derive in an orderly fashion the necessary information. Certain data, such as antenna gain or receiver noise factor, may be available from other sources for the specific equipment to be used. The distribution of excess scatter loss L_{BH} represents winter hourly medians in the temperate zone so that considerable signal increase may be expected under more-favorable meteorological conditions. The 50-percent L_{BH} curve is for the median value that will be exceeded 50 percent of the time, or conversely the design resulting from the use of this loss has a reliability of 50 percent. The additional margin required for a reliability of 99.99 percent is shown in the next to the bottom line of the table.

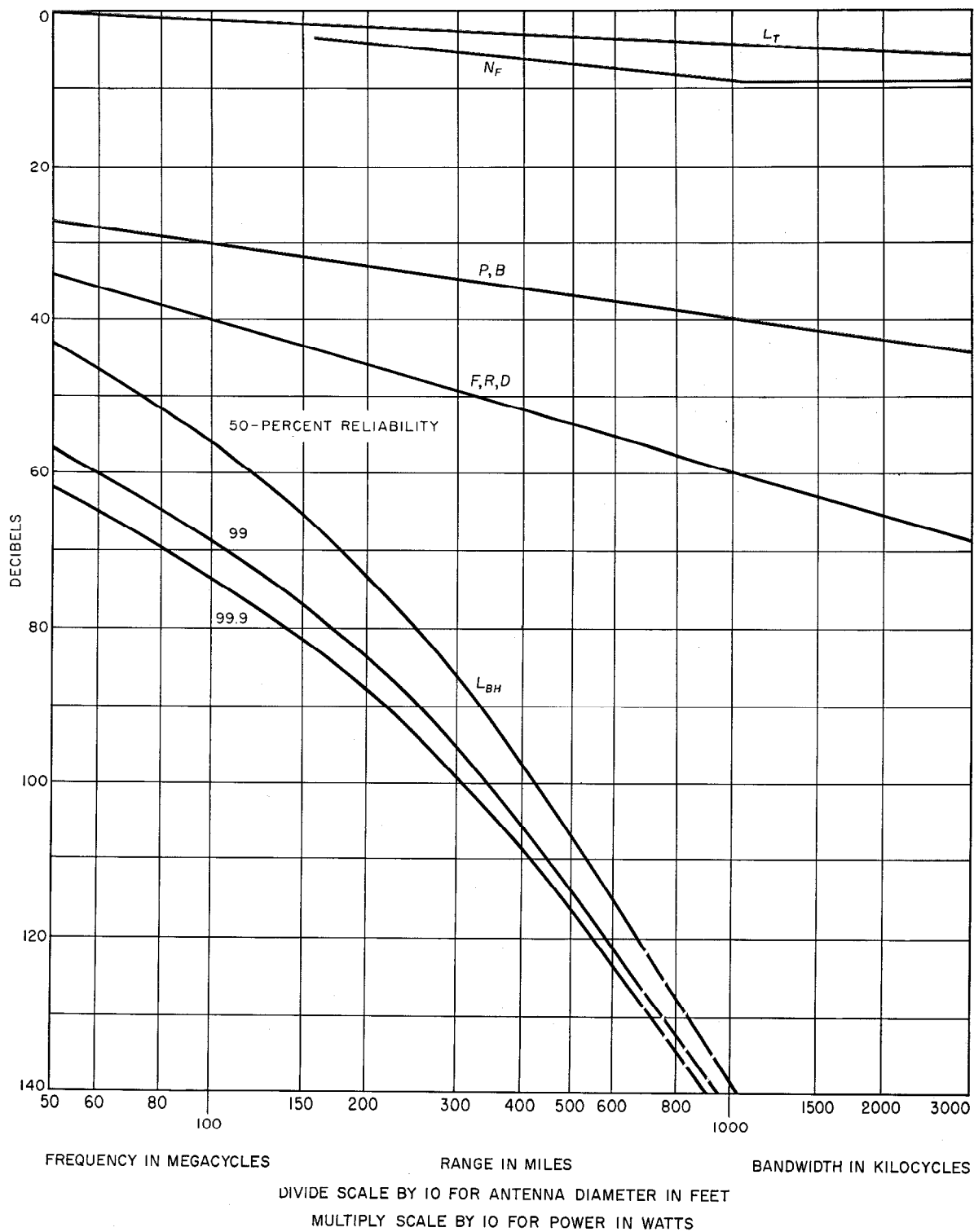

Figure 1—Design chart for beyond-the-horizon tropospheric propagation.

TABLE 1
COMPUTATIONS FOR BEYOND-THE-HORIZON LINKS

Symbol and Factor	Equation	Curve of Figure 1	Example 1		Example 2		Example 3	
			Value	Decibels	Value	Decibels	Value	Decibels
F = Frequency	$20 \log f_{mc}$	F	900 mc	59	2000 mc	66	300 mc	50
R = Range	$20 \log r_{mi}$	R	90 mi	39	200 mi	46	400 mi	52
K_p = Propagation Constant	See Note 1			37		37		37
L_{FS} = Free-Space Loss	$F + R + K_p$			135		149		139
L_{BH} = Median Beyond-the-Horizon Loss	See Note 2	$L_{BH} 50\%$	90 mi	54	200 mi	72	400 mi	98
L_T = Terminal Loss	$5 \log f_{mc} - 10$	L_T	900 mc	5	2000 mc	6	300 mc	3
L = Total Loss	$L_{FS} + L_{BH} + L_T$			194		227		240
D = Antenna Diameter	$20 \log 10 d_{ft}$	D	28 ft	49	60 ft	55	100 ft	60
F = Frequency	$20 \log f_{mc}$	F	900 mc	59	2000 mc	66	300 mc	50
Sum	$D + F$			108		121		110
K_a = Antenna Constant	See Note 3			73		73		73
G' = Antenna Gain, Uncorrected	$D + F - K_a$			35		48		37
Gain for 2 Antennas	$2G'$			70		96		74
L_c = Antenna Aperture-to-Medium Coupling Loss	See Note 4			2		4		2
G_N = Net Antenna Gain	$2G' - L_c$			68		92		72
P = Power Ratio	$10 \log P_w$	P	500 w	27	10 kw	40	50 kw	47
G_T = Total Gain	$G_N + P$			95		132		119
C = Median Carrier at Receiver	$G_T - L$			-99*		-95*		-121*
B = Bandwidth	$10 \log b_{kc} + 10$	B	200 kc	33	600 kc	38	60 kc	28
F_N = Receiver Noise		F_N	900 mc	9	2000 mc	9	300 mc	5
Sum	$B + F_N$			42		47		33
K_N = Noise Constant	$0.01 kT^\circ$		293°	184	293°	184	293°	184
N = Noise	$K_N - (B + F_N)$			-142*		-137*		-151*
C/N = Median Carrier/Noise	$C - N$			43		42		30
ΔL_{BH} = Margin of Beyond-the-Horizon Loss	50%–99.9%	L_{BH}	90 mi	18	200 mi	15	400 mi	10
Minimum Long-Term C/N	$(C - N) - \Delta L_{BH}$			25		27		20

* = decibels referred to 1 watt

° = degrees Kelvin

% = percent

ft = feet ($\times 30.48$ = centimeters)

kc = kilocycles per second

kw = kilowatts

mc = megacycles per second

mi = miles ($\times 1.609$ = kilometers)

w = watts

k = Boltzmann's constant

Note 1. "Reference Data for Radio Engineers," Federal Telephone and Radio Company, New York, New York, third edition, 1949: page 436.

Note 2. W. E. Morrow, "Ultra-High-Frequency Transmissions Over Paths of 300 to 600 Miles," presented at Symposium on Scatter Propagation of the New York Section of the Institute of Radio Engineers, New York, New York, on January 14, 1956.

Note 3. "Reference Data for Radio Engineers," page 437: 20 decibels added to constant to compensate for use of $10 d_{ft}$.

Note 4. Aperture-to-medium coupling loss has been measured as being 4.5 decibels for 46-decibel-gain antennas 150 miles apart. For much lower gains and for distances substantially shorter or longer, this loss may be negligible.

Range of Multichannel Radio Links Between 30 and 10 000 Megacycles*

By HELMUT CARL

C. Lorenz A.G.; Stuttgart, Germany

WITHIN TEN YEARS, the range of directional radio links operating at frequencies above 30 megacycles per second has been extended from between 30 and 50 miles (50 and 80 kilometers) to about 250 miles (400 kilometers), that is, far beyond the horizon. This paper is a summary of the facts behind this evolution.

1. Factors Affecting Range

The range of a radio link for the transmission of information with commercial quality, specifically those conforming to the recommendations of the Comité Consultatif International, is essentially determined by the following factors: transmitter power, antenna gain, noise figure of the receiver, type of modulation, and attenuation over the transmission path. Details of minor importance are neglected in this general review.

2. Receiver Noise and Modulation

Compared with the other factors, the variation of the noise figure of the receiver is low. It does not exceed ± 3 decibels from an average value of 10 decibels in the frequency range assigned to radio links.

The noise threshold of a receiver is determined by its input noise power. This threshold must be exceeded by the signal power for useful communication. The noise power at the receiver input is a direct function of the bandwidth. Radio-frequency and intermediate-frequency amplifiers of modern multichannel radio link systems provide acceptance bandwidths ranging from 0.5 to 40 megacycles per second, the wider band producing 19 decibels more noise input power than the narrower band.

* Originally published under the title "Die Grenzen der Reichweite von Richtfunkstrecken für Vielkanalübertragung im Frequenzgebiet von 30...10 000 MHz" in *SEG-Nachrichten*, volume 3, number 4, pages 185-187; 1955.

Taking into account the average receiver noise figure of 10 ± 3 decibels, the absolute value of the noise power across the receiver input is, hence, between -110 and -85 decibels referred to 1 milliwatt (dbm). This corresponds to a noise voltage of 1 to 15 microvolts in an input impedance of 60 ohms. A signal-to-noise ratio of 20 decibels is indispensable for reliable operation and requires that the minimum receiver input power be between -90 and -65 decibels referred to 1 milliwatt, corresponding to 10 to 150 microvolts.

If the system consists of but one radio link between two terminal stations, these values generally ensure satisfactory transmission quality. If however there are many sections as in a transcontinental or coast-to-coast system, another 25 decibels must be added to provide increased quality in each link to avoid an unacceptably large total deterioration as a result of the many handlings of the information being transmitted. In other words, such systems will properly operate only with input powers of -65 to -40 decibels referred to 1 milliwatt or input voltages of 300 microvolts to 2 millivolts, respectively.

These values are rather independent of the carrier frequency and of the system of modulation. They are valid for operation without compressor and expander (comparator) equipment.¹⁻⁴

A comparator improves the speech channel by 20 decibels and the minimum required power may be reduced by 10 decibels if there is only one section in the entire radio system. Because of

¹ M. Jänke, E. Prenzel, and W. Speer, "Dynamik-pressor und -dehner für Fernsprechverbindungen," *Fernmeldetechnische Zeitschrift*, volume 6, pages 459-468; October, 1953.

² K. Steinbuch, "Neuentwicklungen auf dem Gebiet der Übertragungstechnik," *SEG-Nachrichten*, volume 3, number 1, pages 4-13; 1955.

³ G. Hässler, "Sprachübertragung mit Dynamikkompensation," *Fernmeldetechnische Zeitschrift*, volume 7, pages 659-664; December, 1954.

⁴ L. Christiansen, F. Buchholtz, and W. Zaiser, "Das Sechskanal-Kompandersystem Z 6 NC für den Fernsprechnahverkehr," *Fernmeldetechnische Zeitschrift*, volume 8, pages 502-511; September, 1955.

difficulties in operating close to the receiver threshold, full utilization of the compandor is not possible in this case.

In an individual section of a longer transmission path, the compandor can be utilized to its

full capacity, that is, the power input at the receiver may be as low as -60 decibels referred to 1 milliwatt. It should be kept in mind, however, that compandors are applicable only to speech transmission at present.

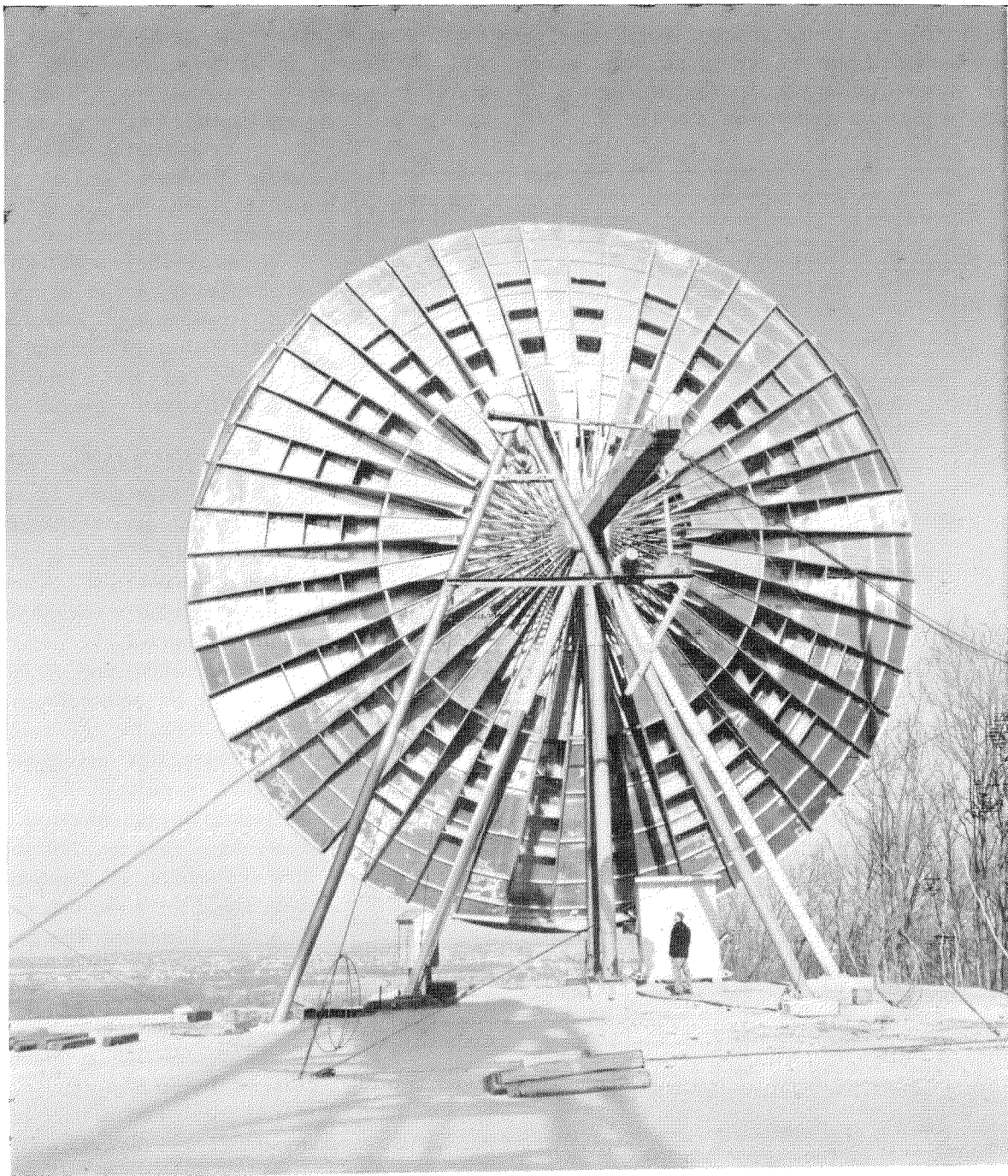

Figure 1—Paraboloidal reflector having a diameter of 20 meters (60 feet). Courtesy *Bell Laboratories Record*.

3. Antenna Gain

In contrast to the noise figure and input power required by the receiver, considerable variations that are dependent on frequency affect the transmitting power, transmission loss, and antenna gain.

The upper limit of the antenna gain is determined by two considerations. With regard to tropospheric beam refraction, the beam cannot be narrowed infinitely. A radiation angle of 0.7 degree between half-power points is the limit.

This can be achieved with a paraboloidal reflector having a diameter of 100 wavelengths, corresponding to a gain of 48 decibels referred to an isotropic radiator.

For a frequency of 2000 megacycles, 100 wavelengths are equal to about 50 feet (15 meters). Antenna reflectors of this diameter are costly in every respect; nevertheless, reflectors even 60 feet (20 meters) in diameter have been constructed for special purposes. Figure 1 shows such an antenna used for transmission of micro-

waves to a point beyond the horizon. Referred to isotropic radiators, antenna gains of 45 decibels can be obtained at 1000 megacycles with such structures. It can be assumed that paraboloidal reflectors about 100 feet (30 meters) in diameter can be fabricated without too many mechanical difficulties.

Assuming an antenna beam width of 0.7 degree and an antenna with an aperture of 100 feet (30 meters) in diameter, plotting antenna gain versus frequency produces the curves shown in Figure 2.

Between 1000 and 10 000 megacycles, the gain is limited to 48 decibels by the beam width. Below 1000 megacycles, the gain is reduced by the limitations in the mechanical dimensions. Between 200 and 300 megacycles, an improvement by about 3 decibels can be achieved because it is now possible to replace the paraboloid by a dipole array. The latter has an effective area that almost equals its geometric area, while the area efficiency of the paraboloid is only between 0.55 and 0.65. The gain decreases further as the frequency is lowered.

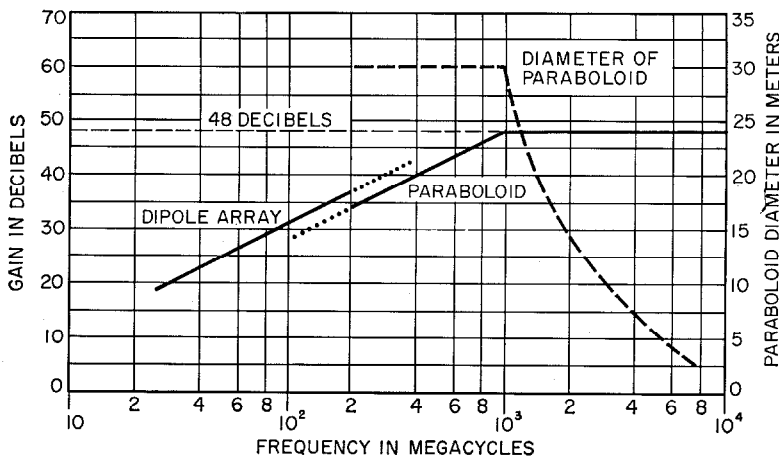

Figure 2—Maximum gain referred to an isotropic radiator of commonly used antennas.

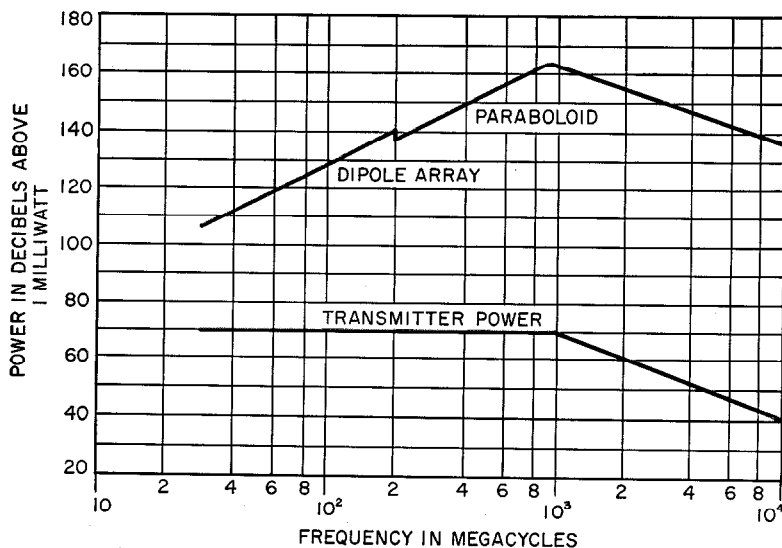

Figure 3—The maximum practical effective transmitting power for radio links is given in the two upper curves and includes the maximum available transmitter power (given in the lower curve) and the maximum gains of antennas of the types indicated.

4. Transmitting Power

Modern electron tubes will supply transmitting powers of an effective value of 10 kilowatts for frequencies between 30 and 1000 megacycles and recently even up to 2000 megacycles. For higher

attenuation will be related to the distance between the transmitter and receiver. However, an unequivocal correlation, even neglecting the dependence on frequency, of the magnitude of this attenuation can not be generally determined at

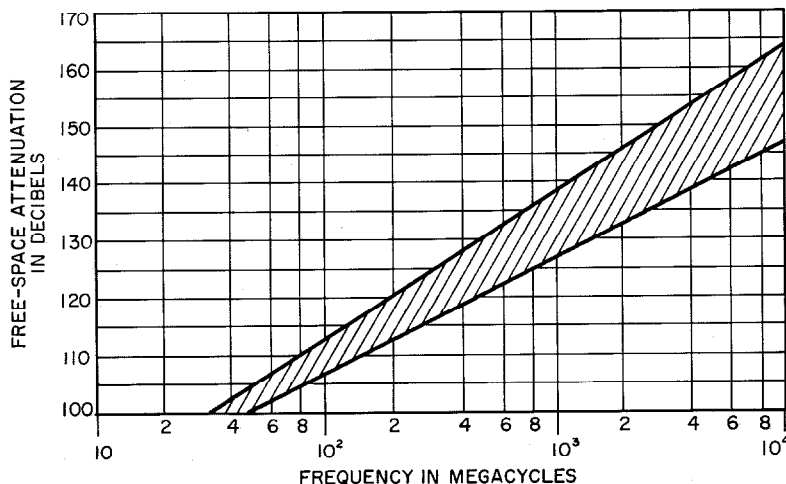

Figure 4—Free-space attenuation for a 50-kilometer (31-mile) path for median values (exceeded 50 percent of the time) with isotropic antennas is given in the lower curve. The margin to allow for fading and to produce 99-percent reliability is shown by the upper curve.

frequencies, the maximum possible power drops to, say, 10 watts for 10 000 megacycles, which is the limit of present-day engineering. This relation is plotted in the lower curve of Figure 3.

In a radio link, however, not only the power of the transmitter itself is important but also the effective power available in the direction of the desired transmission. This effective power is calculated by multiplying the transmitter power by the directional gain for both the transmitting and the receiving antennas. The product of this multiplication is shown in the upper part of Figure 3. It will be seen that the effective power has a maximum of 165 decibels referred to 1 milliwatt (or 10^{13} watts) at 1000 megacycles dropping to 135 decibels (10^{10} watts) at higher and to 110 decibels (10^8 watts) at lower frequencies.

5. Propagation Loss

The ratio of the available effective transmitted power to the minimum required power input at the receiver is a measure of the tolerable attenuation of each section of the radio link system. This

attenuation will be related to the distance between the transmitter and receiver. However, an unequivocal correlation, even neglecting the dependence on frequency, of the magnitude of this attenuation can not be generally determined at this time because of the tropospheric fading phenomena and of the diffraction and reflection of the propagated beam by obstacles. Therefore, measurements have to be compiled for each case individually. For two extremes, however, it is possible by approximation to establish rules that yield usable median values.

The first case is that for propagation within the lowest layers of the troposphere; it is optically undisturbed but is subject to fading. This transmission path has, so far, been regarded as an indispensable prerequisite for any acceptable microwave radio link. Figure 4 shows the transmission loss over a distance of 31 miles (50 kilometers). Free-space attenuation is plotted as a function of frequency in the lower curve and the additional margin required to provide for fading and to produce 99-percent reliability is shown by the upper curve. The fading values were taken from numerous available observations. Both free-space attenuation and fading increase with distance.

The second limiting case is for propagation far beyond the horizon which, contrary to former theories, can be utilized today for multichannel transmission of satisfactory quality at frequencies up to 5000 megacycles. Based on hitherto valid assumptions, calculations on beam propagation above the surface of a curved earth indicate that the loss of power beyond the horizon for tropospheric propagation is too large for useful communication to be possible. Contrariwise, the measured results published by Bullington⁵ showed that the transmission loss exceeds that of free space only by some 50 to 100 decibels,

⁵ K. Bullington, "Radio Transmission Beyond the Horizon in the 40- to 4000-Mc Band," *Proceedings of the IRE*, volume 41, pages 132-135; January, 1953.

depending on distance. This is evident in Figure 5. The values predicted by theory were 200 to 300 decibels. The additional loss is in practice independent of frequency. Fading effects are not much greater than with an optical path provided space diversity is used for its compensation.

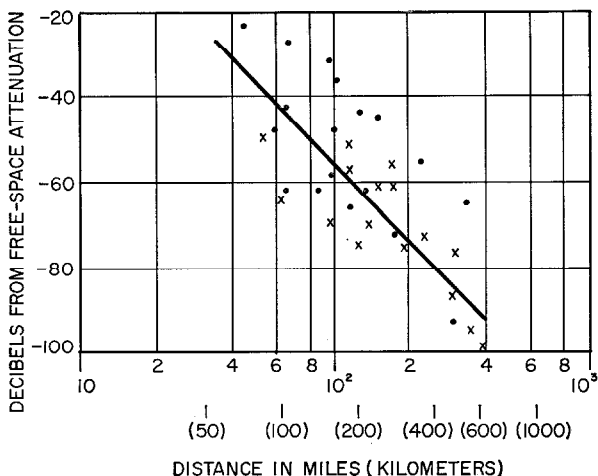

Figure 5—Median signal levels in the 300-to-4000-megacycle band. Ultra-high-frequency measurements are indicated by dots and super-high-frequency data by crosses.

6. Beyond-the-Horizon Propagation

An explanation that seems to be satisfactory both from the mathematical and the physical viewpoints is that the energy is scattered within the air volume penetrated by the radiation from the transmitting antenna toward the receiving antenna,⁶ as sketched in Figure 6. The height of the antenna is of minor importance.

The relation of transmission loss and distance for communication paths beyond line of sight is obtained by simple addition of the values published by Bullington to the free-space loss. Figure 7 shows this relation for several frequencies as a function of distance.

Figure 8 is the result of an evaluation of the effective-power curves given in Figure 3 and the attenua-

⁶H. G. Booker and J. T. deBettencourt, "Theory of Radio Transmission by Tropospheric Scattering Using Very Narrow Beams," *Proceedings of the IRE*, volume 43, pages 281-290; March, 1955.

tion for tropospheric propagation as given in Figure 7 to obtain numerical values of range for radio links beyond line of sight that can be achieved at present. The diagram shows that at a distance of 250 miles (400 kilometers) and a frequency of 1000 megacycles, an input voltage of 50 microvolts or -70 decibels referred to 1 milliwatt can be available to the receiver beyond the horizon. This would be sufficient for the transmission of 60 to 120 speech channels of moderate quality. Links of this type have already been investigated experimentally, and permanent operation is anticipated in the near future between Florida and Cuba and elsewhere.

Below 1000 megacycles, the range decreases with antenna gain and is about 155 miles (250 kilometers) for 30 megacycles. This distance is of the order of the radio links between Western Germany and Berlin, where tropospheric ranges were commercially utilized for the first time.⁷

For frequencies above 1000 megacycles, the available transmitter power decreases and the free-space loss increases even with constant antenna gain. This reduces the range. However experiments have shown that this range is still 125 miles (200 kilometers) for 4000 megacycles.

7. Conclusion

Although the possibility of operating microwave radio links over ranges that extend beyond the horizon has been established, the classical relay stations within line-of-sight range remain indispensable if high transmission quality, corresponding for instance to the recommendations of

⁷H. Carl and K. Christ, "Richtfunkverbindungen für Fernsprech- und Fernsehübertragung," *SEB-Nachrichten*, volume 3, number 3, pages 141-148; 1955.

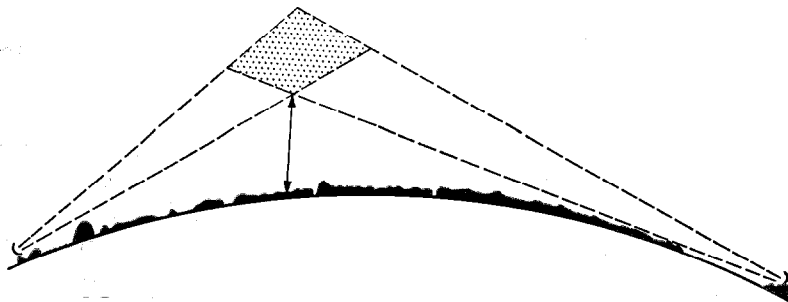

Figure 6—Principle of tropospheric propagation beyond the horizon. Scattering of the wave occurs in the region "viewed" by both antennas.

Figure 7—Attenuation as a function of distance for the indicated frequencies in megacycles is given in the 4 upper curves for free-space propagation. To them must be added the lowest curve, which gives the additional attenuation for beyond-the-horizon propagation.

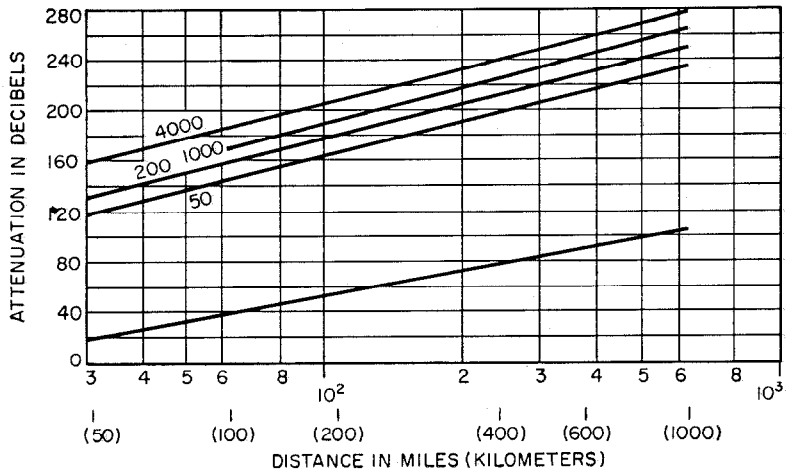
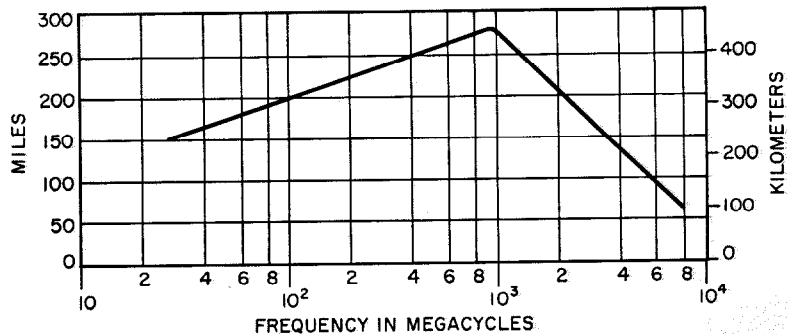

Figure 8—Distance plotted against frequency for an input to the receiver of -70 decibels referred to 1 milliwatt using the maximum radiated power and the path attenuation given in Figures 3 and 7.



the Comité Consultatif International Téléphonique, is to be provided. This is especially true since experience suggests that a moderate increase of antenna dimensions of the relay stations opens the possibility of extending the range,

which has been limited to 30 miles (50 kilometers) on the average. Both types of engineering, optical and beyond-line-of-sight ranges, will supplement each other advantageously in the future to meet varying purposes and requirements.

United States Patents Issued to International Telephone and Telegraph System; November 1955–January 1956

UNITED STATES patents numbering 44 were issued between November 1, 1955 and January 31, 1956 to the indicated companies in the International System. The names of the inventors, subjects of the patents, and Patent Office serial numbers are given below.

- J. L. Allison, Federal Telecommunication Laboratories, Bearing-Signal Quality Detector, 2 726 387.
- W. A. Anderson, Federal Telecommunication Laboratories, Inductive Coupling Circuits for Pulses, 2 729 793.
- M. Arditi and P. Parzen, Federal Telecommunication Laboratories, Frequency-Stabilization Systems, 2 726 332.
- A. J. Baracket, T. M. Maxwell, and F. H. Numrich, Federal Telecommunication Laboratories, Montage Amplifier, 2 723 307.
- E. S. L. Beale, Standard Telephones and Cables (London), Engine Indicators, 2 722 604.
- J. I. Bellamy and T. L. Bowers, Kellogg Switchboard and Supply Company, Multigroup Primary-Secondary-Spread Crossbar Telephone System, 2 725 428.
- J. I. Bellamy and L. Hemminger, Kellogg Switchboard and Supply Company, Transmitter for a Remote Supervisory and Control System, 2 729 813.
- J. F. Bigelow, Capehart-Farnsworth Company, Television Synchronizing System, 2 726-282.
- D. W. Black, Federal Telephone and Radio Company, Artificial-Barrier-Layer Selenium Rectifier, 2 724 079.
- M. C. Branch, P. M. King, and W. A. G. Walsh, Standard Telephones and Cables (London), Electrical Counting Circuits, 2 722 630.
- R. F. Chapman, Federal Telecommunication Laboratories, Diversity Reception System, 2 729 741.
- R. J. Cashman, Capehart-Farnsworth Company, Photoconductive Electrode, 2 730 638.
- A. G. Clavier and D. L. Thomas, Federal Telecommunication Laboratories, Transmission-Line System, 2 723 378.
- G. M. Cresson, International Standard Electric Corporation, Mounting-Plate Insulator and Assemblies, 2 723 302.
- C. L. Day, Capehart-Farnsworth Company, Article Comprised of a Metallic Part and a Ceramic Body, 2 728 425.
- E. M. Deloraine and J. J. B. Lair, Federal Telecommunication Laboratories, Telephone System, 2 723 309.
- G. C. Dewey, Federal Telecommunication Laboratories, Traveling-Wave Amplifier 2 730 649.
- M. Di Toro, Federal Telecommunication Laboratories, Method and Apparatus for Reducing Bandwidth Requirements in Transmission Systems, 2 726 283.
- R. F. Durst, G. C. Florio, and D. W. Black, Federal Telephone and Radio Company, Selenium Rectifiers, 2 724 078.
- C. L. Estes, Federal Telecommunication Laboratories, Multichannel Communication 2 729 791.
- A. Frum, Federal Telecommunication Laboratories, Time-Multiplex System, 2 723 310.
- A. R. Gobat, Federal Telecommunication Laboratories, Anode for Primary Cells and Method for Making Same, 2 726 279.
- F. P. Gohorel, Compagnie Générale de Constructions Téléphoniques (Paris), Automatic Telephone System, 2 724 019.
- D. D. Grieg, H. F. Engelmann, and J. A. Kostriza, Federal Telecommunication Laboratories, Attenuators, 2 725 535.
- H. S. Haynes, Federal Telecommunication Laboratories, Pulse-Code Modulator, 2 729-790.
- J. A. Henderson, Capehart-Farnsworth Company, Signal Terminator Circuit, 2 726-329.

- L. Himmel, Federal Telecommunication Laboratories, Amplitude-Control Unit, 2 726 369.
- R. V. Judy, Kellogg Switchboard and Supply Company, Register Sender, 2 724 020.
- A. G. Kandoian and R. A. Felsenheld, Federal Telecommunication Laboratories, Antenna System Combinations and Arrays, 2 726 388.
- E. Labin, Federal Telecommunication Laboratories, Electrical Delay Devices, 2 723 376.
- J. S. LeGrand, Federal Telecommunication Laboratories, Logarithmic Amplifier-Detector, 2 729 743.
- S. W. Lewinter, Federal Telecommunication Laboratories, Radio Receiver System, 2 723 345.
- E. Manteuffel, Mix and Genest (Stuttgart), Facility for Tracing the Routing Adjustment Rings on Pneumatic-Tube Dispatch Carriers, 2 723 810.
- G. L. Martin, Capehart-Farnsworth Company, Method and Apparatus for Measuring Film Thickness, 2 726 173.
- L. F. Mayle, Farnsworth Research Corporation, Pulse-Keying Circuit for Power Amplifiers, 2 723 347.
- L. F. Mayle, Farnsworth Research Corporation, High-Voltage Regulated Power Supply, 2 726 350.
- E. S. McLarn, International Standard Electric Corporation, Alarm Switching Device for Rotary Elements, 2 723 322.
- H. Oden, Mix and Genest (Stuttgart), Condenser Arrangement for Registering and Sending Control Signals, 2 722 568.
- W. Pouliart, M. den Hertog, and H. H. Adelaar, Bell Telephone Manufacturing Company (Antwerp), Method of Line Scanning for Automatic Telephone System, 2 724 018.
- A. J. Radcliffe, Kellogg Switchboard and Supply Company, Balanced Junction Device for a Two-Way Telephone Repeater, 2 725 532.
- D. S. Ridler and J. D. Reynolds, Standard Telecommunication Laboratories (London), Telegraph Transmission System, 2 722-565.
- I. R. Taylor, Federal Telecommunication Laboratories, Antenna Unit, 2 726 389.
- A. J. Warner and D. K. Keel, Federal Telecommunication Laboratories, Purification of Hydrogenated Polystyrene, 2 726 233.
- A. K. Wing and T. J. Marchese, Federal Telecommunication Laboratories, Filament Support, 2 726 349.

Line Scanning for Automatic Telephone Systems

W. Pouliart, M. den Hertog, and H. H. Adelaar
2 724 018—November 15, 1955

This rectifier gating network for line scanning in machine switching of telephone circuits is arranged in tree formation having a plurality of stages. There is one terminal at the first stage and an increasing number of terminals at succeeding stages. Each branch of each stage is controlled by a rectifier to which is applied a pulse train having a different time position from the pulse trains applied to the other rectifiers. As the lines are scanned by a pulse train, any change in potential on a line will appear on the terminal of the first stage at a time peculiar to that particular line.

Attenuators

D. D. Grieg, H. F. Engelmann, and J. A. Kostriza 2 725 535—November 29, 1955

For microstrip assemblies, this attenuator uses a body of lossy material resting on the conductor of the microstrip circuit and extending beyond its side edges to intercept the fringe field of the electromagnetic wave.

Artificial-Barrier-Layer Selenium Rectifier

D. W. Black
2 724 079—November 15, 1955

The blocking layer covered by the patent is between the counter electrode and the selenium in a selenium rectifier. It consists of a nylon lacquer to which is added approximately 0.125 percent by weight of magnesium nitrate.

In Memoriam

WILLIAM HENRY HARRISON, president of the International Telephone and Telegraph Corporation, died of a heart ailment on April 21, 1956. He was 63 years of age, having been born in 1892 in Brooklyn, New York.

He went to work for the New York Telephone Company in 1909 and in 1914 joined the engineering department of the Western Electric Company. From 1918 to 1933, he was in the operations and engineering department of the American Telephone and Telegraph Company. After four years as vice president of the Bell Telephone Company of Pennsylvania and the Diamond State Telephone Company, he returned to the parent company, becoming a vice president in 1938.

His wartime services started in 1940, when he was appointed head of the construction division of the National Defense Advisory Commission and early in 1941 chief of the shipbuilding and construction branch of the Office of Production Management. Later that year, he became Director of Production, the second highest post in that agency. He served also on the Joint Defense Production Committee of the United States and Canada.

In 1942, he was commissioned a colonel, and shortly thereafter a brigadier general, in the United States Army. As director of procurement in the Services of Supply, he was responsible for obtaining all materiel needed by the army in the prosecution of the war. As a major general in 1943, he directed the procurement and distribution of all communications, radio, and electronics materiel for the army and the army air forces.

In recognition of these wartime services, he received the Distinguished Service Medal from

the United States War Department, the Most Excellent Order of the British Empire with the degree of Honorary Commander, and the Cross of the French Legion of Honor with the rank of Officer. He received the Hoover Medal, the highest engineering civilian award, for his "distinguished public service".

On return to civilian life, he became vice president of the American Telephone and Telegraph Company in charge of operations and engineering. He was elected president of the International Telephone and Telegraph Corporation in 1948.

In addition to his many directorships in the International System, he served also on the boards of the Intertype Corporation of Brooklyn, Nassau Hospital in Mineola, Long Island, and New York Hospital.

Mr. Harrison was a past president of the American Institute of Electrical Engineers. He was a member of the governing bodies of the Polytechnic Institute of Brooklyn, Pratt Institute, and the United Engineering Trustees, which is responsible for the engineering societies building in New York City. He served on advisory councils of Notre Dame University, Princeton University, and of two honorary scientific societies, Eta Kappa Nu and Tau Beta Pi. He received honorary degrees from Polytechnic Institute of Brooklyn, Notre Dame University, Rensselaer Polytechnic Institute, and Manhattan College.

With his passing, the Corporation has lost an executive of highest quality; the communications industry, one of its foremost members; the nation, one of its great public servants; and his associates, a valued friend.



WILLIAM HENRY HARRISON

Contributors to This Issue

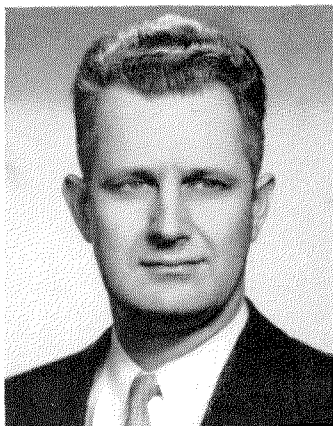

FREDERICK J. ALTMAN

FREDERICK J. ALTMAN was born on March 7, 1915, in New York, New York. He received B.S. and M.S. degrees from the Massachusetts Institute of Technology in 1938.

From 1940 to 1946, he served as a radar officer with the Army Air Force. In 1946, he joined Federal Telecommunication Laboratories, where he is working on doppler radar, scatter communications, and other projects. He is currently a senior project engineer in the radio communication laboratory.

Mr. Altman is a Senior Member of the Institute of Radio Engineers.

...



V. A. ALTOVSKY

V. A. ALTOVSKY was born in Lucerne, Switzerland, in 1910. He graduated from Ecole Supérieure d'Electricité in Paris in 1931.

From 1937 to 1945, he worked for Laboratoire Central de Télécommunications in Paris on waveguides, the propagation of centimeter waves in the troposphere, and on the first multiplex 24-channel 3000-megacycle radio toll junction between Paris and Montmorency.

He joined the engineering staff of the French Thomson-Houston Company in 1945 and became technical director of the radar department of the Société Nouvelle de l'Outillage RBV et de la Radio-Industrie in 1949.

Mr. Altovsky received the Ancel Award in 1950 for his research on ultrahigh frequencies. He is a Senior Member of the Institute of Radio Engineers.

...

ALBINO ANTINORI was born in Canicatti, Sicily, in 1899. He graduated in mechanical industrial engineering from Turin Polytechnic in 1921. Two years later, he received a diploma from Scuola Superiore di Elettrotecnica G. Ferraris in Turin and in 1925 a degree in physics from Turin University.

From 1923 to 1925, he was an assistant in experimental physics at Turin Polytechnic and from 1925 to 1931 taught physics and engineering at Istituto Industriale Nazionale at Fermo.

He joined the specialized engineering group of the Italian Ministry of Posts and Telecommunications in 1931. He was appointed Inspector General of Telecommunications in 1947 and Superior Inspector General of Telecommunications in 1950. He held a commission in the Italian signal corps.

Mr. Antinori is a director of the Posts and Telecommunications Administration, of its Superior Technical Council, and of the National Research Council. He is a Senior Member of the Italian Electrotechnical Association.

...



ALBINO ANTINORI

HELMUT CARL was born in Danzig, then Germany, in 1916. He was educated in the technical universities of Danzig and Berlin, receiving a doctor of engineering degree in 1943 from the Technical University of Danzig.

Dr. Carl joined C. Lorenz in Berlin in 1939 and has done development work on radar, frequency-modulation broadcast transmitters, and very-high-frequency radio links. His present duties concern the over-all planning of radio communication systems at the Pforzheim laboratory.

...



HELMUT CARL



J. M. CLARA

J. M. CLARA was born in Zaragoza, Spain, in 1892. He received the degrees of Licenciado en Ciencias Químicas in 1914, Licenciado en Ciencias Físicas in 1916, Ingeniero de Telecomunicación in 1920, and Ingeniero Radiotelegrafista in 1923.

He entered the national telegraph service in 1908, while still a student. In 1924, he joined the Compañía Telefónica Nacional de España as a district engineer and is now executive operating vice president. Since 1930, he has represented the company on the Comité Consultatif International Téléphonique.

• • •

ANDRÉ G. CLAVIER was born in 1894 in Cambrai, France. He received the



ANDRÉ G. CLAVIER

Licence es Sciences Physiques et Mathématiques from the Sorbonne in 1918 and the diplôme d'Ingénieur de l'Ecole Supérieure d'Electricité (Paris) in 1920.

From 1920 to 1925, he was in charge of a laboratory on high-frequency radio research for the French Signal Corps. After service with the International Western Electric Company in London and with Société Française Radioélectrique in Paris, he joined the International Telephone and Telegraph System in 1929. He was assistant director of research of Laboratoire Central de Télécommunications when he was transferred in 1946 to Federal Telecommunication Laboratories, of which he is now vice president and technical director.

He played a major role in the experimental microwave transmission across the English Channel in 1931 and in the commercial telephone and teleprinter link between Lympne and Saint Inglevert that followed it in 1933.

Mr. Clavier is a Member of the Société des Radioélectriciens, a Membre Lauréat of the Société Française des Electriciens, vice president of the American section of the Société des Ingénieurs Civils de France, a Fellow in both the Institute of Radio Engineers and the American Institute of Electrical Engineers, and a Member of the Institution of Electrical Engineers.

• • •

RICHARD E. GRAY was born in England in 1902. After graduating from Faraday House, electrical engineering college in London, he joined Standard Telephones and Cables in 1924.

From 1927 to 1939, he was with the laboratories of Le Matériel Téléphonique in Paris. In 1940, he joined the Royal Aircraft Establishment at Farnborough, England, and in 1943 was transferred to the Telecommunication Research Establishment at Malvern.



RICHARD E. GRAY

He has been with Federal Telecommunication Laboratories at Nutley, New Jersey, since 1946, where he is now working on tropospheric scatter communication.

He is a member of the Institute of Radio Engineers and of the Institution of Electrical Engineers.

• • •

ARMIG G. KANDOIAN received the M.S. degree in electrical engineering from Harvard Graduate School of Engineering in 1935.

He has been associated with the International System since 1935 and has done extensive work on antennas, transmission lines, measurements, and on



ARMIG G. KANDOIAN

various problems connected with radar, communications, and navigation. He is the director of the radio communication laboratory of Federal Telecommunication Laboratories.

Mr. Kandoian received the honorable mention award of Eta Kappa Nu in 1943. He is a Fellow of the Institute of Radio Engineers and a member of the American Institute of Electrical Engineers and Harvard Engineering Society.

• • •

WILLIAM SICHAK was born on January 7, 1916, in Lyndora, Pennsylvania.

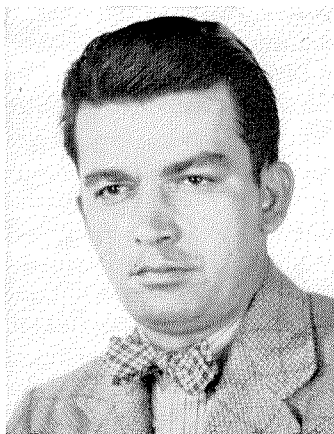

WILLIAM SICHAK

He received the B.A. degree in physics from Allegheny College in 1942.

From 1942 to 1945, he was engaged in developing microwave radar antennas at the Radiation Laboratory of Massachusetts Institute of Technology. Since then, he has been with Federal Telecommunication Laboratories, working on microwave antennas, allied radio-frequency equipment, and radio-relay links.

Mr. Sichak is an associate director of the radio communication laboratory. He is a member of the American Physical Society and of the Institute of Radio Engineers.

INTERNATIONAL TELEPHONE AND TELEGRAPH CORPORATION

MANUFACTURE AND SALES

North America

UNITED STATES OF AMERICA —
Divisions of International Telephone and Telegraph Corporation
Farnsworth Electronics Company; Fort Wayne, Indiana
Federal Telephone and Radio Company; Clifton, New Jersey
Kellogg Switchboard and Supply Company; Chicago, Illinois
Federal Electric Corporation; Clifton, New Jersey
International Standard Electric Corporation; New York, New York
International Standard Trading Corporation; New York, New York
Kellogg Credit Corporation; Chicago, Illinois
Kuthe Laboratories, Inc.; Newark, New Jersey
CANADA — (*See British Commonwealth of Nations*)

British Commonwealth of Nations

ENGLAND —
Standard Telephones and Cables, Limited; London
Creed and Company, Limited; Croydon
International Marine Radio Company Limited; Croydon
Kolster-Brandes Limited; Sidcup
CANADA — Standard Telephones & Cables Mfg. Co. (Canada), Ltd.; Montreal
AUSTRALIA —
Standard Telephones and Cables Pty. Limited; Sydney
Silovac Electrical Products Pty. Limited; Sydney
Austral Standard Cables Pty. Limited; Melbourne
NEW ZEALAND — New Zealand Electric Totalisators Limited; Wellington

Latin America and West Indies

ARGENTINA —
Compañía Standard Electric Argentina, S.A.I.C.; Buenos Aires
Capehart Argentina; Buenos Aires
BRAZIL — Standard Electrica, S.A.; Rio de Janeiro
CHILE — Compañía Standard Electric, S.A.C.; Santiago
CUBA — International Standard Products Corporation; Havana
MEXICO — Standard Electrica de Mexico, S.A.; Mexico City
PUERTO RICO — Standard Electric Corporation of Puerto Rico; San Juan

Europe

AUSTRIA — Vereinigte Telephon- und Telegraphenfabriks A. G., Czeija, Nissl & Co.; Vienna
BELGIUM — Bell Telephone Manufacturing Company; Antwerp
DENMARK — Standard Electric Aktieselskab; Copenhagen
FINLAND — Oy Suomen Standard Electric AB; Helsinki
FRANCE —
Compagnie Générale de Constructions Téléphoniques; Paris
Le Matériel Téléphonique; Paris
Les Téléimprimeurs; Paris
GERMANY —
Standard Elektrik A.G.; Stuttgart
Divisions
Mix & Genest; Stuttgart and Berlin
Süddeutsche Apparatefabrik; Nürnberg
C. Lorenz, A.G.; Stuttgart and Berlin
Schaub Apparatebau; Pforzheim
ITALY — Fabbrica Apparecchiature per Comunicazioni Elettriche Standard S.p.A.; Milan
NETHERLANDS — Nederlandsche Standard Electric Maatschappij N.V.; The Hague
NORWAY — Standard Telefon og Kabelfabrik A/S; Oslo
PORTUGAL — Standard Eléctrica, S.A.R.L.; Lisbon
SPAIN —
Compañía Radio Aérea Marítima Española; Madrid
Standard Eléctrica, S.A.; Madrid
SWEDEN — Aktiebolaget Standard Radiofabrik; Stockholm
SWITZERLAND — Standard Téléphone et Radio S.A.; Zurich

TELEPHONE OPERATIONS

BRAZIL — Companhia Telefônica Nacional; Rio de Janeiro
CHILE — Compañía de Teléfonos de Chile; Santiago
CUBA — Cuban American Telephone and Telegraph Company; Havana

CUBA — Cuban Telephone Company; Havana
PERU — Compañía Peruana de Teléfonos Limitada; Lima
PUERTO RICO — Porto Rico Telephone Company; San Juan

CABLE AND RADIO OPERATIONS

UNITED STATES OF AMERICA —
American Cable & Radio Corporation; New York, New York
All America Cables and Radio, Inc.; New York, New York
The Commercial Cable Company; New York, New York
Mackay Radio and Telegraph Company; New York, New York

ARGENTINA —
Compañía Internacional de Radio; Buenos Aires
Sociedad Anónima Radio Argentina; Buenos Aires (*Subsidiary of American Cable & Radio Corporation*)

BOLIVIA — Compañía Internacional de Radio Boliviana; La Paz
BRAZIL — Companhia Radio Internacional do Brasil; Rio de Janeiro
CHILE — Compañía Internacional de Radio, S.A.; Santiago
CUBA — Radio Corporation of Cuba; Havana
PUERTO RICO — Radio Corporation of Porto Rico; San Juan

RESEARCH

UNITED STATES OF AMERICA —
Division of International Telephone and Telegraph Corporation
Federal Telecommunication Laboratories; Nutley, New Jersey
International Telecommunication Laboratories, Inc.; New York, New York

ENGLAND — Standard Telecommunication Laboratories, Limited; London
FRANCE — Laboratoire Central de Télécommunications; Paris
GERMANY — Standard Central Laboratories; Stuttgart

ASSOCIATE LICENSEES FOR MANUFACTURE AND SALES IN JAPAN

Nippon Electric Company, Limited; Tokyo

Sumitomo Electric Industries, Limited; Osaka