

# ELECTRICAL COMMUNICATION

*Technical Journal of the  
International Telephone and Telegraph Corporation  
and Associate Companies*

---

R.M.S. CARONIA RADIO AND ELECTRONIC INSTALLATION

FACSIMILE FOR PICKUP AND DELIVERY OF TELEGRAMS

TELEPHONE PLANT OF BOLOGNA

TRAVELLING-WAVE AMPLIFIER FOR 6 TO 8 CENTIMETRES

TELEPHONE STATISTICS OF THE WORLD

INTERCONNECTION OF CHANNEL GROUPS BETWEEN COAXIAL CABLES

HARMONIC DISTORTION IN FREQUENCY-MODULATION DISCRIMINATOR

NEGATIVE FEEDBACK APPLIED TO FREQUENCY-MODULATION SYSTEMS

---

JUNE, 1949

Volume 26

Number 2

## **Electrical Communication**

### **Index to Volumes 1-25**

**1922-1948**

A cumulative index for the first 25 volumes of **ELECTRICAL COMMUNICATION** has been prepared. Both author and subject indexes are included and the latter is extensively cross referenced. Copies may be obtained at \$1.00 each (payable in New York funds), postpaid, from **ELECTRICAL COMMUNICATION**, 67 Broad Street, New York 4, New York.

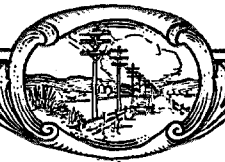

# ELECTRICAL COMMUNICATION

Technical Journal of the  
INTERNATIONAL TELEPHONE AND TELEGRAPH CORPORATION  
and Associate Companies

H. P. WESTMAN, Editor

F. J. MANN, Managing Editor

J. E. SCHLAIKJER, Editorial Assistant

## REGIONAL EDITORS

E. G. PORTS, Federal Telephone and Radio Corporation, Newark, New Jersey  
B. C. HOLDING, Standard Telephones and Cables, Limited, London, England  
P. F. BOURGET, Laboratoire Central de Télécommunications, Paris, France  
H. B. WOOD, Standard Telephones and Cables Pty. Limited, Sydney, Australia

## EDITORIAL BOARD

H. Busignies    H. H. Buttner    G. Deakin    E. M. Deloraine    W. T. Gibson    Sir Frank Gill  
W. Hatton    E. Labin    E. S. McLarn    A. W. Montgomery    Haraden Pratt    G. Rabuteau  
F. X. Rettenmeyer    T. R. Scott    C. E. Strong    A. E. Thompson    E. N. Wendell    W. K. Weston

Published Quarterly by the

## INTERNATIONAL TELEPHONE AND TELEGRAPH CORPORATION

67 BROAD STREET, NEW YORK 4, N.Y., U.S.A.

Sosthenes Behn, Chairman

William H. Harrison, President

Charles D. Hilles, Jr., Vice President and Secretary

Subscription, \$2.00 per year; single copies, 50 cents

Electrical Communication is indexed in Industrial Arts Index

Copyrighted 1949 by International Telephone and Telegraph Corporation

Volume 26

June, 1949

Number 2

## CONTENTS

	PAGE
R.M.S. CARONIA RADIO AND ELECTRONIC INSTALLATION .....	107
FACSIMILE TRANSCIVER FOR PICKUP AND DELIVERY OF TELEGRAMS .....	129
<i>By G. H. Ridings</i>	
TELEPHONE PLANT OF BOLOGNA .....	138
<i>By F. Pezzoli</i>	
TRAVELLING-WAVE AMPLIFIER FOR 6 TO 8 CENTIMETRES .....	144
<i>By D. C. Rogers</i>	
TELEPHONE STATISTICS OF THE WORLD .....	153
INTERCONNECTION OF CHANNEL GROUPS BETWEEN COAXIAL CABLES .....	158
<i>By A. Fromageot and M. A. Lalande</i>	
HARMONIC DISTORTION IN FREQUENCY-MODULATION OFF-RESONANCE DISCRIMINATOR .....	167
<i>By A. R. Vallarino and Marilyn S. Buyer</i>	
APPLICATION OF NEGATIVE FEEDBACK TO FREQUENCY-MODULATION SYSTEMS .....	173
<i>By P. F. Panter and W. Dite</i>	
RECENT TELECOMMUNICATION DEVELOPMENTS	
CHINESE HONOR SIR FRANK GILL .....	128
POST OFFICE TELECOMMUNICATIONS JOURNAL .....	128
TELEGRAPH SWITCHING IN DENMARK .....	137
LOW-CAPACITANCE CABLE .....	166
RADIO PROVIDES COMMUNICATION WITH PRESIDENTIAL TRAIN .....	179
FARNSWORTH CORPORATION ENTERS I. T. & T. SYSTEM .....	180
ELEMENTS IN THE DESIGN OF CONVENTIONAL FILTERS—ADDENDUM .....	180
DESIGN OF IONIZATION MANOMETER TUBE—ERRATA .....	180
CONTRIBUTORS TO THIS ISSUE .....	181



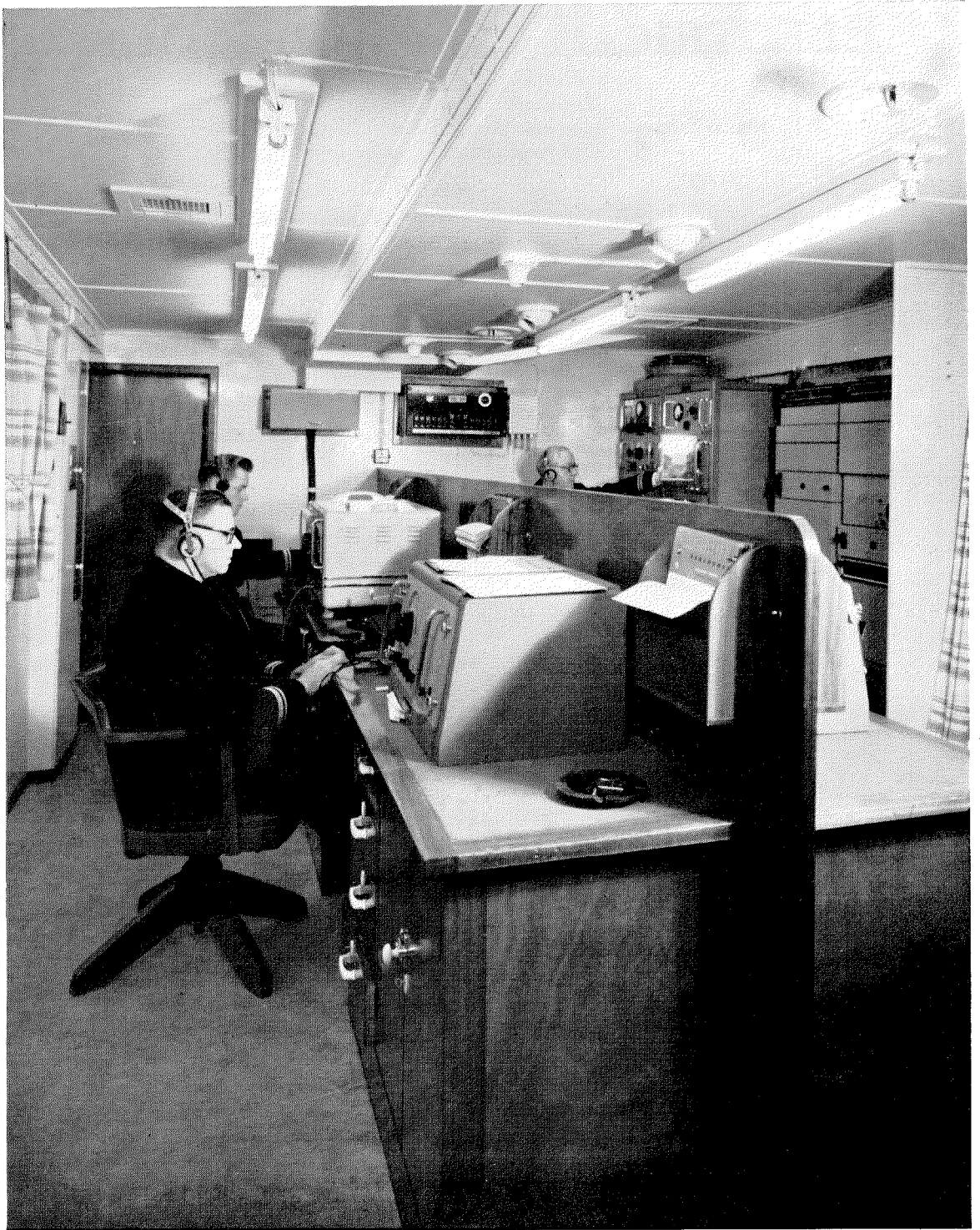

Radio receiving room and operating positions aboard R.M.S. Caronia. The single-sideband radiotelephone receiver and terminal equipment are in the far corner of the room.

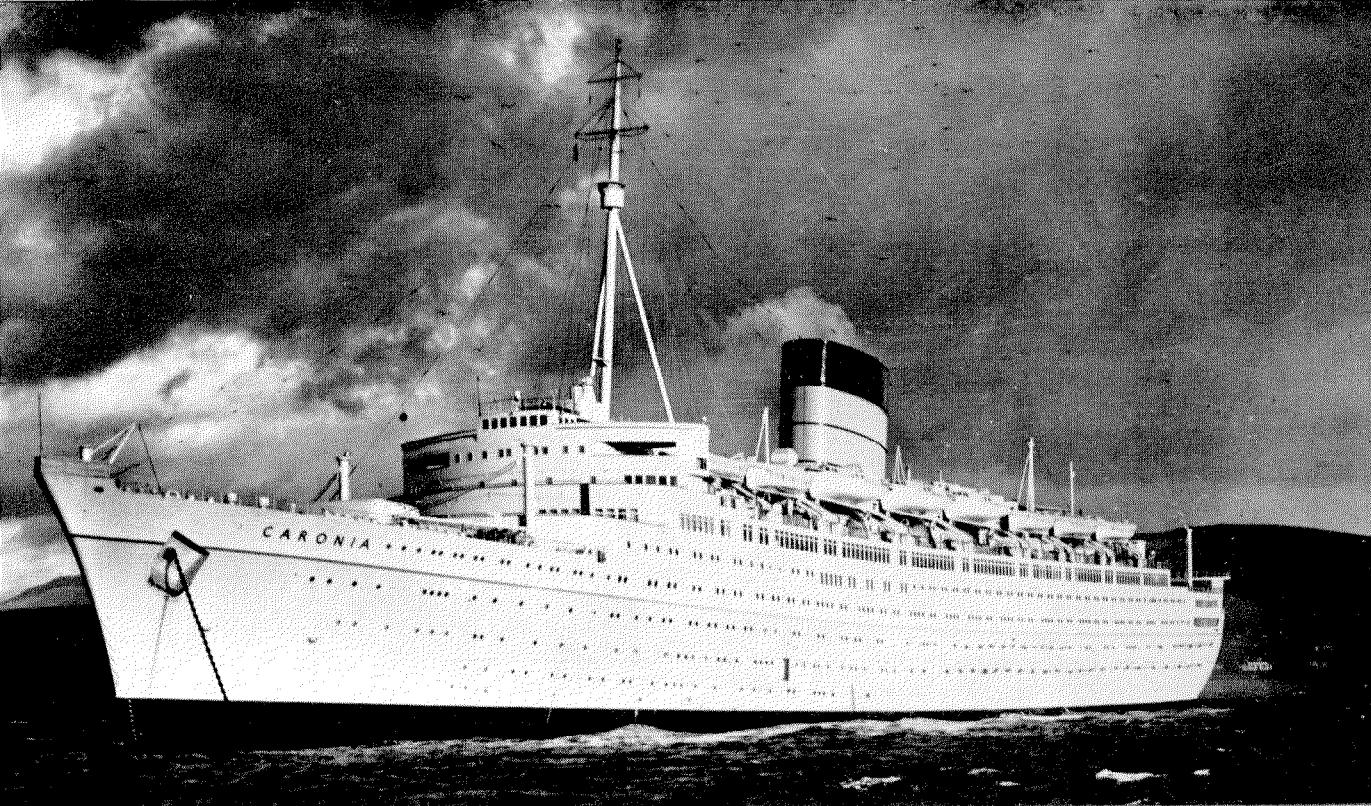

## *R.M.S. Caronia* Radio and Electronic Installation\*

**U**LTRA-MODERN DESIGN with extremely graceful lines characterize the 34,000-ton *R.M.S. Caronia*, Britain's largest post-war liner. One of the striking departures from traditional construction in this Cunard-White Star vessel is the use of a single tripod mast set abaft the bridge and a single funnel, instead of the usual two masts and at least two funnels. This arrangement, which may be seen in Figure 1 above, presented a problem in connection with the design of the antenna system, and in particular that of the transmitting antennae, which are 5 in number. Another important point affecting design is the fact that only one location was available for housing all the equipment comprising the main radio station. The space, 42 by 12 feet, is located on the sun deck just abaft the bridge structure.

After considering all the possibilities, it was decided to split the available space into two rooms, one housing all the transmitters and emergency equipment, the other, which is completely

copper-lined, housing the receivers and telephone terminal equipment. The general layout of the main radio station is clearly shown in Figure 2, which emphasises the amount of equipment that had to be fitted into a relatively small space.

In addition to the transmitter and receiver rooms, Figure 2 also includes the machine and battery rooms and the night acceptance office. The foregoing together with the main acceptance office, located in the promenade deck square, completes the radio station proper. The extensive public-address system and navigational aids are considered to be auxiliaries and are covered later under a separate heading.

### *1. General Scheme of Operation*

As the *Caronia* is expected to be engaged in extensive cruising it was necessary to ensure both telegraph and telephone communication from all parts of the world. Hence the emphasis that has been placed on high-frequency channels, whilst medium- and low-frequency equipment is provided for short-range communication whilst on the normal north Atlantic trade.

\* Presented in part at Radio Technical Committee on Marine Services, Annual Assembly Meeting, in Boston, Massachusetts, U. S. A., on April 28, 1949.

The provision of radiotelephone transmission facilities also presented a somewhat difficult problem. Owing to the limited space in the transmitter room and the relatively close proximity between transmitting and receiving aerials, it was obvious that high-power equipment of some 5 to

10 kilowatts was out of the question. It was finally decided to employ medium-power single-sideband with double-sideband stand-by equipment for use with shore stations not having single-sideband facilities. If desired the double-sideband transmitter could also be used for radio-

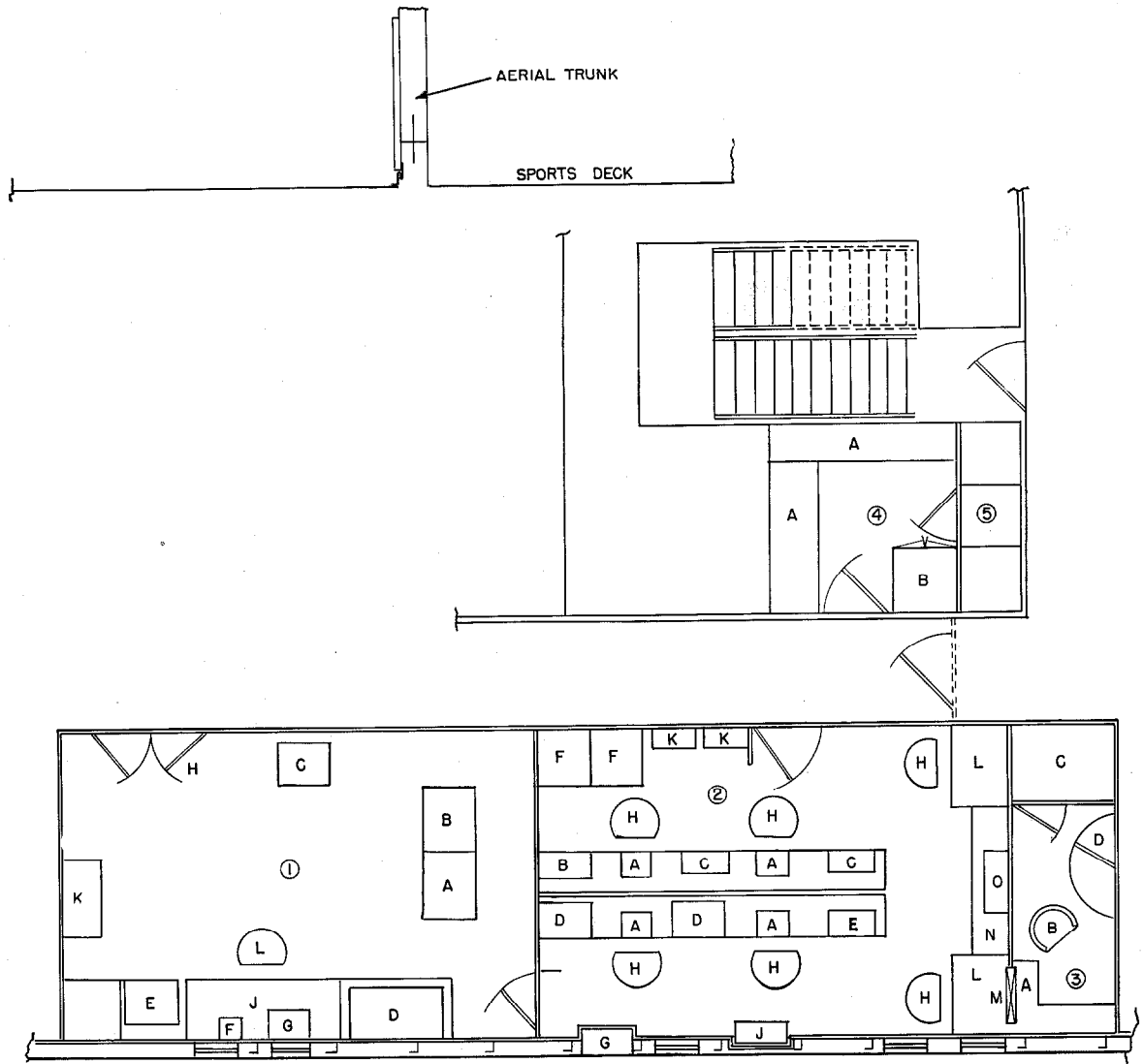

Figure 2—Layout of radio equipment in five rooms on the sun deck just abaft the bridge.

1—Transmitter room: A—*E.S.4.B.* transmitter, radio-frequency unit. B—*E.S.4.B.* transmitter, power unit. C—*D.S.9.* single-sideband transmitter. D—*I.M.R.29.* transmitter. E—*I.M.R.53.* transmitter. F—*I.M.R.22.* receiver. G—*I.M.R.31.* transmitter. H—Double-door entry for large equipment. J—Operating desk. K—Power distribution board. L—Chair.

2—Receiver room: A—Typewriter wells. B—Terminal control console. C—*R.V.9.A.* receivers. D—*I.M.R.42.* receivers. E—*R.V.11.* receiver. F—*R.X.9.* single-sideband receiver. G—Lamson message carrier. H—Chairs. J—Accepted-message cabinet. K—Terminal-equipment racks. L—Desks. M—Night acceptance window. N—Table. O—Monitoring and patching panel.

3—Night acceptance office: A—Table. B—Chair. C—4-wire-telephone booth. D—Entrance.

4—Machine room and workshop: A—Benches and machines. B—Tube-storage cupboard.

5—Battery room,

telegraphy. The telegraph facilities are covered by two separate equipments, one exclusively high-frequency and the other combining high-frequency and low-frequency apparatus. The transmitter room therefore houses the four main equipments shown in Figures 3 and 4 as follows:-

*Type D.S.9.* high-frequency 300-watt single-sideband radiotelephone transmitter.

*Type E.S.4.B.* high-frequency 300/1000-watt radiotelephone/radiotelegraph transmitter.

*Type I.M.R.53.* high-frequency 300-watt radiotelegraph transmitter.

*Type I.M.R.29.* high/medium/low-frequency 500-watt radiotelegraph transmitter.

In addition to the foregoing, the transmitter room also houses a complete medium-frequency emergency operating position including a transmitter and receiver.

As the transmitter and receiver rooms are adjacent it was decided to provide only semi-remote control, except in the case of the *E.S.4.B.* transmitter which has full remote control. The semi-remote control facilities cover frequency selection within any particular low-, medium-, or high-frequency marine band. The only exception is the single-sideband transmitter which is not at present designed for remote control. As may be seen in the frontispiece the receiver room has been laid out to provide a maximum of four operating positions each capable of handling a two-way circuit. Referring back to Figure 2 the operating positions are primarily intended to cover the following functions:-

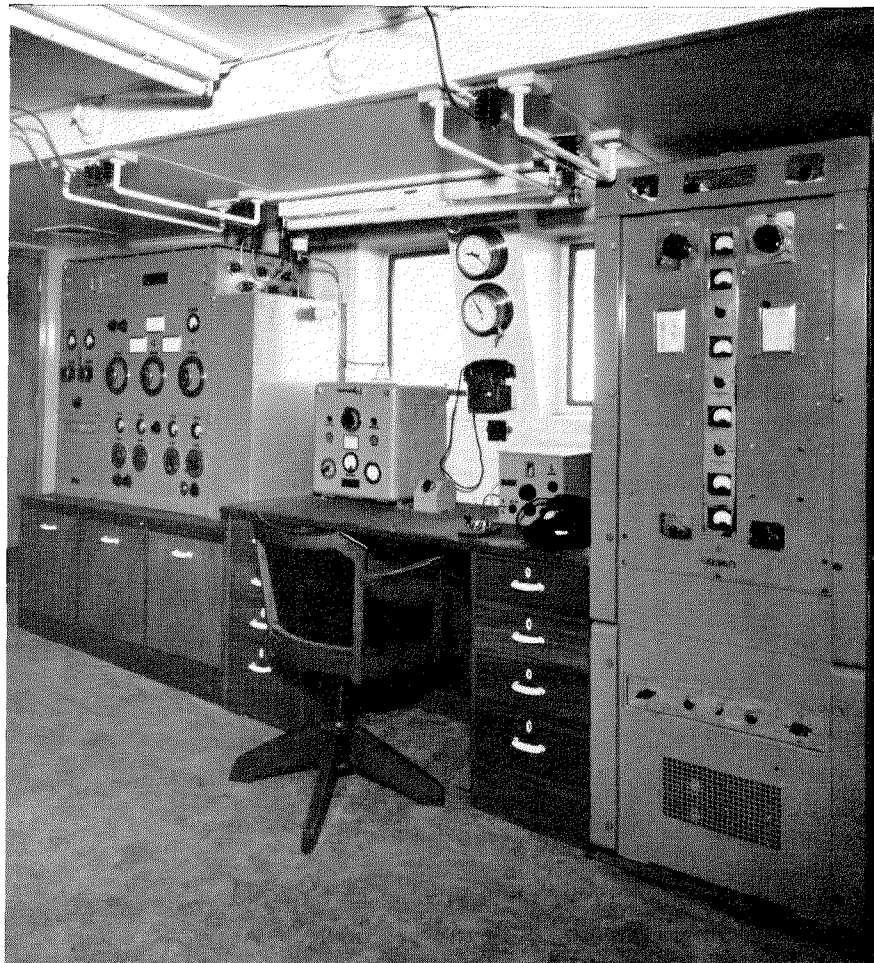

Figure 3—Part of the transmitter room showing the *I.M.R.29.* and *I.M.R.53.* transmitters and the emergency equipment.

*Position 1*—Main position for radiotelegraphy. Control of all transmitters except the single-sideband transmitter. Access to two all-wave receivers type *I.M.R.42.* Provision for automatic transmission if required.

*Position 2*—Supplementary radiotelegraph position with control of the *I.M.R.53.* and *I.M.R.29.* transmitters. Access to one *I.M.R.42.* all-wave receiver and one *R.V.11.* medium- and low-frequency receiver. This position also includes a telegraph-key patching unit whereby any transmitter keying line may be connected to any telegraph key

*Position 3*—Supplementary radiotelephone/radiotelegraph position with control of *I.M.R.53.* and *E.S.4.B.* transmitters. Also access to two *R.V.9.A.* medium- and high-frequency receivers.

*Position 4*—Main radiotelephone operating position. The operator at this position has control of the single-sideband transmitter audio-frequency input, and frequency-change facilities for the *E.S.4.B.* transmitter when used for

telephony, also access to the single-sideband double-channel receiver and one *R.V.G.A.* high-frequency receiver. A telephone terminal control panel provides all the necessary facilities for the handling of incoming and outgoing radiotelephone calls.

As each passenger cabin is fitted with a telephone connected to the ship's exchange, most calls are handled over this 2-wire circuit, but a single 4-wire extension is included with a booth inside the night acceptance office. The latter is a precautionary measure for use under difficult circuit conditions or in cases of main switchboard failure. In addition to a certain degree of privacy provided by the use of single-sideband a normal speech inverter is included in the terminal equipment. Provision is also made for high-quality broadcast transmission by completely by-passing the terminal equipment and the insertion of a high-quality microphone amplifier. Such broadcasts can be made from most of the vessel's public rooms utilizing the public-address microphone lines, or from a wardroom near the radio offices to which special high-quality lines have been run.

All receiver output, public-address input, and microphone lines are terminated at a special monitoring and patching panel situated at the forward end of the room. The unit includes four loudspeakers on which any circuit may be monitored while the supervisor is engaged on other duties.

Another important supplementary unit is the aerial patching panel at which the four remote receiving aerials are terminated. This panel is so arranged that three receivers may be connected to any aerial.

Apart from the emergency equipment and the *I.M.R.29.* transmitter all power supplies are derived from a 220-volt 50-cycle-per-second 3-phase system installed in the ship primarily for fluorescent lighting. The emergency transmitter type *I.M.R.31.* derives its power from a 200-ampere-hour 24-volt storage battery whilst the emergency receiver type *I.M.R.22.* operates from a 4-volt storage battery with high tension from the same source via a rotary-transformer. The *I.M.R.29.* transmitter is energised from the vessel's 220-volt direct-current main supply via a 1.5 kilovolt-ampere motor-alternator, the output of which has a frequency of 500 cycles.

## 2. Operational Features

The station has been designed with the object of providing an efficient multiplex system with the greatest possible reduction of mutual interference. The most important object is simultaneous operation of telephone and telegraph circuits. In the case of telephone circuits it must be remembered that a subscriber is involved and a circuit merit equivalent to a long-distance service ashore is expected. Although a skilled operator may be able to obtain full intelligibility from a circuit with a signal-to-noise ratio of 10 to 15 decibels it could not be used by an unskilled subscriber, except perhaps by prior agreement. It may therefore be said that to avoid complaint an overall signal-to-noise ratio of over 20 decibels must be maintained. In the design of transmitters and layout of the station all possible precautions have been taken against direct or indirect interference from the vessel's own transmitters. The receiver room is completely copper-screened and earthed at one point only; the transmitter keying lines are carefully filtered and the output circuits are designed to give a maximum reduction of harmonics. In the case of the *I.M.R.53.* and *E.S.A.B.* high-frequency transmitters the harmonic power is at least 40 decibels below the carrier. Actual measurement on the *I.M.R.53.* showed the latter figure to be nearer 50 decibels. It will also be realised that in a ship installation there must be some fairly definite limitation to adjacent-channel operation on high frequencies. In this respect some experience has been gained in the *Queen Mary* and *Queen Elizabeth* where it was found that in the band from 4 to 25 megacycles per second commercial telephone circuits could be readily handled when the separation between transmitting and receiving frequencies was as low as 2.5 per cent when utilizing a sustained carrier. The latter figure was subject to considerable deterioration during wet and stormy weather conditions due to what are known as "stay" noises. The latter are well known in marine radio circles and are due to imperfect earthing or insulation of wire stays or halyards.

Although the *Caronia* has a minimum of "top-hammer" and is almost devoid of stays there are a number of wire halyards, used for dressing the



ship, which can prove very troublesome if not properly trimmed. However, preliminary tests show that it is possible to use sustained carrier with frequency separations down to about 2 per cent provided the incoming field is reasonably good. Although the latter figure can be readily attained when using sustained carrier it must be recorded that such close channelling is hardly possible with a keyed carrier, e.g. with one of the radiotelegraph transmitters operating within a comparable percentage of the radiotelephone received frequency. Under keyed conditions the minimum separation is nearer 4 to 5 per cent. The latter difficulty is solved by the fact that in practice the radiotelegraph and radiotelephone sections of the band are usually well separated from each other.

Generally the main circuit-limiting factor aboard ship is interference from the electrical machinery which, if not adequately suppressed, can be very severe indeed. During the design of the radio installation the co-operation of the owners was enlisted and close contact was maintained throughout. As already mentioned the receiver room is completely copper-lined, which is considered to be the greatest single contribution to the reduction of noise. All electrical equipment within 30 feet of the radio rooms or aerials is suitably suppressed and all cables within the same radius are lead-covered. Apart from occasional troubles which are usually traced to a single offending machine, it may be said that the foregoing precautions are adequate.

It is perhaps somewhat early to lay down any very definite figures covering multiplex con-

ditions, but during the trials and maiden voyage all the requirements of the system specifications were fulfilled. During busy periods simultaneous high-frequency radiotelephone, high-frequency radiotelegraph, and low-frequency radiotelegraph circuits have been operated without mutual interference. The introduction of single-sideband telephony has contributed greatly to the general improvement in radiotelephone circuits.

### 3. Transmitters

#### 3.1 SINGLE-SIDEBAND RADIOTELEPHONE TRANSMITTER, D.S.9.

The *D.S.9.* transmitter together with its associated receiver (type *R.X.9.*) provides the main long-distance radiotelephone circuit. It has been designed in the first instance as a single-channel equipment working on either the upper or lower sideband, but arrangements have been made for the installation of an extra unit for providing a second channel if it is required. Its frequency

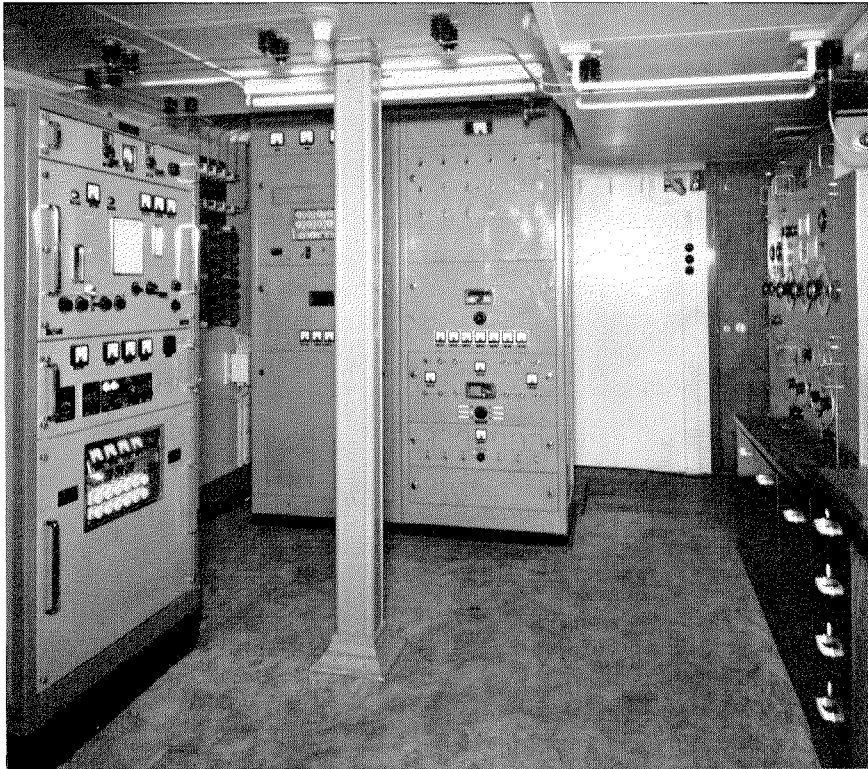

Figure 4—*D.S.9.*, *E.S.4.B.*, and *I.M.R.29.* transmitters.

range is 4 to 22 megacycles and its output (peak envelope) power is 300 watts.

Figure 5 is a front view of the transmitter, which is built in a single cabinet. The power supplies, derived from the ship's 50-cycle mains, are located at the bottom of the cabinet: the single-sideband generating unit is in the middle with the oscillator and negative-feedback unit and the radio-frequency amplifier unit on the left and right above it; the top unit is for aerial coupling.

Front access only is required for maintenance, since all chassis except the power unit are so arranged that they can be pulled out and operated in the withdrawn position. The single-sideband generating unit can also be swung into the vertical position to facilitate access to components mounted below the chassis.

The whole equipment measures 5 feet 6 inches by 2 feet 8 inches by 2 feet 11 inches and weighs approximately 600 pounds.

As can be seen from the block schematic of Figure 6 the transmitter works on the multiple-modulation principle to obtain sufficient suppression of the carrier and unwanted sideband.

The audio-frequency input is set to the correct level in the line-amplifier and volume-indicator unit and is mixed with the output of a 100-kilocycle oscillator in the first modulator, which is of the balanced type designed to give a minimum of residual carrier. The output of this modulator therefore consists of two sidebands, the upper being 100 kilocycles plus the audio frequencies and the lower being 100 kilocycles minus the audio frequencies. Either one of these is selected as required by means of crystal band-pass filters. The carrier is reinserted at the correct level at this point so that assuming an audio-frequency band of 200 to 6000 cycles the input to the second modulator consists of either:-

- A. A band of frequencies from 94 to 99.8 kilocycles plus a carrier at 100 kilocycles 16 decibels (or 26 decibels, if required) below the level of the sideband.
- B. A band of frequencies from 100.2 to 106 kilocycles plus a carrier of 100 kilocycles 16 decibels (or 26 decibels, if required) below the level of the sideband.

This signal is mixed in the second modulator with the output of a 3-megacycle oscillator to

produce two sidebands in the region of 2.9 and 3.1 megacycles, the 3-megacycle component being suppressed by the use of a balanced modulator. The 3.1-megacycle sideband is then selected in a filter and amplifier unit.

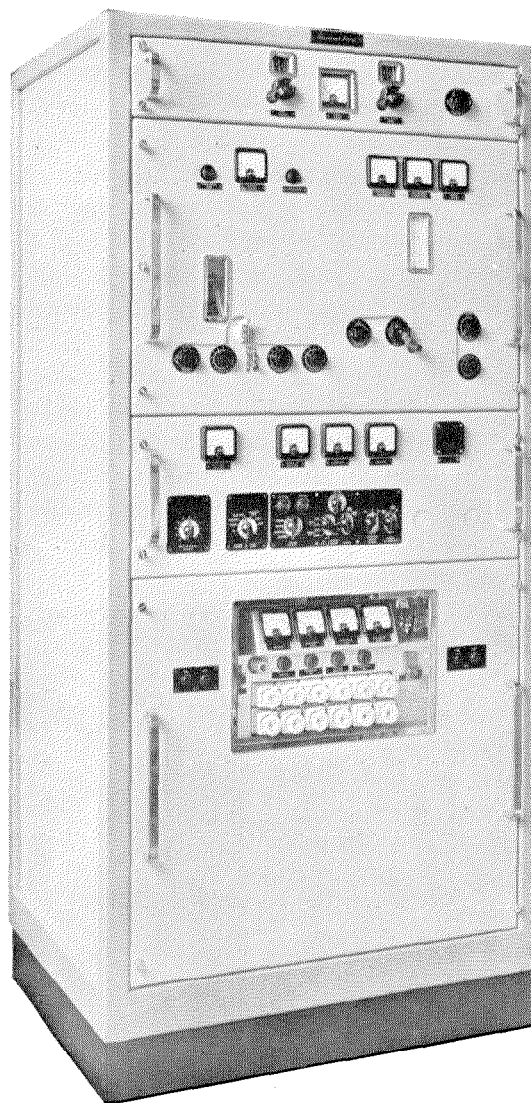

Figure 5—Single-sideband high-frequency radiotelephone transmitter type *D.S.9*.

Since low-level modulation is used in this system it is necessary for the radio-frequency amplifier and output stages to be linear. They are therefore operated in class *A* and to improve the linearity still further negative envelope feedback is used. This feedback is applied to the

signal after the 3.1-megacycle filter and amplifier unit. A portion of the radio-frequency output is mixed with the output of the final oscillator to convert it back to 3.1 megacycles. It is then mixed with the signal in special circuits that ensure that the feedback is as nearly as possible 180 degrees out of phase at all frequencies.

The radiated frequency is determined by the radio-frequency oscillator. This is continuously tunable from 7 to 19 megacycles and is normally crystal-controlled. Six vacuum-sealed crystals are provided any one of which may be selected by means of a switch. The crystals are housed in a thermostatically controlled oven and to give increased stability certain of the components associated with the tuning circuits are mounted in a similar oven. In addition the high-tension supply voltage is regulated by a neon stabilizer, so that the frequency can be kept constant within 0.001 per cent.

In accordance with normal practice when the radiated frequency  $f_R$  is below 10 megacycles, the output from the final oscillator (at twice crystal frequency)  $f_0 = (f_R \text{ plus } 3.1)$  megacycles; when the radiated frequency is above 10 megacycles,  $f_0 = (f_R \text{ minus } 3.1)$  megacycles. The modulated 3.1-megacycle signal is applied to the grid of the third modulator or frequency-translator

valve and the oscillator output at  $f_0$  is applied to the cathode. The required modulation products are selected by tuned circuits and amplified by two buffer and an output stage all operating in class A.

The output is fed to the aerial through a matching circuit and a portion is tapped off from the anode of the final valve and taken to the negative-feedback unit as explained above.

### 3.2 RADIOTELEPHONE/RADIOTELEGRAPH TRANSMITTER, E.S.4.B.

Type *E.S.4.B.* is a high-frequency transmitter designed to operate on 4 frequencies in each of 6 bands between 1.76 and 22 megacycles. The output power is 1 kilowatt on continuous-wave transmission or approximately 300 watts on speech or modulated continuous waves. A remote-control system provides facilities for changing frequency, selection of service (continuous waves, modulated continuous waves, or speech), switching on and off, and repeat back of the operating condition of the transmitter. The maximum power consumption is 4.6 kilowatts from a 3-phase 415-volt 50-cycle supply.

As shown in Figure 7 the transmitter is built in two cabinets, one containing the power supplies

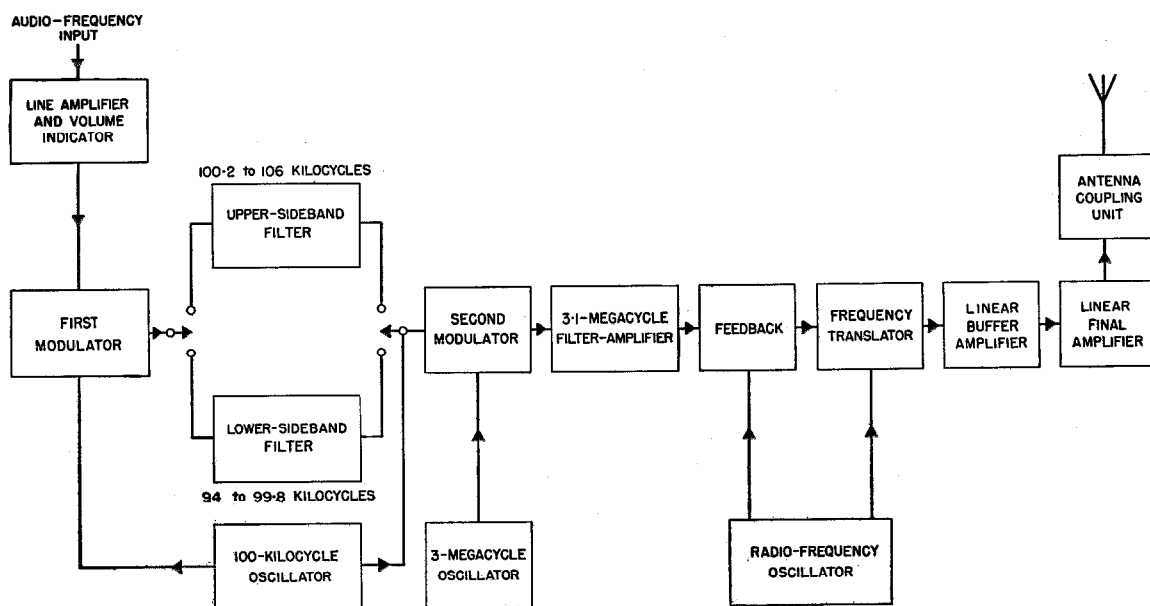

Figure 6—Block diagram of single-sideband transmitter.

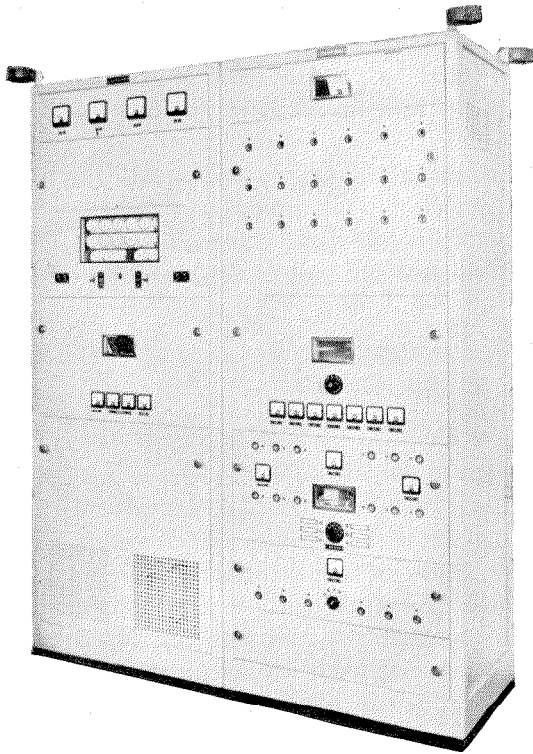

Figure 7—*E.S.A.B.* high-frequency radiotelephone/-radiotelegraph transmitter.

and control circuits, the other the radio-frequency equipment. All the chassis in the radio-frequency cabinet may be withdrawn from the front, all connections being broken automatically. In the power-supply and control cabinet, the keying unit, speech amplifier, 500-volt supply unit, and bias-supply unit may be removed after plug-and-socket connections have been broken. Access to the rear of the cabinets is required only for installation and major maintenance. All doors and panels are electrically interlocked with the power supplies to protect operating personnel.

The circuit arrangement is shown in Figure 8. There are 6 separate oscillator units each of which contains 4 crystals. Any unit may be selected by a switch and any one of the 4 crystals in the selected unit may be connected to the oscillator tube by relays controlled by another switch. There are 6 band-pass circuits associated with the tuning of each of the remaining stages and 6 output circuits. These circuits and the oscillator units are selected by the same switch. The response of each band-pass circuit is substantially level within 0.5 to 1 per cent of the centre frequency, and the frequencies of the 4 crystals are in each case arranged to lie within this band. The crystal frequency range is 0.88 to 2.5

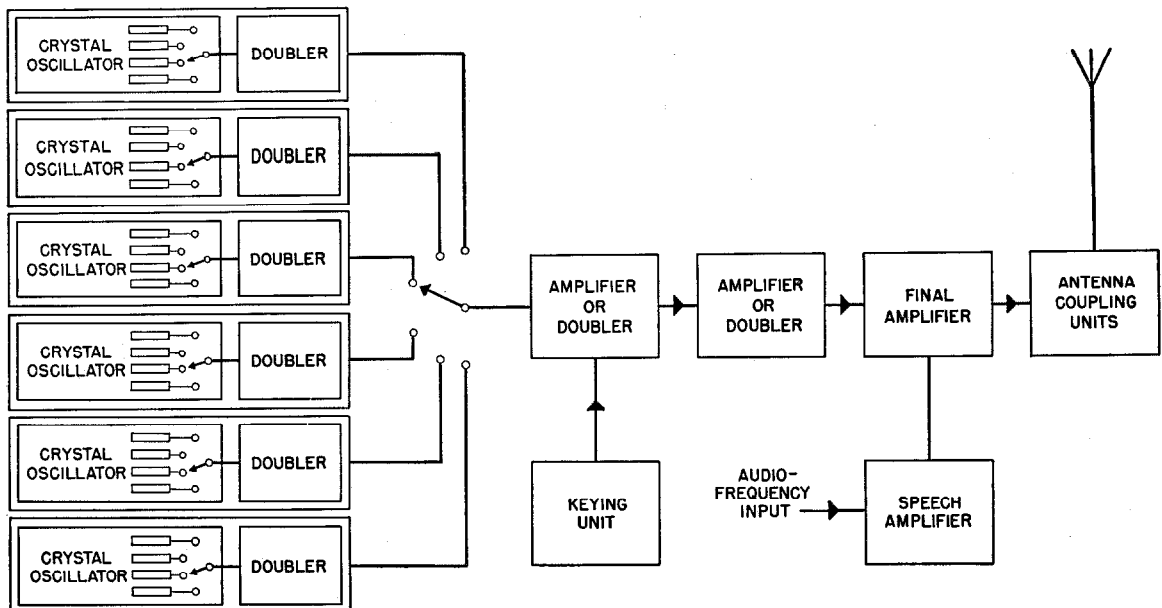

Figure 8—Block diagram of *E.S.A.B.* transmitter.

megacycles and thus the output from the buffer doubler stage lies between 1.76 and 5.0 megacycles. The range is extended to 10 megacycles by using the penultimate amplifier as a doubler and to 20 megacycles by using the first amplifier also as a doubler.

On speech the final radio-frequency amplifier, which comprises two radiation-cooled pentodes, is suppressor-grid modulated. The speech amplifier consists of three push-pull stages and has an output of about 6 watts. It also contains an oscillator which produces the 800-cycle tone for modulated-continuous-wave operation.

The keying unit can be operated either by direct keying or a tone input. For high-speed keying, the output, which consists of a large negative voltage in the space condition, is applied to the grid of the first amplifier valve thereby biasing it beyond cut-off; for low-speed keying and carrier suppression it is also applied, suitably reduced, to the grid of the oscillator.

The high-tension supply for the final and penultimate radio-frequency amplifiers is provided by a 3-phase half-wave rectifier using 3 hot-cathode mercury-vapour valves. The 2200-volt output is smoothed by a single-stage choke-input filter and is connected to the penultimate amplifier through a dropping resistance.

High tension for the remaining valves is provided by the 550-volt supply unit which uses a 3-phase full-wave selenium-metal rectifier. Bias for the final radio-frequency amplifier is obtained from a similar unit, the output of which is 150 volts.

### 3.3 HIGH-FREQUENCY RADIOTELEGRAPH TRANSMITTER, I.M.R.53.

The *I.M.R.53* transmitter actually installed in the *Caronia* is the basic development of a new series designed to meet the requirements of the new United Kingdom specifications for marine equipment. It was inevitable that the *Caronia* model would have to be special inasmuch as remote frequency selection within a given band was essential. Another point affecting the design was the necessity for operation from 50-cycle alternating current already available in the ship. Future models of this transmitter will operate from 500-cycle power derived from the direct-current main supplies via a motor-alternator.

As shown in Figure 9 the transmitter is in two sections which are bolted together to form a single deck-mounted unit. A feature of the design is a rotating front panel on the radio-frequency

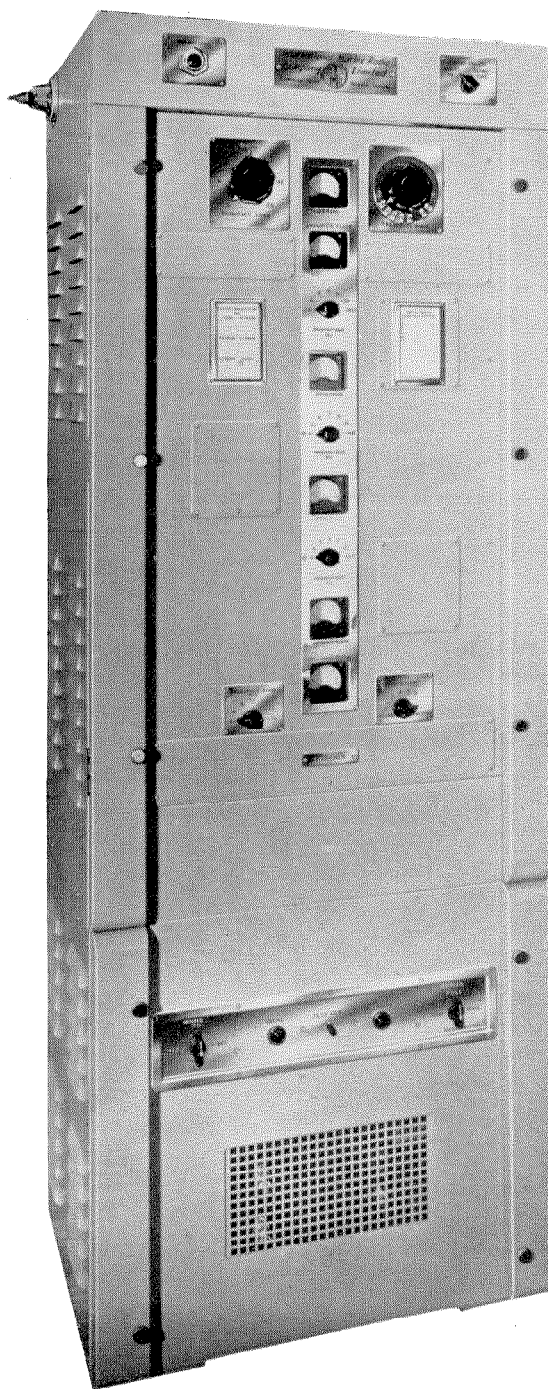

Figure 9—*I.M.R.53* high-frequency radiotelegraph transmitter.

(upper) unit, thus allowing immediate access to all circuits for rapid servicing, side and rear access being unnecessary.

or a rotary switch at the transmitter. Despite the large number of frequencies covered by the transmitter it is possible to keep the number of

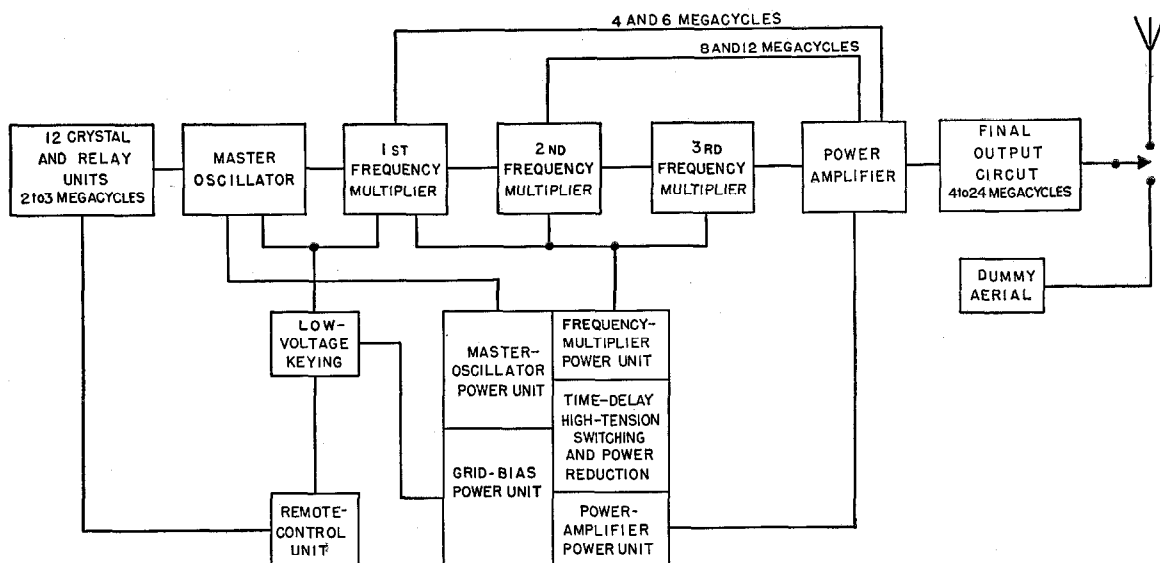

Figure 10—Block diagram of *I.M.R.53* transmitter.

The transmitter covers 7 marine bands between 4.0 and 24 megacycles and provides rapid selection of one calling and four working frequencies in each band. This arrangement is in accordance with the proposals for marine high-frequency operation as laid down at the International Telecommunications Union Convention, Atlantic City, 1947. Also in accordance with the latter convention continuous waves only are provided. Low-temperature-coefficient crystals fundamentally 2 to 3 megacycles with a basic accuracy of  $\pm 0.01$  per cent give the transmitter an overall tolerance of better than  $\pm 0.02$  per cent. A pi-section output circuit is used to reduce harmonic radiation and provide a flexible arrangement for coupling to aerials of random length as usually encountered aboard ship. Care has been taken in the design of the keying circuit to shape the waveform for avoidance of clicks and reduction of bandwidth.

Referring to Figure 10 it will be seen that 5 stages are employed, viz. a crystal-controlled oscillator of the Pierce type followed by 3 fairly orthodox stages of frequency multiplication. A total of 12 crystals are employed each being selected by a key switch at the operating position

crystals at a minimum by virtue of the degree of harmonic relation between the bands. For a given band the tuning of each frequency multiplier is preset to the midband point for the range of frequencies allocated, thus band change in these stages is accomplished by means of a single switch. Blocked-grid keying is employed on the master-oscillator and first multiplier stages.

The output stage employs two parallel-connected beam-tetrodes operating in class C. The aerial power is approximately 300 watts on all frequencies. A dummy load of 100 ohms may be switched into circuit for check purposes.

In the power unit selenium elements are used in the 5 separate full-wave rectifier circuits, which supply bias and anode voltages to the radio-frequency stages. This section also incorporates the usual protective devices including a thermal delay tube, which controls application of the anode voltages.

### 3.4 HIGH-, MEDIUM-, AND LOW-FREQUENCY TRANSMITTER, *I.M.R.29*.

The *I.M.R.29* transmitter is a modified version of a medium-power main equipment for

passenger vessels. The basic circuits are identical with those of the normal transmitter but remote frequency change has been added for all marine bands. The transmitter is seen at the left-hand side of Figure 3.

The general circuit arrangement is shown in Figure 11 from which it will be seen that the transmitter basically comprises a power unit and high-frequency unit, the medium- and low-frequency-determining circuits being switched in or out as required. The high-frequency section comprises a continuously variable or crystal-controlled beam-tetrode master-oscillator followed by an orthodox beam-tetrode buffer/-frequency doubler. The latter drives a class-C power amplifier employing 3 radio-frequency pentodes in parallel. The output power is approximately 500 watts, and a frequency range of 3 to 18 megacycles is covered. In the *Caronia* version of this transmitter it is possible to obtain 4 crystal-controlled harmonically related spot frequencies in 5 marine bands. Frequency stability using crystal-control is of the order of  $\pm 0.02$  per cent. The variable master-oscillator utilises an orthodox Colpitts circuit and the stability is within  $\pm 0.05$  per cent. Rotatable

coils give inductive tuning in all stages and, when using remote control, the required master-oscillator crystal is relay selected.

When the transmitter is switched to the medium/low-frequency condition the amplifier/-buffer tube operates as a variometer-tuned Colpitts master-oscillator. In the frequency band 365 to 525 kilocycles the variometer coils are in parallel whilst for 100 to 160 kilocycles they are in series. A similar sequence of events occurs in the power-amplifier anode circuit, which stage is driven directly by the master-oscillator. In the range from 100 to 160 kilocycles an external loading coil is necessary and is mounted directly below the transmitter. In the remote-control position frequency change is accomplished by means of contactors in both master-oscillator and output circuits.

The power supply to the rectifier unit is at 500 cycles thus providing modulated-continuous-wave operation at 1000 cycles by removal of smoothing elements in the high-tension supply to the power amplifier. Keying is accomplished by the use of a heavy-duty relay operating in the primary circuit of the mains transformer. The 500-cycle supply is obtained from a 1.5 kilovolt-

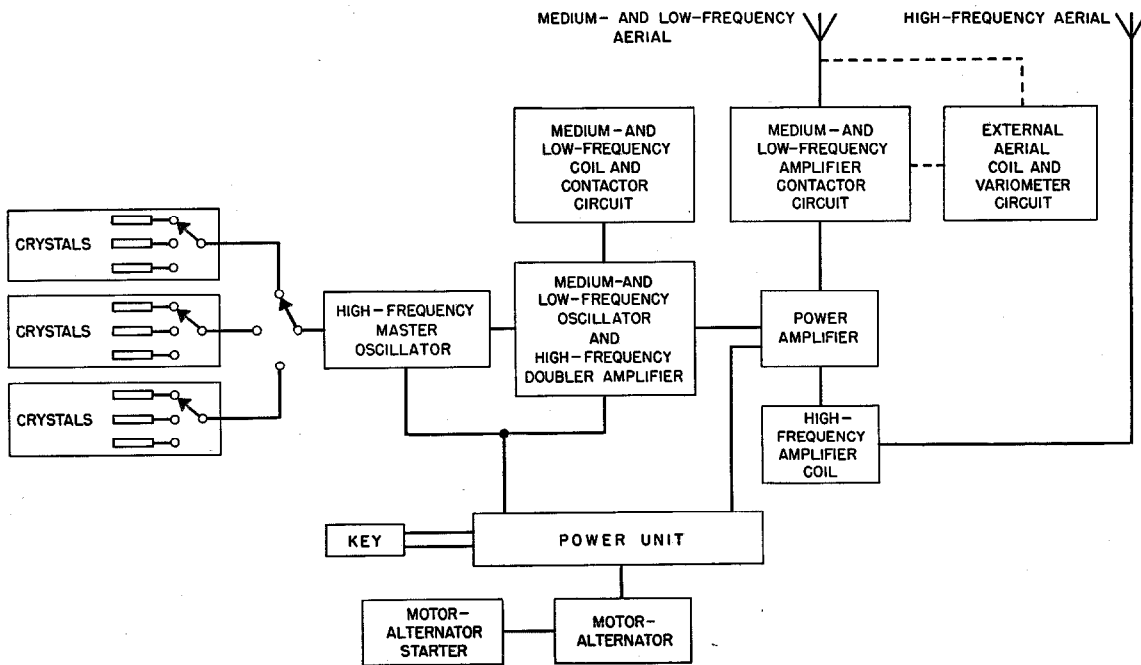

Figure 11—Block diagram of *I.M.R.29* high-, medium-, and low-frequency radiotelegraph transmitter.

ampere inductor-type motor-alternator which in turn derives its energy from the vessel's 220-volt direct-current mains. The motor armature is tapped and brought out to slip rings to provide alternating current for all tube filaments.

### 3.5 MEDIUM-FREQUENCY EMERGENCY TRANSMITTER, I.M.R.31.

The *I.M.R.31* transmitter together with its associated receiver (type *I.M.R.22*.) may be seen in Figure 3 bench-mounted between transmitters *I.M.R.29* and 53. As both of these emergency equipments together with an emergency lamp derive all their supplies from storage batteries, they form a complete station and can be operated for many hours if both the main alternating- and direct-current supplies fail.

The *I.M.R.31* transmitter employs a single triode in an open-oscillator circuit and is capable of covering the frequency band from 365 to 525 kilocycles. The aerial-circuit power is approximately 50 watts and a neon tuning indicator set at 500 kilocycles ensures that the equipment may be accurately adjusted to the distress frequency irrespective of the changes of aerial constants that are liable to occur.

Power is obtained from a 24-volt 200-ampere-hour storage battery. The tube filament is supplied directly from the battery which also drives a small inductor-type motor-alternator. Output from the motor-alternator at 600 cycles is applied to the tube anode via a step-up transformer. Keying is accomplished by directly interrupting the low-tension alternating-current circuit.

## 4. Receivers

### 4.1 SINGLE-SIDEBAND RECEIVER, R.X.9.

The *R.X.9* single-sideband receiver has been designed to meet the special requirements of ship-board use. Although in many ways simpler than comparable equipments intended for shore use, where size and weight are not limiting factors, it nevertheless offers full facilities for the reception of either or both channels of a double-channel independent-sideband transmission. It can be used for high-grade reception of double-sideband transmission.

Automatic frequency control is incorporated and the receiver is continuously tunable over the

range from 4 to 25 megacycles. The various units of the receiver are mounted in two 5-foot 5-inch racks as shown in Figure 12. Each chassis is arranged so that it can be slid outwards for

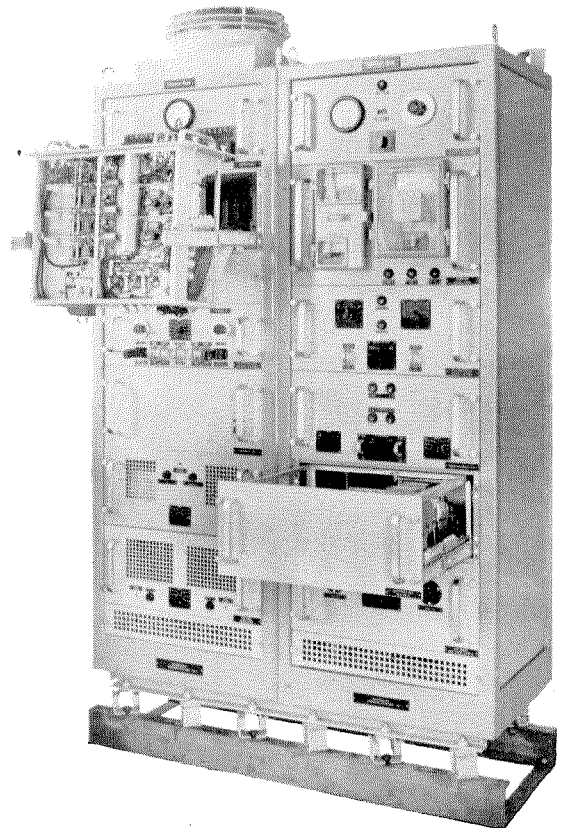

Figure 12—*R.X.9* high-frequency single-sideband receiver. Each chassis may be pulled out on runners and rotated through 90 degrees.

inspection and swung through 90 degrees. This is achieved by pivoting the chassis at its gravitational centre on bearings fitted to the forward runners. The chassis is normally locked on the runners in the horizontal position, but can be released to swing into the vertical position to facilitate servicing. All cabling from the rack to the chassis is arranged on semi-coiled formers to allow the units to be operated in the withdrawn position. In the interests of safety withdrawing the chassis removes all dangerous voltages, but these may be replaced by means of a key-operated switch.

Referring to Figure 13 the signal is passed to the receiver through the aerial coupling unit



and after two stages of radio-frequency amplification is mixed with the output of the first oscillator. The first oscillator is located in the oscillator unit and is continuously tunable. For frequencies below 10 megacycles it is tuned to  $(f_R + 3.1)$  megacycles and for higher frequencies to  $(f_R - 3.1)$  megacycles where  $f_R$  is the frequency of the received signal.

The output from the first frequency changer at 3.1 megacycles is selected by band-pass filters and after two stages of amplification is applied with the output of the second oscillator at 3 megacycles to the control grid of the second frequency changer. The resulting 100-kilocycle signal is fed through a low-pass filter to the grids of three output valves, which feed the two sideband amplifiers and the carrier amplifier through crystal filters.

The crystal filters each consist of a pair of two-section lattice networks and are contained in a thermostatically controlled oven. The filter feeding sideband amplifier *A* passes the band 100.1 to 105.8 kilocycles and the one feeding sideband amplifier *B* passes the band 94.2 to 99.9 kilocycles. The filter in the carrier amplifier is peaked at 100 kilocycles.

The sideband amplifiers each consist of two intermediate-frequency stages, a balanced demodulator, and an audio-frequency output stage.

In the demodulator stage the signal is applied in opposite phase to the control grids of two valves and the reconstituted (or locally generated) 100-kilocycle carrier is applied in the same phase to each control grid. The level from the output stage is adjustable between  $-4$  and  $+16$  decibels with reference to 1 milliwatt, and is sufficient for it to be connected direct to line. A volume indicator is provided to enable this level to be monitored continuously.

The first oscillator is used normally with 6 crystals mounted in a thermostatically controlled oven. As an emergency measure it can be used as an auto oscillator. Its frequency range is 3.225 to 6.55 megacycles and it is followed by a doubler stage. Thus the input to the first frequency changer is in the band 6.45 to 13.1 megacycles. When signals below 10 megacycles are to be received, the lower modulation product is selected by the anode circuit of the frequency changer, so that the possible signal frequency range is 3.35 to 10 megacycles. Above 10 megacycles the higher modulation products are selected and the possible frequency range is 10 to 16.2 megacycles. Above this frequency the second harmonic of the output is used to extend the range to the limit of the signal-frequency stages, i.e. 25 megacycles.

The second oscillator uses a beam-tetrode in a conventional high-stability circuit to oscillate at 3 megacycles. A trimming capacitor driven by the automatic-frequency-control motor is connected across the main tuning capacitor.

The third output from the receiver is taken to the carrier amplifier, where it passes through a three-section lattice crystal filter tuned to 100 kilocycles to an attenuator which enables the overall gain of the amplifier to be adjusted according to the level of the carrier (i.e. for single-

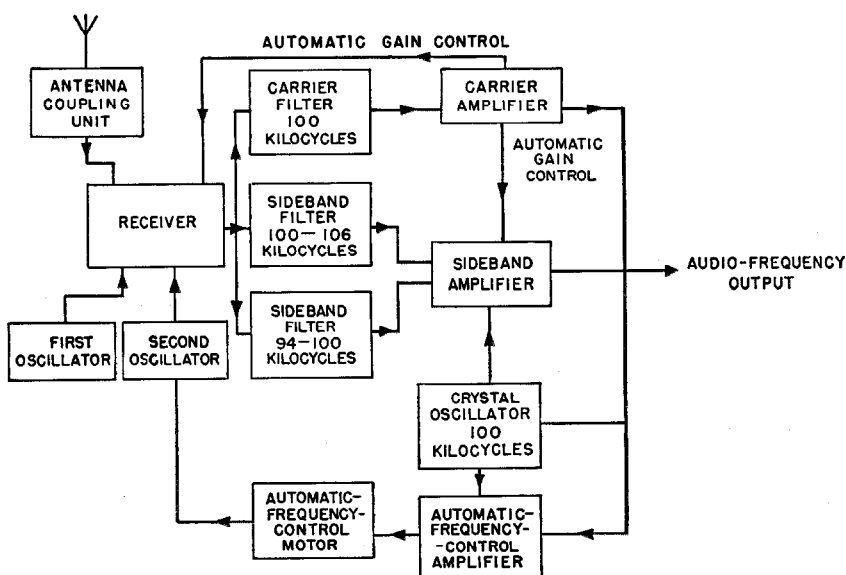

Figure 13—Block diagram of R.X.9. receiver.

or double-channel single-sideband or for double-sideband working). The carrier then passes through three amplifier stages the last of which

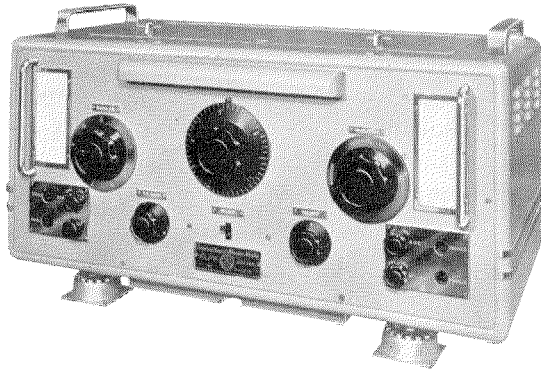

Figure 14—High-, medium-, and low-frequency receiver type *I.M.R.42*.

feeds four separate circuits. The first of these provides the 100-kilocycle input to the automatic-frequency-control amplifier where it is compared with the output of a high-stability 100-kilocycle reference oscillator, any difference being fed to the motor driving the trimmer across the tuning circuit of the second oscillator.

The second circuit provides automatic gain control and consists of a rectifier and a direct-

current amplifier. The output from the latter is fed back to control the gain of the receiver and also forward to the sideband amplifier.

The third circuit comprises the carrier cut-out, the function of which is to remove the carrier output when it is below a certain level to prevent the automatic-frequency-control motor from operating under the control of weak carrier or noise.

The fourth circuit operates the carrier alarm system. Under no-signal conditions a red indicator lamp on the front panel lights and after a delay an alarm bell rings.

The power required is approximately one kilowatt at 220/250 volts 50/60 cycles. The main supply is connected to the alternating-current input and oven supply unit, which provides in addition to the 75-volt alternating-current supply for the oven heaters and the 6- and 75-volt direct-current supplies for the associated relays, an output of nominally 325 volts for the voltage-regulator unit. This unit provides 240 volts of regulated alternating current to individual heater transformers located in each of the various units and a separate similar supply to the stabilised power unit, auxiliary power unit, and automatic-frequency-control power unit.

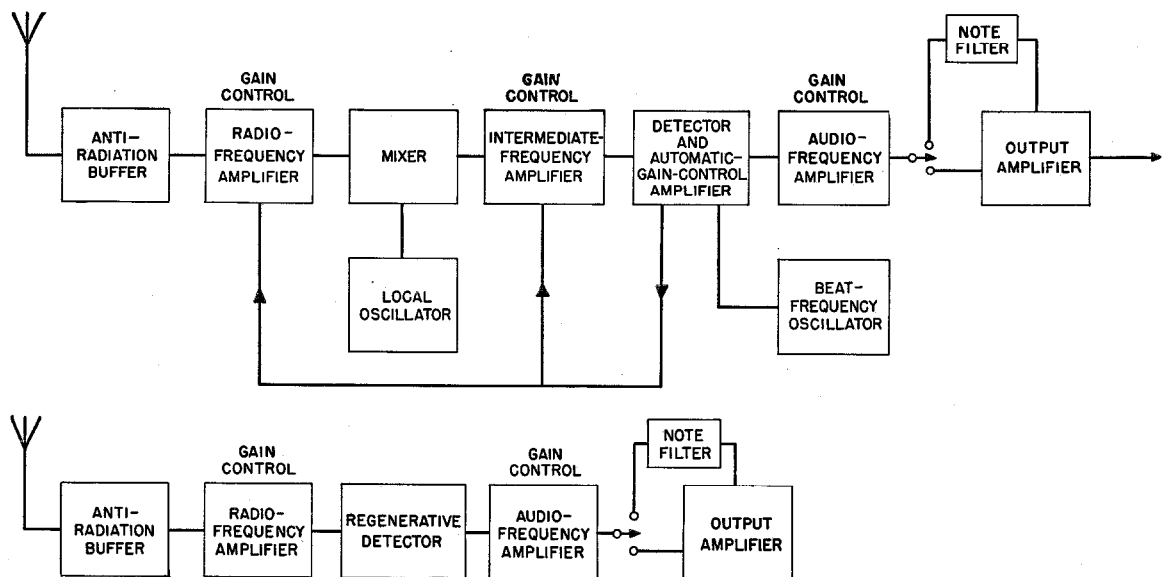

Figure 15—Block diagram of *I.M.R.42* receiver. From 25 megacycles to 150 kilocycles the upper superheterodyne circuit is operative and from 15 to 150 kilocycles the lower tuned-radio-frequency arrangement is used.

The stabilised power unit provides the high-tension supplies for most of the units, while the auxiliary power unit provides the bias supplies and the floating high-tension supply for the automatic-gain-control circuit. The automatic-frequency-control power unit provides the 240-volt direct-current supply for the automatic-frequency-control amplifier and motor units.

#### 4.2 HIGH-, MEDIUM-, AND LOW-FREQUENCY RECEIVER, I.M.R.42.

The *I.M.R.42* receiver shown in Figure 14 has been recently developed to cover the complete frequency spectrum between 15 kilocycles and 25 megacycles apart from a narrow band above and below the intermediate frequency of 580 kilocycles. To avoid the use of conversion units it has been designed to operate directly from 110 volts direct or alternating current. When the mains supply is 220 volts an external series dropping unit is provided. In the *Caronia* the *I.M.R.42* receivers are operated from 220 volts 50 cycles via a step-down transformer.

A total of 11 valves are employed in what may be described as a "double" circuit arrangement. From 150 kilocycles to 25 megacycles the circuit follows the lines of a fairly orthodox superheterodyne, but from 15 to 150 kilocycles it operates as a tuned-radio-frequency receiver. In each combination the first tube functions as an untuned buffer stage designed to reduce radiation in accordance with United Kingdom requirements.

As will be evident from Figure 15 in the superheterodyne version the buffer tube is followed by a radio-frequency pentode amplifier stage feeding directly into a triode-hexode mixer. The local oscillator is a separate pentode, which on the low-frequency ranges operates as a leaky-grid detector. Two stages of intermediate-frequency amplification at 580 kilocycles follow the mixer, and the second intermediate-frequency transformer has variable coupling, providing three degrees of selectivity controlled by a switch on the front panel. The second detector and automatic-gain-control stage employ a double-diode-triode, and the audio-frequency complement is made up by two pentodes, the first being transformer-coupled to the final. A 1000-cycle note filter is interposed between these two stages and

may be switched in or out of circuit from the front panel. The final audio-frequency stage, which also incorporates a noise limiter of the

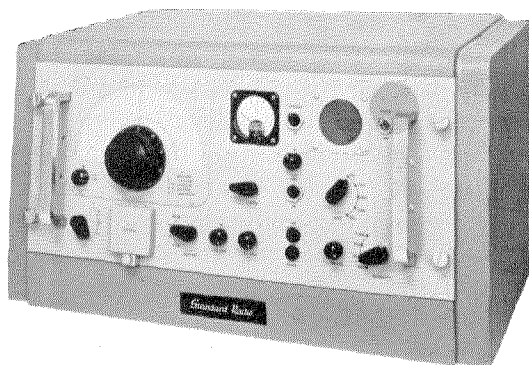

Figure 16—*R.V.9* medium- and high-frequency receiver.

back-to-back rectifier type, feeds two headphone jacks and an internal monitor loudspeaker. High-tension voltage is supplied via a half-wave high-vacuum rectifier tube and orthodox smoothing circuits. The high-tension voltage to the mixer tube is stabilized and all heaters are connected in series.

The output from a separate fixed-frequency beat-frequency-oscillator stage, employing a pentode tube, is injected at the signal diode of the second detector, thus providing for reception of continuous-wave signals.

When operating in the low-frequency band a relay, energised by the turret contacts, converts the superheterodyne arrangement into a tuned-radio-frequency circuit comprising buffer stage, two radio-frequency amplifier stages, a leaky-grid detector-oscillator, and the two normal audio-frequency stages. The beat-frequency oscillator is variable, thus full use may be made of the 1000-cycle note filter, which is particularly indispensable at the very low frequencies.

#### 4.3 MEDIUM- AND HIGH-FREQUENCY RECEIVER, R.V.9.

The *R.V.9* receiver comprises a 9-valve superheterodyne continuously tunable over the range from 500 kilocycles to 25 megacycles. It is mounted in a light-alloy cast case with sloping front as shown in Figure 16 and is designed to withstand the most severe operating conditions.

The circuit as shown in Figure 17 comprises radio-frequency amplifier, frequency changer, three stages of intermediate-frequency amplification, detector, beat-frequency oscillator, noise limiter, audio-frequency amplifier, and output amplifier. Automatic gain control is applied to the radio-frequency amplifier and the first two intermediate-frequency amplifier stages.

The input circuit is designed to match an open aerial, 75- or 600-ohm single line, or 75-ohm balanced or coaxial feeder. An aerial trimmer control is provided to compensate for different lengths of aerial and ensure maximum signal-to-noise ratio. Radio-frequency gain control is obtained by varying the cathode bias of the radio-frequency amplifier valve.

A triode-hexode is used as mixer and oscillator. The frequency of the oscillator section can be determined by crystal or by the setting of the main tuning capacitor. In the latter case fine frequency control is obtained by a trimmer connected in a special circuit that maintains the adjustment obtainable almost constant over the whole frequency range. The anode circuit of the hexode portion of the valve is tuned to the intermediate frequency of 580 kilocycles.

The intermediate-frequency amplifier comprises three stages with seven tuned circuits. Three different degrees of selectivity are available. In their normal condition the tuned circuits pass a band 6.5 kilocycles wide. For the "medium" bandwidth condition the coupling between these circuits is reduced and the

"narrow" bandwidth is obtained by the use of a single crystal filter in a gate circuit. If still greater selectivity is required for continuous-wave working a note filter can be switched into the audio-frequency stages to reduce the bandwidth to about 300 cycles.

A tuning meter, approximately calibrated in S units, is connected in the anode circuit of the second intermediate-frequency tube.

A double-diode-pentode valve is used for the third intermediate-frequency and detector stages and for the production of the automatic-gain-control voltage. A separate double-diode valve can be switched in as a noise-limiter. This is arranged to silence the receiver when the carrier becomes more than 100-per-cent modulated due to a noise pulse.

The audio-frequency note for continuous-wave operation is provided by a heterodyne oscillator connected in a Hartley circuit. Temperature compensation is obtained, as in the case of the oscillator portion of the frequency changer, by the use of components with balanced temperature-coefficients. The note control enables the frequency of the oscillator to be varied  $\pm 1000$  cycles from the centre frequency of the intermediate-frequency amplifier.

The output tube is a beam-tetrode which is arranged to feed an internal loudspeaker, phones, or a 600-ohm line as required. The output power available is 400 milliwatts.

Operation is obtained entirely from 50-cycle alternating current.

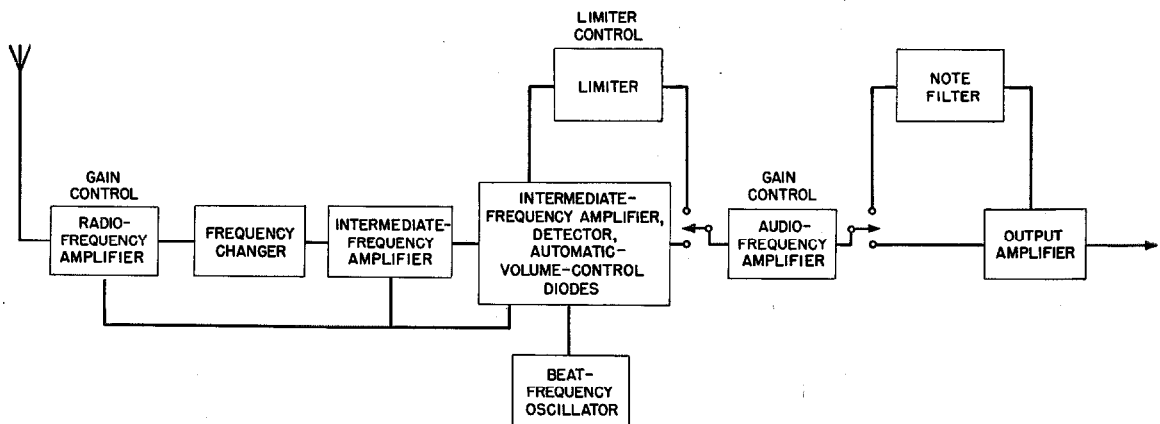

Figure 17—Block diagram of R. V. 9. receiver.

#### 4.4 LOW- AND MEDIUM-FREQUENCY RECEIVER, R.V.11.

The *R.V.11* receiver is a simple tuned-radio-frequency receiver primarily intended for marine communication. It is continuously tunable in four bands from 38 to 550 kilocycles. In addition it is possible to set the receiver to a broad-band condition in which it will receive signals on any frequency between 487 and 512 kilocycles.

The receiver is fully tropical and employs hermetically sealed audio-frequency and power transformers. It is housed in a cast light-alloy case as shown in Figure 18. Flywheel tuning with geared drive between logging scale and capacitor facilitates rapid change of frequency.

The circuit comprises two radio-frequency amplifiers, detector with regenerative feedback, audio-frequency amplifier, and output stage. Variable-mu pentodes are used in the first three stages and radio-frequency gain and reaction controls are provided.

Continuous-waves, modulated-continuous-waves, or telephony may be received, the beat note for continuous-wave reception being obtained by using the set in the oscillating condition.

Power is obtained entirely from 50-cycle alternating current.

#### 4.5 BROADCAST RECEIVER, B.R.40.T. (I.M.R.56.)

Although nominally part of the ships' public-address and music-reproduction system, the broadcast receiver is housed in the radio receiver room, operates from the ship's alternating-current supply, and is capable of connection to any of the remote receiving antennae. It is a 7-tube superheterodyne covering both medium- and high-frequency bands. A feature of the receiver is its efficient bandspread over the normal high-frequency broadcast bands. Frequency drift on the later bands is reduced by the use of temperature-compensated capacitors, and a "magic-eye" type indicator facilitates tuning. A radio-frequency buffer stage is incorporated to reduce radiation to the limits specified by United Kingdom regulations. In addition to the buffer stage, the circuit includes a radio-frequency amplifier; frequency changer; intermediate-frequency amplifier; demodulator,

automatic volume control, and audio-frequency stage; and a beam-tetrode output amplifier. The power supply circuit employs a full-wave vacuum-tube rectifier.

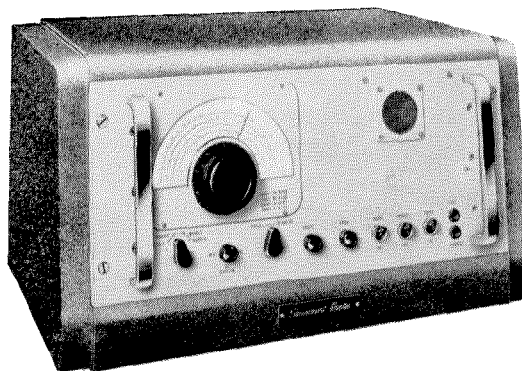

Figure 18—*R.V.11* low- and medium-frequency receiver.

Maximum undistorted output is 4 watts and a built-in loudspeaker provides for local monitoring. The whole is housed in a steel cabinet and is located at the forward end of the receiver room immediately below the monitoring and patching unit.

### 5. Telephone Terminal Equipment

The telephone terminal equipment has been specially developed to provide the minimum of circuitry necessary for operating either two- or four-wire subscriber circuits. From experience gained during operation of the terminal equipments in the *Queen Mary* and *Queen Elizabeth* it was generally agreed that line vodas (voice-operated device, anti-singing) for two-wire operation via the ship's exchange is unnecessary, particularly as one of these devices is always in operation at the shore end of the circuit and local "sing" has never been reported. As a further measure to reduce the size of the terminal equipment it was also decided to omit such items as the compandor (compressor-expandor) and vogad (voice-operated gain-adjusting device) although the expandor section of the compandor unit is considered a useful adjunct and may be added at a later date.

The general arrangement of the terminal equipment is shown in Figure 19 and the rack assembly may be seen at the extreme right of the

frontispiece. Complete control of the equipment and extensions is carried out from operating position 4 where the control console is located. Two 2-wire subscriber's circuits and an order-wire circuit are provided to the ship's manual exchange. In addition to the foregoing there is a single 4-wire circuit to a special booth for use when conditions are bad or in case of a failure at the ships' exchange. The exchange circuits have been duplicated, as far as cabling is concerned, to allow for the addition of a further terminal equipment if considered necessary at a later date. A feature of the order-wire circuits is an arrangement whereby a second subscriber can be prepared for a call whilst a prior call is in progress, e.g. a "flick" of a key switch serves to release the first subscriber at the completion of a call and connects the waiting subscriber to the radio circuit. This arrangement saves considerable time between calls without detracting from the quality of the radio circuit, as the operator's headphone earpieces are split, one monitoring the radio circuit and the other connected to the order-wire circuit.

Privacy arrangements comprise a 4-wire inverter, which is inserted during all subscriber calls. When carrying out high-quality broadcasts from the ship, the terminal equipment is bypassed by patching cords and the speech level is controlled at a separate microphone-amplifier-mixer unit. A "cue" line from the terminal "receive path" is fed back to the broadcast microphone position. The rack assembly also includes an 800-cycle tone oscillator for transmitter and

circuit lining-up. The latter may also be used in conjunction with the volume indicator for level testing throughout the equipment. The whole terminal equipment operates from 50-cycle alternating current at 220 volts.

## 6. Antenna System

When designing a ship's antenna system the engineer is confronted with a number of problems that are usually not encountered ashore. Firstly, shipboard antennae, however carefully they are designed, always detract from the appearance of the vessel, and secondly antennae calculated for certain desired characteristics often differ widely when actually put into practice. Finally, they must be erected in such a way that they are able to withstand the high wind velocities sometimes encountered aboard ship and must be suitable for almost any type of climate. Summarising it may be said that ship's antennae must be as simple as possible, robust, easy to maintain, and suspended in such a manner that they "blend" with the lines of the ship. In the *Caronia* which is an ultra-modern vessel of pleasing lines the latter point is of extreme importance.

Owing to the fact that the radio offices are located in the forepart of the vessel almost directly below the single mast it was fairly obvious from the outset that the transmitting antennae should be concentrated about that point, making maximum use of mast and funnel. It was decided that a total of three high-frequency transmitting antennae should be em-

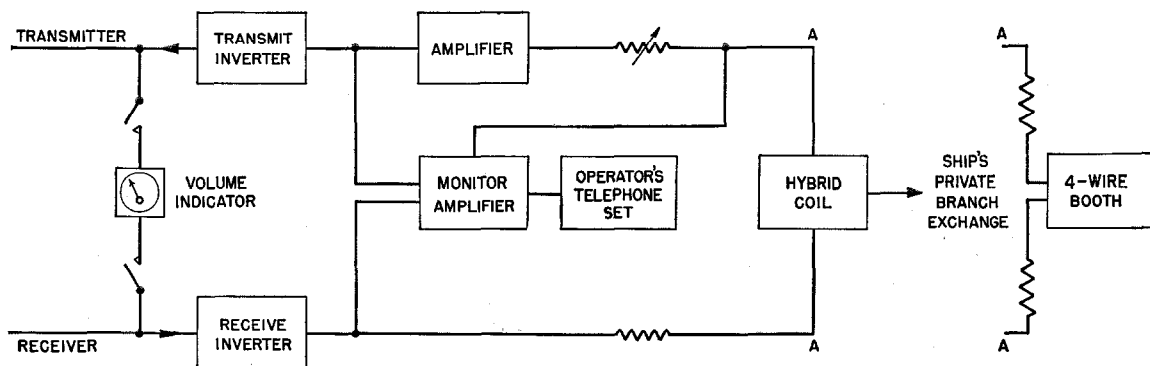

Figure 19—Telephone terminal equipment. The termination differs at points A-A depending on whether the call is made through the ship's private branch exchange or from the booth in the night acceptance office.

ployed and these, which take the form of single-wire "verticals" of random length, are suspended from a jumper stay between mast and funnel. The most difficult problem was to obtain sufficient length for the medium/low-frequency transmitting antenna which finally took the form of two "legs" running from each side of the funnel to the extremities of a 25-foot yard near the top of the mast, the free ends being extended some 120 feet forward and made fast at each side of the forepeak—a total of 240 feet in each "leg." A separate lead-in is taken from each wire at the funnel. The latter are led through the trunk separately so that one or two "legs" might be used as required.

The emergency antenna which is required by law to be suspended from extremely rigid structures, preferably not the masts, is run between the lead-in trunk, starboard side of the funnel, and a Samson's-post slightly abaft the funnel. All transmitting antennae are terminated at a distribution board in the transmitter room and may be patched to any transmitter or earthed.

To reduce coupling between transmitting and receiving antennae to a minimum, the latter are located abaft the funnel at the extreme end of the boat deck. Owing to the wide frequency range to be covered viz.: 15 kilocycles to 25 megacycles it was necessary to arrange for each of the four antennae to cover as wide a band as possible. Perhaps the most important receiving an-



Figure 20—Receiving antennae.

tenna is that used mainly for radiotelephone reception covering the frequency band 8 to 25 megacycles. This antenna takes the form of a dipole of the vertical folded and terminated type. It is made up of two vertical steel whips electrically joined at their upper extremities and with insulated spacers at intervals down to the base. As shown at the right-hand side of Figure 20 the whole assembly is mounted at the top of a post 25 feet above the boat deck. Termination is by means of a wideband matching unit, the low-impedance winding of which is connected to the receiver room through about 250 feet of coaxial cable.

On the port side of the ship—left-hand side of Figure 20—is a similar 25-foot post which

mounts a single 30-foot whip antenna covering a frequency band of 1.5 to 10 megacycles. The lower end of this whip is similarly terminated in a British Admiralty type wideband matching unit connected to the receiver room via a low-impedance coaxial cable.

To cover the medium- and low-frequency bands two orthodox inverted  $L$  antennae are suspended between the "after" end of the funnel and the posts supporting the whips. The free ends of these antennae may be seen in Figure 20. They are both terminated in Admiralty type transformers, located inside the funnel casing, and connected to the receiver room through coaxial cable.

At the receiver room all feeder cables are terminated at a distribution unit as mentioned earlier.

### 7. Navigational Equipment—Direction-Finder, I.M.R.26.

Despite the advent of loran, Decca, and other new position-finding systems developed mainly during the war years, the medium-frequency direction-finder still plays a major role as a reliable navigational aid.

What might be called the "radio corner" of the wheelhouse is covered by Figure 21 with the radiotelephone left and direction-finder right. The latter is of the rotating-loop type with direct drive from the handwheel. The upper case houses the scale, automatic quadrantal-error compensator, and gyro-repeater motor, whilst the lower case encloses the receiver.

The receiver is of the tuned-radio-frequency

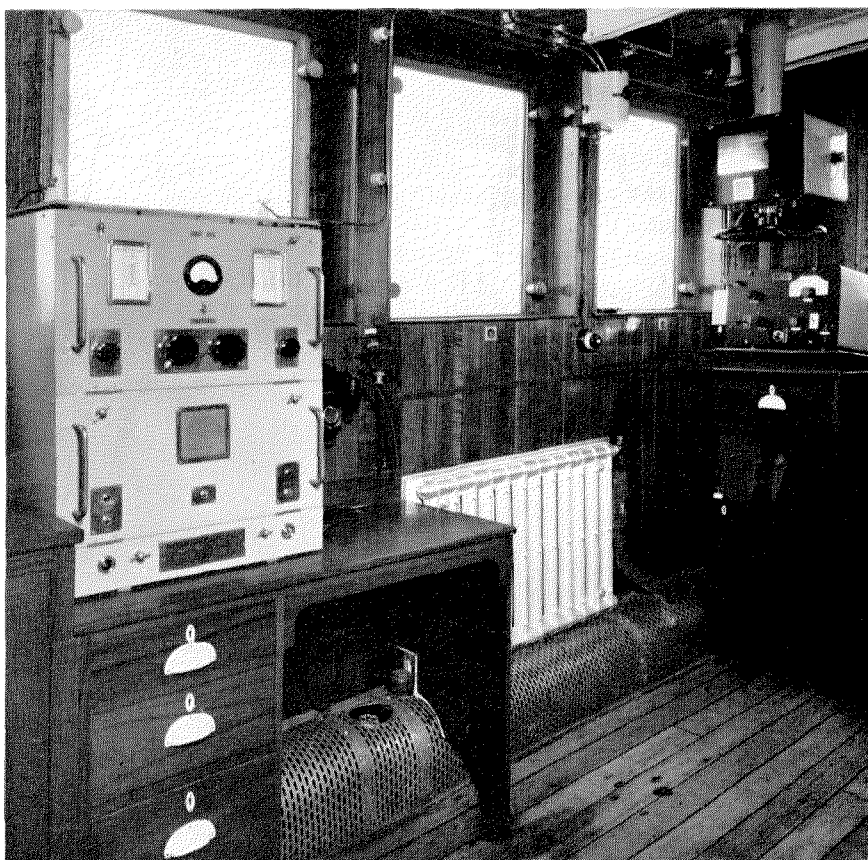

Figure 21—Corner of wheelhouse (port side) showing direction-finder and radiotelephone.

type employing two radio-frequency stages followed by a reacting detector and audio-frequency stage. The loop winding, which is of the earthed-centre-point type, is terminated at sliprings in the upper unit and conveyed from there to the receiver unit in coaxial low-loss cable. A single-wire antenna some 45 feet long is connected directly to the receiver unit and serves to provide for "sense" determination and zero balance.

Nominally the direction-finder requires supplies at 4 volts and 120 volts for heaters and anodes respectively. In the *Caronia* these voltages are supplied by a special selenium rectifier unit operated from the ship's 50-cycle alternating-current supply.

### 8. Radiotelephone, I.M.R.42/36.

In these days when almost all small vessels, such as lightships, pilot cutters, and customs and medical launches, are fitted with low-power



radiotelephone equipment, it is essential that even the larger liners should be able to communicate with them directly, i.e. without recourse to the ship's main radio service. For this reason a complete transmitting and receiving radiotelephone has been installed on the bridge as depicted in Figure 21.

The *I.M.R.43/36* radiotelephone comprises a crystal-controlled transmitter and receiver; the transmitter having an output power of approximately 25 watts. Two stages only are employed in the transmitter viz.:- a triode oscillator and a single-ended power amplifier. A total of 10 crystal-controlled "spot" frequencies may be preset anywhere between 1.5 and 4 megacycles. High-level anode modulation is employed and the carrier is controlled by a pressel\* switch on the microtelephone handset. The receiver is a 7-tube superheterodyne comprising a radio-frequency stage followed by a mixer which derives its local oscillation from a separate crystal-controlled stage. The mixer is followed by an intermediate-frequency stage of 580 kilocycles, demodulator and automatic volume control, and audio-frequency amplifier. As in the case of the transmitter a frequency range of 1.5 to 4.0 megacycles is covered and a total of 10 "spot" frequencies may be preset anywhere within the range. The seventh tube is employed in a separate carrier-operated noise limiter which operates from the automatic-volume-control circuit and mutes the receiver until a carrier is present.

The complete equipment operates from the ship's 220-volt 50-cycle supply. Separate rectifier units are employed for transmitter and receiver. A feature of the equipment is the alternative use of the modulator output to energise a highly directional loud hailer. An audio-frequency output of some 15 watts is available for this purpose.

### 9. Public-Address and Music-Reproduction Equipment

It will be appreciated that in a modern liner the rediffusion of information, news bulletins, and music is an essential service. The *Caronia* is no exception to this rule and has an extensive public-address equipment, the main console of which is shown in Figure 22.

The main console, which is housed in a special

\* Press-to-talk switch.

room, comprises basically a control panel, two gramophone turntables, and four amplifiers each with a final output of 50 watts. Each amplifier comprises four stages with input facilities for microphone or gramophone pickup. Externally there are 62 loudspeakers in 17 groups and 7 microphone points. The loudspeaker groups and amplifiers are arranged in accordance with local requirements to enable more than one programme to be diffused simultaneously. Double-screened microphone cables are run directly to the radio receiver room for the handling of incoming and outgoing broadcast programmes. In the case of outgoing broadcasts from a particular public room the microphone line from that room is patched directly to the radio receiver room and the loudspeaker line is utilised for "cue" reception by means of headphones at the point where the broadcast is taking place.

The whole equipment operates directly from the 50-cycle power system each amplifier having its own rectifier circuit.

### 10. Acknowledgment

The high-frequency radiotelephone equipment was designed and manufactured by Standard Telephones and Cables, Limited, London, for the

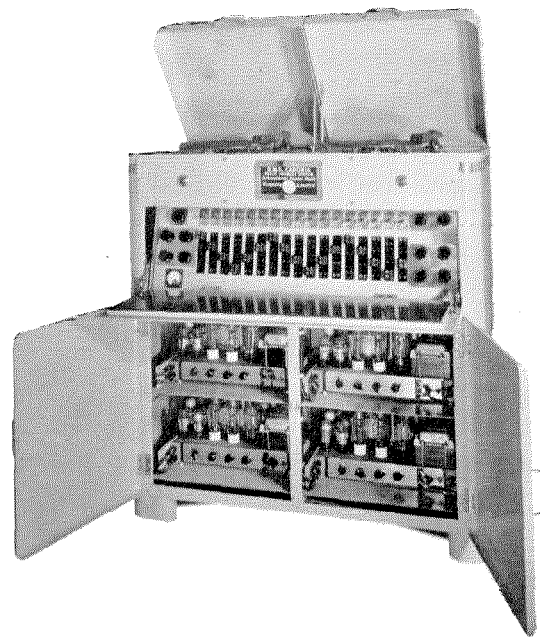

Figure 22—Public-address console with front panel and doors open.

International Marine Radio Company, Limited, who designed and manufactured the radiotelegraph equipment and were responsible for the supply, systems planning, installation, and operation of the entire radio, direction-finding, and public-address equipments.

Acknowledgements are due to both of the above companies for their assistance in the preparation of this paper. Thanks are also extended to the owners of the vessel, Cunard-White Star, Limited, for permission to publish the information.

### Recent Telecommunication Developments

**C**HINESE HONOR SIR FRANK GILL—The Order of the Brilliant Star with Special Rosette was conferred by the President of the National Government of the Republic of China on Sir Frank Gill, K.C.M.G., O.B.E., Chairman of the Board of Standard Telephones and Cables, Limited.

The award is in recognition of Sir Frank's services to China, including the organization of public-utility works in Shanghai and (as Chairman of F.B.I. Chinese Engineering Post Graduate Apprenticeships Committee) the promotion of industrial cooperation between China and Britain during the war.

The presentation was made by the Chinese Ambassador in London on March 24, 1949, at a reception at the Chinese Embassy.

**P**OST OFFICE TELECOMMUNICATIONS JOURNAL—A new publication has been initiated by the Post Office of the United Kingdom to promote and extend knowledge of the operation and administration of telecommunications. The Post Office Telecommunications Journal is published quarterly in February, May, August, and November. Annual postal subscriptions at 92 cents, U.S.A., post free to any address, should be directed to the Editor, Post Office Telecommunications Journal, Headquarters G.P.O., London, E.C.1, England, by means of an international money order made payable to the Postmaster-General, London. Volume 1, number 1, bears the date of November, 1948.

# Facsimile Transceiver for Pickup and Delivery of Telegrams\*

By G. H. RIDINGS

*Western Union Telegraph Company, New York, New York*

THE MECHANIZATION PROGRAM of Western Union, regarding which much has been said and written, has placed great emphasis on getting telegraph communications from one city to another in the quickest time practicable, at the least cost, and with a minimum of human intervention. Direct circuits between the various cities have been increased in number many fold, and manual handling of messages has been replaced largely by mechanical switching methods at all but the terminating pickup and delivery points. All of these improvements have a great impact on the over-all speed and dependability of telegraph service. However, there is a vast majority of the American public whose use of the telegraph is only occasional, and who have no way of getting their telegrams to and from the telegraph office except by messengers or by telephone.

The most promising approach to the problem of providing faster terminal handling to these smaller patrons is the development and application of mechanical recording and transmitting devices that will be low enough in first cost and in operating and maintenance charges to permit their employment on a broad scale for use in pickup and delivery service. The patrons to be served may be roughly grouped as:

A. Individual business houses.

B. Large office buildings, apartment houses, and hotels, giving the occupants the benefit of direct connection to the central office, even though their individual use of the telegraph may be infrequent.

C. Residential areas, to be provided with automatic, conveniently located devices for pickup and Telecars<sup>1</sup> for delivery. Telecars are automobiles equipped with message recorders having direct radio connection to the nearest central office.

It should be noted that all three objectives require direct wire communication with the

\* Presented before the Winter General Meeting of the American Institute of Electrical Engineers in Pittsburgh, Pennsylvania, on January 29, 1948. Revised paper reprinted from *Western Union Technical Review*, v. 3, pp. 17-25; January, 1949.

central office by means of automatic or semi-automatic machines that will be simpler, less expensive, and easier to operate than telegraph printers, and better suited to written-message-service requirements than telephone recording. These requirements can be met only by employing some form of facsimile process.

## 1. *What Has Already Been Accomplished*

The basic groundwork for a Telefax<sup>1</sup> service for pickup and delivery of telegrams by facsimile methods has been well laid and further progress should be at a rapid rate. The key of this development is a recording paper called Teledeltos.<sup>1,2</sup>

Teledeltos is a dry recording paper which, unlike most recording media, requires no processing of any kind before or after recording. The coating of this conducting paper is light in color and turns black when an electrical current of about 20 milliamperes passes through it. Either alternating or direct current may be employed in recording. The paper is sensitive only to electrical impulses and is affected by light or moisture much less than is ordinary writing paper. It produces a clear-cut and permanent record, requiring no "fixing" of any kind. There is no apparent aging of records many years old. Teledeltos is extremely fast, pulses of 0.0001-second duration being easily recorded. It is capable of reproduction speeds many times the highest yet employed in commercial facsimile equipment. Its current-density characteristic is such that fairly good half-tone reproduction may be obtained if desired, without special circuit arrangements. Its cost is a small fraction of the cost of photographic paper. Only the simplest of recording equipment is needed. Amplified tone signals, without rectification, may be applied

<sup>1</sup> Registered trademark of the Western Union Telegraph Company.

<sup>2</sup> G. Hotchkiss, "Electrosensitive Recording Paper for Facsimile Telegraph Apparatus and Graphic Chart Instruments," *Western Union Technical Review*, v. 3, pp. 6-15; January, 1949.

directly to the paper by means of a stylus riding continuously on its surface.

A number of different types of automatic and semiautomatic transmitters, transmitter-recorders, and recorders have been developed and employed commercially on a limited scale for the pickup and delivery of telegrams. Among these, is the transmitter-recorder shown in Figure 1, designed for use in a patron's office. It is about the size and shape of a teleprinter or typewriter. This machine may be placed on a table or desk or may be furnished complete with a pedestal. The machine is 11 inches high, 16½ inches wide and 15½ inches deep. It is self-contained, requiring only a pair of line wires, a ground, and a

source of 110-volt, 50-60-cycle alternating current for its operation. This machine has three controls: a send-receive switch, a vernier control for adjusting the density of the recorded copy, and a starting switch. To transmit a telegram, the copy, either typed or hand-written on a blank of proper size, is wrapped by hand around the drum, which protrudes from one side of the cover. The send-receive switch is set to "send" and the starting switch operated. Thereafter, operation is entirely automatic. A call is set up in a concentrator at the central office. There, a switching unit in which the patron's line terminates automatically connects an idle recorder to the circuit and the message is recorded. The

scanning of the message for transmission is by a light beam and photoelectric cell, associated with a suitable system of lenses. After the message has been completely scanned, the patron's machine shuts down automatically.

To transmit a telegram from the central office to a patron, the attendant wraps the message about a drum and inserts it into one of several transmitters, which are a part of the concentrator. She then connects the transmitter to the patron's line causing a buzzer to sound summoning him to his machine. The patron places a sheet of Teledeltos on the drum, sets the send-receive switch to "receive" and operates the start switch. Transmission starts immediately and automatically. When the message has been recorded and the transmitter stopped, a red signal lamp on the top



Figure 1—Telefax transmitter-recorder with optical scanning.

of the patron's machine will light and the patron may stop the machine and remove the telegram. If the patron does not stop the machine it will continue to scan until the entire blank has been



Figure 2—Automatic Telefax transmitter.

scanned, at which time it will shut itself off automatically. If, in sending or receiving a message, the send-receive switch is inadvertently placed or left in the wrong position, the red signal lamp will light and transmission will not start until the switch is operated correctly.

Another Telefax development is the transmitter, shown in Figure 2, designed to facilitate the pickup of telegrams in office buildings, apartment houses, hotels, and similar locations. In this equipment, another step has been taken towards the goal of a completely automatic telegraph system. With these machines, it is easy to file a telegram. The sender or agent simply presses a button and drops the telegram into the slot in the front of the machine. This is all that is required of him. The telegram automatically wraps itself about the drum of the trans-

mitter and the entrance to the slot closes, preventing the insertion of another telegram until the first one has been transmitted. Several of these machines may be operated over one line pair where the volume of business is light. Circuits from these transmitters terminate in a central office in a facsimile receiving concentrator from which all of the functions of the transmitter are controlled. After the message has been recorded at the central office, the telegram is stripped from the drum of the transmitter and deposited into a receptacle beneath the drum, and the transmitter released.

Two types of transmitters are employed in this service. One is a wall model about 30 inches high, 15 inches wide, and 8 inches deep. The other, illustrated in Figure 2, is a table model, 24 inches high, 16 inches wide, and 12 inches deep. This model may be equipped with a pedestal if desired so that it will rest directly on the floor. Both machines are completely self-contained, requiring only a pair of line wires, a ground, and a source of 110-volt, 50-60-cycle alternating current for their operation. Where an agent is employed to operate it, the machine is equipped with a push-button for starting. Where it is to be installed for unattended service, in an office building lobby for example, it may be equipped with a lock switch, for which charge account patrons in the building will be supplied with keys. In the case of the unattended installation in a public place, a coin slot mechanism may be employed.

Figure 3 illustrates an automatic Telefax recorder employed in the Telecar delivery service

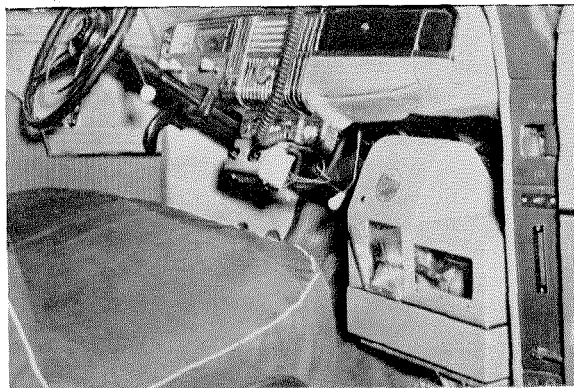

Figure 3—Telefax recorder for mobile delivery of telegrams.

previously referred to. This recorder, which is controlled by radio from the central office, employs a roll of Teledeltos from which a length sufficient for one message is automatically formed into a cylinder and scanned internally, then cut from the roll and ejected from the front of the recorder. The process is automatic and while the operator of the car is delivering one telegram, another is being recorded and deposited into the convenient receptacle just under the dash of the car. Radio and control equipment is located in the trunk of the car.

## 2. Radical Changes in Design Necessary to Lower Equipment Cost

When the patron's transmitter-recorder shown in Figure 1 was developed, it was expected that it would answer the service requirements of a large majority of small businesses. The results of the limited installations that have been in service throughout the war years have been highly satisfactory. However, post-war economic conditions have made it necessary to develop a simpler and cheaper machine to serve a larger portion of the telegraph company's patrons, particularly those in the "small-business" category, and thus make possible nationwide expansion of patron Telefax service.

To undertake such a development, it was necessary to think along radically different lines than heretofore. Conventional methods of scanning, line-feed, etc., had to be discarded. The simplest means of facsimile recording is that wherein the facsimile signals are applied directly to a stylus riding continuously on the surface of an electrosensitive record sheet. Since Teledeltos was already available for this purpose, this method of recording was retained for the new model transceiver. Now, it was reasoned, if some form of conductive pickup could be employed, this same stylus could be utilized to scan the sending copy and a really simple transceiver would result. Why not use conductive pickup? The principle is sound, as old as facsimile itself. True, it will not give good half-tone characteristics, but for message transmission this is not necessary.

What about the preparation of copy? The use of conductive pickup would simply mean furnishing patrons with a different kind of blank than would be provided for use with some other type of transmitter. The problem then resolved itself, for the most part, into the development of a simple, economical, easy-to-use sending blank on which writing and typing would have a different conductivity than the blank itself. Two

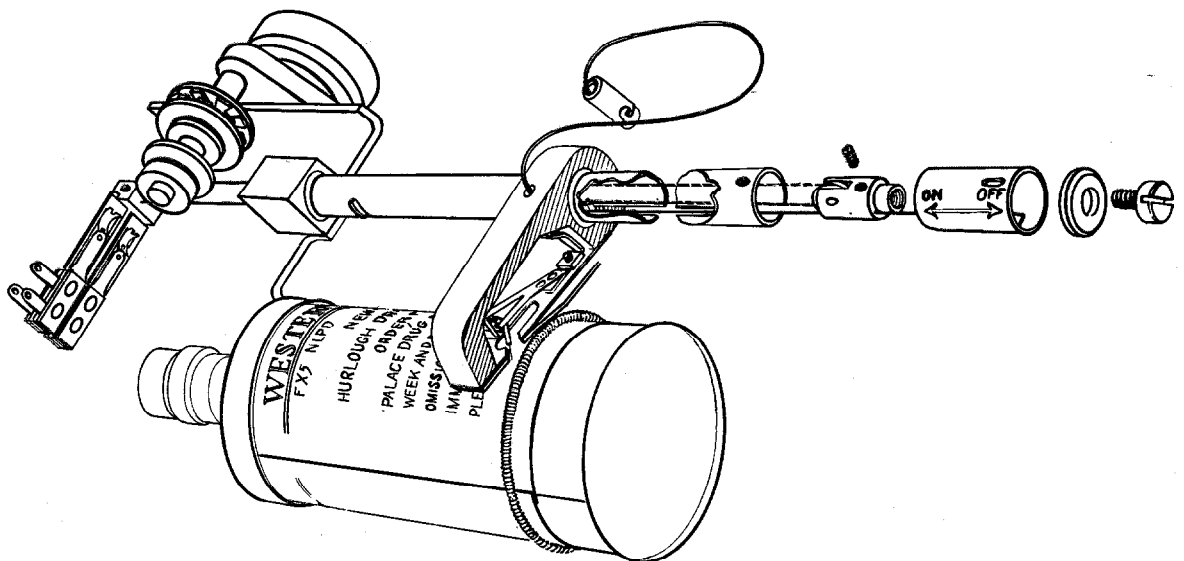

Figure 4—Schematic view of scanning mechanism of Deskfax transceiver.

methods for the preparation of sending copy have been developed. One method employs a sheet of Teledeltos similar to that used for the receiving copy. Over this, is placed a sheet of special carbon paper; writing or typing on the back of this carbon paper transfers the electrically conducting carbon onto the surface of the Teledeltos. The carbon penetrates the thin insulating coating of the Teledeltos, making contact with the conductive base of the paper. A stylus scanning such copy would traverse characters of low resistance, whereas the background of the paper would present an extremely high resistance—practically open circuit.

The second method employs a sheet of black conducting paper, which is the same as that ordinarily coated to form Teledeltos. This method also involves the use of a special "carbon paper." In this case the so-called carbon paper is coated with a white insulating wax so that writing or typing on its reverse side transfers white insulating characters to the black conducting paper. A stylus traversing this copy would encounter characters of very high resistance—practically open circuit, whereas the background of the paper would present a fairly low resistance. Using such a sending blank, it is a simple matter to key or modulate the output of a vacuum tube oscillator. With the aid of a bridge arrangement, it is equally easy to provide for signal conversion so that, with a simple adjustment, a "positive" or a "negative" may be transmitted from either of the two types of subject copy.

### 3. Mechanism of the New Transceiver

The simplest scanning mechanism for a facsimile machine consists of a drum on which the original copy or recording sheet is mounted, and which rotates at constant speed while the scanning point or stylus moves at a uniform rate along the length of the drum. Of course, the same relative motion could be secured by causing the drum to move along its axis as it rotates, with the scanning point remaining fixed in space, but the former method is usually employed. Conventionally, this relative motion or line feed is secured by means of a feed-screw and half-nut, but in the new transceiver, shown schematically in Figure 4, it is accomplished by winding a cord on a drum or reel powered by a small clock

motor. The reel is frictionally coupled to the motor shaft so that the stylus housing may be manually returned to the start position after the completion of each transmission. A slotted tubular track is provided to support and guide the

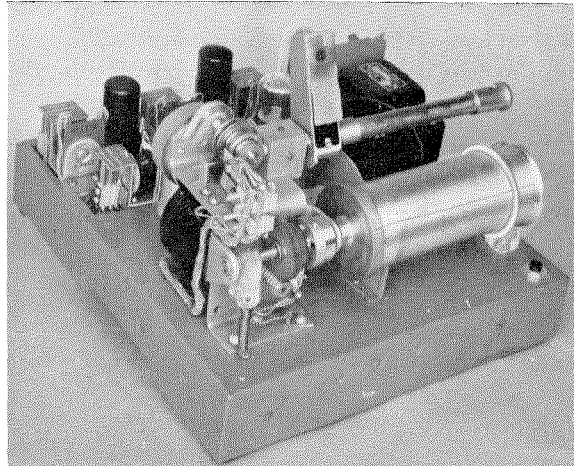

Figure 5—Deskfax transceiver with cover removed.

stylus housing, with the slot fashioned in such a manner as to cause the stylus housing to be raised from the drum in the start position, to facilitate loading. The cord, which is attached to the stylus housing at the pin projecting through the slot in the tube, passes over the pulley at the right end of the tube then back again through the tube to the reel on the motor shaft at the left of the machine. The motor causes the stylus housing to feed to the right and it is returned manually by pushing it towards the left at the end of transmission. The pin riding up the incline in the tube slot at the extreme left lifts the stylus housing to a vertical position. The stylus holder is a replaceable unit to facilitate renewal, and the stylus itself is pivoted so that when the housing is in an upright position the stylus is completely withdrawn into it. Pivoting the stylus also prevents damage to this vital part of the mechanism, if the patron should improperly remove a blank from the drum without first returning the housing to the start (upright) position.

### 4. Deskfax<sup>1</sup>

Figure 5 is a close-up of the mechanism of the new transceiver. The copy or record sheet is

held on the drum by the flange at its left end and by a toroidal spring, which is rolled onto it from the right end. A small synchronous motor mounted on the rear of an L-shaped bracket drives the drum through a single set of gears, and a simple fabric brake on the drum shaft takes up any back-lash. On the drum shaft, is a commutator, which is used for phasing. Above the drum motor, on top of the bracket, is the small clock motor with frictionally coupled reel, which causes the stylus housing to move out along the tube parallel to the drum. At the extreme right end of this tube is a sleeve, which is connected by means of a rod extending through the tube back to a "start-stop" switch mounted on top of the bracket. This sleeve, which is operated manually to the left to start the transceiver, will be moved to the right or "off" position by the motion of the stylus housing as it completes the scanning of the message blank.

The controls of this transceiver are simpler than those of the larger machine of Figure 1. Both machines employ a start-stop switch which also serves as an end-of-message switch, but this newer transceiver does not have a send-receive switch nor a control to regulate the density of the recorded copy. In this transceiver, operation of the start switch automatically sets up the machine as a transmitter unless a call has been placed at the central office causing the buzzer to operate in the patron's machine. Under these conditions, operation of the start switch automatically sets up the transceiver as a recorder.

Since the circuits from these transceivers may terminate in large concentrators at the central office, the use of number sheets there would be extremely cumbersome. Provision is therefore made for the patron to acknowledge individually the receipt of each telegram. This is accomplished by means of a push-button that he operates, after a small neon lamp and buzzer on his machine have indicated that the transmission to him is complete.

The mechanism is assembled from simple stamped and bent sheet-metal parts and die castings wherever possible, with a minimum of machined parts, most of which are of the screw-machine variety. The drums and stylus-feed motors, gears, start-stop switch, and stylus connector are inexpensive commercial items. There

are no close tolerances and the stylus construction is such that considerable eccentricity of the drum may be tolerated. The entire mechanism mounts on the L-shaped bracket and may be assembled or disassembled in a very few minutes with no special tools. There are few adjustments, none critical.

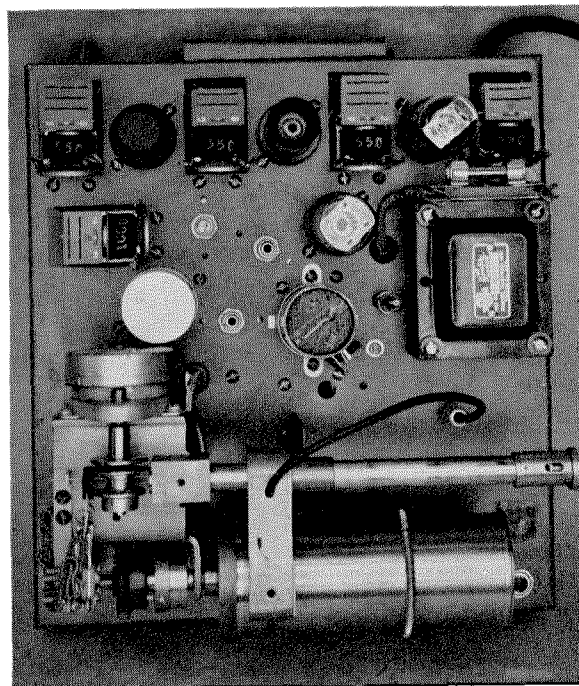

Figure 6—Top view of Deskfax transceiver showing arrangement of parts.

### 5. *Electronic and Control Circuits—Characteristics*

The mechanism mounts across the front of a sheet-metal chassis, which contains the electronic and control circuits. Wiring of the mechanism terminates on convenient terminal strips on the chassis to facilitate servicing or replacement. Figure 6 shows the complete unit with cover removed, and Figure 7 shows the under side of the chassis with bottom plate removed. Although the chassis measures only  $10\frac{1}{8}$  by  $11\frac{1}{8}$  inches, there is no crowding of parts; relays, vacuum-tube sockets, terminal strips, and other vital components are readily accessible for test or maintenance purposes. The electronic circuits employ four tubes,—a rectifier for power



supply; a dual triode, which serves as oscillator and transmitting amplifier; and a high- $\mu$  pentode and a power output tube, which serve as the recording amplifier. The use of separate tubes for transmitting and recording would appear an extravagance, but such is not the case. By switching tubes from one circuit to the other, one tube at most would be saved, the cost of which is more than outweighed by the simplification of switching and wiring that the use of separate tubes permits.

Controls are provided for transmitting and recording levels and for bridge balancing. These are set for each installation and remain unchanged unless servicing is required. A terminal strip is provided for attaching line wires and ground, another for attaching a rubber-covered power cord so that the desired length of cord for each installation may be provided. With the exception of the oscillator coil, all components of the electronic and control circuits are inex-

ing as an output transformer when transmitting and as an input transformer when recording. Control relays are the inexpensive rugged type employed in juke boxes and pinball machines. No critical adjustments are required. The relays are mounted so that the contacts are accessible for cleaning. Wiring of the unit is comparable to that of a small table-model radio and can be done in economical assembly-line fashion. The over-all dimensions of the transceiver with cover and blank holder are  $11\frac{1}{8}$  by  $11\frac{1}{4}$  by 7 inches high. It weighs about 19 pounds. Maximum power consumption is 100 watts, and no power is consumed when the machine is idle.

The oscillator frequency is about 1900 cycles and since a total band width of 1900 cycles is adequate, the transceiver will operate over an ordinary telephone pair. The two-inch drum rotates at 180 revolutions per minute and the line feed is 125 lines per inch, to match the index of cooperation of the central-office equipment, which employs a larger-size blank. Blank size is  $6\frac{1}{2}$  by  $4\frac{1}{2}$  inches, with a useful message area of  $5\frac{3}{8}$  by 3 inches. This will accommodate about 150 typewritten words and is transmitted in two minutes. No special provisions for synchronization are made, the synchronous driving motor being operated from the same commercial 50- or 60-cycle alternating-current power source employed at the central office. Phasing, signaling, and other necessary control functions operate on a direct-current basis using the physical wires with ground return through a center-tapped primary of the line coupling transformer. Phasing clutches on the central-office transmitters and recorders are controlled by the commutator of the patron's machine.

#### **6. Central-Office Equipment—Circuit Operation**

Circuits from patron's transceivers terminate in Western Union central offices in concentrators, made up in multiples of 50 patron units. Each 50-patron unit is provided with four conventional telegram-size optical transmitters and six conventional-size page-type continuous recorders. The transmitters employ the so-called "color sensitive" photocell and improved electronic circuits, so that messages received by tape printer, page printer, and various other means may be retransmitted by Telefax with equal fidelity.

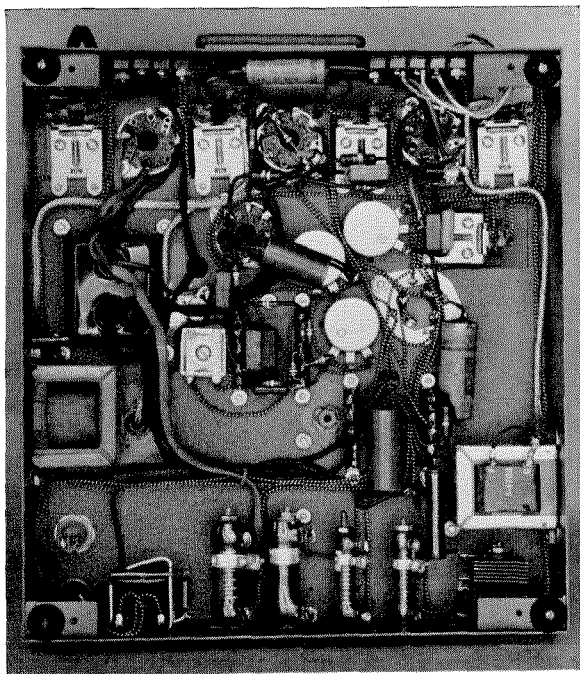

Figure 7—Bottom view of Deskfax transceiver showing accessibility of components.

pensive commercial items. The power transformer is similar to that used in the smallest alternating-current table-model radios. A transformer couples the amplifier to the line pair, serv-

To send a message to a patron, the central-office operator wraps the message about a drum, inserts the drum into a transmitter, and plugs up to that patron's circuit. This removes positive standby potential and applies negative potential to the line over the simplex circuit, which operates a relay in the patron's transceiver causing the buzzer to sound. When the patron answers the call by loading his drum with a Teledeltos recording blank and operating the start switch, the buzzer stops and his transceiver is automatically

set up as a recorder. As soon as the transceiver's tubes heat up, a relay operates to start the stylus-feed motor and to send out phasing pulses (interruption of the direct current over the simplex loop). The central-office transmitter phases immediately and the transmission of the message proceeds. When the message has been transmitted, the transmitter stops and polarity of the battery on the line is reversed, causing the "acknowledge" lamp and buzzer to operate in the patron's transceiver. After the patron has examined the recorded message, he operates the "acknowledge" push-button, which extinguishes the light, stops the buzzer, and opens the simplex loop, giving an acknowledgment indication to the central-office operator. The operator then removes her transmitter from the line.

To send a message to the central office, the patron wraps the copy, prepared as described previously, about the drum and operates the start switch. This sets up the transceiver as a transmitter and operates a relay at the central office, which gives appropriate indication to the operator that a call from that patron is waiting. She connects a recorder to the calling circuit and

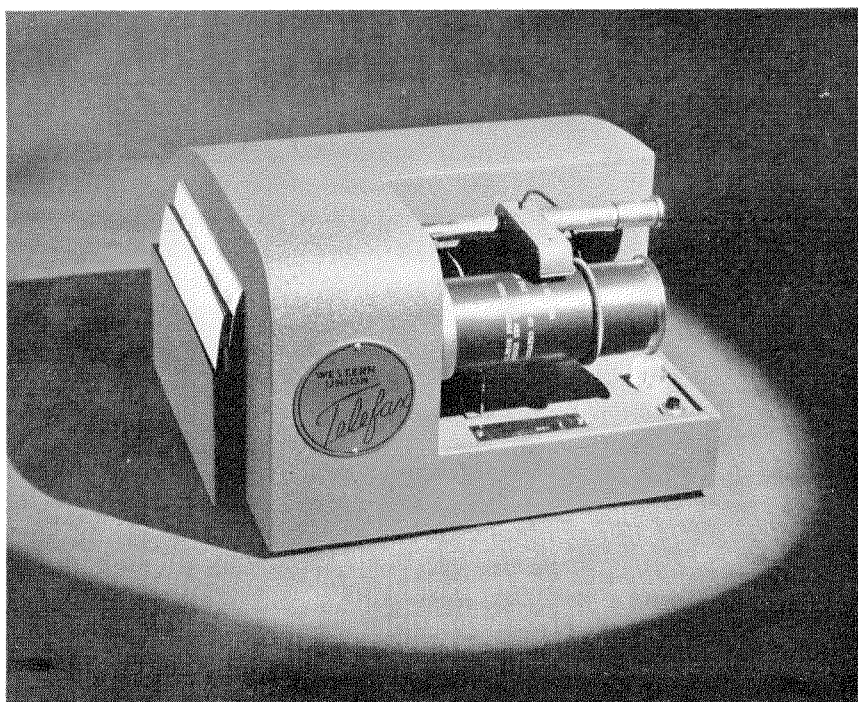

Figure 8—Latest model of Deskfax.

operates a start button. As soon as the heat relay of the transceiver has operated, the recorder phases from the first phasing pulse from the transceiver's commutator. Contacts on the phasing relay reverse the potential on the line, which starts the stylus feed motor at the transceiver. Transmission continues until the transceiver shuts down automatically or until the patron manually operates the "start-stop" switch. The recorder also stops and a light indicates to the operator that the message is complete. She rotates a paper-feed-out knob on the recorder until the conventional telegram blank length of paper is fed out, at which time the light is extinguished. The message is then torn off and the recorder disconnected.

The first concentrators for this service will be of the plug-and-jack manual type, the switching turret resembling the familiar private branch exchange switchboard. Circuits have been worked out for a more automatic concentrator, with automatic line finders on the receiving side and push-button switching on the sending side, should this method of operation be found desirable.

### 7. Patron-to-Patron Transceiver

A machine similar to the Deskfax described above has been developed for patron-to-patron use. That is, two machines work together, directly, without any central-office concentrator equipment. The same mechanism is employed with some rearrangement of the control circuits and a simple phasing circuit whereby one motor drifts into step with the other. Phasing is accomplished without the use of conventional magnets or clutches, employing the commutator on each motor shaft and an added capacitor, which is connected across the recorder driving motor causing it to run slightly under synchronous speed until pulses from the two commutators are in step, at which time the capacitor is removed and both motors run synchronously. Such machines may be used to provide intercommunication for business organizations or for pickup and delivery of telegrams, where only a few patrons are involved and a concentrator is not justified.

Installations of this type have been in operation in one of the eastern cities for the past several months, from which considerable information has been obtained that has been helpful in improving the design. A number of ways were found to simplify and improve the mechanism and reduce the manufacturing costs. The trial installations have so decisively demonstrated the effectiveness of Telefax as a means for pickup and delivery of telegrams that quantity production of transceivers, incorporating all of the improvements resulting from the trials, is now under way. The manufacturing cost of the new unit is expected to be about one-third that of the larger patron's machine shown in Figure 1. Central-office concentrator equipment is being manufactured for installations in six major cities. Although over a million telegrams a year are currently handled by facsimile equipment, the new installations will increase the volume of telegraph traffic handled by facsimile methods many fold and should pave the way for still larger installations in the future, particularly for small-volume telegraph users.

---

### Recent Telecommunication Development

**T**ELEGRAPH SWITCHING IN DENMARK—The December, 1948, issue of *Electrical Communication*, volume 25, number 4, carried on page 421 a Recent Telecommunication Development note on the "Creed No. 47 Tape Teleprinter" in which mention is made that several countries "contemplate" the introduction of nationwide automatic telegraph switching service. Denmark

was included in error as automatic telegraph switching was actually in use throughout that country in 1940. We are pleased to refer readers to an article published in the March and April, 1946, issues of *Journal des Telecommunications*, which contain a comprehensive description of the Danish teleprinter switching network.

# Telephone Plant of Bologna

By F. PEZZOLI

*Fabbrica Apparecchiature per Comunicazioni Elettriche, Milan, Italy*

**T**HE TOWN OF BOLOGNA, which has a population of about 300,000, is the center of the Emilia region of Italy, a very fertile agricultural country. Bologna is the most important market for agricultural products and, due to its geographical position, is also an important junction of roads, railways, and telecommunication networks. Its architecture, typically medieval, is characterised by its porticos and numerous towers.

Before the war, the telephone installation was of the 7-A rotary system and was equipped with 13,000 lines. It was practically a single-office area; only two satellites of minor importance, Galliera and Casalecchio, being connected to the Bologna exchange. These satellites were not provided for local-traffic switching, a connection between two subscribers of the same satellite being handled by the main exchange and occupying two junctions.

In April of 1945, the Casalecchio satellite was destroyed by an aerial bomb. In addition, the automatic equipment and toll board of the main exchange were completely destroyed by the Germans during their retreat. The building was also seriously damaged.

The town was totally without telephone service and to provide for the immediate necessities of the authorities and public, a manual exchange of 1500 lines was installed within a few weeks by the operating company, Telefoni Italia Medio Orientale.

In the summer of 1945, the order for a new automatic telephone plant for Bologna was given to Fabbrica Apparecchiature per Comunicazioni Elettriche.

## 1. *New Automatic Service*

It was decided to use 7-D rotary equipment in the new plant. It was found convenient to decentralize the service by providing some small-capacity exchanges in the town periphery and suburbs. The 7-D system was considered to provide a highly suitable solution to this problem.

Also, the gradual automatization of the entire rural zone of the province of Bologna is foreseen without requiring interworking equipment.

Table 1 lists those exchanges that have been installed.

TABLE 1  
EXCHANGES ALREADY INSTALLED

Exchanges	Subscribers
Galvani (Main Exchange)	14,000
Trento-Trieste	2,000
Pontelungo	600
Galliera	600
Casalecchio	250
S. Lazzaro	150
Total	17,600

No effort was spared by either the manufacturing or operating companies, and the automatic telephone service of Bologna was restored in record time. In October, 1945, the Trento-Trieste exchange was put into service.

During this time, the operating company had completed repairs to the damaged building of the old main exchange (Galvani), the installation of the new office was started, and the first 2000 subscribers' lines were put in service on March 1, 1946. The exchange was gradually extended by groups of 2000 lines until the full order of 14,000 lines was completed. Concurrently, work on the minor exchanges was started, the first of which, Galliera, was put in service at the end of March, 1946. With the cutover of the Pontelungo exchange, the whole installation was completed on January 24, 1948.

In the most important exchanges, all available lines have been connected and negotiations are being completed for the extension of 2000 lines at Galvani, 2000 at Trento-Trieste, and 600 at Galliera.

## 2. *Main Characteristics of Exchanges*

The map of the Bologna network is shown in Figure 1, and it will be seen that, except for the small exchange of S. Lazzaro connected to

Trento-Trieste, all the peripheral exchanges are connected exclusively to the Galvani exchange, which constitutes the network tandem center.

At this time, the small number of lines equipped in the peripheral exchanges make it uneconomical to provide direct connections among them. These may be added in the future when traffic justifies it.

The four major exchanges are situated in the urban district of Bologna, while Casalecchio and S. Lazzaro are located in two nearby suburbs. Connections between those two satellites and the Bologna exchange are taxed at the local tariff rate.

The ultimate planned capacity of the various exchanges is given in Table 2. The further installation of another 10,000-line exchange and many other minor offices is foreseen.

The numbering scheme is on the 5-digit basis. For Galvani, 2 and 3 are assigned as the first

digit; for Trento-Trieste, 4; for Pontelungo, 6; and 5 is allotted to the other minor exchanges.

The main exchanges are of the urban type with combined line finders and finals and with overflow selectors in all selection stages beyond the first.

TABLE 2  
ULTIMATE PLANNED CAPACITY OF EXCHANGES

Exchange	Lines
Galvani	20,000
Trento-Trieste	10,000
Pontelungo	10,000
Galliera	4,000
Casalecchio	1,000
S. Lazzaro	300

For Galliera and Casalecchio, the rural type is used in which the first group selectors are positioned by the registers via marking multiples. The S. Lazzaro office is of the district type.

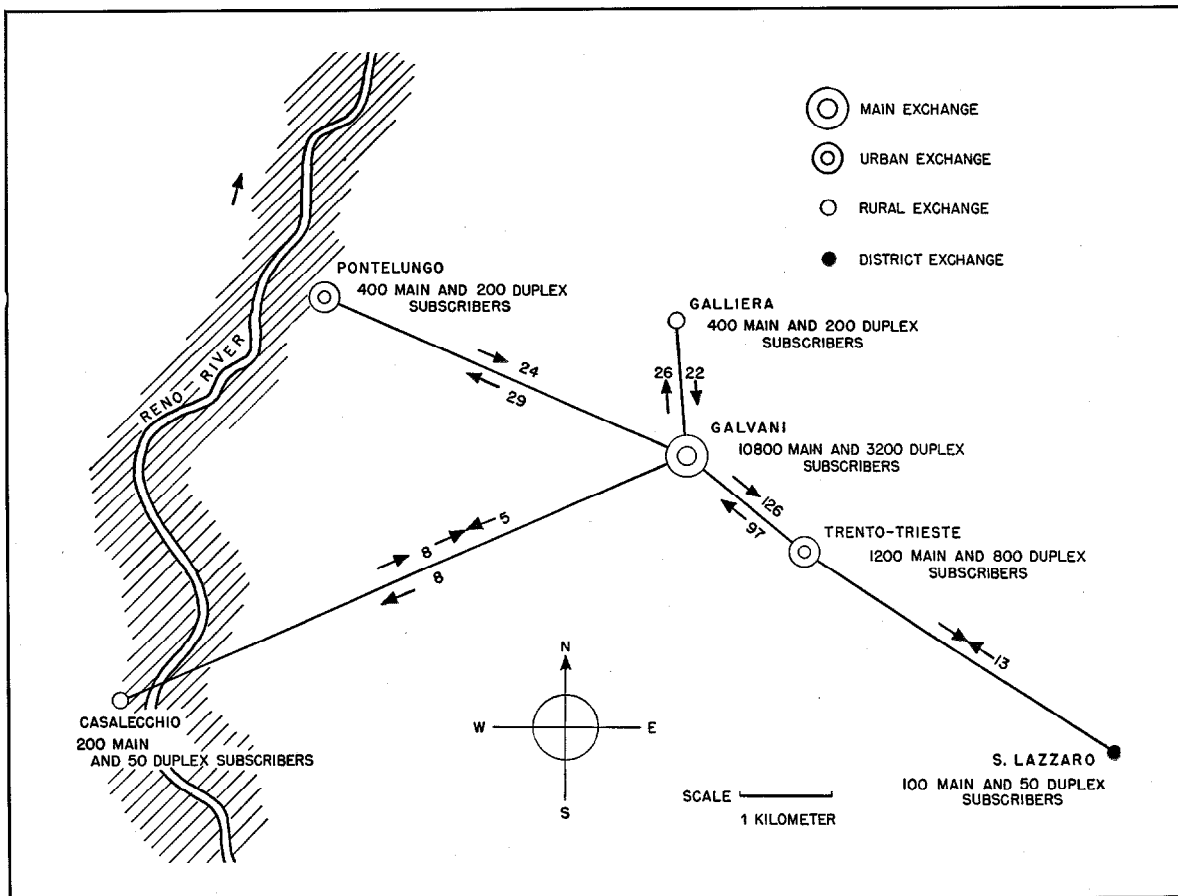

Figure 1—Map of the Bologna local area.

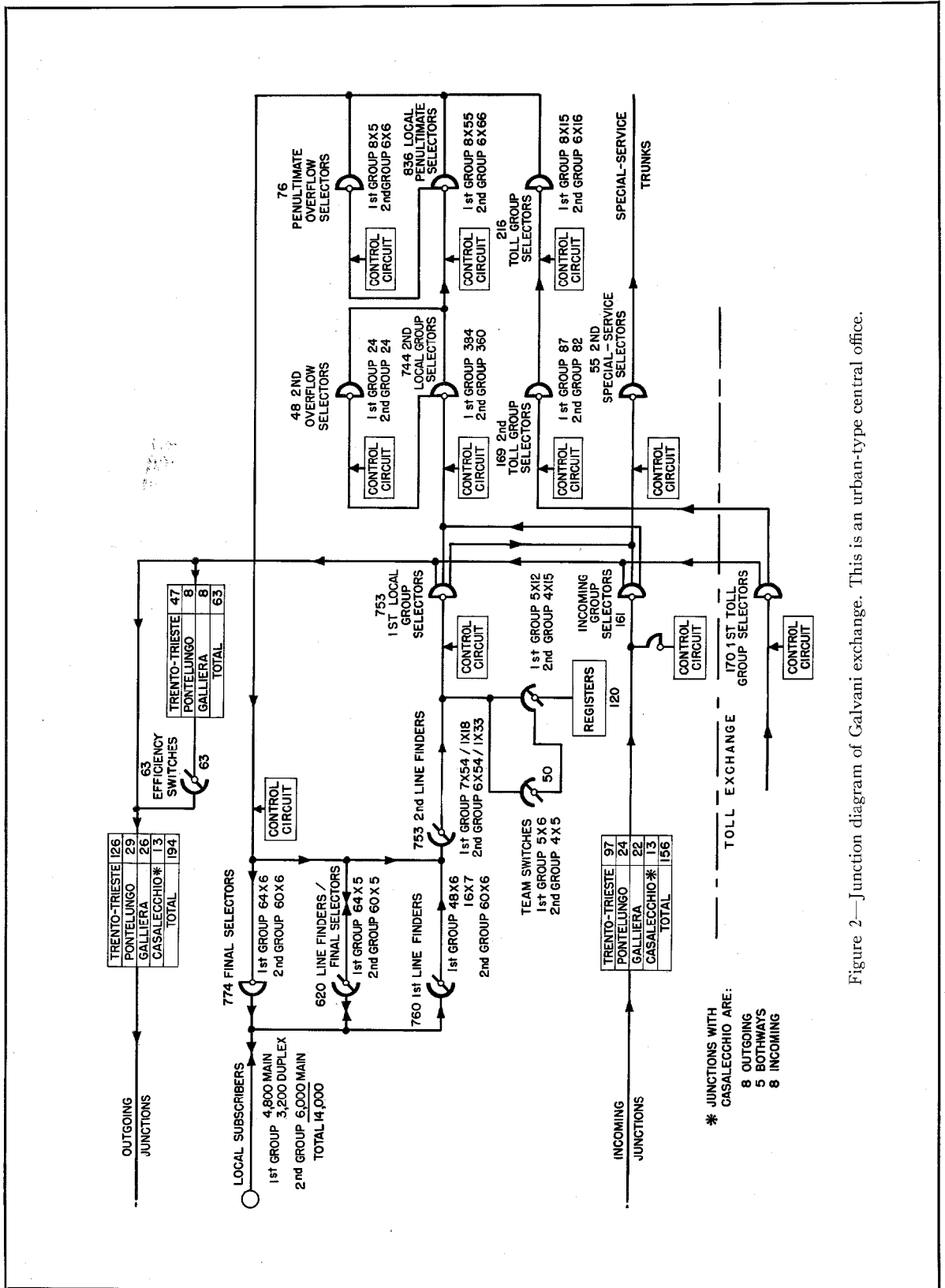

Figure 2—Junction diagram of Galvani exchange. This is an urban-type central office.

As in every exchange in service in Italy, a portion of the subscribers are connected to two-party lines with private service and individual metering, but without revertive calling. Privacy is obtained by a relay located at the junction point of the lines. This arrangement, called "duplex," is used extensively for residential service.

Figure 2 shows the junction diagram of the Galvani exchange. Due to the large capacity of this exchange, a stage of second group selectors is introduced between the first group selectors and the penultimate selectors. The exchange comprises two groups of 10,000 lines, each group having its own registers, alarms, etc. The traffic per line in the two groups is not equal; in the first group, 40 percent of the subscribers are duplex, while in the second group, all lines are main lines. The first group consists of 8000 subscribers and the second of 6000, but as the average traffic of a duplex subscriber is considered to be about half that of a normal subscriber, it may be assumed that the total traffic in each group is approximately equal.

The junctions to the other exchanges, the two groups of second local selectors, and the special-service selectors are connected to the arcs of the first group selectors.

The junction diagram shows that the overflow selectors, besides being normally connected to the penultimate selector stage, are also associated with the second group selector stage. The reduction of equipment obtained by adding the overflow selectors to the second group selector stages is small. However, the elimination of the overflow facility, by simplifying the first group selector circuits and associated control circuits, would have brought about a more substantial economy. Owing to the urgency of putting the first thousand subscribers into service, it was necessary to use for the first group selectors and associated controls the normal circuits including overflow facilities. The second group selectors were introduced only after the cutover of the first 8000 subscribers and, therefore, the first group selectors were initially connected directly to the penultimate selectors, for which the overflow facility existed.

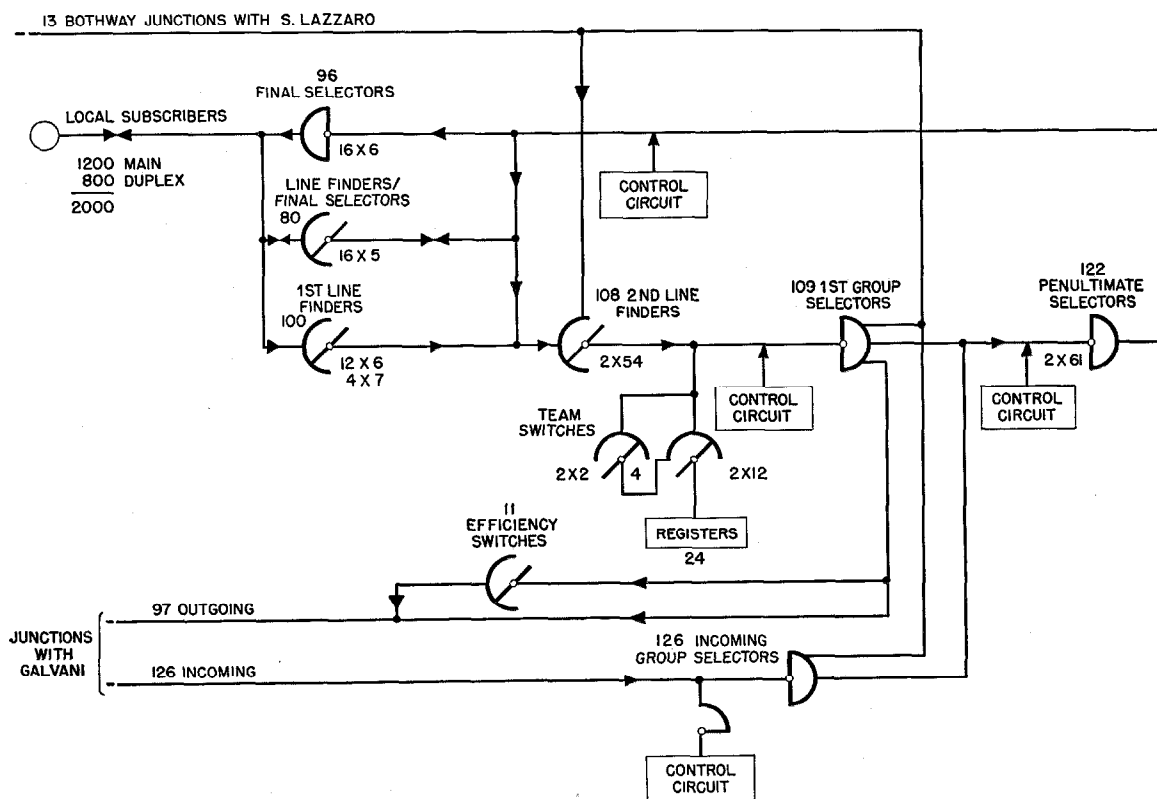

Figure 3—Trento-Trieste junction diagram, a center-type exchange.

To improve the utilization of the outgoing junctions, efficiency switches have been introduced for all directions, except for that of Casalecchio.

The duplex subscriber lines appear on the first line finder and final arcs on one point for each subscriber pair. For this reason, it was necessary to invert the two-line wires on the penultimate selector arcs instead of on the final arcs. The directory numbers of the two duplex subscribers differ in the hundreds digit. For calls originating in duplex lines, the switching of the meter is done by a relay. Toll-preference facility is provided in the Bologna toll connections (forced break-

down of the local connection 4 seconds after warning tone) and for this reason the toll traffic passes through separate second group and penultimate selectors for the Galvani exchange, which is located in the same building as the toll exchange.

In the peripheral exchanges, as the toll traffic and local traffic pass over a common group of junctions, the selectors are common for the toll and local traffic and receive a signal for applying the toll criterium by a supplementary selection between the tens and the units.

Figure 3 represents the junction diagram of the Trento-Trieste exchange. As the present

equipment is for only 2000 subscribers, the overflow selectors are not yet equipped but their introduction is, however, foreseen. The diagram of the Pontelungo exchange is similar, but covers a smaller installation. In this latter exchange, the efficiency switches for the outgoing junctions are not yet installed.

Figure 4 represents the junction diagram of the rural-type exchange of Galliera. The penultimate group selectors are not equipped at present; however, they will be installed as soon as the exchange equipment exceeds 1000 lines. The diagram of Casalecchio is similar, but because of the smaller size of this exchange, the second line finders are not provided; their later introduction is foreseen. Figure 5 represents the junction diagram of the S. Lazzaro type of district exchange.

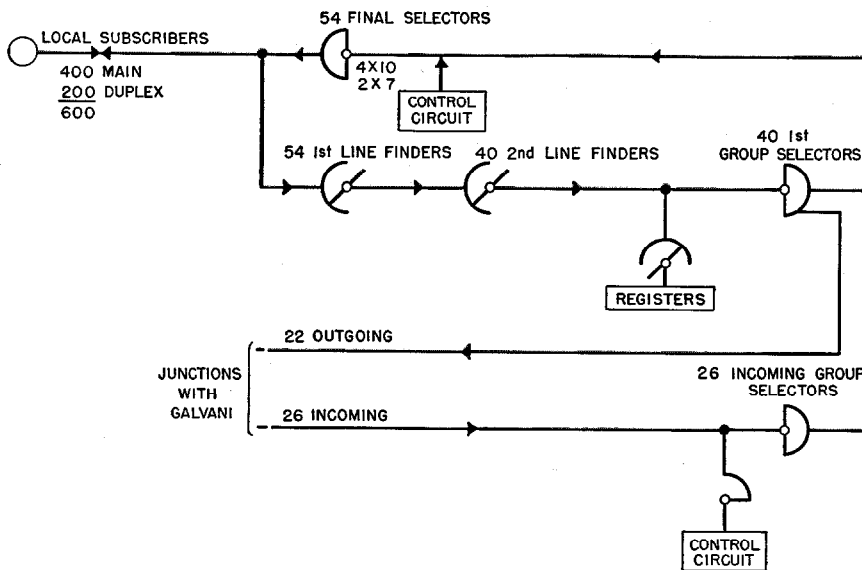

Figure 4—Rural-type exchange junction diagram for Galliera office.

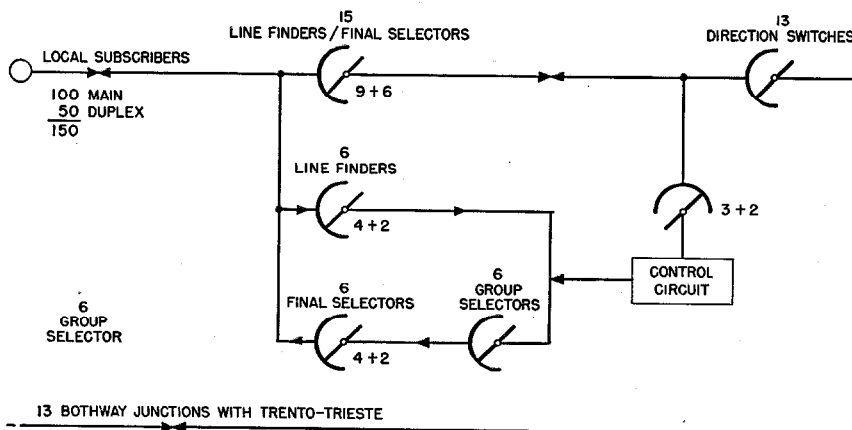
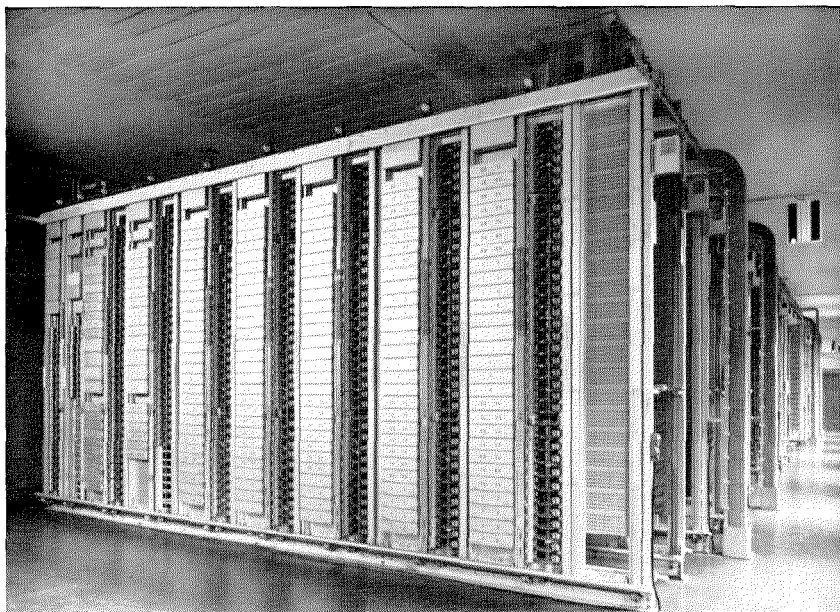

Figure 5—District-type exchange of S. Lazzaro.



In all these exchanges, manual routine test circuits are supplied; the introduction of automatic routine test circuits for the main exchange of Galvani is anticipated.

In each group, a specially arranged final selector circuit is provided for the testing of external lines in addition to its normal functions. Wire-chief desks or turrets are installed in every exchange. Alternatively, the three-position wire-chief's desk of the Galvani exchange tests all lines of the network.



Galvani exchange showing local-line-circuit, line-finder, and final-selector bays. Penultimate and overflow selector bays are at the left.

### 3. Automatization of Bologna Province

The operating company intends to proceed gradually with the automatization of the province of Bologna, which includes some 100 small exchanges with total equipment for about 3000 subscribers.

Local tariff will be applied to places within approximately 10 kilometers of Bologna and comparable zones have been set up for the rest of the province. Connections between different zones will be metered on a time-and-zone basis.

A closed 5-digit numbering system for the province and Bologna is foreseen. The first digits allotted for the province are 8 and 9.

The majority of the junctions with Bologna must be of the 50-cycle signaling type. At present, the exchanges for Persiceto, Minerbio, and Baricella have been ordered and those of Castel S. Pietro and Crevalcore are on order. Persiceto is already in service, but at present only the traffic to Bologna is automatic; the traffic from Bologna passes via the toll board. These rural

exchanges are all of the 7-D district type. Those with initial equipment of 10 or 20 subscribers will be relay-type satellites.

### 4. Toll Service

The toll service is actually handled by an emergency 40-position toll exchange installed by the operating company, mostly with recovered material. At present, the installation of a modern 28-position cordless exchange for the operating company's lines is imminent, and negotiations are in hand for an additional 32-position board of the same type for the government's lines.

With the new exchange, all of the operating company's toll lines and part of the government's toll lines will be handled by operator-to-subscriber dialing. It is planned to convert gradually all of the operating company's toll lines for subscriber-to-subscriber long-distance dialing. This is already being studied for the Bologna, Ferrara, Modena, Reggio Emilia, and Parma exchanges.

# Travelling-Wave Amplifier for 6 to 8 Centimetres

By D. C. ROGERS

*Standard Telephones and Cables, Limited, Ilminster, England*

**T**RAVELLING-WAVE AMPLIFIER TUBES for use between 6 and 8 centimetres (3750 to 5000 megacycles per second) were developed for non-attended repeater-amplifier radio communication links. Limitations of the early types of tubes are indicated, and mechanical details and electrical performance of an improved design are given. A gain of 25 decibels over a band of 1400 megacycles was obtained with an output power of 140 milliwatts. A noise-factor of 18 decibels indicates the desirability of limiting bandwidth where possible to reduce noise output.

. . .

Since Kompfner first described an amplifier using the travelling-wave principle,<sup>1</sup> a number of papers have presented various treatments of the theory of these amplifiers,<sup>2-5</sup> but very few experimental results have been made known. This paper is an attempt to fill this gap; it outlines the course of development that led to the design of an amplifier suitable for commercial use. The development was undertaken to study the suitability of the travelling-wave tube as a repeater-amplifier in a microwave communication link, and for this reason most of the work has been carried out in the 6-to-8-centimetre wavelength range, which embraces both the 3900-to-4200- and 4400-to-5000-megacycle-per-second bands allocated for this purpose. However, since work was commenced before these frequency allocations became known, some of the

early experiments were made at wavelengths around 10 centimetres, for which suitable equipment was then readily available.

In view of the fact that these tubes may have to operate in remotely situated repeater stations, where frequent maintenance is not possible, considerable importance was attached to the necessity for consistent performance and simplicity of adjustment.

To illustrate the nature of the problems that were encountered, some of the results obtained with early experimental tubes will first be described.

## 1. Early Experiments

The first tubes made were very similar to those described by Pierce<sup>2</sup> and were constructed as shown in Figure 1 and in the photograph of Figure 2. They were intended for operation at a wavelength of 10 centimetres. The helix was 14 inches long and was wound with 0.0148-inch-diameter nickel-chrome-iron resistance wire on a 0.25-inch-diameter mandrel. The length of the wire itself was 196 inches, so that, on the assumption that the wave travelled along the wire with a velocity close to that of light, the wave velocity along the axis was one-fourteenth of that of light, corresponding to an electron energy of 1300 electron-volts. Highly resistive wire was chosen for the helix to provide a substantial attenuation to a freely propagated wave and thus reduce the likelihood of self-oscillation due to reflexion of a wave from output to input of the helix. The helix was supported by three glass rods held in mica spacers at intervals along their length.

Coupling to the helix was effected by arranging the end turns to lie across the input and output waveguides with the axis of the helix parallel to the electric vector, the pitch of the helix being increased for the end two or three turns to facilitate matching to the guides. The ends of the wire were welded to metal cylinders, which, in conjunction with brass tubes soldered into the

<sup>1</sup> R. Kompfner, "The Travelling Wave Valve," *Wireless World*, v. 52, pp. 369-372; November, 1946.

<sup>2</sup> J. R. Pierce, "Theory of the Beam-Type Traveling-Wave Tube," *Proceedings of the I.R.E.*, v. 35, pp. 111-123; February, 1947.

<sup>3</sup> R. Kompfner, "Traveling-Wave Tube as Amplifier at Microwaves," *Proceedings of the I.R.E.*, v. 35, pp. 124-127; February, 1947; also *Wireless Engineer*, v. 24, pp. 255-266; September, 1947.

<sup>4</sup> C. Shulman and M. S. Heagy, "Small-Signal Analysis of Traveling-Wave Tube," *RCA Review*, v. 8, pp. 585-611; December, 1947.

<sup>5</sup> J. Bernier, "A Preliminary Theory of the Travelling-Wave Tube," *L'Onde Electrique*, v. 27, pp. 231-241; June, 1947.

waveguides, formed coaxial lines approximately a quarter-wavelength long. These metal cylinders, which also held the ends of the glass support rods, were mounted on mica discs fitted into dimples in the outer glass bulb.

By careful adjustment of the pitch of the end turns, and of the position of the reflecting pistons in the waveguides, a satisfactory match to the guides was obtained.

The electron gun was designed to produce a convergent beam, which was subsequently brought parallel by the action of a magnetic lens located between the gun and the input waveguide. Spread of the beam along the length of the helix, due to space-charge repulsion, was prevented by means of a solenoid extending between the two waveguides. A collector electrode was provided at the remote end of the helix for the measurement of the current traversing the length of the tube. With this system, it was possible by careful adjustment of the focusing currents and alignment of the coils to cause up to 60 per cent of the cathode current to reach the collector, currents of up to 5 milliamperes being available at the collector.

The results obtained with these tubes at high frequency were disappointing; they exhibited a strong tendency to burst into self-oscillation, even when operated at very small beam currents and despite the helix attenuation of 25 decibels being considerably in excess of the forward gain. On some occasions, in fact, oscillations were observed when the forward gain was less than unity. Nevertheless, it was possible to obtain a useful gain of up to 20 decibels, but only after a

series of critical adjustments to the focusing system and beam velocity. It was observed that maximum gain corresponded to a very small percentage of the available current reaching the collector, perhaps as little as 1 out of 10 milliamperes leaving the cathode. It was also noticed that the gain was quite markedly dependent on frequency, increasing as the frequency was reduced.

As a result of these experiments, it became clear that development should take place along the following lines:

- A. Means had to be found for preventing spurious oscillation.
- B. The helix geometry had to be modified so that the gain was, as far as possible, independent of frequency over a wide band.
- C. Some improvement to the electron-optical system had to be made, such that no critical adjustments were necessary when setting up the tube. To facilitate setting up, it was desirable that maximum amplification should occur when the focusing system was adjusted to give a maximum percentage of beam current at the collector.

It was also realised that if these tubes were to be produced in any quantity, the mechanical construction would have to be changed to give a more rigid assembly and to permit maximum use of the normal techniques of valve manufacture.

## 2. *Suppression of Spurious Oscillation*

In the course of experiments with different methods of construction, it was observed that the tendency to oscillate was to some extent influenced by the diameter of the outer glass bulb

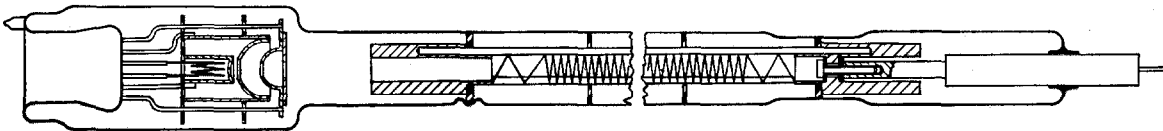

Figure 1—Constructional details of an early type of travelling-wave tube for operation at 10 centimetres.

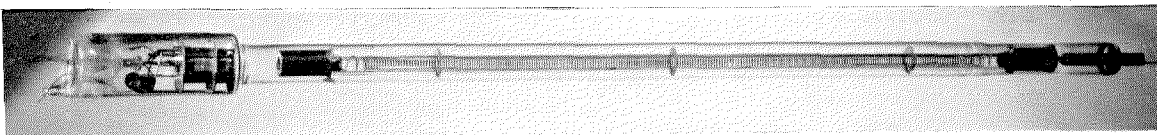

Figure 2—Travelling-wave tube for 10-centimetre work. Length approximates 24 inches.

of the tube. In general, the tendency to oscillate increased as the diameter of the bulb was made smaller, and the glass was closer to the helix. This suggested the possibility that the mechanism of oscillation might lie in some mode of propagation having an appreciable field component external to the helix. At about this time, Dewey and Smullin,<sup>6</sup> pointed out that theory also indicated the existence of such a mode, propagating at about the velocity of light, and suggested the use of a lossy material outside the helix to damp out this wave. Accordingly, a coating of graphite was applied to the inner surface of the glass envelope, the coating extending along most of the length of the helix. This resulted in a definite improvement in stability, whilst the effect on the propagation of the slow wave in the helix was negligible, the attenuation being increased by only one or two decibels.

It was still possible, however, to obtain oscillation when the net forward gain was less than the helix attenuation. This was attributed to the fact that, as already mentioned, the gain in the helix was rising with increasing wavelength, and might rise to values higher than the helix attenuation at wavelengths beyond the range over which the helix was matched to the waveguides. Some confirmation of this existed in the fact that the wavelength of the oscillations was greater than 10 centimetres—usually 15 to 20 centimetres. When the helix geometry was amended to bring the operating frequency to the peak of the gain-versus-frequency curve, as will be described in the next section, it became possible with good matching to the waveguides to obtain gain figures 10 decibels or more in excess of the helix attenuation. In general, however, it was not found satisfactory to operate a tube with a greater gain than the helix attenuation, since it is then sensitive to changes in matching and may oscillate with maladjustment of the input or output circuits. To achieve a useful gain of 25 decibels, therefore, the helix attenuation should be in excess of, say, 35 decibels. Using the highest-resistivity materials available, this may still require a prohibitively long helix. An alternative scheme is to provide a localised highly attenuating region near the centre of the helix,

<sup>6</sup> G. C. Dewey and L. D. Smullin, Federal Telecommunication Laboratories, Incorporated, Nutley, New Jersey. Unpublished Memorandum.

thus effectively dividing the helix into two portions and making the propagation of energy from the output to the input impossible. A satisfactory method of obtaining this high attenuation was to coat the helix support rods with graphite, the graphite being in contact with the turns of the helix. By this means, an attenuation as high as 40 decibels at 7 centimetres could be obtained over a 1-inch length of helix. Gain figures of up to 30 decibels could then be obtained without trouble from spurious oscillation, even in the presence of a serious mismatch at the ends of the helix.

This highly attenuating region results, of course, in the need for a higher current to obtain the same overall gain. The effect is not very serious; in most cases the introduction of a region of localised attenuation has resulted in a reduction in overall gain of some 6 to 8 decibels, the beam current and other factors being held constant.

### 3. Geometry of Helix

The fact that maximum gain was obtained in early tubes when only very little of the beam current reached the collector was interpreted as indicating that the high-frequency field at the axis of the helix was very weak compared with that near the helix wire. To verify this, tubes were made in which the internal diameter of the helix was decreased from 0.25 to 0.19 inch; the velocity of the wave increased from one fourteenth to one thirteenth that of light. This resulted in a very considerable increase in the gain obtainable with the focusing system adjusted for maximum collector current, and only a relatively small increase in gain could be obtained by deliberate misadjustment.

There was still a serious variation in gain with wavelength, however; typical gain figures for a collector current of 2 milliamperes are given in Table 1. The helix length in this case was 11 inches.

TABLE 1

Wavelength in Centimetres	Gain in Decibels
9.0	17
10.0	22
11.0	25

The theoretical gain of a travelling-wave tube at optimum beam velocity is given by Pierce<sup>2</sup> as

$$G = A + BCN, \text{ decibels,} \quad (1)$$

where  $A = -9.54$  decibels for a lossless helix,  
 $B = 47.3$  decibels for a lossless helix,  
 $C =$  a gain parameter (see below),  
 $N =$  number of cycles required for an electron to traverse the helix in the absence of a wave.

For values of attenuation and gain used in practice  $A$  and  $B$  become approximately  $-12.5$  and  $39.0$  decibels respectively. The problem of obtaining a flat response-frequency curve is therefore that of maintaining the product  $CN$  substantially constant over the waveband.

$$\text{Now} \quad C = \left( \frac{E^2 I}{\beta^2 P 8V} \right)^{\frac{1}{3}}, \quad (2)$$

where  $E =$  high-frequency field on axis of helix,  
 $P =$  power passing along the helix,  
 $I =$  direct beam current,  
 $V =$  beam voltage,  
 $\beta = \frac{2\pi f}{u_0}$ ,  
 $f =$  operating frequency,  
 $u_0 =$  average beam velocity.

If the electron velocity is close to the velocity of the wave on the helix, and the helix is  $l$  centimetres long,

$$CN \approx \frac{\beta l}{2\pi} \left( \frac{E^2 I}{\beta^2 P 8V} \right)^{\frac{1}{3}}. \quad (3)$$

For  $\left( \frac{E^2}{\beta^2 P} \right)^{\frac{1}{3}}$ , Pierce obtains

$$\left( \frac{\beta}{\beta_0} \right)^{1/3} \left( \frac{\gamma}{\beta} \right)^{4/3} F(\gamma a), \quad (4)$$

where  $\beta_0 = \frac{2\pi f}{c}$ ,

$c =$  velocity of light,  
 $\gamma^2 = \beta^2 - \beta_0^2$ ,  
 $a =$  radius of helix,

and  $F(\gamma a)$  is a function plotted in Pierce's paper and reproduced here in Figure 3.

Now for velocities less than  $c/10$ ,  $\gamma$  is very closely equal to  $\beta$ , i.e. to  $2\pi f/u_0$ , and we may write

$$CN \approx \left( \frac{I}{8V} \right)^{\frac{1}{3}} \frac{\gamma l}{2\pi} \left( \frac{c}{u_0} \right)^{\frac{1}{3}} F(\gamma a). \quad (5)$$

In the region where the helix is substantially non-dispersive,  $V$  is independent of  $f$ , and differentiating with respect to  $f$ , we obtain the condition for gain independent of frequency,

$$F(\gamma a) + \gamma a F'(\gamma a) = 0 \quad (6)$$

and  $-\gamma a F'(\gamma a)$  is also plotted in Figure 3, from which it will be seen that (6) is fulfilled when  $\gamma a = 1.5$ .

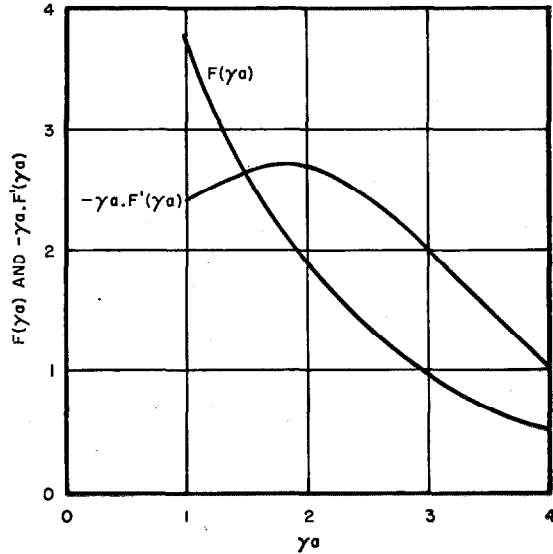

Figure 3—The functions  $F(\gamma a)$  and  $-\gamma a \cdot F'(\gamma a)$ .

The value of  $\gamma a$  for the helix with an internal diameter of 0.19 inch was 2.2 at 10 centimetres. A further reduction to 0.125 inch, decreasing the pitch to keep the velocity ratio constant, yielded a flat frequency response; the gain remained constant to within  $\pm 1.0$  decibel from 9.0 to 12.0 centimetres, the greatest range over which gain could then be measured. With this helix diameter, maximum gain was always obtained with the focusing system adjusted for maximum collector current.

Tubes were next made for the 6-to-8-centimetre waveband, using an internal diameter of 0.09 inch ( $\gamma a = 1.5$  at 7.2 centimetres); the length of the helix was 7 inches. The measured gain-versus-frequency characteristic of a typical tube of this type is shown in Figure 4, from which it will be seen that the gain remains constant to within  $\pm 1.5$  decibels from 6.0 to 8.3 centimetres, a total bandwidth of 1400 megacycles. The rapid

drop in gain at wavelengths longer than 8.3 centimetres is in part due to the fact that the helix becomes dispersive—i.e., the phase velocity of the wave increases with wavelength. The opti-

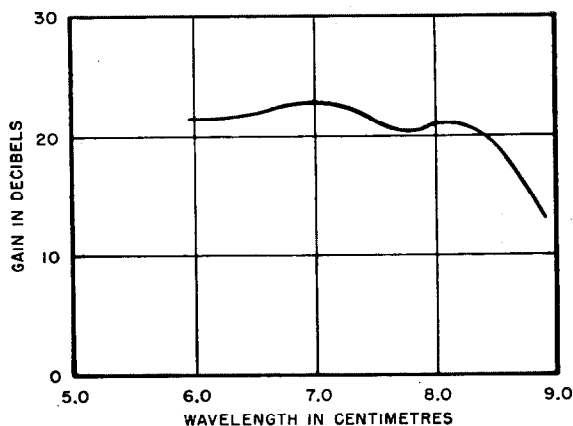

Figure 4—Gain plotted against frequency for a tube designed for the 6-to-8-centimetre range.

imum helix voltage at these wavelengths is therefore higher than that at the shorter wavelengths. For example, on increasing the helix voltage to 1460 from the value of 1350 used in obtaining Figure 4, the gain at 8.8 centimetres increased from 14.0 to 18.5 decibels. A further contributing factor to the drop in gain at long wavelengths is the deterioration of the matching of the helix to the waveguide.

The use of a small helix diameter considerably increases the difficulties of focusing, and it becomes necessary to use a large wire diameter to avoid overheating difficulties. Clearly the maximum possible wire diameter is such that there is no spacing between the turns, and at diameters approaching this the factor  $E^2/\beta^2P$  will tend to zero, as the high-frequency field will then be concentrated between the turns, where there is no beam. An experimental investigation showed that the wire diameter had little influence on the gain, provided that it did not greatly exceed 50 percent of the pitch. Beyond 60 percent of the pitch, a rapid drop in gain was experienced.

It is of interest to make a comparison between the measured and calculated values of gain; for this purpose we will choose a tube in which the dimensions are as follows:

Mean radius of helix = 0.131 centimetre,  
 Length of helix = 17.8 centimetres,  
 Length of wire in helix = 231 centimetres.

This tube had a cold attenuation of 18 decibels, and gave a gain of 20 decibels at 7 centimetres, using a beam current of 1.5 milliamperes at 1400 volts.

Referring to Pierce's paper, we find that

$$\left(\frac{E^2}{\beta^2P}\right)^{\frac{1}{2}} = 6.23,$$

whence  $C = 0.032$ ,

$$CN = 1.09.$$

From this value of  $CN$  and the cold attenuation  $R$ , we find from Pierce's theory  $A = -11$  and  $B = 42$ , so that the gain  $A + BCN = 35$  decibels. The measured gain thus falls appreciably short of the calculated figure. The main reason for this is thought to be that Pierce's equation for  $E^2/\beta^2P$  gives an optimistic figure; this has already been found by Cutler<sup>7</sup> in an experimental investigation of the field within the helix.

#### 4. Electron-Optical System

The critical nature of the focusing system was believed to be largely due to the region of non-uniform magnetic field in the neighbourhood of the input waveguide, i.e. between the first waveguide and the long solenoid. It was decided that the most satisfactory method of obtaining a system that would be free from critical adjustments, and, therefore, could be operated reliably for long periods without carefully stabilised supplies, would be to maintain a uniform field along the entire length of the beam. Accordingly, the waveguide and focus-coil assembly shown in Figure 5 was built. The uniform field was obtained by means of three coils disposed relative to the waveguides as shown in the figure. The field irregularity in the region of the waveguides was kept small by the use of an adequately large ratio of the mean diameter of coil to the thickness of the waveguide; a ratio of about four was found to be satisfactory.

The electron gun was modified to give an initially parallel electron beam, the cathode

<sup>7</sup> C. C. Cutler, "Experimental Determination of Helical-Wave Properties," *Proceedings of the I.R.E.*, v. 36, pp. 230-233; February, 1948.

being made somewhat smaller than the internal diameter of the helix. Apart from the cathode, the gun comprised a focusing electrode, internally connected to the cathode, and two anodes, the first being used to control the beam current and the second, internally connected to the helix, to control the beam velocity. The beam current could be controlled from very small values up to the maximum with very little defocusing of the beam. With a helix having an internal diameter of 0.09 inch, a current of 4 milliamperes could be obtained at the collector, representing some 60 to 70 percent of the total cathode current.

The performance of tubes using this focusing arrangement is almost independent of the current flowing in the focus coils, provided this is kept above a certain minimum value and, hence, the only two adjustments that need to be made, other than waveguide circuit adjustments, are the beam current and voltage.

It might be argued that the use of an electron beam that is parallel along the whole length of the tube places an unnecessary restriction on the size of the cathode and hence entails operation of the cathode at a higher current density than if a gun giving a convergent beam were used, particularly when the helix diameter is small. This is, of course, true, but the current densities needed so far have not been high enough to justify relinquishing the advantages obtained with the parallel beam in order to prolong the life of the tube.

A second possible disadvantage of the uniform magnetic field and parallel beam is the increase in bulk and weight of the complete assembly. This may be of importance

in some applications, but it is probably not too serious in a repeater station of a fixed communication link.

### 5. Mechanical Construction

To obtain increased rigidity, the mica washers holding the three glass support rods for the helix were dispensed with and the diameter of the outer tube reduced so that the rods were in contact with it along the whole length of the tube, as shown in Figure 6. This necessitated a close control on the bore of the outer tube; tubing is available commercially, however, with a bore accurate to better than 0.001 inch. The rods engaged at their ends in slots in the quarter-wavelength sleeves to which the extremities of the helix were attached. The design was so arranged that the helix, support rods, and quarter-wave sleeves could be assembled as a unit before insertion into the bulb, thus ensuring the least risk of distortion of the helix during assembly. Direct-current connexion to the helix is made by a metal tube attached to the first quarter-wave

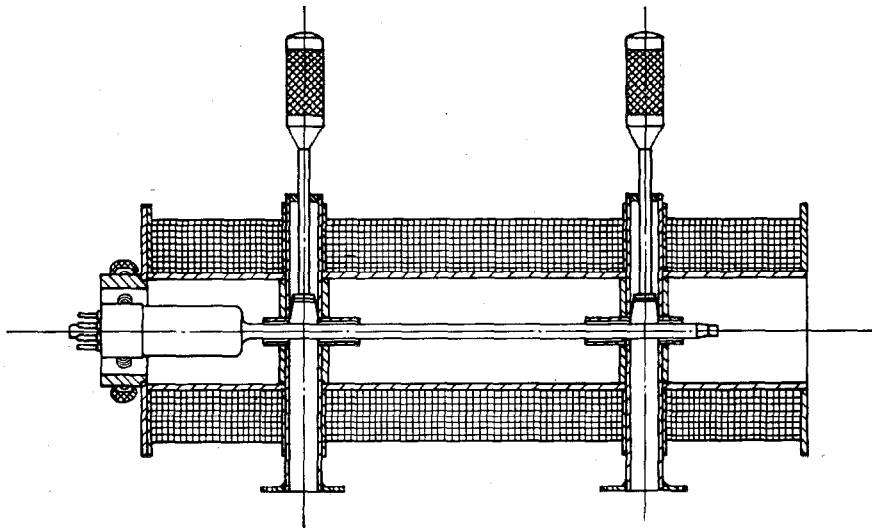

Figure 5—Waveguide and focus-coil assembly with tube in position.

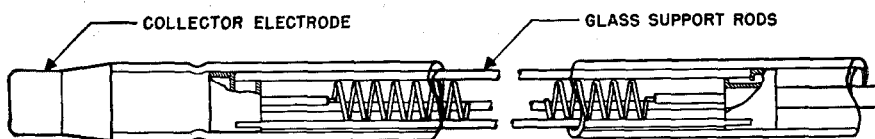

Figure 6—Mounting of the helix in the 6-to-8-centimetre amplifier tube.

sleeve; this tube enters a suitable recess in the second anode of the electron gun and hence, also assures correct alignment of the gun with the helix. All parts of the tube are made by pressing or spinning from thin sheet metal. To avoid distortion of the magnetic field, non-magnetic alloys are used throughout, with the exception of the cathode, which is of nickel; this, of course, becomes non-magnetic at its operating temperature.

Tapering the pitch of the helix at its ends to obtain matching to the waveguides was thought undesirable because of the difficulty of controlling variation between tubes. An experimental investigation showed that this tapering could be

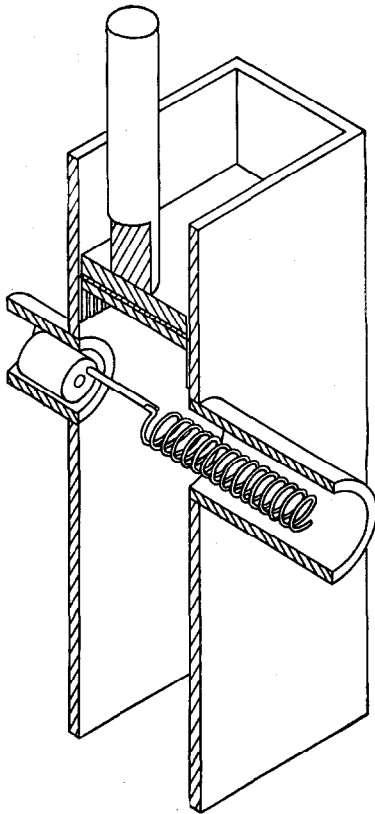

Figure 7—Matching of helix to waveguide.

avoided by the arrangement of Figure 7, in which the helix is welded to a short cylindrical post soldered into the quarter-wave sleeve. By correct choice of the length of the post and sleeve, a standing-wave ratio of less than 2.5 was obtained over the band from 6.0 to 8.0 centimetres; the optimum length of the sleeve was found to be somewhat less than a quarter-wavelength at the centre of the waveband, even when due allowance was made for the dielectric constant of the glass. Figure 8 is representative of the variation in standing-wave ratio obtained over the waveband.

### 6. Performance of Typical Tube

Figure 9 is a photograph of the design finally evolved as a general-purpose amplifier for operation between 6 and 8 centimetres. Figure 10 shows this tube in its focusing coil and waveguide assembly. In this photograph, the assembly is seen mounted on a waveguide switch designed to put the travelling-wave tube in and out of circuit as required. This greatly facilitated measurements of tube performance.

At the optimum helix voltage, nominally 1400, and a collector current of 3.0 milliamperes, an average tube of this type will give a gain of 25 decibels. A high degree of stability of helix voltage is not necessary; variation in helix volt-

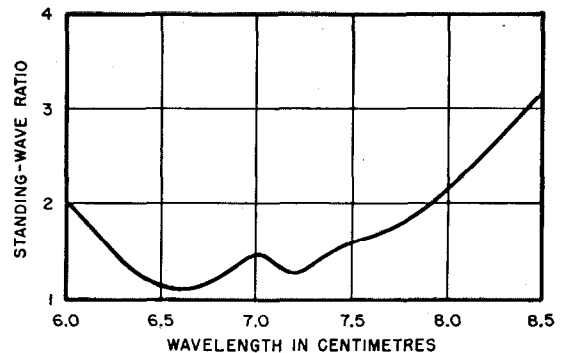

Figure 8—Variation with wavelength of standing-wave ratio in the waveguide.

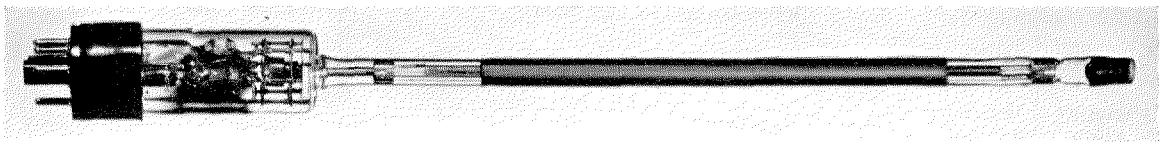

Figure 9—Final design of amplifier tube for the band from 6 to 8 centimetres. Length approximates 14 inches.



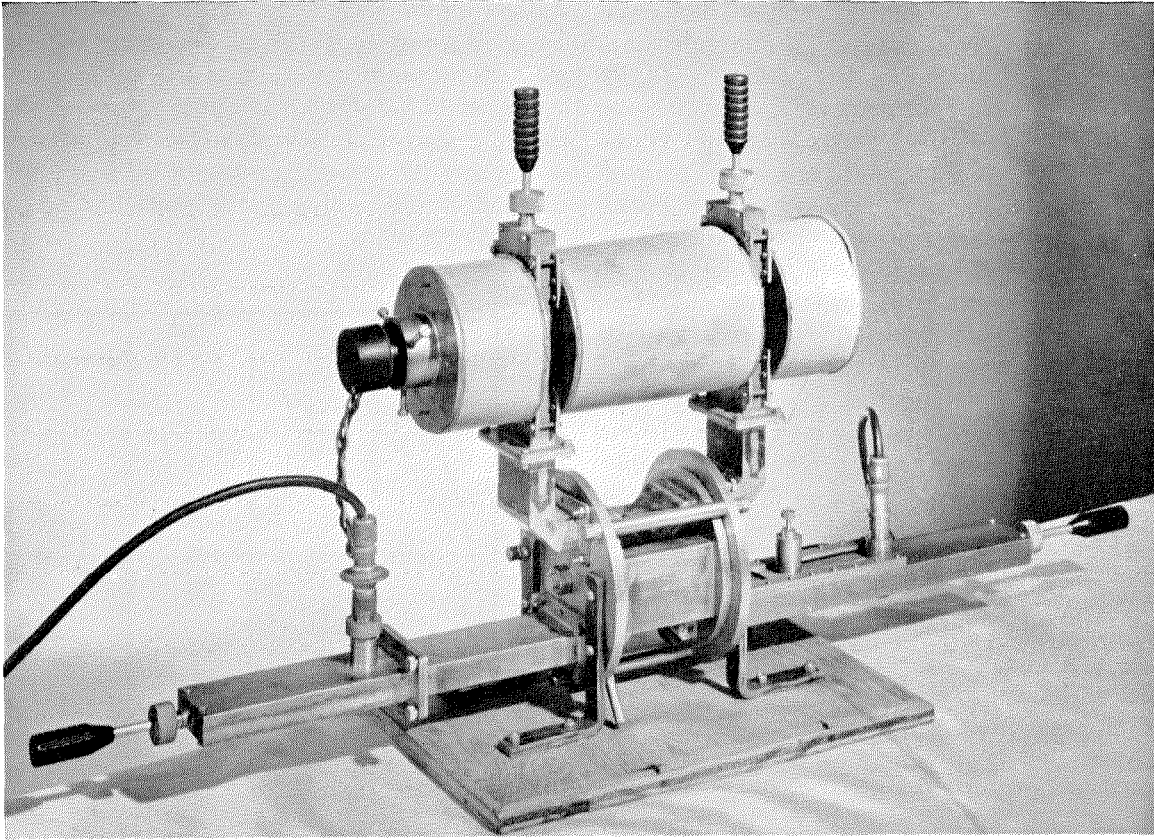

Figure 10—Amplifier tube and circuit with waveguide switch for testing.

age by  $\pm 50$  volts results in a drop in gain of only 2 decibels. Figure 11 is a curve of gain versus helix voltage for a constant collector current of 3.0 milliamperes. The variation in gain between tubes amounts to about  $\pm 4$  decibels, and all tubes can be made to give 25 decibels of gain by slight adjustment to the collector current.

The maximum output power delivered into a matched waveguide at 3.0 milliamperes of beam current is approximately 140 milliwatts; assuming a helix voltage of 1400 and a cathode current of 5.0 milliamperes, this corresponds to an efficiency of 2 per cent. Figure 12 is a curve of output power versus input signal power, from which it will be seen that the response is appreciably non-linear for outputs greater than 70 milliwatts. The two dotted-line curves show the relation between output and input power at helix voltages 50 volts above and below the optimum respectively. The same collector current was used in all three curves.

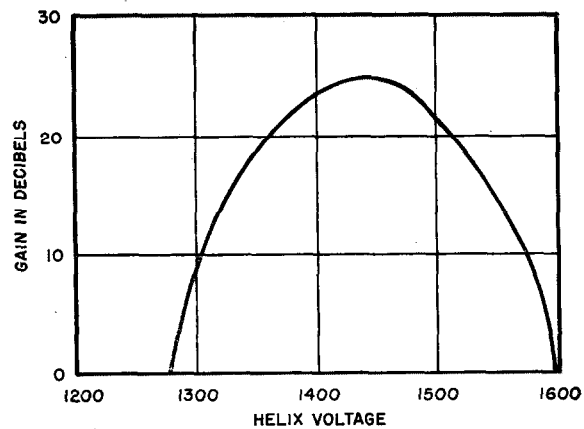

Figure 11—Variation of gain with helix voltage.

It will be noticed that the output decreases if the input signal level is increased beyond that giving maximum output—a phenomenon akin to overbunching in klystron amplifiers.

Noise-factor measurements have been made

using a calibrated signal generator and a receiver incorporating a thermistor in the intermediate-frequency amplifier for measurement of the signal and noise output powers. The results were 18.0 and 20.0 decibels respectively for two tubes. These figures relate to the overall noise-factor of a system consisting of a travelling-wave amplifier followed by a crystal mixer and intermediate-frequency amplifier. In view of the high gain of the travelling-wave tube, however, the contribution of mixer and intermediate-frequency noise to the overall noise-factor is negligible. It has been found that the noise-factor changes only very slowly with beam current, as long as the current is adequate for the tube to give a reasonably high gain. In a particular case, a change in beam current from 1.0 to 4.0 milliamperes resulted in a change in noise-factor of only 2 decibels, the better noise-factor being obtained at the higher current.

It is worth noting that in multi-stage high-gain amplifiers, in which the full bandwidth is not needed, steps would have to be taken to limit the bandwidth at some point in the amplifier, as otherwise the large noise power available in such a wide band would overload the amplifier. For example, with a noise-factor of 20 decibels and a bandwidth of 1400 megacycles, a gain of only 84 decibels is necessary to raise the noise level to 140 milliwatts, the maximum output that this particular type of tube can deliver.

### 7. Conclusion

It is believed that the development work described here has demonstrated that the travelling-wave tube is a practical proposition for use in a repeater-amplifier of a microwave link. Before complete repeater-amplifiers using these tubes can be made, however, it may be necessary to develop tubes capable of higher output power for the output stages and tubes with a lower noise-factor for the input stages. Some progress has

already been made along both of these lines. Tubes have been made in these laboratories with output powers in excess of 1 watt and noise-factors of 13.5 decibels have been recorded with specially designed input tubes. The final question of whether the travelling-wave or other types of tube will be used will probably be decided on the basis of economics.

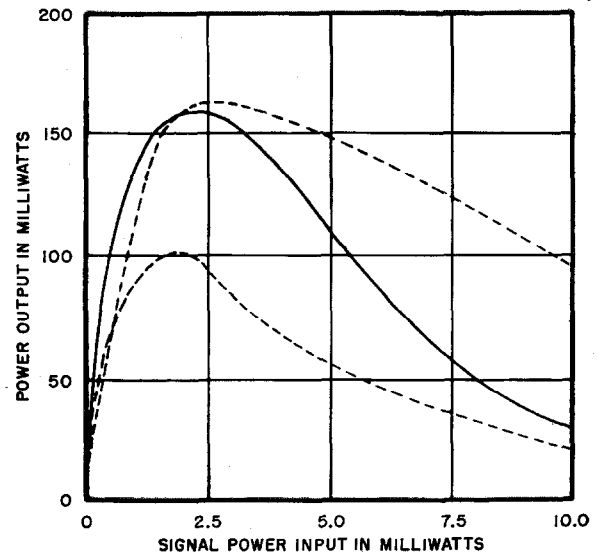

Figure 12—Relation between power output and signal power input. Solid line is for optimum helix voltage (1350 volts) for maximum gain. The upper broken line is for 50 volts above and the lower curve for 50 volts below optimum.

### 8. Acknowledgement

In conclusion, the author wishes to acknowledge the valuable assistance he has received from his many colleagues at Standard Telephones and Cables, Limited, Ilminster, including Mr. S. Barker, now at the Royal Naval Scientific Service.

This paper is published with the approval of the Lords Commissioners of the Admiralty, but the responsibility for any statements of fact or opinions expressed rests solely with the author.

## Telephone Statistics of the World\*

**D**URING THE YEAR 1947, there were 6,000,000 telephones added to the telephone networks of the world, making a total of 60,600,000 at the end of the year. This increase is all the more striking when it is considered that it took more than 25 years after the invention of the telephone for the world to acquire its first 6,000,000 instruments. At that time,

1947 by nearly 300,000 instruments, which was 5 percent of the total net gain throughout the world.

Two-thirds of all the telephones in the world were privately owned and operated. Of those operated by governmental systems, more than three-fourths were on the continent of Europe. Within this category, the largest system in re-

TABLE 1  
TELEPHONES IN CONTINENTAL AREAS  
January 1, 1948 (a)

Continental Area	Total Telephones			Privately Owned		Automatic (Dial)	
	Number	Percent of Total World	Per 100 Population	Number	Percent of Total	Number	Percent of Total
North America (less United States) . . . . .	2,717,000	4.5	4.2	2,383,500	87.7	1,560,000	57.4
United States . . . . .	34,867,000	57.5	24.2	34,867,000	100.0	20,850,000	59.8
South America . . . . .	1,489,000	2.5	1.4	791,500	53.2	1,048,000	70.4
Europe . . . . .	17,717,000	29.2	3.0	2,650,000	15.0	11,170,000	63.0
Asia . . . . .	1,800,000	3.0	0.2	210,000	11.7	740,000	41.1
Africa . . . . .	660,000	1.1	0.4	9,000	1.4	437,000	66.2
Oceania . . . . .	1,350,000	2.2	1.3	99,000	7.3	820,000	60.7
World . . . . .	60,600,000	100.0	2.6	41,010,000	67.7	36,625,000	60.4

(a) Partly estimated. All data have been adjusted to January 1, 1948.

there was only one telephone for every 800 individuals in the world, as compared with one telephone for every 38 people in the world today.

More than three and one-quarter million of the world's increase in telephones were added in the United States which, at the end of the year, had 34,867,000 telephones in service or 57.5 percent of the world's total. The United Kingdom, which has the second largest network of telephone facilities in the world, increased its telephones during

respect to absolute size is that of the United Kingdom; the government-operated system having the greatest telephone development is that of Sweden with one telephone for every five persons, as compared to the United States with one telephone for every four persons.

Through vigorous research and work by communications experts in the various administrations and operating companies throughout the world, telephone service in recent years has been so extended and improved that the ideal of universal service has nearly been attained.

\* Reprinted in part from a booklet issued by the American Telephone and Telegraph Company.

TABLE 2  
TELEPHONES IN COUNTRIES OF THE WORLD  
January 1, 1948

Country	Total Telephones			Ownership		Automatic (Dial)	
	Number	Percent of Total World	Per 100 Population	Government	Private	Number	Percent of Total
<b>North America:</b>							
United States.....	34,866,758	57.5	24.2	—	34,866,758	20,850,000	59.8
Canada.....	2,213,400	3.7	17.4	283,500	1,929,900	1,254,400	56.7
Central America..... (a)	53,300	+	0.5	29,000	24,300	20,700	38.8
Cuba.....	91,800	0.2	1.8	578	91,222	75,850	82.6
Jamaica.....	9,701	+	0.7	—	9,701	8,875	91.5
Mexico.....	237,000	0.4	1.0	3,000	234,000	160,846	67.9
Newfoundland & Labrador.....	14,760	+	4.6	1,690	13,070	90	0.6
Puerto Rico.....	31,988	+	1.5	1,514	30,474	15,825	49.5
Trinidad & Tobago.....	11,027	+	1.9	—	11,027	6,617	60.0
Other Places..... (a)	54,300	+	0.7	14,300	40,000	16,700	30.8
<b>South America:</b>							
Argentina.....	651,082	1.1	4.0	572,582	78,500	470,000	72.2
Bolivia.....	7,800	+	0.2	—	7,800	6,050	77.6
Brazil.....	468,500	0.8	1.0	1,500	467,000	340,000	72.6
Chile.....	119,500	0.2	2.1	—	119,500	78,604	65.8
Colombia.....	57,300	+	0.5	36,000	21,300	19,500	34.0
Ecuador.....	10,000	+	0.3	4,600	5,400	1,200	12.0
Paraguay.....	4,900	+	0.4	4,900	—	4,200	85.7
Peru.....	43,000	+	0.5	—	43,000	31,845	74.1
Uruguay.....	73,367	0.1	3.2	71,732	1,635	53,014	72.3
Venezuela.....	48,800	+	1.1	1,200	47,600	43,062	88.2
Other Places..... (a)	4,744	+	0.8	4,744	—	128	2.7
<b>Europe:</b>							
Austria.....	305,311	0.5	4.4	305,311	—	230,227	75.4
Belgium.....	534,780	0.9	6.3	534,780	—	388,997	72.7
Bulgaria.....	54,347	+	0.8	54,347	—	23,000	42.3
Czechoslovakia.....	350,708	0.6	2.9	350,708	—	208,319	59.4
Denmark.....	617,586	1.0	14.8	(b) 30,948	586,638	250,277	40.5
Eire.....	59,753	+	2.0	59,753	—	34,247	57.3
Finland.....	281,013	0.5	6.9	28,136	252,877	145,703	51.8
France.....	2,108,140	3.5	5.2	2,108,140	—	1,263,331	59.9
Germany..... (c)	1,753,000	2.9	3.3	1,753,000	—	960,000	54.8
Greece.....	62,900	0.1	0.8	1,000	61,900	61,600	97.9
Hungary.....	106,768	0.2	1.2	106,768	—	77,492	72.6
Iceland.....	15,696	+	11.8	15,696	—	9,596	61.1
Italy.....	958,813	1.6	2.1	—	958,813	857,612	89.4
Luxemburg.....	19,654	+	6.8	19,654	—	14,312	72.8
Netherlands.....	575,995	1.0	5.9	575,995	—	507,151	88.0
Norway..... (c)	376,503	0.6	12.0	310,192	66,311	218,420	58.0
Poland.....	192,156	0.3	0.8	192,156	—	127,500	66.4
Portugal.....	114,818	0.2	1.4	34,272	80,546	54,988	47.9
Romania..... (e)	127,153	0.2	0.8	1,022	126,131	96,402	75.8
Spain.....	509,993	0.8	1.8	—	509,993	367,576	72.1
Sweden.....	1,450,478	2.4	21.2	1,448,470	2,008	853,665	58.9
Switzerland.....	744,997	1.2	16.3	744,997	—	692,542	93.0
United Kingdom..... (b)	4,654,500	7.7	9.3	4,654,500	—	3,202,500	68.8
Other Places..... (a)	1,800,000	3.0	0.7	1,800,000	—	555,000	30.8
<b>Asia:</b>							
China.....	244,028	0.4	+	84,028	160,000	178,000	72.9
Japan..... (b)	1,195,238	2.0	1.5	1,195,238	—	366,221	30.6
Korea..... (e)	75,134	0.1	0.3	75,134	—	24,871	33.1
Turkey.....	43,114	+	0.2	43,114	—	36,000	83.5
Other Places..... (a)	290,000	0.5	+	240,000	50,000	150,000	51.7
<b>Africa:</b>							
Algeria.....	75,670	0.1	0.9	75,670	—	49,634	65.6
Egypt..... (e)	99,814	0.2	0.4	99,814	—	66,009	66.1
Morocco.....	45,153	+	0.5	36,553	8,600	28,800	63.8
Tunisia.....	19,729	+	0.6	19,729	—	12,296	62.3
Union of South Africa.....	335,000	0.6	2.9	335,000	—	245,000	73.1
Other Places..... (a)	80,700	0.1	+	80,400	300	31,400	38.9
<b>Oceania:</b>							
Australia..... (d)	905,017	1.5	11.9	905,017	—	538,438	59.5
Hawaii.....	92,076	0.2	17.5	—	92,076	84,730	92.0
New Zealand..... (b)	300,552	0.5	16.5	300,552	—	172,830	57.5
Philippine Republic.....	6,917	+	+	—	6,917	5,419	78.3
Other Places..... (a)	34,000	+	+	34,000	—	3,900	11.5

+ Less than 0.1.

(a) See Table 5 for detail.

(b) March 31, 1948.

(c) Excluding the Russian Zone of Occupation.

(d) June 30, 1947.

(e) January 1, 1947.

TABLE 3, TELEPHONE DEVELOPMENT OF LARGE CITIES, January 1, 1948

Country and City (or Exchange Area)	Estimated Population (Thousands)	Number of Telephones	Telephones Per 100 Population	Country and City (or Exchange Area)	Estimated Population (Thousands)	Number of Telephones	Telephones Per 100 Population
Algeria:				Netherlands:			
Algiers.....	361	25,802	7.1	Amsterdam.....	814	83,592	10.3
Argentina:				Haarlem.....	201	17,298	8.6
Buenos Aires.....	4,065	406,228	10.0	The Hague.....	600	74,566	12.4
Australia:				Rotterdam.....	723	56,747	7.8
Adelaide.....	383	51,000	13.3	Utrecht.....	205	18,510	9.0
Brisbane.....	402	56,840	14.1	New Zealand: (a)			
Melbourne.....	1,227	204,039	16.6	Auckland.....	275	42,979	15.6
Sydney.....	1,484	238,983	16.1	Wellington.....	185	43,391	23.5
Austria:				Norway: (c)			
Vienna.....	1,550	163,117	10.5	Oslo.....	424	105,422	24.9
Belgium:				Portugal:			
Antwerp.....	573	57,669	10.1	Lisbon.....	794	52,123	6.6
Brussels.....	930	183,905	19.8	Oporto.....	324	17,664	5.5
Liège.....	363	31,387	8.6	Puerto Rico:			
Brazil:				San Juan.....	220	15,924	7.2
Rio de Janeiro.....	2,160	172,874	8.0	Spain:			
São Paulo.....	1,720	93,369	5.4	Barcelona.....	1,225	79,581	6.5
Canada:				Madrid.....	1,276	104,300	8.2
Montreal.....	1,219	293,253	24.1	Seville.....	375	15,174	4.0
Ottawa.....	255	71,651	28.1	Valencia.....	520	17,132	3.3
Toronto.....	911	322,980	35.4	Sweden:			
Vancouver.....	391	113,278	29.0	Göteborg.....	337	103,858	30.8
Winnipeg.....	352	76,136	21.6	Malmö.....	181	48,462	26.8
Chile:				Stockholm.....	889	371,399	41.8
Santiago.....	1,104	64,553	5.8	Switzerland:			
China:				Basel.....	172	61,107	35.5
Shanghai.....	4,494	94,945	2.1	Bern.....	144	53,952	37.5
Cuba:				Geneva.....	126	48,032	38.1
Havana.....	900	64,195	7.1	Zurich.....	405	116,946	28.9
Czechoslovakia:				United Kingdom: (a)			
Prague.....	921	122,273	13.3	Belfast.....	453	32,720	7.2
Denmark:				Birmingham.....	1,290	107,260	8.3
Copenhagen.....	973	288,214	29.6	Edinburgh.....	488	68,320	14.0
Eire:				Glasgow.....	1,202	103,570	8.6
Dublin.....	513	34,247	6.7	Kingston upon Hull.....	346	25,302	7.3
Finland:				Liverpool.....	1,427	105,720	7.4
Helsinki.....	380	83,898	22.1	London (City and County of).....	3,391	788,870	23.3
France:				Manchester.....	1,200	120,800	10.1
Bordeaux.....	254	31,314	12.3	Newcastle on Tyne.....	492	40,080	8.1
Lille.....	210	22,494	10.7	Sheffield.....	508	39,730	7.8
Lyon.....	545	60,502	11.1	Uruguay:			
Marseille.....	636	53,247	8.4	Montevideo.....	730	53,014	7.3
Paris.....	2,734	545,000	19.9	Venezuela:			
Germany:				Caracas, D.F.....	450	34,739	7.7
Berlin.....	3,253	86,684	2.7	United States:			
Bremen.....	405	29,188	7.2	New York.....	7,888	2,458,102	31.2
Frankfort-on-Main.....	535	42,495	7.9	Chicago.....	3,700	1,396,387	37.7
Hamburg—Altona.....	1,469	145,450	9.9	Los Angeles.....	1,950	740,943	38.0
Munich.....	842	38,110	4.5	Cleveland.....	1,313	458,380	34.9
Hawaii:				Pittsburgh.....	1,035	346,836	33.5
Honolulu.....	268	50,607	18.9	Total 9 exchange areas with more than one million population.....	22,355	7,342,777	32.8
Hong Kong (b).....	1,500	19,974	1.3	Washington, D.C.....	942	410,072	43.5
Hungary:				San Francisco.....	836	398,712	47.7
Budapest.....	1,500	72,031	4.8	Boston.....	738	275,121	37.3
Italy:				Minneapolis.....	600	237,810	39.6
Florence.....	371	36,022	9.7	Seattle.....	570	235,646	41.3
Milan.....	1,267	173,850	13.7	Total 16 exchange areas with 500,000 to one million population.....	10,651	3,753,022	35.2
Naples.....	1,020	25,327	2.5	Portland (Oregon).....	472	167,674	35.5
Rome.....	1,600	203,083	12.7	Denver.....	410	164,259	40.1
Venice.....	303	16,680	5.5	St. Paul.....	358	132,184	36.9
Japan: (a)				Hartford.....	274	111,265	40.6
Kobe.....	664	22,130	3.3	Oklahoma City.....	272	97,314	35.8
Kyoto.....	1,029	55,669	5.4	Total 37 exchange areas with 200,000 to 500,000 population.....	11,701	3,516,457	30.3
Nagoya.....	899	25,938	2.9	Total 62 exchange areas with more than 200,000 population.....	44,707	14,642,256	32.8
Osaka.....	1,652	70,060	4.2				
Tokio.....	4,385	153,547	3.5				
Mexico:							
Mexico, D.F.....	1,830	126,340	6.9				

Note: There are shown, for purposes of comparison, the total development of all cities in the United States in certain population groups and the development of certain representative cities within each such group.

(a) March 31, 1948.

(b) September 30, 1947.

(c) June 30, 1947.

TABLE 4  
TELEPHONE CONVERSATIONS, 1947

Country	Number of Conversations (a) (in Thousands)			Per Capita
	Local	Toll	Total	
Algeria .....	38,700	35,900	74,600	8.8
Argentina.....	2,340,000	30,000	2,370,000	147.0
Australia.....(b)	798,200	58,500	856,700	114.0
Belgium.....	357,100	49,400	406,500	48.3
Brazil.....	2,540,000	30,000	2,570,000	54.1
Canada.....	3,760,000	84,000	3,844,000	305.5
Chile.....	409,500	20,500	430,000	77.9
Cuba.....	540,000	3,000	543,000	106.7
Czechoslovakia .....	396,900	42,600	439,500	36.1
Denmark.....	888,900	155,900	1,044,800	251.2
Egypt.....(c)	427,000	8,000	435,000	17.2
Eire.....	54,000	8,300	62,300	21.0
Finland.....	429,000	79,400	508,400	130.5
France.....	1,078,600	412,800	1,491,400	36.8
Germany.....(d)	1,560,500	276,900	1,837,400	34.7
Greece.....(e)	169,700	2,300	172,000	22.9
Hawaii.....	176,700	4,200	180,900	346.6
Hungary.....	118,800	5,500	124,300	13.4
Iceland.....	39,900	1,100	41,000	308.3
Jamaica.....	28,500	300	28,800	22.0
Japan.....(b)	3,191,700	182,600	3,374,300	43.1
Luxemburg.....	4,900	9,400	14,300	49.7
Mexico.....	587,800	6,700	594,500	25.4
Morocco.....	47,500	12,200	59,700	6.0
Norway.....(f)	492,500	45,100	537,600	172.1
Portugal.....	127,800	23,800	151,600	18.2
Puerto Rico.....	61,300	1,700	63,000	29.3
Spain.....	1,060,000	49,300	1,109,300	40.3
Sweden.....(f)	1,794,700	96,700	1,891,400	279.6
Switzerland.....	353,000	259,400 (g)	612,400	134.7
Trinidad and Tobago.....	38,800	500	39,300	68.3
Tunisia.....	15,300	5,800	21,100	6.9
Union of South Africa.....(e)	430,200	27,800	458,000	40.3
United Kingdom.....(b)	2,720,000	218,000	2,938,000	59.1
United States.....	43,425,000	1,875,000	45,300,000	317.3
Uruguay.....	236,700	3,100	239,800	103.5
Venezuela.....	250,000	4,000	254,000	56.5

(a) Telephone conversation data were not available for all countries.

(b) Year ended March 31, 1948.

(c) Year 1946.

(d) Excluding Russian Zone of Occupation.

(e) Year ended March 31, 1947.

(f) Year ended June 30, 1947.

(g) Three-minute units.

TABLE 5  
TELEPHONES IN OTHER PLACES (a)  
January 1, 1948

Countries	Number of Telephones		Countries	Number of Telephones	
	Total	Automatic or Dial		Total	Automatic or Dial
<b>Central America:</b>			<b>Other Places in Europe:</b>		
British Honduras.....	565	0	Albania.....	1,200 0	150 0
Costa Rica.....	8,375	0	Germany..... (e)	200,000 0	100,000 0
Guatemala.....	3,900 0	2,700 0	Gibraltar.....	1,195	1,112
Honduras.....	5,300 0	1,400 0	Liechtenstein.....	1,321	0
Nicaragua.....	2,157	100 0	Malta and Gozo.....	5,448	0
Panama..... (b)	27,000 0	16,500 0	Monaco.....	2,465	2,208
Salvador.....	6,047	0	U.S.S.R..... (f)	1,500,000 0	400,000 0
<b>Other Places in North America:</b>			Yugoslavia.....	80,000 0	48,000 0
Alaska.....	29,498	790	Miscellaneous Places.....	10,000 0	5,000 0
Bahamas.....	3,100	3,100	<b>Other Places in Africa:</b>		
Barbados.....	3,302	3,081	Belgian Congo.....	3,104	668
Bermuda.....	2,850	2,850	British East Africa.....	13,500	8,902
Curacao.....	2,313	1,770	British South Africa.....	19,900	15,900
Dominican Republic.....	4,511	2,795	British Southwest Africa.....	3,024	1,376
Greenland.....	0	0	British West Africa.....	12,540	930
Guadeloupe.....	668	0	Ethiopia.....	1,750	1,400
Haiti.....	2,560 0	2,300 0	French Cameroon.....	722	0
Leeward Islands.....	800	0	French Equatorial Africa.....	840	0
Martinique.....	1,932	0	French Togo.....	304	0
St. Pierre and Miquelon.....	90	0	French West Africa.....	7,653	1,115
Virgin Islands.....	846	0	Madagascar.....	4,220	0
Windward Islands.....	1,778	0	Mauritius.....	3,518	0
<b>Other Places in South America:</b>			Portuguese Africa.....	4,943	130
British Guiana.....	3,038	128	Reunion.....	2,050	0
Falkland Islands.....	159	0	Somaliland (British & French).....	335	0
French Guiana.....	165	0	Spanish Guinea.....	250	0
Surinam.....	1,382	0	Miscellaneous Places.....	2,000 0	1,000 0
<b>Other Places in Asia:</b>			<b>Other Places in Oceania:</b>		
Afghanistan.....	2,676	250	Fiji.....	1,700 0	0
Ceylon.....	13,484	11,503	French Oceania.....	1,773	0
Cyprus.....	3,410	0	Indonesian Republic.....	2,000 0	0
French India.....	72	72	Netherlands Indies..... (g)	20,263	1,200
French Indo-China.....	3,633	1,785	North Borneo.....	430 0	0
Hong Kong..... (c)	19,974	19,974	Pacific Islands (British).....	450	0
Iraq.....	13,043	9,394	Pacific Islands..... (h)	5,332	2,705
Malaya.....	13,633	4,108	Papua-New Guinea.....	1,000 0	0
Pakistan.....	13,829	8,470	Portuguese Timor.....	190 0	0
Palestine..... (d)	24,856	20,184	Samoa.....	430	0
Portuguese Asia.....	1,557	1,400	Sarawak.....	409	0
Singapore.....	10,966	10,966	Miscellaneous Places.....	100 0	0
Syria.....	6,200	0			
Miscellaneous Places.....	162,000 0	62,000 0			

0 Partly estimated.

(a) Countries and territories comprising "Other Places" categories as shown in Table 2.

(b) Including Canal Zone.

(c) September 30, 1947.

(d) January 1, 1947.

(e) Russian Zone of Occupation only.

(f) Including all Asiatic territory of the U.S.S.R.

(g) Territory under authority of Netherlands Indies Government.

(h) Territories (formerly Japanese South Sea mandated territories) under authority of U. S. military forces.

# Interconnection of Channel Groups Between Coaxial Cables

By A. FROMAGEOT and M. A. LALANDE

*Laboratoire Central de Télécommunications, Paris, France*

THE OPERATION of coaxial-cable networks for carrier telephony raises the problem of introducing and removing groups of channels into and from such cables. It must be possible to remove a frequency band  $\Delta F$  without disturbing the currents having frequencies adjacent to that band. The attenuation that must be provided in the eliminated band depends on the cross-talk requirements between the channels within the band and those adjacent to it. If it is desired to introduce the frequency band  $\Delta F$  into a second cable, this band must be selected and the currents from the adjacent channels must be so attenuated as not to disturb the currents of the same frequencies carried by the second cable. The value of this attenuation depends again on the cross-talk requirements.

There may be designated for interconnection purposes, one or even two frequency bands, for instance, those of the first two supergroups, that is 60 to 300 and 312 to 552 kilocycles per second. Such a solution has the advantage of simplicity and consequently of cheapness. In a large number of cases, it can fulfill the operating requirements. There are, however, circumstances where greater interconnection facilities are desirable even at some additional expense. The solution presented in this paper is then of interest, its purpose being the interconnection of any one of the first eight supergroups.

The circuits that will be described, as well as the results obtained, are related to the interconnection of the eighth supergroup, which, due

to its high frequency, presents the greatest difficulties among the first eight. It will be seen that the equipments required for the other supergroups include an appreciable number of components identical to those developed for the eighth. (The question of a filter transmitting one supergroup, and only one, is not dealt with in the present paper).

## 1. Principles

In Figure 1, a filter  $F1$  eliminates the frequency band ( $f_2$  to  $f_3$ ) that it is desired to remove from the cable and provides the attenuation required by cross-talk considerations (70 decibels). This filter eliminates to some degree the currents in the transitional bands that are adjacent to  $f_2$  and  $f_3$  (i.e.,  $f_1$  to  $f_2$  and  $f_3$  to  $f_4$ ), and this results in an amplitude distortion of the corresponding channels. To compensate for this unavoidable distortion, the currents pertaining to the transitional bands are selected at the input of the band-elimination filter and, after they have

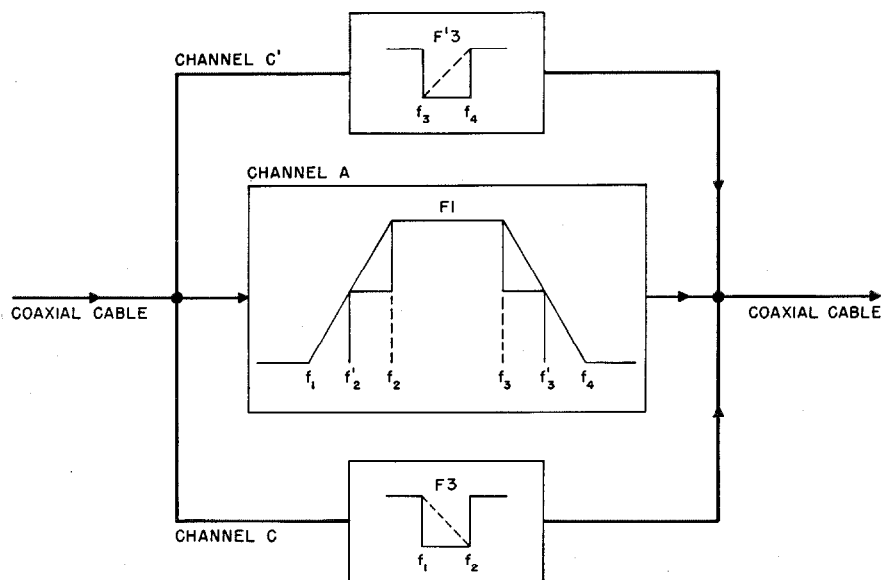

Figure 1—Arrangement of filters for removing a frequency band  $\Delta F$  from a coaxial cable. Distortion at band edges resulting from the characteristics of the main filter  $F1$  is compensated by filters  $F3$  and  $F'3$ , which operate in the transitional-frequency bands.



been given a suitable amplitude, are returned to the cable at the output of the filter. The circuits corresponding to the bands  $f_1$  to  $f_2$  and  $f_3$  to  $f_4$  are referred to on the schematic as channels  $C$  and  $C'$ ,

$K_1$  being independent of frequency.  $\varphi_1$  results from the action of the phase shifter  $D1$  and does not enter into the present analysis. It will be shown later that the effect of the phase-shifter

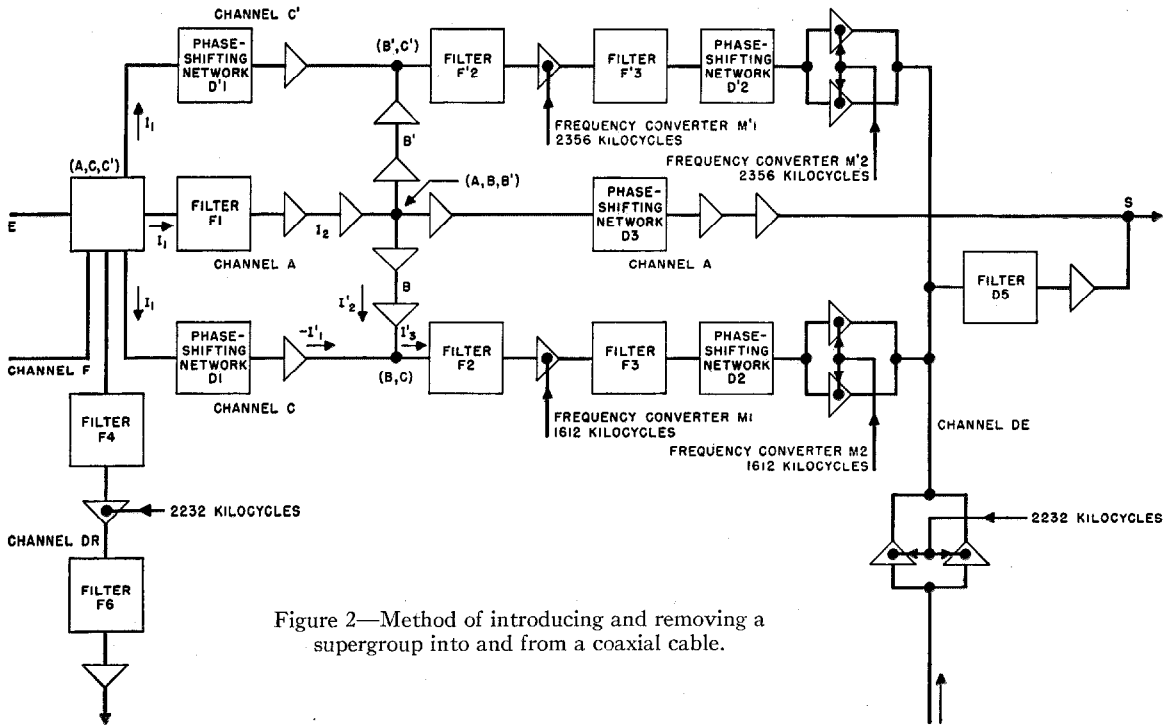

Figure 2—Method of introducing and removing a supergroup into and from a coaxial cable.

respectively. Channel  $C$  (Figure 2) includes a phase-shifting network  $D1$ , a pentode amplifier stage, a frequency converter comprising the filter  $F2$  and the mixer  $M1$ , which shifts the frequency band ( $f_1$  to  $f_2$ ) into the pass band of the filter  $F3$ , a phase-shifting network  $D2$ , and a frequency converter  $M2$ . Channel  $C'$  includes similar components relating to the transitional band  $f_3$  to  $f_4$ .

$D1$  is to balance, to a certain extent and within a given frequency band, the phase of filter  $F1$ . The resulting current at point  $(B,C)$ , supplied to channel  $C$  is

$$I'_3 = -I'_1 + I'_2 = K_1(I_2 - I_1 \exp j\varphi_1).$$

The value of this current at the output of channel  $C$  is

$$K_2 K_1 (I_2 - I_1 e \exp j\varphi_1) e \exp j\varphi_2,$$

$K_2$  being independent of frequency.

1.1 ANALYSIS OF CHANNELS  $C$  AND  $C'$  WHEN TRANSMITTING TRANSITIONAL BANDS

In Figure 3, vector  $I_1$  represents the current at the system input, that is at point  $A, C, C'$ . Vector  $I_2$  represents the current at the output of filter  $F1$ , and vector  $-I'_1$  represents the current arriving at point  $(B,C)$  through channel  $C$ . The circuit is such that

$$I'_1 = K_1 I_1 e \exp j\varphi_1,$$

$$I'_2 = K_1 I_2,$$

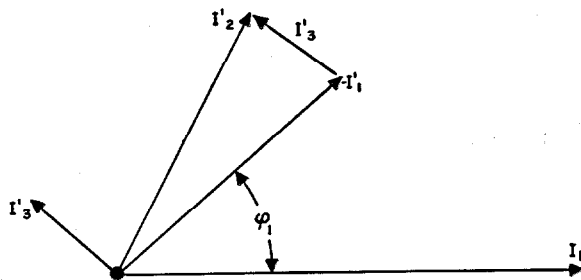

Figure 3—Vector diagram of currents through channels  $A$ ,  $B$ , and  $C$  to point  $B,C$ .

In passing through channel *A*, the current  $I_2$  from the output of filter *F1* is changed to  $I_2 K_2 K_1 e^{j\varphi_2}$ . The addition of the currents at the output of channels *A* and *C* gives

$$K_2 K_1 I_1 e \exp[j(\varphi_1 + \varphi_2)].$$

$K_1$  and  $K_2$  being independent of frequency, output currents are eventually obtained having amplitudes that are proportional to the amplitudes at the input, that is to say, devoid of amplitude distortion. Practically, filters *F2* and *F3* are responsible for the phase-shift  $\varphi_2$ . Networks *D3*, inserted in the main channel, and *D2*, inserted in channel *C*, compensate for this phase shift.

The analysis of operation for channel *C'* is identical.

## 1.2 TRANSITIONAL-BAND FILTERS

The only function of filters *F2* and *F'2* is to eliminate the images of the bands that must be removed. Otherwise, these images would travel through filters *F3* and *F'3* after frequency conversion in *M1* and *M'1*.

Filter *F3* selects the lower transitional band and *F'3* selects the upper transitional band of filter *F1*.

Filter *F3* must have sharp cut-off on the side corresponding to the frequency of  $f_2$  of the filter *F1*. Based on frequencies before conversion in *M1*, filter *F3* must attenuate frequencies above  $f_2$  to a value below the tolerable cross-talk, since the corresponding residual currents would disturb subsequent transmission in the cable. On the other hand, current at frequencies just below

$f_2$  must be transmitted without amplitude distortion since these currents, strongly attenuated by filter *F1* on channel *A*, must be fully transmitted by channel *C*.

In practice, the gap between the transmitted band and the eliminated band in filter *F3* in the vicinity of  $f_2$  equals the distance between two supergroups, that is 8 kilocycles. This filter must provide, within an 8-kilocycle band, a variation in attenuation of the order of the cross-talk attenuation.

Conditions concerning frequency  $f_1$  are less severe. Filter *F3*, however, must define a frequency band, otherwise it would be necessary to insure throughout the entire transmitted band, a correct phase relation between currents transmitted through channels *C* and *A*.

Similar considerations apply to filter *F'3*.

## 1.3 CURRENT TRANSMISSION NEAR CUT-OFF FREQUENCIES OF *F3* AND *F'3*

Networks *D2* and *D3*, *D'2* and *D'3* must compensate for the nonlinearity of the phase characteristics of filters *F3* and *F'3*, respectively. To avoid difficulties due to the shape of the phase characteristic of these filters in the vicinity of their cut-off frequencies, steps have been taken so that currents, the frequencies of which belong to neighboring bands, are effectively transmitted only by either channel *A* or one of the two channels *C* and *C'*, so that the problem of phase relation between currents passing through *A* and *C* or through *A* and *C'* does not arise.

For frequencies lying in the neighborhood of  $f_2$ , the currents are transmitted by channel *C* only: to obtain this, the attenuation in *F1* has

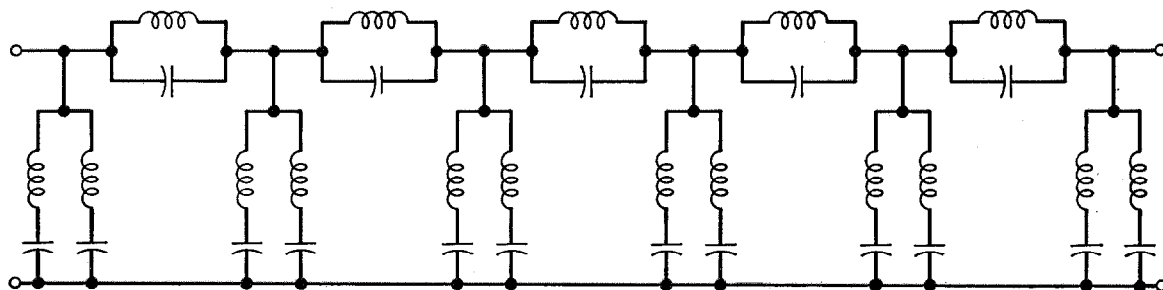

Figure 4—Band-elimination filter for frequencies between 1796 and 2052 kilocycles.

been kept larger than 30 decibels until the value  $f'_2$ , the interval ( $f'_2 f_3$ ) corresponding to the region where the phase shift introduced by  $F3$  is difficult to compensate; in this manner, the currents in the band ( $f'_2 f_2$ ) are transmitted by channel  $C$  only. In the same manner, the frequencies lying in the vicinity of  $f_3$ , which is one of the cut-off frequencies of  $F'3$ , are transmitted through channel  $C'$  only.

In the vicinity of  $f_1$ , currents are transmitted through channel  $A$  only: this is due to the presence of the phase-shifting circuit  $DI$ , which causes the currents transmitted by channel  $C$  to arrive at point ( $B,C$ ) in phase opposition with the currents fully transmitted by the channel ( $A,B$ ). In a similar manner,  $D'$  cancels the currents transmitted by  $C'$  in the vicinity of  $f_4$ , and, consequently, these frequencies are transmitted only by channel  $A$ .

## 2. Details of Actual Circuit

The system described above has not been fully completed. Actually, the circuits for the upper transitional band  $C'$  have been only partially set up and have not been adjusted. Consequently, no compensation has been provided for the distortion introduced by the band-elimination filter at its upper cut-off region. The functioning of this equipment in its present state corresponds to the case of a coaxial cable transmitting only the first eight supergroups, and out of which it is desired to remove at an intermediate point the eighth supergroup. It should be remarked that the transmission of a supergroup higher than the eighth is exceptional at this time.

Before going into the detail of the principal circuit components, numerical values for the frequencies used should be given. The currents transmitted over the cable may be considered as split into five bands: 60 to 1730, 1730 to 1796, 1804 to 2044, 2052 to 2120, and 2120 to 4000 kilocycles. The frequencies 1730 and 2120 kilocycles are approximate and experimentally determined by the attenuation and phase characteristics of the filters.

Besides, there are between the input  $E$  and the output  $S$  of the system, five channels for conveying the signals.

A. Channel  $A$  is the principal channel and passes integrally the bands 60 to 1780 and 2120 to 4000 kilocycles

only. It includes a band-elimination filter for 1804 to 2044 kilocycles.

B. Channel  $C$  is the lower transitional channel and conveys integrally the band 1730 to 1796 kilocycles only.

C. Channel  $C'$  is the upper transitional channel and conveys integrally the band 2052 to 2160 kilocycles only.

D. Channel  $B$  is the lower compensating channel and includes part of channels  $A$  and  $C$ . It is used to cancel the residual signals below 1730 kilocycles in channel  $C$ .

E. Channel  $B'$  is the upper compensating channel and includes part of channels  $A$  and  $C'$ . It is used to cancel the residual signals above 2120 kilocycles in channel  $C'$ .

To these five channels, should be added:

F. Channels  $DR$  and  $DE$ , the first of which selects signals in the band 1804 to 2044 kilocycles received at the input, and the second supplies complementary signals to the output.

G. Channel  $F$  is the synchronizing channel and picks out of the input a frequency of 124 kilocycles to synchronize the generator of the modulating currents used throughout the system.

These currents, which have frequencies of 1612, 2232, and 2356 kilocycles, are used to translate the transitional and the  $DR$  channels down to a frequency where sharp cut-off filtering is convenient. Such frequencies are 118 to 184, 112 to 180, and 312 to 552 kilocycles and sharp cut-off is provided at 184, 180, 312, and 552 kilocycles, respectively. A second modulation, using the same auxiliary frequencies, restores the filtered signals to their original position.

The modulating-current generator may also work as a self-oscillator at 124 kilocycles if this pilot frequency is not transmitted over the cable.

Figure 2 shows schematically the general layout of circuits. The various components, such as filters or phase-shifting networks, have been determined by means of the classical theory of selective circuits. The modulations are done by means of high-slope pentode tubes, the carrier being applied to the suppressor. Level adjustments are obtained by modifying the bias of the suppressors. These means of modulation and level adjustment have the advantage of not producing spurious phase shift.

Without going into every detail, it may be of interest to give some information on the basic components of the equipment, such as the band-elimination filter  $F1$ , the transitional-band filters<sup>1</sup>  $F3$  and  $F'3$ , and the phase-shift networks.

<sup>1</sup> The two filters  $F3$  and  $F'3$  have slightly different cut-off frequencies. This is due to the fact that the carriers used for frequency conversion have been chosen from frequencies already present in coaxial-system terminal equipments.

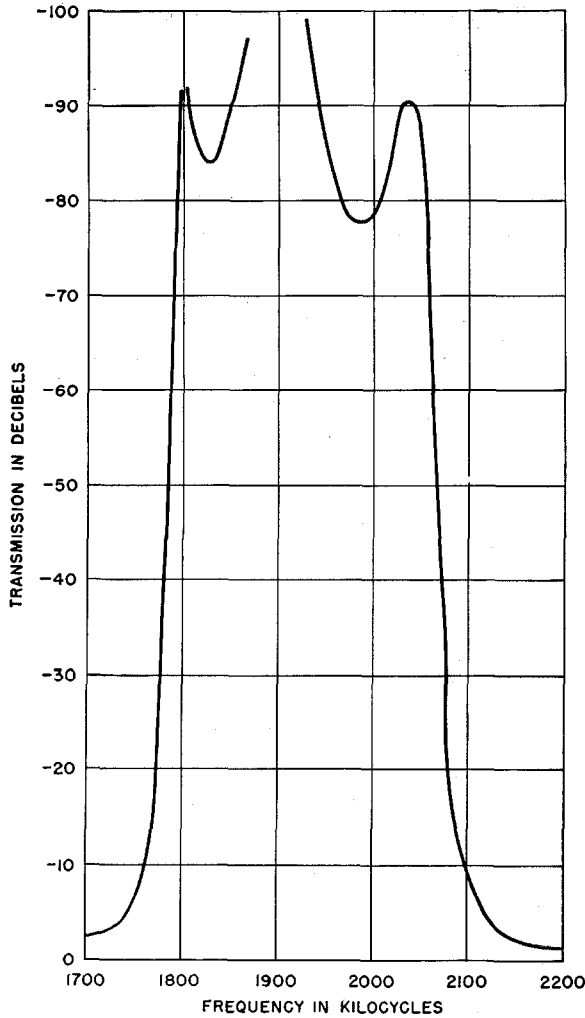

Figure 5—Transmission characteristics of band-elimination filter shown in Figure 4.

2.1 BAND-ELIMINATION FILTER

The schematic of this filter is shown in Figure 4, and its attenuation is shown in Figure 5. It should be remarked that the attenuation is larger than 75 decibels between 1800 and 2050 kilocycles, and larger than 30 decibels between 1780 and 2070 kilocycles. The value of 75 decibels had been chosen a priori, since the parasitic currents flowing through the filter are a cross-talk disturbance for the currents that are transmitted normally in the 1804-to-2044-kilocycle band over the part of the cable beyond the equipment. The value of 30 decibels in the 1780-to-2070-kilocycle band makes unnecessary equal phase relations between channels *A* and *C*, or *A* and *C'*, for frequencies in the vicinity of the cut-off of filters *F3* and *F'3*. The shape of this attenuation curve justifies the values given above for the various frequencies allotted to the channels in the equipment.

2.2 TRANSITIONAL-BAND FILTER

The schematic of the lower-transitional-band filter is given in Figure 6, while its attenuation is shown in Figure 7. It should be remarked that more than 75 decibels of attenuation are provided as the frequency varies from 185 to 192 kilocycles. (When translated into the frequency scale of this filter, the limit frequencies of the transmitted and eliminated supergroups are 1796 minus 1612 = 184 kilocycles and 1804 minus 1612 = 192 kilocycles.)

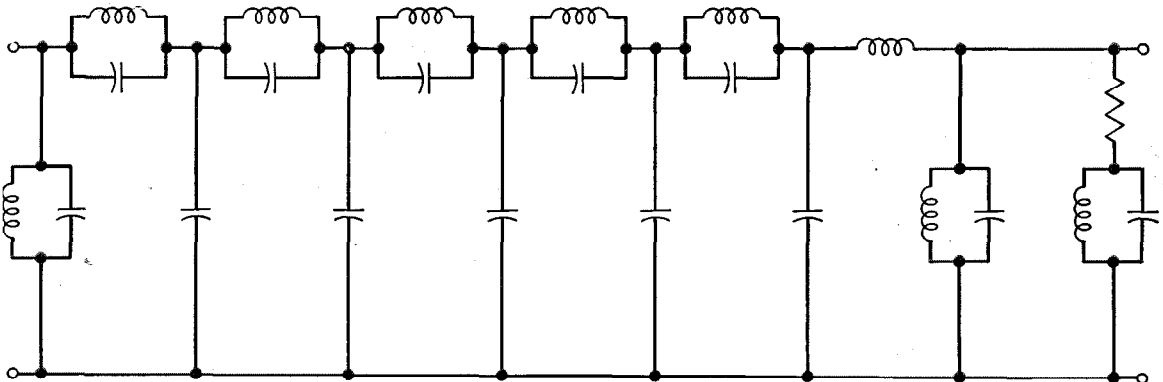

Figure 6—Filter for transition band from 106-184 kilocycles.

2.3 PHASE-SHIFTING NETWORKS

All phase-shifting networks are made up of sections of the type shown in Figure 8. Figure 9 indicates how one such section is constructed.

3. Equipment Characteristics

The system is designed in principle for transmitting the 60-to-4000-kilocycle band. As has been mentioned already, the actual set-up has been limited to the 60-to-2044-kilocycle band because of postponement of the complete study.

Input and output impedances are 75 ohms, and the over-all gain between cable inlet and outlet may be adjusted to 0 decibels. The transmission loss between the input (1804-to-2044-kilocycle band) and the output of *DR* channel (312 to 552-kilocycles) is about 14 decibels. The transmission gain between the input of the *DE* channel (312 to 552 kilocycles) and the output of the system is about 14 decibels.

3.1 AMPLITUDE DISTORTION

The curve in Figure 10 represents the attenuation introduced into the cable transmission by the complete system throughout its full bandwidth.

The curve of Figure 11 is an enlargement of the preceding one, showing in detail the distortion

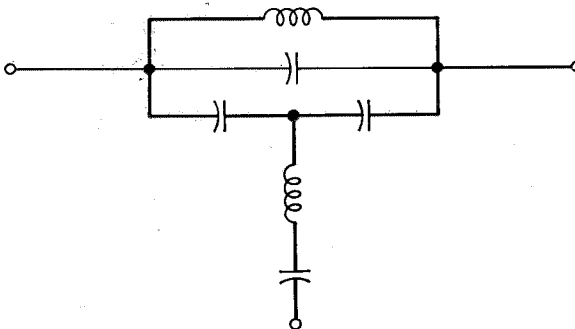

Figure 8—Type of phase-shifting network used.

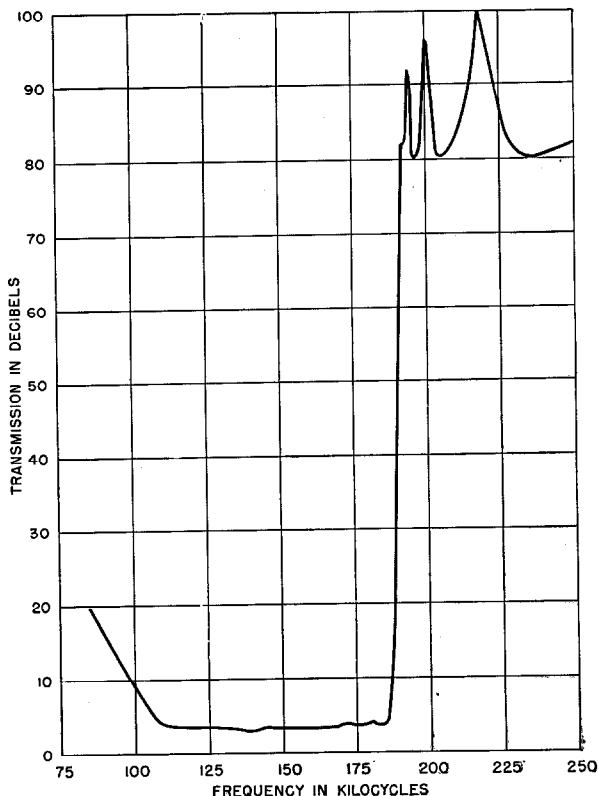

Figure 7—Transmission characteristics of transition-band filter shown in Figure 6.

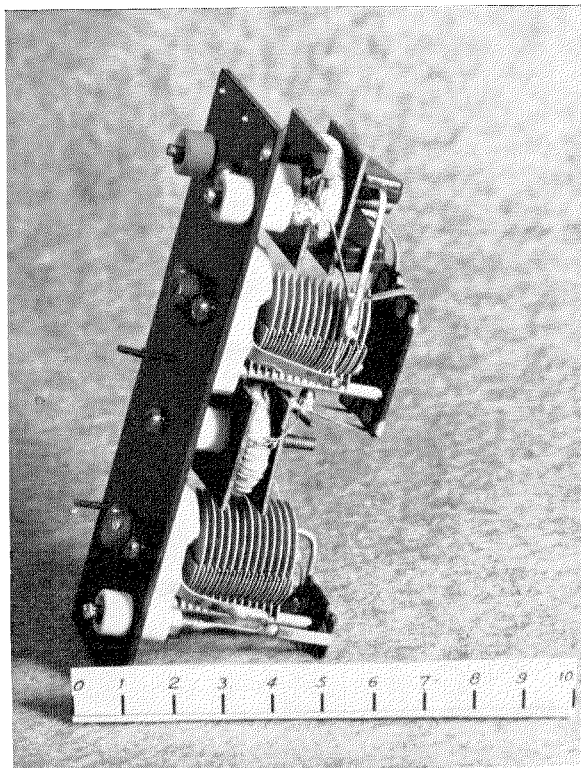

Figure 9—Constructional arrangement of one section of phase-shifting network.

introduced in the speech channels adjacent to the cut-off frequency. It may be seen that this distortion does not exceed 1 decibel within the full width of any 4-kilocycle channel. An improvement in this value is expected when the circuits related to the frequencies above 2044 kilocycles are set up (upper transitional channel *C'*). On the same figure, the attenuation of the band-elimination filter has been plotted to show its compensating effect on the whole circuit.

### 3.1 CROSS-TALK

The attenuation between the input and output of the system in the eliminated band, 1804 to 2044 kilocycles, is due to the band-elimination filter, which introduces an attenuation of at least 75 decibels as is shown in Figure 5. The minimum value that is obtained on the complete circuit is better than 60 decibels as may be seen from Figure 10. The difference between these two

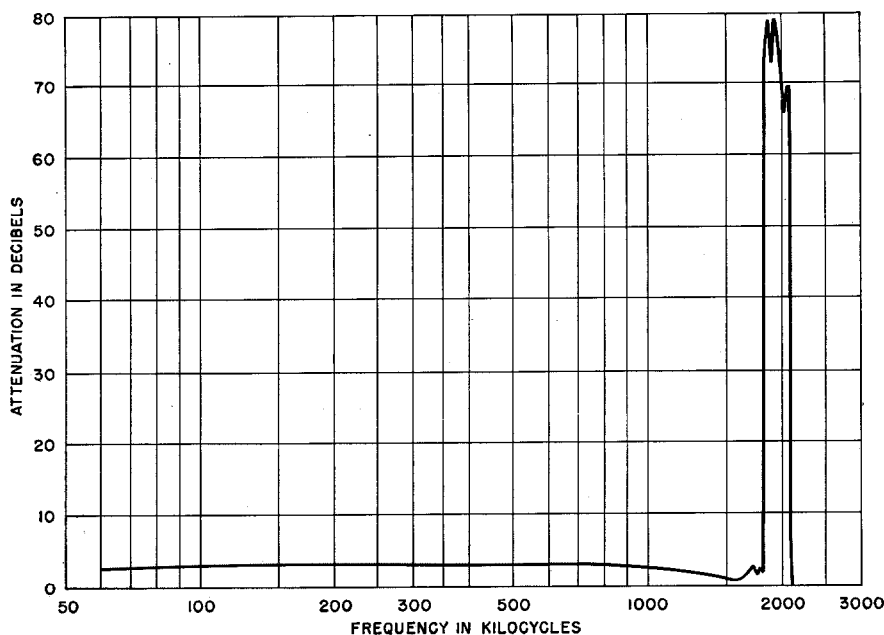

Figure 10—Attenuation introduced into coaxial cable by complete system.

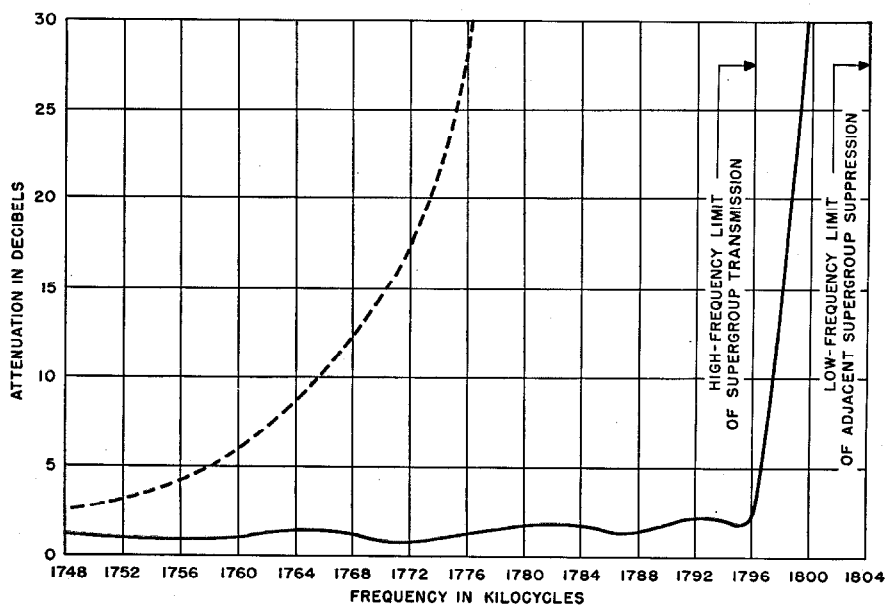

Figure 11—The solid line shows the attenuation characteristics of the system for the 12-channel supergroup adjacent to the lower cut-off frequency shown in Figure 10. The frequency limits of each channel are designated. The variation within any channel does not exceed 1 decibel. The attenuation produced by the band-elimination filter is shown by the broken-line curve.

figures is due to a slight pick-up by the three amplifying stages following the filter. This should be reduced to a negligible value in the final design.

center unit is the band-elimination filter *F1*, and the derived-channel filters *F4* and *F6* are mounted in the lower assembly.

### 3.3 POWER SUPPLY

Plate power is supplied to the various chassis by stabilized 300-volt rectifiers, with a consumption of 300 milliamperes per bay. The alternating-current mains supply is 220 volts, and the power consumption is 500 watts. The stabilized power supplies may be seen at the bottom of the bays.

### 3.4 CASE WHERE ANOTHER SUPERGROUP THAN THE EIGHTH MUST BE REMOVED

The same method as described above applies without difficulty to the removal of any supergroup. By means of frequency conversions, the transitional-band filters in the compensating channels *C* and *C'*, which require the maximum of care, remain the same irrespective of the chosen supergroup. Among the components that vary according to the particular case, only the band-elimination filter *F1* requires careful adjustment.

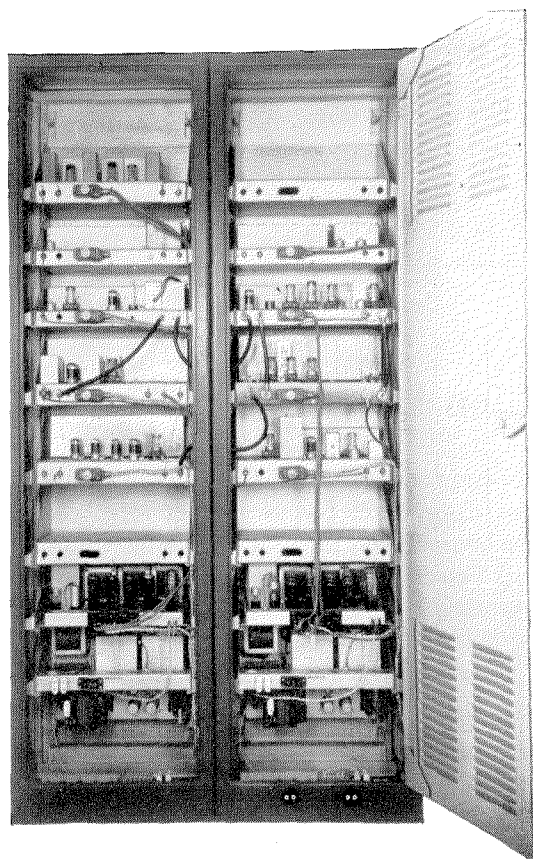

Figure 12—Inside view of the two bays accommodating the experimental equipment.

### 3.2 GENERAL REMARKS

This equipment has been set up for experimental purposes and is not a prototype for manufacture. It consists of two bays,  $22\frac{1}{2}$  inches wide, 86 inches high, and 13 inches deep. Figure 12 shows the inside of these bays. The components have been placed on horizontal chassis, which are very convenient for experimentation but are rather bulky. The equipment could be made substantially smaller by following standard toll telephone equipment practice.

Figure 13 shows the front view of three chassis with the front plates removed. The upper chassis contains the phase shifter *D1* and filter *F2*, the

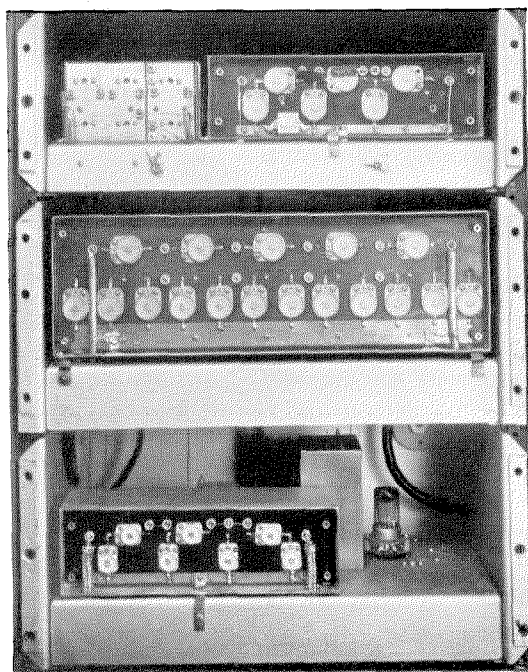

Figure 13—The upper chassis includes the phase shifter *D1* and filter *F2*, the center unit is the band-elimination filter *F1*, and the lower assembly houses the filters *F4* and *F6*.

It appears that, practically, the construction of this filter for any one of the eight lower supergroups does not raise difficulties. On the contrary, the removal of a supergroup of a higher order would probably lead to difficulties due to parasitic resonances.

#### 4. Conclusion

The equipment has provided a difference in attenuation of more than 60 decibels between

frequencies below 1796 kilocycles and frequencies above 1804 kilocycles without appreciable distortion of the transmitted currents in the region below 1796 kilocycles. It provides a means of removing the currents of the eighth supergroup from a coaxial cable; this supergroup may be used for different transmissions on either side of the equipment. The design may be modified readily to handle any one of the seven lower-frequency supergroups.

## Recent Telecommunication Development

**L**OW-CAPACITANCE CABLE—A small flexible coaxial cable with a capacitance of 8.0 micromicrofarads per foot has been developed by the Selenium Intelin Division of Federal Telephone and Radio Corporation. The cable, designated as Intelin Type K-109, was designed as an antenna leadin for automobile radio installations. A reduction of 38 percent in capacitance over that of a solid-dielectric cable is obtained through the use of composite air and polyethylene dielectric.

Previously, low-capacitance antenna leads were manufactured by pulling a conductor into a predetermined length of dielectric tubing over which a metallic braid had been applied. The conductor was neither centered nor supported within the tube. This method was restricted to short lengths as much handling was required and the results were not uniform.

The manufacturing process for the new cable provides a means for crimping the inner phos-

phor-bronze conductor (Number 30 American Wire Gage) and for extruding a polyethylene tube over the conductor in one continuous operation. The crimping and extruding operations are accurately synchronized, and any length of cable may be manufactured.

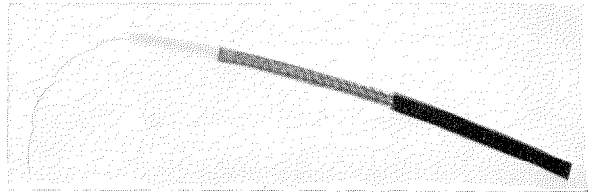

The crimping causes the inner conductor to assume a fixed position with respect to the braided shielding, covering the polyethylene tubing. The jacket is a tough thermoplastic compound and is held to an outside diameter of  $0.275 \pm 0.007$  inch.



# Harmonic Distortion in Frequency-Modulation Off-Resonance Discriminator

By A. R. VALLARINO and MARILYN S. BUYER

Federal Telecommunication Laboratories, Incorporated, Nutley, New Jersey

**T**HIS IS AN ANALYSIS of the frequency-discrimination effect of a resonant circuit on a frequency-modulated wave. The incoming frequency-modulated wave is assumed to be undistorted. The modulation frequency is assumed to be low enough compared to the circuit bandwidth so that the steady-state resonant curve obtains in terms of the instantaneous frequency.

The main advantage of this type of discriminator lies in its simplicity. A single tuned circuit is necessary with a detector preceded by one or two limiters. Curves are shown giving the percentage nonlinearity and the percentage distortion in terms of a parameter  $\delta X = \Delta\omega / \frac{1}{2}BW$ , where  $\Delta\omega$  is the frequency difference between the carrier frequency and the resonance frequency of the tuned circuit and  $\frac{1}{2}BW$  is one half the bandwidth between the 3-decibel points.

Figure 7 gives the percent third-harmonic distortion directly in terms of the frequency deviation of the carrier and the half bandwidth of the tuned circuit.

...

From the ratio of the approximate impedance of a parallel-resonant circuit near resonance to that at resonance, we obtain the relation

$$\frac{Z_1}{Z_o} = \frac{1}{1 + j\lambda Q \left( \frac{2 + \lambda}{1 + \lambda} \right)}$$

The derivation of this relation is given in Appendix 1. The symbols used are defined as follows (Figure 1):

$Z_1$  = impedance close to resonance,

$Z_o$  = impedance at resonance,

$Q = R / \omega_o L = \omega_o / BW$ ,

$BW$  = bandwidth at 3-decibel points,

$\lambda = (\omega_1 - \omega_o) / \omega_o = \Delta\omega / \omega_o$ ,

$X = \Delta\omega / \frac{1}{2}BW$ ,

$\omega_o / 2\pi$  = resonant frequency, and

$\omega_1 / 2\pi$  = a frequency close to resonance.

For  $\lambda \ll 1$ ,  $1 + \lambda \approx 1$ , and  $2 + \lambda \approx 2$ . The equation then reduces to

$$\begin{aligned} Z = \frac{Z_1}{Z_o} &= \frac{1}{1 + 2j\lambda Q} = \frac{1}{1 + j\frac{\Delta\omega}{\frac{1}{2}BW}} = \frac{1}{1 + jX} \\ &= \frac{1}{(1 + X^2)^{\frac{1}{2}}} \exp[-j \tan^{-1} X]. \end{aligned}$$

This relation gives the ratio of the magnitude and phase of the impedance near resonance to that at resonance in terms of the parameter  $X$ . Hence, the phase angle  $\theta$  is given by

$$\theta = -\tan^{-1} X,$$

and the magnitude by

$$|Z| = \frac{1}{(1 + X^2)^{\frac{1}{2}}}.$$

Graphical representations of  $|Z|$  and  $\theta$  as functions of  $X$  give the standard resonance curves for the relative magnitude and phase angle of an impedance near resonance. Our inter-



Figure 1—Parallel-resonant circuit as is used in an off-resonance discriminator.

est is in the section of the impedance curve near resonance having the most linear impedance-to-frequency characteristic, i.e.,

$$\frac{d|Z|}{d\omega} = K \frac{d|Z|}{d\Delta\omega} = K \frac{d|Z|}{dX} \approx \text{constant},$$

$$\frac{d|Z|}{dX} = \frac{-X}{(1 + X^2)^{\frac{3}{2}}},$$

$$\frac{d^2|Z|}{dX^2} = \frac{2X^2 - 1}{(1 + X^2)^{\frac{5}{2}}} = 0,$$

$$\therefore X = \pm \frac{1}{2^{\frac{1}{2}}} = \pm 0.707$$

for maximum slope. The value of the relative impedance at this point is then

$$|Z| = \frac{|Z_1|}{|Z_0|} = \frac{1}{(1+\frac{1}{2})^{\frac{1}{2}}} = 0.816.$$

Figure 2 gives a plot of  $d|Z|/dX$  as a function of  $X$  over a wide range of values. Figure 3 gives the curve around the point  $X=0.707$ . We are interested in Figure 3 in the region where  $\Delta X < 0.2$  and  $\Delta X = X - 0.707$ .

To determine the linearity of the impedance function  $|Z|$  around the point of maximum slope,  $X=0.707$ , we use Taylor's expansion;

$$|Z| = \frac{1}{(1+X^2)^{\frac{1}{2}}} = f(0.707) + f'(0.707)\Delta X + \frac{f''(0.707)}{2!}(\Delta X)^2 + R_n,$$

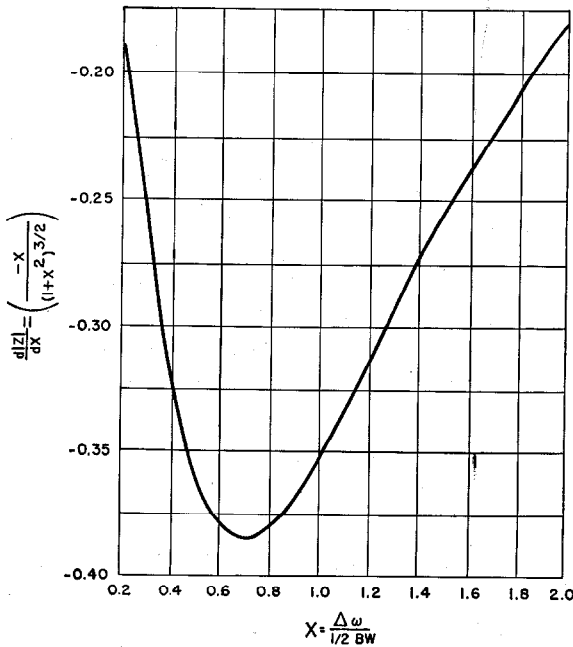

Figure 2— $d|Z|/dX$  plotted against  $X$ .

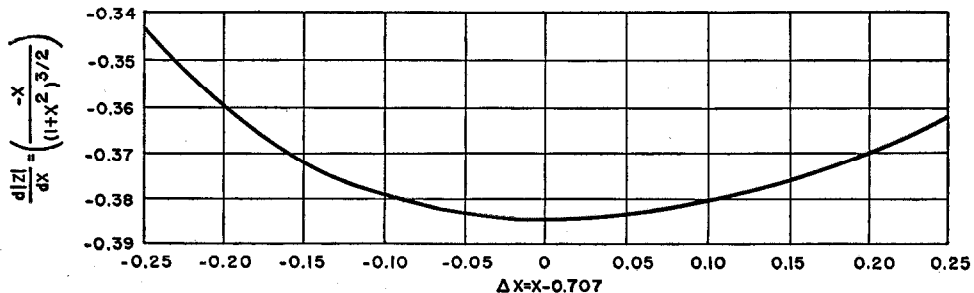

Figure 3—Curve of Figure 2 around the point where  $X = 0.707$ .

noting that  $f''(0.707) = 0$ . The fractional deviation from linearity is found as follows (Figure 4):

The incremental change in impedance is

$$\Delta|Z| = f(X) - f(a)$$

and for  $a = 0.707$

$$= \left[ f'(a) + \frac{f''(a)(\Delta X)^2}{6} \right] \Delta X + R_n.$$

For the linear case, the differential change would be

$$d|Z| = f'(a)\Delta X.$$

The fractional deviation is then

$$\frac{\Delta|Z| - d|Z|}{d|Z|} = \frac{\left[ f'(a) + \frac{f''(a)(\Delta X)^2}{6} \right] \Delta X - f'(a)\Delta X + R_n}{f'(a)\Delta X} = \frac{\left[ \frac{f''(a)(\Delta X)^3}{6} \right] + R_n}{f'(a)\Delta X}.$$

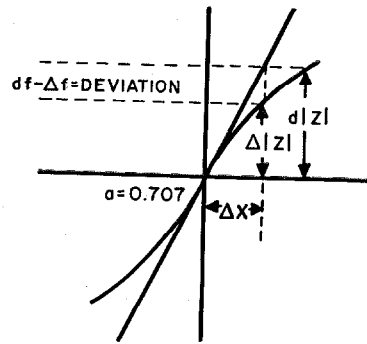

Figure 4—Deviation from linearity around the point of maximum slope,  $X = 0.707$ .

The part of the fractional deviation from linearity due to the third-order term becomes

$$\frac{f'''(a)(\Delta X)^2}{6f'(a)}$$

For  $a=0.707$ ,  $f'(a)=-0.386$ , and  $f'''(a)=1.025$ , the percentage of deviation from linearity equals

$$-44(\Delta X)^2$$

The curve for percentage of deviation from linearity due to the third-order term as a function of  $\Delta X$  is shown in Figure 5. The effect of the remainder term  $R_n$  is computed in Appendix 2, and the maximum total deviation from linearity is shown in Figure 6. The effect of the remainder is negligible.

The preceding has been derived on the basis of a displacement  $X$  half bandwidths from the resonant point. Let us again take  $X=0.707$  as the operating point. The maximum variation from  $X=0.707$  will be denoted by  $\delta X$ . Then  $\delta X$  corresponds to the maximum frequency deviation  $\delta\omega$ , due to frequency modulation of the carrier  $\omega_1$ :

$$\begin{aligned} \delta X &= X - a = \frac{\Delta\omega - \Delta\omega_1}{\frac{1}{2}BW} \\ &= \frac{\delta\omega}{\frac{1}{2}BW} \end{aligned}$$

The harmonic distortion is given by the ratio of the magnitude of the third harmonic to that of the fundamental; the remainder is negligible. Let  $\Delta X = \delta X \sin \rho t$ , and substitute in the Taylor's series. Then

$$\begin{aligned} f(X) &= f(a) \\ &+ f'(a)\delta X \sin \rho t \\ &+ \frac{f'''(a)}{6}(\delta X)^3 \sin^3 \rho t \\ &+ R_n \end{aligned}$$

Substituting  $\sin^3 \rho t$

$= \frac{1}{4}(3 \sin \rho t - \sin^3 \rho t)$ , and collecting terms,

$$\begin{aligned} f(X) &= f(a) + \left[ f'(a)\delta X + \frac{3}{4} \cdot \frac{f'''(a)(\delta X)^3}{6} \right] \sin \rho t \\ &\quad - \frac{1}{4} \cdot \frac{f'''(a)(\delta X)^3}{6} \sin^3 \rho t + R_n \end{aligned}$$

The third-harmonic distortion is given by

$$\begin{aligned} \frac{-\frac{f'''(a)(\delta X)^3}{24}}{f'(a)\delta X + \frac{3f'''(a)(\delta X)^3}{24}} &= -\frac{f'''(a)(\delta X)^2}{24f'(a) + 3f'''(a)(\delta X)^2} \\ &= \frac{1.025(\delta X)^2}{9.264 - 3.075(\delta X)^2} \end{aligned}$$

The percentage of distortion as a function of  $\delta X$  is plotted in Figure 7.

In conclusion, the deviation from linearity and the distortion resulting at the operating point  $X=0.707$ , can be found by determining  $\delta X$  from the frequency deviation and the half bandwidth of the tuned circuit. As an example, take  $\delta\omega = 2\pi \times 75$  kilocycles, and  $\frac{1}{2}BW = 2.5$  megacycles.

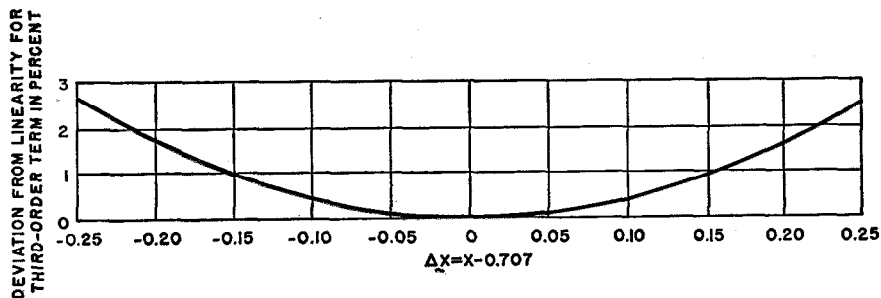

Figure 5—Third-order-term deviation from linearity as a function of  $\Delta X$ .

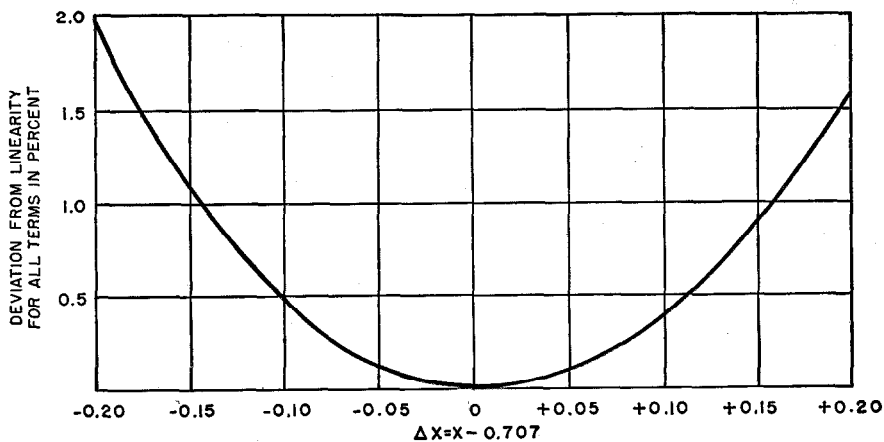

Figure 6—Deviation from linearity for all terms as a function of  $\Delta X$ .

Then,

$$\delta X = \frac{75 \times 10^3}{2.5 \times 10^6} = 0.03.$$

From Figure 7, the distortion for  $\delta X = 0.03$  is 0.02 percent.

The second derivative of the impedance is zero at  $X = 0.707$ . This corresponds to the most linear region of the impedance characteristic, and is the point of minimum distortion. There is no second-harmonic component here, and all distortion is a result of third- and higher-order terms. It is not quite the point of maximum total output, however. Taylor's expansion for  $\Delta X = X - a = \delta X \sin pt$  gives, as the coefficient of the fundamental,

$$f'(a)\delta X,$$

where  $f'(a) = -a/(1+a^2)^{3/2}$ , and as the coefficient of the second harmonic,

$$-\frac{f''(a)(\delta X)^2}{4},$$

where  $f''(a) = (2a^2 - 1)/(1+a^2)^{5/2}$ . Figure 8 shows curves giving the normalized fundamental output, the second-harmonic output, and the arithmetic sum of these two as a function of the operating point  $a$  for fixed frequency deviations of  $\delta X = 0.1, 0.2,$  and  $0.4$ . It is obvious from these curves that the location on the discriminator curve corresponding to minimum distortion does not correspond to the point of maximum output.

Minimum distortion is located in the region between the two output peaks.

The general behavior can be understood from Figure 9, where the slopes of the coefficients of the fundamental and second harmonic have been plotted as a function of the parameter  $a$ . The slope of the fundamental is zero at  $a = 0.707$ , but

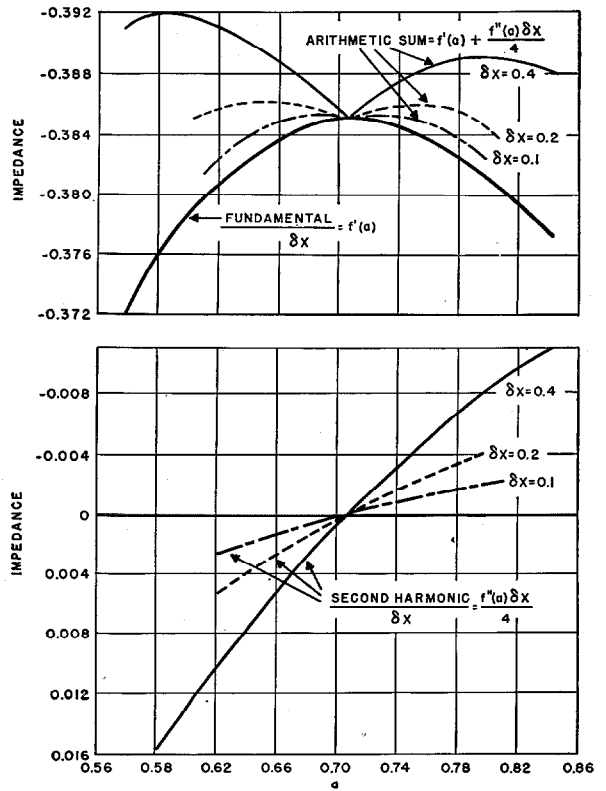

Figure 8—Lower graph, second-harmonic distortion as a function of  $a$ . Upper graph, the heavy line shows the normalized fundamental output as a function of  $a$ , and the lighter lines the arithmetic sum of the fundamental plus second-harmonic outputs.

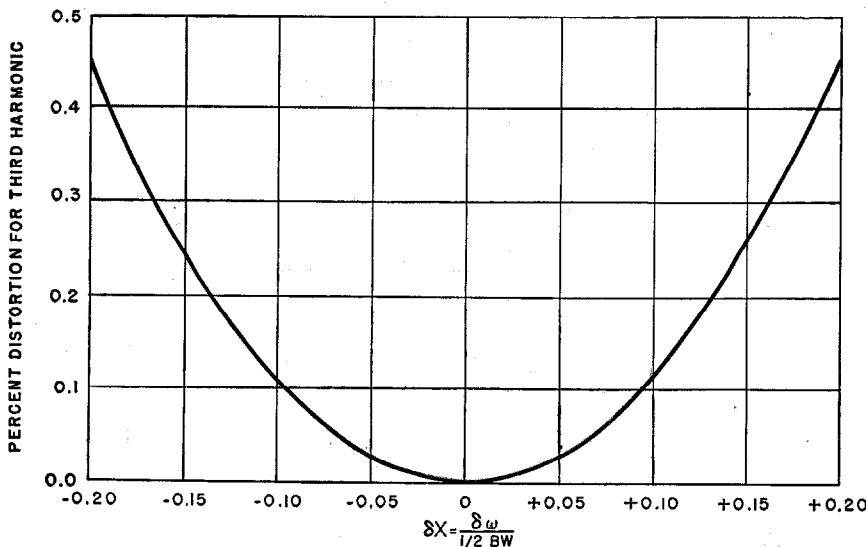

Figure 7—Third-harmonic distortion as a function of  $\delta X$ .

that of the second harmonic is finite, i.e.,

$$\frac{d}{da} \left( \frac{f''(a)\delta X}{4} \right) = 0.051.$$

There is then a region around the operating point where the added second harmonic is greater than the reduction of the fundamental. Thus, a double hump may occur around the point of minimum distortion. The smaller  $\delta X$  is, the closer these humps are together.

Only the case of the existence of the fundamental and second harmonic was considered above. In Figure 10, the result of the addition of the second and third harmonics to the fundamental is given. Again we see the existence of double humps about the point of minimum distortion. The addition of the third-order term in the power series results in an increase of the fundamental by

$$\frac{f'''(a)(\delta X)^3}{8},$$

where  $f'''(a) = (9a - 6a^3)/(1+a^2)^{7/2}$ . The fundamental still maximizes at  $a=0.707$ . The coefficient of the third harmonic equals

$$-\frac{f'''(a)(\delta X)^3}{24}.$$

The arithmetic sum is not appreciably altered by

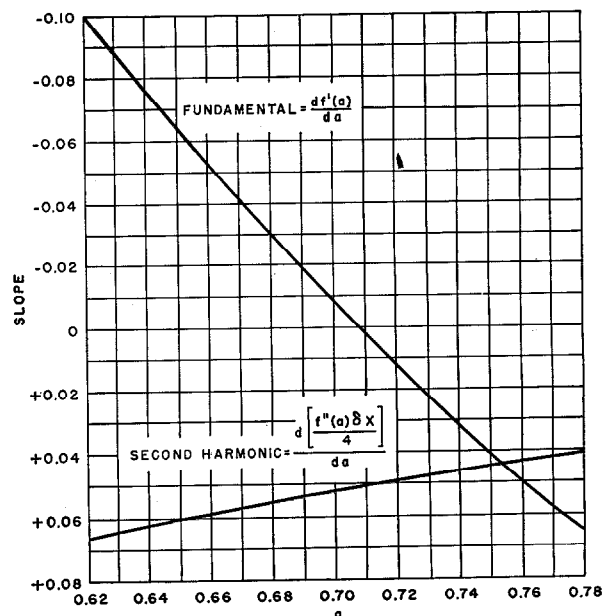

Figure 9—Slopes of the coefficients of fundamental and second harmonic plotted against  $a$ , where  $\delta X = 0.2$ .

the addition of the third harmonic, and the higher-order terms become negligible.

If harmonics of the carrier frequency are present, as will be the case when the discriminator is preceded by limiters, the modulation present in

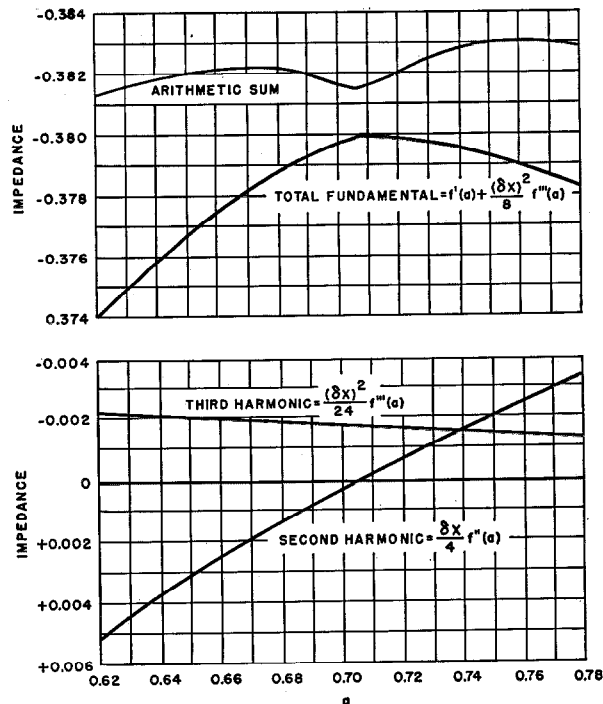

Figure 10—Lower graph, second- and third-harmonic outputs plotted against  $a$ . Upper chart, the total fundamental and the arithmetic sum of harmonics and fundamental are plotted against  $a$ . In each case,  $\delta X = 0.2$ .

the carrier harmonics will also be detected. If the circuit  $Q$  is low, second harmonics of the modulating frequency may appear in the output.

The above study has been based on the introduction of a pure fundamental modulating frequency  $\rho$ . The effect of a wave having harmonic components of the modulating frequency can be considered in terms of the effect of the fundamental and the harmonics separately. The fundamental produces the effects noted above. The harmonics would produce second and higher harmonics. Therefore, at the operating point  $X=0.707$ , there will be present a second harmonic resulting from the harmonic input. The magnitude of this second harmonic will be essentially constant over the tuning range of the resonant circuit. At some point on the resonance curve, the second harmonic resulting from the harmonic input may cancel the second harmonic

resulting from the nonlinearity of the resonance curve. At this point, the distortion would appear to be at a minimum and may lead to an incorrect interpretation of the distortion being measured.

### Appendix 1

The derivation of the impedance relationship in a parallel resonant circuit (Figure 11) is as follows:

$$Z_1 = \frac{RX_L X_C}{RX_L + RX_C + X_L X_C},$$

$$\frac{Z_1}{R} = \frac{L/C}{j\omega LR + \frac{R}{j\omega C} + \frac{L}{C}}$$

$$= \frac{1}{1 + j\left(R\omega C - \frac{R}{\omega L}\right)}$$

Let  $\lambda = (\omega - \omega_0)/\omega_0$ , or  $\omega = \omega_0(1 + \lambda)$ ;

$$\frac{Z_1}{R} = \frac{1}{1 + j\left[\omega_0(1 + \lambda)RC - \frac{R}{\omega_0(1 + \lambda)L}\right]}$$

$$= \frac{1}{1 + j\left[Q(1 + \lambda) - \frac{Q}{(1 + \lambda)}\right]},$$

where  $Q = R/\omega_0 L = R\omega_0 C$ .

$$\frac{Z_1}{R} = \frac{1}{1 + jQ\left[\frac{(1 + \lambda)^2 - 1}{(1 + \lambda)}\right]}$$

$$= \frac{1}{1 + j\lambda Q\left(\frac{2 + \lambda}{1 + \lambda}\right)},$$

$$\approx \frac{1}{1 + 2j\lambda Q}.$$



Figure 11—Parallel-resonant circuit.

### Appendix 2

The remainder of the Taylor's series, after the third term, is given by

$$R_4 = \frac{f^{IV}(\xi)}{4!}(X - a)^4,$$

where  $\xi = a + \eta(X - a)$ ,  $0 < \eta < 1$ . Let  $\eta = 1$ . Then  $R_n$  will always be less than the calculated value.

$$f^{IV}(X) = \frac{24X^4 - 72X^2 + 9}{(1 + X^2)^{9/2}}.$$

Substituting  $\xi = (0.707 + \Delta X)$  for  $X$ , we have

$$f^{IV}(\xi) = \frac{24(0.707 + \Delta X)^4 - 72(0.707 + \Delta X)^2 + 9}{[1 + (0.707 + \Delta X)^2]^{9/2}}.$$

Then the remainder becomes

$$R = \frac{[24(0.707 + \Delta X)^4 - 72(0.707 + \Delta X)^2 + 9][\Delta X]^4}{4![1 + (0.707 + \Delta X)^2]^{9/2}}.$$

The deviation from linearity due to the remainder is then

$$\frac{R}{f'(a)\Delta X} = \frac{[24(0.707 + \Delta X)^4 - 72(0.707 + \Delta X)^2 + 9](\Delta X)^3}{(0.386)(4!)[1 + (0.707 + \Delta X)^2]^{9/2}}.$$

### Appendix 3

The derivatives of  $|Z| = f(X)$  are as follows:

$$|Z| = (1 + X^2)^{-1/2}$$

$$\frac{d|Z|}{dX} = f'(X) = \frac{-X}{(1 + X^2)^{3/2}}$$

$$f'(0.707) = -0.386.$$

$$\frac{d^2|Z|}{dX^2} = f''(X) = \frac{2X^2 - 1}{(1 + X^2)^{5/2}}$$

$$f''(0.707) = 0.$$

$$\frac{d^3|Z|}{dX^3} = f'''(X) = \frac{-6X^3 + 9X}{(1 + X^2)^{7/2}}$$

$$f'''(0.707) = 1.025.$$

$$\frac{d^4|Z|}{dX^4} = f^{IV}(X) = \frac{24X^4 - 72X^2 + 9}{(1 + X^2)^{9/2}}.$$

# Application of Negative Feedback to Frequency-Modulation Systems

By P. F. PANTER and W. DITE

*Federal Telecommunication Laboratories, Incorporated, Nutley, New Jersey*

A GENERAL feedback formula is developed and applied to the reduction of distortion in frequency-modulation systems. For a transmitter, feedback will reduce distortion provided a limiter is used in the feedback path to take care of any variation of output with frequency. For a receiver, a limiter is required before the discriminator to obtain constant output independent of rapid variations in the input signal. The use of inverse feedback has the advantage of reducing the required bandwidth of the intermediate-frequency amplifier without sacrificing the advantage of wideband frequency modulation.

## 1. Transmitters

An advantage of applying inverse feedback is the reduction of nonlinear distortion products generated within the system. The general feedback formula developed, is applied to the problem of reducing distortion products generated in a frequency-modulation transmitter. It is shown that inclusion of a limiter in the feedback loop is essential for the linearization of the frequency modulation when the amplitude varies with frequency. This is illustrated by a numerical example using the experimental curves of amplitude and frequency versus repeller voltage for a 2K22 klystron.

### 1.1 GENERAL FEEDBACK FORMULA

Let the input-output characteristic of a nonlinear network be given by

$$e_o = \mu_1 e_s + \mu_2 e_s^2 + \mu_3 e_s^3 + \dots, \quad (1)$$

where  $e_s$  = effective input voltage,  
 $e_o$  = output voltage,  
 $\mu$  = voltage gain of network.

In Figure 1, let  $e$  be the applied voltage. Then

$$e_s = e - \beta e_o, \quad (2)$$

where  $\beta$  is the fraction of the output voltage fed back to the input.

Substituting (2) in (1) gives

$$e_s = e - \mu_1 \beta e_s - \mu_2 \beta e_s^2 - \mu_3 \beta e_s^3 - \dots \quad (3)$$

or

$$e_s = \frac{e}{1 + \mu_1 \beta} - \frac{\mu_2 \beta}{1 + \mu_1 \beta} e_s^2 - \frac{\mu_3 \beta}{1 + \mu_1 \beta} e_s^3 - \dots \quad (4)$$

This may be written in the form

$$e_s = a + t \phi(e_s), \quad (5)$$

where

$$\left. \begin{aligned} a &= \frac{e}{1 + \mu_1 \beta}, \\ t &= \frac{-\beta}{1 + \mu_1 \beta}, \\ \phi(e_s) &= \mu_2 e_s^2 + \mu_3 e_s^3 + \dots \end{aligned} \right\} \quad (6)$$

We may apply Lagrange's formula, which gives

$$f(e_s) = f(a) + \sum_{n=1}^{\infty} \frac{t^n}{n!} \frac{d^{n-1}}{da^{n-1}} [f'(a) \phi(a)^n], \quad (7)$$

where  $f(e_s)$  is a function of  $e_s$ . Letting  $f(e_s) = e_s$

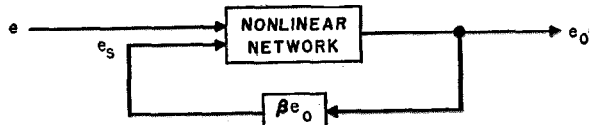

Figure 1.

and limiting ourselves to terms of the third degree, the feedback voltage  $e_s$  becomes

$$e_s = \frac{e}{1 + \mu_1 \beta} - \frac{\mu_2 \beta e^2}{(1 + \mu_1 \beta)^2} - \left( \frac{\mu_3 \beta}{(1 + \mu_1 \beta)^4} - \frac{2\mu_2^2 \beta^2}{(1 + \mu_1 \beta)^5} \right) e^3 - \dots \quad (8)$$

Since  $e_s = e - \beta e_o$ , we have from (8),

$$e_o = \frac{\mu_1 e}{1 + \mu_1 \beta} + \frac{\mu_2 e^2}{(1 + \mu_1 \beta)^3} + \left( \frac{\mu_3}{(1 + \mu_1 \beta)^4} - \frac{2\mu_2^2 \beta}{(1 + \mu_1 \beta)^5} \right) e^3 + \dots \quad (9)$$

Comparing the linear coefficients of (1) and (9), we see that the gain has been reduced by the factor  $1/(1+\mu_1\beta)$ . To restore the output to its level without feedback, the input voltage must be increased by the factor  $1+\mu_1\beta$ . When this is done, (9) becomes

$$e_o = \mu_1 e + \frac{\mu_2 e^2}{1+\mu_1\beta} + \left( \frac{\mu_3}{1+\mu_1\beta} - \frac{2\mu_2^2\beta}{(1+\mu_1\beta)^2} \right) e^3 + \dots \quad (10)$$

This is the basic feedback formula that will be used in the following analysis.

### 1.2 NEGATIVE FEEDBACK APPLIED TO A FREQUENCY-MODULATED TRANSMITTER—LIMITER IN FEEDBACK LOOP

The results derived above will be applied to the frequency-modulated transmitter shown in Figure 2, where a limiter is included in the feedback loop.

The output of the transmitter, with  $e_s$  being the effective modulating voltage, is

$$e_o = A(t) \exp \left[ j \int \Omega dt \right], \quad (11)$$

where

$$A(t) = A_o(1 + \lambda_1 e_s + \lambda_2 e_s^2 + \lambda_3 e_s^3) \quad (12)$$

and

$$\Omega(t) = \omega_o(1 + \mu_1 e_s + \mu_2 e_s^2 + \mu_3 e_s^3). \quad (13)$$

The limiter will be assumed to be ideal, so that

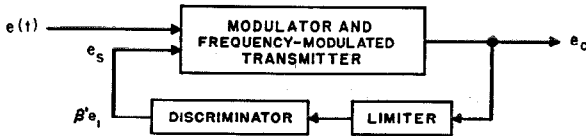

Figure 2.

the output of the discriminator is proportional to instantaneous frequency  $\Omega(t)$  and independent of the amplitude  $A(t)$ .

The output of the discriminator is

$$e_1 = D\omega_o(\mu_1 e_s + \mu_2 e_s^2 + \mu_3 e_s^3), \quad (14)$$

where  $D$  is a proportionality factor. If a fraction  $\beta'$  of the output of the discriminator is fed back, then

$$e_s = e - \beta' e_1 = e - \beta' D\omega_o(\mu_1 e_s + \mu_2 e_s^2 + \mu_3 e_s^3). \quad (15)$$

Letting  $\beta = \beta'\omega_o D$ , we have

$$e_s = \frac{e}{1+\mu_1\beta} - \frac{\mu_2\beta e_s^2}{1+\mu_1\beta} - \frac{\mu_3\beta e_s^3}{1+\mu_1\beta},$$

which is of the same form as (4). Using (10), we find that the output instantaneous frequency is

$$\Omega = \omega_o \left[ 1 + \mu_1 e + \frac{\mu_2 e^2}{1+\mu_1\beta} + \left( \frac{\mu_3}{1+\mu_1\beta} - \frac{2\mu_2^2}{(1+\mu_1\beta)^2} \right) e^3 \right]. \quad (16)$$

Thus the output frequency can be made very nearly linear by increasing  $\beta$ . Remembering that the input voltage has been increased by a factor  $1+\mu_1\beta$ , so that the feedback voltage from (16) is

$$\beta' e_1 = \mu_1 \beta e + \frac{\mu_2 \beta e^2}{1+\mu_1\beta} + \left( \frac{\mu_3 \beta}{1+\mu_1\beta} - \frac{2\mu_2^2 \beta^2}{(1+\mu_1\beta)^2} \right) e^3.$$

The effective applied voltage is

$$e_s = e - \frac{\mu_2 \beta e^2}{1+\mu_1\beta} - \left( \frac{\mu_3 \beta}{1+\mu_1\beta} - \frac{2\mu_2^2 \beta^2}{(1+\mu_1\beta)^2} \right) e^3. \quad (17)$$

Equation (17) will now be used to evaluate the effect of negative feedback on the amplitude  $A(t)$ .

From (12), we have

$$\begin{aligned} A(t) &= A_o(1 + \lambda_1 e_s + \lambda_2 e_s^2 + \lambda_3 e_s^3) \\ &= A_o \left[ 1 + \lambda_1 e + \left( \lambda_2 - \lambda_1 \frac{\mu_2 \beta}{1+\mu_1\beta} \right) e^2 \right. \\ &\quad \left. + \left( \lambda_3 - 2\lambda_2 \frac{\mu_2 \beta}{1+\mu_1\beta} - \frac{\lambda_1 \mu_3 \beta}{1+\mu_1\beta} + \frac{2\lambda_1 \mu_2^2 \beta^2}{(1+\mu_1\beta)^2} \right) e^3 \right]. \end{aligned} \quad (18)$$

For  $\mu_1\beta \gg 1$ , this reduces to

$$\begin{aligned} A(t) &= A_o \left\{ 1 + \lambda_1 e + \left( \lambda_2 - \lambda_1 \frac{\mu_2}{\mu_1} \right) e^2 \right. \\ &\quad \left. + \left[ \lambda_3 - 2\lambda_2 \frac{\mu_2}{\mu_1} - \lambda_1 \frac{\mu_3}{\mu_1} + 2\lambda_1 \left( \frac{\mu_2}{\mu_1} \right)^2 \right] e^3 \right\}. \end{aligned} \quad (19)$$

It is seen that the linear term is unaffected by feedback. As  $\mu_1 \gg \mu_2$  and  $\mu_1 \gg \mu_3$ , the higher terms are virtually unaffected by feedback. Thus, feedback of the type shown in Figure 2 will linearize the frequency modulation but will not minimize the nonlinearity in amplitude modulation.

### 1.3 FEEDBACK APPLIED TO TRANSMITTER—LIMITER OMITTED FROM FEEDBACK LOOP

The effect of omitting the limiter in the feedback path will now be considered. Assuming that



the discriminator acts as an ideal differentiator followed by a linear rectifier, the discriminator output is

$$e_D = D[A'(t)^2 + A(t)^2\Omega(t)^2]^{\frac{1}{2}} \quad (20)$$

As  $A(t)\Omega(t) \gg A'(t)$ , we have, to a first approximation,

$$e_D = DA(t)\Omega(t) = DA_o\omega_o(1 + \lambda_1 e_s + \lambda_2 e_s^2 + \lambda_3 e_s^3) \times (1 + \mu_1 e_s + \mu_2 e_s^2 + \mu_3 e_s^3).$$

The variable portion of the discriminator output is

$$e_1 = DA_o\omega_o[(\mu_1 + \lambda_1)e_s + (\mu_2 + \mu_1\lambda_1 + \lambda_2)e_s^2 + (\mu_3 + \mu_2\lambda_1 + \mu_1\lambda_2 + \lambda_3)e_s^3]. \quad (21)$$

A fraction  $\beta'$  is fed back to the input and

$$e_s = e - \beta'e = e - \beta'DA_o\omega_o[(\mu_1 + \lambda_1)e_s + (\mu_2 + \mu_1\lambda_1 + \lambda_2)e_s^2 + (\mu_3 + \mu_2\lambda_1 + \mu_1\lambda_2 + \lambda_3)e_s^3].$$

Put  $\beta'DA_o\omega_o = \beta$

$$\begin{aligned} \therefore e_s + \beta(\mu_1 + \lambda_1)e_s &= e - \beta(\mu_2 + \mu_1\lambda_1 + \lambda_2)e_s^2 - \beta(\mu_3 + \mu_2\lambda_1 + \mu_1\lambda_2 + \lambda_3)e_s^3, \\ \therefore e_s &= \frac{e}{1 + \beta(\mu_1 + \lambda_1)} - \frac{\beta(\mu_2 + \mu_1\lambda_1 + \lambda_2)}{1 + \beta(\mu_1 + \lambda_1)}e_s^2 - \frac{\beta(\mu_3 + \mu_2\lambda_1 + \mu_1\lambda_2 + \lambda_3)}{1 + \beta(\mu_1 + \lambda_1)}e_s^3. \end{aligned} \quad (22)$$

By analogy with (4), we have, using (8),

$$e_o = \frac{e}{1 + \beta(\mu_1 + \lambda_1)} - \frac{\beta(\mu_2 + \mu_1\lambda_1 + \lambda_2)}{[1 + \beta(\mu_1 + \lambda_1)]^3}e_s^2 - \left[ \frac{\beta(\mu_3 + \mu_2\lambda_1 + \mu_1\lambda_2 + \lambda_3)}{[1 + \beta(\mu_1 + \lambda_1)]^4} - \frac{2\beta^2(\mu_2 + \mu_1\lambda_1 + \lambda_2)^2}{[1 + \beta(\mu_1 + \lambda_1)]^5} \right]e_s^3. \quad (23)$$

Finally, the instantaneous frequency is

$$\Omega = \omega_o \left( 1 + \mu_1 e + \frac{\mu_2(1 + \lambda_1\beta) - \mu_1\beta(\lambda_2 + \mu_1\lambda_1)}{1 + (\mu_1 + \lambda_1)\beta} e^2 + \dots \right), \quad (24)$$

where now the input signal has been increased by a factor  $1 + (\mu_1 + \lambda_1)\beta$ .

Due to the complexity of the distortion terms, it is difficult to judge whether or not the distortion has been decreased by feedback.

#### 1.4 NUMERICAL EXAMPLES

The amplitude and frequency change of a 2K22 klystron have been plotted against frequency in Figure 3. Letting  $e_s$  be the variation of the repeller voltage about an operating point, we find

$$\Omega = +2\pi \times 5186.1(1 + 1.28 \times 10^{-4} - 2.31 \times 10^{-6}e_s^2 + 4.05 \times 10^{-7}e_s^3). \quad (25)$$

$$A = 1 + 6.09 \times 10^{-3}e_s - 1.294 \times 10^{-3}e_s^2 - 2.54 \times 10^{-5}e_s^3, \quad (26)$$

where the center frequency is 5186.1 and  $A$  is the normalized output voltage.

$A = 1$  at the operating point, where  $e_s$  = variation of repeller voltage about the operating point.

In Figure 4, the output frequency is plotted with

Figure 3—Amplitude and frequency change plotted against frequency for a 2K22 klystron.

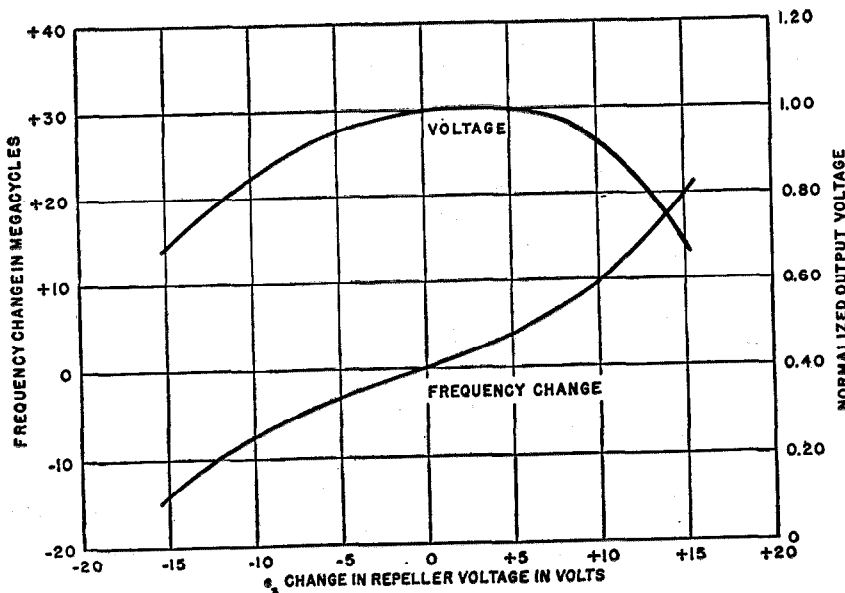

$\mu_1\beta$  as a parameter. The independent variable is taken as  $e/(1+\mu_1\beta)$  to confine the curve in this direction. The curves are readily plotted by noting from (14) that the feedback voltage  $e_f$  is

$$\begin{aligned} e_f &= \beta' D\omega_o(\mu_1 e_s + \mu_2 e_s^2 + \mu_3 e_s^3) \\ &= \beta[\mu_1(e - e_f) + \mu_2(e - e_f)^2 + \mu_3(e - e_f)^3], \end{aligned}$$

where  $e$  is the signal voltage applied to the repeller.

If we now assume values for  $e - e_f$  and  $\beta$ , and substitute in the right-hand side, we obtain  $e_f$ . Since  $e_f$  and  $e - e_f$  are now known, we obtain the input  $e$ .

As the polynomial on the left is known, the calculation for various values of  $\mu_1\beta$  is simple. As the voltage  $e - e_f$  uniquely determines both amplitude and frequency change, it may be stated that for the same frequency change the amplitude is the same. The curve of amplitude versus repeller voltage becomes flatter, but the amplitude modulation becomes flatter.

When no limiter is used in the feedback path, (24) is easy to apply and gives for large values of  $\beta$

$$\Omega = 2\pi(5186.1)(1 + 1.28 \times 10^{-4} e_s + 2.7 \times 10^{-5} e_s^2 + \dots). \quad (27)$$

Comparing (25) and (27), we see that with feedback the coefficient of  $e_s^2$  is over 10 times larger than without feedback. Hence there is no advantage resulting from feedback unless a limiter is used. The limiter need not be perfect, provided it is good enough to make the limited values of  $\lambda_1, \lambda_2, \lambda_3$  substantially smaller than  $\mu_1, \mu_2, \mu_3$ .

## 2. Receivers

It is well known that the use of a large modulation index considerably increases the advantages of frequency over amplitude modulation but imposes severe bandwidth requirements on the intermediate-frequency amplifiers for comparable

distortion. As has been shown by Carson<sup>1</sup> and Chaffee,<sup>2</sup> the use of negative feedback allows a reduction in the bandwidth while preserving the advantages of a high modulation index. This method, known as frequency-following, is reviewed. Earlier workers<sup>1-3</sup> concluded that the output of the receiver is independent of the input amplitude when the negative feedback is great enough. It is shown in what follows that this con-

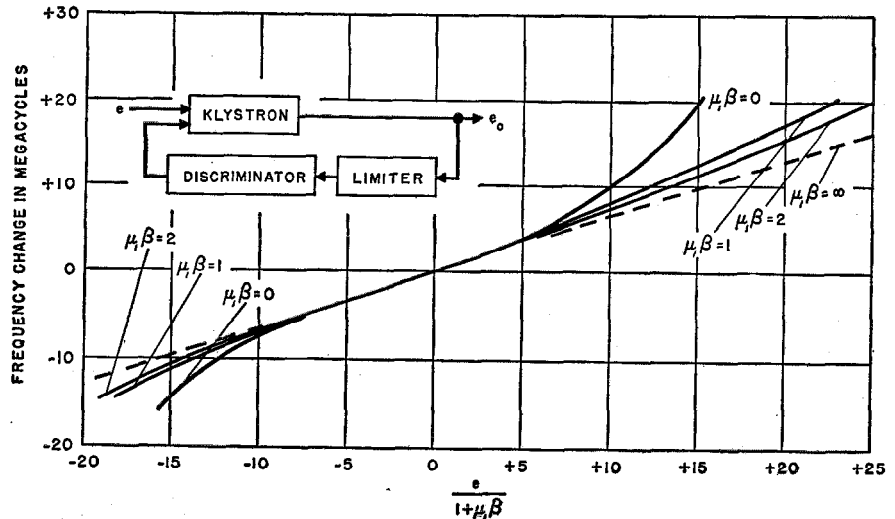

Figure 4—Frequency change plotted against repeller voltage with  $\mu_1\beta$  as a parameter; limiter in feedback loop.

clusion is correct if the amplitude varies at a sufficiently slow rate. In the general case of a signal that is both amplitude and frequency modulated, a limiter is required to secure an output independent of the amplitude modulation of the input.

## 2.1 REVIEW OF FREQUENCY-FOLLOWING

In the circuit of Figure 5, the output of the discriminator is used to modulate the frequency of the local oscillator and to cause it to follow the frequency of the incoming signal. It will be assumed that as the frequency of the local oscillator varies, its amplitude remains constant.

<sup>1</sup> J. R. Carson, "Frequency-Modulation: Theory of the Feedback Receiving Circuit," *Bell System Technical Journal*, v. 18, pp. 395-403; July, 1939.

<sup>2</sup> J. A. Chaffee, "The Application of Negative Feedback to Frequency-Modulation Systems," *Bell System Technical Journal*, v. 18, pp. 404-437; July, 1939.

<sup>3</sup> D. A. Bell, "Reduction of Bandwidth in F. M. Receivers," *Wireless Engineer*, v. 19, pp. 497-502; November, 1942.

Let the instantaneous angular velocity of the received signal be

$$\Omega = \omega_o + \Delta\omega \sin pt, \quad (28)$$

where  $\Delta\omega$  = maximum deviation,  
 $\omega_o$  = carrier angular velocity,  
 $p$  = audio angular velocity.

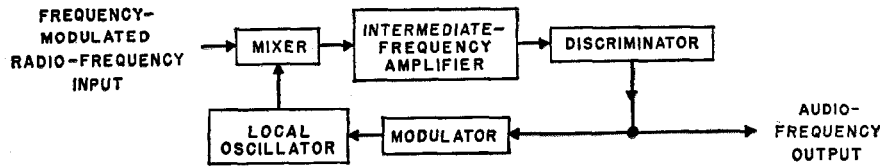

Figure 5.

If  $V$  is the output voltage of the discriminator, let  $\mu V$  be the change produced in angular velocity of the local oscillator. The corresponding angular velocity of the intermediate frequency is  $\omega_1 + \Delta\omega \sin pt - \mu V$ . Assuming a linear discriminator, the variable portion of the output is

$$V = DE(\Delta\omega \sin pt - \mu V), \quad (29)$$

where

$E$  = input amplitude (assumed constant),  
 $D$  = discriminator constant.

Solving this relation of  $V$  gives

$$\left. \begin{aligned} V &= \frac{DE}{1 + \mu DE} \times \Delta\omega \sin pt \\ &\doteq \frac{\Delta\omega}{\mu} \sin pt \end{aligned} \right\} \quad (30)$$

when  $\mu DE \gg 1$ . Thus, the effective index of modulation has been reduced. The intermediate-frequency bandwidth may be reduced to accept only one pair of sidebands of the frequency-modulated wave. The output is apparently independent of the input signal amplitude. As is shown in the next section, this statement is true if the changes of amplitude are slow.

## 2.2 SIMULTANEOUS FREQUENCY AND AMPLITUDE MODULATION

The input signal may be taken as

$$e(t) = A(t) \exp \left[ j \left( \omega_o t + \Delta\omega \int_0^t \sin ptdt \right) \right]. \quad (31)$$

Hence the intermediate-frequency signal is proportional to

$$\begin{aligned} A(t) \exp \left\{ j \left[ \omega_1 t + \int_0^t (\Delta\omega \sin pt - \mu V) dt \right] \right\} \\ = A(t) \exp \left[ j \int \Omega dt \right]. \end{aligned} \quad (32)$$

Now it is well known that the output of a network of steady-state admittance  $Y(j\omega)$  that has an impressed signal

$$A(t) \exp \left[ j \int \Omega dt \right]$$

is of the form

$$\exp \left[ j \int \Omega dt \right] \left[ A(t) Y(j\Omega) + \frac{dA}{dt} \cdot \frac{dY(j\Omega)}{d(j\Omega)} \right]. \quad (33)$$

For a general linear discriminator, we may write

$$Y(j\omega) = \alpha(\omega - \omega_1) + \beta$$

$$\therefore Y(j\omega_1) = \beta$$

or

$$\begin{aligned} Y(j\Omega) &= \alpha(\Omega - \omega_1) + Y(j\omega_1) \\ &= \alpha(\Delta\omega \sin pt - \mu V) + Y(j\omega_1). \end{aligned} \quad (34)$$

For a linear discriminator passing through the origin as in the case of an ordinary inductance used as a discriminator

$$\beta = Y(j\omega_1) = \alpha\omega_1$$

and

$$Y(j\Omega) = \alpha[\omega_1 + \Delta\omega \sin pt - \mu V].$$

In this special case, the discriminator acts as a pure differentiator of the applied signal and its output becomes

$$\exp \left[ j \int \Omega dt \right] \left[ A(t) \cdot \alpha\Omega + \frac{dA}{dt} \cdot \frac{\alpha}{j} \right],$$

which is proportional to

$$\frac{d}{dt} \left\{ A(t) \exp \left[ j \int \Omega dt \right] \right\}.$$

However, the output of the general linear discriminator that does not pass through the origin

may be expressed in the form

$$\begin{aligned} \exp \left[ j \int \Omega dt \right] & \left\{ A(t) [\alpha(\Delta\omega \sin pt - \mu V) \right. \\ & \left. + Y(j\omega_1)] - j\alpha \frac{dA(t)}{dt} \right\} \\ & = \alpha \exp \left[ j \int \Omega dt \right] \\ & \times \left\{ KA(t) \left( 1 + \frac{\Delta\omega \sin pt - \mu V}{\alpha} \right) - jA'(t) \right\}, \end{aligned}$$

where

$$K = \frac{Y(j\omega_1)}{\alpha}.$$

Hence, the detected signal of the discriminator is

$$\begin{aligned} V = D \left[ A'(t)^2 + K^2 A(t)^2 \right. \\ \left. \times \left( 1 + \frac{\Delta\omega \sin pt - \mu V}{K} \right)^2 \right]^{\frac{1}{2}}. \end{aligned} \quad (35)$$

For the sake of simplicity, the special differentiating discriminator will be discussed in the following. Here

$$K = \frac{Y(j\omega_1)}{\alpha} = \omega_1$$

and

$$\begin{aligned} V = D \left[ A'(t)^2 + \omega_1^2 A(t)^2 \right. \\ \left. \times \left( 1 + \frac{\Delta\omega \sin pt - \mu V}{\omega_1} \right)^2 \right]^{\frac{1}{2}}, \end{aligned} \quad (36)$$

which is identical with (20). This equation can be solved by a method of successive approximations. If we assume that the first term under the radical is negligible compared to the second, we obtain

$$V = \frac{DA(t)(\omega_1 + \Delta\omega \sin pt)}{1 + \mu DA(t)}. \quad (37)$$

Thus

$$\Delta\omega \sin pt - \mu V = \frac{\Delta\omega \sin pt - \mu DA(t)\omega_1}{1 + \mu DA(t)}$$

and

$$1 + \frac{\Delta\omega \sin pt - \mu V}{\omega_1} = \frac{\omega_1 + \Delta\omega \sin pt}{\omega_1 [1 + \mu DA(t)]}.$$

Substituting this value in (36), we have

$$V = D \left[ A'(t)^2 + A(t)^2 \left( \frac{\omega_1 + \Delta\omega \sin pt}{1 + \mu DA(t)} \right)^2 \right]^{\frac{1}{2}} \quad (38)$$

$$\begin{aligned} & = \frac{DA(t)(\omega_1 + \Delta\omega \sin pt)}{1 + \mu DA(t)} \\ & \times \left[ 1 + \frac{A'(t)^2}{A(t)^2} \frac{(1 + \mu DA(t))^2}{(\omega_1 + \Delta\omega \sin pt)^2} \right]^{\frac{1}{2}}. \end{aligned} \quad (39)$$

On the assumption that the second term in the radical is small compared to unity, we have

$$\begin{aligned} V = \frac{DA(t)(\omega_1 + \Delta\omega \sin pt)}{1 + \mu DA(t)} \\ \times \left[ 1 + \frac{1}{2} \left( \frac{A'(t)}{A(t)} \frac{1 + \mu DA(t)}{\omega_1 + \Delta\omega \sin pt} \right)^2 \right]. \end{aligned} \quad (40)$$

Now as  $\omega_1 \gg \Delta\omega \sin pt$  and  $\mu DA(t) \gg 1$ , we have

$$V = \frac{1}{\mu} (\omega_1 + \Delta\omega \sin pt) \left[ 1 + \frac{1}{2} \left( A'(t) \cdot \frac{\mu D}{\omega_1} \right)^2 \right]. \quad (41)$$

To have this expression hold, it is necessary that

$$\frac{1}{2} \left( A'(t) \frac{\mu D}{\omega_1} \right)^2 < 1. \quad (42)$$

If we let

$$A(t) = A_o(1 + m \sin pt),$$

then

$$A'(t) = A_o m p \cos pt.$$

The above inequality becomes

$$\frac{1}{2} \left( m p \frac{A_o \mu D}{\omega_1} \right)^2 < 1. \quad (43)$$

If the received signal is obtained from a modulated klystron, the index of amplitude modulation  $m$  is fixed by the frequency swing. If we assume that the quantities  $A_o$ ,  $\mu$ ,  $D$ , and  $\omega_1$  are fixed, there is a definite upper limit to the audio frequency.

### 3. Conclusion

The main conclusion of this paper is that negative feedback may be used to linearize the voltage-frequency characteristic of a transmitter. Negative feedback may also be used in a receiver to reduce the bandwidth of the intermediate-frequency amplifiers. In both cases, an amplitude limiter is required in the feedback loop to take advantage of this action. It is of interest to note that this point was verified by A. G. Clavier and G. Phelizon<sup>4</sup> in work done at the Laboratoire Central de Télécommunications in Paris, France.

<sup>4</sup>A. G. Clavier and G. Phelizon, "Paris-Montmorency 3000-Megacycle Frequency-Modulation Radio Link," *Electrical Communication*, v. 24, pp. 159-169; June, 1947.

## Recent Telecommunication Developments

**R**ADIO PROVIDES COMMUNICATION WITH PRESIDENTIAL TRAIN—Present-day conditions demand that the president of the U.S.A. be in uninterrupted communication with Washington. When the president makes extensive tours of the country by rail, it is necessary to maintain communication with his train at all times.

The Signal Corps selected a pair of 1-kilowatt high-frequency radiotelegraph transmitters for installation on the presidential train. In the photograph, one of these transmitters can be seen on the right immediately behind the soldier. The other is at the left partly obscured by the fre-

quency-shift exciters used with the transmitters.

The complete installation is in a combination coach and baggage car. Radio teleprinter operation with frequency-shift keying is employed. Power for transmitters, receivers, teleprinters, and auxiliary apparatus is provided by electric generators driven by the two diesel engines in the foreground. Antennas are mounted on the roof of the car but do not project beyond seven inches from it.

The transmitters are standard BC-339 units built by Federal Telephone and Radio Corporation for the U.S. Signal Corps (Federal type 180).

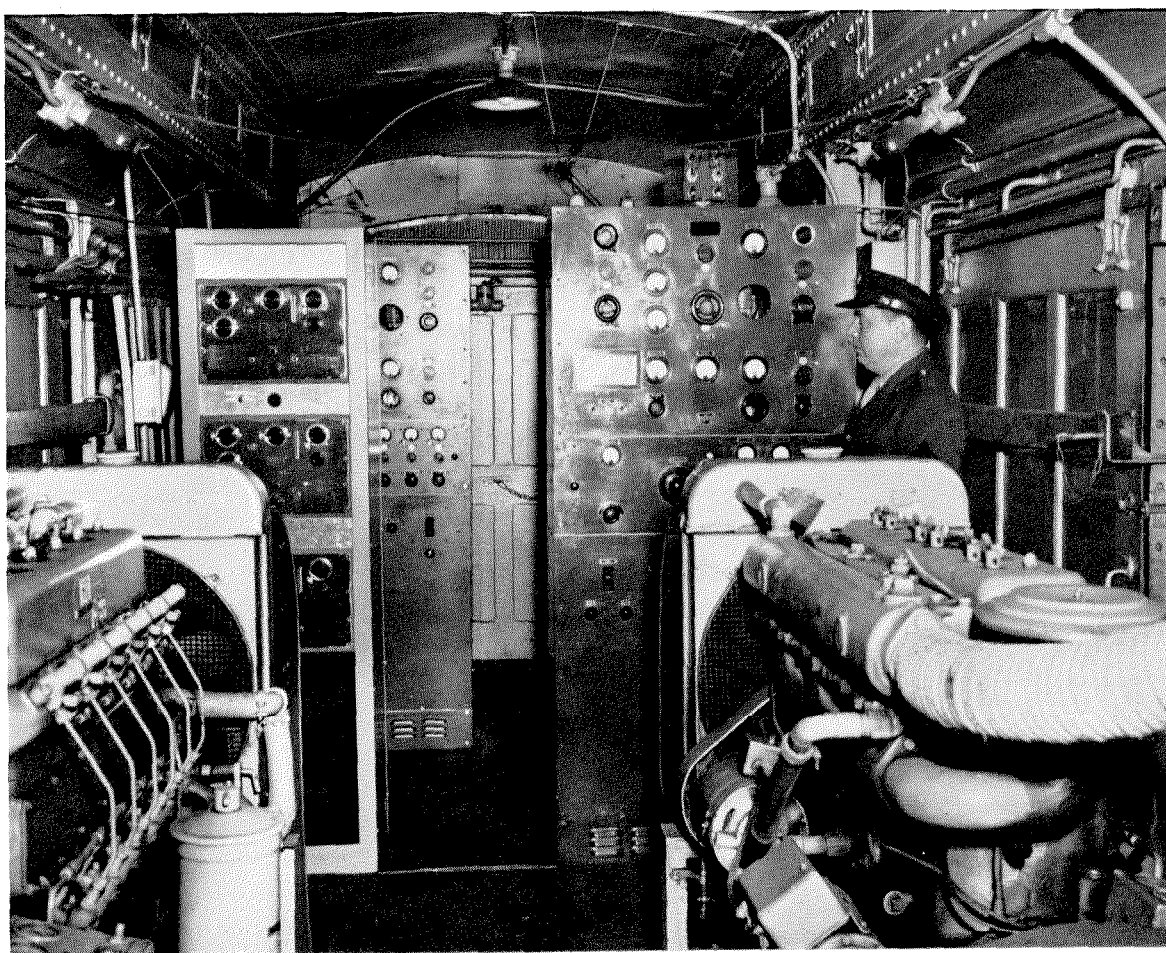

**F**ARNSWORTH CORPORATION ENTERS I. T. & T. SYSTEM—The stockholders of Farnsworth Television and Radio Corporation approved the acquisition of the assets of that organization by the International Telephone and Telegraph Corporation. A new company, Capehart-Farnsworth Corporation, has acquired these assets and is a

wholly owned subsidiary of the International Telephone and Telegraph Corporation. Immediate steps are being taken to put the new company into full production and to maintain and strengthen the existing dealer and distributor organization.

### Elements in the Design of Conventional Filters

Addendum to Volume 26, Pages 84–98; March, 1949.

On page 84, it is mentioned that the graphical calculation of attenuation and phase by means of templates was developed by T. Laurent and E. Rumpelt.

Professor Laurent of the Royal Institute of Technology, Stockholm, Sweden, kindly informs us that his first paper<sup>1</sup> on this matter appeared in 1937. Frequency transformations have also been considered by him in later articles, and the subject is extensively discussed in his recent book.<sup>2</sup>

<sup>1</sup> T. Laurent, "Calcul des processus non stationnaires à l'aide des transformations fréquentielles," *Ericsson Technics*, v. 5, n. 4, pp. 59–84; 1937.

<sup>2</sup> T. Laurent, "Fyrpoltheorier och Frekventstransformationer" (Four-pole Theories and Frequency Transformations), Stockholm; 1948.

An article by G. Neovius<sup>3</sup> on the same subject was also referred to by Professor Laurent. Figure 8 of that article, giving the attenuation obtainable with  $n$  filter sections, is identical to Figure 4 of the present paper, but has been obtained by empirical interpolations based on exact solutions for the case  $n = 2^m$  ( $m = 0, 1, 2, \dots$ ). Mr. Neovius was apparently unaware of Cauet's complete solution in terms of elliptic functions. It may be worth pointing out that the possibility of an elementary solution in the case  $n = 2^m$  could be explained by applying Landen's transformation to Cauet's equations.

<sup>3</sup> G. Neovius, "New Methods of Filter Design by means of Frequency Transformations," *Transactions of the Royal Institute of Technology*, Stockholm, n. 3; 1946.

### Design of an Ionization Manometer Tube

Errata, Volume 25, Pages 373–385; December, 1948

Page 377, Table 2: True sensitivity  $S$  is determined by multiplying the apparent sensitivity  $S'$  by the thermal effusion correction factor

$$\left(\frac{460+T}{460+T_g}\right)^{\frac{1}{2}} \left(\frac{460+T_g}{460+68}\right),$$

which approximates  $\left(\frac{460+T}{460+71}\right)^{\frac{1}{2}}$ ,

not  $\left(\frac{460+71}{460+T}\right)^{\frac{1}{2}}$  as shown.

Page 379, Table 4: In the 150-volt column, the last line should be 4.74 instead of 2.74; in the 300-volt column, change 30.2, 30.5, and 0.9 to 31.3, 29.4, and 7.9, respectively.

## Contributors to This Issue

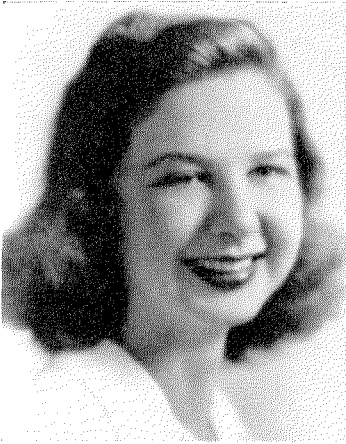

MARILYN S. BUYER

MARILYN STIER BUYER was born on September 1, 1922, at Evanston, Illinois. She received a B.A. degree with honors in mathematics from Wellesley College in 1944. Since then, she has been employed by Federal Telecommunication Laboratories on the development of frequency-modulation equipment.

Mrs. Buyer is an associate of Sigma Xi and of the Institute of Radio Engineers.

• • •

WILLIAM DITE was born in New York City on March 2, 1919. He received the

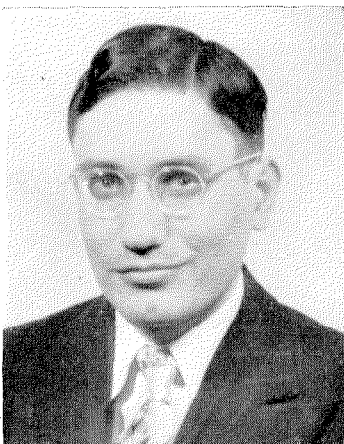

WILLIAM DITE

B.E.E. degree from the College of the City of New York in 1940.

From 1940 to 1943, he was with the Signal Corps Laboratories, Fort Monmouth, New Jersey, working on sound-ranging and radar equipment. Since 1943, he has been associated with Federal Telecommunication Laboratories, Nutley, New Jersey, where his work has been largely concerned with communication systems employing pulses.

Mr. Dite is a member of the American Institute of Electrical Engineers.

• • •

ANTOINE FROMAGEOT was born on October 27, 1910, in Paris, France. He studied at the Ecole Polytechnique until 1932. In 1934, he received the degree of electrical engineer at the Ecole Supérieure d'Electricité (Paris), and spent the next year at the Cavendish Laboratory of Cambridge University.

Mr. Fromageot joined the Société Anonyme Lignes Télégraphiques et Téléphoniques in 1936; he was later placed in charge of development work related to coaxial and 12-channel carrier cables. In 1943, he was transferred to the Laboratoire Central de Télécommunications, where he is now directing development work on carrier telephony.

• • •

MARC A. LALANDE was born in Paris, France, on October 13, 1896. He received the B.S. degree and was admitted to the Ecole de Physique et Chimie, a branch of Paris University, in 1915. The war interrupted his studies and he served in the artillery and signal corps of the French army until 1919. He received the diploma of engineer in 1921.

After serving as an engineer for Société d'Etude pour Lignes Télégraphiques et Téléphoniques à Longue Distance, he joined Le Matériel Téléphonique in 1924. He was transferred in 1935 to Laboratoire Central de Télécommunications, where he now spe-



A. FROMAGEOT

cializes in line and carrier transmission problems for telephony, television, and remote-control systems.

• • •

PHILIP F. PANTER was born in 1908 in Poland. After early schooling in Tel-Aviv, Palestine, he later received from McGill University, Montreal, Canada, the following degrees: B.Sc. in 1933, B. Eng. in electrical engineering in 1935, and Ph.D. in physics in 1936. He continued research in spectroscopy at McGill for an additional year.

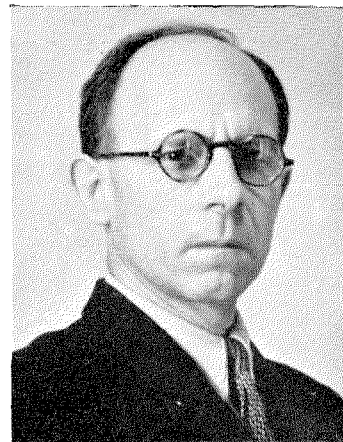

MARC A. LALANDE

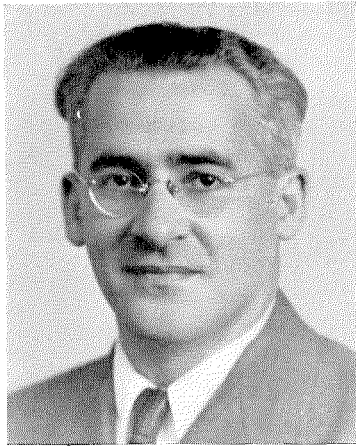

P. F. PANTER

After teaching mathematics and physics in Palestine for a year, he returned to Canada as assistant professor of mathematics and physics in the evening division of Sir George Williams College in Montreal. He served also on the staff of the physics department of McGill University as instructor in physics and later as part-time lecturer, until the end of 1945.

Early in 1941, Dr. Panter joined the transmitter department of the Canadian Marconi Company in Montreal. In October, 1945, he was appointed senior engineer, responsible for the development of frequency-modulation broadcast equipment, at Federal Telephone and Radio Corporation. He later transferred to Federal Telecommunication Laboratories and is now in charge



FRANCESCO PEZZOLI

of the theoretical group of the communications division.

Dr. Panter is a member of the Institute of Radio Engineers and the Radio Club of America.

• • •

FRANCESCO PEZZOLI was born on August 14, 1896, at Spalato in Dalmatia. He received the degree of Doctor of Electro-Mechanical Engineering from Turin University in 1920.

In 1925, Dr. Pezzoli became affiliated with Western Electric Italiana, which has since become Fabbrica Apparecchiature per Comunicazioni Elettriche. In 1945, he was appointed chief engineer for switching systems.

• • •

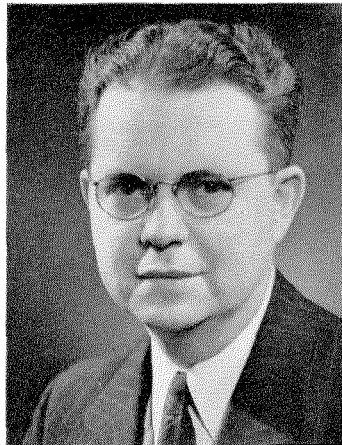

GARVICE H. RIDINGS

GARVICE H. RIDINGS was born on July 9, 1905 in Buena Vista, Virginia. He received the B.S.E.E. degree from Virginia Polytechnic Institute in 1926.

On graduation, he entered the employ of the Western Union Telegraph Company and is now assistant Telefax research engineer in the research and development department.

Mr. Ridings is a Member of the Institute of Radio Engineers.

• • •

DOUGLAS C. ROGERS was born at Richmond, Surry, England, in 1920.

He joined the staff of Standard Telephones and Cables, Limited, in 1939. During the war, he was assigned to the ultra-high-frequency receiver laboratories at Eltham and, later, at Ill-

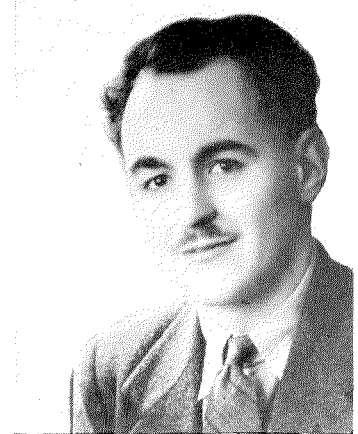

DOUGLAS C. ROGERS

minster, where he was engaged in the development of centimeter-wave receivers.

Mr. Rogers is an Associate Member of the Institution of Electrical Engineers.

• • •

A. R. VALLARINO was born in Panama City, Panama, on August 11, 1913. He was graduated in electrical engineering from Stanford University in 1939. Transferring his studies to electrical communication, Mr. Vallarino spent the next three years in graduate and research work at that university. In 1943, he joined Federal Telecommunication Laboratories as a research engineer.

Mr. Vallarino is an Associate Member of the Institute of Radio Engineers.



A. R. VALLARINO



# INTERNATIONAL TELEPHONE AND TELEGRAPH CORPORATION

## Associate Manufacturing and Sales Companies

### United States of America

International Standard Electric Corporation, New York, New York  
Federal Telephone and Radio Corporation, Clifton, New Jersey  
International Standard Trading Corporation, New York, New York  
Capehart-Farnsworth Corporation, Fort Wayne, Indiana

### Great Britain and Dominions

Standard Telephones and Cables, Limited, London, England  
Branch Offices: Birmingham, Leeds, Manchester, England; Glasgow, Scotland; Dublin, Ireland; Cairo, Egypt; Calcutta, India; Johannesburg, South Africa  
Creed and Company, Limited, Croydon, England  
International Marine Radio Company Limited, Croydon, England  
Kolster-Brandes Limited, Sidcup, England  
Standard Telephones and Cables Pty. Limited, Sydney, Australia  
Branch Offices: Melbourne, Australia; Wellington, New Zealand  
Silovac Electrical Products Pty. Limited, Sydney, Australia  
Austral Standard Cables Pty. Limited, Melbourne, Australia  
New Zealand Electric Totalisators Limited, Wellington, New Zealand  
Federal Electric Manufacturing Company, Ltd., Montreal, Canada

### South America

Compañía Standard Electric Argentina, Sociedad Anónima, Industrial y Comercial, Buenos Aires, Argentina  
Standard Electrica, S.A., Rio de Janeiro, Brazil  
Compañía Standard Electric, S.A.C., Santiago, Chile

### Europe and Far East

Vereinigte Telefon und Telegraphenfabriks Aktiengesellschaft Czeija, Nissl and Company, Vienna, Austria

Bell Telephone Manufacturing Company, Antwerp, Belgium  
Standard Electric Doms a Spolecnost, Prague, Czechoslovakia  
China Electric Company, Limited, Shanghai, China  
Standard Electric Aktieselskab, Copenhagen, Denmark  
Compagnie Générale de Constructions Téléphoniques, Paris, France  
Le Matériel Téléphonique, Paris, France  
Les Téléimprimeurs, Paris, France  
Ferdinand Schuchhardt Berliner Fernsprech und Telegraphenwerk Aktiengesellschaft, Berlin, Germany  
C. Lorenz, A.G. and Subsidiaries, Berlin, Germany  
Mix & Genest Aktiengesellschaft and Subsidiaries, Berlin, Germany  
Süddeutsche Apparatefabrik Gesellschaft m.b.H., Nuremberg, Germany  
Telephonfabrik Berliner A.G. and Subsidiaries, Berlin, Germany  
Nederlandsche Standard Electric Maatschappij N.V., Hague, Netherlands  
Dial Telefonkereskedelmi Részvény Társaság, Budapest, Hungary  
Standard Villamossági Részvény Társaság, Budapest, Hungary  
Telefongyár r.t., Budapest, Hungary  
Fabbrica Apparecchiature per Comunicazioni Elettriche, Milan, Italy  
Standard Elettrica Italiana, Milan, Italy  
Standard Electric Aktieselskap, Oslo, Norway  
Standard Telefon og Kabelfabrik A/S, Oslo, Norway  
Standard Electrica, Lisbon, Portugal  
Compañía Radio Aérea Marítima Española, Madrid, Spain  
Standard Eléctrica, S.A., Madrid, Spain  
Aktiebolaget Standard Radiofabrik, Stockholm, Sweden  
Standard Telephone et Radio S.A., Zurich, Switzerland

## Telephone Operating Systems

Compañía Telefónica Argentina, Buenos Aires, Argentina  
Compañía Telefónico-Telefónica Comercial, Buenos Aires, Argentina  
Compañía Telefónico-Telefónica del Plata, Buenos Aires, Argentina  
Companhia Telefonica Paranaense S.A., Curitiba, Brazil  
Companhia Telefonica Rio Grandense, Porto Alegre, Brazil  
Compañía de Teléfonos de Chile, Santiago, Chile  
Compañía Telefónica de Magallanes S.A., Punta Arenas, Chile

Cuban American Telephone and Telegraph Company, Havana, Cuba  
Cuban Telephone Company, Havana, Cuba  
Mexican Telephone and Telegraph Company, Mexico City, Mexico  
Compañía Peruana de Teléfonos Limitada, Lima, Peru  
Porto Rico Telephone Company, San Juan, Puerto Rico  
Shanghai Telephone Company, Federal Inc. U.S.A., Shanghai, China

## Radiotelephone and Radiotelegraph Operating Companies

Compañía Internacional de Radio, Buenos Aires, Argentina  
Compañía Internacional de Radio Boliviana, La Paz, Bolivia  
Companhia Radio Internacional do Brasil, Rio de Janeiro, Brazil

Compañía Internacional de Radio, S.A., Santiago, Chile  
Radio Corporation of Cuba, Havana, Cuba  
Radio Corporation of Porto Rico, San Juan, Puerto Rico<sup>1</sup>

<sup>1</sup>Radiotelephone and radio broadcasting services.

## Cable and Radiotelegraph Operating Companies

(Controlled by American Cable & Radio Corporation, New York, New York)

The Commercial Cable Company, New York, New York<sup>2</sup>  
Mackay Radio and Telegraph Company, New York, New York<sup>3</sup>

All America Cables and Radio, Inc., New York, New York<sup>4</sup>  
Sociedad Anónima Radio Argentina, Buenos Aires, Argentina<sup>5</sup>

<sup>2</sup>Cable service. <sup>3</sup>International and marine radiotelegraph services.  
<sup>4</sup>Cable and radiotelegraph services. <sup>5</sup>Radiotelegraph service.

## Laboratories

Federal Telecommunication Laboratories, Inc., Nutley, New Jersey

Standard Telecommunication Laboratories, Limited, London, England

Laboratoire Central de Télécommunications, Paris, France