



# ELECTRICAL COMMUNICATION

*Technical Journal of the  
International Telephone and Telegraph Corporation  
and Associate Companies*

---

ANGOLA RADIO NETWORK

PULSE-COUNT MODULATION

PULSE-TIME-MODULATION LINK FOR ARMY FIELD TELEPHONE SYSTEM

PROGRESS OF TELECOMMUNICATION SERVICES IN BRITISH POST OFFICE

SOJ-12 OPEN-WIRE CARRIER TELEPHONE SYSTEMS IN SOUTH AFRICA

OPERATIONAL CONTROL OF ELECTRICITY SUPPLY SYSTEMS

ANOMALOUS ATTENUATION IN WAVEGUIDES

DOUBLE- AND TRIPLE-TUNED BAND-PASS AMPLIFIERS

SIMULTANEOUS RADIO RANGE AND RADIOTELEPHONE EQUIPMENT

VARIABLE-FREQUENCY TWO-PHASE SINE-WAVE GENERATOR

DIMENSIONAL ANALYSIS APPLIED TO VERY-HIGH-FREQUENCY TRIODES

FLASHING SIGNAL FOR RAILWAY CROSSINGS

IN MEMORIAM—HENRY MARK PEASE

---

SEPTEMBER, 1947

VOL. 24

No. 3

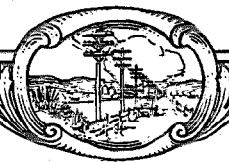

# ELECTRICAL COMMUNICATION

Technical Journal of the  
INTERNATIONAL TELEPHONE AND TELEGRAPH CORPORATION  
and Associate Companies

H. T. KOHLHAAS, Editor  
H. P. WESTMAN, Associate Editor  
F. J. MANN, Managing Editor  
J. E. SCHLAIKJER, Editorial Assistant

### REGIONAL EDITORS

E. G. PORTS, Federal Telephone and Radio Corporation, Newark, New Jersey  
B. C. HOLDING, Standard Telephones and Cables, Ltd., London, England  
P. F. BOURGET, Laboratoire Central de Télécommunications, Paris, France  
H. B. WOOD, Standard Telephones and Cables Pty. Ltd., Sydney, Australia

### EDITORIAL BOARD

H. Busignies    H. H. Buttner    G. Deakin    E. M. Deloraine    W. T. Gibson    Sir Frank Gill  
W. Hatton    E. Labin    E. S. McLarn    A. W. Montgomery    Haraden Pratt    G. Rabuteau  
F. X. Rettenmeyer    T. R. Scott    C. E. Strong    A. E. Thompson    E. N. Wendell    W. K. Weston

Published Quarterly by the

## INTERNATIONAL TELEPHONE AND TELEGRAPH CORPORATION

67 BROAD STREET, NEW YORK 4, N.Y., U.S.A.

Sosthenes Behn, Chairman and President    Charles D. Hilles, Jr., Vice President and Secretary

Subscription, \$2.00 per year; single copies, 50 cents

Copyrighted 1947 by International Telephone and Telegraph Corporation

Volume 24

September, 1947

Number 3

## CONTENTS

	PAGE
ANGOLA RADIO NETWORK .....	283
<i>By Carlos Pelaez</i>	
PULSE-COUNT MODULATION .....	287
<i>By D. D. Grieg</i>	
PULSE-TIME-MODULATION LINK FOR ARMY FIELD TELEPHONE SYSTEM .....	297
<i>By N. H. Young</i>	
PROGRESS OF TELECOMMUNICATION SERVICES IN BRITISH POST OFFICE .....	300
SOJ-12 OPEN-WIRE CARRIER TELEPHONE SYSTEMS IN SOUTH AFRICA .....	310
<i>By D. P. J. Retief and H. J. Barker</i>	
OPERATIONAL CONTROL OF ELECTRICITY SUPPLY SYSTEMS .....	324
<i>By W. Kidd and E. M. S. McWhirter</i>	
ANOMALOUS ATTENUATION IN WAVEGUIDES .....	342
<i>By John Kemp</i>	
EXACT DESIGN AND ANALYSIS OF DOUBLE- AND TRIPLE-TUNED BAND-PASS AMPLIFIERS .....	349
<i>By Milton Dishal</i>	
SIMULTANEOUS RADIO RANGE AND RADIOTELEPHONE EQUIPMENT .....	374
<i>By George T. Royden</i>	
VARIABLE-FREQUENCY TWO-PHASE SINE-WAVE GENERATOR .....	382
<i>By T. H. Clark and V. F. Clifford</i>	
DIMENSIONAL ANALYSIS APPLIED TO VERY-HIGH-FREQUENCY TRIODES .....	391
<i>By Gerard Lehmann</i>	
FLASHING SIGNAL FOR RAILWAY CROSSINGS .....	406
<i>By V. C. Meeuwis</i>	
IN MEMORIAM—HENRY MARK PEASE .....	409
CONTRIBUTORS TO THIS ISSUE .....	410

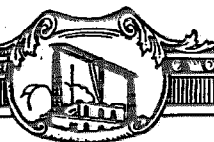

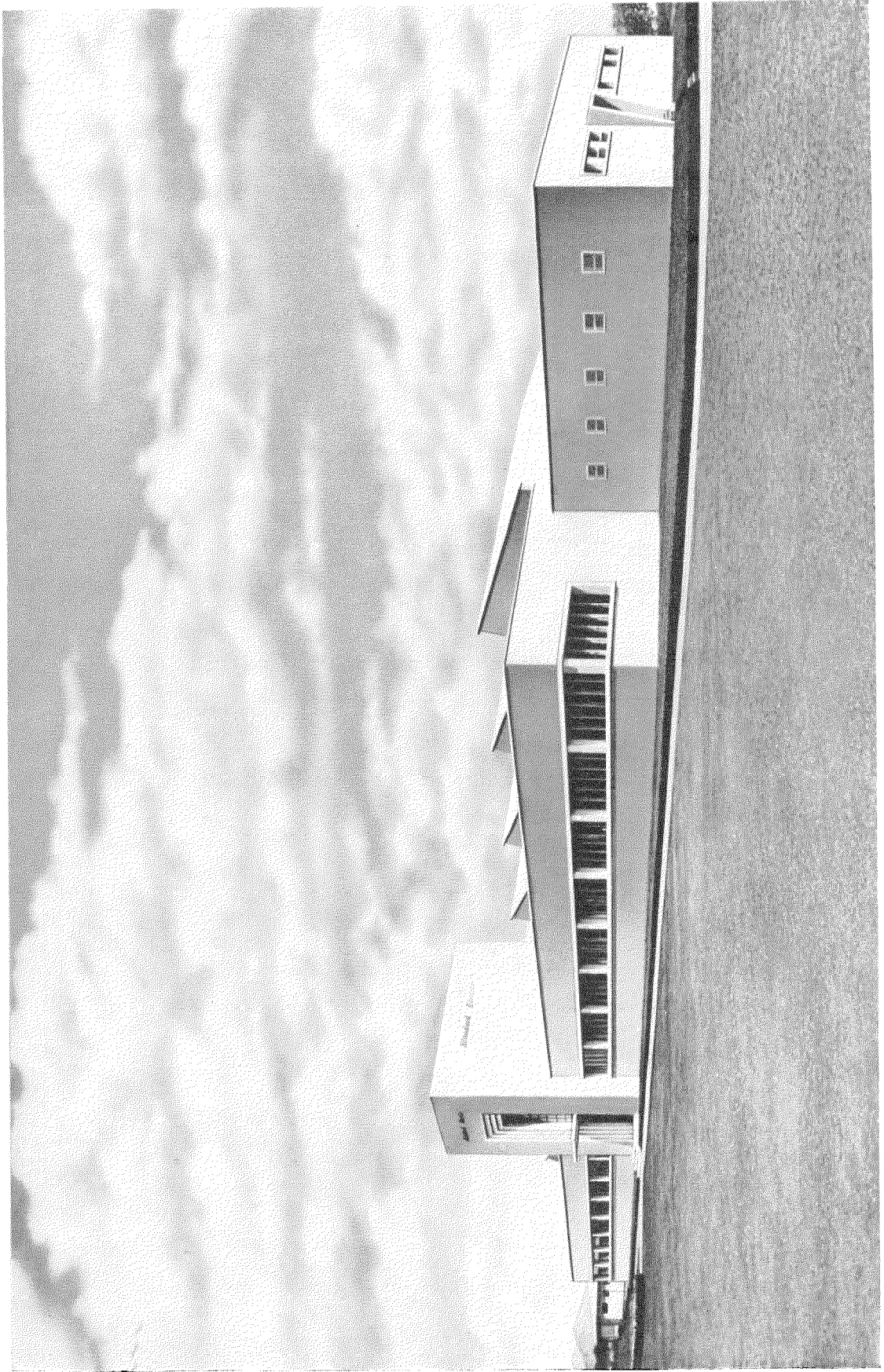

Compañía Standard Electric S.A.C. completed this new factory in Santiago, Chile, in December, 1945. In addition to the manufacture of radio and telephone equipment, the company also serves as installer for the Compañía de Teléfonos de Chile.

# Angola Radio Network

By CARLOS PELAEZ

*Standard Electrica, Lisbon, Portugal*

ANGOLA, a Portuguese colony on the west coast of Africa, is situated between the Congo and the Cunene Rivers. It thus lies between the 6th and 18th southern degrees of latitude and is also between the 12th and 24th degrees of east longitude. The coastal province of Cabinda is an enclave in Belgian territory just a short distance north of the Congo River.

The coastal belt of Angola has a tropical climate. The interior regions, however, are generally at an altitude of between 2000 and 5000 feet above sea level and enjoy a more moderate climate. The highest region is in the Huila district in the southwest part where the city of Sá da Bandeira is located. The total area of the colony is 1,250,000 square kilometers (480,000 square miles) with some 1000 kilometers (625 miles) of coastal belt. The white population numbers about 50,000, and there are approximately 3,700,000 natives.

Luanda is the capital and at the head of a railway running about 450 kilometers (280 miles) inland to Malange. The white population of Luanda is 8000. The second town of importance is Lobito, which is a terminal of the principal railway traversing the colony from west to east and joining Angola with the Belgian Congo and Elisabethville-Cape Town railway.

Angola exports cotton, sugar, palm oil, other agricultural products, and diamonds, the latter being an important factor in the economy of the colony.

## 1. Communications Within the Colony

The communications problem was to provide a service to link 21 specific places scattered throughout the colony as shown in Fig. 1. Economic and geographic conditions did not favor the use of physical circuits, and a radio system offered a practical solution of the problem. It was agreed that both radiotelegraph and radiotelephone service would be provided to the

various centers, which are separated by distances varying between 140 and 700 kilometers (88 and 438 miles). The operation of the system has been adjusted to accord with the amount of traffic, and the power of the various transmitting installations reflects these conditions.

## 2. Communication With Ships

The coastal stations are designed to communicate with ships at sea as well as with the balance of the land network. The Luanda and Lobito stations are considered to have a range of 1000 nautical miles when operating in the band from 100 to 1000 kilocycles per second. In the same band, the Cabinda and Mossamedes stations are rated at 500 miles. The Santo Antonio do Zaire, Novo Redondo, and Baia dos Tigres stations carry but relatively small traffic and have a range of 300 miles.

All of these stations are, of course, equipped with high-frequency transmitters, which will permit much greater ranges in operating with ship stations and land stations in Angola.

## 3. Aircraft Communication

In addition to the marine and overland communication facilities, all of the transmitters are arranged to permit operation at the frequencies assigned for aircraft communication.

Luanda and Lobito are equipped with EL-4 transmitters having a rating of 1500/375 watts. Cabinda and Mossamedes use EL-1 transmitters rated at 500/125 watts. The transmitters at Santo Antonio do Zaire, Novo Redondo, and Baia dos Tigres are of the ESL-50 type of 500/125 watts. All high-frequency transmitters have been provided with a channel for aircraft communication.

## 4. Adcock Direction Finders

Six direction-finding installations of the Adcock type have been made near the airfields at Luanda, Cabinda, Lobito, Mossamedes,

Luanda, the capital of Angola, has higher-powered transmitters than any of the other stations. The receiving building is shown with the antenna systems used for both low and high frequencies.



The high-frequency receiving room at Luanda.

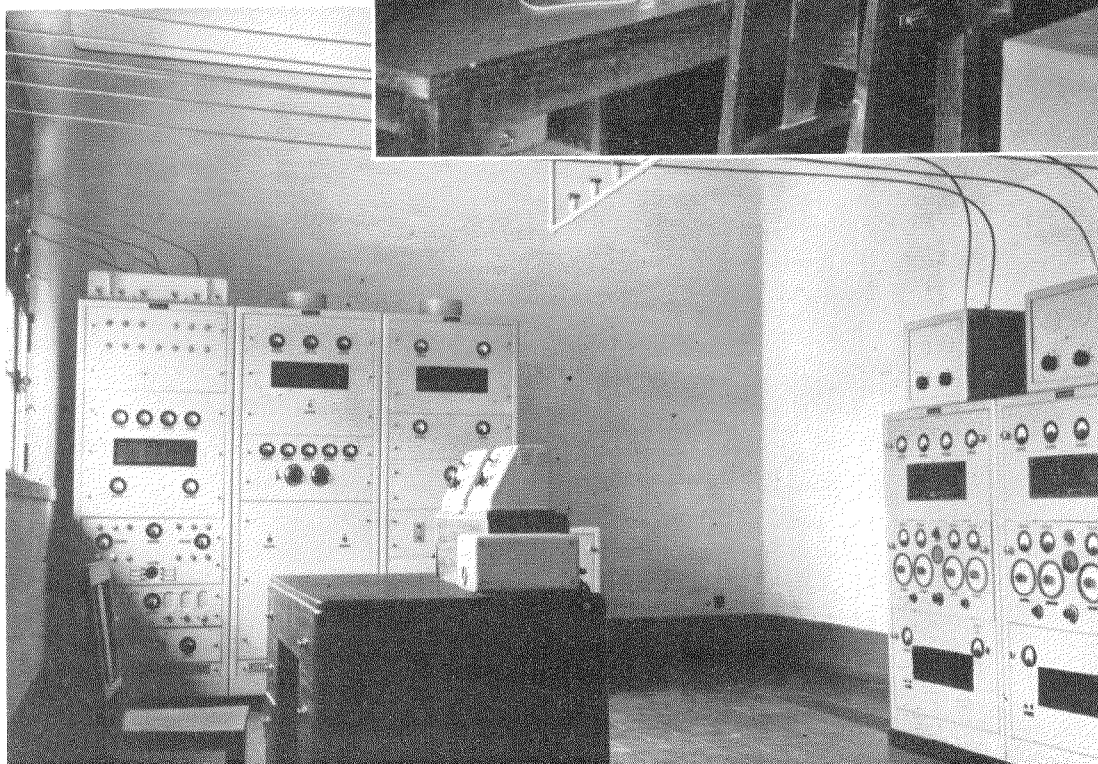
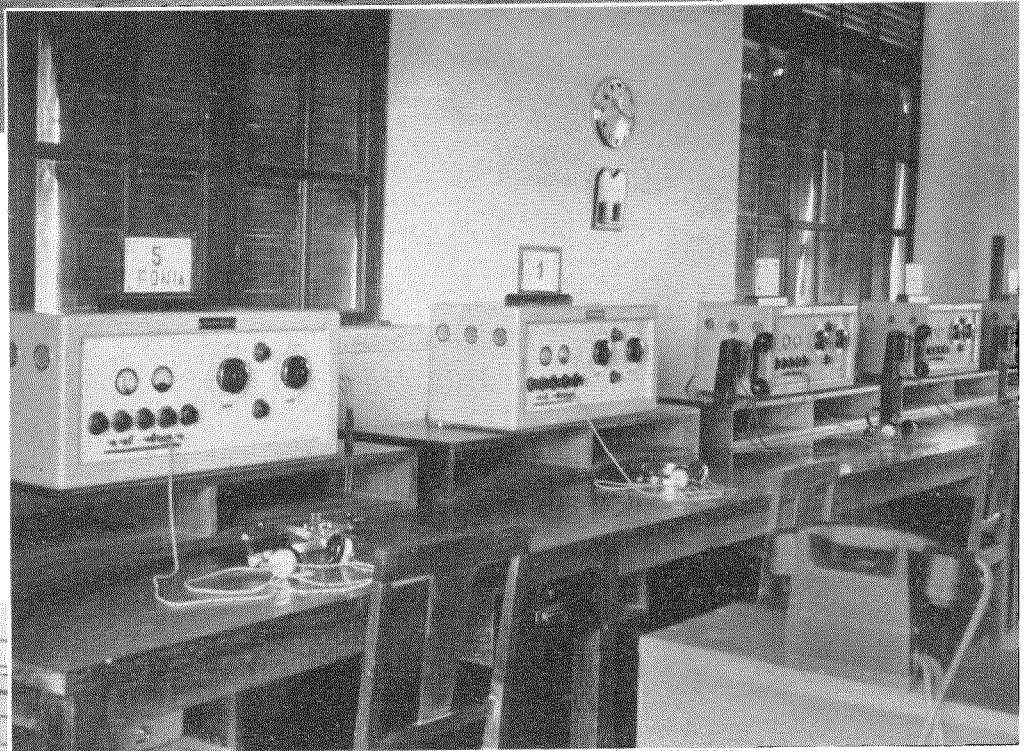

The transmitting room at Luanda showing the CS-2 transmitter in the background, the HS-1 equipment at the right, and the control desk in the foreground.

Nova Lisboa, and Vila Henrique de Carvalho. They are associated with the local radio stations. Further consideration is being given to the establishment of a special network for aeronautical communication.

5. Equipment

Despite wartime problems, the 21 stations have been completed. Each station includes the necessary transmitting and receiving equipment, power supplies, antennas, and essential terminating

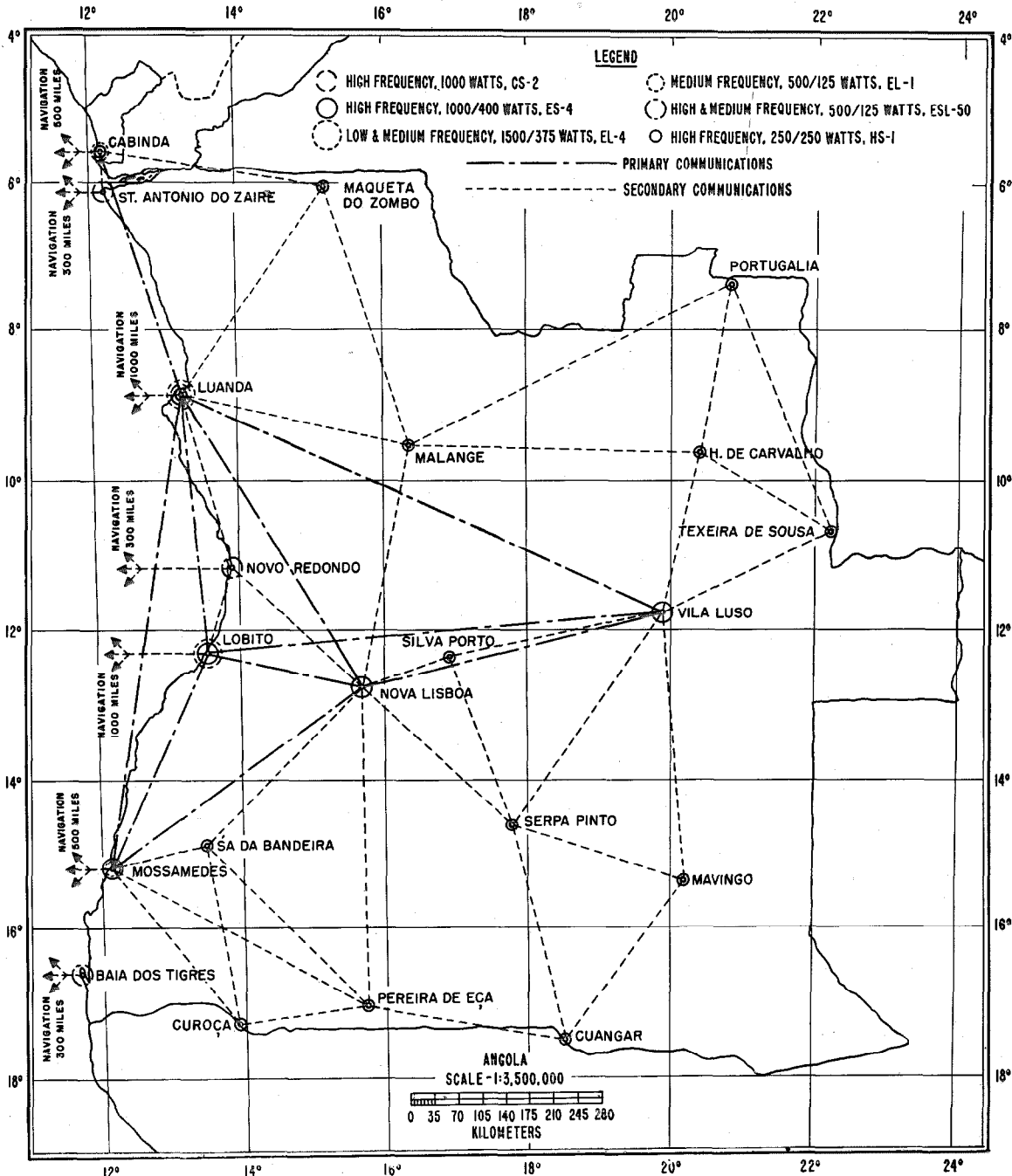

Fig. 1—Angola radio network linking 21 places scattered throughout the colony. Cabinda, on the northern coast, is separated from the main territory by part of the Belgian Congo and the Congo River. The coastal region is tropical and all equipment must be capable of operating in such a climate. The interior is at an elevation between 2000 and 5000 feet above sea level, which brings about a considerable improvement in the climate.

apparatus. All equipment was supplied by Standard Telephones and Cables, Limited, of London, with the exception of the diesel-engine-generator sets and power boards which were supplied by the British manufacturer, Ruston and Hornsby.

For the interior service, Luanda, Lobito, Nova Lisboa, Vila Luso, and Mossamedes are considered to be of greatest importance. At Luanda, a 1-kilowatt high-frequency transmitter type CS-2 is used to cover all points in the colony and for possible broadcasting services. Three HS-1 transmitters of 250-watt rating are provided for other traffic requirements. The other four towns are equipped with ES-4 transmitters rated at 1000/400 watts.

Santo Antonio do Zaire, Novo Redondo, and Baia dos Tigres are equipped with ESL-50 transmitters of 500/125 watts, which are adequate for their relatively minor amount of traffic.

All of the remaining stations have been equipped with 250/250-watt transmitters of the HS-1 type.

Terminal equipment of the TOP-9 type has been installed at Luanda to permit connection between the radiotelephone equipment and the local telephone network. At other places, this facility is provided by the use of 4-wire operation from a public telephone booth. Voice-operated carrier suppression quiets the transmitter during periods of reception. All of the principal stations have been equipped with B-2 privacy equipment.

## 6. Results

### 6.1 HIGH-FREQUENCY OPERATION

The specifications required that most stations be capable of communicating with the main station of each group. Tests have shown that any station in the network is capable of communicating with any other station, a condition that was specified only for the Luanda installation.

This results in much greater flexibility of operation and an increase in the traffic-carrying capacity as relaying from the smaller to the main stations is unnecessary.

Although nothing was included in the specifications regarding communication by high frequencies with places outside of the colony, Lobito maintained satisfactory contact with modulated continuous waves and telephony with Lourenço Marques at a distance of 2500 kilometers (1560 miles) and with planes in flight over

any part of the colony as far as Lourenço Marques. Mossamedes is also able to communicate on modulated continuous waves and telephony with Lourenço Marques and with St. Thomas Island. Luanda, with a higher power than any other station, has communicated over even greater distances; it operates with Leopoldville, Pointe Noire, and St. Thame.

During the return voyage of the writer from Angola to Europe on the *S.S. Mousinho*, radiotelephone tests were made at distances up to 2000 kilometers (1250 miles) to Nova Lisboa and Lobito.

### 6.2 MEDIUM-FREQUENCY OPERATION WITH SHIPS

For operation with ships at sea, the specifications required a range of 1000 nautical miles for Luanda and Lobito, 500 miles for Cabinda and Mossamedes, and 300 miles for St. Antonio do Zaire, Novo Redondo, and Baia dos Tigres. Tests made from the first two stations with ships were successful over distances up to 2650 kilometers (1680 miles) and overland with Tanganyika at 2160 kilometers (1350 miles). Lobito and Mossamedes maintained communication with the *S.S. Mousinho* on a voyage from Lourenço Marques to Lobito.

Although no specifications were included on radiotelephone service for these stations, tests so far carried out from Mossamedes, which is required to have a range of 500 miles on radiotelegraphy, have resulted in communication well over 900 kilometers (560 miles) on radiotelephony.

## 7. Wartime Difficulties

The chief difficulties encountered resulted from the outbreak of war and affected not only the supply of equipment from England but also the means of transportation both to the colony and within Angola. Deficiencies in staff were similarly encountered.

Despite these handicaps, 21 complete stations were erected and include 25 transmitters, 51 receivers, steel antenna masts, cables, motor-generator sets (some in duplicate), together with terminal equipment, dry-type rectifiers, storage batteries, and a large quantity of auxiliary material. All of this equipment and supplies were provided by Standard Telephones and Cables, Limited.

# Pulse-Count Modulation

By D. D. GRIEG

*Federal Telecommunication Laboratories, Inc., New York, N. Y.*

**A**DVANTAGES of pulse transmission include the use of time-division multiplexing, absence of cross talk introduced by nonlinear circuit elements, and improved transmission characteristics. Modulating methods may involve variation of such pulse characteristics as amplitude, frequency, width, and timing. Pulse-count modulation, sometimes called pulse-code modulation, is based on the printing-telegraph binary code to indicate the amplitude of the modulating wave from instant to instant. Thus, to the discrete sampling of a modulating wave in a time dimension is added a discrete sampling of the amplitude of the wave. Electronic methods of coding and decoding the instantaneous amplitudes of audio-frequency modulating waves are described. The system permits the advantages of the printing telegraph to be extended to voice transmission. Substantial improvements in signal-to-noise ratios, cross talk, threshold values, and other transmission factors are indicated. These improvements have been verified under operating conditions.

• • •

Within recent years, a wide variety of modulation methods utilizing short bursts or pulses of energy have been developed. These methods have found application to a large number of systems including telephony, radio relaying, telemetering, and broadcasting.<sup>1-6</sup> The particular properties that have made pulse modulation attractive for

transmission systems have resulted from both its multiplexing and modulation characteristics.

For example, by interleaving the modulating signals in time sequence, i.e., time-division multiplex, cross talk introduced by nonlinearities in the transmission system, such as would be obtained with frequency-division multiplexing, is eliminated. This important property allows the use of circuit elements with nonlinear characteristics and makes possible long relays with many repeaters. A further factor obtained with constant-amplitude pulse systems is independence of fading and other transmission vagaries. An additional property is a flexibility that allows various transmission parameters to be exchanged, for example, bandwidth for noise-reduction properties, and distortion and cross talk for bandwidth. This permits systems to be designed to specific requirements.

Basically, pulse transmission involves sampling the modulating signal at discrete intervals of time sufficiently short so as to allow little or no change in the modulating signal during the period of sampling. As these samples or pulses may be characterized by the parameters of timing, duration, frequency, build-up time, decay time, and shape, a large number of modulation methods involving these quantities either singly or in combination may be envisaged.

The amplitude of the pulses may be varied resulting in pulse-amplitude modulation (PAM). Alternatively, the width or duration of the pulses can be made to vary with the modulating signal resulting in pulse-width modulation (PWM). Instead of varying the individual pulse characteristics, the time between pulses, or with reference to a marker pulse, can be varied, resulting in pulse-time modulation (PTM). Or the repetition frequency of the pulse can be varied, comparable to conventional frequency modulation, yielding pulse-frequency modulation (PFM). Other characteristics of the pulse, such as the build-up or decay time, can be varied. Combinations of these several modulations may be employed to produce various hybrid systems.

<sup>1</sup> E. M. Deloraine and E. Labin, "Pulse Time Modulation," *Electrical Communication*, v. 22, n. 2, pp. 91-98; 1944.

<sup>2</sup> F. F. Roberts and J. C. Simmonds, "Multichannel Communication Systems," *Wireless Engineer*; November, 1945.

<sup>3</sup> D. D. Grieg and A. M. Levine, "Pulse-Time-Modulated Multiplex Radio Relay System—Terminal Equipment," *Electrical Communication*, v. 23, pp. 159-178; June, 1946.

<sup>4</sup> H. S. Black, J. W. Beyer, T. J. Grieser, and F. A. Polkinghorn, "A Multichannel Microwave Radio Relay System," *Electrical Engineering*, v. 65, pp. 798-805; December, 1946.

<sup>5</sup> L. L. Rauch, "Electronic Commutation for Telemetering," *Electronics*; February, 1947.

<sup>6</sup> D. D. Grieg, "Multiplex Broadcasting," *Electrical Communication*, v. 23, pp. 19-26; March, 1946.



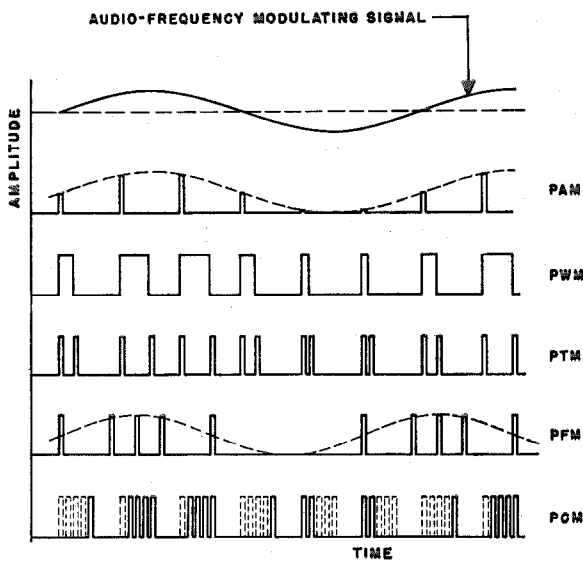

Fig. 1—Pulse-amplitude, pulse-width, pulse-time, pulse-frequency, and pulse-count modulations are illustrated.

Fig. 1 illustrates the general characteristics of a few of the possible modulation methods. It should be noted that the figure illustrates only the so-called “video-frequency” pulses, which can be used directly for transmission over wires or cables or to modulate the radio-frequency carrier in either amplitude, frequency, or phase.

**1. Pulse-Count Modulation**

With most methods of pulse modulation, all levels of the modulating signal between zero and maximum are transmitted in the sampling process. However, a second class of modulation can be devised in which, in addition to time sampling, only selected levels of the amplitude are transmitted; i.e., a system of double discreteness involving quantization of amplitude at discrete intervals of time. With such a system, the amplitude range of the modulating signal is divided into a number of discrete levels. If the instantaneous amplitude of the signal falls between two levels, either the lower or upper level is transmitted depending on which is closer to the signal amplitude. These methods were first described by A. H. Reeves in United States and French patents.<sup>7</sup>

<sup>7</sup> A. H. Reeves, U. S. Patent 2,272,070, February 3, 1942; also French Patent 852,183, October 23, 1939.

Because only a finite number of levels is involved, it is possible to transmit the modulating information by a code similar to that of the printing telegraph system. For example, if the modulating signal is divided into a total of 31 levels, a five-unit binary numbering system may be used to identify each discrete amplitude. Thus, all levels from 0 to 31 would be transmitted in terms of 0 and unity, which for practical purposes may be the absence and presence of a pulse or any other two-value variation such as a difference in frequency. 0 is transmitted as 00000, 1 as 10000, 2 as 01000, 3 as 11000, and 31 as 11111. Fig. 1 compares this system of transmission with other methods. Fig. 2 gives the binary count combinations utilizing five pulses to reproduce any level between 0 and 31.

	WEIGHT OF PULSE				
	1	2	4	8	16
1	X				
2		X			
3	X	X			
4			X		
5	X		X		
6		X	X		
7	X	X	X		
8				X	
9	X			X	
10		X		X	
11	X	X		X	
12			X	X	
13	X		X	X	
14		X	X	X	
15	X	X	X	X	
16					X
17	X				X
18		X			X
19	X	X			X
20			X		X
21	X		X		X
22		X	X		X
23	X	X	X		X
24				X	X
25	X			X	X
26		X		X	X
27	X	X		X	X
28			X	X	X
29	X		X	X	X
30		X	X	X	X
31	X	X	X	X	X

Fig. 2—Binary count combinations. By adding the weights of the pulses for which there are X's, the level number will be obtained. In transmission, the X's correspond to the presence of pulses.

In Fig. 3, the solid line represents the audio-frequency modulating voltage. This signal is broken into discrete levels resulting in the step-type function also shown. At the time of scanning, the instantaneous level of the step function is reproduced in terms of the five-unit pulse code likewise shown. The type of modulation combining both time sampling as well as discrete amplitude or quantization has been termed pulse-count modulation.<sup>8</sup>

This system permits many advantages of the printing telegraph to be extended to voice transmission.

For example:

A. Noise added to the system can be made noncumulative for a long relay using many repeaters because each pulse can be completely regenerated at each repeater with complete suppression of noise previously added in the transmission path, provided the minimum signal received is above the noise threshold. This allows a considerably larger amount of attenuation over other modulation methods, which in practice permits greater distance between repeaters, smaller power requirements, and greater freedom from fading variation.

B. Where multiplexing of the pulse-count signal is by means of time division, cross talk is noncumulative. This factor is of considerable importance because the effect of reflections resulting from multipath transmission in a radio system or, alternatively, caused by mismatches or discontinuities in cable transmission, can be minimized.

C. The system operates effectively with a signal approximately 15 decibels

<sup>8</sup> H. S. Black and J. O. Edson, "Pulse Code Modulation," American Institute of Electrical Engineers Summer Convention, Montreal, Quebec, Technical Paper 47-131; June, 1947.

above thermal-agitation noise or 3 decibels above peak noise, in addition to an extremely large signal-to-noise improvement ratio, which is substantially independent of the signal-to-noise input ratio when that ratio exceeds 15 decibels.

D. The transmission method also allows relatively simple repeaters to be used because only on-off characteristics need be recognized and transmitted.

## 2. Technical Properties

### 2.1 QUANTIZATION DISTORTION

A consideration of first importance is the distortion<sup>9</sup> introduced by quantization of amplitude and sampling in time. It is obvious that, as the number of levels is increased, the granulation of the signal becomes smaller and hence distortion

<sup>9</sup> A. G. Clavier, P. F. Panter, and D. D. Grieg, "Distortion in a Pulse-Count Modulation System," American Institute of Electrical Engineers Summer Convention, Montreal, Quebec, Technical Paper 47-152; June, 1947.

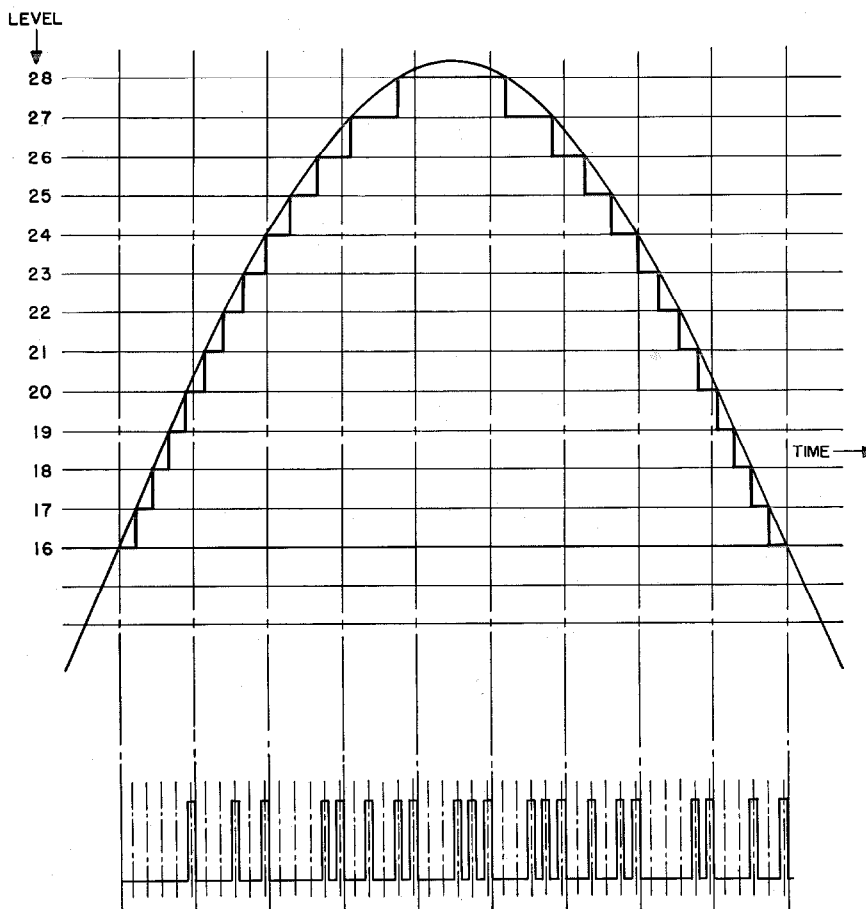

Fig. 3—Details of pulse-count modulation. The solid continuous line represents the audio-frequency modulating voltage, and the step function corresponds to the quantized signal levels. The pulse-count signal at the bottom of each column corresponds to the value of the level at the left side of that column.

resulting from this factor is decreased. On the other hand, this requires an increase in the number of code pulses to be transmitted and a corresponding increase in bandwidth. The reference cited shows that the use of a relatively small number of levels is satisfactory for generally acceptable speech quality. For example, dividing the speech waveform into a total of 31 levels yields a distortion of the order of 3 percent. Tests have been conducted which indicate that intelligible speech can be obtained with as low a number as 7 levels.

The percent distortion  $D$  is a function of the total number of levels  $2m$ , where  $m$  is the number of levels on one side of the zero axis, and is given by

$$D = \frac{1}{\sqrt{6(m)}} \times 100. \quad (1)$$

This expression holds reasonably well for a number of levels less than approximately 100. Table I gives the distortion for various numbers of levels into which the signal may be divided.

## 2.2 TIME-SAMPLING DISTORTION

Time-sampling distortion<sup>10</sup> results from scanning the signal at discrete intervals of time. Time-sampling distortion for pulse-count modulation is the same as for pulse-amplitude modulation; i.e., spurious components are developed mainly as a result of sideband harmonics of the pulse carrier falling into the audio-frequency transmission band. There is, in addition, a small distortion component caused by the finite width of the sampling pulse. For normal pulse widths and for practical purposes, this source of distortion can be neglected.

The minimum ratio of sampling frequency  $f_p$  to audio-frequency bandwidth  $f_h - f_l$ , where  $f_h$  and  $f_l$  are the high- and low-frequency limits of the audio-frequency band, respectively, is given by

$$\frac{f_p}{(f_h - f_l)} = 2. \quad (2)$$

It should be noted that in this case, in order to achieve the maximum sampling frequency, it may be necessary to transpose the band  $(f_h - f_l)$  to a band having a top frequency of  $f_h$ .

<sup>10</sup> H. L. Krauss and P. F. Ordung, "Distortion and Bandwidth Characteristics of Pulse Modulation," American Institute of Electrical Engineers Summer Convention, Montreal, Quebec, Technical Paper 47-166; June, 1947.

TABLE I  
DISTORTION AS A FUNCTION OF NUMBER OF LEVELS

Number of Levels	Distortion in Percent
3	27
7	13
15	7
31	3.5
63	1.7
127	0.8
255	0.4
511	0.2
1023	0.1

TABLE II  
BINARY COUNT SYSTEM  
Number of Levels as a Function of Number of Pulses

Number of Pulses	Number of Levels
1	2
2	3
3	7
4	15
5	31
6	63
7	127
8	255
9	511
10	1023

For practical purposes, a larger ratio must be utilized to permit the sampling components to be separated from the voice components with an economical audio-frequency filter. With a simple filter, a cutoff frequency  $1.5f_l$  can be attained. Also, if the lower cutoff frequency is small compared to the upper frequency, (2) becomes

$$\frac{f_p}{f_h} \cong 2.5. \quad (3)$$

## 2.3 NUMBER OF PULSES

Preferably, the quantized signal is transmitted by a series of pulses as previously mentioned. If  $p$  is the total number of pulses to be transmitted for any given level, the number of levels  $2m$  is given by  $2m = N^p$ , where  $N$  corresponds to the counting system used. If a binary count system corresponding to an on-off function is utilized,  $N = 2$  and  $2m = 2^p$ , or

$$p = 1.44 \log_e 2m. \quad (4)$$

Note that the number of pulses must be the nearest whole number to the value given by (4). Table II illustrates the number of pulses required for the various numbers of levels utilizing a binary count system.

## 2.4 BANDWIDTH CONSIDERATIONS

The transmission of pulses obviously requires a larger bandwidth than that normally employed for voice transmission. On the other hand, with pulse-count modulation, it is necessary to determine only the presence or absence of a pulse and, hence, a comparatively smaller bandwidth than that required for other types of pulse systems is satisfactory. Several factors determine the allowable pulse distortion and the corresponding bandwidth. For example, the amount of carry-over from one pulse to the adjacent pulse determines the cross talk in the system. This same factor influences the signal-to-noise ratio and noise threshold. Alternatively, the bandwidth must be properly defined because the pulse distortion is a function of the low and high cutoff frequencies, and the type and rate of change of attenuation at these cutoff points, as well as of the bandwidth itself.

The minimum bandwidth required for zero cross talk has been determined both theoretically and empirically for various types of cutoff char-

acteristics including the frequency characteristics of equalized and unequalized coaxial cable. The results can be expressed approximately as follows:

$$F \cong \frac{f_p}{2} \quad (5)$$

for the upper limit of frequency, where  $F$  is defined as the pulse bandwidth at the 3-decibel points and  $f_p$  is the total number of pulses per second.

## 2.5 SIGNAL-TO-NOISE AND THRESHOLD

Pulse-count modulation, in common with the printing telegraph system, yields a far greater signal-to-noise improvement than any other modulation system using equal bandwidth. With conventional amplitude, frequency, or pulse-time modulation, audio-frequency output signal-to-noise ratio is always directly proportional to the input carrier-to-noise ratio, provided the carrier is above the threshold value. With pulse-count modulation, however, the output signal-to-noise ratio is essentially independent of the input ratio once the signal exceeds the noise level.

Noise enters into a pulse-count system only if a noise pulse substitutes for, or suppresses, a pulse of the transmitted series. Under conditions where noise never exceeds approximately half the peak pulse amplitude, it is always possible to "slice out" a portion of the signal pulse that is completely undisturbed by noise. The time of occurrence of this pulse may be advanced or retarded but, unlike other pulse systems, this effect is unimportant because it is necessary to determine only the presence or absence of a pulse. Thus, it would be assumed that for signals above twice the noise level, the output signal-to-noise ratio is essentially infinite.

Noise has a random distribution of peak amplitudes. This varying threshold requires that the input signal must pass through a range of values before a maximum output signal-to-noise ratio is achieved. Various calculations and tests indicate that a root-mean-square value of signal-to-noise of the order of 15 decibels gives useful service. This is illustrated by the graph of Fig. 4. This threshold value of 15 decibels has also been observed experimentally in teleprinter tests to correspond to the "breaking point" between perfect and imperfect reception.

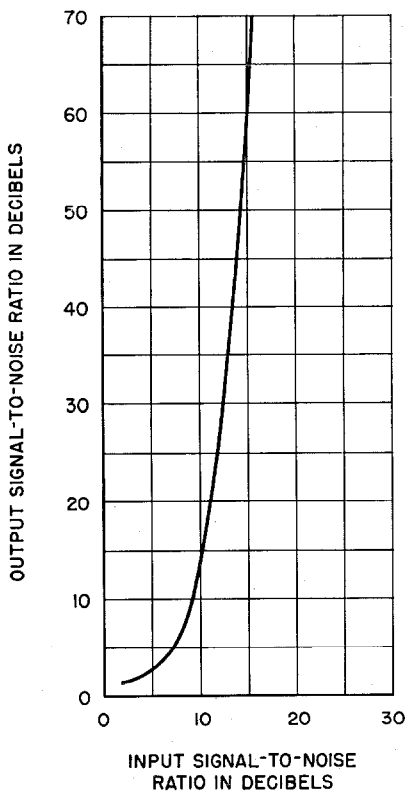

Fig. 4—Output signal-to-noise ratio plotted against input signal-to-noise ratio for pulse-count modulation.

2.6 GENERAL DESIGN RELATIONS

The expressions for the number of pulses in relation to the number of levels (4) and for distortion as a function of the number of levels (1) can

It should be noted that this corresponds to the case for a simple filter for separating the audio-frequency components from the pulse scanning components. Theoretically, if the ratio of pulse

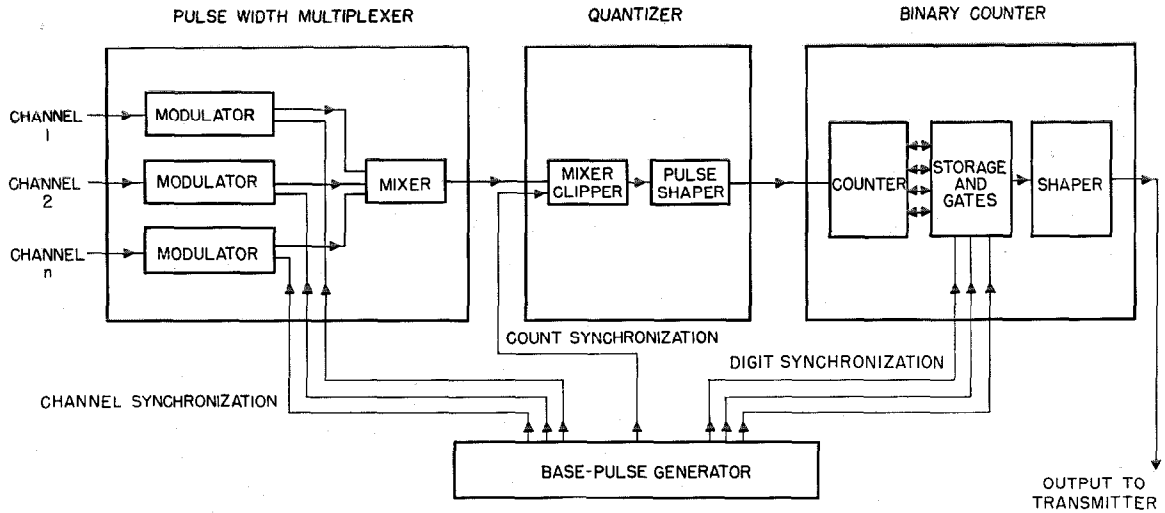

Fig. 5—Block diagram of pulse-count modulator. This unit transposes the modulation of the individual channels to a multiplex series of pulses.

be combined to give the relation between the number of pulses and distortion.

$$p = 1.44 \log_e \frac{80}{D} \tag{6}$$

The ratio of pulse frequency to audio frequency is given for the practical case by (3) and the number of pulses per second per channel is given by

$$f_p = 3.6f_h \log_e \frac{80}{D} \tag{7}$$

For  $N$  channels, this expression is, of course, multiplied by  $N$ . The frequency band is given in (5) as the total number of pulses divided by 2 and, therefore, the ratio of the required transmission bandwidth to the audio-frequency bandwidth is

$$\frac{F}{f_h} = 1.8N \log_e \frac{80}{D} \tag{8}$$

For a distortion  $D$  of 3 percent, which is a reasonable practical value for telephony and corresponds to a 31-level system, we obtain

$$\frac{F}{f_h} = 6.25N. \tag{9}$$

frequency to audio-frequency bandwidth  $f_p/f_h = 2$  is utilized, the above expression becomes

$$\frac{F}{f_h} = 5N. \tag{10}$$

In other words, the theoretical bandwidth for a 31-level pulse-count system is five times that of a single-sideband amplitude-modulation system.

3. Equipment

Several methods are available for producing pulse-count modulation and for its demodulation. A representative method has been described by A. H. Reeves<sup>7</sup> and the modulating system is illustrated by the block diagram of Fig. 5. This corresponds to a multichannel pulse-count-modulation system. Although applicable to a large number of channels, for simplicity only a small number is illustrated.

3.1 MODULATOR

The modulator serves both to multiplex the individual audio-frequency channels as well as to translate the channel information into a series of coded pulses. It consists of four main units: (A)

pulse-width multiplexer, (B) quantizer, (C) binary counter and associated circuits, and (D) base-pulse generator.

The modulating voltages applied to the channel modulators operate on the timing pulses supplied by the base-pulse generator to yield width-modulated pulses occurring in proper time sequence. They yield a pulse-width multiplex series at the mixer output as illustrated in Fig. 6.

This series of pulses passes to the quantizer circuit. Each individual pulse allows the passage of a number of count pulses corresponding to the width of that pulse. The maximum number of count pulses corresponds to the maximum number of levels and is produced only by a pulse of maximum width.

The series of pulses obtained from the quantizer must then be translated into a binary number in the binary counter shown. The counter can take many forms, the most familiar being that of a series of "flip-flop" multivibrators interconnected so that each multivibrator turns over once for every two pulses applied by the preceding multivibrator. Associated with the binary counter are the necessary storage and gate circuits in addition to reset circuits.

A series of digit synchronizing pulses, which have the same time characteristics as the ultimate transmitted pulses, are applied to the gates

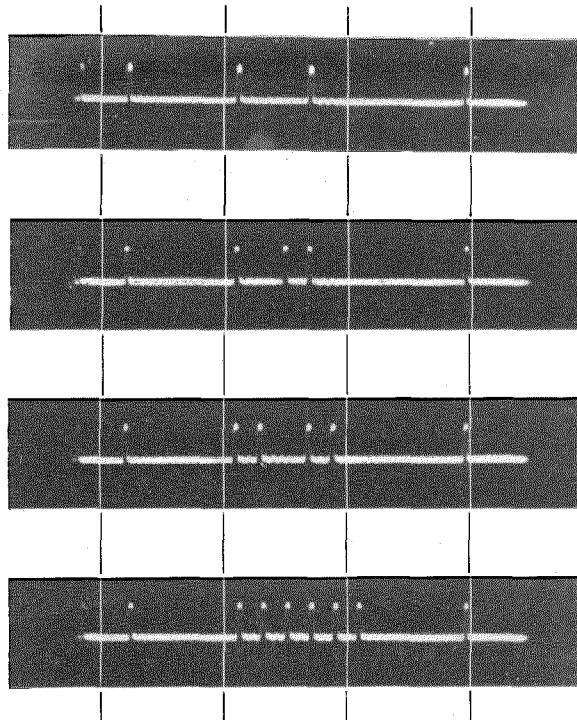

Fig. 7—Oscillogram of pulse-count-modulation signals. The counts set up for the center channel are 9, 13, 27, and 31 respectively.

in addition to the final voltage yielded by each individual multivibrator at the end of the count. Digit pulses are passed by the gates only when a

potential corresponding to a full turnover of the individual multivibrator exists.

The storage circuit is necessary to provide a full count of the instantaneous level prior to setting up the ultimate binary count. The reset signals are, of course, utilized to recycle the counters for subsequent counting. As an example of the pulse rates utilized, the data of Table III are representative for an 8-channel, 31-level pulse-count-modulation system with channel bandwidths of 3500 cycles.

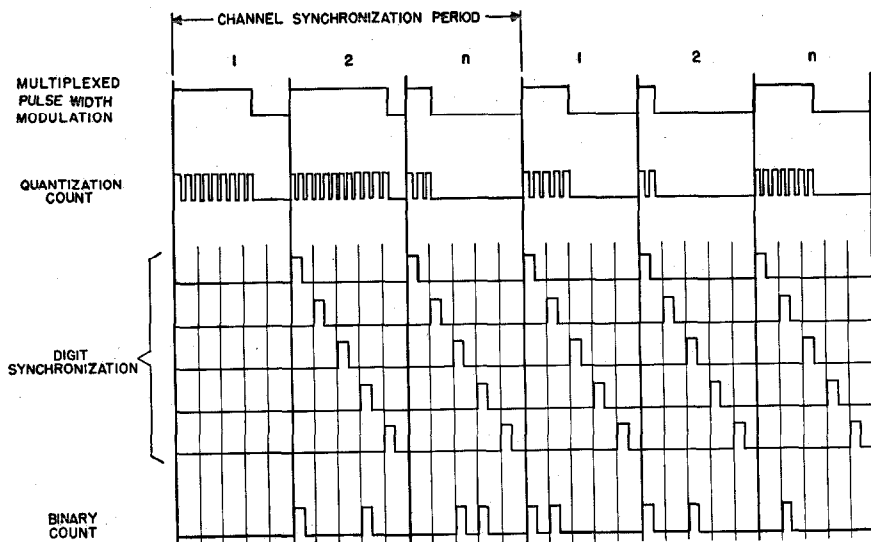

Fig. 6—Modulator waveform sequence. The binary count is delayed as it must follow completion of the quantization count. The binary count thus appears in the next succeeding channel.

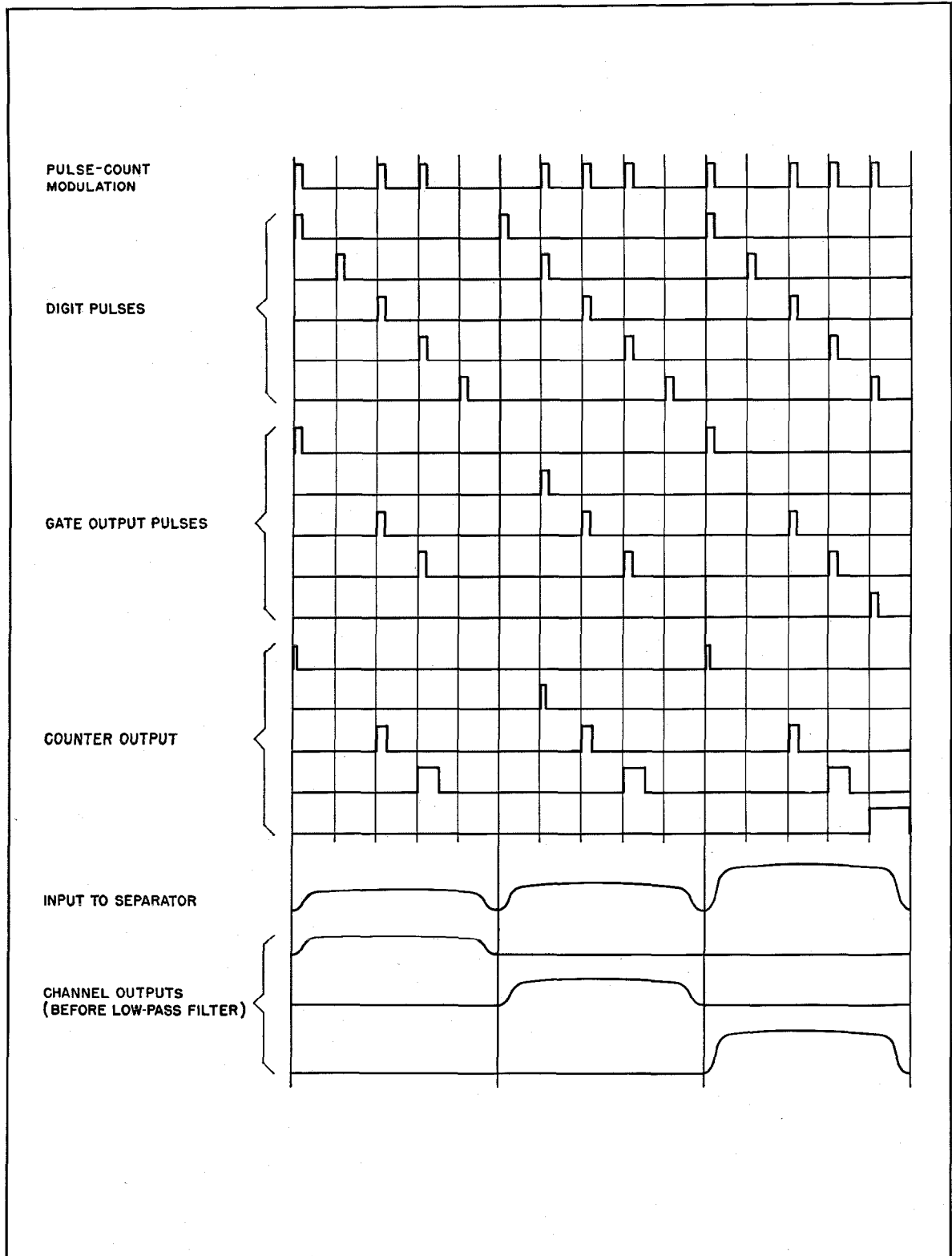

Fig. 9—Demodulation waveform diagram. Audio-frequency filters, not shown in the block diagram, are utilized to remove the pulse-frequency components from the modulating-signal output of the separator-demodulator units.

The final output pulses corresponding to proper binary count for each sample are then obtained from the appropriate shaper circuit for transmission. An oscillogram illustrating the pulses derived from a system similar to that described is shown in Fig. 7.

TABLE III  
REPRESENTATIVE PULSE RATES  
8 Channels, 31 Levels

	Kilocycles
Base Pulse Rate (Channel Synchronization)	8
Count Synchronization	1000
Digit Synchronization	333
Output Pulse-Repetition Frequency	333

### 3.2 DEMODULATOR

The demodulator accepts the multiplex pulse series, separates the individual channels, and recovers the original modulation. The system illustrated in Fig. 8 is essentially the reverse of that described for the modulator. As indicated by the illustration, the receiver consists of three main units: (A) synchronizing circuit, (B) counter circuit, and (C) multiplex demodulator.

The synchronizing circuit extracts from the incoming pulses information for producing a pulse series for the various controls, such as for

digit synchronization, channel order, and channel synchronization. The input signal is obtained from a radio receiver and is in the form of a series of pulses. This signal is applied to gate circuits which, in conjunction with the digit synchronizing voltages, separate the code series into individual pulses corresponding to the actual digits transmitted. This is illustrated in the waveform diagram of Fig. 9. If a code pulse and digit pulse occur simultaneously, the gate circuits produce output. The individual digit pulses actuate a counter circuit that produces a pulse whose width corresponds to the weight of the digit applied. Thus for a 5-pulse system, a total of 5 counters would be used with each counter producing successively an output pulse twice the width of the preceding counter. In this example, the pulse width produced by the fifth counter would be sixteen times the width of the first counter; preceding counters would produce pulse widths having the relative weights of 8, 4, and 2, respectively.

The outputs of the counters are connected in parallel to obtain the sum of the counter pulses produced. This signal is then passed through a filter which removes the high-frequency components. It is then applied to the multiplex demodulator, which serves to separate the individual channels and translate the energy variation into the appropriate audio-frequency signal.

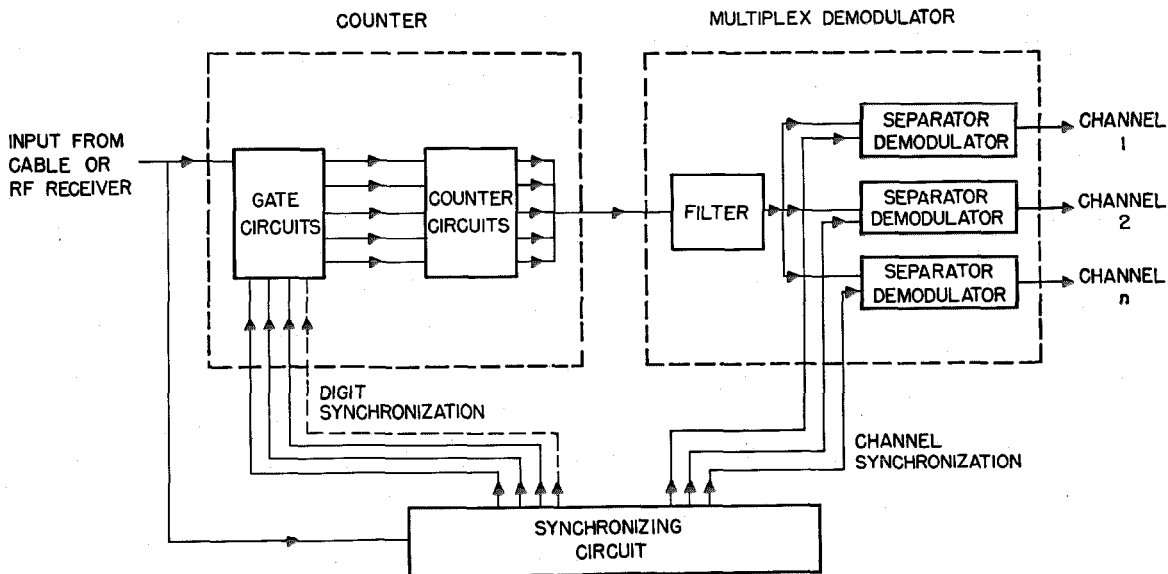

Fig. 8—Block diagram of receiving demodulator. This unit separates the pulse-count multiplex signal into individual channels. In addition, the pulse-count combinations are translated into the corresponding audio-frequency signals.



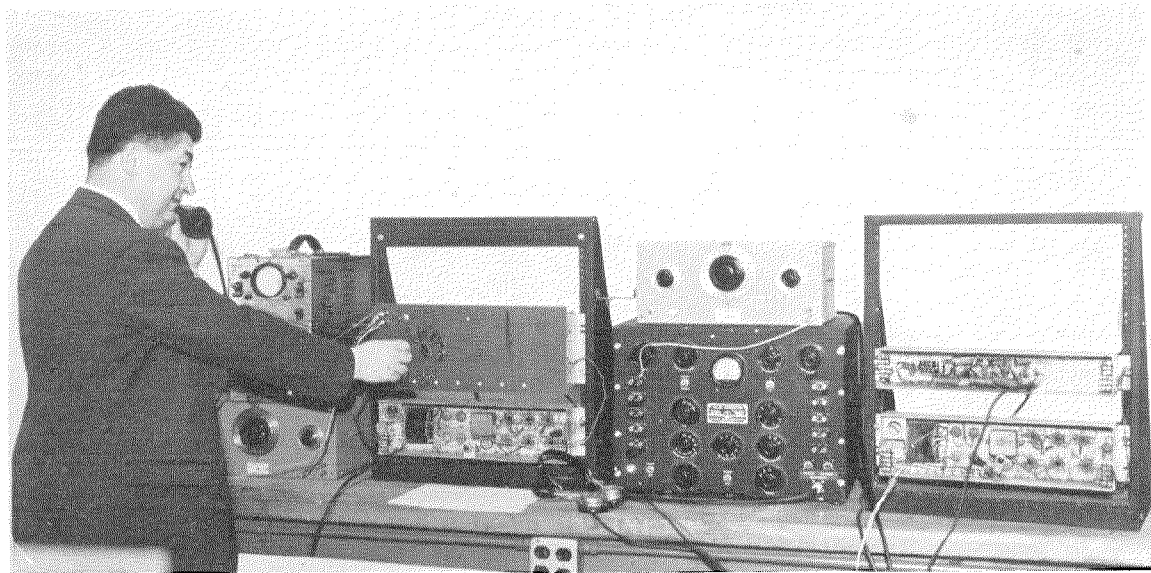

Fig. 10—Representative experimental system for pulse-count-modulation transmission. Included in this apparatus are both the modulator and demodulator for transmission and reception.

Simplified systems of pulse-count-modulation transmission corresponding in general to that described have been constructed in the laboratory. Fig. 10 illustrates such a simplified system developed for experimental purposes.

#### 4. Conclusion

Tests of pulse-count-modulation transmission have tended to confirm the advantages theoretically indicated. In particular, the telegraphy-type characteristics of the system have permitted operation over relatively unfavorable transmis-

sion paths, such as poor cable, without destruction of the signal-carrying characteristics. A similar attractive characteristic can be expected over radio transmission paths where severe fades, as well as multipath reflection, are to be expected.

On the basis of the experimental results obtained to date, pulse-count modulation would seem to offer attractive possibilities for application to radio and wire transmission circuits, particularly for multichannel operation over long relay paths. These applications are being investigated.

# Pulse-Time-Modulation Link for Army Field Telephone System

By N. H. YOUNG

*Federal Telecommunication Laboratories, New York, New York*

**D**URING the war, a need developed for an apparatus that could be introduced between two field telephones to permit them to function normally without a pair of wires connecting them. This type of operation can be achieved by using a duplex radio link and suitable arrangements for changing from the 2-wire telephone circuit to the 4-wire system needed for the radio link.

When pulse modulation is used, the pulses transmitted by each station may be radiated at times when no incoming pulses are due. This form of time division permits duplex operation.

Advantages of this method of duplexing include the use of a single channel for both directions of transmission, increased difficulty of unauthorized interception, and the use of a common antenna system for transmission and reception. An increased rejection of noise in the radio link

results from the use of high peak powers which characterizes pulse methods.

## 1. Principles

The equipment used at one terminal of such a link is shown in block form in Fig. 1. Most of the elements of the system are identical with those used for conventional pulse-time-modulation voice communication without duplexing. The only additions for duplexing are the sine-wave generator and phasing control connected to the output of the receiver and the hybrid network needed to convert from 2-wire to 4-wire operation.

In operation, either station may be used as the "master" station to establish the pulse-repetition rate for both terminals of the link. The pulse-repetition rate is controlled by a sine wave generated by a stable oscillator in the sine-wave-

generator and phaser chassis. This wave is shaped by a pulse-time modulator<sup>1</sup> into a train of pulses, with small deviations from the normal positioning representing the voice modulation. These pulses are amplified and applied as modulation to the transmitter. The modulator unit also forms pulses to block the intermediate-frequency amplifier of the receiver during the time a pulse is to be

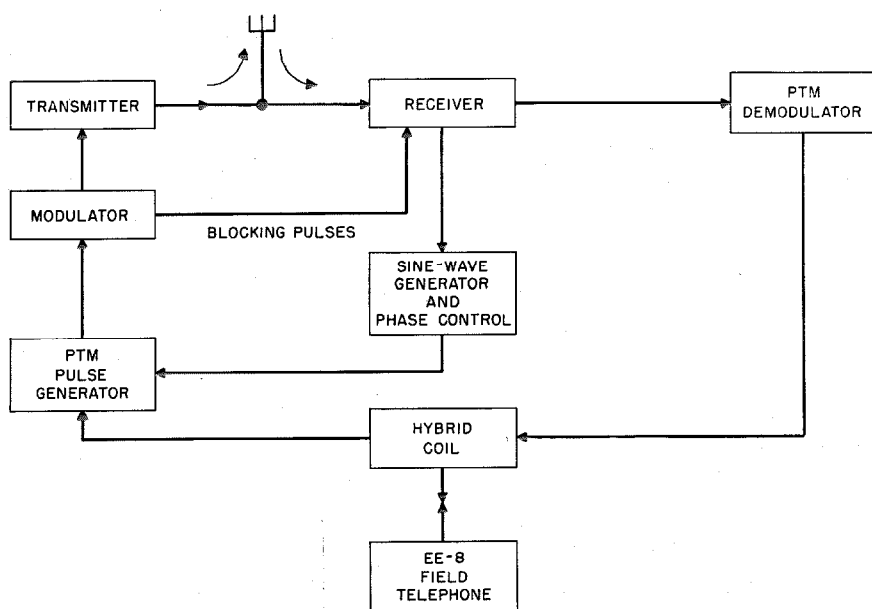

Fig. 1—Block diagram of pulse-time-modulation link used to extend a field telephone system.

<sup>1</sup>D. D. Grieg and A. M. Levine, "Pulse-Time-Modulated Multiplex Radio Relay System—Terminal Equipment," *Electrical Communication*, v. 23, pp. 159-178; June, 1946.

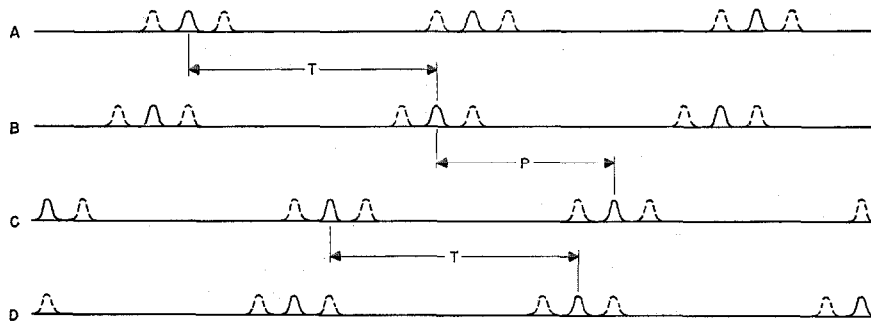

Fig. 2—Relative timing of pulses. *A.* Pulses as emitted from the master station. The dotted pulses indicate the extreme positions assumed under modulation. *B.* Reception of pulses at the slave station. *T* is the time required for transit from the master station. *C.* The pulses are emitted by the slave station after further delay *P* introduced by the phase control at the slave station. *D.* Pulses from the slave station are received at the master station suitably interleaved with those transmitted by the master station, thus allowing duplex operation without interference.

transmitted, thus preventing overload and cross talk in the receiver. The received pulses are demodulated in the usual way and pass through the hybrid circuit to the field telephone line.

At the other end of the link, the unit must be used as a "slave" station, the timing of its transmitted pulses being determined by the pulses re-

ceived from the other end of the link. If this is not done, small differences in pulse-repetition rates would prevent interleaving of the pulses.

The pulse train from the master station is received by the slave station. From the second-detector circuit of the slave receiver, there is filtered out a sine wave having a frequency equal to the pulse-repetition rate.

This wave is formed by the pulse generator into time-modulated pulses to be transmitted by the slave station. By proper adjustment of the phasing control, these pulses may be made to occur during the interval when no incoming pulses are due to be received. Even within the limits imposed by this condition, some shifting of the

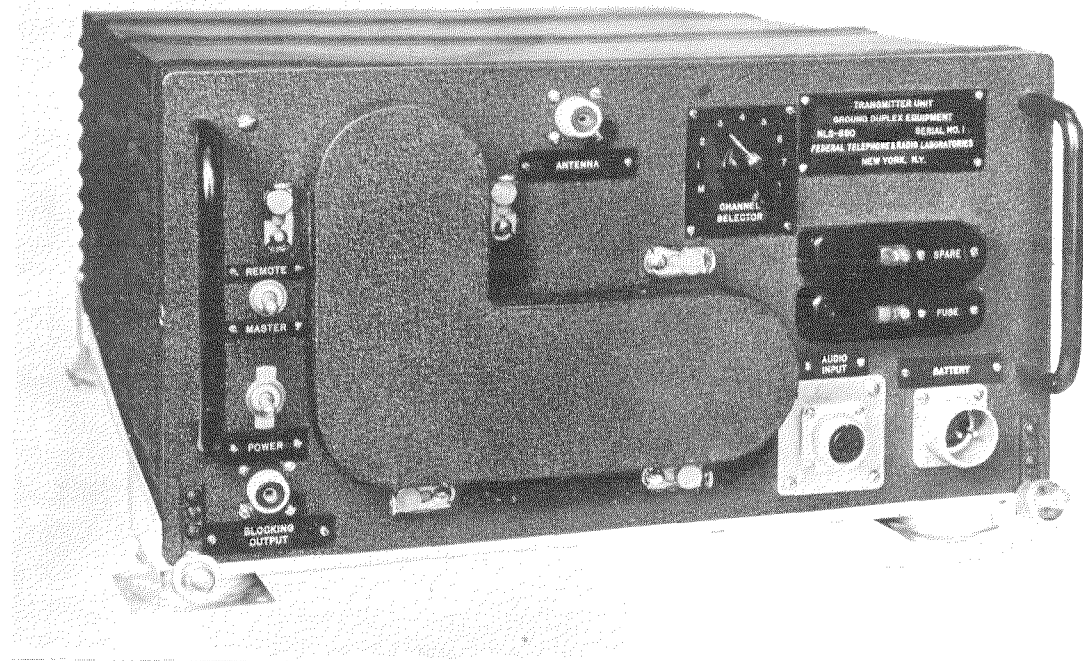

Fig. 3—Experimental pulse-time-modulation transmitter designed to operate with the U. S. Army EE-8 field telephone system.



Fig. 4—Experimental receiver to operate with the transmitter shown in Fig. 3.

phase will be required, depending on the time of transmission of the pulses from one end of the link to the other, to insure that at the master station the incoming pulses do not conflict with the transmitted pulses. This adjustment is not difficult and need be performed only once for any given spacing of stations.

The relative timing of pulses and waveforms throughout the system are shown in Fig. 2. This diagram indicates how the duplex operation is accomplished without interference between incoming and outgoing pulses. As the equipment is not transmitting at the same time that it is receiving, it is possible to use a single antenna for both units, even though they may be operating on the same channel.

## 2. Equipment

Two terminal equipments were constructed and tested at some length in the field. The transmitter and receiver are shown in Figs. 3 and 4, respectively. They are of identical size, being

15 inches by 19½ inches by 7½ inches. The transmitter had a peak power output of 400 watts and an average power output of 5 watts. It was used with an antenna consisting of a dipole in front of a screen reflector. The system operated between 225 and 285 megacycles per second.

A voice-frequency ringing converter has been included in the equipment, so that when conventional field telephones, such as the military type EE-8, are connected to the terminals of the equipment, they will operate exactly as though a wire connection had been provided, ringing and talking in the normal way. This operation is possible even though several miles of wire are interposed between the field telephone and the terminals of the radio equipments.

In field tests, excellent operation has been secured over a line-of-sight path of 23 miles and over a somewhat obscured path of 7 miles. Under these conditions, communication has been observed to be equal to, or better than, the standard telephone circuits.

# Progress of Telecommunication Services in British Post Office \*

## 1. Telephone Exchanges

**T**HE POLICY of the General Post Office is to have automatic working at all exchanges and, before the war, the conversion of existing manual exchanges to automatic working was progressing at a rapid rate. At the outbreak of the war, work on mechanisation had to be curtailed to essentials; in some cases equipment which was being manufactured was completed but stored for installation at the end of hostilities.

During the war, there was a tendency for the number of automatic telephones to decrease because automatic exchanges destroyed by enemy action were replaced by manual exchanges. In 1921, there were 16 automatic exchanges; by 1935, these had grown to 1600, and at the present date there are over 3700 automatic exchanges. Since the end of the war, there has been great difficulty in replacing exhausted exchanges, converting manual exchanges, and extending exchanges that have been overloaded for a long time because of the very great difficulty in getting buildings and equipment.

Priority for building materials and labour is given to the building of new houses and to the repair of buildings damaged during the war. The amount of building which can be provided for telecommunications is only a very small proportion of what is required. Consequently, many expedients have had to be adopted to extend the lives of exchanges and to avoid the need for buildings. At those exchanges where no other method of giving relief is possible, it has been decided that pre-fabricated buildings will be used. The requirements for exchange and subscribers' equipment cannot be fully met by manufacturers because of the competing demands for materials and labour for essential needs, such as export, fuel and power, and railways. The service, however, continues to expand and the rate of installation of subscribers' telephones is now about double the pre-war rate.

\* From material and illustrations supplied by the British Post Office.

## 2. Mobile Unit Automatic Exchanges

Immediately before the war, it was decided to install, experimentally, a few unit automatic exchanges (UAX) on special motor chassis. These were designed for installation at short notice in cases where service could not be maintained at an existing manual or automatic exchange as a result of damage or other unforeseen circumstances. During the war, 14 mobile exchanges were produced, of which 2 were supplied to the War Office, the remainder being kept in reserve by the Post Office for the restoration of exchanges damaged by enemy action. It was found in practice that they were required only on a few occasions for this purpose.

Although the damage aspect has largely disappeared, an increasing use of unit automatic exchanges has been made in cases in which Sub-Postmasters have found it urgently necessary (frequently on grounds of ill health or advancing age) to ask to be relieved of the work of manual exchange operating and alternative arrangements could not immediately be made. The mobile units have also been useful in converting from one type of exchange to another in an existing building. It has recently been decided to increase the number of units and to retain them as standard items.

## 3. Improvements in Telephone Switch-Rooms

### 3.1 LIGHTING

During the war, many switch-rooms were permanently "blacked out," and, in consequence, much attention has been directed to the question of artificial lighting. A number of these exchanges were provided with fluorescent tube lighting, and, as a result of this experience, a series of experiments with this type of lamp is being carried out at selected exchanges to determine the best lighting arrangements.

### 3.2 HEIGHT OF SWITCH-BOARD

Standard switch-boards are made in two heights, 4 feet 8½ inches and 6 feet 4½ inches.

Where the vertical multiple is high, the operating effort is increased, and it also tends to give the staff a "shut in" feeling, particularly where the ceiling is low. In present designs, arrangements are being made to use the lower type of switch-board wherever possible.

### 3.3 COLOUR AND FINISH OF SWITCH-BOARD

The standard finish of polished mahogany has been criticised on two grounds. First, it makes the switch-room dark and gloomy, and second, it can give rise to unwanted reflections. As an experiment, a switch-board is being finished in limed oak, which is light in tone and has a surface that is practically matt.

### 3.4 KEYSHELF

This is covered with red fibre on present designs; fibre is one of the few materials that will stand up to the wear and tear experienced. An experiment with green fibre is being undertaken, as it is thought that this will have a more pleasing appearance.

### 3.5 MULTIPLE

The multiple face accommodates strips of jacks and lamps, labels, and plain strips to fill up spare capacity. A number of experiments involving the use of various colours and new materials are being undertaken, and polished surfaces are being replaced by matt finishes where possible.

### 3.6 FUTURE SWITCH-BOARD DESIGNS

The cordless type of switch-board is being considered for future exchanges. With this equipment, there is no vertical multiple, and the appearance of the positions can be made much cleaner and more attractive. Also, the physical effort of operating is much reduced. In designing switch-boards for the future, efforts are being made to simplify the operator's work, and attention is being given to motion study.

### 3.7 SWITCH-ROOM LAYOUTS

At present, switch-boards in large exchanges are arranged with their backs to the wall round the sides of the room. With possible future developments such as the cordless switch-board in view, consideration is being given to other ar-

rangements. For instance, switch-boards might be installed back-to-back and in short suites across the width of the room.

## 4. *Private Branch Exchanges*

During the war, a new type of switch-board was developed for use in large manual installations. This, the P.M.B.X. No. 1A, supersedes the C.B. No. 9. Its principal advantages are that it employs lamp signalling, and it is constructed of standard parts; it is also more compact, and is now standard for installations of over 180 lines.

This new equipment is a 24-volt CB-type multiple switch-board, with capacity for 800 extensions and 160 exchange lines, private circuits, or inter-switch-board lines. It is built up in one-position two-panel sections. The extension multiple is made up of strips of 20 jacks of the break-jack type, and the exchange line multiple is of strips of 10 jacks of the branching type. Both multiples have a four-panel repetition.

There is no separate answering field, calling lamps being fitted in the multiple and associated with selected appearances of the lines to which they relate. Each extension has a single calling lamp, while exchange lines are given a second ancillary lamp at a different multiple appearance.

The design also embodies a "follow-on call trap" which, in cases where an extension-to-exchange connection has not been cleared at the private branch exchange, prevents a fresh incoming call from ringing the extension bell and gives a supervisory flash instead. Also included is a "calling in" facility, whereby an extension user can press a special button to flash the private branch exchange operator during a call to the public exchange without disconnecting the call.

## 5. *Local Lines*

In the pre-war period, meticulous and exhaustive development studies were made throughout the country in order that the planning of local line networks might be placed on a sound footing. During the war, owing to dispersal of industry, evacuation of the population, war damage, and demands of the armed forces, these studies became more and more out of date. Subsequently, the return of many businesses and

evacuees to the towns, closing down of war installations, redistribution of industry, and replanning of industrial development, produced further complications. As a result, the existing development studies are in need of drastic revision, and this work is already in hand. In the meantime, special studies are being made in areas where there is an urgent need of new plant to meet accumulated demands for telephone service. Completely new studies must be made in certain towns, e.g., Liverpool, where records were destroyed by bombing, and joint engineering and commercial surveys are being made in this connection.

Good progress is being made with duct- and cable-laying schemes, and the provision of auxiliary joints and cross-connection frames in street cabinets and pillars will ensure the flexibility that is so necessary during periods of unforeseen development. As a result of improvement in telephone instruments, it may be possible to use lighter-gauge conductors than hitherto and effect corresponding economies in local cable schemes.

In country districts, new distribution points are being created and new lines provided at an unprecedented rate. Pole shortage and the uncertainty of future supplies of timber suitable for poles have compelled the recovery of poles from abandoned routes. The use, in spite of higher costs and the need for special fittings, of non-wooden poles is being considered.

### **6. Rural Areas**

The policy of the Post Office is to provide service in country districts by means of small, unattended, automatic exchanges, and to install such an exchange in any area where a minimum of eight subscribers is forthcoming. This policy involves the conversion of all small manual exchanges in rural areas to automatic working, and has also led to the opening of a very large number of new exchanges. Between the wars, the number of country exchanges was increased from about 1600 to about 4000.

The programme of automatization in rural areas was largely suspended during the war, but will be resumed as soon as conditions permit. Until adequate supplies of equipment are available, however, it will be necessary to concentrate largely on the extension of existing automatic

exchanges rather than on work of conversion of manual exchanges.

Telephone service at standard rentals is available to anyone within three miles of an exchange, an additional charge being made where this distance is exceeded. The extent of the coverage is now such that there are comparatively few localities that are more than three miles from an exchange.

### **7. Public Call Offices**

It is the policy to provide a kiosk in every village where there is a post office. While much work under this policy has already been carried out, it was almost entirely suspended during the war. It is now being resumed.

In villages where there is no post office, a kiosk is provided on payment by the local authority of £4 a year for five years, the pre-war rental of a private subscriber's line in the provinces for five years. This covers about 10 per cent of the cost, the remainder being borne by the Post Office; at the end of the five years, the full cost falls on the Post Office.

Between the wars, the number of public call offices in rural areas increased from 4700 to nearly four times this figure.

### **8. Local Exchange Service**

In London and the four largest provincial cities, Birmingham, Glasgow, Liverpool, and Manchester, the director-type automatic equipment is in use although there are numbers of manual exchanges still to be converted. The London system consists of an area enclosed by a circle of  $12\frac{1}{2}$ -mile radius round Oxford Circus, and subscribers connected to all but the very earliest type of director exchange can dial directly to all other exchanges in the system. The call fees are recorded automatically.

In the provincial director areas, the ultimate size of the systems will be a circle of  $9\frac{1}{2}$ -mile radius, although at present there are only 3 director exchanges beyond the original boundary of the systems, which was a circle of 7-mile radius. There is multi-metering (i.e., automatic connection and recording of calls with charges up to 4d.) to all exchanges in the provincial director systems, except from a few of the oldest type of exchanges in Birmingham and Man-

chester. The equipment programme includes the conversion of existing manual exchanges in the director systems and the introduction of multi-metering at some of the older exchanges where it was not originally provided.

Plans are now being made to extend the range of direct dialling by subscribers on director exchanges to other exchanges within 20 miles of Oxford Circus, and 17 miles of the centre of provincial director systems. Development work is also being carried out to give multi-metering from automatic exchanges adjacent to a director system to exchanges within the director system; these facilities will be introduced first in the London area. It has been decided to introduce director working in Edinburgh and one director exchange, Craiglockhart, was opened in 1946. The size of the director automatic area in Edinburgh will be a circle of 5-mile radius.

Multi-metering facilities are now given at the largest (director) exchanges and at the smallest (unit automatic) exchanges. Multi-metering is a standard facility for unit automatic exchanges although access to every exchange within range is not always possible because tandem equipment is not available at intermediate exchanges.

The equipment at the medium-sized automatic exchanges and many of the larger exchanges that are not big enough for director

working is of the non-director type. At these exchanges, subscribers at present can dial only to exchanges up to 5-miles chargeable distance. The relay set, which is used to give the appropriate metering, i.e., 1d. on routes up to 5 miles, has been modified to give second, third, and fourth-fee metering so that multi-metering can be given on calls to directly connected exchanges up to 15-miles chargeable distance.

It is estimated that the tandem traffic from non-director exchanges is small, that it is generally about 5 per cent of the total untimed junction traffic and rarely rises above 10 per cent. This tandem traffic could be completed automatically by using equipment that would correctly route and register traffic passing over one route. The equipment is relatively expensive and not easy to maintain. It is probable that the automatic completion of the small amount of tandem traffic will not prove to be justified economically.

The development of the relay set to give multi-metering on directly connected routes has recently been completed, and data are now being finished for the design of equipment to provide multi-metering facilities at several new and existing exchanges. For the present, it is not proposed to make any arrangements for the multi-metering of the non-director tandem traffic.

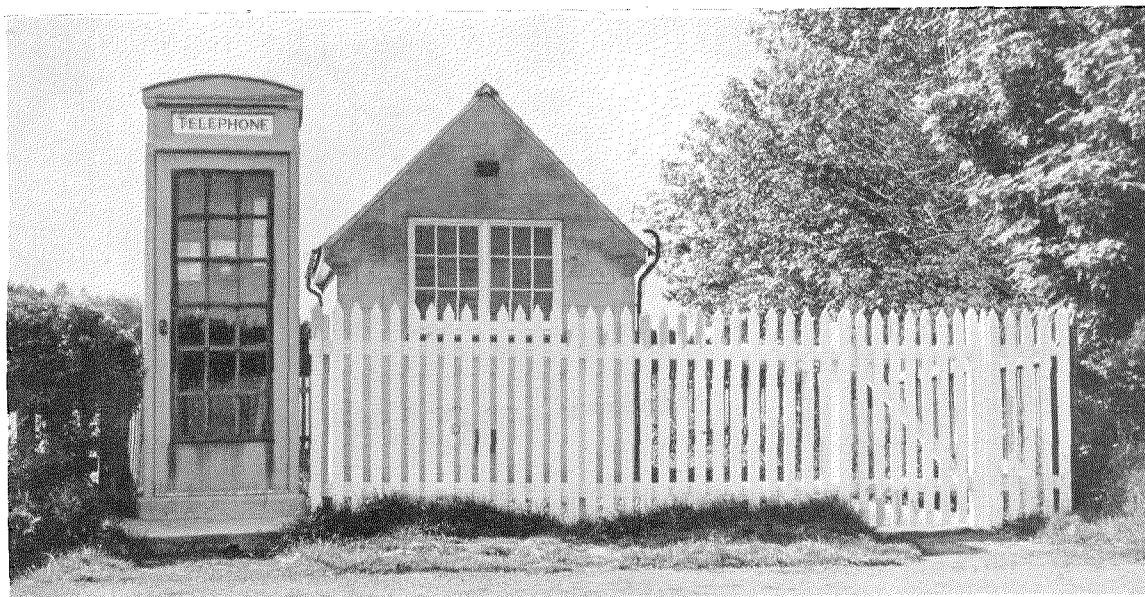

Unattended automatic exchange and kiosk at Beal, Northumberland.



### 9. Provision of Telephone Service

During the war, the Post Office suspended the provision of all local subscribers' cables other than those immediately required for war or war production purposes, and the same policy was followed in regard to extending telephone exchanges. The Post Office also released 16,000 of its 41,000 engineers for service with the Forces. It was, therefore, impossible to meet many applications from the public for telephone service and, when the war ended, the outstanding applications amounted to 250,000. The difficulty of dealing with this accumulation of orders was added to by the receipt of new orders at an unprecedented rate. During 1946, the average demand was for 70,000 telephones per month, which is more than double the prewar figure. A peak was reached in October, 1946, when the demand reached 83,000, but it has now fallen to

a fairly steady rate around 45,000 per month, which is about 50 per cent higher than before the war.

The rate of installation of new telephones was stepped up considerably in 1946 as engineering staff returned and reached 70,000 per month, but the effect of this rapid rate of connection was to use up reserves of exchange equipment and spare wire in underground cable. The amount of engineering work and materials required to connect a given number of subscribers has steadily increased, and it has not been possible to maintain the high rates achieved last year. The present rate of installation is about 53,000 per month as compared with 31,000 before the war.

Despite the efforts which have been made, the outstanding applications for exchange lines now amount to 450,000. The spare exchange equipment is exhausted at about a fifth of the exchanges and there are no spare wires in the under-

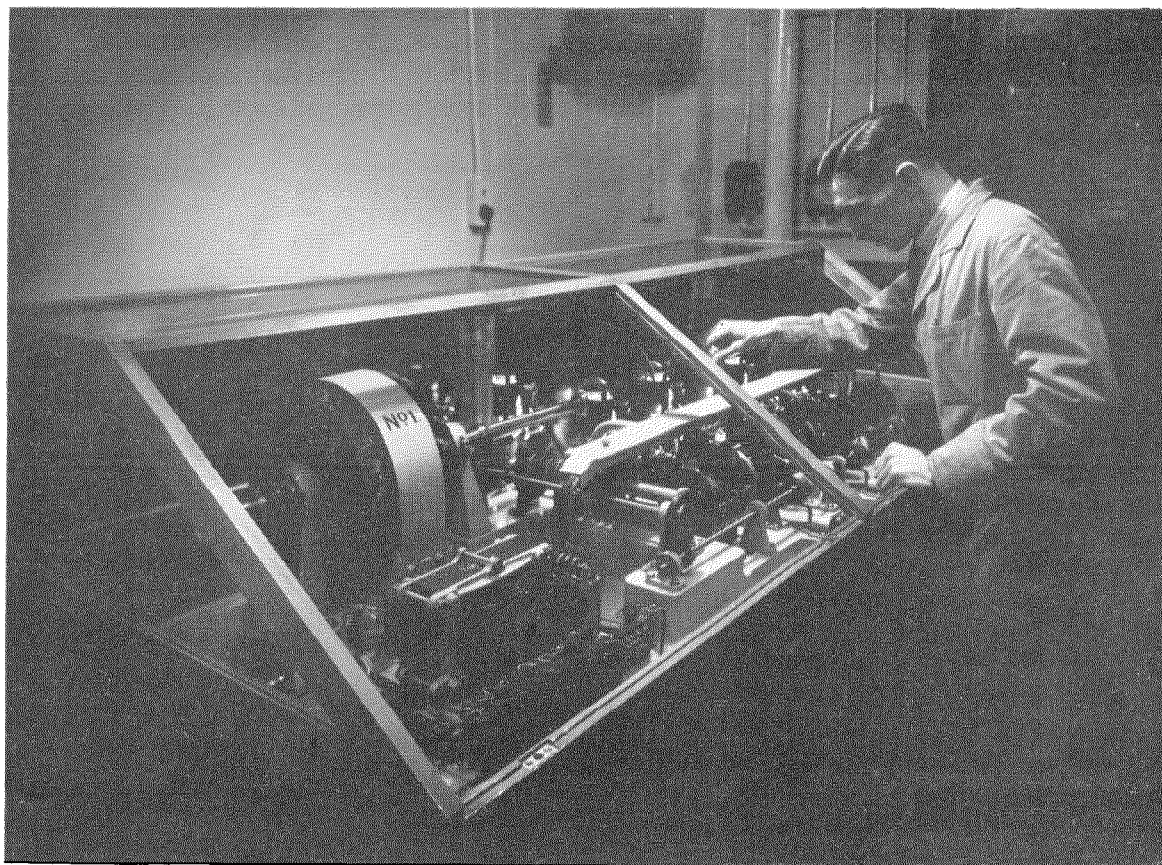

The speaking clock shown above announces the time within an accuracy of 0.1 second. It may be dialled directly in certain exchanges and obtained through operator's connections in some others.

ground cables serving a third of the distribution points. In this country therefore, as in America, the provision of telephone service to many ordinary applicants is subject to appreciable delay. It is still necessary to impose limitations on the amount of constructional work undertaken to connect an individual subscriber, and a system of priorities is in operation to ensure that telephone service is provided first to those with a special claim in the public interest.

The Post Office has an ambitious programme for the extension or replacement of telephone exchanges and the expansion of the underground plant but the fulfilment of these plans is being seriously handicapped by inadequate supplies of stores and equipment, due mainly to shortages of raw materials.

#### **10. Emergency Call Service**

This service is provided to enable a telephone user on an automatic exchange to obtain, in an emergency, by dialling "999", an immediate reply from the auto-manual board operator who is able to connect to the police, fire, or any other emergency authority without delay. No coins are required to obtain such a call from a coin-box telephone. The service was available at London and Glasgow before the war. Since the war, it has been installed in all but the smaller automatic exchanges.

#### **11. Speaking Clock**

This service is available to subscribers on automatic exchanges in London and 13 other towns and cities, and on the manual exchanges in London, Birmingham, Glasgow, and Manchester. To obtain the time, subscribers dial TIM in director areas and "952" in non-director areas. They are connected automatically to a speaking record of the time which is accurate to 1/10 of a second. Calls to the speaking clock cannot be obtained automatically from call offices but are obtained by calling the operator who connects the calls manually.

#### **12. Long-Distance Telephone Service**

During the war, the provision of circuits for the public service did not keep pace with the increase in traffic, as a very large proportion of the new plant laid down by the Post Office during the war years was used to provide private wires

to meet the needs of the defence forces and the armed forces of the allies stationed in Great Britain and Northern Ireland; also, the Post Office suffered a heavy loss of trained technical staff to the signals branches of the navy, army and air force. Although some temporary staff, including women, was recruited to take their places, the numbers were fewer and, of course, they were less skilled and lacked the experience of the regular staff. There was, in consequence, a deterioration in the quality of the long-distance service and also in the maintenance of the plant, which in turn added to the service troubles resulting from bombing, congestion of traffic, etc.

Despite these difficulties, traffic is now about 80 per cent higher than when the war began, the number of long-distance calls completed each week being almost 4½ million compared with about 2½ million in the corresponding period of 1939. With the very active state of business throughout the country, traffic is still growing. Doubtless the war-time dispersal of factories and the evacuation of populations from towns to less vulnerable districts, with the consequent separation of families, has fostered the "telephone habit." Moreover, despite a 50 per cent increase of the trunk-call charges, the service is still inexpensive, the highest rate being 3s. 9d. for 3 minutes for any distance of more than 125 miles.

Since D-Day, large numbers of the private wires provided for the defence and armed forces have been relinquished and those found suitable have been added to the public system.

The number of circuits of over 25-miles chargeable distance now (July, 1947) totals about 13,600 compared with 6775 in April, 1939, an increase of about 100 per cent. This increase in the number of circuits, together with an easing in the staff situation, has resulted in a rapid improvement in the service and, except for a few routes on which a shortage of circuits still exists, the pre-war speed of connection has been largely restored. There is still a shortage of experienced operating staff, however, particularly in London, where the speed of answer, though steadily improving, is not yet back to the pre-war standard.

Before the war, the long-distance service was designed to enable 90 per cent of calls made

during the day-time to be completed on demand, and it is now the aim to provide sufficient circuits to enable 98 per cent of calls to be completed on demand. For the provision of circuits necessary to meet this improved standard, and to cater for general growth in the volume of traffic, plans have been made for the laying of an extensive network of coaxial cables linking all the main towns. Many of these coaxial cables will include up to 400 audio-frequency pairs to cater for toll circuit requirements, and by this means the laying of separate audio-frequency cables will be avoided and full use made of all available duct space.

### **13. Trunk Service—Direct Dialling**

It is possible for operators in trunk exchanges to dial directly to subscribers at distant centres by transmitting over the trunk lines dialled impulses of direct current or of alternating currents of certain frequencies within the frequency range of the human voice. This is already employed on a large number of short- and long-distance routes, and the scope of such systems is being progressively extended so that within a number of years trunk operators will be able to call most subscribers within the United Kingdom simply by dialling and without the need for another operator.

It is not proposed, at least in the immediate future, to arrange for direct dialling of trunk calls by subscribers.

### **14. Mechanical Trunk Fee Accounting**

Recently, methods of mechanising the accounting for subscribers' trunk calls have been investigated with a view to eliminating the present tedious and laborious manual sorting of tickets on which calls are recorded. The proposals at present being considered would involve the replacement of the present paper tickets by cards that would be perforated, after leaving the exchange, with holes corresponding to the manuscript data recorded thereon. The tickets would then be sorted at high speed by machines into subscribers' number or any other order necessitated by the accounting processes, e.g., tickets from non-consecutive private-branch-exchange lines would be picked out for association with the tickets for the main number. It is prob-

able that the pricing of trunk tickets would be performed mechanically if the schemes under consideration were adopted. After punching and sorting, the cards would pass through a tabulator, which is a machine capable of listing all the particulars on the cards, carrying totals, and printing these as required. Thus the subscriber's trunk statement would contain an abstract of the data recorded on the tickets, as much or as little information as required being supplied. It is, in particular, desired to furnish subscribers with the name of the exchange called on trunk calls.

There are hundreds of millions of trunk tickets handled every year, and it is hoped that considerable staff savings would be achieved from mechanising the accounting processes. As an offset, more expensive machinery would be required, but it is hoped that overall savings would result. It should be fairly easy to extend the mechanical system to deal with rentals and local calls, if this were found to be useful and justifiable.

### **15. Census of Long-Distance Telephone Traffic**

In October, 1945, the British Post Office took a census of long-distance telephone traffic to obtain information on which to base post-war traffic and cable network planning. Full details from all tickets prepared on three normal days were entered on cards which were subsequently perforated for analysis by the punched-card system. Some 800,000 cards were mechanically sorted to provide a record of calls from each trunk centre to every other trunk centre during each half-hourly period throughout the day, thus enabling a more accurate estimate of relative degrees of community of interest between trunk centres to be made. The addition to the cards of perforations corresponding to the standard routing of the calls made possible a further analysis showing the amounts of traffic proper to each existing route.

The volume of traffic in each charge step and the revenue obtained from this traffic has been analysed, but this leaves a considerable amount of data which can still be extracted from the census figures including, to quote one example, the proportions of the various types of call, e.g.,

personal, transferred charge, and fixed time, made from each centre over various distances and the times at which the demand for these services reaches a peak.

**16. Trunk Network**

During the war, the British trunk network was rapidly expanded as a result of defence requirements, and 12-channel carrier now forms the backbone of the system, audio-frequency cables being used for shorter junction routes. The 12-channel standard units, with appropriate modulating equipment, may be worked over (A) a paired cable of 14 or 24 pairs in which each pair may carry up to 24 channels and separate cables are used for "go" and "return," (B) an air-dielectric coaxial cable, in which each tube carries up to 600 channels in one direction, or (C) a solid-dielectric coaxial submarine cable, in which the number of groups is limited by the attenuation of the cable between adjacent repeaters.

**17. Radio Links—Development for Public Traffic**

In the past, extensive use has been made of ultra-short waves (60 megacycles per second and above) for radiotelephone communication over sea routes up to 100 miles. Many of these have been multichannel amplitude-modulated services. In some cases, the radio link has

served to carry the 12 channels of a line carrier system without demodulation to audio frequencies at the radio terminals. A development in recent years has been to apply frequency modulation to these 12-channel radio systems with resulting improvement in intermodulation characteristics and in signal-to-noise ratio. A number of such systems are in operation or are planned.

**18. Inland Telegraph Service**

Just before the war and after an exhaustive study of the traffic characteristics of the British



Teleprinter switch-room in Manchester.

telegraph service, it was planned to install an automatic teleprinter switching system by which any telegraph office equipped with teleprinters could communicate directly with any other teleprinter office. War broke out before the first installation was started, and the heavy commitments of work for the armed forces prevented the scheme being carried out. This resulted in the retention of the existing point-to-point system which, by reason of its heavy concentrations of traffic at the large towns, was particularly vulnerable to air attack. To reduce these concentrations as far as possible, a policy of dispersal was adopted by which traffic circulated through the smaller towns, but which, in consequence, increased the number of retransmissions. To counter this effect, which was aggravated by a substantial increase in traffic, a manual switching scheme was planned and installation of the first two switch-boards began in 1943. This scheme has developed steadily since that date, and six switching centres are now installed and working. Approximately 150 offices will be connected to the system and something like 100,000 telegrams per day signalled over it when it is complete.

In February, 1945, when it was evident that the end of the war was not far off, steps were taken to begin the preliminary work for recommencement of the automatic switching programme. Much valuable knowledge of telegraph switching schemes had come from the war-time experience and the pre-war design was entirely re-examined and improvements made. In particular, it has been decided to abandon the use of the standard Post Office No. 3 teleprinter and to adopt one using the International Teleprinter Alphabet No. 2. The commencement of the scheme is planned for 1949, and it is hoped to complete it by 1954. Ultimately, approximately 700 teleprinter offices will be connected and will be given full inter-communication by dialling. There will be 26 automatic switching centres. The system will incorporate certain new features such as automatic return of the answer-back signal and suspense conditions on calls to engaged lines.

A system of automatic distribution of calls from telephone subscribers wishing to dictate telegrams is also being developed. The principles are similar to those used in such systems in other

countries, that is, distribution to disengaged operators, and storage and queuing when no disengaged operator is available. The usual waiting call indicators will be provided.

### ***19. European Telegraph Services***

Voice-frequency telegraph systems on coaxial submarine telephone cables have been set up and improved performance and a considerable increase in the number of telegraph channels to the continent have resulted. The additional channels provide a sufficient margin to permit the establishment of private telegraph circuits for the larger users between Great Britain and the continent, and also for the development of Telex services with the continent, thereby catering for short-duration connections between teleprinter renters in Great Britain and the continental countries. Telex service with Belgium, Holland, and France has been established, and it is hoped to open service to Switzerland shortly.

### ***20. Extra-European Telegraph Services***

The public telegraph services between the United Kingdom and places outside Europe are operated by telegraph companies, and not by the British Post Office. Telegrams for all parts of the world are, however, accepted at all postal telegraph offices.

### ***21. Development of Overseas Telephone Services***

During the war, international telephone communication was almost at a standstill. All land-line communication with the continent of Europe had ceased by the time France was overrun; the radiotelephone services were maintained only when absolutely necessary and then under severe censorship restrictions.

From D-Day onwards, telephone and teleprinter circuits have been progressively restored, first for the use of the armed forces for communication between bases in England and advanced positions on the continent, and later for public service.

Plans for post-war development are based on carrier technique and take advantage of the lessons learned in the manufacture, laying, and use of the carrier cables across the English Channel during the final phases of the war.

The majority of the cross-channel cables that were cut during the war had been designed for audio-frequency use although a few had been designed for carrier working; the full facilities amounted to about two hundred circuits. Circuits in the war-time carrier cables have been set up as public-service circuits and work in the manufacture and laying of new coaxial carrier cables is well in hand to meet future needs.

To cater for Anglo-French requirements, two of the cables laid during the war provide 60 channels per cable and, when the 1939 St. Margarets Bay—Calais carrier cable is repaired, an additional 168 circuits will become available.

Traffic between Britain and Belgium is already considerably in excess of the pre-war level. Many additional circuits will be required, not only to meet the needs of Belgium, but also of services beyond. The provision of a new single-core coaxial cable of a larger and improved type is in hand and will yield over 200 circuits.

To extend the additional French and Belgian circuits from St. Margarets Bay to London and to cater for possible television requirements, a four-tube coaxial cable is to be laid, which will be able to provide for up to 1200 circuits. Simultaneously, the French and Belgian administrations are making plans for extending the circuits across their countries.

A new cable is already in course of manufacture for the Anglo-Dutch route which, it is hoped, will be ready for service by the end of 1947. The cable, which will be 86 nautical miles in length, will be of the coaxial type similar to that which

is proposed for the new Anglo-Belgian cable. The possibility of fitting ultimately two submerged repeaters to make the cable capable of providing 250 circuits is being considered.

Thus the British Post Office, in conjunction with the other administrations concerned, is looking well ahead. As a member of the Comité Consultatif International Téléphonique, Britain is participating in a study of the problem of providing an "on demand" service in Europe, and is planning its communications accordingly.

On the overseas radiotelephony side, the services have been extended to meet the growing demand, and additional services are opened as and when the need arises. The Rugby transmitting station is to be extended, and a new receiving station will shortly be provided. Single-sideband equipment is available for all services and will be brought into use generally as equipment becomes available at the overseas terminals.

## ***22. Ship-Shore Radiotelephone Services***

The pre-war facility of radiotelephone communication between ship and shore with a link service to the inland telephone system has been restored and expanded. In addition, consideration is being given to the provision of a very-high-frequency radiotelephone service for direct two-way communication between ships and shore to facilitate navigation, docking, etc. in coastal, port-approach, and harbour areas.

# SOJ-12 Open-Wire Carrier Telephone Systems in South Africa

By D. P. J. RETIEF

*Department of Posts and Telegraphs, Pretoria, Union of South Africa*

and

H. J. BARKER

*Standard Telephones and Cables, Limited, London, England*

**A**N SOJ-12 SYSTEM provides 12 additional two-way speech channels over an open-wire pair on which a three-channel carrier telephone system and the usual voice facilities may already be operating. That is, it increases the capacity of a pair from 4 to 16 telephone channels.

With the ever-increasing demand for long-distance communication facilities in the Union of South Africa, the administration has embarked on a comprehensive programme of installing such systems. The initial programme includes 12 sys-

tems, 6 of which are long-haul circuits utilizing one or more repeaters, the other 6 being for short distances, directly connecting nearby communication centres without intervening repeaters. A rough map of these routes is shown in Fig. 1. It is proposed to install 20 additional systems by the end of 1948.

The carrying-out of such a programme involves considerable work on the open-wire lines. The administration has reconstructed and re-transposed all existing routes concerned, and has on hand the building of some 2000 to 3000 miles

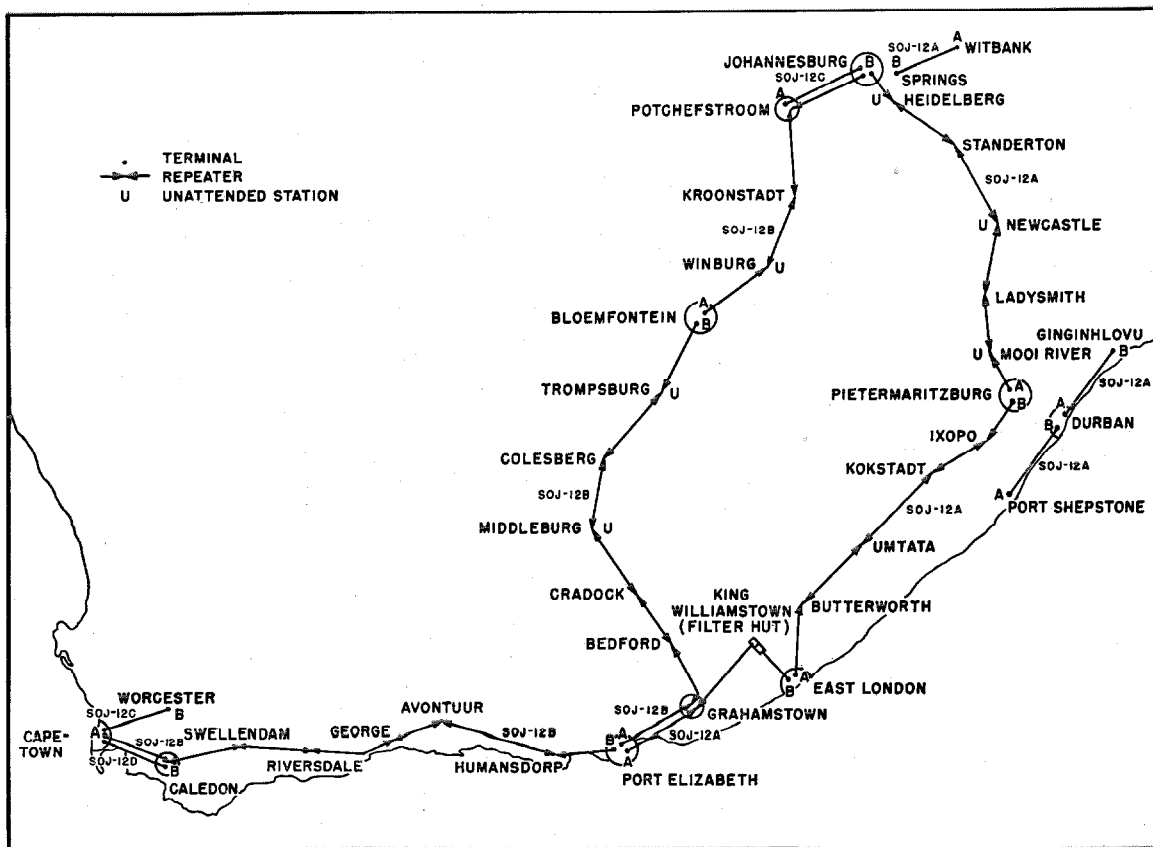

Fig. 1—Map of the initial 12 SOJ systems installed in the Union of South Africa.

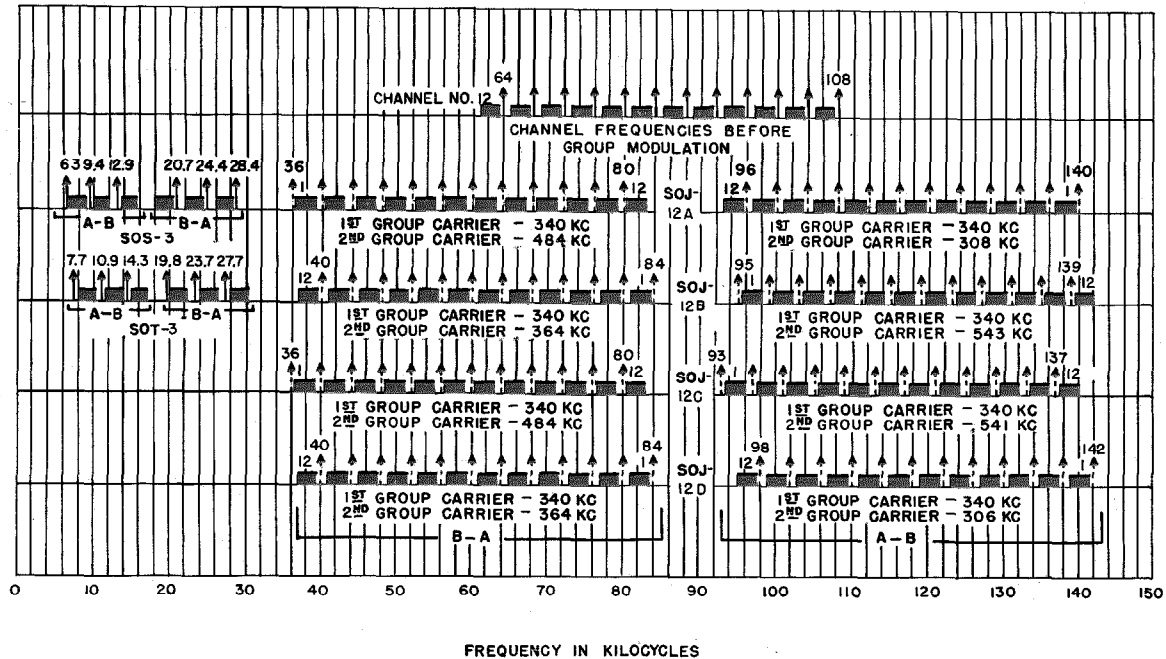

Fig. 2—Frequency pattern of the four variations of the SOJ-12 system. Real carriers are shown by solid arrows and virtual carriers are indicated by dashed arrows. The SOS-3 and SOT-3 systems have been included to show how the SOJ-12 may be added to circuits already using these 3-channel equipments.

of new J-type trunk routes, suitable practices being followed to enable further SOJ systems to be added at a later date, up to a total of from 8 to 12 systems.

It is the purpose of this article to describe the application on the Johannesburg-Bloemfontein route of the first SOJ system to be installed in the field.

**1. SOJ System**

The system operates on a "grouped-frequency" basis, i.e., different frequency groups are used in the two directions of transmission on the line, equivalent to 4-wire operation over the pair. Four variants of the system are available, designated SOJ-12A-D, utilizing frequency inversion and staggering to ease the problems of transposition design and crosstalk whenever more than one system is required to operate on a route. Similar principles are already widely used in the application of three-channel carrier systems. The frequency allocations are shown in Fig. 2.

Figs. 3 and 4 show the block schematic arrangements of typical terminal and repeater stations. Outgoing speech currents on each of the

12 channels pass to the copper-oxide modulators and crystal band filters and then to a common transmitting group circuit. Interposed between the modulators and 4-wire terminating sets are 2-wire to 4-wire switching circuits, which provide the facility for extending each channel on a 4-wire basis as an alternative to the 2-wire termination.

As shown in Fig. 5, the frequency range occupied by the channels at this stage extends from 60 to 108 kilocycles, the lower side-bands of the 12 carrier frequencies, 64, 68, . . . , 108 kilocycles, being selected by filters. The equipment providing this 'basic' group of 12 channels is common to SOJ-12, coaxial, and 12-channel cable systems.

The group of 12 channels passes through a filter, which further suppresses the channel carrier frequencies, to a hybrid coil where two pilot frequencies are introduced and thence to the first group modulator to which a carrier frequency of 340 kilocycles is applied. The upper side-band, occupying the range from 400 to 448 kilocycles, is selected by a filter, and the signals are raised by an amplifier to a suitable level for application to the second group modulator. The



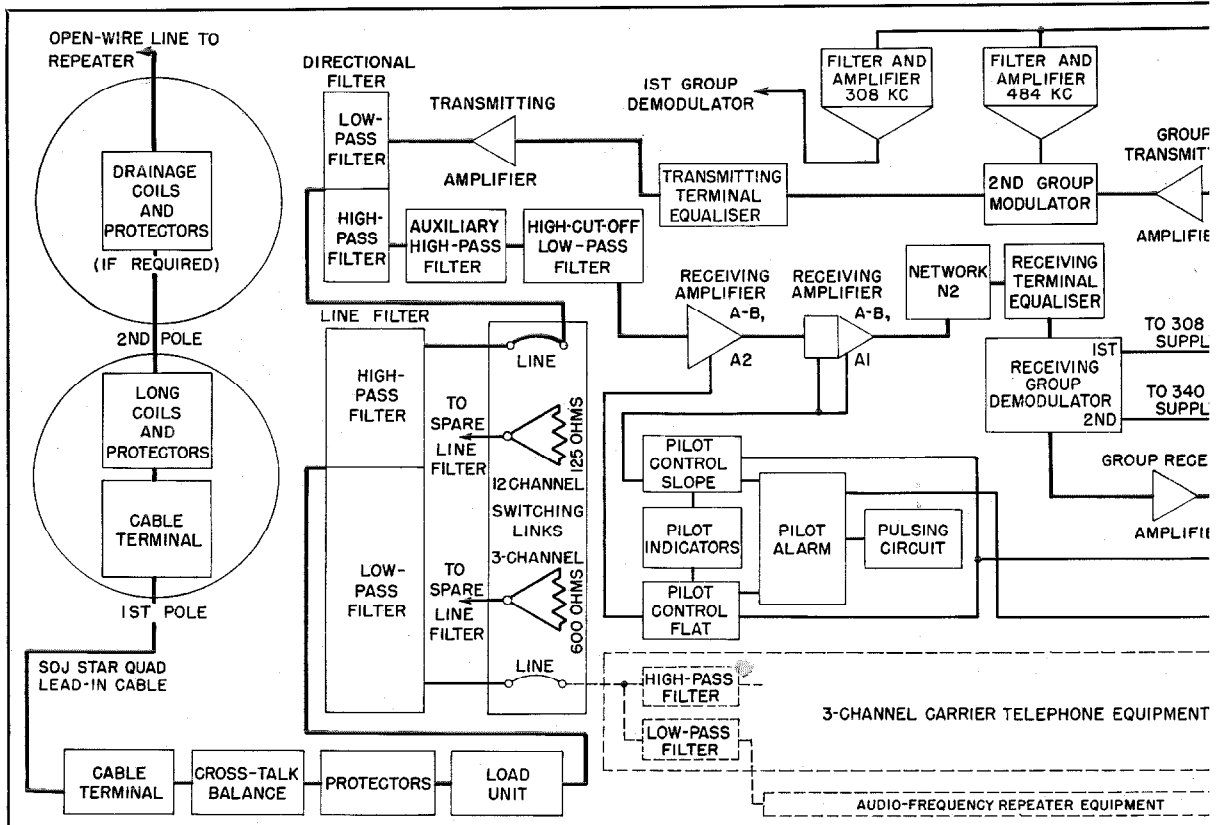

Fig. 3—Schematic of a "B" terminal of a typical SOJ-12A equipment. No filter hut is shown.

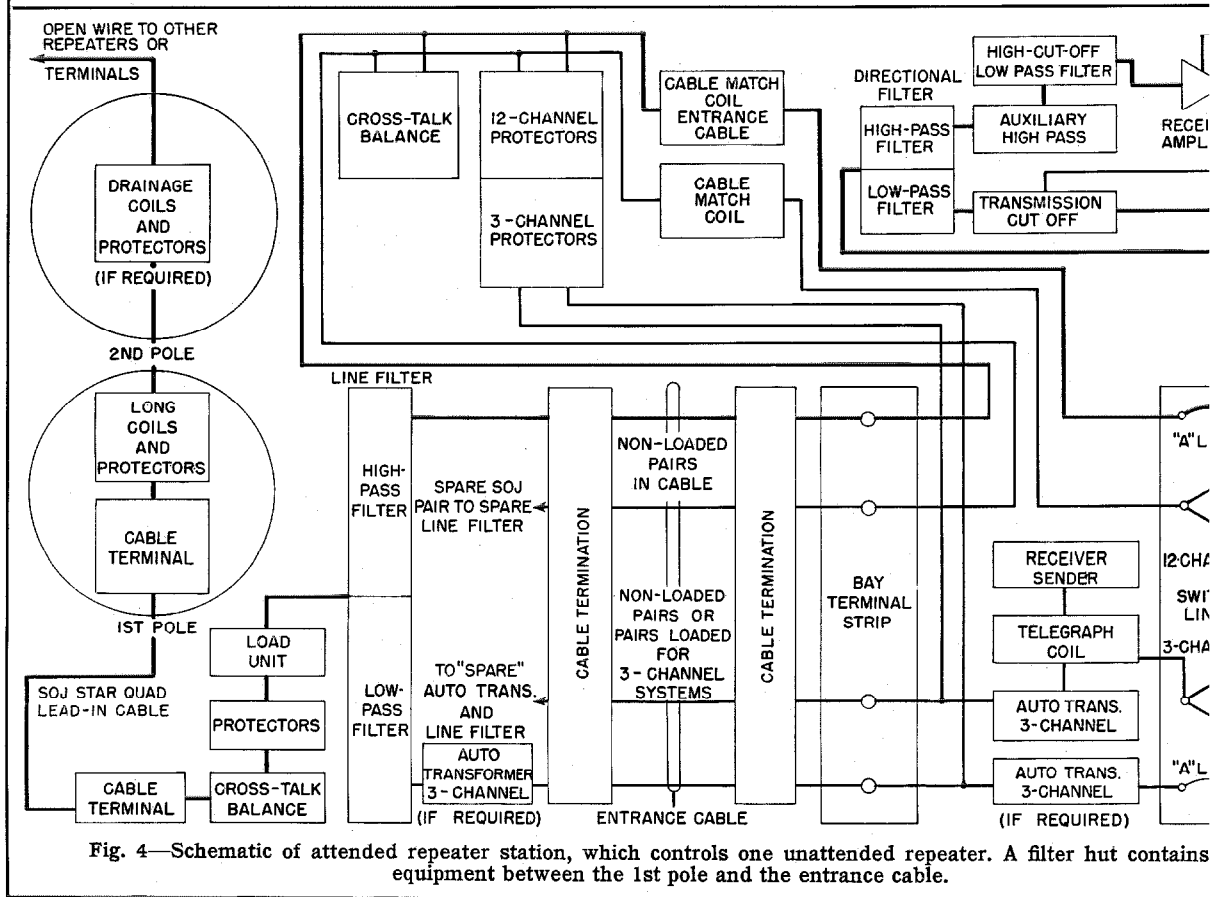
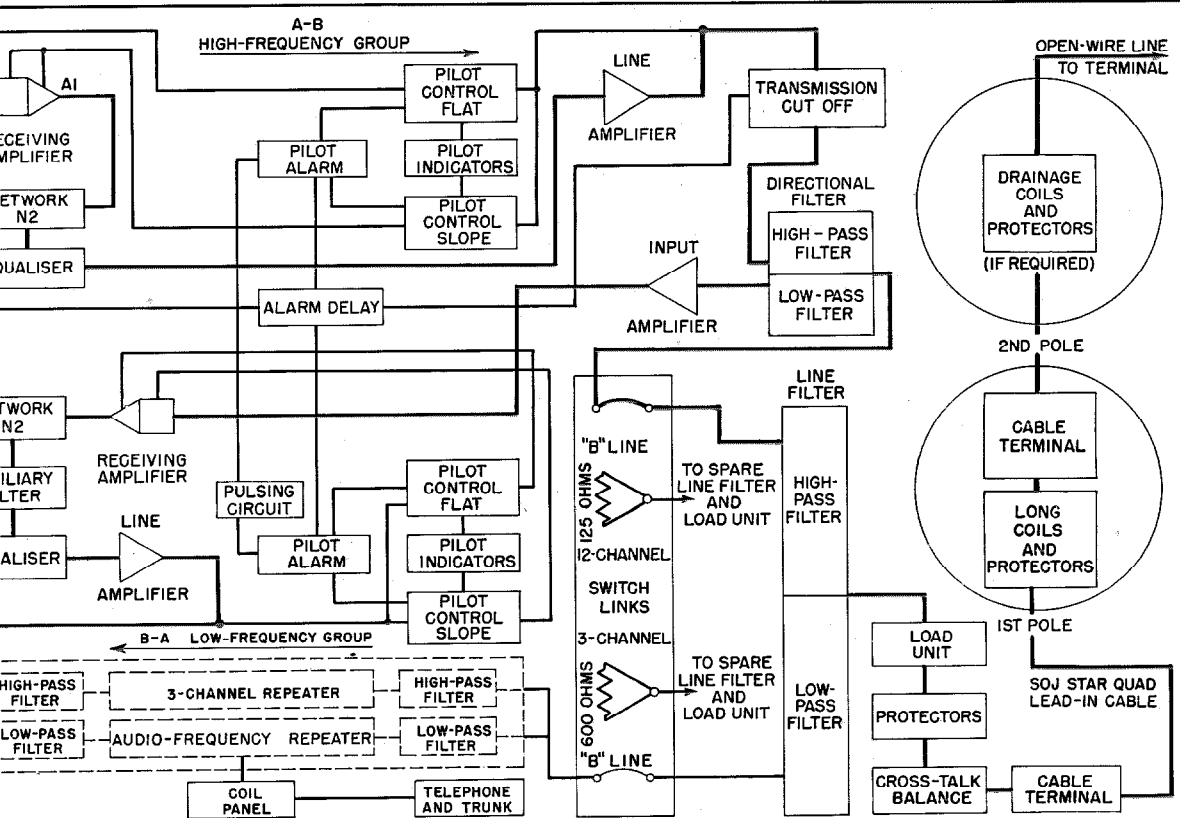
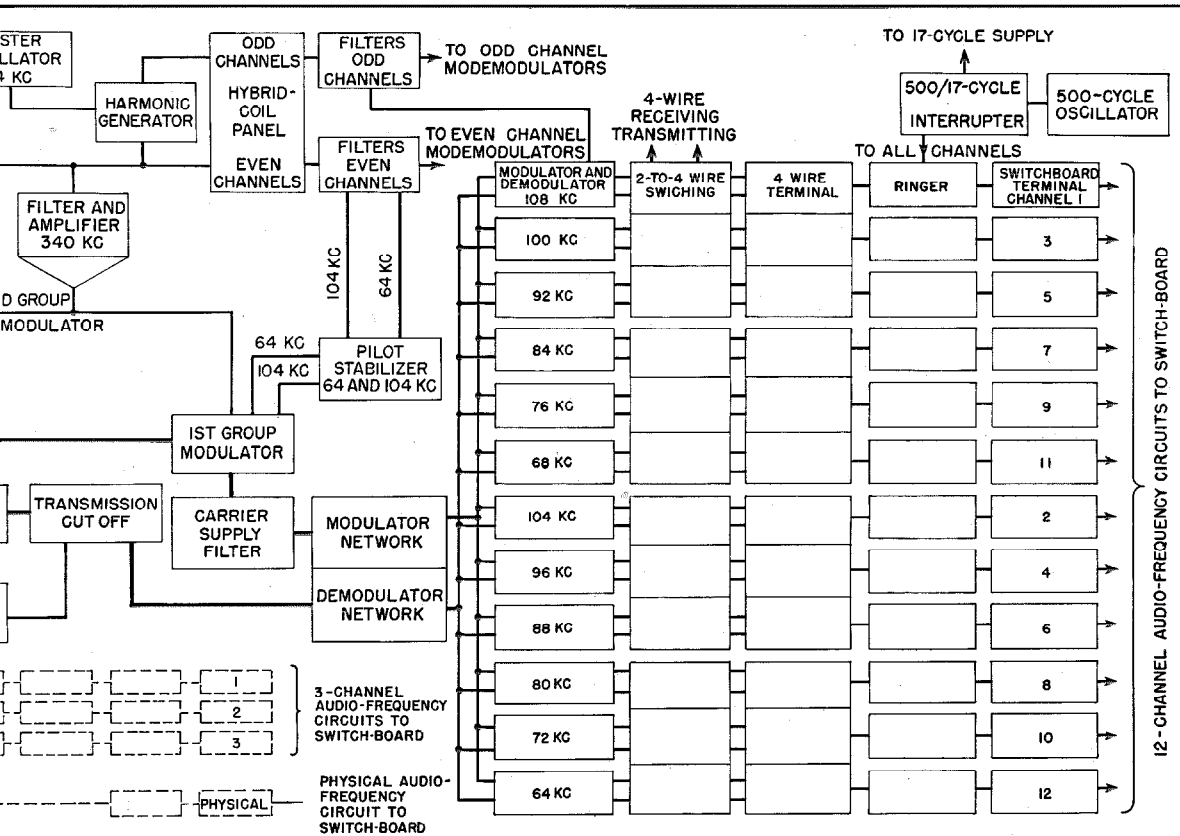

Fig. 4—Schematic of attended repeater station, which controls one unattended repeater. A filter hut contains equipment between the 1st pole and the entrance cable.



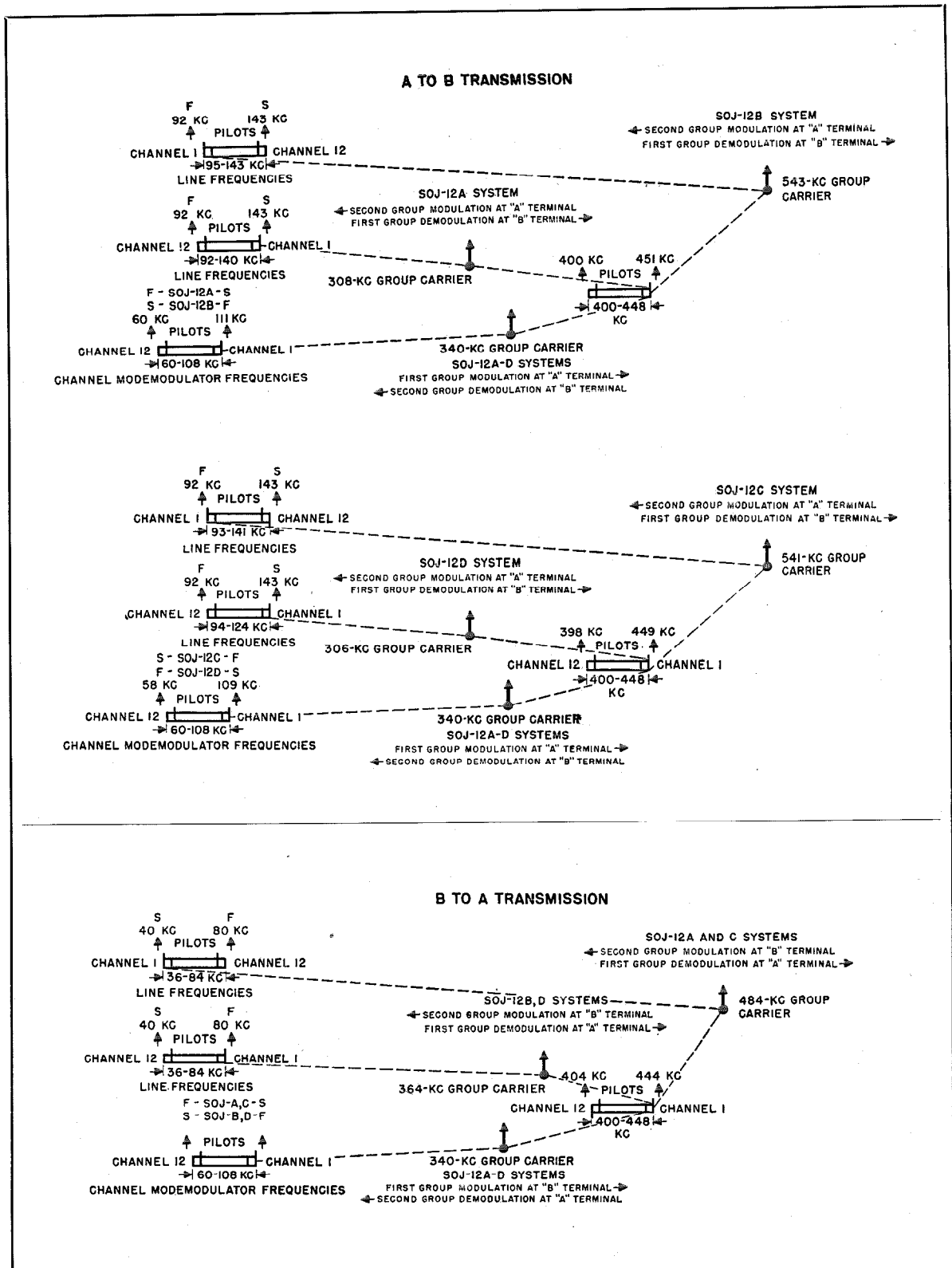

Fig. 5—Group-frequency translations of SOJ-12A-D systems. F denotes flat- and S, slope-gain-control pilot.

frequency used for the second stage of modulation is dependent on the direction of transmission and type of system, being 364 kilocycles at Johannesburg and 543 kilocycles at Bloemfontein. The output passes through a low-pass filter, which selects the lower side-band of this modulation process. Compensation for the distortion introduced by the various items of equipment is provided in the equaliser to give a nominally flat characteristic over the required line frequency range, i.e., 36 to 84 kilocycles in the direction from Johannesburg to Bloemfontein and 92 to 143 kilocycles for the reverse direction.

The transmitting amplifier, which is designed to combine high gain with large power-handling capacity, raises the signals to a level suitable for transmission to line (+17 decibels relative to the transmitting trunk switch-board per channel). The signals pass to line by way of the directional and line filters and line plant.

On the receive side, incoming signals pass through the regulating equipment, which is described later, to the demodulation circuits, which function in a similar way to the modulating circuits on the transmit side, to translate the incoming line frequencies to the basic group from 60 to 108 kilocycles prior to the final demodulation process for separating the 12 channels.

The carrier supplies are derived from a 4-kilocycle valve-maintained tuning-fork oscillator, which operates into a harmonic generator. These oscillators have a high degree of frequency stability, being maintained readily in practice within 18 parts in a million of the nominal frequency. Odd harmonics of 4 kilocycles are produced in a saturated coil and even harmonics in a copper-oxide rectifier. The frequencies required are selected by crystal filters, followed in the case of the group frequencies by amplifiers to raise the carrier to a level suitable for application to the group modulators.

Three of the group frequencies, namely, 306, 541, and 543 kilocycles, which are required for certain frequency allocations, are not multiples of 4 kilocycles. For their derivation, a 5-kilocycle oscillator is locked to the main 4-kilocycle supply and its output is used to modulate an appropriate harmonic of 4 kilocycles selected by a crystal filter as for the other supplies. Thus 306 kilocycles are derived from 316 kilocycles (multiple

of 4 kilocycles) and 10 kilocycles (multiple of 5 kilocycles).

The frequencies for the channel carrier supplies are developed in one bay capable of feeding 12 systems, and the group and pilot frequencies are produced in an associated bay capable of feeding 8 systems.

Units of the carrier supply system, which on failure would cause all 12 channels to fail, that is, the master oscillator, harmonic generator, and group carrier amplifiers, are duplicated; in the event of failure automatic change-over takes place. A further feature of this circuit is its ability to discriminate between a major and minor fault, for, whereas a failure of the 340-kilocycle supply would cause all the associated systems to fail, failure of any of the other group frequencies would cause only some of the systems to fail. In the event of a failure on both sets of supplies, the change-over panel functions to maintain working the set which has the less-important fault.

The repeater, shown schematically in Fig. 4, functions in the ordinary way to amplify the signals at the line frequencies and retransmit them to line at the appropriate level (+17 decibels relative to the transmitting trunk switch-board).

The method of regulation using two pilot frequencies in each direction of transmission is of interest. With changes in weather, especially in areas where fog, sleet, and ice are experienced, the attenuation characteristics of open-wire lines change in slope as well as in basic loss.

The gain-frequency characteristic of the repeater or receive terminal is designed to cover the ranges of slope and flat loss in the lines. As shown in Fig. 6, the slope can be varied between the limits defined by  $cc'$  (or  $hh'$ ) and  $dd'$  (or  $gg'$ ). Any slope characteristic inside these limits can be moved up or down within the range shown by changing the flat gain. It will be observed that the slope characteristics for any fixed flat gain come virtually to focal points at the highest line frequency in the low-frequency direction of transmission and at the lowest line frequency in the high direction. Thus, by using pilots at or near these focal points, the flat gain may be controlled, whereas pilots at or near the other extremes of the frequency ranges may be used to vary the slope without radically affecting the flat gain.

The pilots transmitted from the terminal are selected by narrow-band crystal filters at the output of the line amplifiers, at repeaters, or at the output of the receiving group amplifiers at receiving terminals. They are separately ampli-

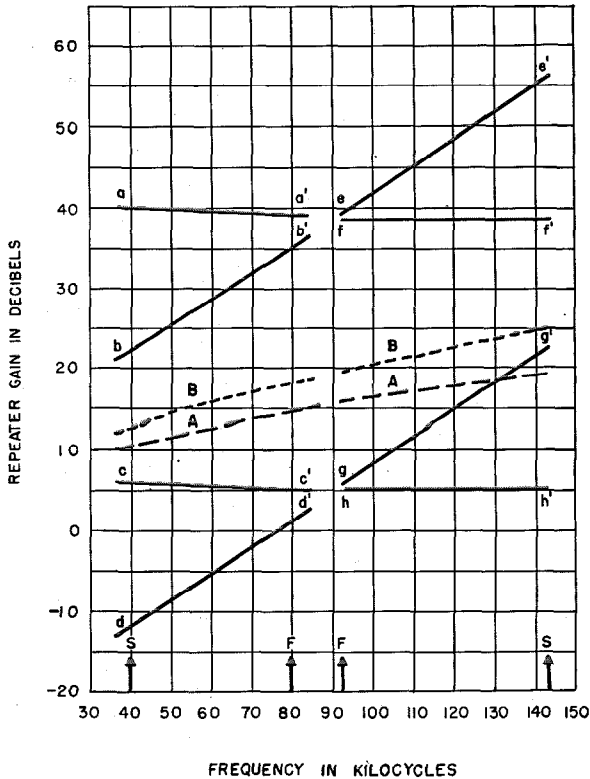

Fig. 6—Range of gain in repeater or receive terminal. A is the typical overall gain characteristic for 65 miles of 300-pound copper conductors spaced 8 inches in dry weather. B is for wet weather. F is for flat and S for slope pilots.

fied and rectified, the direct component of voltage being used to bias an oscillator. This oscillator supplies power to the heater of a thermistor, which is a device producing a variation in resistance for a change in heater currents.

By incorporating the resistance element of the thermistor in the feedback or coupling path of an amplifier, the flat gain is readily controlled in the orthodox way. The variable-slope networks are designed to give a family of linear curves for different values of thermistor resistance. Thus, it can be seen that by using the appropriate pilots to control the slope and flat gain, it is possible to achieve the required characteristics shown in Fig. 6.

It will be apparent that the gain and slope variation in the transmission path are dependent on a change in pilot levels at the output. By suitably designing the circuits, it is practicable to cover the whole range shown in Fig. 6 by a pilot change of the order of 0.5 decibel. In other words, as the pilot-to-signal-level ratio is fixed, the signal levels will not vary by more than 0.5 decibel for all changes in slope and loss in the lines that can be covered by the range of the repeater or receiving terminal gain shown in the figure. For testing purposes, or if otherwise required, the regulation may be fixed manually by rheostats controlling the flat and slope gains of the circuits.

### 1.1 ALARM TRUNK CIRCUITS

On a system of this nature, with fully automatic pilots compensating for all reasonable line variations, it is possible to leave some of the repeater stations unattended. This is often desirable in view of the fact that repeater spacing of about 75 miles, which is normally practicable on the *SOJ* system, approximately doubles the number of stations previously used for three-channel operation.

The alarm trunk circuit has been developed specially for use in conjunction with unattended *SOJ* repeater stations. Faults or alarm conditions at the unattended station are indicated fully back to the attended control station, which may be the next repeater or terminal, by means of signals transmitted over a physical or derived direct-current telegraph circuit. Typical alarms indicated in this way include such conditions as mains failure and mains restored, rectifier failure, and low fuel in the engine-generator.

In addition, the unit operates in the other direction, giving the attended station control over the other station, enabling the remote attendant to switch power to a spare repeater, to switch from automatic working with pilots to manual operation of the repeater, or to effect other similar changes as required.

### 1.2 INTERSTATION COMMUNICATION

Facilities are provided whereby all stations or selected groups of stations along a route may be in direct communication. By using bridging filters across a suitably chosen line, the circuit is

arranged to introduce no appreciable loss except when actually in the talking condition, so that there is negligible interference with normal commercial traffic. The effect at all times on a three-channel carrier system operating on the pair is negligible.

Any physical or derived direct-current telegraph leg may be used in conjunction with the telephone panel to provide a signalling circuit between the stations and any simple code may be used to make the calling selective.

## 2. Line Facilities in the Union

The administration has done a considerable amount of experimental work with a view to determining the type of line construction most suited to its needs. New main trunk routes are being built entirely to the *J-3* transposition design, in which every pole on 6.4-mile transposition sections is a potential transposition pole, 300-pound copper wires are supported on 40 poles per mile, the wires of a pair being spaced 8 inches apart, and the crossarms being 24 inches apart. The pole spacing and sag regulation is kept within close limits as required by the theoretical design. On existing *K-8* and *K-8-2* routes, with 32 or 40 poles per mile, where *SOJ* operation is required new *J-3* pairs are being erected, the existing wires being retransposed where necessary to avoid conflict with the *J-3* transpositions. A typical terminal pole-head with lead-in cable for two *SOJ* pairs is shown in Fig. 7.

Measurements on the lines are facilitated by the use of special mobile test vans equipped with oscillators, transmission-measuring sets, cross-talk sets, impedance bridges, etc., together with the necessary power supply and lighting arrangements. Up to four open-wire pairs at a time are connected from the crossarms to separate insulated terminals on the exterior of the van by loosely twisted pairs of 7/0.029 indiarubber vulcanized wire, the terminals on the inside of the van being wired to a U-link panel. The test gear is wired to other U-links and switches, and the apparatus appropriate to the required measurement can thus be readily connected to the pair or pairs under test. Adequate accommodation is provided in the van for two observers.

In a country that comprises so many diverse geographical features, maintenance considera-

tions dictate that the main routes should be readily accessible to wheeled transport, and they are, therefore, constructed along the national highways.

In the smaller towns, it is possible to run the open-wire route very close to the office. Specially developed low-capacitance star quad cable is used to lead in from two open-wire pairs down the pole and into the office. The cable is supplied with terminations for mounting on the line-

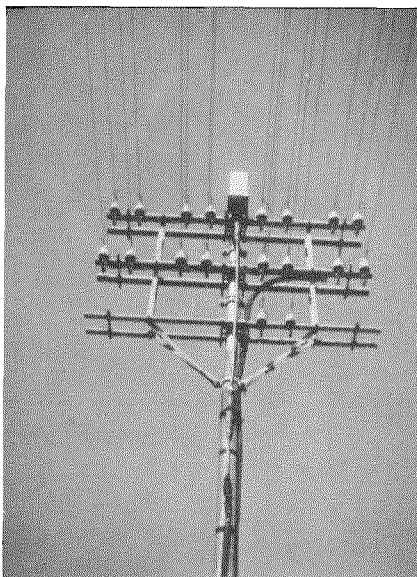

Fig. 7—Typical *J-3* terminal pole with lead-in cable for two *SOJ* pairs.

filter bays in the office and on the crossarm of the pole. Short stubs of cable are sealed into the terminations, and the appropriate length of cable is jointed into the stubs at each end. Connections from the pole-mounted termination to the open-wire lines are made with bridle wire via the loading units and coil-and-protector boxes described later. This arrangement makes it convenient to break into the circuit and carry out tests and localize faults.

To prevent reflected near-end crosstalk on the open-wire lines from becoming a controlling factor at the far end, it is necessary to reduce impedance irregularities to a minimum. For this purpose the lead-in cable is loaded so that its impedance closely matches that of the open-wire line. For lengths of lead-in up to 180 feet, the required degree of matching is achieved by

suitably adjusting a variable load unit mounted on a line-filter bay in the office. For longer lengths up to 330 feet, this load is supplemented by a fixed load unit mounted on the crossarm of the terminal pole, connection to this unit being made by the bridle wires from the cable termination on the office side and by similar wires through the coil and protector boxes on the open-wire side.

The degree of matching achieved is illustrated in Fig. 8, which shows the reflection coefficient between the open-wire line and the lead-in cable at Johannesburg. The office end of the long entrance cable was terminated in its nominal impedance of 125 ohms for the purpose of these measurements. Normally, of course, with the equipment connected, the impedance of the directional filter would cause mismatch in the frequency range from 84 to 92 kilocycles.

In the larger centres, the open-wire route terminates some distance from the office, and the treatment is then necessarily different from that described. One method is to use the low-capacitance star quad cable with full loading at 600-foot intervals, the terminal loads being designed for mounting on the pole crossarm at one end and on the line filter bay at the other.

The administration, however, has standardised for economic reasons on an alternative method



Fig. 9—Filter hut at Kroonstad.

using filter huts. It is not economically practical to develop a satisfactory loading system for paper-insulated toll entrance cables of the usual capacitance at *SOJ* frequencies. If unloaded pairs are to be used, it becomes necessary to match the impedance of the cable to that of the open wire and equipment. As the impedance of such cable changes markedly with frequency below about 20 kilocycles, it is not practicable to produce a suitable matching transformer for high-grade operation at all frequencies in the voice and carrier range. Such a transformer, however, is available to cover the *SOJ* range of frequen-

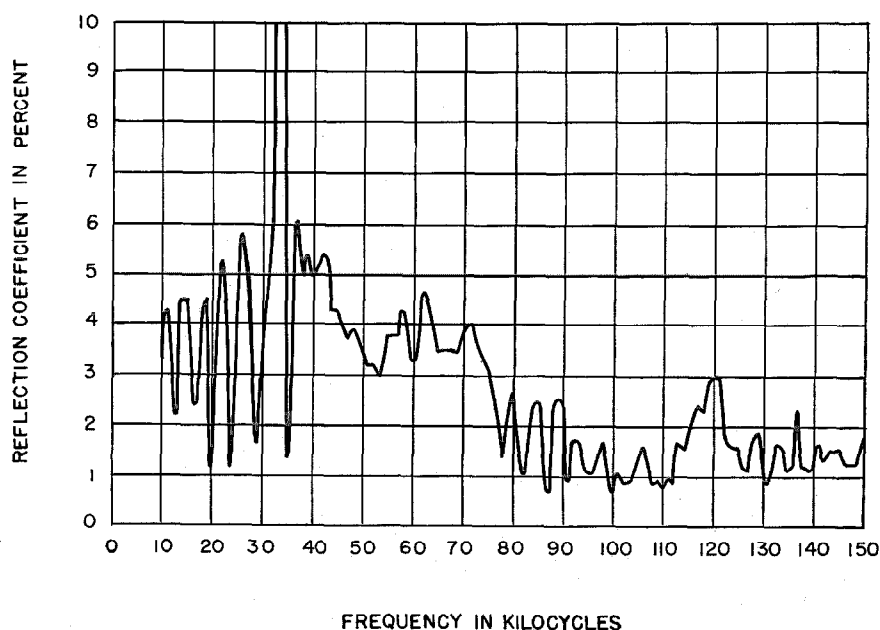

Fig. 8—Reflection at junction of open-wire line and lead-in cable at the Johannesburg terminal.

cies, and the procedure, therefore, is to separate the *SOJ* from the lower-frequency systems on the circuit, leading the former into the office over a non-loaded pair with impedance matching coils and the latter, as hitherto, over a pair loaded for three-channel operation. This separation is achieved by housing the normal *SOJ* line filters in a filter hut erected near the junction of the entrance cable and the open-wire routes. The existing entrance cable at Johannesburg is some 8000 yards long, and extensive tests carried out by the administration indicate that 10,000 yards is a reasonable practical limit. Over this length in a 54-pair multiple twin cable, it should be possible to select 8 pairs that can be balanced for satisfactory crosstalk. The lead-in arrangement on the *SOJ* pairs from the pole crossarm to the hut are precisely the same as those already discussed. Fig. 9 shows the filter hut and terminal pole on the north side of Kroonstad.

To limit crosstalk from the *SOJ* into other pairs or into the longitudinal path, retard coils are inserted in the wires. These coils, together with protectors, are mounted in a box on the terminal-pole crossarms, connections to the open wires and lead-in cable (if necessary via the load) being made with bridle wires as mentioned previously.

As severe lightning storms are frequent in the Union, the ordinary protection is supplemented by drainage. The arrangement comprises a coil bridged across the line in series with protection on each side of the coil. The coil centre point is earthed, and the protectors operate at a lower voltage than the main-line protectors. Hits that would not cause the normal protectors to break down can seriously affect the operation of voice-frequency telegraphs, and the purpose of drainage is to reduce these disturbances by ensuring that the two pairs of protectors in series with the coil break down together and thus minimise the currents in the metallic circuit. A subsidiary function is to prevent intermittent breakdown of the main-line protectors during severe dust static. The apparatus is mounted in a box identical with that used for the longitudinal coils and protectors.

### 3. Equipment

The equipment follows the standard practices, being mounted on both sides of rack frameworks 10 feet, 6 inches high, on panels 19 inches wide. Fig. 10 shows some of the equipment at the Bloemfontein terminal. The two carrier supply bays can be seen on the left, the others from left to right being ringer, channel and frequency-translating bays for system 2, and duplicates for system 1.

Fig. 11 is a photograph of the equipment in the unattended repeater station at Winburg. Working and spare repeater bays are shown in the left foreground with one line-filter bay immediately behind and the edge of the other on the right. In the background, adjacent to the toll test board, is the miscellaneous-apparatus bay mounting the alarm trunk unit for a controlled station.

The introduction of these systems in the Union has, in most instances, entailed the erection of



Fig. 10—Part of the Bloemfontein terminal equipment.



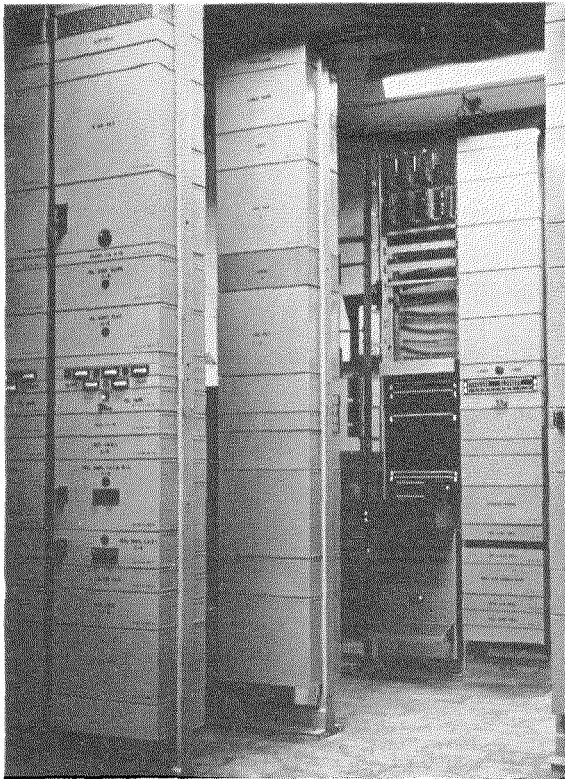

Fig. 11—Repeater equipment at the unattended station at Winburg.

entirely new buildings, either on account of the reduced repeater spacing necessitated by the introduction of *SOJ*, or because the existing carrier accommodation has become inadequate to deal with the new and expected developments. With one or two exceptions, the repeater buildings follow a standard pattern, the plan of which is shown in Fig. 12. It can be seen that the accommodation has been planned on a very liberal basis to allow for considerable development. A typical photograph of such a station is shown in Fig. 13.

The accommodation required in large terminal stations cannot be standardised to the same extent, and each one has, therefore, been considered and planned individually, but always with a view to future development.

All the filter huts are new buildings, and the administration has standardised on two sizes, the larger of which will cater for 16 pairs and the smaller for 8 pairs. The bays supplied for installation in the huts are 7 feet high. The first bay mounts terminations for 8 *SOJ* pairs (4 quad cables) and line filters and loads for 2 pairs. The second and third bays each mount 3 line filters and loads, so that the 3 bays cater for 8 pairs.

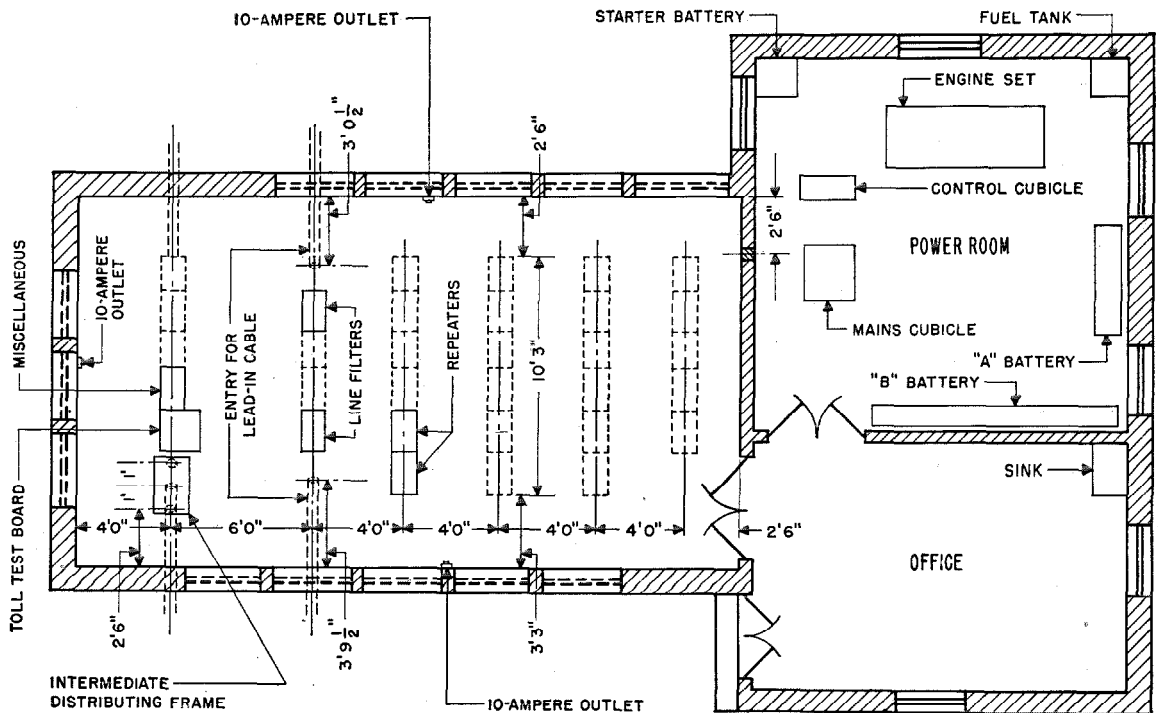

Fig. 12—Standard repeater station arrangement.

### 3.1 TEST GEAR

The test gear supplied with the equipment for maintenance purposes is described briefly in the following paragraphs.

At terminal stations, a trolley carries most of the facilities normally required for routine maintenance. The form of this item can be seen in the foreground in Fig. 10. It comprises the following apparatus mounted on a steel framework.

A. Transmission-measuring set with all necessary sending and receiving facilities over the *SOJ* frequency range.

B. 800-cycle oscillator.

C. A 14-fixed-frequency oscillator giving 12 frequencies equivalent to voice frequency on each channel at the output of the channel modulating equipment and 2 frequencies corresponding to middle frequencies in the bands transmitted to line in the two directions of transmission.

D. Meters for voltage and current measurements and a U-link panel.

The trolley operates from the normal equipment supply voltages, 24 and 130 volts, and each bay for the *SOJ* equipment has a socket suitable for the connecting plug on the trolley.

For measuring the levels of the group-frequency supplies, i.e., up to 600 kilocycles, a small high-frequency voltmeter is provided with 0-2.5- and 0-5-volt scales. This set is all that is required at these frequencies for routine maintenance measurements. For more detailed tests in cases of breakdown, however, a mains-operated transmission-measuring set, reading down to -55 decibels in the frequency range from 60 to 600 kilocycles is supplied.

At repeater stations, a portable transmission-measuring set, which obtains its power supplies via a cord which can be plugged into the sockets on the bays in a similar way to the trolley, is supplied for maintenance purposes. This transmission-measuring set incorporates all the necessary facilities on the send and receive units for such measurements and an oscillator giving the two frequencies corresponding to middle frequencies in the bands transmitted to line in the two directions of transmission. The unit can be used with 12- and 130-volt batteries, when required for measurements in the filter hut or on the lines.

Apart from the gear described above for routine and maintenance tests, the administra-

tion has felt the need for apparatus suitable for making more precise measurements on detailed parts of the equipment. For this purpose at terminal stations of combined 3-channel and 12-channel repeaters, the following items are supplied:

A. Continuously variable heterodyne oscillator with a maximum output of +30 decibels, referred to 1 milliwatt, giving a high-grade performance at frequencies in the range 500 cycles to 150 kilocycles.

B. Transmission-measuring set covering the frequency range 100 cycles to 150 kilocycles reading from -45 to +35 decibels, referred to 1 milliwatt, on the receive unit and incorporating a send unit suitable for use in conjunction with item A.



Fig. 13—Typical repeater station building.

Both units are operated from the alternating-current mains and they are mounted, together with the mains units, on a trolley framework.

### 4. Power Plant

As many of the stations on the *SOJ* routes are entirely new, no power equipment exists. In many of the others, the present power plants are inadequate to deal with the additional loads. The type of power plant used exclusively by the administration in these cases at repeater stations and the smaller terminals will be described. At the large terminal stations, generators with floating batteries are used.

The equipment supplies of 24 and 130 volts are normally provided by rectifier units operating from alternating-current mains. The units are designed so that variations of up to  $\pm 10$  per cent in the mains-supply voltage or considerable variations in the load on the 130-volt supply are automatically compensated to maintain the output voltage constant within close limits. This

is achieved by a motor-driven tap on the mains input transformer, the motor being actuated by a robust, sensitive, marginal relay in the 130-volt circuit. The transformer is designed so that any correction necessary on the primary side to maintain the higher voltage within the required limits due to changes in mains-supply voltage also causes a corresponding change in the lower voltage, thus

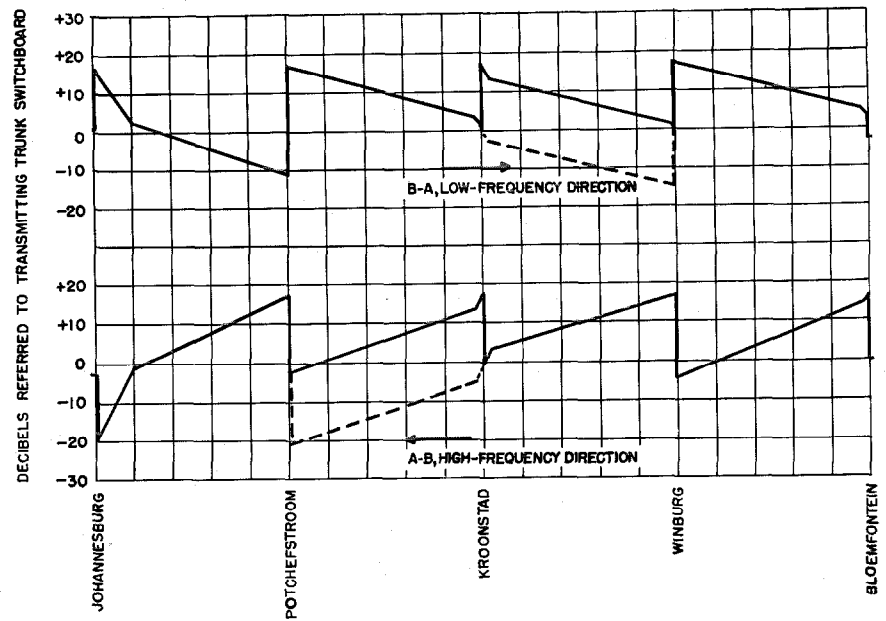

Fig. 15—Signal levels at the highest line frequency used between Johannesburg and Bloemfontein. The dotted curve is obtained with the lines patched through at Kroonstad.

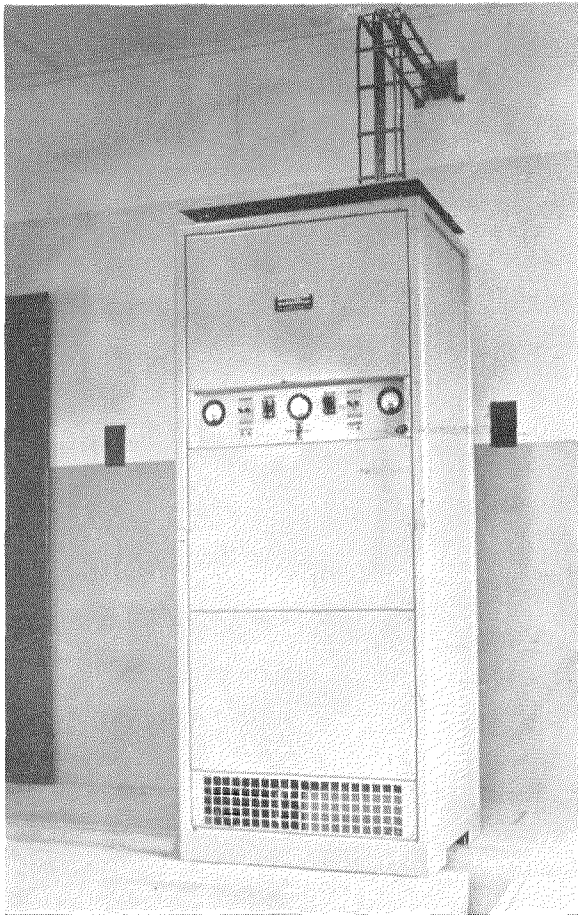

Fig. 14—Rectifier delivering 60 amperes at low tension and 4 amperes at high tension.

maintaining this within approximately the same close limits.

Similarly, if the higher- and lower-voltage loads vary in the same ratio, the lower voltage is maintained approximately correct. As the *SOJ* equipment is designed to use ballast lamps in all the valve heater circuits, considerable divergence in the load ratios is permissible before the lower voltage falls outside the range that can be compensated. The higher voltage will be maintained within the limits of the control relay and, in practice, it is possible to achieve approximately  $\pm 1$  per cent.

Three sizes of rectifiers are available, delivering at lower and higher voltages, respectively, 30 and 2 amperes, 60 and 4 amperes, or 100 and 6 amperes. The higher- and lower-voltage supplies in the two smaller plants are derived in one cabinet, but for the larger plants, separate units are used. A photograph of a 60/4 unit is shown in Fig. 14. The other equipments are similar in appearance, the height and width being the same in all cases.

As protection against mains or rectifier failures, the standby plant consists of a Diesel engine-generator yielding regulated direct-current outputs at 24 volts and 130 volts to the station

equipment through the smoothing filters in the rectifier. This plant is arranged to start up automatically in case of a mains or rectifier failure. Small-capacity batteries of a totally enclosed type are floated across the rectifier outputs and supply the equipment during the period of some 15 seconds before the generator takes over the load. The engine starter battery is fully recharged from the starter motor, which becomes a generator following the automatic change-back of the load to the rectifier unit on restoration of the normal mains supply, before the engine shuts down. A fuel tank, capable of keeping the engine running for 48 hours, ensures that even at unattended stations there will be no break in the service. It is considered practicable within this time for an attendant to reach the station and either refuel the engine or service the power plant. With such a reserve, this action should be possible even at week-ends and similar periods, when only a skeleton staff normally mans the station.

#### 5. Line-up of Circuits: Joannesburg-Bloemfontein

Fig. 15 shows the signal levels, relative to the transmitting trunk switch-board, at the highest line frequency along the route in the two directions of transmission, as measured in dry weather during the initial line-up of the system. The greater slopes at Johannesburg, Bloemfontein, and on both sides of Kroonstad are due to entrance cables, but it should be understood that no attempt is made to show the relative lengths of cable and open wire on the horizontal axis. The dotted lines show the levels with the lines patched through at Kroonstad; during the course of the tests such a patch was made and the system was found to align itself and work perfectly satisfactorily. By examining this figure in conjunction with Fig. 6, it will be seen that even

under these conditions the repeater still has a considerable margin of gain in the two directions.

The circuits were lined up to a 3-decibel 2-wire equivalent. It is interesting to note that ul-

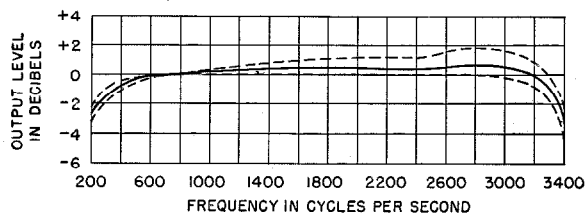

Fig. 16—Quality curve related to 800-cycle transmission. The solid curve is the average of 12 channels and the maximum departures are indicated by the dotted curves.

mately it will be lined up to 0 decibel, for, to conform with the administration's zoning plan whereby any two subscribers throughout the country may be interconnected with a prescribed maximum overall loss, all major trunk carrier circuits will have a zero equivalent. Automatic trunk switch-boards providing 4-wire switching on a tail-eating basis with pad connections will be used.

Fig. 16 shows the quality curve, relative to the 800-cycle point representing the average of the 12 channels in the B-A direction of transmission. The dotted curves show the spread, i.e., they are drawn through the extreme figures at each frequency.

Noise measurements were made on each channel, after lining up to 3-decibel equivalent in each direction of transmission. The worst channel gave 2.0 millivolts psophometric electromotive force of weighted noise. All other channels gave figures better than 1.0 millivolt, more than half the channels being better than 0.5 millivolt.

#### 6. Acknowledgment

The authors express their appreciation to all those who, directly or indirectly, made possible the writing of this article.

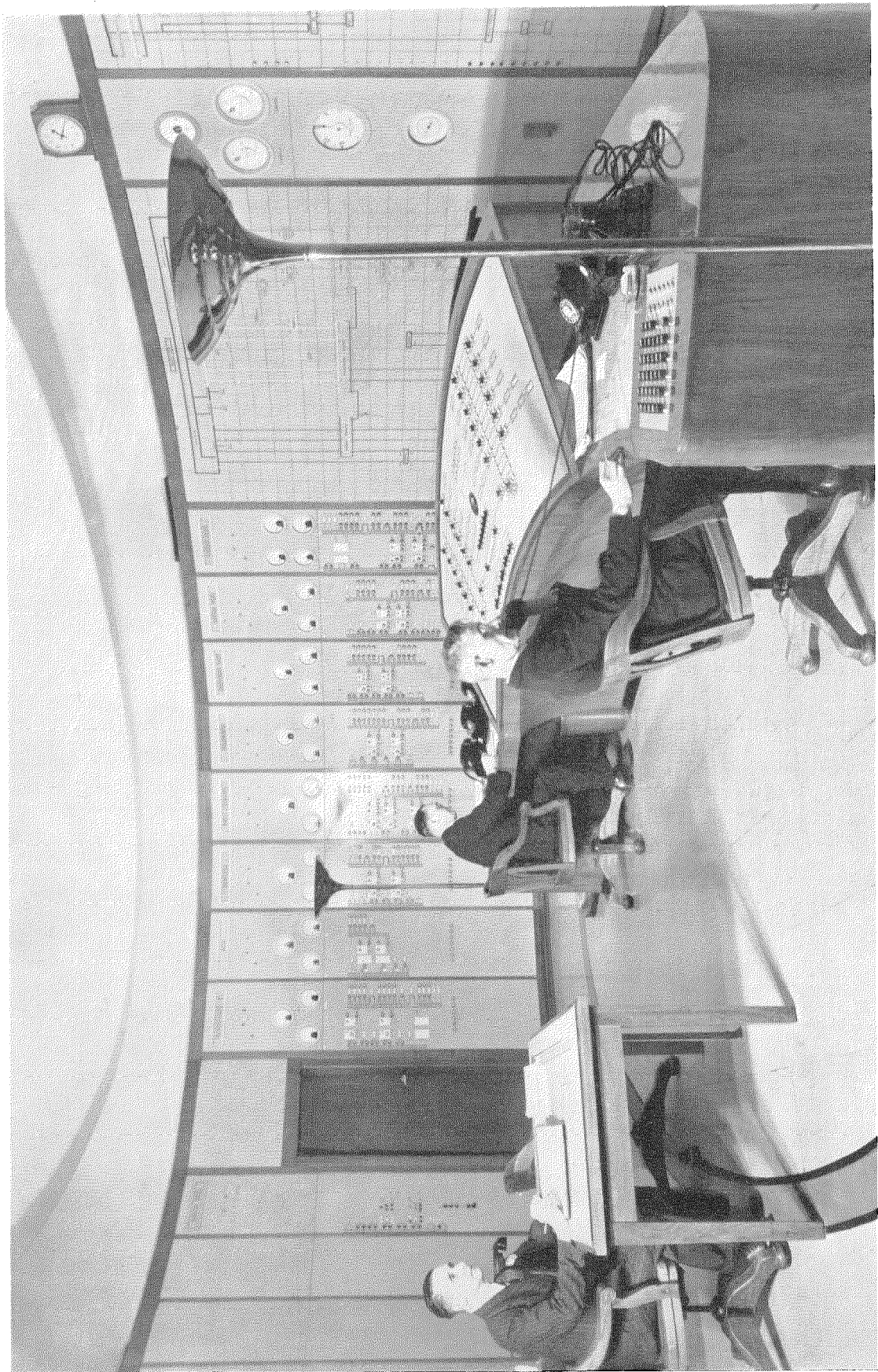

General view of the central control room of the Manchester Corporation Electricity Department. In the background are the panels for the remote control, indication, and metering of nine 33-kilovolt main substations. To the right of these is the 33-kilovolt system diagram separated from the 6.6-kilovolt diagram, shown in part on the extreme right, by a central loading and frequency panel.

# Operational Control of Electricity Supply Systems\*

By W. KIDD, M.I.E.E.

*Manchester Corporation Electricity Department, Manchester, England*

and E. M. S. McWHIRTER, M.I.E.E.

*Standard Telephones and Cables, Limited, London, England*

**S**UPERVISORY EQUIPMENT for the remote control of plant has proved to be thoroughly reliable and to facilitate efficient operation of electricity supply systems. This paper gives the reasons for, and the steps taken to develop, the common-diagram control system, which enables an almost unlimited number of substations, etc., to be completely controlled from one diagram and control panel and is sufficiently flexible to cater for the growth of the undertaking. It describes a wall-type system diagram which automatically indicates which substations have changed conditions, and therefore the area involved in any disturbance. The system diagram is equally extensible to accommodate new feeders and substations, with a minimum of operating disturbances.

Particulars of the circuits and apparatus, and comparisons of floor area, pilot, and cost economies are given; also information of an installation dealing initially with 78 substations, to which others are being added.

## 1. Introduction

### 1.1 GENERAL

Factors essential for the satisfactory operational control of an electricity supply system include:

- A. Accurate forecasts of load conditions.
- B. Knowledge of current flow and fault MVA in all parts of the system.
- C. Immediate notification of occurrences on the system.

\* Reprinted from *Journal of the Institution of Electrical Engineers*, v. 92, Part II, pp. 311-322; August, 1945. Presented before Transmission Section, March 14, 1945; North-Western Centre, March 13, 1945; North Midland Centre, March 20, 1945; Tees-side Sub-Centre, April 14, 1945; East Midland Sub-Centre, October 30, 1945; Western Centre, November 12, 1945; Scottish Centre, November 14, 1945; Mersey and North Wales Centre, January 7, 1946; South Midland Centre, January 9, 1946; and North-Eastern Centre, February 25, 1946. Discussions at these meetings published in *Journal of the Institution of Electrical Engineers*, v. 92, Part II, pp. 322-326; August, 1945; v. 92, Part II, pp. 554-561; December, 1945; and v. 94, Part II, pp. 33-45; February, 1947.

D. Facilities for voltage regulation and the performance, without delay, of switching operations.

Many supply authorities have an organization for the collection of statistics, and for the planning and execution of operations. Calculating boards to ascertain fault MVA and the current flow, in all parts of the system under all conditions of working, are of great value in enabling the results of switch operation to be forecast. The more progressive organizations have installed remote supervisory control gear for the rapid acquisition of information from the system, to enable voltage to be regulated and switching performed directly from a central control room.

### 1.2 REASONS FOR DEVELOPING A COMMON-DIAGRAM SUPERVISORY SYSTEM

Supervisory control equipment which was in service prior to the year 1943 had the disadvantage of being found inflexible when extensions were necessary. If a larger number of substations had to be controlled, the floor space required became excessive because an individual panel was required for each substation, whereas for the common-diagram system only one small desk is required for any number of substations, and only a pair of pilot lines is required for a group of substations (Fig. 1).

It became obvious that, to render practicable the application of remote-control equipment to a large number of substations, new development beyond these individual systems was essential.

Routine operational control is secondary in importance to that which it is necessary to provide for a network disturbance. For this condition a control engineer requires to know first the extent of the disturbance, and second, detailed information of the state of affairs at various points on the network. This detailed information he will acquire point by point in order of importance as judged from his

experience and knowledge of the extent of the disturbance.

Therefore, if there is a pictorial representation of the whole system which indicates automatically the substation affected by a disturbance, then the engineers' requirements will be fulfilled by a "common" control desk providing detailed control and indication of any substation.

This paper describes a new supervisory-control system designed to meet these requirements for Manchester. It includes a wall-type system diagram in combination with a control desk of moderate size, which is capable of having any additional number of substations connected to it, without increasing the size of the desk, and at less cost than individual panels.

### 1.3 SYSTEM DIAGRAMS AND CONTROL BOARDS

A large diagram with miniature indications automatically displaying every switch position in the system might seem to be ideal, but a few observations on its undesirability will illustrate the reasons for choosing the type of diagram adopted.

If switch indication only is required, the diagram may be 10 feet high and the indicators will be within vision, but if control is also required, experience has shown that the control switches should be located between 2 feet and 6 feet 6 inches above the floor level. This consideration means that, if many feeders and substations are to be represented, the diagram becomes disproportionately long, to the detriment of its pictorial value, and, owing to crossing lines, results in loss of clarity.

Individual automatic switch indicators and control keys require individual relays and wiring. This tends towards inflexibility, and, although mosaic types of diagrams are helpful in overcoming this defect, it is doubtful whether they could successfully cater for both control and indication. Diagrams should therefore be capable of rapid and easy modification, but this becomes increasingly difficult of attainment as the amount of detail on the diagram is increased.

A control engineer is less concerned with the geographical position of a substation than with its electrical position, i.e., the section of generators from which it is normally fed, the alternative

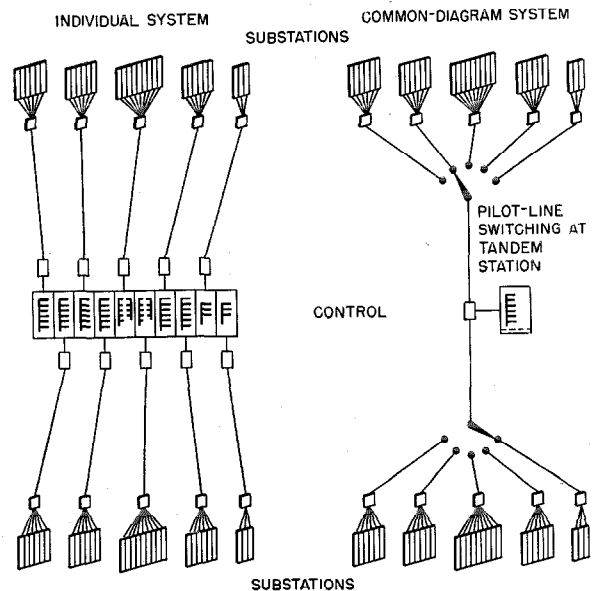

Fig. 1—A comparison in outline of individual and common-diagram systems. Supervisory equipment, indicated by the open boxes, is connected to the switchgear, illustrated by the larger boxes which are subdivided by vertical lines.

means of supply, which feeders may be paralleled and which should not be coupled, etc.

Even large, complicated systems can be represented by a diagram restricted to straight lines interconnecting substation symbols, each of which has a lamp automatically illuminated when the conditions at that substation change. These diagrams, built up of small moulded panels, can be arranged to form control room walls. They are built up on a jack-in tile basis, each tile being easily removable. Adhesive coloured tape is used to make rectangles and straight lines to represent substations and feeders, respectively. The tape diagram is easily and quickly modified to cater for extensions to the system. A pilot lamp is inset in the portion of a tile within the substation symbol. Connections to three such lamps can be made through four pin connectors per tile, which also form the means of fixing the tile. The system diagram has small plug-in disc indicators of various colours and symbols. This enables the wall diagram to be hand-dressed to represent, to any desired extent, the conditions on the system.

The geographical layout of feeders and substations forming a section of the area is shown in Fig. 2, and the form in which this section appears on the system diagram is shown in Fig. 3.

1.4 COMMON-DIAGRAM CONTROL DESK

More detailed information from a substation, and also remote control of equipment, must be provided if the system is to be complete. The control and indicating equipment must be capable of being applied at will to any substation.

When the substation plant arrangements for a distribution system are reviewed, it is found that the least common multiple of equipment required is not much larger than that of the ultimate largest requirement of any substation to be provided on the system. This is reasonably easy to state since, for reasons of economy, and also of load distribution and voltage drop, it is not good policy to permit the unlimited growth of a single substation, however great the load density may be.

Thus, a least common multiple of supervisory remote control equipment can be designed for any group of substations. The problem of making such an equipment available to any one of a number of substations involves two problems, namely:

A. Switching pairs of pilot wires to make them available to the equipment, one pair at a time.

B. Setting the equipment so that for a period of time it loses its least-common-multiple character and takes on that of the particular substation.

A solution has been achieved by the use of telephone-switching apparatus and methods, and may be summarized thus:

A. The diagram must represent the least common multiple of the substations, either by rows of lamps or by diagram.

B. Feeders and transformers, etc., must bear identity numbers, and means to display them.

C. For flexibility in extension, substations must be given numbers.

D. Means should be provided to display identity numbers of more than the one substation which is occupying the common diagram. In addition to lamp indication on the system diagram of all substations reporting trouble, there should

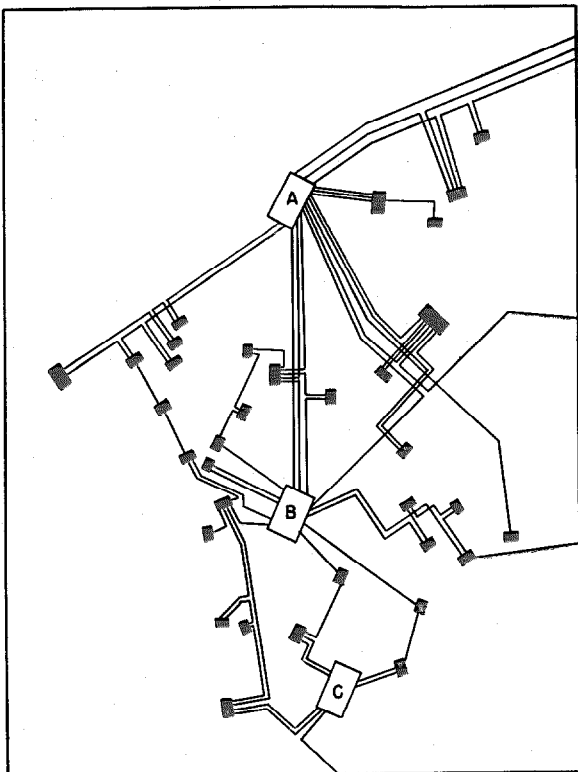

Fig. 2—Geographical layout of a section of feeders and substations.

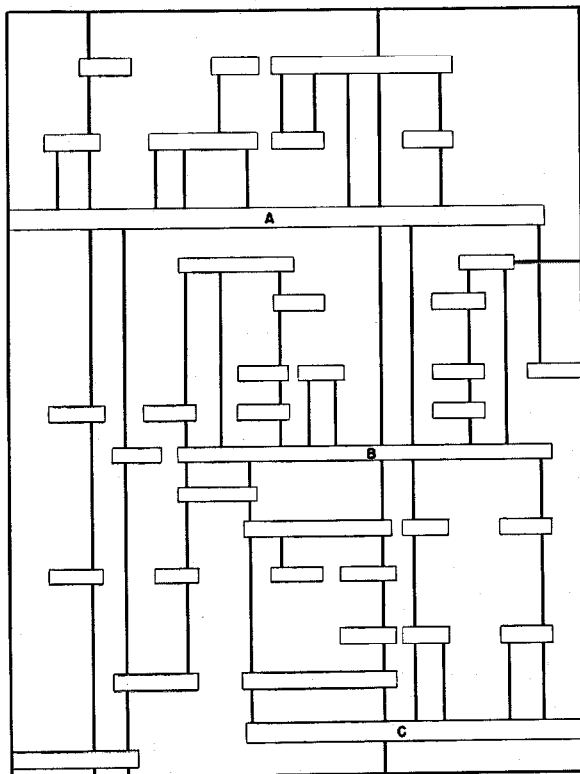

Fig. 3—System diagram layout for the section of feeders and substations shown in Fig. 2.



be means to display the identity number of substations occupying or requiring to occupy the common diagram.

### 1.5 PILOT LINES

Line-signalling circuits between the control station and the substations are necessary in any supervisory system. The pilot lines which exist between substations are rarely the result of a single planned installation which considers all possible present and future requirements of telephony, protection, intertripping, remote control, etc. The two extreme arrangements possible in any set of pilot lines are:

A. Pilot lines radiating individually to all substations from the control point.

B. All substations connected on one omnibus pilot line to the control station.

Rarely would either be met on a large system. This results in each case having to be treated on its merits, but a study of almost any existing network usually reveals a possible satisfactory arrangement even if, in a few instances, lines have to be added or switched. In the common-diagram system, economy can be effected by grouping substations around radiation points so that only a one-pair line between each substation radiation point, called a tandem station, and the central control is required.

It might be argued that it provides bottlenecks if a number of substations require to signal a supply failure simultaneously, but this is not serious for two reasons:

A. On any scheme employing a common diagram, fundamentally only one station can be connected at a time and therefore a pilot-line bottleneck at each tandem station does not worsen this arrangement.

B. Also, substations can be arranged to signal their identity immediately a supply failure occurs. This signal is short, and when received it lights the station pilot lamp on the system diagram. Immediately one such signal is received, the equipment is free to accept a second, so that as little time as possible is lost in providing the control engineer with the names of the substations affected by the failure. He, then, from his knowledge of the network, assisted by the system

diagram, should be able to determine in what order of priority he desires to examine the individual switchgear conditions of the substations and select and call them to his common diagram in that order.

Indeed, this method ensures that the control engineer operates in the correct manner in the event of a major disturbance, in that it first directs his attention to the overall picture before it is too strongly attracted by one particular feature about which he might be tempted to take some premature action.

Further economy could be effected by the adoption of party-line working from each tandem, but as the number of substations for each tandem may be larger than present-day relay design allows for in party-line working, a mixed system from each tandem would result. It is better for circuit uniformity to have either all non-party lines or all party lines; the layout of existing pilots will in general govern the decision. For example, common-diagram system applied to the control of traction substations would require party lines rather than the tandem-station arrangement to provide an economy of pilot lines, whilst supply distribution will in general find the tandem-station, non-party line, best suited to its geography.

The circuit design can, if desired, be arranged to permit the operation of a telephone over the same pilots as the supervisory facilities.

### 1.6 GENERAL PLAN

Association of these ideas enables a general plan to be stated for their application to a specific case.

Each substation is connected by a telephone pair to a tandem station. Equipment at the tandem consists of line relays and a line-finder, so that the pilots connecting the tandem station to the central control equipment can be switched to any one of a number of substations at the request of either the substation or the control engineer. One telephone pair only is required between each tandem station and the control station.

Circuits at the control station are so arranged that each tandem-station line circuit can be connected to a free connecting or link circuit under stimulus from either a substation equip-

ment or the control station. At the same time a substation marker circuit can be energized by information received over the tandem-station line circuit, indicating the number of the substation which is calling or is to be called.

By these means, a substation is identified and its number displayed on the desk either by the control engineer originating the request for it or by fault conditions causing the substation to indicate these conditions.

Simultaneously, the particular substation lamp on a system diagram is illuminated, the lamps showing the extent of the area affected by a disturbance. The number of lamps that can be illuminated simultaneously is independent of the number of links serving the desk, and, whether or not the desk is free, an incoming signal from a substation must always serve the purpose of illuminating its associated lamp on the wall-system diagram.

Having occupied a link circuit, a substation can be arranged to occupy the common diagram on the control desk, causing it to display the switchgear conditions at that substation, and to provide remote-control facilities.

## 2. Application of the Common-Diagram System

### 2.1 GENERAL

The application of common-diagram supervisory equipment to the operational control of an electricity supply system can now be considered, Manchester being taken as an example and the number of 33-kilovolt and 6.6-kilovolt substations being 14 and 410, respectively. The 33-kilovolt substations are used as control tandem stations.

Supervisory control of some of the non-attended 33-kilovolt substations had been in commission since the year 1929, and the experience of operational control proved that the equipment was a valuable asset; supply had been resumed within a few minutes after interruptions, whereas without supervisory gear a delay of half an hour would have occurred. It was decided to extend the use of supervisory gear; a selection of substations (78), where load and switch control was considered to be of particular importance, was made for an initial installation. A proviso was made that the type of gear to be

installed must be capable of extension to deal with a much greater number of substations.

The individual-panel type of supervisory gear was, for reasons previously given in the paper, considered to be impracticable for such large-scale development, and consequently the common-diagram system was evolved.

### 2.2 PROBLEM OF RELATING ALL TYPES OF SUBSTATION TO A LEAST COMMON MULTIPLE

In most undertakings there exist variations in the design of substations, but these physical differences do not seriously affect supervisory control and indication.

Any system of remote switchgear indication is concerned primarily with three fundamental types of equipment:

- A. Two-position devices such as oil circuit breakers, isolators, alarms, etc.
- B. Multi-position devices such as transformer tap-change gear.
- C. Meter readings or the transmission of continuously variable quantities.

The controls required are almost wholly confined to one of two conditions, namely "closed" or "open," "on" or "off," "raise" or "lower."

From these fundamentals many variations are derived, such as duplicate busbars, "fleeting" contact alarms, etc., all of which usually involve only the addition of relays to translate their variations back to the standard types of condition.

In designing a control desk, therefore, to cater for various types of equipment, the same control and indication devices can be used, since these have only to fulfil one or other of the above-named universal conditions. Similarly, so far as the control panel is concerned, the type of the switchgear and diagram of its operating circuits are immaterial; where differences occur they must be catered for by local supervisory relays.

The common-diagram control desk therefore includes the greatest number, in any one substation, of two-position devices that will occur, together with a method of indicating to which feeder, transformer alarm, etc., each device belongs; and similarly for multi-position devices and meters.

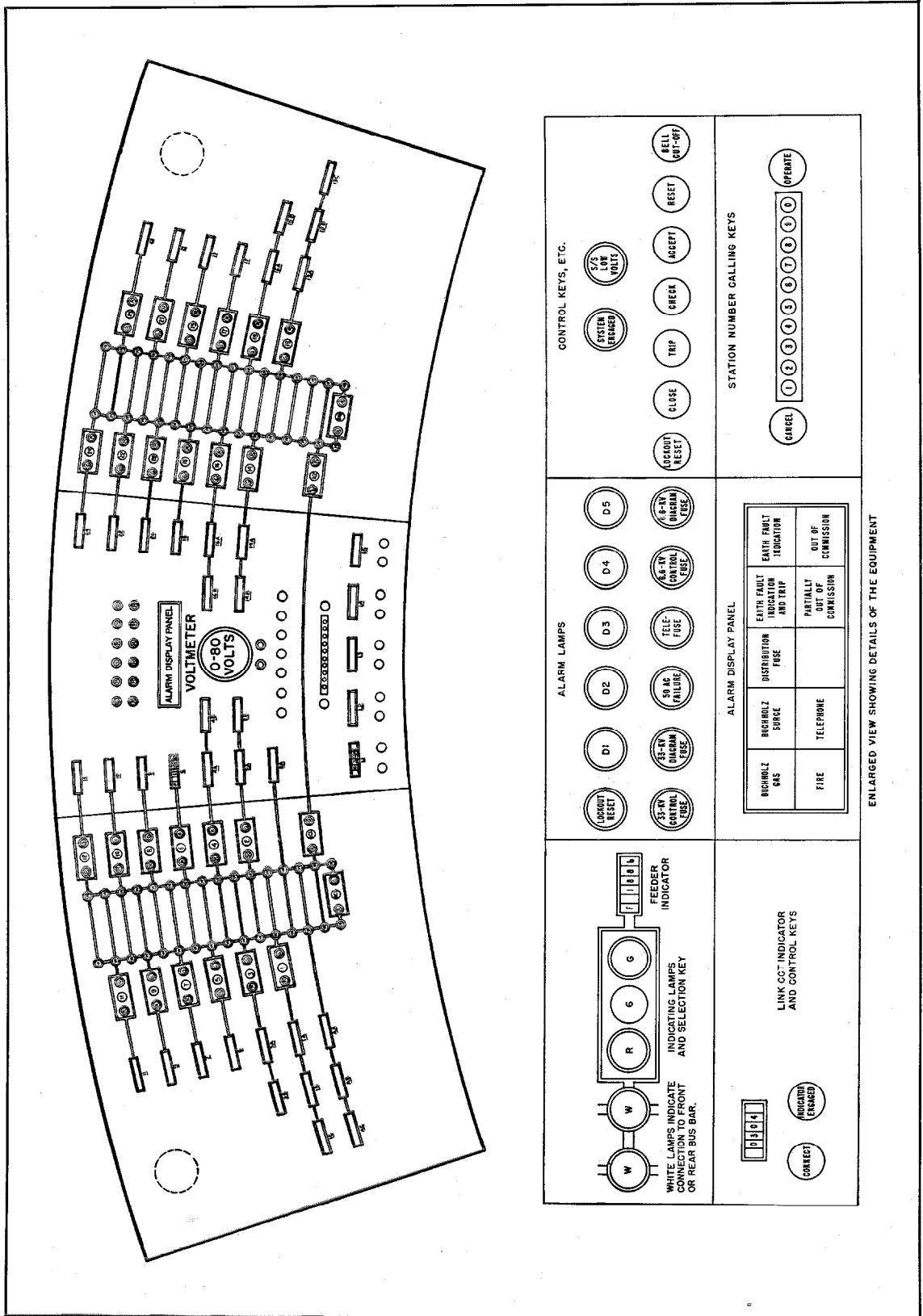

ENLARGED VIEW SHOWING DETAILS OF THE EQUIPMENT

Fig. 4—Common-control-diagram layout.

### 2.2.1 Display of Switchgear Identity

The problem of indicating the name or number of the device beside the indicating lamps and control keys can be solved in several ways, but to be universally flexible and extensible the scheme should be confined to the use of letters and figures representing a simple code of definition, such as: T1 for Transformer No. 1, F1 for Feeder No. 1, etc. Such a code, to almost any variety, can easily be set up and displayed on digit-wheel indicators.

Thus, given a control key, indicating lamps, and electrically operated digit-wheel indicators forming a unit for a two-position control and indication, a number of them could be associated at will to represent any arrangement of switchgear.

### 2.2.2 Busbar Arrangements

Further, if the substations have either single or duplicate busbars, these indicating units can be mounted on the control desk one above the other and shown diagrammatically connected to the busbars. Since any unit can be designated by any indicator, the order of connection to the busbars can be suited to any substation.

Busbar couplers and section switches can be catered for in the diagrammatic representation by placing these units in position and working along the busbars on either side as far as it is necessary to go for any particular substation.

Many substations will not use all the units provided; this will not cause confusion, because the lamps of only those units actually in use at any instant will be illuminated. Additional busbar-selection indicating lamps, remotely operated, will show the connections of the switchgear to the busbars obtaining at any time.

### 2.2.3 Indication of Substation Numbers

To inform the control engineer which of a number of substations is using the diagram, the substations must be numbered and displayed on a stepping numerical indicator or similar device. Either an instrument similar to a telephone dial, or a row of digit keys, will enable one of an infinite number of substations to be selected.

### 2.2.4 The Common-Diagram Desk

The equipments in the Manchester substations at present vary from one feeder, one transformer, and one circuit breaker, to 12 feeders and 7 transformers on 11-kilovolt and 6.6-kilovolt single- and duplicate-busbar sectionalized boards. In some substations having two feeders and two transformers only, one circuit breaker is installed. The complete lowest common multiple of facilities provided is listed in Table II, whilst Fig. 4 shows the common diagram which was developed for indicating and controlling the combinations of equipment in the present and future substations.

Duplicate busbars on each side panel are provided with busbar couplers and joined by an interconnector towards the front of the panel. Beneath the layout of the panel, six enlarged views illustrate the items of equipment, including that for a two-position remote control and indication; the series of alarm lamps (positioned above the alarm display panel); the common control keys (positioned below the supervisory system voltmeter); details of the connecting links for the display of substation numbers (five of which were provided and positioned across the front of the centre panel); particulars of the other remote alarms provided (illustrated as they are displayed when illuminated in the alarm display panel); and the digit keys used for "dialling" the substation number, together with the "operate" and "cancel" keys which render the dialling effective or otherwise.

Since this common-diagram installation was put into commission, arrangements have been made for the indication and removal of "lock-out" for 26 trolleybus supply circuit breakers in 11 substations, whilst earth-fault alarm indications are being provided from an additional 37 substations.

## 2.3 PILOT-LINE ARRANGEMENTS

There were pilot-line pairs available in the telephone network between most substations in an area and the 33-kilovolt substation supplying that area; also a single pilot pair between each 33-kilovolt substation and central control. It was therefore decided to install tandem-station working, 12 circuits radiating from central control to

the 12 tandem equipments (at the 33-kilovolt substations), which enabled these circuits to be extended to any one of a series of pilot pairs connecting to the substations in the area, either by signals from the substations or by a coded signal from the central control.

#### 2.4 SUITABLE SUPERVISORY REMOTE-CONTROL SYSTEM

Methods of employing a common-diagram system depend upon a technique well known to automatic-telephone switching engineers, for, given the method of supervisory signalling, the rest is a matter of calling a particular substation, or being called by it, and connecting its line wires to the common-diagram equipment. It is obviously convenient to make the impulsing voltages used for the supervisory and substation calling signals the same, but, in general, almost any method of supervisory-control signalling could be employed which employs impulse trains for selection and does not depend upon maintaining a continuously rotating synchronism between substation and control.

To illustrate the method by which a large number of stations are remotely controlled and supervised from one control desk, a basic method of supervisory control will be explained and then the expansion of this method into a common-diagram system developed.

### 3. Common-Diagram System

#### 3.1 BASIC SUPERVISORY REMOTE-CONTROL SYSTEM

In the various well-known methods of supervisory remote control which use impulse trains to perform the required selections, the detailed differences consist in the methods adopted to ensure that the impulsing is correctly transmitted and received, and in the use of two, four, or more line wires or communication channels between control and substation.

A coded train of impulses totalling to a constant number is used for the common-diagram system, giving the numerical constancy of the impulse trains a simple and reliable safeguard against errors. For control selection, 91 codes are provided from 15 impulses, divided into three digits. A selection having been made, further final

“operate” impulses complete the closing or tripping desired, as well as indicating back immediately that this has been done.

For the switchgear position-indication signalling a fixed number of impulses is again used, but with the difference that each impulse indicates by its polarity either the closed or open position of a particular switch, the fixed total number of the pulses again providing a ready means of checking that no mutilation of impulsing has occurred.

Two pilot lines only are required between the substation and control station equipments for these circuits, the nature of the currents transmitted over them being as follows:

A. *For Control Selection.* A coded train of negative impulses of constant length.

B. *For Final Operation.* A series of dovetailing impulses, transmitted alternately from each station and of positive or negative polarity corresponding to the closed or open condition of the switchgear selected, the actual operating pulse to change this condition being made longer than the others.

C. *For Position Indication.* A fixed-length train of impulses, each impulse of positive or negative polarity corresponding to a closed or open position of an associated switch.

D. *For Line Proving.* A small direct current, removed from the line during impulsing.

#### 3.2 OUTLINE CIRCUIT DESCRIPTION

Fig. 5 is a composite illustration showing association between the circuits.

In the basic supervisory system, a symmetry exists between the circuits at the substation and the control station, because both have to send and receive impulses, the substation to select indicating lamps, etc., at the control station, and the latter to select closing and trip-interposing relays at the substation. A sender-connector circuit at each station enables the selecting impulses to be transmitted from any of a number of control selection keys or switchgear auxiliary contacts without confusion, whilst either indication relays or selector circuit relays enable the received codes to be operative at their respective locations.

Relays connected in the line-switching and impulse circuit enable the two equipments mu-

tually to interlock to avoid confusion whilst impulsing, and also to effect switching between the various circuits.

Given a basic system of supervisory remote control, the application of this to a common-diagram system can now be described in outline form under the two stages into which it naturally divides—establishing connection with a substation, and dressing the common diagram to display that substation.

### 3.3 SIGNALLING TO ESTABLISH PILOT-LINE CONNECTION FROM SUBSTATION VIA TANDEM TO CONTROL STATION

Both the control engineer at will, and the substation automatically, must be able to establish this circuit, but whereas in the first case the connection when established may be retained for

control purposes, this must not occur when the substation automatically establishes it. If it did, the tandem-control section of the pilots would be prohibited to other substations. The outline circuit is illustrated in Fig. 5.

It is essential that a substation when signalling automatically shall occupy the circuit for the shortest possible time, in order that no delay shall occur to signals from other substations affected by the disturbance. Accordingly, the circuit is so arranged that only the substation number is transmitted by the tandem selector *P* (after it has been actuated from the substation line relay) into the tandem connector *Q*, where a selector is positioned to actuate the substation marker circuit *R* and light the pilot lamp on the system diagram. As soon as the substation marker circuit individual to the calling substation

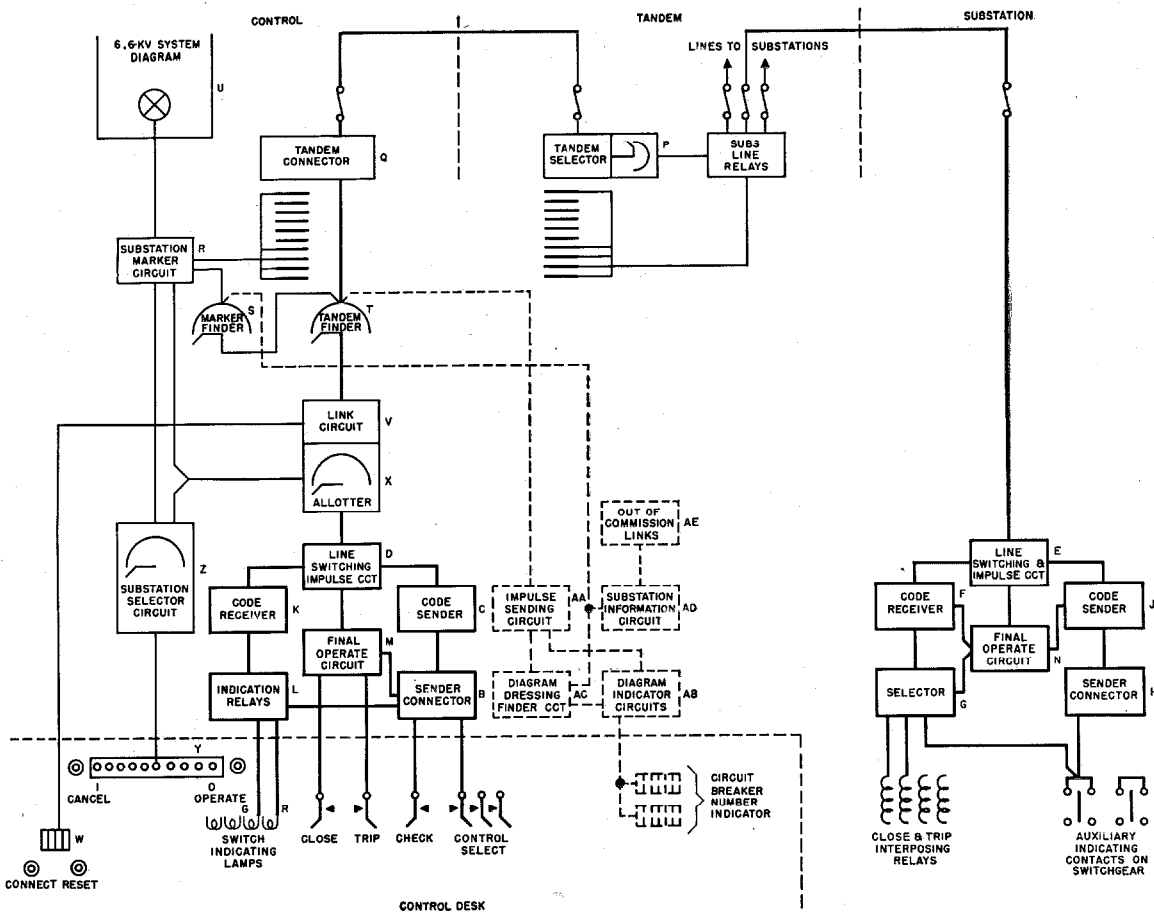

Fig. 5—Composite key diagram. The heavy line indicates the basic supervisory system, the light line illustrates the circuit to establish pilot-line connection from common-control through tandems to substations, and the dotted line the circuit for dressing the common diagram.

has been actuated, the circuits *P* and *Q* are free to operate for other substations, and therefore as many pilot lamps as necessary can be energized in sequence. In addition to the substation pilot lamps, five link circuits *V*, each with a number indicator *W* mounted on the desk, are employed to display the numbers of the first five substations automatically signalling-in a network disturbance. These link circuits are allocated for use to the incoming signals and the control engineer by the allotter circuit *X*, which causes the allocated link circuit to position the number indicator via the markings set up on the tandem finder *T* and marker finder *S*. When the number of a substation is displayed, the system-diagram pilot lamp changes from flashing to steady light, thereby informing the control engineer of this fact.

To "call" a substation, the control engineer must connect a free link circuit to the common diagram and then originate a four-figure number, the first two numerals of which nominate the tandem station to which the required substation (represented by the last two numerals) is connected. Ten digit keys *Y* enable him to do this and store the number in the substation selector circuit *Z*, which becomes effective via the circuits *R*, *S*, and *T*, and light the substation pilot lamp on the system diagram, after he has pressed an "operate" key.

By this arrangement the equipment is set up ready to call the substation, but the pilot-line circuits are not occupied until the control engineer proceeds to check and control the substation.

### 3.4 DRESSING THE COMMON DIAGRAM

Whenever the control engineer wishes to record or control switch positions at any substation, he requires the common diagram dressed to that particular substation. Each possible connection to the busbars is represented on the common diagram by a number indicator, control-select key, and indicating lamps. In a few cases where feeders are solidly connected to the busbars, the control-select key and indicating lamps are omitted.

Setting the number indicators to display, for example, F215 representing Feeder 215, or T4 for Transformer 4, is the principal function of the circuit shown in broken lines in Fig. 5. The

range of the information provided by the number indicator is given in Table I, whilst the illustration in Section 5.4 shows an indicator from which the cover has been removed.

Each wheel of the number indicator is moved independently, and therefore to set all 6 wheels of an indicator completely requires 6 trains of up to 10 impulses; these are delivered simultaneously to all wheels at a stepping speed of 10 impulses per second. A common source provides the impulses for all circuits; this arrangement means that, for any particular setting, each wheel has only to be provided with a circuit marking how many impulses are to be supplied to it.

Employing unselector switches each with 8 levels of 25 points each, one such unselector circuit or diagram-dressing finder can mark an indicator for 25 different 6-digit positions, the other two levels being available for positioning the unselector.

In this way a group or rank of, say, 10 diagram-dressing finders, one per indicator, will enable the diagram to be dressed to show 25 different substations of up to 10-switch capacity.

It was found possible to provide for a theoretical number of 150 substations in 6 such ranks for Manchester Corporation, the smallest positioning 4 indicators and the largest 30. As additional substations are connected it may be found necessary to add additional ranks just before the 150-substation limit is reached, unless the sizes of substations are such that they can be fitted into the spaces still available on the existing ranks.

In the key diagram (Fig. 5), the outline of the circuits for dressing the diagram is shown. A

TABLE I

Position	1st wheel	2nd wheel	3rd wheel	4th wheel	5th wheel	6th wheel
1	F	1	1	1	1	a
2	M	2	2	2	2	b
3	T	3	3	3	3	c
4	R	4	4	4	4	d
5	C	5	5	5	5	e
6	—	6	6	6	6	f
7	—	7	7	7	7	g
8	—	8	8	8	8	h
9	—	9	9	9	9	i
0	—	0	0	0	0	j

F = Feeder.  
M = Motor convertor.  
T = Transformer.  
R = Rectifier.

C = Consumer.  
a = Incoming.  
b = Outgoing.  
c = Outgoing.

common source of impulsing is provided in an impulse-sending circuit *AA*, which provides any number of impulses between 1 and 10 to as many indicator circuits *AB* as the diagram-dressing circuit *AC* orders. The source of impulses at 10 per second is a pendulum relay, which operates slave relays and a uniselector in the impulse-sending circuit. The slave relays pass the impulses to each indicator wheel, the number being controlled from one of 10 wires feeding 1 to 10 impulses according to the wiring connections of the diagram-dressing finders, while the uniselector apportions the impulses on to the 10 wires.

One other circuit is engaged in the operation of dressing the diagram. This is the substation information circuit *AD*, which supplies the following information.

The control circuit is informed of the number of signalling groups which will be transmitted by the substation, so that the code receiver at the control station may accept this number only. As the substations vary in size from one switch up to 28, the substation equipments were made so that they could be equipped to transmit information in a maximum of three groups of impulses using 1, 2, or 3 groups as necessary.

If the substation is partially or wholly out of commission, this fact is indicated on an alarm panel on the control desk, and can be manually set up on a separate panel (shown in the key diagram at *AE*) in the control room by inserting plugs in jacks associated with the individual substations.

The interconnector circuits and busbar couplers are the only circuits on the common diagram fitted without indicators, since their purpose is obvious, and consequently substations fitted with interconnectors and/or busbar couplers have to be signalled as such to the common supervisory control equipment by the substation information circuit.

**4. Outline of Operational Procedure**

**4.1 SUPERVISORY REMOTE-CONTROL SIGNALING BETWEEN CONTROL AND THE SELECTED SUBSTATION**

A substation having been selected for display and the diagram dressed to illustrate its particular arrangement on the common diagram, the

control engineer has only to press the "check" key to cause the display of all existing switch positions and the condition of the alarm circuits. This "check" key is mounted with the other common "operate" keys on the desk, and is connected to the sender connector *B* of the control equipment, which is already connected through the link circuit *V*, and the tandem finder *T*, to the tandem connector *Q*. Its action causes the pilot lines, from the tandem station associated with the substation, to be switched through, and to start the code-sender circuit. This originates a code, the first part of which is the number of the substation, transmitted as three digits totalling 21 impulses, while the second part is a check pulse. The first part of this double code is received at the tandem station and selects the pilot lines to the required substation, and after this first part has been correctly received and has connected the lines through at the tandem station, the second part of the code is transmitted direct into the substation equipment.

A check signal is immediately effective, its action being to cause all the indication signals to be returned from the substation direct into the code receiver. On the completion of these signals the pilot lines are freed for use by any other station.

Indication signals from the substation of all two-position devices are given in 1, 2, or 3 groups, depending upon the size of the substation, the details of each group being shown in Table II.

TABLE II

Group 1	Group 2	Group 3
Buchholz (surge)	BC 2	OCB 15
Buchholz (gas)	IC 1	OCB 16
Distribution fuse	IC 2	OCB 17
Earth-fault indication and trip	OCB 7	OCB 18
Earth-fault indication	OCB 8	OCB 19
Fire	OCB 9	OCB 20
Spare alarm	OCB 10	OCB 21
OCB 1	OCB 11	OCB 22
OCB 2	OCB 12	OCB 23
OCB 3	OCB 13	OCB 24
OCB 4	OCB 14	Spare OCB
OCB 5	D 1	
OCB 6	D 2	
BC 1	D 3	
2 spare OCB	D 4	
	D 5	

Busbar selection and breaker position



The substation information circuit has already indicated to the control circuit how many groups to expect and, as the signal codes are received from the substation and checked for correctness, the indicating lamps on the control desk are energized in accordance with the signal, i.e., either a red or green lamp for each breaker, one of two white lamps to indicate to which busbar a breaker is connected, or a lamp beneath a glass panel, showing the type of alarm for an alarm condition. These signals are given as short positive or negative impulses for conditions which have not recently changed, but for switch-tripping a longer negative impulse is transmitted. Whilst this longer impulse does not prevent the total being correct, it does enable the control circuit to make a special note of the occurrence and indicate that particular switch with a flashing light. The substation equipment is so designed that this recent-change indication can be stored for a matter of 10 minutes, and also that it will be sent only once. By this arrangement, although a substation may send only its number and not its detailed information immediately a switch trips, when it is checked by the control engineer it indicates especially those switches that have tripped.

#### 4.2 CONTROL OPERATION

Pressing a selection key mounted between the red and green lamps indicating the breaker he requires to control, the control engineer causes the control circuit to send a switch-selection code of 15 impulses divided into 3 digits, following the station selection code of 21 impulses, through the tandem station to the substation, where it selects the switch-closing and switch-tripping coils, and also connects the final "operate" circuit at the substation to the pilot lines. This is signalled to the control engineer by the light in the particular selection key changing to a rapid flash (or flicker), whilst simultaneously the close or trip keys, common to the whole desk, light up red or green. At the same time the final "operate" circuit at control is connected to the lines, so that the two final "operate" circuits interact with interlacing pulses and retain the pilots to the exclusive use of the engineer at one end and the selected switch at the other.

A long positive impulse will be sent if the control engineer presses the close key, and at the substation this will energize the closing interposing contactor. When the switch closes, a long positive pulse returned from the substation will change the green indication to red on the control desk for that switch. Similarly, pressing the trip key will perform the reverse operation, using long negative pulses, and until the control engineer presses the reset key he can close and trip the selected circuit breaker as often as desired. He cannot, however, continually energize the switch-closing circuit by keeping his control key pressed, the circuit being arranged to operate once and once only for each distinct key operation.

#### 4.3 OPERATING TIMES

The periods of time required for operations and indications on the common-diagram system indicate the speed with which a large number of substations can be controlled.

A substation signal of a change of conditions takes 4.5 seconds.

Signalling from different tandem stations can occur simultaneously, but two or more substations connected to the same tandem station must signal in sequence, each taking

4.5 seconds.

The largest number of substations connected to any one of the 12 tandem stations is 24; therefore the time taken to signal a complete shut-down of 288 substations would be

1 minute, 48 seconds.

The time required for the complete display of the largest substation giving the positions of 28 breakers, their busbar selections, and 7 alarms, representing a total of 59 indications, is

23.5 seconds.

To select and operate the switch and indicate its operation requires

12.5 seconds.

### 5. Equipment

#### 5.1 APPARATUS

Automatic-telephone switching apparatus has been used throughout, and this, with the exception of the pendulum relay, combined key and lamp, and the number indicator, conforms to standard Post Office designs.

### 5.2 PENDULUM RELAY

To provide uniform timing of impulses, pendulum-controlled impulse relays are used as the fundamental source of uniformly timed impulses. The relays are similar to the P.O. 3000-type major relay, but are provided with a horseshoe extension at the end of the relay core and a vibrating reed operating within the arms of the horseshoe. A pair of contacts on each side of the operating reed, mounted in a somewhat similar manner to those of the normal relay, are operated by the reed at its fundamental frequency, one of the contacts being used to drive the reed through the medium of the energizing winding on the core.

### 5.3 COMBINED KEY AND LAMP

To reduce the amount of control-panel area, a control key which includes an inset indicating lamp has been developed. This comprises a diecast body, on the sides of which are mounted twin-contact lever springs of the type used for automatic-telephone relays. Inside the body and between the springs is carried the lamp mounting, which projects into the barrel of the operating knob carried in the front of the die castings. This barrel is shaped and spring-loaded so as to provide a number of different types of movement of the knob. It can be made to operate the springs by turning through an angle of 90 degrees; by a push-and-pull action; by a push-in spring-return action; or by a short spring-return action on either of two positions normally 90 degrees apart.

It is arranged for single-hole fixing in the control panel, and the operating knob is 1 inch in diameter with an indicating window approximately 1 inch in diameter. The indicating window is therefore quite large enough for the display of an abbreviated description of the function of the key, whilst arrows inscribed in the window can be used to indicate whether the key has to be turned or pressed.

### 5.4 NUMBER INDICATOR

To designate substations, feeders, and transformers, electrically operated indicators have been developed, built on the unit principle, in which each wheel, showing one digit of a number,

with its operating mechanisms, forms a complete and separate unit. In this respect it is quite unlike the better-known Veeder counter and has the great advantage that all wheels can be operated simultaneously and independently to any of their positions (see illustration).

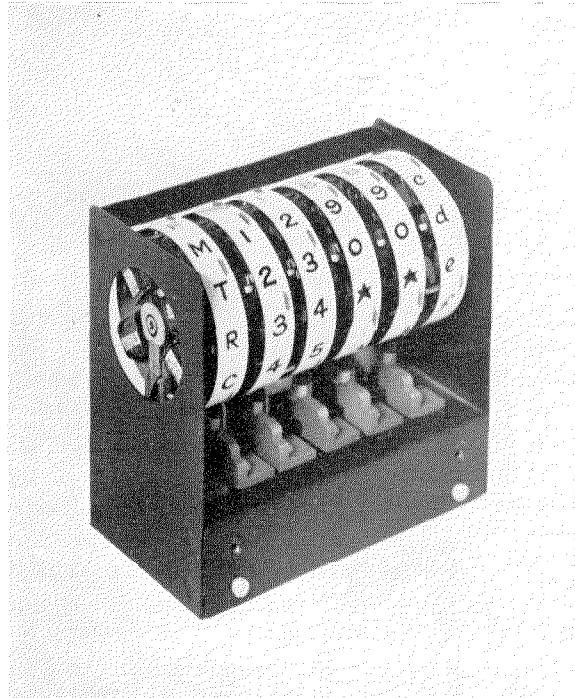

Number indicator with cover removed.

Each unit comprises a simple 4-pole stator and a wheel-type rotor with bent-over fins revolving about the centre of the stator and around the outside of the stator poles. By energizing the stator poles in pairs, the rotor is attracted to move through 30 degrees, in two movements of 15 degrees each, against a light return spring. A small spring catch beside each pole of the stator is energized by the operating windings and prevents backward movement of the rotor; it thereby ensures continuous forward movement so long as impulses are delivered to the pair of stator windings. The indicator windings remain energized for as long as the display is required, and for this purpose an external resistance is introduced by the control circuit to economize in current and reduce heating. The digits appearing in the instrument window are quarter-

inch characters for capitals, in black on a white background.

By using the number indicator, a designation comprising 6 characters is displayed in a length of 3 inches, the whole indicator in its casing being approximately 4 inches long by  $2\frac{1}{2}$  inches wide by  $3\frac{1}{2}$  inches deep. The indicators are wired to a removable multi-point plug to facilitate maintenance.

### 5.5 SUBSTATION EQUIPMENT

At each substation, the cubicle containing the relays and switches is one of five standard sizes. Equipment external to the cubicle consists of a battery, with a metal-rectifier automatic charging supply, and interposing relays which are mounted upon the panels or cubicles of the switchgear to be controlled.

With the exception of the largest, the supervisory cubicles were designed for wall-mounting with front access only, the relays and switches being mounted upon a drop frame, hinged along its lower edge, to provide the necessary access to the wiring. The relays, suitably grouped into circuits, were mounted upon removable jack-in panels. In the largest substation cubicle, front and rear access was provided to enable the terminal units for the interconnecting cables between the supervisory equipment and the switchgear to be accommodated on each side of the central framework.

The question of unit-type design to facilitate standardized arrangements for the wide variations of requirements is of considerable importance, if maintenance and spares are to be reduced to a minimum. The requirements vary

between one switch indicated only, plus alarms, to 28 switches controlled and indicated, the number of units of equipment used being given in Table III.

### 5.6 CONTROL-STATION RELAY-ROOM EQUIPMENT

In the relay room for both the common-diagram system, and eight 33-kilovolt substations, the operation of which has now been centralized in the control room, provision has been made for 8 rows of racks, only 5 of which are occupied at present. The whole of the relay and switching equipment for the common-diagram system occupies 3 racks at one end of the room, and cabling has been initially installed for 400 substations. The present floor space will not be exceeded by the ultimate expansion planned.

At the other end of the room two suites are occupied by the supervisory relay racks for the 33-kilovolt substations which were remotely controlled from other centres, previous to the planning of the present scheme. The central space at present unoccupied, approximately 15 feet by 21 feet, is considered ample for any future developments. Racks 8 feet, 6 inches high and either 2 feet, 6 inches or 4 feet, 6 inches wide, depending upon the equipment to be mounted upon them, have been used for the common-diagram system. Equipment is mounted upon one side of the rack, with wiring on the other side, and, wherever convenient and necessary for testing or maintenance, relays and switches are mounted upon jack-in panels. A cross-connecting frame enables all wiring between the substation marker and finder circuits and the diagram-dressing circuit, which is particular to the substation, to be readily provided as further substations are brought into use.

### 5.7 CONTROL ROOM

Particulars of the supply-system control room are shown in Fig. 6. The batteries, charging gear, pilot-cable terminals, supervisory-switch, and relay equipment are on the ground floor.

The upper floor houses ventilating and heating plant, a telephone exchange, canteen, cloak-room, log store, system diagrams, and control desk.

TABLE III

Facilities and equipment	Capacity of cubicle				
	A	B	C	D	E
Indicated OCB's	4	10	8	12	28
Controlled OCB's	—	—	8	12	28
Alarms	7	7	7	7	7
Telephone	—	4	—	—	—
D-C lock-outs	—	—	5	5	5
Number of indicating groups	1	2	2	2	3
Relay panel (design 1)	1	1	1	1	1
Relay panel (design 2)	1	1	1	1	1
Relay panel (design 3)	—	—	1	1	1
Uniselectors	1	1	3	4	5

The control room is elliptical, the walls being formed of panels for supervisory control of the 33-kilovolt equipment, lighting and ventilating-plant switchgear, meters, load-summation indicators, and complete system diagrams. A ceiling specially designed by illumination experts was provided to accommodate coloured fluorescent lighting tubes, which give a daylight effect, a high standard of illumination on horizontal and vertical surfaces, and freedom from shadow and glare.

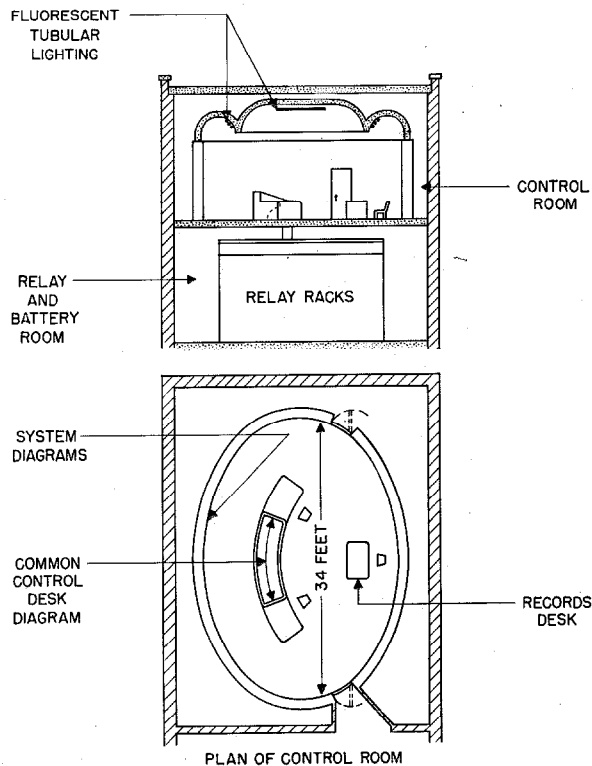

Fig. 6—General arrangement of a control room housing a common-diagram system.

In the middle of the room, the control desk has accommodation on the wings for two control engineers, Post Office telephone and private telephone facilities for communication with every staff office, generating station, substation, and depot on the system. There is also a card index of substation data, diagrams, names, and code numbers. The common-diagram control equipment occupies the middle section of the desk.

The panel walls are coloured *eau-de-nil*, the beading, doors, and furniture mahogany, and the floor pink with a dark green and black border.

## 6. Considerations of Cost and Space

### 6.1 Costs

Considerable economy would be expected both in first cost and when extending a common-diagram system, as compared with individual supervisory equipment for each substation. The cost of supervisory control equipment for a substation may be divided into two parts, (A) control-station equipment, including the control diagram board, and (B) substation equipment, including interposing relays and cabling. Both costs may be sub-divided into a basic part plus an adjustment for each switch-control indicator and alarm. In general, the basic equipment is designed to cater for a maximum number of facilities and will vary accordingly. It is rarely fully equipped at the outset, being intended to cater for future extensions within the forecast maximum.

In addition to these normal variations, there are other considerations to be taken into account when assessing the probable cost of installation. These concern the degree to which the control station is to be completely equipped so as to be agreeable to and maintain the alertness of its occupants; the cost of pilot cables necessary; modifications of switchgear to add electrical closing and tripping gear; and whether or not battery equipment additional to that already existing is to be provided.

Some form of cost comparison, however, can be obtained by assuming either that supervisory equipment only is to be supplied, or that supervisory equipment plus interposing relays, cable, battery equipment, and installation, are included. The following comparisons have been made upon the basis of fully equipped stations, each with 20 switches controlled and indicated, plus five alarms indicated only.

It might be supposed that with the common-diagram system there is a minimum number of substations at which it becomes economic when compared with individual equipment for each substation. This is correct, but the minimum number varies with the ultimate capacity of the

common-diagram system, since it is obvious that the economy effected is due almost wholly to a saving in control-station equipment, and also that the amount of common equipment provided for a common-diagram system with an ultimate capacity of 25 substations will be smaller than that provided for 50, 100, 200, or more substations.

It should be noted that for an individual equipment providing only for indication and alarms, the substation section cost will be between 35 and 45 per cent of that of the whole equipment, whilst if equipment for both control and indication is provided, the substation cost rises to between 55 and 60 per cent of the whole cost. This increase is indicative of the high proportion of the whole cost required to provide for interposing relays and cabling.

In Fig. 7, curve *A* shows the minimum number of substations, expressed as a percentage of the maximum substation capacity of the system, at which the common-diagram system will prove economic when the substations are fully equipped. Curve *C* indicates the percentage saving at first cost effected when considering a fully equipped common-diagram system, as compared with individual systems to give the same facilities. For comparison, curve *B* indicates the percentage saving of first cost of the supervisory equipment only of a common-diagram system compared with individual systems, and shows a higher saving than that indicated in curve *C* for the same equipment complete with all cabling, accessories, and power supplies installed ready for service. Both curves exclude any cost for either switchgear modifications or pilot lines.

## 6.2 SPACE ECONOMY

Equally as important as economy of cost is the saving in control building-space achieved by the adoption of a common-diagram system and it is possible to assess the approximate space saved on a hypothetical basis. For this purpose, we need only consider the control room and its associated relay room, since the substation requirements will be approximately the same for individual systems as for a common-diagram system. The following curves are based upon substations equipped to control and indicate 20 circuit breakers and five alarms.

Curves *A* and *B* in Fig. 8 illustrate the difference in relay room space for the two systems, and Fig. 9 compares the control-room space for individual and common-diagram system requirements. These curves can, of course, only be approximate and are based on the following estimate:

A. That an individual system of the size stated would require 5 square feet of control diagram per substation.

B. That the individual control panels, each with a maximum height of 6 feet operating space, would be arranged in a

semicircle for up to 25 substations (ultimate), and in a circle for a larger number of substations; also that a minimum control-room size of 25 feet diameter for the semicircular pattern would be chosen. The curves are then based on areas semicircular or circular, adding nothing for the corners which usually result when a circular room is placed within a rectangular building.

C. For the relay room, rack space for the individual system is assumed to be 4 feet high by 3 feet wide per substation, using racks 8 feet, 6 inches high. No headroom allowance has been made for the end of suites.

D. Space in common-diagram system calculations is of the same order as that provided at Manchester.

Fig. 10 indicates the total percentage saving in space obtained at the control centre on these hypotheses. As would be expected, the savings increase with the number of substations controlled, attaining figures showing an economy of 86 per cent in space for the largest installations.

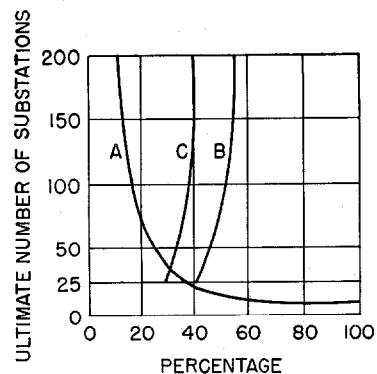

Fig. 7—*A*—Minimum number of substations equipped initially for which common-diagram system is economical compared with individual systems, expressed as a percentage of the number to be equipped ultimately. *B*—Saving in first cost of common-diagram-system supervisory equipment only, expressed as a percentage of equivalent individual systems. *C*—As *B*, but including costs of cabling, interposing relays, power supplies, erection, and testing.

### 6.3 MAINTENANCE COSTS

Records of cleaning and maintenance costs for individual-type supervisory equipment show that the amount per substation is small, being almost entirely for labour.

traction, and domestic loads increase, but it is believed that, in the system described, a basis for meeting these requirements without adversely affecting present facilities has been provided.

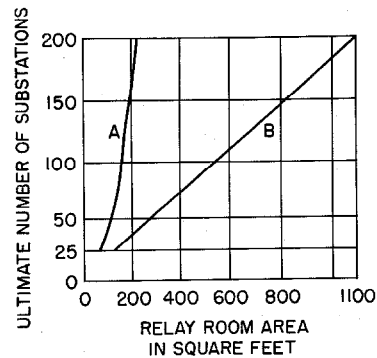

Fig. 8—Comparison of relay-room area, A—common-diagram system, and B—equivalent individual system.

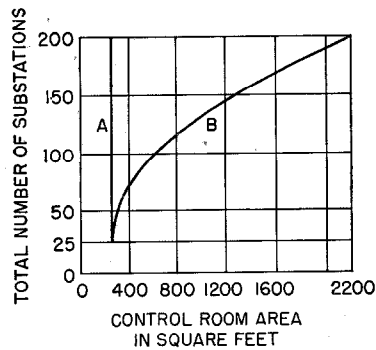

Fig. 9—Comparison of control-room area, A—common-diagram system, and B—equivalent individual system.

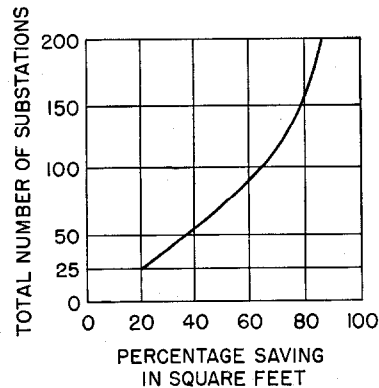

Fig. 10—Total saving in space obtained from comparisons shown in Figs. 8 and 9, expressed as a percentage of space required for individual systems.

The relatively smaller amount of equipment required at the control station where a common-diagram system is installed, and also the large degree of standardization obtained for the relays, switches, etc., would indicate that the maintenance costs would be *pro rata* on a quantity basis, since similar equipment is used; consequently these costs should show a percentage economy as compared with the individual system at least equal to that shown in Fig. 7, curve C, for the economy of first cost.

The authors wish to thank Mr. H. C. Lamb, late Chief Engineer and Manager, and Mr. R. A. S. Thwaites, Chief Engineer and Manager, of the Manchester Corporation Electricity Department, and Standard Telephones and Cables, Limited, for permission to publish particulars of the development and installation.

### 7. Conclusion and Acknowledgments

It is thought that, by the development of these ideas, the use of supervisory remote-control equipment has been extended on normal automatic-telephone switching practice to a wider application than was practicable with individual systems for large numbers of substations. As might be expected, this results in an economy of cost of equipment, an economy of cost for control buildings, and an economy of effort of the control staff. Operational control of large electricity supply systems will undoubtedly produce new requirements and problems as industrial,

### 8. Bibliography

1. W. Kidd and J. L. Carr, "The Application of Automatic Voltage and Switch Control to Electrical Distribution Systems," *Journal of the Institution of Electrical Engineers*, v. 74, p. 285; 1934.
2. M. Schleicher, "Modern Practice in Germany and the European Continent with regard to Supervisory Control Systems as applied to Large Interconnected Supply Areas," *Journal of the Institution of Electrical Engineers*, v. 75, p. 710; 1934.
3. A.I.E.E. Joint Sub-Committee of the A.I.E.E. Committees on Automatic Stations and on Instruments and Measurements, "Telemetry, Supervisory Control and Associated Circuits," Revised edition; October, 1941.
4. E. M. S. McWhirter, "The Centralization of Control of Power Networks," *Electrical Communication*, v. 13, pp. 255-273; January, 1935.
5. J. D. Peattie, "Control Rooms and Control Equipment of the Grid System," *Journal of the Institution of Electrical Engineers*, v. 81, pp. 607-624; 1937.
6. G. A. Burns and T. R. Rayner, "Remote Control of Power Networks," *Journal of the Institution of Electrical Engineers*, v. 79, p. 95; 1936.

# Anomalous Attenuation in Waveguides\*

By JOHN KEMP

*Standard Telephones and Cables, Limited, London, England*

THE puzzling phenomenon of decreasing attenuation constant with increasing frequency which occurs in a few isolated instances is here elucidated by treating the guides concerned as limiting cases of a guide of more general shape in the interior of which the waves display the normal properties characteristic of waves in guides generally. The equations of the electromagnetic field, cut-off frequency, and attenuation constant describing the isolated cases are then, in like manner, deduced as limiting cases from those appropriate to a guide of general shape. The isolated cases thus lose their character of isolation and assume that of straightforward limits instead. According to the point of view developed in the paper, these limiting cases imply an electromagnetic field which extends to infinity along one of the transverse co-ordinates but, being wrapped around the axis of the guide, the field is constrained to exist in finite space where it continues to display the properties characteristic of a field of infinite extent.

. . .

It is a well-known fact that when an electromagnetic wave is traversing a transmission line of any conventional type, it is always possible to find a frequency above which the attenuation constant of the wave is a steadily increasing function of frequency. This property also appertains to waves propagated through the interior of hollow metal tubes with the exception, however, of a few seemingly isolated cases. There is, for instance, the case where the  $H$ -wave (also known as the transverse electric or  $TE$ -wave) of zero order is propagated through a tube of circular cross-section. Here, as in two further cases to be dealt with below, the attenuation constant follows a course precisely opposite to that normally encountered; that is to say, in each case a frequency can be found above which

the attenuation steadily *decreases* and ultimately vanishes altogether.

This striking anomaly may be accounted for satisfactorily by means of Ampère's Law of electromagnetic induction, whereby the current induced in the metal tube may be stated in terms of the tangential components of the magnetic field at the surface of the metal—the longitudinal component of the current in terms of the transverse component of the field—and the transverse component of the current in terms of the longitudinal component of the field. Now in the exceptional case of the  $H$ -wave of zero order in a guide of circular cross-section, all lines of magnetic force are at any frequency restricted to radial planes (Fig. 1) and in consequence the transverse tangential component is always zero. There thus remains only the longitudinal tangential component and as this component—in common with the longitudinal component of all other waves in hollow metal tubes—is a steadily decreasing function of frequency, the attenuation of the wave is of necessity also a diminishing function of frequency.

As an instructive alternative explanation it is here suggested that a guide of circular cross-section might be regarded as an extreme case of a guide having a cross-section of sector shape (Fig. 2). In such a guide the  $H$ -wave of zero order displays the normal properties characteristic of waves in guides generally and from these there emerge as straightforward limiting cases those appropriate to waves in a circular guide. By this procedure, the appearance of an anomaly is completely eliminated. Moreover, by extending the analysis to guides encompassed by two coaxial circular cylinders and two radial planes (Fig. 3), the properties of  $H$ -waves of zero order may be stated in a general form which includes as particular cases those associated with guides of rectangular, circular, sector- and ring-shaped cross-sections, with and without baffle planes.

We shall first recapitulate for ready reference the well-known relevant formulae relative to a

\* Reprinted from *Wireless Engineer*, v. 23, pp. 211-216; August, 1946.

rectangular guide. We shall then establish the corresponding formulae for a guide of sector shape leading to those for circular guides. Finally we shall proceed to the general case and identify as particular cases the results recorded for the guides of more special shape.

1. Principal Symbols

- $a$  = width of rectangle in metres
- $b$  = height of rectangle in metres
- $r_0$  = radius of sector in metres
- $r_1, r_2$  = inner and outer radii of ring-sector in metres
- $\phi$  = sector angle in radians

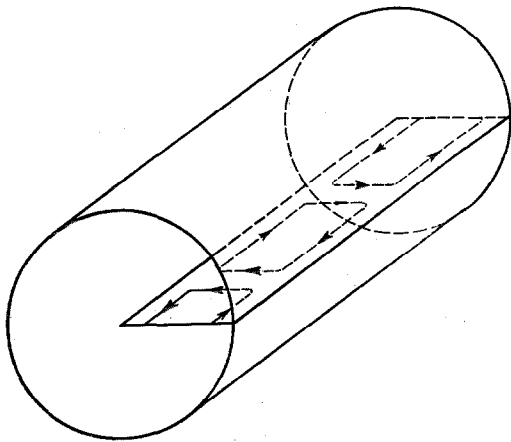

Fig. 1—Pattern representing the magnetic field in any radial plane of a circular guide transmitting an  $H$ -wave, of zero order and principal mode. If the plane is turned full circle the pattern describes a set of toroidal surfaces which completely represent the magnetic field in space.

$\mu, \bar{\mu}$  = permeability of dielectric and conductor, respectively, in henrys per metre; for vacuum  $\mu_0 = 4\pi \times 10^{-7}$

$\epsilon, \bar{\epsilon}$  = permittivity of dielectric and conductor, respectively, in farads per metre; for vacuum,  $\epsilon_0 = \frac{1}{36\pi} \times 10^{-9}$

$g, \bar{g}$  = conductivity of dielectric and conductor, respectively, in mhos per metre; for pure copper  $\bar{g} = 5.8 \times 10^7$

$c = \frac{1}{\sqrt{\mu\epsilon}}$  = characteristic velocity of waves in

the unrestricted medium in metres per second; for vacuum  $c = 3 \times 10^8$

$f$  = frequency in cycles per second

$f_{0m}$  = cut-off frequency of the  $m$ th mode in cycles per second

$$v_{0m} = \frac{f_{0m}}{f}$$

$$\omega = 2\pi f$$

$\alpha_{0m}$  = attenuation constant corresponding to the  $m$ th mode in nepers per metre

$\Gamma$  = propagation constant in the  $z$  direction per metre

$k_{1m}$  =  $m$ th non-vanishing root of  $J_1(x) = 0$ ; i.e.,  $k_{11} = 3.83$ ;  $k_{12} = 7.02$ ;  $k_{13} = 10.17$ .

2. Guides of Rectangular Cross-Section

The electric and magnetic intensities of an  $H$ -wave of zero order and  $m$ th mode<sup>1</sup> in a guide of rectangular cross-section, having metal walls of infinite

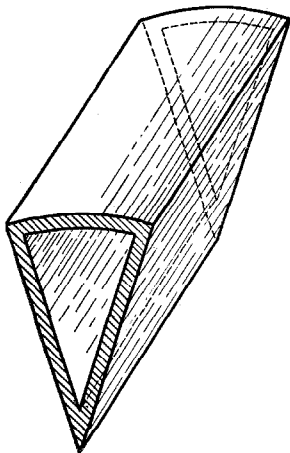

Fig. 2—Guide of sector-shaped cross-section.

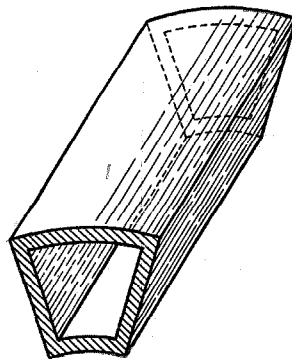

Fig. 3—Guide composed of portions of coaxial circular cylinders and radial planes.

<sup>1</sup> The characteristic feature of any  $H$ -wave is a prominent magnetic field in the direction of propagation. To rank as a wave of "zero" order it is required that in the direction of one of the transverse co-ordinates of the guide—for instance, the height of a rectangular guide—every one of the six components of the electromagnetic field is independent of the coordinate, that is to say, is of "zero variation" in that direction. The mode  $m$  specifies the number of half-cycles to which the non-vanishing components of the field are subjected in the direction of the other transverse co-ordinate of the guide—for instance, the width of a rectangular guide. The first mode is frequently referred to as the principal mode.



conductivity and a dielectric that is nondissipative, are given by

$$\left. \begin{aligned} E_x &= 0, & E_z &= 0, & H_y &= 0, \\ E_y &= -\frac{m\pi}{a} \sin\left(\frac{m\pi}{a}x\right)e^{-\Gamma z}, \\ H_x &= \left(\frac{1-\nu_{0m}^2}{\mu/\epsilon}\right)^{\frac{1}{2}} \frac{m\pi}{a} \sin\left(\frac{m\pi}{a}x\right)e^{-\Gamma z}, \\ H_z &= \frac{1}{j\omega\mu} \left(\frac{m\pi}{a}\right)^2 \cos\left(\frac{m\pi}{a}x\right)e^{-\Gamma z}. \end{aligned} \right\} (1)$$

If the conductivity of the metal walls is finite but high, the above expressions of the field become approximations but remain amply accurate for our purpose. As usual the time factor  $\exp j\omega t$  is omitted.

Since both  $E_x$  and  $E_z$  are zero, the lines of electric force may be represented by patterns of parallel lines stretching from top to bottom with densities that vary sinusoidally across any transverse section of the guide. For the case where  $m=1$  (Fig. 4), the electric field is a maximum along the middle line of the section and zero at each of the two side walls. This pattern is subject to the usual cyclic variation with time, that is to say, the pattern fades away, increases in the opposite direction to its original intensity, fades again, and finally re-assumes the original configuration from which the next cycle begins.

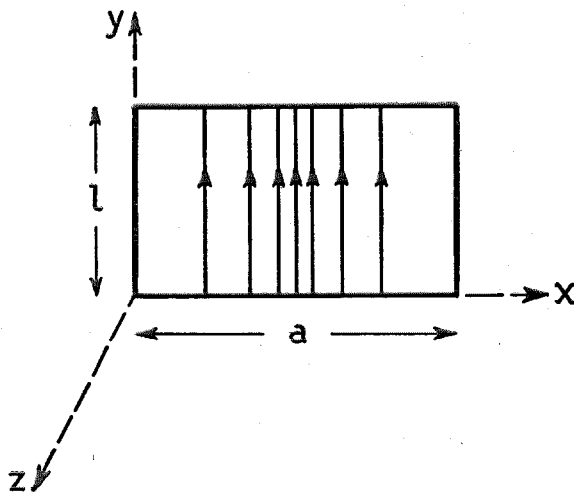

Fig. 4—Pattern representing the electric field of an *H*-wave, of zero order and principal mode, propagated through a rectangular guide.

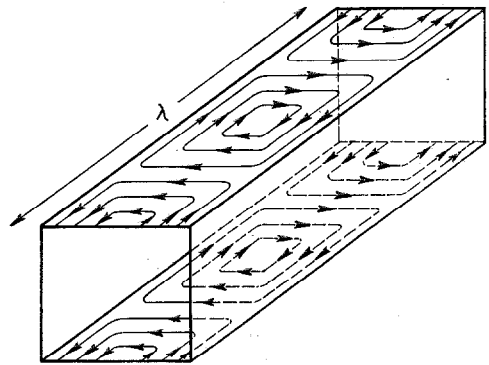

Fig. 5—Pattern representing the magnetic field in any horizontal plane of a rectangular guide transmitting an *H*-wave, of zero order and principal mode.  $\lambda$  indicates the length of the wave.

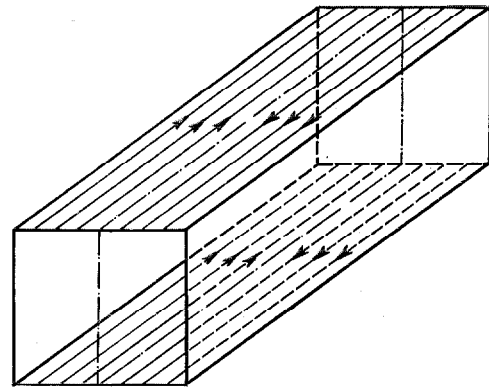

Fig. 6—Pattern representing the magnetic field in any horizontal plane of a rectangular guide supporting an *H*-wave, of zero order and principal mode, at the cut-off frequency.

The lines of magnetic force are restricted to horizontal planes and, since both  $H_x$  and  $H_z$  are independent of the height of the guide, the magnetic pattern is identical in all horizontal planes. For  $m=1$  (Fig. 5), there is a single row of closed curves. The distance between recurring configurations of the pattern indicates the wavelength. With falling frequency, the loops lengthen and finally, at cut-off frequency, they break up into two sets of parallel lines as shown in Fig. 6. The magnetic field is now divided into two halves pointing in opposite directions and being separated from one another by the vertical mid-plane (shown dotted in Fig. 6) where the magnetic intensity is permanently zero. While the magnetic field is thus being broken up, no corre-

sponding change takes place in the electric field. This field retains at cut-off frequency the character indicated in Fig. 4; that is, at any given instant the electric intensities in both halves of the guide point in the *same* direction. In consequence we are led to the conclusion that energy is simultaneously thrust from the interior towards each of the side walls whence it is reflected back towards the mid-plane. There are thus two transverse pulsations of energy, between mid-plane and side walls, without any concurrent transmission of energy along the guide. The frequency at which this resonant state is reached is given by

$$f_{0m} = \frac{m\pi}{2\pi a} c. \tag{2}$$

Assuming that the dielectric medium is non-dissipative, as in the case of air, we have for the attenuation constant of the wave

$$\alpha_{0m} = \frac{\left(\frac{\mu\pi f}{g}\right)^{\frac{1}{2}}}{\left(\frac{\mu}{\epsilon}\right)^{\frac{1}{2}}} \left[ \frac{1}{b(1-\nu_{0m}^2)^{\frac{1}{2}}} + \frac{2\frac{1}{4}\nu_{0m}^2}{a_1^2(1-\nu_{0m}^2)^{\frac{1}{2}}} \right]. \tag{3}$$

The first term is due to currents induced in the top and bottom walls by the tangential magnetic intensities  $H_x$  and  $H_z$ . For all frequencies above  $3f_{0m}$ , this term is an increasing function of frequency (Fig. 7). The second term arises from currents induced in the side walls. These are due to the longitudinal magnetic field  $H_z$  only; for  $H_x$ , being perpendicular to the side walls, is prevented from setting up currents in them. This second term is a decreasing function of frequency (Fig. 7). As the cut-off frequency (2) is independent of  $b$ , the height of the guide may be increased indefinitely without affecting the character of the wave. At the same time the first term of the attenuation constant (3) diminishes and ultimately, when the rectangular guide becomes a guide composed of two parallel planes, only the second term of (3) remains; and now, with increasing frequency the attenuation actually tends towards zero. Although this case is of no practical importance it is, as we shall presently see, the exact counterpart of a physically realizable guide, namely the guide of circular cross-section.

### 3. Guides of Sector Cross-Section

In so far as  $H$ -waves of zero order are concerned there is a close correlation between a guide of rectangular cross-section in a cartesian system of co-ordinates  $(x, y, z)$  and a guide of sector-shaped cross-section in a cylindrical system of co-ordinates  $(r, \phi, z)$  (Fig. 8). The form of the equations of the electromagnetic field is

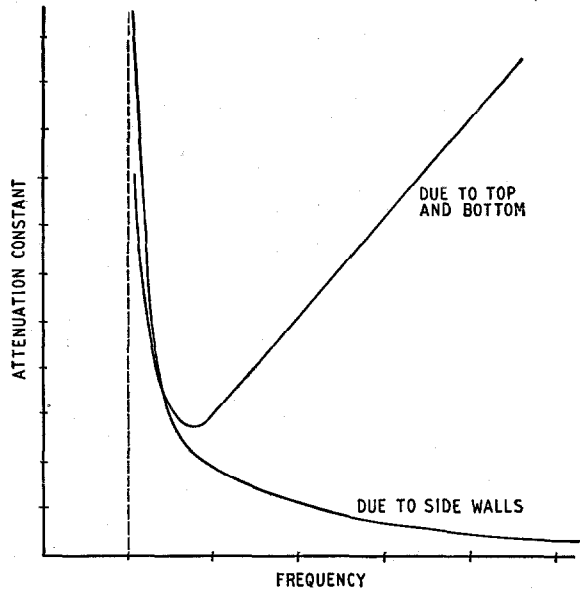

Fig. 7—Analysis of the attenuation constant of an  $H$ -wave of zero order propagated through a guide of rectangular cross section.

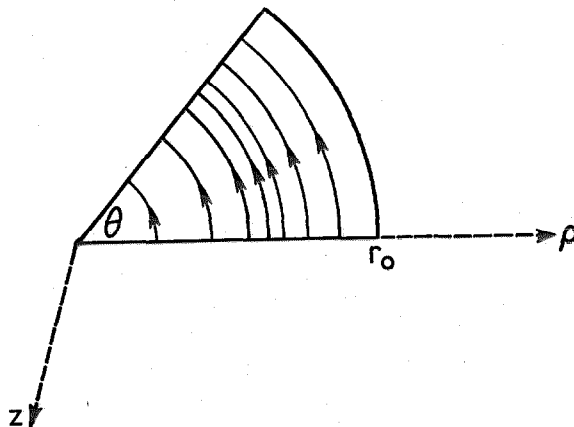

Fig. 8—Pattern representing the electric field of an  $H$ -wave, of zero order and principal mode, propagated through a guide composed of a portion of a circular cylinder and two radial planes.

exactly the same in the two cases; in place of the circular functions, we now have Bessel functions of the first kind, and in place of the non-vanishing roots of  $\sin x = 0$ , we now have the non-vanishing roots of  $J_1(x) = 0$ , which are denoted below by  $k_{1m}$ . Thus

$$\left. \begin{aligned} E_r &= 0, & E_z &= 0, & H_\phi &= 0, \\ E_\phi &= -\frac{k_{1m}}{r_0} J_1\left(\frac{k_{1m}r}{r_0}\right) e^{-\Gamma z}, \\ H_r &= \frac{(1-\nu_{0m}^2)^{\frac{1}{2}} k_{1m}}{(\mu/\epsilon)^{\frac{1}{2}} r_0} J_1\left(\frac{k_{1m}r}{r_0}\right) e^{-\Gamma z}, \\ H_z &= \frac{1}{j\omega\mu} \left(\frac{k_{1m}}{r_0}\right)^2 J_0\left(\frac{k_{1m}r}{r_0}\right) e^{-\Gamma z}. \end{aligned} \right\} \quad (4)$$

The pattern of the electric field now consists of concentric arcs (Fig. 8) and that of the magnetic field of closed curves in radial planes (Fig. 9).

The cut-off frequency is given by

$$f_{0m} = \frac{k_{1m}}{2\pi r_0} c, \quad (5)$$

which differs from the expression found for the rectangular guide merely in that the root of the Bessel function takes the place of that of the corresponding circular function.

As the attenuation constant may be calculated by Schelkunoff's well-known general formula<sup>2</sup> in a perfectly straightforward manner, it may suffice here merely to state the result.

$$\alpha_{0m} = \frac{\left(\frac{\bar{\mu}\pi f}{\bar{g}}\right)^{\frac{1}{2}}}{\left(\frac{\mu}{\epsilon}\right)^{\frac{1}{2}}} \left[ \frac{2}{\phi r_0} C_{1m} \frac{1}{(1-\nu_{0m}^2)^{\frac{1}{2}}} + \frac{2}{\phi r_0} \frac{\nu_{0m}^2}{(1-\nu_{0m}^2)^{\frac{1}{2}}} + \frac{1}{r_0} \frac{\nu_{0m}^2}{(1-\nu_{0m}^2)^{\frac{1}{2}}} \right], \quad (6)$$

where

$$C_{1m} = \frac{\int_0^{k_{1m}} [J_1(x)]^2 dx}{k_{1m} [J_0(k_{1m})]^2}.$$

The factor  $C_{1m}$  is always greater than unity. The lowest value occurs for  $m = 1$  in which case  $C_{1m}$  is approximately 1.01. The first term in (6) arises from currents induced in the radial planes,

partly by  $H_r$ , and partly by  $H_z$ . After a minimum is passed, this term is an increasing function of frequency. The second and third terms arise, respectively, from currents in the radial planes and in the cylindrical surface in consequence of the longitudinal field; both of these terms are decreasing functions of frequency. Since the

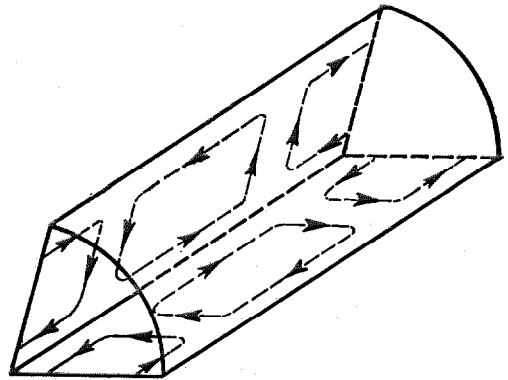

Fig. 9—Patterns representing the magnetic field in any radial plane of a guide of sector-shaped cross-section transmitting an  $H$ -wave, of zero order and principal mode.

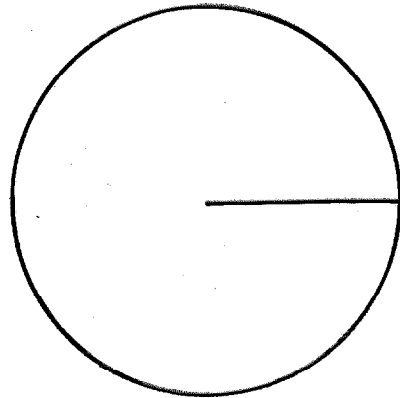

Fig. 10—Guide composed of a circular cylinder and a radial baffle plane.

cut-off frequency (5) is independent of the sector angle, (6) is applicable to the case of  $\phi = 2\pi$ , that is to say, to a circular guide with a single radial baffle plate (Fig. 10).

A sector angle of  $2\pi$  appears to be the limiting value for a guide in physical space, but this restriction need not be applied to the equations of the field or the equations of the cut-off frequency and attenuation constant. Although

<sup>2</sup>S. A. Schelkunoff, "Transmission Theory of Plane Electromagnetic Waves," *Proceedings of the I. R. E.*, v. 25, p. 1482; November, 1937.

originally established for physical space, their range of validity extends into the region of  $\phi$  beyond  $2\pi$ —a fictitious region, known also as Riemann Space,<sup>3</sup> where the sector angle may, indeed, be increased indefinitely. In consequence, the length of the arc  $\phi r_0$  increases correspondingly, with the result that the first two terms of (6) tend towards zero. As the radial planes of the guide are thus ultimately of no effect they may be removed, and now the barrier between physical and fictitious space effectively breaks down, and there remains a guide of circular cross-section. On this view, then, a guide of circular cross-section is the extreme case of a guide of sector-shaped cross-section, for which the length of the arc becomes infinite—in exact correspondence to the extreme case of the rectangular guide for which the height increases indefinitely. As the first two terms in (6) vanish, the attenuation constant is supplied by the third term alone, which is a falling function with increasing frequency.

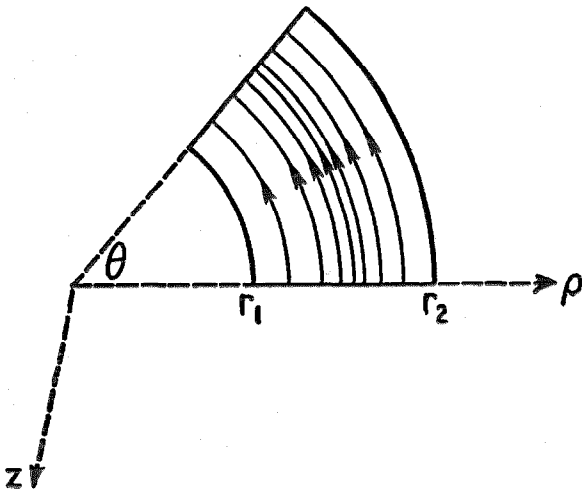

Fig. 11—Pattern representing the electric field of an *H*-wave, of zero order and principal mode, propagated through a guide composed of portions of two coaxial circular cylinders and two radial planes.

As a check of our last result, we may employ a method that does not require the notion of a fictitious space. Let us assume that while the conductivity of the metal of the cylinder retains a high, but finite, value, that of the baffle plane

<sup>3</sup> J. H. Jeans, "The Mathematical Theory of Electricity and Magnetism," 5th Edition, p. 283.

is allowed to increase indefinitely. If then, instead of being given as a product of two factors, (6) is re-written as a sum of three separate terms, the first two terms, which refer to the baffle plane, again tend towards zero. Moreover, as the baffle plane does not constrain the field, the plane may be deleted altogether. There thus again remains a guide of circular cross-section for which the attenuation constant is as before correctly given by the third term of (6).

4. Guides of Ring-Sector Section

The treatment of this case (Fig. 11) is identical with that of the sector-shaped guide except that to the Bessel function of the first kind there must now be added that of the second kind. If we put

$$Z_n(\chi r) = A J_n(\chi r) + B N_n(\chi r),$$

where *A* and *B* are real and  $\chi$  is a function of the radii  $r_1$  and  $r_2$ , the electromagnetic field is given by

$$\left. \begin{aligned} E_r &= 0, \\ E_\phi &= -\frac{\nu_{1m}}{r_2 - r_1} Z_1\left(\frac{\nu_{1m}}{r_2 - r_1} r\right) e^{-\Gamma z}, \\ E_z &= 0, \\ H_r &= \left(\frac{1 - \nu_{0m}^2}{\mu/\epsilon}\right)^{\frac{1}{2}} \frac{\nu_{1m}}{r_2 - r_1} Z_1\left(\frac{\nu_{1m}}{r_2 - r_1} r\right) e^{-\Gamma z}, \\ H_\phi &= 0, \\ H_z &= \frac{1}{j\omega\mu} \left(\frac{\nu_{1m}}{r_2 - r_1}\right)^2 Z_0\left(\frac{\nu_{1m}}{r_2 - r_1} r\right) e^{-\Gamma z}, \end{aligned} \right\} \quad (7)$$

where  $\nu_{1m}$  denotes the *m*th root of the equation

$$J_1(\chi r_1) N_1(\chi r_2) - J_1(\chi r_2) N_1(\chi r_1) = 0;$$

moreover  $m\pi \leq \nu_{1m} \leq k_{1m}$ .

The cut-off frequency is given by

$$f_{0m} = \frac{\nu_{1m}}{2\pi(r_2 - r_1)} c. \quad (8)$$

If  $r_1$  approaches zero, (7) and (8) become identical with those appropriate to a sector-shaped guide, that is, (4) and (5). If both  $r_1$  and  $r_2$  are very large, the Bessel functions in (7) may be replaced by their asymptotic expansions whereby (7) assumes the form of (1); i.e., that of the field within a rectangular guide.

As before, the attenuation constant may be calculated by the general formula in a straightforward manner with the result

$$\alpha_{0m} = \left( \frac{\mu \pi f}{g} \right)^{\frac{1}{2}} \left\{ 2 \frac{\int_{r_1}^{r_2} [Z_1(\chi r)]^2 dr}{\phi r_2^2 [Z_0(\chi r_2)]^2 - r_1^2 [Z_0(\chi r_1)]^2} \times \frac{1}{(1 - \nu_m)^{\frac{1}{2}}} \right. \\ \left. + \frac{2 r_2 [Z_0(\chi r_2)]^2 - r_1 [Z_0(\chi r_1)]^2}{\phi r_2^2 [Z_0(\chi r_2)]^2 - r_1^2 [Z_0(\chi r_1)]^2} \frac{\nu_{0m}^2}{(1 - \nu_{0m}^2)^{\frac{1}{2}}} \right. \\ \left. + \frac{r_2 [Z_0(\chi r_2)]^2 + r_1 [Z_0(\chi r_1)]^2}{r_2 [Z_0(\chi r_2)]^2 - r_1^2 [Z_0(\chi r_1)]^2} \frac{\nu_{0m}^2}{(1 - \nu_{0m}^2)^{\frac{1}{2}}} \right\} \quad (9)$$

The first term in (9) is due to the currents induced in the two radial planes, partly by  $H_r$  and partly by  $H_z$ . This is the rising term. The second and third terms are due to currents induced by  $H_z$  in the radial planes and in the two cylindrical surfaces, respectively. If  $r_1$  tends to zero, or if both  $r_1$  and  $r_2$  become large, (9) assumes the forms appropriate to guides of sector or rectangular cross-sections. For  $\phi = 2\pi$ , the guide becomes a pair of coaxial cylinders with a single radial baffle plane (Fig. 12). As before, we make use of the notion of Riemann Space and extend the validity of our equations into regions for which the sector angle exceeds  $2\pi$ . And then with  $\phi$  increasing indefinitely, the first two terms of (9) again tend towards zero; and again the radial planes become ineffective and may be removed. On this view, then, a guide of two coaxial circular cylinders is an extreme case of a guide composed of portions of two coaxial cylinders and two radial planes, and the attenuation

constant is simply given by the third term in (9). This is the general case in which the attenuation approaches zero with increasing frequency.

In this, as in the special cases considered, the equations reveal that the anomalous falling off of the attenuation constant with frequency may be ascribed to the indefinite increase of one of the transverse dimensions of the guide, with the consequent disappearance of all terms that nor-

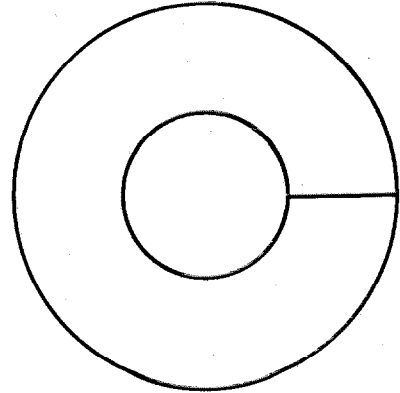

Fig. 12—Guide composed of two coaxial circular cylinders and a radial baffle plane.

mally account for the rise with frequency. Thus all surfaces at which lines of electric force begin or end are relegated to regions infinitely far apart from one another where their existence can no longer be of any practical consequence. In the rectangular case, the guide ceases thereby to be of finite height, but in the two circular cases, where the field is wrapped around an axis or around a circular cylinder, the guide retains a finite form and the field within it, so constrained, continues to display the properties characteristic of a field of infinite range.

# Exact Design and Analysis of Double- and Triple-Tuned Band-Pass Amplifiers\*

By MILTON DISHAL

*Federal Telecommunication Laboratories, Inc., Nutley, New Jersey*

**T**HE PURPOSE of this paper is to present a quick, complete, and exact method of design and analysis of double- and triple-tuned band-pass amplifiers.

The necessary small-percentage pass-band equations are derived giving the relationship between the circuit characteristics and the response characteristics. These circuit characteristics are: the resonant frequency  $f_0$ , coefficient of coupling  $K$ , the circuit  $Q$ , and the input and output capacitances  $C_{in}$  and  $C_{out}$ . The response characteristics are: the percentage bandwidth between peaks  $\Delta f_p/f_0$ , the peak-to-valley response ratio within the pass band  $V_p/V_v$ , the peak-to-"skirt" response ratio  $V_p/V$  at different skirt-to-peak bandwidth ratio points  $\Delta f/\Delta f_p$  outside the pass band, the circuit gain at the peaks, and the phase shift  $\theta$  at any frequency.

These design equations, extended to the case of one to eight cascaded stages, are incorporated in two sets of conveniently used nomographs, one set for the double-tuned circuits and one set for triple-tuned circuits. Specific examples of the use of these nomographs are given.

• • •

## 1. Symbols

$f_0$  = resonant frequency (see Section 5)

$\omega_0$  = resonant radian frequency

$n$  = decrement of a resonant circuit (see Section 4)

$Q$  = reciprocal of decrement (see Section 4)

$K_C$  = coefficient of capacitive coupling between resonant circuits (see Fig. 3)

$K_L$  = coefficient of inductive coupling between resonant circuits (see Fig. 3)

$K_M$  = coefficient of mutual inductive coupling between resonant circuits (see Fig. 3)

$K = [K_C(\omega/\omega_0) - K_L(\omega_0/\omega)]$

$C, L, M, R$  = capacitance (farads), inductance (henries), mutual inductance (henries), resistance (ohms)

$B$  = susceptance

$g$  = conductance

$F = (f/f_0 - f_0/f) = (\omega/\omega_0 - \omega_0/\omega)$

$\theta$  = phase angle between a resulting voltage and the driving current, or the phase angle between a resulting current and the driving voltage

$\Delta f$  = difference between two frequencies

$V$  = response voltage

$\beta$  = a constant for double-tuned circuits (a function of peak-to-valley ratio)

$N$  = number of cascaded stages

$\gamma$  = a constant for triple-tuned circuits (a function of peak-to-valley ratio)

$\Delta f_p$  = bandwidth between response peaks

$V_p$  = voltage at peaks of the response

$V_v$  = voltage at the valley of the response

$D = n_2/n_1 = Q_1/Q_2$

## 2. Introduction

To aid in the design and analysis of circuits which produce a band-pass response with respect to frequency, there has arisen a large body of literature<sup>1-4</sup> under the two general headings of filter theory and coupled-circuit theory.

However, it would be worthwhile to have collected in one place a method of design that will quickly and easily give answers to questions of the following type which might arise in the course of a thorough design of, say, a wide-band intermediate-frequency amplifier for receivers:

<sup>1</sup> E. S. Purinton, "Single and Coupled Circuit Systems," *Proceedings of the I.R.E.*, v. 18, pp. 983-1016; June, 1930.

<sup>2</sup> C. B. Aiken, "Two Mesh Tuned Coupled Circuit Filters," *Proceedings of the I.R.E.*, v. 25, pp. 230-272; February, 1937.

<sup>3</sup> F. X. Rettenmeyer, "Radio Bibliography—Filters," *Radio*, n. 273, pp. 26-30; October, 1942.

<sup>4</sup> T. E. Shea, "Transmission Networks and Wave Filters," D. Van Nostrand Company, Inc., New York, N. Y., 1929.

\* Reprinted from *Proceedings of the I.R.E.*, v. 35, pp. 606-626; June, 1947.

A. For a given bandwidth and "flatness" of response, exactly how much more gain can be obtained if we use triple-tuned rather than double-tuned circuits?

B. Can a certain skirt-selectivity specification be satisfied using only five double-tuned circuits? If so, what must the circuit constants be? What peak-to-valley ratio will there be in the pass band?

C. How much more gain and how much greater skirt selectivity will be obtained if we accept a relatively poor response in the pass band by allowing a 1.3 peak-to-valley ratio in preference to a good 1.05 peak-to-valley ratio? What must the circuit constants be for both cases?

D. Will more gain per stage be obtained if all the loading is done in one of the resonant circuits, or should the  $Q$  of all the resonant circuits be made equal?

In this paper, through the medium of two sets of three nomographs each, the writer hopes to provide in one place a ready means of obtaining exact answers (with a minimum of time and calculation) to the above and other questions for the case of double-tuned and triple-tuned band-pass circuits when small-percentage (20 percent or less) bandwidths are used.

The concepts and constants used are those commonly associated with coupled-circuit theory. Filter-theory constants and concepts are always useful, and when many tuned circuits are coupled together it is practically necessary to use the filter-theory type of design. However, for both double- and triple-tuned circuits, it is possible to obtain exact closed-form solutions for the circuit response (when band-pass percentages are approximately 20 percent or less); and these solutions are more concisely stated in terms of coupled-circuit constants.

The circuit constants used are the resonant frequency  $f_0$ , the  $Q$  of each resonant circuit used, and the coefficient of coupling  $K$  between resonant circuits. The response constants are the percentage bandwidth between peaks  $\Delta f_p/f_0$ , the peak-to-valley ratio  $V_p/V_v$  inside the pass band, (this fixes the goodness or "flatness" of the pass band); and the skirt bandwidths  $\Delta f/\Delta f_p$  at different skirt response points  $V_p/V$  (this fixes the sharpness of cutoff or the skirt selectivity outside the pass band), the circuit gain at the peaks, and the phase shift at any frequency.

The results of the double-tuned analysis (i.e., the nomographs and the family of phase-shift curves) will be given next with examples of their use.

### 3. Design and Analysis of Double-Tuned Circuits by Means of the Nomographs

From (19a),  $A_1$ ,  $C_1$ ,  $D_2$ , and  $E_1$  of this paper, a set of nomographs have been prepared, and a family of curves have been prepared from the phase-shift equation (26). The use of these nomographs is best explained by a few specific examples.

#### 3.1 EXAMPLE I

Knowing that the gain per stage is approximately

$$\text{Gain} = g_m/4\pi\Delta f_p\sqrt{C_1C_2}$$

and that  $C_1 \doteq C_2 \doteq 10$  micromicrofarads and  $g_m = 5 \times 10^{-3}$  mho, it is decided that five stages are probably needed to obtain a certain desired gain. A ratio of peak gain to valley gain of 1.10 will be satisfactory. A bandwidth between peaks  $\Delta f_p$  of 2 megacycles is required; and to make the percentage bandwidth approximately 20 percent or less, a midfrequency  $f_0$  of 30 megacycles is chosen.

What loading resistances should be used to give the proper  $Q$  in the two tuned circuits? What exact gain per stage will be obtained? What must the mutual impedance be to give the proper coefficient of coupling? What will the bandwidth be 6 decibels down from the peaks? What will the bandwidth be 60 decibels down from the peaks?

Starting with Chart A, place a straight edge between point 5 on the "Number of Cascaded Stages ( $N$ )" column and point 1.10 on the " $(V_p/V_v)$ " column. From the " $[Q/(f_0/\Delta f_p)]$ " column, we find that the  $Q$  of each resonant circuit must be

$$Q = 0.69 \frac{f_0}{\Delta f_p} \doteq 10,$$

and from this same column the gain per stage will be

$$\text{Gain} = 0.69 \frac{g_m}{4\pi\Delta f_p\sqrt{C_1C_2}} \doteq 14.$$

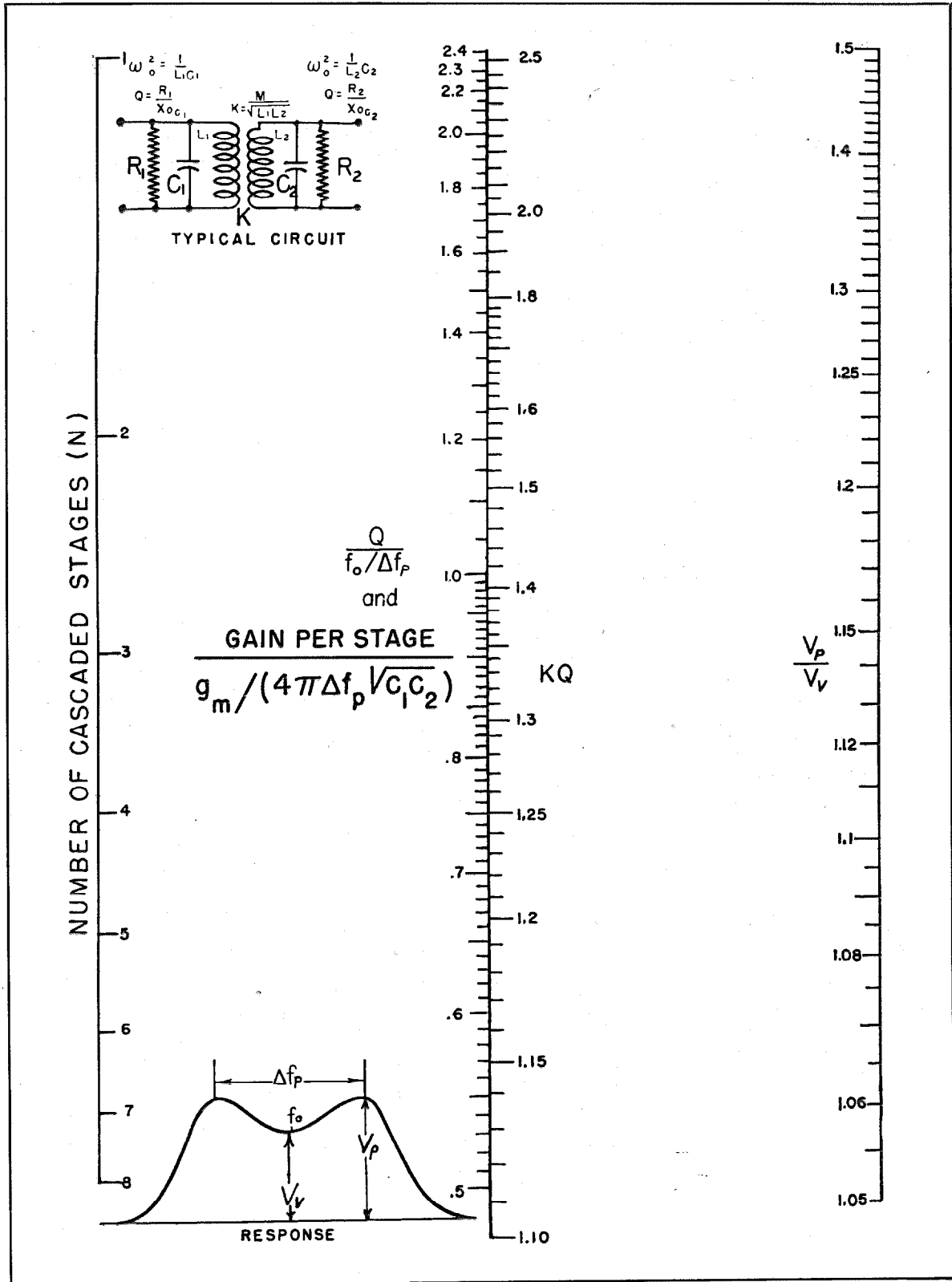

Chart A—Double-tuned band-pass circuit design.



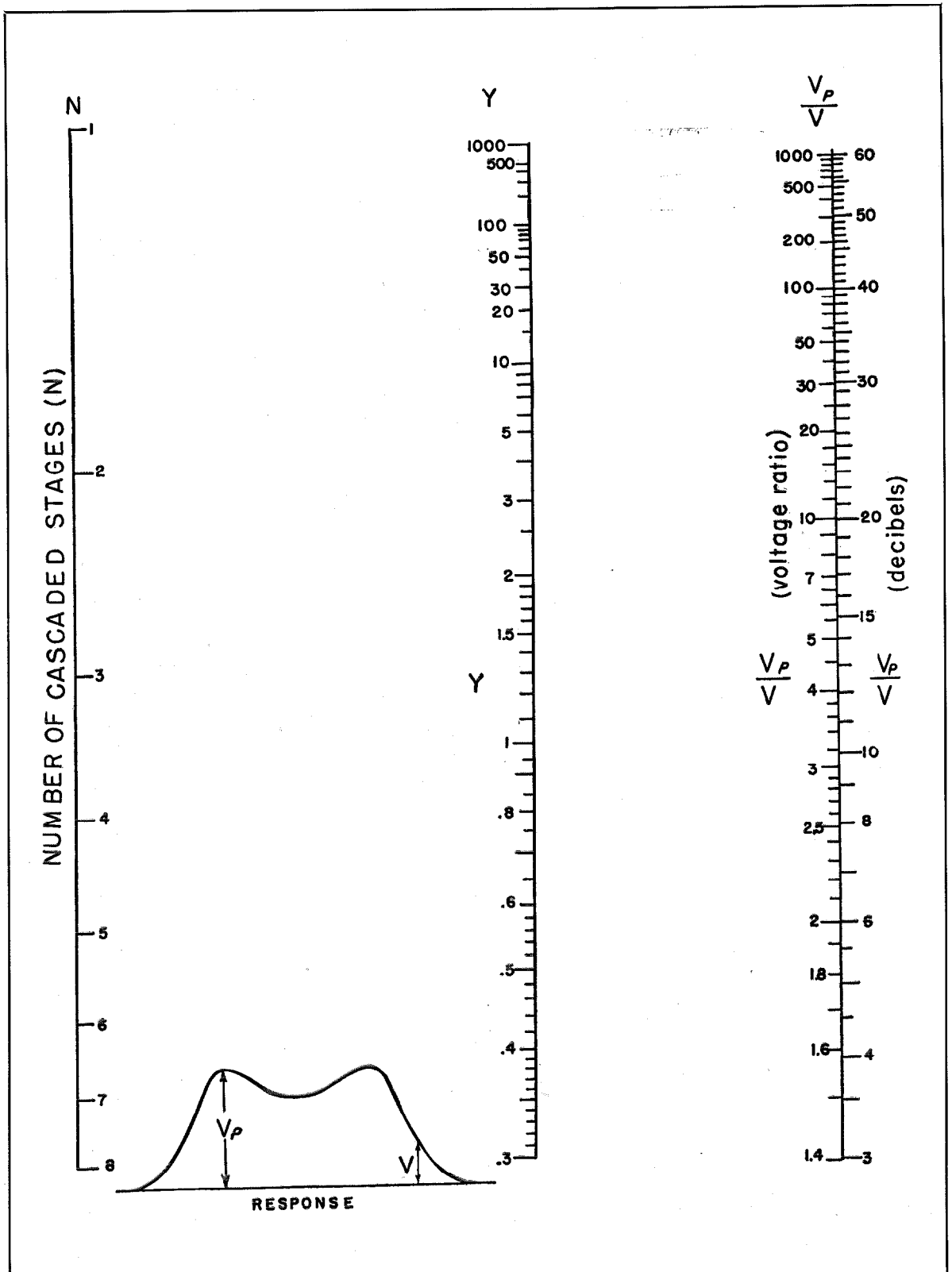

Chart B—Double-tuned band-pass circuit design.

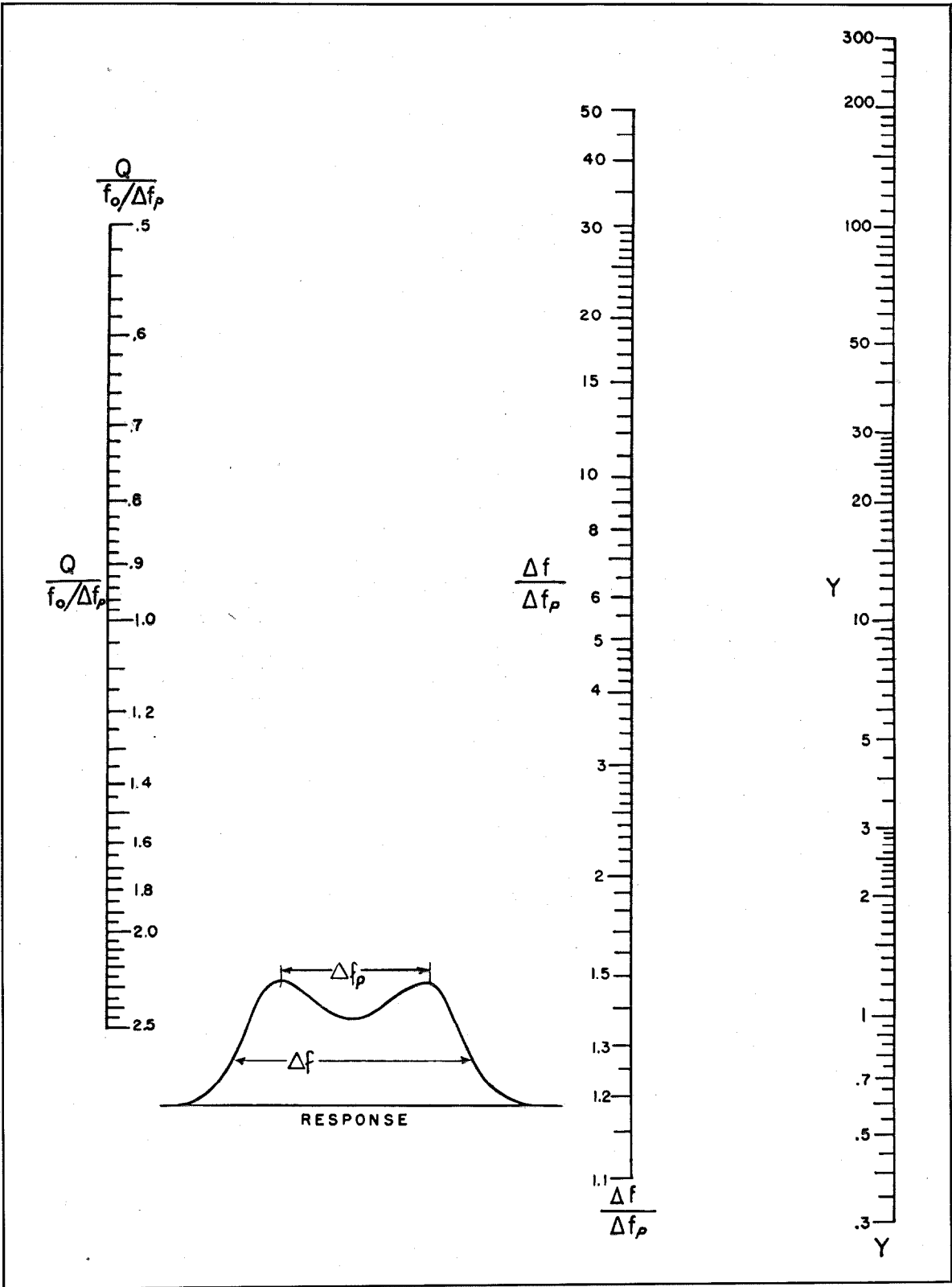

Chart C—Double-tuned band-pass circuit design.

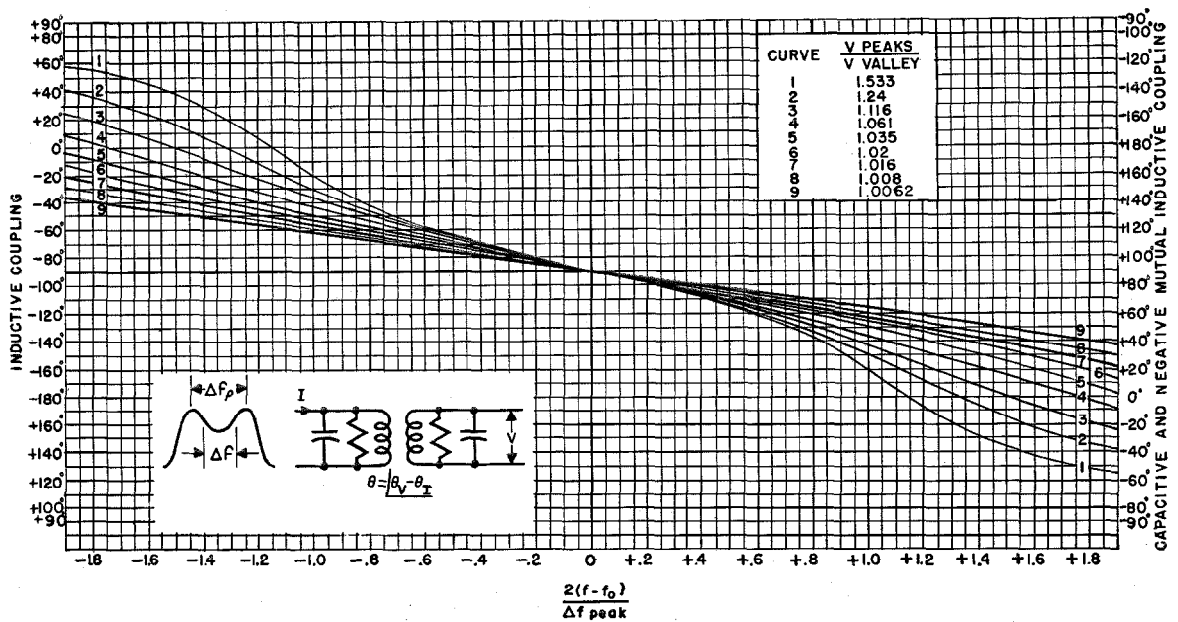

Chart D—Phase shift for a flat-top double-tuned circuit for different peak-to-valley ratios.

Knowing the necessary resonant-circuit  $Q$  and the reactance of the total shunt capacitances in the resonant circuits, the necessary resultant loading resistance is, of course, given simply by  $R = QX_{o_c} = 10 \times 500 = 5000$  ohms.

Since the coils used will usually have appreciable loss, they will effectively supply a shunt loading resistance of value  $Q_L X_{o_c}$  where  $Q_L$  is the  $Q$  of the inductance and  $X_{o_c}$  is the impedance of the shunt capacitance at the resonant frequency.

Thus, the resistance  $R_+$  which must be added in parallel with the above effective resistance, due to a  $Q_L$  of 50, for example, to produce the required resultant  $Q$  is

$$R_+ = \left[ Q / \left( 1 - \frac{Q}{Q_L} \right) \right] X_{o_c} \approx 6250 \text{ ohms.}$$

From the “ $KQ$ ” column of Chart A, the coefficient of coupling must be

$$K = \frac{1.22}{Q} = 0.122.$$

In the type of circuit chosen (see Figs. 1 and 2), the mutual reactance between the two resonant circuits is then found from the simple equation for the coefficient of coupling as given with each type of coupling in Fig. 3.

To consider skirt selectivity, use Charts B and C. On Chart B, place a straight edge between point 5 on the “Number of Cascaded Stages ( $N$ )” column, and 6 decibels (or 2) on the “( $V_p/V$ )” column. Read 0.56 on the middle, or “ $Y$ ” column. Now, going to Chart C, place the straight

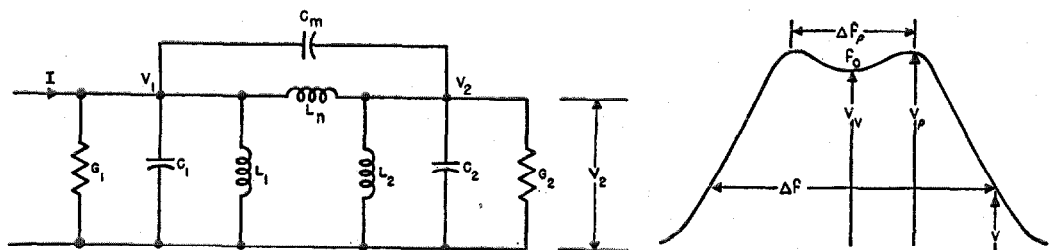

Fig. 1—Basic double-tuned two-node band-pass circuit using both inductive and capacitive coupling and the type of voltage response to be considered.

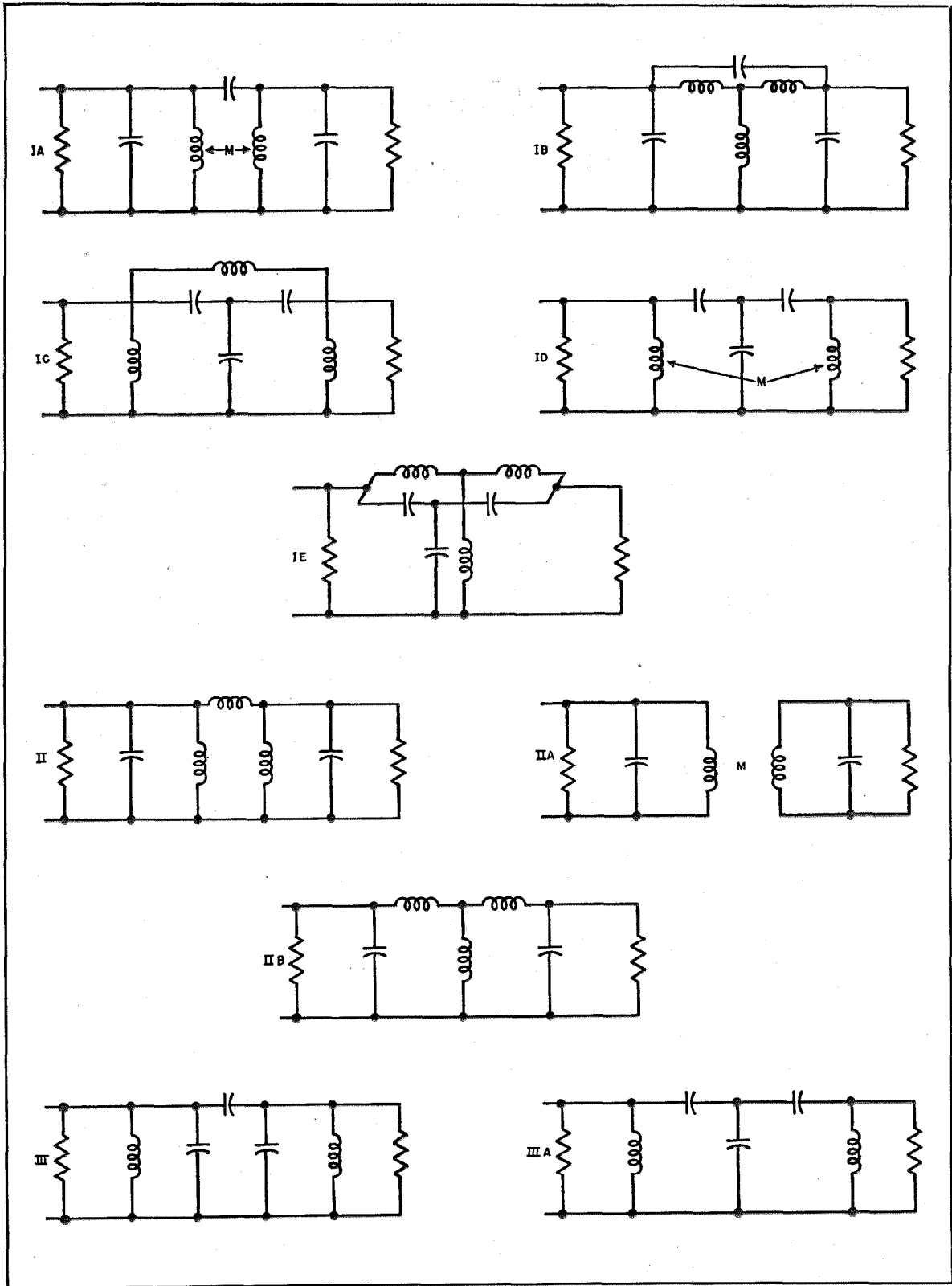

Fig. 2—Ten two-node circuits. The circuit of Fig. 1 is exactly equivalent to these circuits.

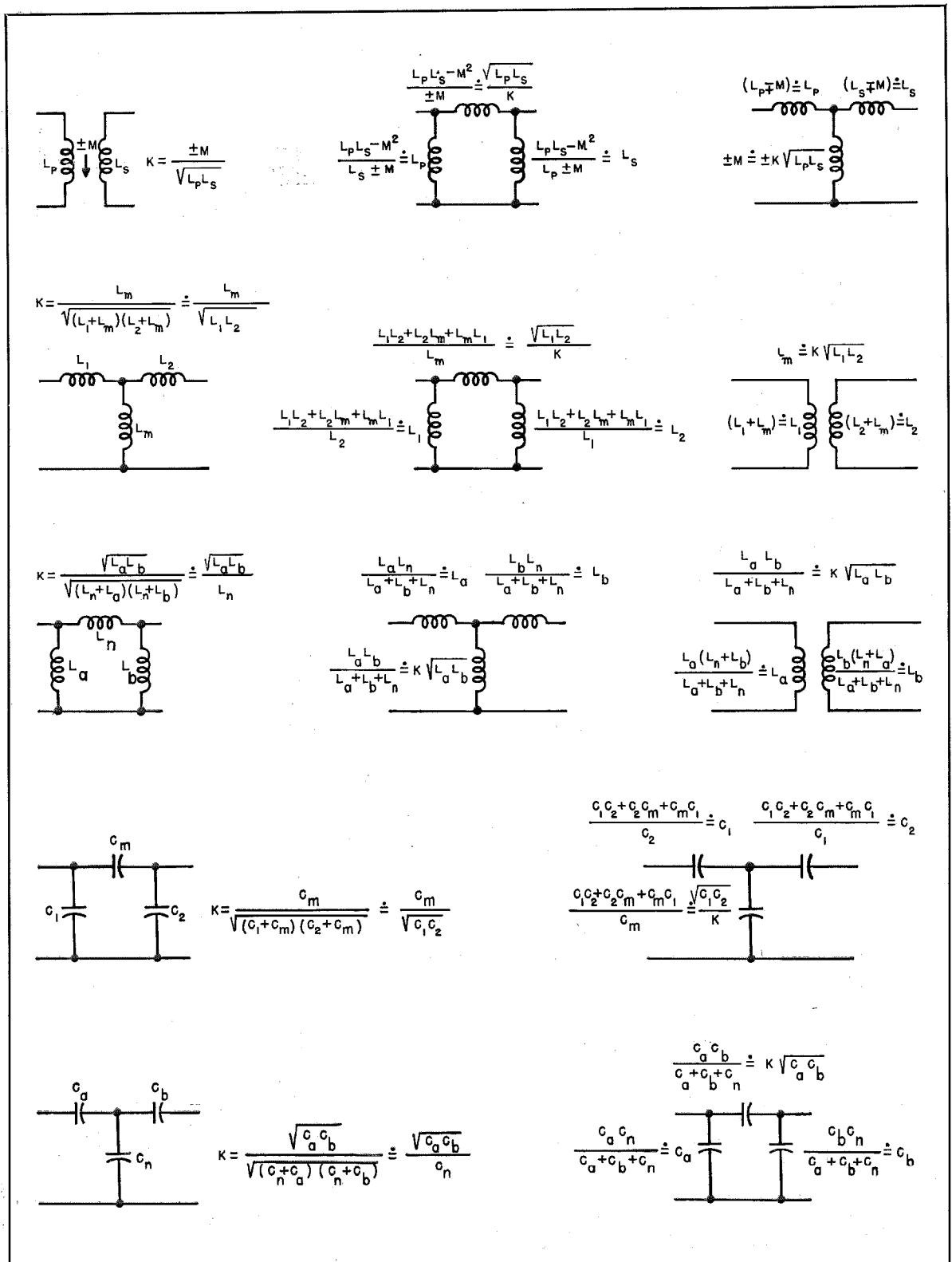

Fig. 3—Coefficient of coupling used in the analysis and the  $\pi$ , T, and transformer exact equivalents, and approximations for small couplings.

edge between 0.69 on the " $[Q/(f_0/\Delta f_p)]$ " column and 0.56 on the "Y" column and read from the middle column that

$$\Delta f_{60 \text{ decibels}} = 1.95 \Delta f_p = 3.9 \text{ megacycles.}$$

The bandwidth at the 60-decibels-down point is obtained in exactly the same way, i.e., on Chart B, place the straight edge between the point 5 on the "Number of Cascaded Stages ( $N$ )" column and 60 decibels (or 1000) on the " $(V_p/V)$ " column. Read 3.6 on the "Y" column. Going to Chart C, place the straight edge between point 0.69 on the " $[Q/(f_0/\Delta f_p)]$ " column and 3.6 on the "Y" column. Read from the " $[(\Delta f/\Delta f_p)]$ " column that

$$\Delta f_{60 \text{ decibels}} = 4.4 \Delta f_p = 8.8 \text{ megacycles.}$$

Any other points on the response curve are found in the same manner.

### 3.2 EXAMPLE II

Knowing that the approximate gain per stage is  $\text{Gain} = g_m / 4\pi \Delta f_p \sqrt{C_1 C_2}$ , it is decided that only 3 stages are needed to give a certain desired gain. It is necessary that the skirt selectivity be such that the bandwidth 60 decibels down be only 5 times the bandwidth between the peaks, i.e.,  $\Delta f_{60 \text{ decibels}} / \Delta f_p = 5$ . What must be the  $Q$  of each tuned circuit to obtain this skirt selectivity? What exact gain per stage will be obtained? What coefficient of coupling is required? What peak-to-valley ratio must be accepted to obtain this selectivity?

Starting with Chart B, place a straight edge between point 3 in the "Number of Cascaded Stages ( $N$ )" column and point 60 decibels on the " $(V_p/V)$ " column and read 9.6 from the "Y" column. Going to Chart C, place the straight edge between point 5 on the " $(\Delta f/\Delta f_p)$ " column and 9.6 on the "Y" column and read on the " $[Q/(f_0/\Delta f_p)]$ " column that the required  $Q$  is

$$Q = 1.1 \frac{f_0}{\Delta f_p}.$$

Now going to Chart A, place the straight edge between point 3 on the "Number of Cascaded Stages ( $N$ )" column and 1.1 on the " $[Q/(f_0/\Delta f_p)]$ " column. The exact gain will be

$$\text{Gain} = 1.1 \frac{g_m}{4\pi \Delta f_p \sqrt{C_1 C_2}}$$

and, from the " $KQ$ " column, the required coefficient of coupling is

$$K = \frac{1.48}{Q}.$$

From the " $(V_p/V_v)$ " column, the resulting peak-to-valley ratio will be

$$V_p/V_v = 1.27.$$

### 3.3 EXAMPLE III

The nomographs may be conveniently used for analysis of coupled circuits, as well as for design or synthesis.

Thus, given the  $Q$  of two resonant circuits as 20, the coefficient of coupling  $K$  between them as 0.085, and the resonant frequency as 15 megacycles, what is the response curve?

The product of  $KQ$  is 1.7. Going to Chart A, set the straight edge between 1 on the "Number of Cascaded Stages ( $N$ )" column and 1.7 on the " $KQ$ " column. From the " $(V_p/V_v)$ " column,  $V_p/V_v = 1.15$ . From the " $[Q/(f_0/\Delta f_p)]$ " column, the bandwidth between peaks will be

$$\Delta f_p = 1.38 \frac{f_0}{Q} = 1.04 \text{ megacycles.}$$

To find the width of the skirts at different points, e.g., 10 times or 20 decibels down, go to Chart B. Place the straight edge between 1 on the "Number of Cascaded Stages ( $N$ )" column and 20 decibels on the " $(V_p/V)$ " column and read 10 on the "Y" column. Going to Chart C, place the straight edge between 1.38 on the " $[Q/(f_0/\Delta f_p)]$ " column and 10 on the "Y" column and see that

$$\Delta f_{20 \text{ decibels}} = 4.4 \Delta f_p = 4.6 \text{ megacycles.}$$

Any other points on the skirts are obtained in the same way.

### 3.4 EXAMPLE IV

To find the phase shift at any point in the pass band, Chart D is used.

It should be noted that  $2(f - f_0)/\Delta f_p$  (which is the abscissa of the graph) is merely a way of writing  $(\Delta f/\Delta f_p)$  to show more clearly that in the phase-shift equation (26),  $\Delta f$  defines two frequencies equidistant from the resonant frequency. The abscissa is (+) for frequencies above the resonant frequency and is (-) for frequencies

below the resonant frequency. For example, at the high-frequency peak,  $f=f_{ph}$  and  $2(f-f_0)/\Delta f_p=+1$  and at the low-frequency peak,  $f=f_{pl}$  and  $2(f-f_0)/\Delta f_p=-1$ .

Note also that the ordinates give the phase shift *per stage*. If  $N$  cascaded identical stages are used, this phase shift is then multiplied by  $N$ .

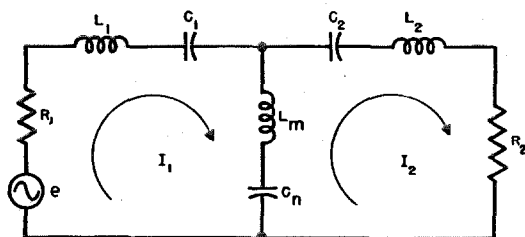
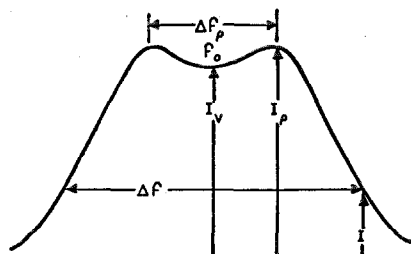

Fig. 4—Basic double-tuned two-mesh band-pass circuit (using both inductive and capacitive coupling) and the type of current response to be considered.

in Fig. 4, where  $I$ , the equivalent constant-current generator, and  $g$ ,  $C$ , and  $L$ , are substituted for by  $e$ ,  $R$ ,  $L$ , and  $C$ , respectively. Again, by virtue of the equivalence of  $\pi$ 's,  $T$ 's, and transformers, the analysis also applies to the ten additional circuits given in Fig. 5. Thus, a total of 22 band-pass circuits are effectively analyzed in this



Finally, note that the peak-to-valley ratios for each curve are the ratios for a single *stage*.

Thus, if 6 cascaded stages are being used to produce a resultant peak-to-valley ratio of 1.05, each single stage must have a peak-to-valley ratio equal to the 6th root of 1.05, or 1.0083. For this case, Curve 8 would therefore give the phase shift versus frequency per stage. This phase shift at each frequency is then multiplied by 6 to give the resultant phase-shift-versus-frequency curve.

#### 4. Circuits Which Are Analyzed

The basic circuit analyzed is the two-node network consisting of two resonant circuits coupled together both inductively and capacitively. This circuit and the response investigated are shown in Fig. 1.

By virtue of the exact equivalence of  $\pi$ 's,  $T$ 's, and transformers, the exact analysis of the basic circuit is immediately applicable to ten more circuits. These ten circuits are shown in Fig. 2 and the equations giving the values of the equivalent elements are given in Fig. 3. Lattice, bridged- $T$ , etc., equivalents may also be used.

By virtue of the concept of duality,<sup>5</sup> the analysis of the basic two-node network is immediately applicable to the dual two-mesh network given

paper, plus any lattice, bridged- $T$ , etc., equivalents which the reader may desire to use.

The two-node circuit of Fig. 1 is picked as the circuit to be analyzed, rather than the dual two-mesh circuit of Fig. 4, because vacuum-tube amplifiers are effectively high-impedance generators, and for practically all high-frequency band-pass amplifier applications, high-impedance resonance is desired as obtained by the use of the circuits of Figs. 1 and 2.

If very-small-percentage pass bands are to be produced, and very slight inequality in the height of the two peaks can be tolerated, then all 22 of the circuits shown in Figs. 1, 2, 4, and 5 can be used as either high- or low-impedance circuits by means of the following reasoning. For the small-percentage band-pass case, it is convenient (and correct) to consider the band-pass characteristic as being produced in the following manner:

A. Fundamentally, the configuration of only the lossless reactive components produces the band-pass response; the percentage bandwidth being fixed (to a first approximation) by the coefficient of coupling  $K$ . Figs. 1 and 2 and Figs. 4 and 5 give the two-node and the two-mesh reactive networks that can produce a band-pass characteristic. (Consider the shunt resistors of Figs. 1 and 2 to be open-circuited and the series resistors of Figs. 4 and 5 to be short-circuited.)

<sup>5</sup> Electrical Engineering Staff, Massachusetts Institute of Technology, "Electric Circuits," John Wiley and Sons, New York, N. Y., 1940, pp. 245-246.

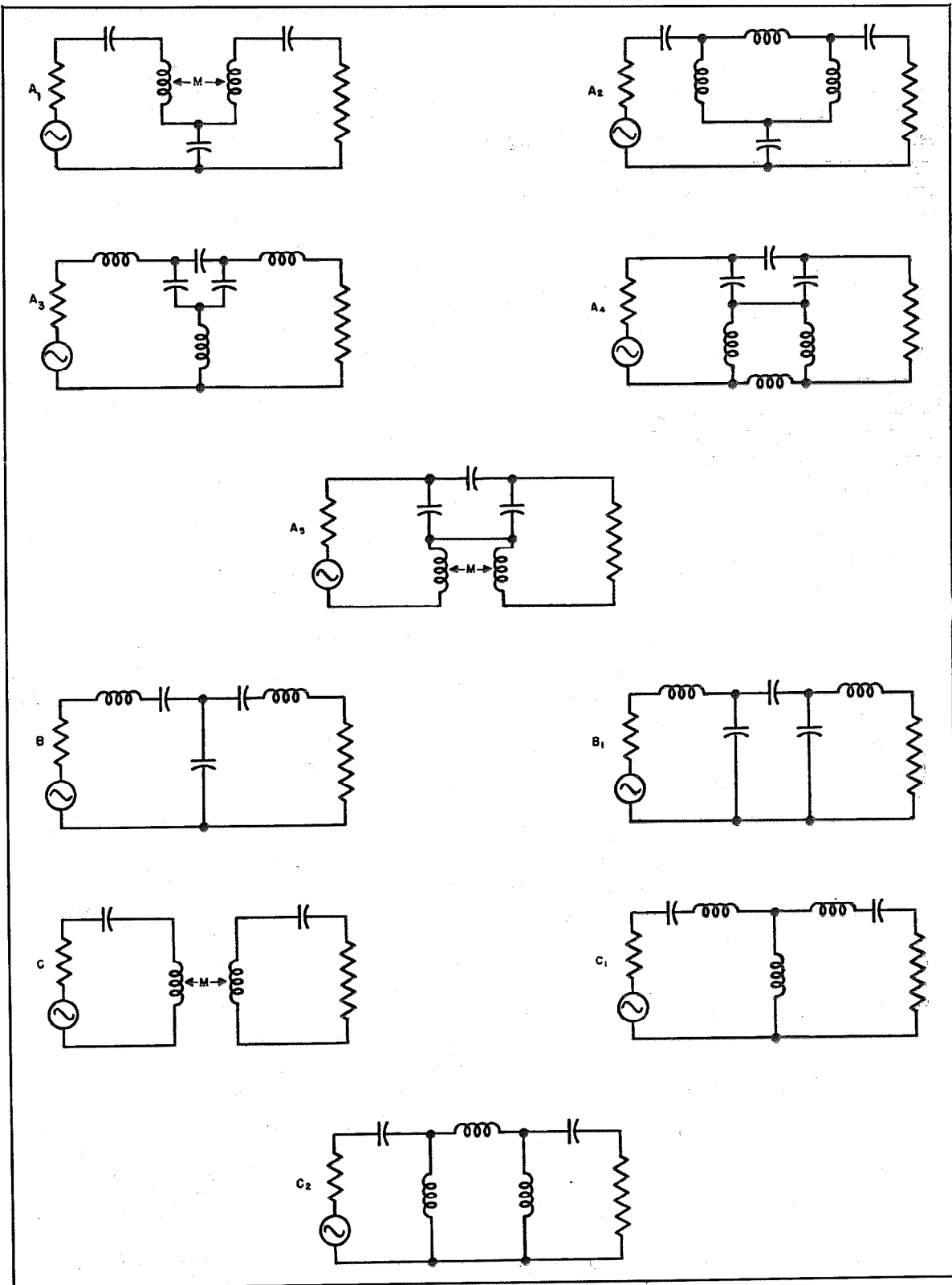

Fig. 5—Ten two-mesh circuits. The circuit of Fig. 4 is exactly equivalent to these circuits.



B. The peak-to-valley ratio is fixed to a first approximation by the required  $Q$  of the input and output resonant circuits. The correct resonant circuit  $Q$  can be produced in three ways: (1) by placing a small resistance in series with the resonant circuit,  $Q = X_{0c}/R_s$ ; (2) by placing a large resistance in parallel with the resonant circuit,  $Q = R_p/X_{0c}$ , or (3) by a combination of both series and parallel loading. For this case

$$Q = \frac{1}{(R_s/X_{0c}) + (X_{0c}/R_p)}$$

C. The driving force may be applied in two ways: either an infinite-impedance (i.e., zero conductance) constant-current generator may be placed in parallel with either the resonating inductance or the resonating capacitance (never across the mutual reactance); or a zero-impedance constant-voltage generator may be placed in series with either the resonating inductance or resonating capacitance (never in series with the mutual reactance).

In practice, all equivalent generators have finite output impedances associated with them. Thus, the above steps, *B* and *C*, are interrelated to the extent that the effect of the output impedance of the generator upon the resonant circuit  $Q$  must be considered.

D. The output voltage may be obtained across either the resonating inductance or the resonating capacitance in the output circuit. Of course, we must consider the effect of the resistive component of the load upon the  $Q$  of the output resonant circuit.

### 5. Elements Which Are Resonated

It is important to know exactly what elements are resonated in the above circuits. The elements which are tuned to resonance in circuit 1, Fig. 5, and all the two-node circuits are indicated by the following procedure: node 2 is shorted to ground and all the reactive elements remaining are resonated at the desired frequency; then node 1 is shorted to ground (the short on node 2 is removed) and all the remaining reactive elements are resonated to the above frequency. Thus, in circuit 1,  $C_1$  plus  $C_m$  is resonated with the re-

sultant of  $L_2$  and  $L_n$  in parallel. Thus, for Fig. 1, we have

$$\begin{aligned} \omega_0^2 &= \frac{1}{\left(\frac{L_1 L_n}{L_1 + L_n}\right)(C_1 + C_m)} \\ &= \frac{1}{\left(\frac{L_2 L_n}{L_2 + L_n}\right)(C_2 + C_m)} \end{aligned} \quad (1)$$

This method of defining the resonances also introduces a very practical method of aligning double- or triple-tuned coupled resonant circuits. *First*, completely detune all but one of the resonant circuits without affecting the mutual impedance. This detuning effectively short-circuits the node to ground for all practical purposes, and may be accomplished simply by placing an additional capacitance across the resonant circuits whose value is approximately three or four times that of the capacitance in the circuit. Or, if iron-slug tuning is used, sufficient detuning can usually be accomplished merely by turning the slug to its extreme position. *Second*, feed a signal into the circuit at the desired resonant frequency and tune the remaining circuit, which is not detuned, for maximum output. This procedure is then repeated until all the circuits have been resonated in the above manner.

Actually, for a certain distribution of the circuit constants, i.e.,  $Q_1 = Q_2$ , there is a more convenient method of alignment which will be mentioned later.

In the dual two-mesh circuits, the elements to be resonated are indicated by the following procedure: mesh 2 is open-circuited and all the reactances remaining in the circuit are resonated. Then, with mesh 2 returned to its normal condition, mesh 1 is open-circuited and all remaining reactive elements are resonated to the same frequency. Thus, for Fig. 4, we have:

$$\begin{aligned} \omega_0^2 &= \frac{1}{(L_1 + L_m)\left(\frac{C_1 C_n}{C_1 + C_n}\right)} \\ &= \frac{1}{(L_2 + L_m)\left(\frac{C_2 C_n}{C_2 + C_n}\right)} \end{aligned} \quad (2)$$

### 6. Exact Response Equations

The node equations for the circuit shown in Fig. 1 are:

$$\left. \begin{aligned} I &= [g_1 + j(B_{c_1} + B_{c_m} - B_{L_1} - B_{L_n})V_1 \\ &\quad - j(B_{c_m} - B_{L_n})V_2] \\ 0 &= -j(B_{c_m} - B_{L_n})V_1 \\ &\quad + [g_2 + j(B_{c_2} + B_{c_m} - B_{L_2} - B_{L_n})]V_2 \end{aligned} \right\} \quad (3)$$

As mentioned in Section 4, the solution of the above two equations for the response voltage  $V_2$  contains the solution for all 22 circuits shown in Figs. 1, 2, 4, and 5.

A great simplification is produced in the resulting equations for the circuits if the resonant frequency  $f_0$ , the coefficient of coupling  $K$  between resonant circuits, and the decrement of each resonant circuit  $n$  are introduced into the circuit equations. (The decrement is the reciprocal of the more commonly used  $Q$ .)

With the introduction of these constants, the equations can be expressed in terms of the three quantities only instead of in terms of the eight  $L$ ,  $C$ , and  $R$  elements making up the circuit. Our mental picture of the circuit action is thus greatly simplified.

By solving (3) for the output voltage  $V_2$  and introducing into the solution the three constants mentioned above, namely,

$$\begin{aligned} \omega_0^2 &= \frac{1}{\left(\frac{L_1 L_n}{L_1 + L_n}\right)(C_1 + C_m)} \\ &= \frac{1}{\left(\frac{L_2 L_n}{L_2 + L_n}\right)(C_2 + C_m)} \end{aligned} \quad (4)$$

$$n_1 = \frac{g_1}{\omega_0(C_1 + C_m)} \quad (5)$$

$$n_2 = \frac{g_2}{\omega_0(C_2 + C_m)} \quad (6)$$

$$K_C = \frac{C_m}{\sqrt{(C_1 + C_m)(C_2 + C_m)}} \quad (7)$$

$$K_L = \frac{\sqrt{L_1 L_2}}{\sqrt{(L_1 + L_n)(L_2 + L_n)}}, \quad (8)$$

we obtain as the exact solution for the magnitude of the response

$$V_2 = \frac{I}{\omega_0 \sqrt{(C_1 + C_m)(C_2 + C_m)}} \times \frac{K}{\sqrt{F^4 - 2 \left[ K^2 - \frac{n_1^2 + n_2^2}{2} \right] F^2 + (K^2 + n_1 n_2)^2}} \quad (9)$$

and the phase of the output voltage with respect to the constant current source is

$$\tan \theta = \frac{\pm [K^2 + n_1 n_2 - F^2]}{\pm [(n_1 + n_2)F]} \quad (10)$$

where

$$K = \left( K_C \frac{\omega}{\omega_0} - K_L \frac{\omega_0}{\omega} \right) \quad (11)$$

$$F = \left( \frac{\omega}{\omega_0} - \frac{\omega_0}{\omega} \right). \quad (12)$$

The sign to be used in the phase-shift equation (10), is the sign of the quantity

$$\left( K_C \frac{\omega}{\omega_0} - K_L \frac{\omega_0}{\omega} \right).$$

Thus, with capacitive coupling predominant, the top signs are used in numerator and denominator, and, with positive inductive coupling predominant, the bottom signs are used.

Examination of the numerator of (9) shows immediately one characteristic of the response. The numerator becomes zero and thus there is a null response at:

$$\frac{\omega_{\text{null}}}{\omega_0} = \sqrt{\frac{K_L}{K_C}}. \quad (13)$$

With reference to circuit IC of Fig. 2, it should be mentioned that if the winding sense of the inductances is such that the mutual inductive coupling "aids" the capacitive coupling there is no null of response, for then the sign of  $K_L$  in (11) is negative (-) and, therefore, the numerator never becomes zero.

We will now introduce into the above exact equations the approximations that produce the symmetrical and relatively simple small-percent-age pass-band analysis.

### 7. Small-Percentage Pass-Band Response Shape

Because  $K$  in (9) is a function of frequency, the exact response shape is not symmetrical either geometrically or arithmetically with respect to frequency. If, however, we limit ourselves to small-percentage pass bands where  $\omega/\omega_0$  varies in value over the small range from, say, 0.9 to 1.1 then two important simplifications immediately result in the factors shown in (11) and (12).

Equation (11) becomes independent of frequency:

$$K \doteq (K_C - K_L). \quad (11a)$$

(It must be realized that this approximation cannot be used in the region of the null given by (13).)

Equation (12) becomes

$$F = \left( \frac{\omega}{\omega_0} - \frac{\omega_0}{\omega} \right) = \frac{(\omega + \omega_0)}{2\omega} \times \frac{2(\omega - \omega_0)}{\omega_0} \\ \doteq \frac{2(\omega - \omega_0)}{\omega_0} \doteq \frac{\Delta f}{f_0}, \quad (12a)$$

where  $\Delta f$  is the frequency bandwidth between points equidistant from the resonant frequency  $f_0$ .

With the above limitation, (9) shows that in the small-percentage pass-band case (where (11a) applies) the shape of the amplitude response curve is independent of the type of coupling used. The gain obtained with inductive coupling only is slightly greater than that obtained with capacitive coupling, for, as seen from (9), the capacitances that must be considered in figuring the gain are  $(C_1 + C_m)$  and  $(C_2 + C_m)$ .  $C_m$  is the equivalent high-side capacitances of Fig. 5 and is zero for inductive coupling only.

The phase shift as given by (10) does differ for the two types of coupling. Since the top signs are used with capacitive coupling and the bottom signs with inductive coupling, we will have positive phase angles with capacitive coupling and negative phase angles with inductive coupling.

The frequency at which the response maximum and minimum occurs is given by differentiating (9) with respect to  $F$  (i.e.,  $\Delta f/f_0$ ) and equating to zero. This results in

$$\left( \frac{\Delta f}{f_0} \right)^2 = K^2 - \frac{n_1^2 + n_2^2}{2}, \quad (14)$$

and the location of the minimum is given by  $\Delta f_v/f_0 = 0$ .

The response at the peaks, obtained by substituting (14) in (9), is

$$V_{\text{peaks}} = \frac{I}{\omega_0 \sqrt{(C_1 + C_m)(C_2 + C_m)}} \\ \times \frac{K}{\sqrt{K^2(n_1 + n_2)^2 + n_1^2 n_2^2 - \left( \frac{n_1^2 + n_2^2}{2} \right)^2}}. \quad (15)$$

The response at the minimum or valley, which is at the resonant frequency, is obtained from (9) by setting  $\Delta f/f_0 = 0$  and is

$$V_v = \frac{I}{\omega_0 \sqrt{(C_1 + C_m)(C_2 + C_m)}} \frac{K}{K^2 + n_1 n_2}. \quad (16)$$

The peak-to-valley ratio is, therefore,

$$\left( \frac{V_p}{V_v} \right) = \frac{K^2 + n_1 n_2}{\sqrt{K^2(n_1 + n_2)^2 + n_1^2 n_2^2 - \left( \frac{n_1^2 + n_2^2}{2} \right)^2}}. \quad (17)$$

What we desire, so far as design is concerned, is the values of the decrement  $n$  (or  $Q$ ) and the coefficient of coupling  $K$  required to give a certain peak-to-valley ratio. By combining (14) and (17), we obtain

$$\frac{n_1 + n_2}{2} = \beta \left( \frac{\Delta f_p}{f_0} \right), \quad (18)$$

where

$$\beta = \sqrt{\frac{1}{2} \left[ \frac{(V_p/V_v)_1}{\sqrt{(V_p/V_v)_1^2 - 1}} - 1 \right]}, \quad (19)$$

and where the subscript 1 is to show that this is the peak-to-valley ratio of one double-tuned stage. Equation (18) is one of the desired design equations and shows that the required average of the decrements of the primary and secondary is fixed only by the peak-to-valley ratio desired and the percentage bandwidth.

The smaller we desire the peak-to-valley ratio to be (thus the flatter the response is in the pass band) the larger  $\beta$  becomes and, therefore, the greater must be the average decrement, i.e., the lower must be the  $Q$ . From (19), we find that  $\beta$  varies between the values of 1.75 to 0.42 as the peak-to-valley ratio varies, respectively, between the values of 1.01 to 1.50.

Now, making use of equations (14) and (18), we obtain for the required coefficient of coupling

$$K = \frac{\Delta f_p}{f_0} \sqrt{1 + \beta^2} \frac{2(1+D^2)}{(1+D)^2} \quad (20)$$

where  $\beta$  is given by (22) and  $D$  is the ratio of the primary  $Q$  to the secondary  $Q$ .

$$D = \frac{n_2}{n_1} = \frac{Q_1}{Q_2}$$

Thus, we see that the coefficient of coupling required is fixed mainly by the percentage band pass desired and is also dependent (not to a great extent, however) on the ratio  $D$  of primary  $Q$  to secondary  $Q$ . Equation (20) is the second of our desired design equations.

Dividing equation (20) by equation (18), we obtain

$$\frac{K}{(n_1+n_2)/2} = \sqrt{\frac{2(1+D^2)}{(1+D)^2} + \frac{1}{\beta^2}} \quad (21)$$

This is a very useful equation because it does not involve frequency. It shows that as soon as the peak-to-valley ratio (i.e.,  $\beta$ ) and the  $Q$  ratio are fixed, then the ratio of the coefficient of coupling  $K$  and the average decrement  $(n_1+n_2)/2$  is also fixed, and conversely for a given circuit where the  $Q$  ratio and the ratio of the coefficient of coupling and the average decrement is fixed, the peak-to-valley ratio is fixed. It should be understood that the  $Q$  ratio  $D$  has an almost second-order effect; for the quantity  $2(1+D^2)/(1+D)^2$  is equal to unity when the  $Q$  ratio is unity, and approaches a maximum value of two when the  $Q$  ratio approaches either zero or infinity.

The next design equation desired is one that will give the output voltage or the gain of the circuit at the peaks of the response. By substituting the design conditions given by (18) and (20) in the equation giving the response at the peaks, which is (15), we obtain

$$V_p = \frac{1}{\beta} \times \frac{I}{4\pi\Delta f_p \sqrt{(C_1+C_m)(C_2+C_m)}} \times \sqrt{\frac{1 + \frac{2(1+D^2)}{(1+D)^2} \beta^2}{1 + \beta^2}} \quad (22)$$

and for the usual case, where the constant-current generator of value  $I$  is a vacuum tube,

$I = g_m E_g$ , and we have

$$\text{Gain}_{(\text{per stage})} = \frac{1}{\beta} \times \frac{g_m}{4\pi\Delta f_p \sqrt{(C_1+C_m)(C_2+C_m)}} \times \sqrt{\frac{1 + \frac{2(1+D^2)}{(1+D)^2} \beta^2}{1 + \beta^2}} \quad (23)$$

Design equation (23) brings out several points of interest with reference to the gain obtained with "flat-topped" band-pass circuits. We see that the gain depends directly on the  $g_m$  of the tube used and inversely on the *numerical* bandwidth desired between peaks  $\Delta f_p$ . The midfrequency has no effect on the gain (as long as the bandwidth  $\Delta f_p$  is a small percentage of the midfrequency  $f_0$ ). The gain is also inversely proportional to the square root of the product of the total capacitance across the input or output circuits that must be resonated. We see also that the gain is inversely proportional to the factor  $\beta$  which is given by (19) and which is a measure of the flatness of response in the flat-top pass band. The flatter the pass band, the lower the gain obtainable. Finally, the gain depends on the square root of a quantity involving the ratio of primary  $Q$  to secondary  $Q$ .

This square root has only an almost second-order effect on the gain. It is interesting, however, to see the effect of this  $Q$  ratio on the gain. If  $Q_1$  equals  $Q_2$ , the factor under discussion becomes unity. If  $Q_2$  is made infinite and all the loading is done on the primary side, we obtain

$$\sqrt{\frac{1+2\beta^2}{1+\beta^2}}$$

and, if  $Q_1$  is made infinite and all the loading is done on the secondary side, we again obtain

$$\sqrt{\frac{1+2\beta^2}{1+\beta^2}}$$

In most practical designs,  $\beta$  will have a value close to unity; therefore, if all loading is done on one side of the band-pass circuit, approximately 25 percent more gain per stage will be obtained, as compared to the case where the primary and secondary are equally loaded (i.e.,  $Q_1=Q_2$ ).

It may be mentioned here that practical considerations dealing with ease of circuit alignment, and "Miller effect" detuning, lead to the

conclusion that in many cases it is better to make  $Q_1=Q_2$  and thus sacrifice the above 25 percent additional gain per stage. These points will be discussed later.

The next desired design equation is concerned with the shape of the circuit response outside the pass band, i.e., the skirt selectivity. By combining (9), giving the response at any frequency, and (15), giving the response at the peaks, and (18) and (20), giving the required circuit constants, we obtain for the ratio of peak response  $V_p$  to the response  $V$ , at any bandwidth  $\Delta f$ ,

$$\left(\frac{V_p}{V}\right)_1 = \sqrt{1 + \left[ \frac{(\Delta f / \Delta f_p)^2 - 1}{2\beta\sqrt{1+\beta^2}} \right]^2} \quad (24)$$

and solving (24) for  $\Delta f / \Delta f_p$ , we obtain

$$\frac{\Delta f}{\Delta f_p} = \sqrt{1 \pm 2\beta\sqrt{1+\beta^2}\sqrt{(V_p/V)_1^2 - 1}}, \quad (25)$$

where the subscript 1 is to show that the ratios are the voltage ratios for *one* double-tuned stage.

This is the last of our desired design equations and we see that the larger  $\beta$  is made (therefore, the flatter the response inside the pass band) the wider are the skirts at any skirt-response point, i.e., skirt selectivity becomes poorer as the pass-band response is improved. It should be noted from (24) or (25) that, for a given peak-to-valley ratio (i.e., a given  $\beta$ ), the shape of the response curve is independent of the ratio of primary  $Q$  to secondary  $Q$ .

The plus-or-minus sign in (25) should also be noted. When the plus sign is used, we obtain the skirt bandwidths outside the response peaks, and when the minus sign is used, we obtain the bandwidths inside the peaks of the response curve.

To make analysis as complete as possible, the phase of the response voltage with respect to the driving current should also be given. By combining (10) for the phase shift with design equations (18) and (20), we obtain

$$\tan \theta_{\text{per stage}} = \frac{\pm[1 + 2\beta^2 - (\Delta f / \Delta f_p)^2]}{\pm[2\beta(\pm \Delta f / \Delta f_p)]} \quad (26)$$

In (26) the top sign is used in front of the numerator and denominator when  $(K_C - K_L)$  is plus, i.e., with a net capacitive coupling. (It should be remembered that these equations should not be applied to the region in the vicinity of the null given by (13).) The plus sign is used

inside the bracket in the denominator for the frequencies above the resonant frequency and the minus sign is used for the frequencies below the resonant frequency.

From (26) we can see that for *inductive* coupling the phase shift at the midfrequency (i.e.,  $\Delta f=0$ ) is  $-90$  degrees; at the low-frequency peak, the tangent of the phase angle is  $(-/+)\beta$ ; and at the high-frequency peak, the tangent of the phase angle is  $(-/-)\beta$ . Since in many applications satisfactory flatness in the pass band is given when  $\beta$  is approximately unity, we see that the phase shift at the low-frequency peak is usually approximately  $-45$  degrees and the high-frequency peak usually has a phase angle of approximately  $-135$  degrees.

With *capacitive* coupling, we see that the phase shift at the midfrequency is  $+90$  degrees; the tangent of the phase angle at the low-frequency peak is  $(+/-)\beta$ ; the tangent of the phase angle at the high-frequency peak is  $(+/+)\beta$ ; and for  $\beta$  equal approximately to unity the phase shift at the low-frequency peak is thus approximately  $+135$  degrees, and at the high-frequency peak it is approximately  $+45$  degrees.

It should be noted that for a given peak-to-valley ratio (i.e., a given  $\beta$ ), the phase shift is independent of the  $Q$  ratio.

### 8. Small-Percentage Pass-Band Design Equations When $Q_1=Q_2$

Design equations having even a small degree of complexity are, in many cases, not used by engineers. However, conveniently used graphical representations of the complex equations will usually be put to use.

Usually, identical band-pass circuits are cascaded to produce intermediate-frequency-amplifier chains. Various applications may necessitate the use of from one to, perhaps, eight cascaded stages. It would appear worthwhile to develop an exact, rapid, graphical method of designing cascaded circuits so that they produce a specified response shape.

Since the number of cascaded stages used must be one of the design parameters, consideration of (18), (20), (21), (22), (25), and (26) shows that some form of family-of-curves representation or its equivalent is necessary. We further note that (20) and (22) are complicated by the relatively second-order effect of the  $Q$  ratio which would

necessitate an almost useless family of curves. Because of this complication, we will consider the case where  $Q_1=Q_2$ , in the graphical method of design; and the equations themselves can be used directly when  $Q_1$  does not equal  $Q_2$ .

There are two important practical reasons why a design using  $Q_1=Q_2$  should be used whenever possible. The first reason is concerned with the problem of aligning cascaded flat-topped band-pass circuits. The second reason is concerned with the detuning effect caused by the fact that the input and output capacitances of a pentode change with gain-control setting due to plate-to-grid capacitance feedback (Miller effect) and space-charge effects.

With reference to the alignment of cascaded flat-topped circuits, if  $Q_1$  is made equal to  $Q_2$  the circuits can be aligned just as single-peaked or single-tuned circuits are aligned, i.e., by using a single-frequency signal generator (not a "sweeper"), and tuning for absolute maximum output. With double-peaked circuits, the signal generator is set at the frequency at which the *low* peak of the response is desired and all the circuits are tuned *lower* in frequency for maximum response. (Or the signal generator may be set at the frequency at which it is desired to have the *high*-frequency peak, and all the circuits are then tuned *higher* in frequency for maximum response.) It can be shown that if  $Q_1$  equals  $Q_2$ , equal absolute maxima of response are obtained at the peaks only when both circuits are tuned to the same resonant frequency (as described in Section 4) and, conversely, when both circuits are tuned to the same resonant frequency, absolute maximum (and equal) response is obtained at both peaks (so long as there is no loss in the mutual reactance). This fact is the basis of the method of alignment just described.

When  $Q_1$  does not equal  $Q_2$ , tuning of the circuits to produce an absolute maximum of response at one frequency would necessitate the two circuits being tuned to different resonant frequencies and the two peaks are then of different amplitudes.

With reference to the second reason for making  $Q_1$  equal to  $Q_2$ , it is desirable to have a response curve which is not affected when the gain (i.e., the  $g_m$ ) of the amplifier tubes is changed. Unfortunately, the changes in input and output capacitances of a pentode, with changing  $g_m$  (due to

plate-to-grid capacitance feedback and space-charge effects), detunes the resonant circuits. However, it can be shown that, with  $Q_1=Q_2$ , a slight detuning of the resonant circuits will have practically negligible effect on the *symmetry* of the response curve. Thus, although the response curve as a whole will move slightly as the gain control is changed, the shape of the curve will remain sensibly constant when  $Q_1=Q_2$ .

When circuits are cascaded, the voltage responses at a given frequency are multiplied together to give the resultant voltage response. When the cascaded circuits are all identical, it is obvious that to obtain the resultant voltage response, the voltage response of one circuit is raised to that power given by the number of cascaded circuits.

We must realize that all the voltage responses in the previous equations apply to only one double-tuned stage. If we are going to cascade  $N$  stages and want a certain resultant peak-to-valley ratio  $V_p/V_v$ , the peak-to-valley ratio of each circuit  $(V_p/V_v)_1$ , must equal  $(V_p/V_v)^{1/N}$ . Likewise, if the resultant skirt-response ratio for  $N$  cascaded stages is to be  $V_p/V$ , then the skirt-response ratio for each stage  $(V_p/V)_1$ , must equal  $(V_p/V)^{1/N}$ .

Thus, in (19) and (25), which apply to one stage only, we should make the above substitutions to make them apply to  $N$  cascaded stages.

For the case of  $Q_1=Q_2$ , the design equations then become as follows:

Let

$$\beta = \sqrt{\frac{1}{2} \left[ \frac{(V_p/V_v)^{1/N}}{\sqrt{(V_p/V_v)^{2/N} - 1}} - 1 \right]}. \quad (19a)$$

Then

$$\frac{Q}{f_0/\Delta f_p} = \frac{1}{\beta} \quad (18a)$$

$$KQ = \sqrt{1 + 1/\beta^2} \quad (21a)$$

$$\left(\frac{V_p}{V}\right) = \left\{ 1 + \left[ \frac{(\Delta f/\Delta f_p)^2 - 1}{2\beta\sqrt{1 + \beta^2}} \right]^2 \right\}^{N/2} \quad (24)$$

$$\frac{\text{Gain per stage}}{g_m/4\pi\Delta f_p\sqrt{(C_1 + C_m)(C_2 + C_m)}} = \frac{1}{\beta} \quad (23a)$$

$$\frac{\Delta f}{\Delta f_p} = \sqrt{1 \pm 2\beta\sqrt{1 + \beta^2}\sqrt{(V_p/V)^{2/N} - 1}} \quad (25a)$$

$$\tan \theta_{\text{per stage}} = \frac{\pm [1 + 2\beta^2 - (\Delta f/\Delta f_p)^2]}{\pm [2\beta(\pm \Delta f/\Delta f_p)]}. \quad (26)$$

### 9. Formation of Triple-Tuned Band-Pass Circuits<sup>6,7</sup>

Any two of the circuit configurations shown in Figs. 1 and 2 may be connected in series to form a triple-tuned three-node band-pass circuit. (This also means, of course, that one of the circuits shown can be used twice.) Similarly, the circuit configurations of Figs. 4 and 5 can be used to form three-mesh band-pass circuits.

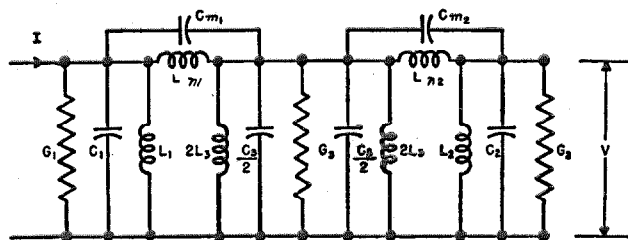

Fig. 6—Basic triple-tuned three-node band-pass circuit using both inductive and capacitive coupling and the type of voltage response to be considered.

With respect to the calculation of the two equal coefficients of coupling which appear in the resulting triple-tuned circuit, maximum gain will be obtained if the following procedure is used: the middle resonant circuit formed when two of the node networks of Figs. 1 and 2 are connected in series should be considered to be formed from two identical resonant circuits in parallel (i.e., each one having twice the net inductance and one half the net capacitance). The input resonant circuit is then coupled to one of the above resonant circuits and the output circuit is coupled to the other resonant circuit.

The middle resonant circuit formed when two of the mesh circuits of Figs. 4 and 5 are connected in series should be considered to be formed from two identical resonant circuits in series (i.e., each one having twice the net capacitance and half the net inductance). The input resonant circuit is then coupled to one of the above resonant circuits and the output circuit is coupled to the other resonant circuit.

<sup>6</sup> E. A. Guillemin, "Communication Networks," John Wiley and Sons, New York, N. Y., v. 1, 1931; pp. 335-339. This analysis deals with the rather unfortunate case (in so far as good band-pass response is concerned) of  $Q_1 = Q_2 = Q_3$ .

<sup>7</sup> M. R. Winkler, "A 3 Resonant Circuit Transformer," *Electronics*, v. 16, pp. 96-100; January, 1943. Here again the main emphasis is placed on the case of  $Q_1 = Q_2 = Q_3$ .

The points made in Sections 4 and 5 of the double-tuned analysis apply also to the triple-tuned case, and, rather than repeat them here, it will be assumed that the reader will again refer to the above sections.

To obtain a flat-topped response with three peaks of equal amplitude in the pass band, all the loading must be removed from the middle tuned circuit, which is formed when two double-tuned circuits are thus connected in series. Other-

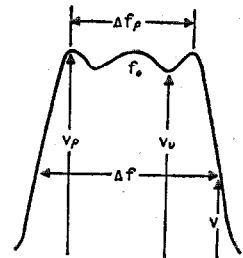

wise, as will be shown later, the outer two peaks of the response will be lower in amplitude than the middle peak.

Unfortunately, it is often impossible to obtain inductances of sufficient  $Q$  for the middle tuned circuit unless extremely large coil forms and shield cans are used. It will be shown that the required  $Q$  for the input and output tuned circuits is of the order of the value of the reciprocal of the percentage bandwidth. Thus, if a bandwidth between peaks of 400 kilocycles is desired with a midfrequency of 20 megacycles, the required  $Q$  of the input and output circuit will be approximately 50. To approach the ideal triple-tuned response curve, the  $Q$  of the middle tuned circuit must be of the order of 10 times (or more) the  $Q$  of the input and output circuits. Thus, a  $Q$  of the order of 500 or more is required in the above case. It is difficult to obtain an inductance of this  $Q$ .

However, if the midfrequency of the 400-kilo-cycle pass band were shifted down to 4 megacycles, the required  $Q$  of the input and output circuits would then be about 10, and the necessary middle-circuit  $Q$  would be at least 100. This  $Q$  can be obtained without too much trouble. Thus, if triple-tuned band-pass circuits are to be

used, it would be worthwhile choosing a 10-percent, or even greater, bandwidth.

As in the double-tuned case, the high-impedance or node circuits will be considered to be used the most, and therefore the specific analysis will be made using three node circuits having both inductive and capacitive coupling, as shown in Fig. 6. It should be clearly realized, however, that the resulting analysis applies exactly to all of the myriad triple-tuned networks that can be formed from the networks of Figs. 1 and 2 and 4 and 5.

### 10. Exact Triple-Tuned Response Equation

The node equations which apply to the triple-tuned circuit of Fig. 6 are:

$$\begin{aligned}
 I &= \left\{ g_1 + j \left[ \omega(C_1 + C_{m_1}) - \frac{1}{\omega \left( \frac{L_1 L_n}{L_1 + L_{n_1}} \right)} \right] \right\} V_1 - j \left( \omega C_{m_1} - \frac{1}{\omega L_{n_1}} \right) V_2 + 0 \\
 0 &= -j \left( \omega C_{m_1} - \frac{1}{\omega L_{n_1}} \right) V_1 + \left\{ g_3 + j \left[ \omega(C_3 + C_{m_1} + C_{m_2}) - \frac{1}{\omega \left( \frac{L_{n_1} L_3 L_{n_2}}{L_n L_3 + L_3 L_{n_2} + L_{n_1} L_{n_2}} \right)} \right] \right\} V_2 - j \left( \omega C_{m_2} - \frac{1}{\omega L_n} \right) V_3 \\
 0 &= 0 - j \left( \omega C_{m_2} - \frac{1}{\omega L_{n_2}} \right) V_2 + \left\{ g_2 + j \left[ \omega(C_2 + C_{m_2}) - \frac{1}{\omega \left( \frac{L_2 L_{n_2}}{L_2 + L_{n_2}} \right)} \right] \right\} V_3.
 \end{aligned} \tag{27}$$

Introducing the resonant frequency (as defined in Section 5), the coefficient of coupling, and the decrement, we obtain from (27) the complete, exact solution for the magnitude and phase of the output voltage.

$$\begin{aligned}
 \frac{V_3}{I/\omega_0 \sqrt{(C_1 + C_{m_1})(C_2 + C_{m_2})}} &= \frac{\frac{1}{2} K^2}{\left\{ F^6 - [2K^2 - (n_1^2 + n_2^2 + n_3^2)] F^4 \right.} \\
 &\quad \left. + \{ K^4 - K^2 [n_1^2 + n_3^2 - n_2(n_1 + n_3)] + n_1^2 n_2^2 + n_2^2 n_3^2 + n_3^2 n_1^2 \} F^2 + \left[ K^2 \left( \frac{n_1 + n_3}{2} \right) + n_1 n_2 n_3 \right]^2 \right\}^{\frac{1}{2}}
 \end{aligned} \tag{28}$$

$$\tan \theta = \frac{+F[K^2 + (n_1 n_2 + n_2 n_3 + n_3 n_1) - F^2]}{-\left[ K^2 \left( \frac{n_1 + n_3}{2} \right) + n_1 n_2 n_3 - (n_1 + n_2 + n_3) F^2 \right]} \tag{29}$$

where as before  $F = \left( \frac{\omega}{\omega_0} - \frac{\omega_0}{\omega} \right)$   $K = \left( K_C \frac{\omega}{\omega_0} - K_L \frac{\omega_0}{\omega} \right)$ .

### 11. Small-Percentage Band-Pass Design Equations

Applying the reasoning used in Section 6 of the double-tuned analysis, we will consider the small-percentage band-pass case, i.e., where  $\omega/\omega_0$  becomes only about 10 percent greater or less than unity. We thus have the two great simplifications:

$$K \doteq (K_C - K_L) \quad \text{and} \quad \left( \frac{\omega}{\omega_0} - \frac{\omega_0}{\omega} \right) \doteq \frac{\Delta f}{f_0}$$

Setting the derivative with respect to

$$F \left( \doteq \frac{\Delta f}{f_0} \right)$$

of (28) equal to zero, we obtain for the location of



the maxima (plus sign) and minima (minus sign)

$$\frac{\Delta f_{\max}}{f_0} = 0, \quad \frac{\Delta f_{\min \max}}{f_0} = \frac{2}{3} \left[ K^2 \frac{n_1^2 + n_2^2 + n_3^2}{2} \right]$$

$$\pm \frac{1}{3} \{ K^4 - K^2 [n_1^2 + n_3^2 + n_2(3n_1 + 4n_2 + 3n_3)] + (n_1^4 + n_2^4 + n_3^4) - (n_1^2 n_2^2 + n_2^2 n_3^2 + n_3^2 n_1^2) \}^{\frac{1}{2}}. \quad (30)$$

We will obtain the design equations for the case where the  $Q$ 's of the input and output circuits are the same ( $n_1 = n_3 = n$ ) and the middle resonant circuit  $Q$  is much greater than the  $Q$  of the input and output circuits ( $n_2 \ll n$ ).

For this case, the general response (28) becomes the relatively simple equation

$$\frac{V_3}{I/\omega_0[(C_1 + C_m)(C_2 + C_m)]^{\frac{1}{2}}} = \frac{\frac{1}{2}K^2}{\left[ \left( \frac{\Delta f}{f_0} \right)^6 - 2(K^2 - n^2) \left( \frac{\Delta f}{f_0} \right)^4 + (K^2 - n^2)^2 \left( \frac{\Delta f}{f_0} \right)^2 + K^4 n^2 \right]^{\frac{1}{2}}} \quad (28a)$$

and from (30) the locations of the maxima and minima are given by

$$\left( \frac{\Delta f_{\max}}{f_0} \right)^2 = 0 \quad \text{and} \quad (K^2 - n^2) \quad (30a)$$

$$\left( \frac{\Delta f_{\min}}{f_0} \right)^2 = \frac{1}{3}(K^2 - n^2) = \frac{1}{3} \left( \frac{\Delta f_{\max}}{f_0} \right)^2$$

and the phase-shift equation becomes

$$\tan \theta = \frac{+ \left( \frac{\pm \Delta f}{f_0} \right) \left[ K^2 + n^2 - \left( \frac{\Delta f}{f_0} \right)^2 \right]}{- \left[ K^2 n - 2n \left( \frac{\Delta f}{f_0} \right)^2 \right]}. \quad (29a)$$

Substituting the locations of the maxima (30a) into the response equation (28a), gives the response at the peaks, which is

$$V_{\text{peaks}} = \frac{I}{\omega_0[(C_1 + C_m)(C_2 + C_m)]^{\frac{1}{2}}} \times \frac{1}{2n}. \quad (31)$$

Substituting the location of the minimum (30a) in the response equation (28a) gives the following response at the valley:

$$V_{\text{valley}} = \frac{I}{\omega_0[(C_1 + C_m)(C_2 + C_m)]^{\frac{1}{2}}} \times \frac{\frac{1}{2}K^2}{\left[ 4/27(K^2 - n^2)^3 + K^4 n^2 \right]^{\frac{1}{2}}} \quad (32)$$

and so the peak-to-valley ratio is

$$\left( \frac{V_p}{V_v} \right)_1 = \frac{\left[ 4/27(K^2 - n^2)^3 + K^4 n^2 \right]^{\frac{1}{2}}}{K^2 n}. \quad (33)$$

Introducing the location of the outside peaks (30a) into the peak-to-valley ratio (33), we can solve for the decrement that is required to produce a desired peak-to-valley ratio with a given percentage bandwidth between outside peaks. The result is our first design equation.

$$\frac{Q}{f_0/\Delta f_p} = \frac{1}{\gamma} \quad (34)$$

where

$$\gamma = \frac{\left\{ \frac{1 + (V_p/V_v)_1}{\left[ (V_p/V_v)_1^2 - 1 \right]^{\frac{1}{2}}} \right\}^{\frac{1}{2}} + \left\{ \frac{1 - (V_p/V_v)_1}{\left[ (V_p/V_v)_1^2 - 1 \right]^{\frac{1}{2}}} \right\}^{\frac{1}{2}}}{3^{\frac{1}{2}}} \quad (35)$$

and, using (30a), we have as the equation giving the coefficient of coupling which is required to obtain a given peak-to-valley ratio with a given percentage bandwidth between peaks

$$\frac{K}{\Delta f_p/f_0} = (1 + \gamma^2)^{\frac{1}{2}} \quad (36)$$

where  $\gamma$  is given by (35).

Multiplying (34) by (36), we obtain our second design equation.

$$KQ = [1 + (1/\gamma^2)]^{\frac{1}{2}}. \quad (37)$$

The next desired design equation is the one giving the skirt selectivity. Substituting the design equations (34) and (36) into the response equation (28a), we obtain the response at any point in terms of the peak-to-valley ratio (represented by  $\gamma$  of (27)) and the percentage bandwidth at the outside peaks. Dividing the result

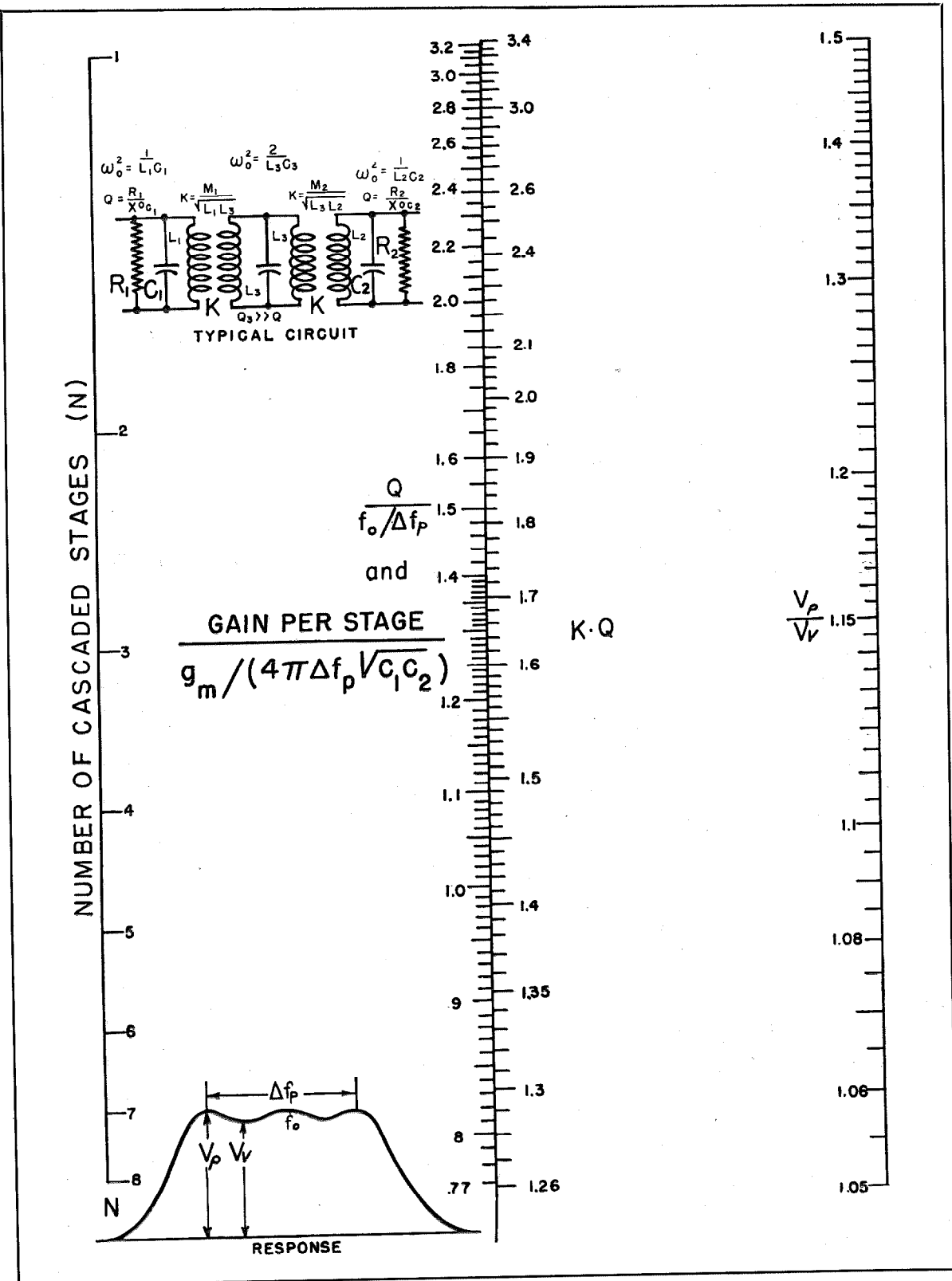

Chart I—Triple-tuned band-pass circuit design.

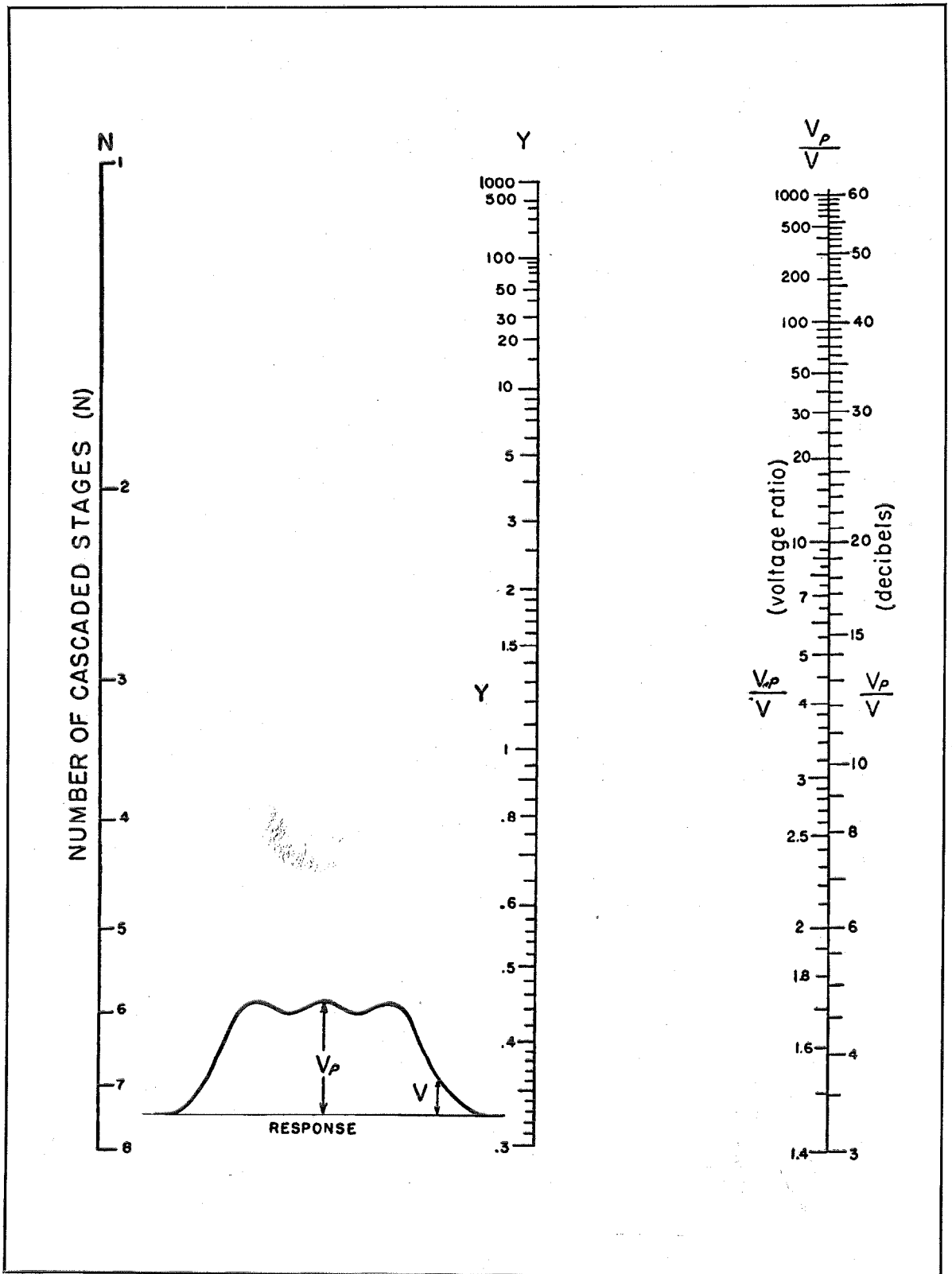

Chart II—Triple-tuned band-pass circuit design.

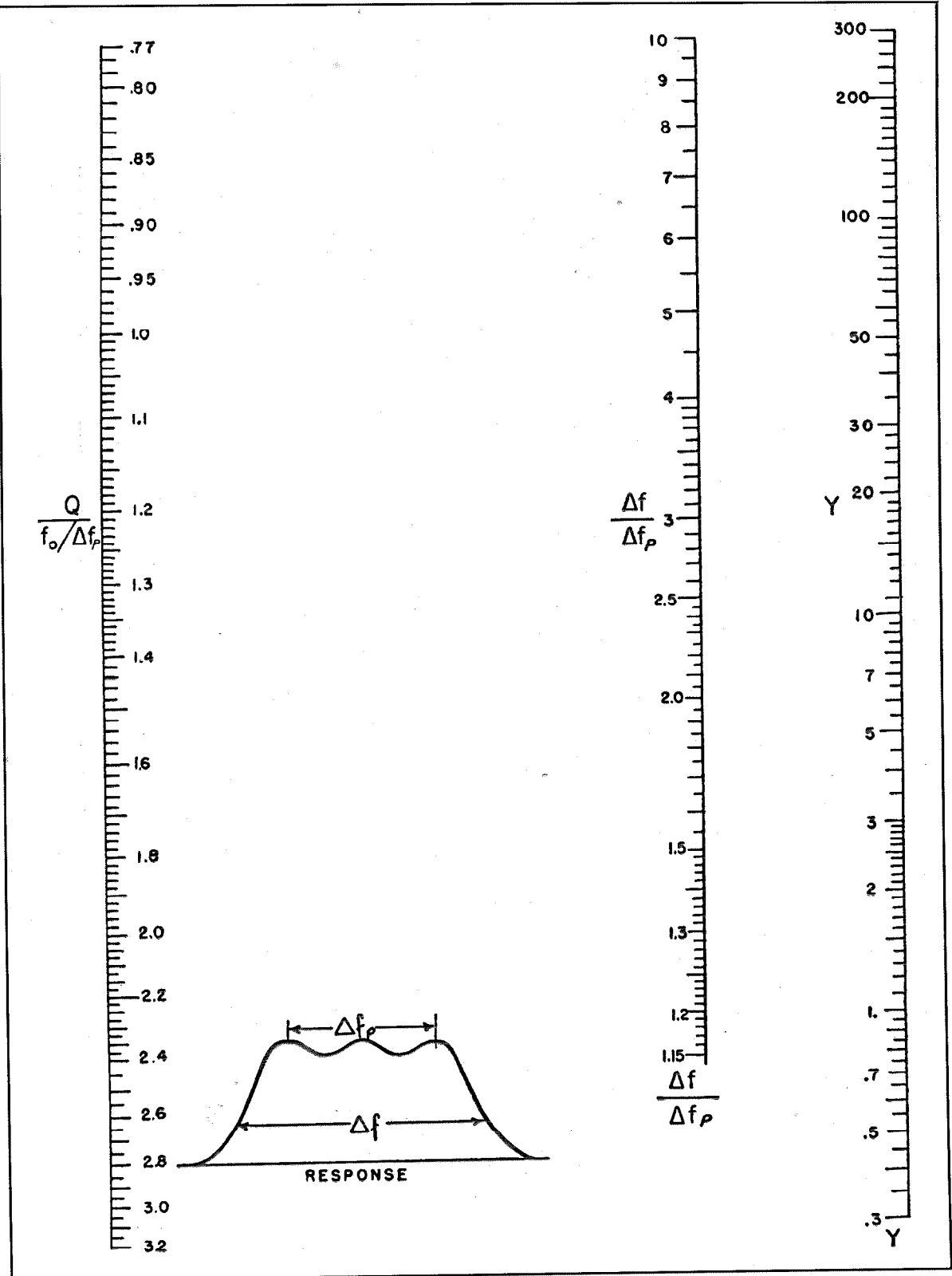

Chart III—Triple-tuned band-pass circuit design.

by the response at the peaks given by (24), we obtain the equation giving the skirt response ratios in terms of the skirt bandwidth.

$$\left(\frac{V_p}{V}\right)_1 = \left\{ 1 + \left\{ \frac{\left(\frac{\Delta f}{\Delta f_p}\right) \left[ \left(\frac{\Delta f}{\Delta f_p}\right)^2 - 1 \right]}{(1 + \gamma^2)\gamma} \right\}^2 \right\}^{\frac{1}{2}} \quad (38)$$

Solution of (38) for  $\Delta f/\Delta f_p$  gives

$$\left(\frac{\Delta f}{\Delta f_p}\right) = \frac{[d + (d^2 - 4/27)^{\frac{1}{2}}] + [d - (d^2 - 4/27)^{\frac{1}{2}}]}{\sqrt{2}} \quad (39)$$

where  $d = \gamma(1 + \gamma^2)[(V_p/V_v)^2 - 1]^{\frac{1}{2}}$ .

From this equation we can calculate the skirt bandwidth for different skirt-response points.

The next desired equation is the gain equation. Substituting the condition given by equation (34) into the peak equation (31), we obtain

$$V_2 = \frac{1}{\gamma} \times \frac{I}{4\pi\Delta f_p [(C_1 + C_{m_1})(C_2 + C_{m_2})]^{\frac{1}{2}}} \quad (40)$$

and, finally, if we substitute the design conditions (given by equations (34) and (36)) in the phase-shift equation (29a), we obtain the phase shift in terms of the peak-to-valley ratio, repre-

sented by  $\gamma$ , and the ratio of the bandwidth to the peak bandwidth.

$$\tan \theta = \frac{+\left(\frac{\pm \Delta f}{\Delta f_p}\right) \left[ 2\gamma^2 + 1 - \left(\frac{\Delta f}{\Delta f_p}\right)^2 \right]}{-\gamma \left[ \gamma^2 + 1 - 2\left(\frac{\Delta f}{\Delta f_p}\right)^2 \right]} \quad (41)$$

The above equations apply to a single triple-tuned stage. When  $N$  stages are cascaded and a resultant peak-to-valley ratio of  $V_p/V_v$  is desired, then the peak-to-valley ratio of each stage  $(V_p/V_v)_1$  must equal  $(V_p/V_v)^{1/N}$ . Similar reasoning applies to the skirt-response ratio, so that  $(V_p/V)_1 = (V_p/V)^{1/N}$ .

Application of the above reasoning gives the following design equations for  $N$  cascaded triple-tuned circuits, where the input and output resonant circuits in each stage are of equal  $Q$ , and the  $Q$  of the middle resonant circuit is much higher than that of the input and output circuits.

Let

$$\gamma = \frac{\left\{ \frac{1 + (V_p/V_v)^{1/N}}{[(V_p/V_v)^{2/N} - 1]^{\frac{1}{2}}} \right\}^{\frac{1}{2}} + \left\{ \frac{1 - (V_p/V_v)^{1/N}}{[(V_p/V_v)^{2/N} - 1]^{\frac{1}{2}}} \right\}^{\frac{1}{2}}}{3^{\frac{1}{2}}} \quad (35a)$$

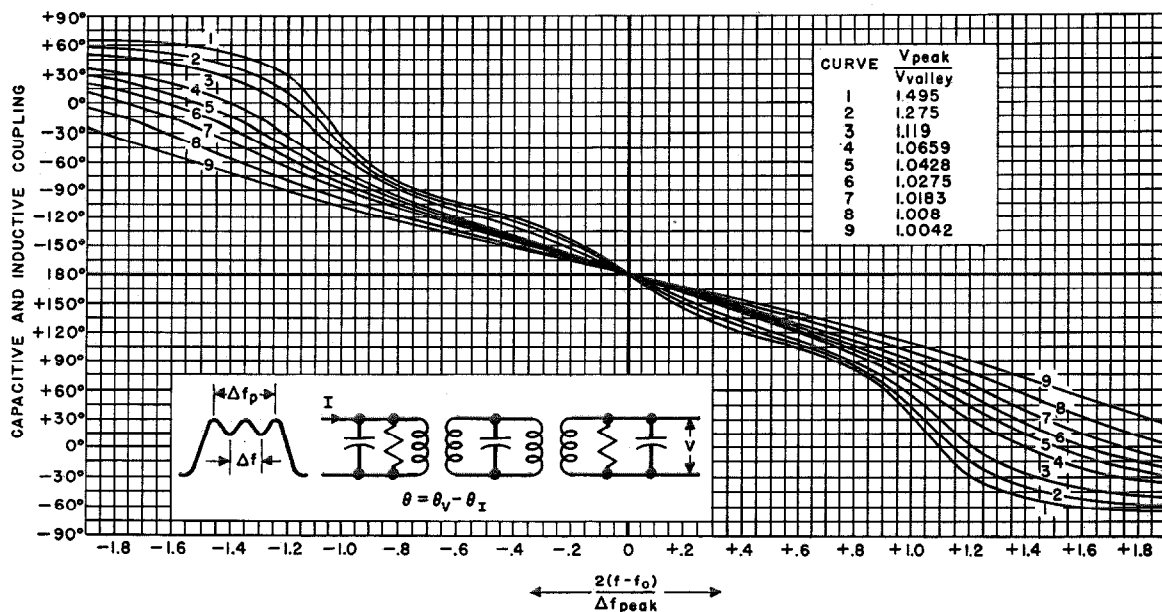

Chart IV—Phase shift for a flat-top triple-tuned circuit ( $Q_1 = Q_3, Q_2 \gg Q_{1,3}$ ) for different peak-to-valley ratios.

then

$$\frac{Q}{f_0/\Delta f_p} = \frac{1}{\gamma}$$

$$KQ = \sqrt{1 + 1/\gamma^2}$$

$$\frac{V_p}{V} = \left[ 1 + \left\{ \frac{\left( \frac{\Delta f}{\Delta f_p} \right) \left[ \left( \frac{\Delta f}{\Delta f_p} \right)^2 - 1 \right]}{(1 + \gamma^2)\gamma} \right\}^2 \right]^{N/2} \quad (38a)$$

$$\frac{\Delta f}{\Delta f_p} = \frac{[d + (d^2 - 4/27)^{1/2}]^{1/3} + [d - (d^2 - 4/27)^{1/2}]^{1/3}}{2^{1/3}}$$

where

$$d = \gamma(1 + \gamma^2) [(V_p/V)^{2/N} - 1]^{1/2} \quad (39a)$$

$$\frac{\text{Gain per stage}}{g_m/4\pi\Delta f_p [(C_1 + C_{m1})(C_2 + C_{m2})]^{1/2}} = \frac{1}{\gamma} \quad (40a)$$

$$\tan \theta_{\text{per stage}} = \frac{+ \left( \pm \frac{\Delta f}{\Delta f_p} \right) \left[ 2\gamma^2 + 1 - \left( \frac{\Delta f}{\Delta f_p} \right)^2 \right]}{-\gamma \left[ \gamma^2 + 1 - 2 \left( \frac{\Delta f}{\Delta f_p} \right)^2 \right]} \quad (41a)$$

From (34), (35a), (36), (39a), and (40a), another set of nomographs has been prepared. From the phase-shift equation (41), a family of curves has been prepared.

The procedure for using these nomographs and curves is identical with the procedure given in Section 3 for the double-tuned nomographs. The reader should refer to the examples given in that section.

## 12. Acknowledgment

I wish to express appreciation to R. R. Batcher for the construction of the nomographs from the equations in this paper.

I am also indebted to Jesse LeGrand of the Federal Telecommunication Laboratories for his helpful suggestions as to the format of the nomographs, and to both Mr. LeGrand and Melvin Klein for the many productive discussions we have had about much of the subject matter contained in the paper.

## 13. Corrections and Notes

Several corrections have been made in this reprint that were not included in the original publication. They occur in equations (15) and (30) and in references to the figures that introduce equations (1), (2), and (3). Also, the fourth line from the end of page 362 now refers to (19) rather than (18).

In Fig. 3, in the denominators of the equations for the vertical legs of the  $\pi$  equivalent of the transformer,  $\pm$  should be  $\mp$ . In the equations for the vertical leg of the  $T$  equivalent of the transformer,  $\neq$  should be  $=$ .

It should be noted that in Fig. 6, Chart A, and equation (27), subscripts 1, 2, and 3 refer to the input, output, and middle circuits, respectively; whereas in equations (28), (29), and (30), they refer to the input, middle, and output circuits, respectively.

# Simultaneous Radio Range and Radiotelephone Equipment

By GEORGE T. ROYDEN \*

*Mackay Radio and Telegraph Company, New York, New York*

**R**ADIO RANGE SIGNALS provide reliable indications of the location of an aircraft with respect to a specified course. The range station and the sector in which the aircraft is flying can be identified. Furthermore, voice transmission may be made without interfering with the radio range signals.

The development of radio range operation is reviewed, its theory is discussed, and apparatus is described. This type of equipment serves all important airports not only within the United States but also the principal airways throughout the world.

• • •

The equisignal radio range system<sup>1</sup> employing two crossed loop antennas has been particularly effective for the navigation of aircraft in that only an ordinary receiving set is needed on the airplane. Signals are alternately transmitted from each antenna. The figure-of-eight radiation pattern of the loop antennas produces signals of equal intensity along the bisector of the angle between the two antennas. At any other position, the signal from one of the antennas will be stronger. Usually a dash-dot (*N*) signal will be transmitted on one antenna and a dot-dash (*A*) signal on the other to facilitate identification of the sector when outside of the equal-signal zone. The signals are interlocked and a long dash is heard when on course.

Although the early equipments provided only four fixed courses at 90 degrees with respect to each other, devices were included in later designs for rotating the courses and also for squeezing and bending the courses so they might be useful in the most desirable directions. Subsequently, modulators and change-over relays permitted

choice of range or telephone transmissions. This type of equipment is still being employed as localizers for airports of secondary importance and at intermediate points along the airways.

The loop type of radio range was subject to variations, particularly at night.<sup>2</sup> These vagaries, together with the necessity to interrupt the range signals to broadcast weather information and operating instructions by voice, made it desirable to use vertical radiators in lieu of loop antennas and to develop equipment for simultaneous transmission.<sup>3</sup>

After a service trial<sup>4</sup> had demonstrated improved performance, plans were formulated to install the new type of equipment to serve the principal airports in the United States. It is the purpose of this paper to describe, not only the apparatus, but also its function in the system.

## 1. Theory of Operation

The manner in which the simultaneous radio range and radiotelephone system functions is adequately described in text books<sup>5</sup> on the subject and will be reviewed but briefly here.

The radio range station is located several miles from the airfield so its antenna towers will not constitute an accident hazard. Wherever possible, it is aligned so that one course passes over the center of the principal runway. The courses are also aligned so that they are directed along the routes connecting that airport with other airports.

There are five 135-foot vertical tower antennas at each station, four situated at the corners of a

\* Formerly, Federal Telephone and Radio Corporation, Newark, New Jersey.

<sup>1</sup> F. H. Engel and F. W. Dunmore, "A Directive Type of Radio Beacon and Its Application to Navigation," *Bureau of Standards Scientific Paper* 480; January, 1924.

<sup>2</sup> Haraden Pratt, "Apparent Night Variations With Crossed-Coil Radio Beacons," *Proceedings of the I.R.E.*, v. 16, pp. 652-657; May, 1928.

<sup>3</sup> "Simultaneous Transmission of Voice and Aerial Radio Range Signals," *Air Commerce Bulletin*, v. 5, p. 268; May 15, 1934.

<sup>4</sup> "Simultaneous Transmission of Radio Beacon Signals and Voice in Trial Service at Pittsburgh," *Air Commerce Bulletin*, v. 7, p. 1; July 15, 1935.

<sup>5</sup> P. C. Sandretto, "Aeronautical Radio Engineering," McGraw-Hill Book Company, New York; 1942.

square about 425 feet on each side and the fifth at the center. The center antenna is employed for the carrier signal which is modulated by voice. The four corner antennas produce two figure-of-eight radiation patterns.

In Fig. 1, there is shown at *C* the circular radiation pattern of the carrier channel produced by the center tower. One figure-of-eight radiation pattern is keyed with a dot-dash sequence as shown at *A*. The other, keyed with a dash-dot sequence, is shown at *N*.

Voice modulation of the carrier channel is accomplished in the normal manner. However, the audio-frequency signal is supplied to the modulator through a preamplifier having a peak-limiting feature and the subsequent audio-frequency amplification is adjusted so that the maximum modulation is 70 percent. The power radiated by the side-band channel on a frequency 1020 cycles per second above that of the carrier channel is adjusted so that 30-percent modulation occurs in a receiver located on the course having the strongest signal.

This division of the available 100 percent modulation is proportioned so that attention may be concentrated either on the voice or the range signals. However, most aircraft are provided with a small filter to separate the voice and range signals so either may be heard separately without interference from the other.

Referring again to Fig. 1, the signals heard in several directions are indicated at the bottom. In the direction where there is negligible radiation of *A* signals, only *N* signals are heard. Next, an off-course signal on the *N* side is represented. Although the tone is continuous, the stronger *N* signals are clearly identified. In the zone where the *A* signals are equal in intensity to the *N* signals, a continuous tone is heard. This zone is approximately 1.5 degrees wide. It is customary for pilots to fly along the right edge of this equisignal zone where the *A* or *N* signal can just be discerned.

The keying of the interlocked *N* and *A* signals is controlled by a motor-driven device which interrupts the radio range signals after 12 *NA* sequences and transmits the coded station identification letters.

## 2. Equipment

The equipment for a simultaneous radio range and radiotelephone station consists of two transmitters (one for standby), coupling unit, five antenna tuning units, transmitter control unit, receiver, five antennas, buildings, power supply, and miscellaneous materials for installation. The principal units are shown in Fig. 2.

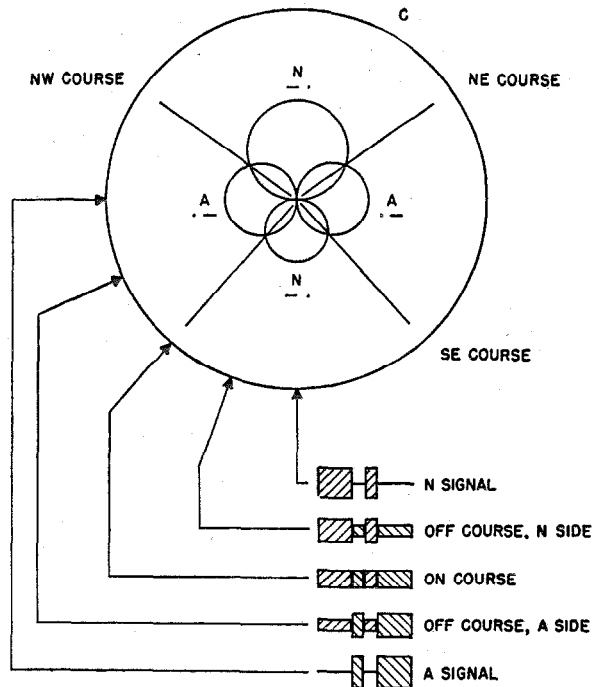

Fig. 1—Typical radiation pattern of a radio range. The asymmetry of radiation in the *N* sectors has shifted the courses from the 90-degree relations that would obtain with equal radiation from each of four antennas at the corners of a square. The center antenna produces the circular field pattern.

## 3. Transmitter

Each of the transmitters, one of which is shown in Fig. 3, has two independent crystal-controlled oscillators, two radio-frequency amplifiers, an audio-frequency amplifier, two rectifiers with filter networks for plate current, one rectifier with filter for grid bias, control switches and relays, indicator lamps, meters, fan, and other necessary auxiliaries.

The oscillator circuits are designed to operate at any frequency between 200 and 400 kilocycles. The oscillator circuit is not tuned to resonance but is designed to provide uniform



amplitude throughout the specified frequency range. The crystal for the side-band channel is ground for a frequency 1020 cycles higher than that for the carrier channel. Furthermore, these crystals are matched pairs having similar characteristics so as to maintain this frequency difference over a wide range of temperature.

One rectifier provides direct current at 1300 volts for the plate circuits of the power tubes. Separate filter networks are provided for the carrier and side-band channels to avoid cross modulation. Another rectifier provides plate current at 500 volts for the oscillator and low-power stages. A third rectifier provides negative

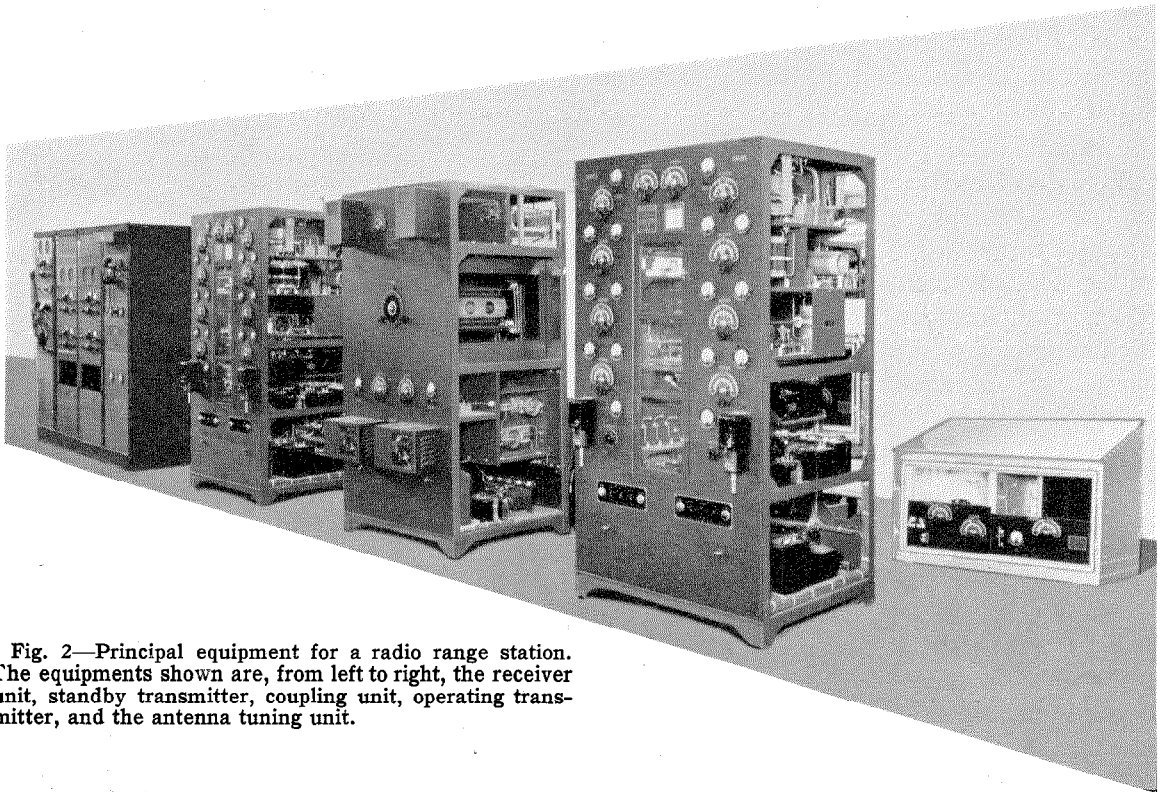

Fig. 2—Principal equipment for a radio range station. The equipments shown are, from left to right, the receiver unit, standby transmitter, coupling unit, operating transmitter, and the antenna tuning unit.

The untuned buffer stage is followed by several tuned stages of radio-frequency amplification. The final stage of the carrier channel employs 4 type-805 triodes in parallel. The radio-frequency amplifier for the side-band channel is similar to that for the carrier channel except that only two tubes are used. The input circuit for the final stage is neutralized. The output circuits are of the  $\pi$  type designed for coupling into a transmission line. Because of the very small frequency separation between the carrier and side-band channels, careful design is necessary to avoid interaction and cross modulation between the two radio-frequency amplifiers.

The audio-frequency amplifier is of conventional design employing three stages with a pair of type-805 tubes operating as a class-B amplifier in the output stage.

grid bias. A thermostatically controlled electric heater ensures proper operating temperature for the mercury-vapor rectifier tubes.

The transmitter is started and stopped by contactors which may be controlled by switches on the front panel or by relays in the transmitter control unit. Appropriate lights indicate the operating conditions.

Controls for the necessary adjustments are mounted on the front panel together with dials. An indicating meter for the controlled circuit is installed in the vicinity of each control.

The inner compartment, in which all vacuum tubes are located, acts as a chimney to provide ventilation. When the ambient temperature is above normal, a thermostat starts a fan to provide additional ventilation.

#### 4. Coupling Unit

Specially designed contactors in the coupling unit, shown in Fig. 4, connect either of two transmitters to the transmission lines to the antennas and their tuning units. The side-band energy passes through appropriate keying and power-dividing circuits.

From the relay that selects the proper transmitter, the side-band circuit is connected through the moving contact of the keying relay to the course-squeezing resistors and the goniometer primary windings, which are tuned to resonance with capacitors. The secondary windings of the goniometer are connected through tuning capacitors to the artificial lines and thence to the transmission lines.

The keying relay, which is often called the link-circuit relay because of its position in the

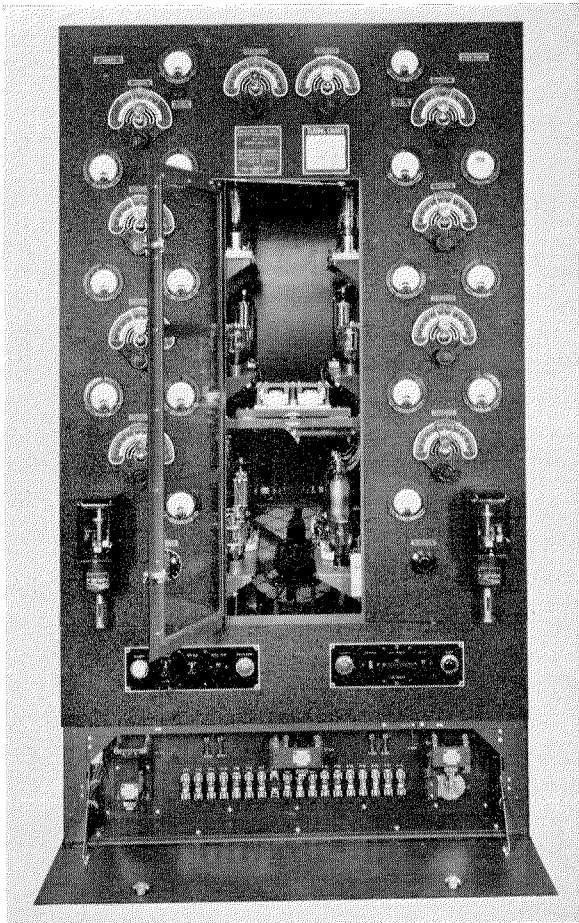

Fig. 3—Radio transmitter. The 400-watt carrier channel is at the left and the 275-watt side-band channel is at the right.

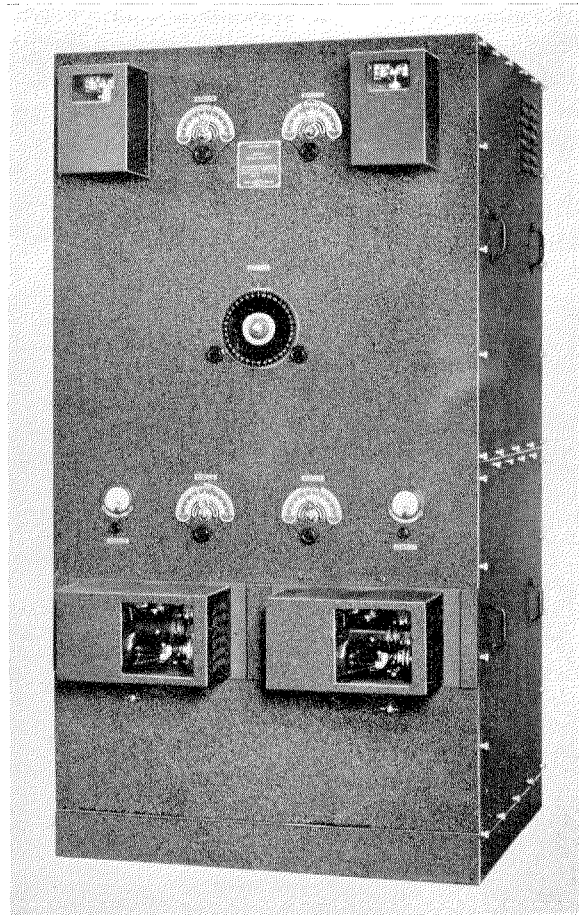

Fig. 4—Coupling unit through which the output power passes from the transmitter to the antenna tuning apparatus. It includes keying relays, goniometer, and other circuits.

circuit coupling the transmitter to the transmission lines, is of special design. The relay is adjusted so that contact is made on one side at the same time contact is broken on the other side. One of each pair of contacts is backed by a spring. This spring is compressed and, on reversal of the signal, assists in accelerating the armature so that a quick break is accomplished.

The course-squeezing resistance pad is connected to a terminal board which has movable links to facilitate connection of the pad in either goniometer primary circuit. The pad may also be connected directly between the link-circuit relay and the goniometer to facilitate adjustment to the required input impedance and to give the proper ratio of currents in the goniometer primaries to produce the desired course squeezing.

The goniometer<sup>6</sup> is an adaptation of the device employed in the early days of radio by Bellini and Tosi in their receiver for direction finding. It was necessary to incorporate many engineering refinements and subtleties of design in the modern version to obtain the high degree of precision required by the exacting specifications. The goniometer has two primary windings

capacitive currents whose magnetic fields oppose the fields of similar currents in the primary windings. Further compensation is obtained by careful disposition of the leads.

A variable air capacitor, shunted by mica capacitors as necessary for the assigned frequency, is employed for tuning each primary and each secondary winding to resonance. Each goniometer secondary circuit supplies energy through two artificial lines and transmission lines to diagonally opposite radiators. These artificial lines are designed so that, in effect, they reduce the length of the real line and are adjustable; the reduction caused by one may exceed that by the other. In this manner, the size of one lobe in the radiation pattern in Fig. 1 may be made larger than that of the other lobe.

Duplicate motor-driven keying devices are provided for controlling the link-circuit relays. Segments may be selected

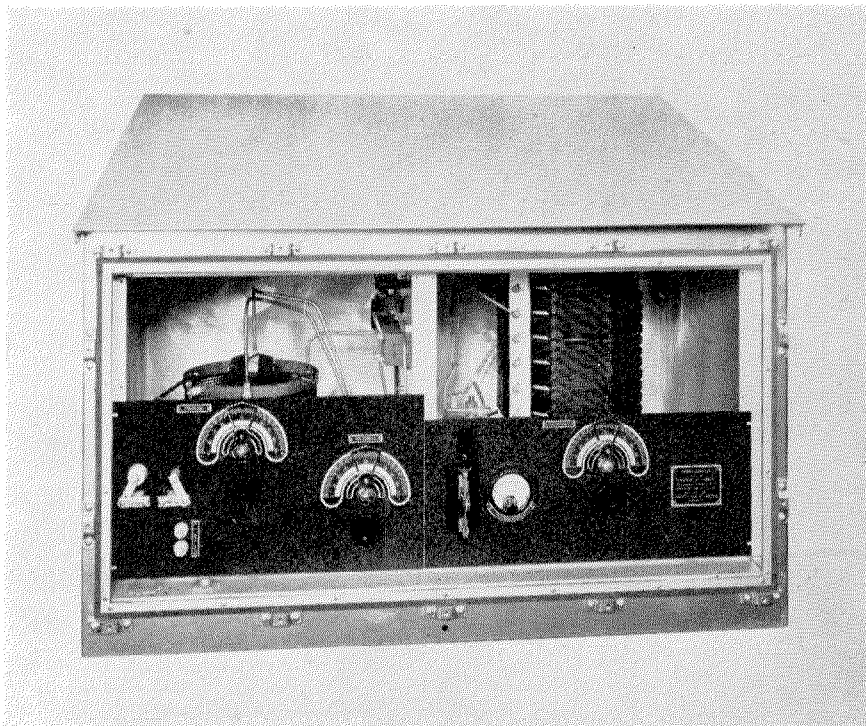

Fig. 5—Antenna tuning unit located at the base of each tower. All necessary antenna adjusting circuits are included in it together with isolation equipment for the tower lights.

at right angles to each other and two secondary windings also at right angles to each other but mounted so that they may be rotated within the primary windings. Each primary consists of two symmetrical windings; the tuning capacitors are inserted between the windings so that the reactive components are electrically balanced with respect to ground. This reduces the effective capacitive coupling, which coupling is further reduced and partially compensated by a shield of special design inside the stator winding. Instead of connecting the wires of this shield in parallel to form a Faraday screen, they are connected in series and so arranged that they carry

and mounted on a cam to form the coded identification signals. This cam is rotated twice at intervals of about 40 seconds and sends the station call letters once on the *A* lobes and once on the *N* lobes. Keying is accomplished in the side-band transmitter at a low level.

Duplicate rectifiers are included in the coupling unit to provide direct current for operation on the link circuit relays.

### 5. Antenna Tuning Unit

Power is fed from the coupling unit through specially designed flexible underground transmission lines to an antenna tuning unit at the base of each vertical radiator. Each unit has an

<sup>6</sup> W. W. Macalpine, "The Radio Range Goniometer," *Communications*, v. 23, p. 36; December, 1943.

input circuit, an antenna circuit, and means for coupling them to each other. The input circuit is tuned by a variable air capacitor, shunted by mica capacitors, if necessary. The antenna inductor is tapped and has a variometer for fine tuning.

The circuits may be adjusted for phase and amplitude stability<sup>7,8</sup> by making the angle between the antenna current and the exciting voltage equal to the angular length of the transmission line between the source and the connection to the antenna tuning unit. This adjustment may be made by temporarily short-circuiting the transmission line at the source, connecting the line to the primary circuit, tuning the primary circuit (with antenna temporarily disconnected) so that the resultant circuit is in resonance; then adjusting the antenna circuit and coupling so that a nonreactive impedance equal to the surge impedance of the transmission line appears at the input terminals.

Radio-frequency choke coils with by-pass capacitors are included for feeding current to the tower for operation of the obstruction warning lights. The return circuit is through the antenna loading coil to ground. A buried parkway cable brings power from an insulating transformer to the antenna tuning unit at each corner tower.

All electrical components are enclosed in a metal house for protection. A view of the antenna tuning unit is shown in Fig. 5.

## 6. Control Unit

The transmitting equipment is normally unattended and is remotely controlled from an operating position at the airport. The control apparatus is mounted in a cabinet as shown in Fig. 6.

A group of secondary relays, mounted at the top, provide for turning the filaments of either transmitter on or off, energizing the plate circuits of either transmitter, energizing the modulator of the transmitter in use, transmitting an attention signal (series of dashes of 1020-

cycle modulation) to warn pilots listening to the range of a forthcoming important voice broadcast, start or stop the marker beacon transmitter, and turn on or off the tower obstruction warning lights.

These secondary relays are controlled by primary relays, which are mounted behind the remote-control panel, located just below the blank panel at the top. The primary relays

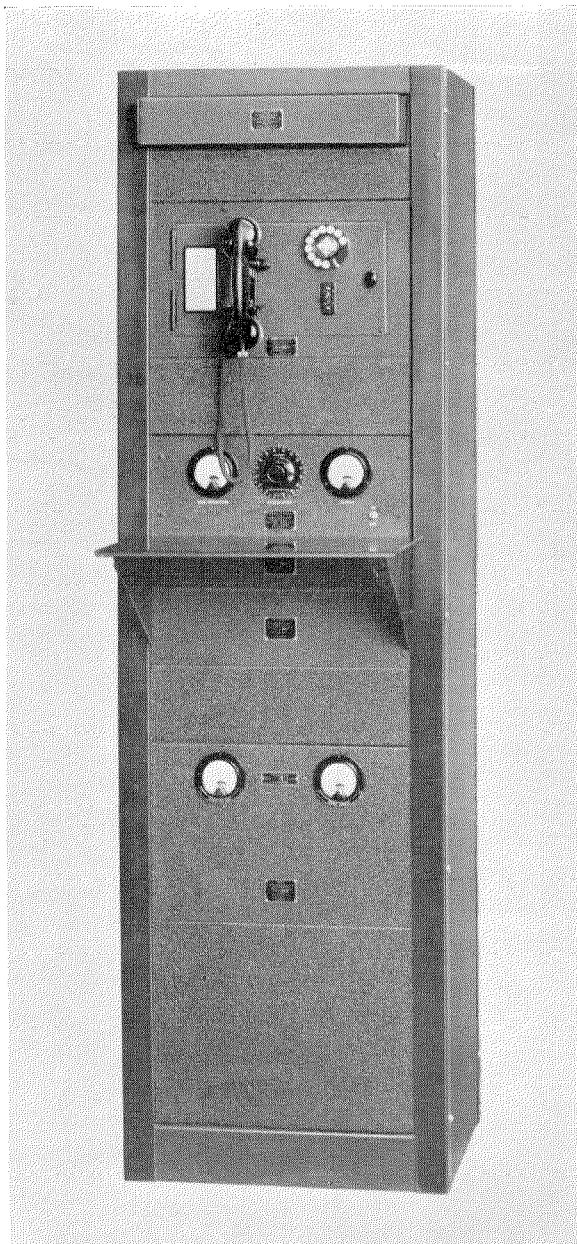

Fig. 6—Control unit permitting remote operation of the unattended transmitting station.

<sup>7</sup>F. G. Kear, "Phase Synchronization in Directive Antenna Arrays with Particular Application to Radio Range Beacon," *National Bureau of Standards Journal of Research*, v. 11, p. 123; July, 1933.

<sup>8</sup>H. Roder, "Elimination of Phase Shifts Between the Currents in Two Antennas," *Proceedings of the I.R.E.*, v. 22, pp. 374-394; March, 1934.

are controlled by a two-motion machine switch. These are of the type employed with automatic-telephone apparatus. A handset of the sound-power type is provided for communication with the remote station. A dial is mounted on the panel for local control through the remote-control apparatus.

The preamplifier for the voice circuit is mounted near the center of the cabinet. This has sufficient gain to compensate for loss in the transmission line. An important feature is the automatic peak-limiting circuit. A signal proportional to the output is applied to a full-wave rectifier whose cathodes have a positive bias such that only an excessive peak signal will pass through the rectifier and charge a capacitor. The change in voltage, thus produced, biases the grids of two variable-gain amplifier tubes in the first stage of the amplifier.

A band-elimination filter is mounted near the center of the cabinet. This is designed to remove a narrow band of frequencies centered at 1020 cycles from the voice signals to avoid interference with radio range operation.

An adjustable line equalizer is provided to compensate for greater losses at frequencies near 200 and 4000 cycles.

The panel near the bottom provides direct current at 48 volts for operation of the remote-control switch and associated relays. Selenium rectifiers<sup>9,10</sup> are employed in connection with an ingenious circuit to maintain substantially constant output voltage with normal variations of line voltage and load current.

<sup>9</sup> J. E. Yarmack, "Selenium Rectifiers for Closely Regulated Voltages," *Electrical Communication*, v. 20, n. 2; Figs 7, 8, and 9, also text on pages 128 and 129; 1941.

<sup>10</sup> U. S. Patent 2,182,666.

## 7. Receiver Unit

The communication-type receivers are mounted in three adjacent cabinets, as illustrated in Fig. 7. Each receiver may be tuned to a frequency in the 200–400-kilocycle band or to a frequency in the high-frequency band. A loudspeaker is provided for each receiver and is connected through a switch which permits it or all other loudspeakers to be silenced.

A high-quality microphone, mounted on an arm that permits a wide range of positioning, is provided for voice broadcast and radio communication.

A speech amplifier is provided for use in connection with the microphone. It has sufficient gain to raise the level to that necessary for operation over a normal telephone line.

The remote-control panel includes a dial of the automatic-telephone type, for control of the

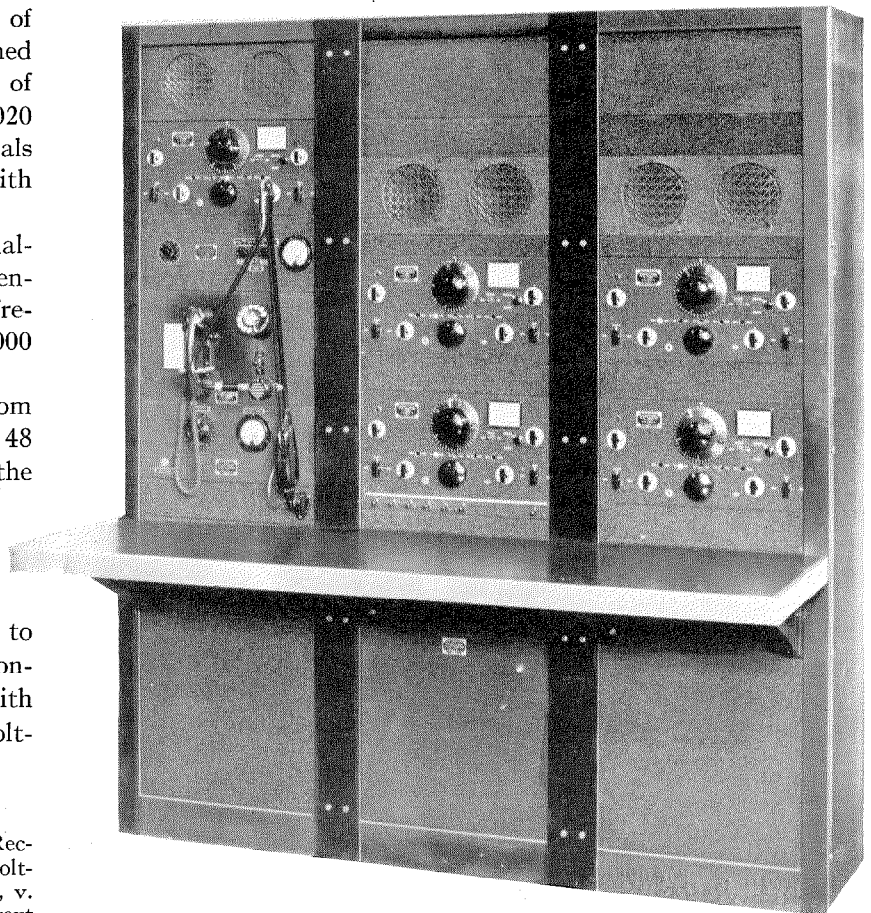

Fig. 7—Several communication-type receivers are mounted in three cabinets. The loudspeakers are arranged so that all but one may be silenced as required.

apparatus at the transmitting station, and a sound-powered telephone handset for intercommunication.

A monitor panel with a combination band-pass and band-reject filter, meter, and switches is included for observation of the signals from any radio range station in the vicinity.

A shelf is provided for the convenience of the operator.

### **8. Antennas**

The antennas most often used are fabricated steel towers approximately 135 feet tall. They are insulated at the base and operate against a counterpoise about 10 feet above the ground. The use of a counterpoise helps maintain constant capacitance and resistance of the antenna circuit.

### **9. Production**

Although similar apparatus has been made by four other organizations within the United States, the number of equipments manufactured by Federal Telephone and Radio Corporation and its predecessor, Federal Telegraph Company, exceeds the combined production of all other concerns.

### **10. Acknowledgment**

The technical staff of the United States Civil Aeronautics Administration and predecessor organizations were responsible for the over-all system planning. Credit is due to Mr. H. Romander for the design of the transmitter, to Mr. W. W. Macalpine for the design of the coupling unit, to Mr. G. C. Perkins for mechanical design, and to other associates in the Federal Telephone and Radio Corporation who made significant contributions to the design and production of the equipment described.

# Variable-Frequency Two-Phase Sine-Wave Generator

By T. H. CLARK and V. F. CLIFFORD

*Federal Telecommunication Laboratories, Inc., Nulley, New Jersey*

VARIABLE-FREQUENCY two-phase sine-wave voltages have an important application to circle generation in cathode-ray-tube circuits. A generator capable of delivering any frequency between direct current and 60 cycles is described. The sine-wave output may in turn have superimposed on it any frequency from direct current to 400 kilocycles.

. . .

A system of direction finding,<sup>1</sup> which was of great utility during World War II, indicated direction by means of a pattern on the screen of a cathode-ray tube. A simple circle, just within the scale markings of Fig. 1, was obtained in the absence of signals. The radial sweep amplitude was controlled by the output of a radio receiver whose input was derived from a goniometer rotating at the speed of generation of the circle. The field explored by the search coil changes the circle to sharp pointers, as shown in Fig. 1, to indicate the direction of arrival of the radio wave.

## 1. Rotating Magnetic Field

One method of generating the circle is to rotate an electromagnet about the neck of the oscilloscope. The electromagnet is energized by the plate current of a direct-current amplifier operated from the second detector of the receiver. This is entirely satisfactory for shore or shipboard equipments. However, it is difficult to adapt for aircraft or mobile use because of its bulk and weight.

## 2. Rotating Electric Field

A circle can also be generated on the screen of a cathode-ray tube by applying a two-phase sine-wave voltage to the deflection plates. Any suitable generator may be used. A two-phase generator or a single-phase generator with a phase-

splitter for deriving the orthogonal phase may be employed. The disadvantage of the single-phase generator and phase-splitter is that the phase shift depends somewhat on frequency, so that the two phases may not always be at 90 degrees. Disadvantages of the two-phase generator are that the two phases may not be orthogonal, of equal amplitudes, or perfect sine waves. Filters to eliminate higher harmonics are usually required.

## 3. Resistive Generator

A resistive sine-wave generator was successfully produced in 1939 in Les Laboratoires, Le Matériel Téléphonique in Paris. This generator is shown in Fig. 2. It uses 360 separate resistors in groups of 4, arranged so that their resistance values give a sinusoidal resultant when measured around the circumference of the distributing or commutating cylinder. The commutator consists of copper bars affixed to the ends of a cylinder rotated on its axis and carrying the resistors. Such an arrangement gives perfectly satisfactory operation and long life. It operates at all speeds up to 3600 revolutions per minute and the circle produced on the cathode-ray tube is of excellent

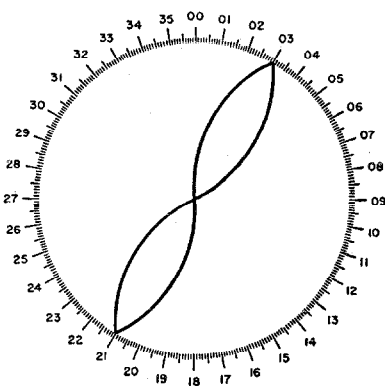

Fig. 1—Indicating pointers on screen of cathode-ray tube show the direction of arrival of incoming waves. In the absence of a signal, a circular pattern is visible just within the scale markings.

<sup>1</sup> Giltner Twist, "Army Radio D-F Networks," *Electronics*, v. 17, pp. 118-124; November, 1944.

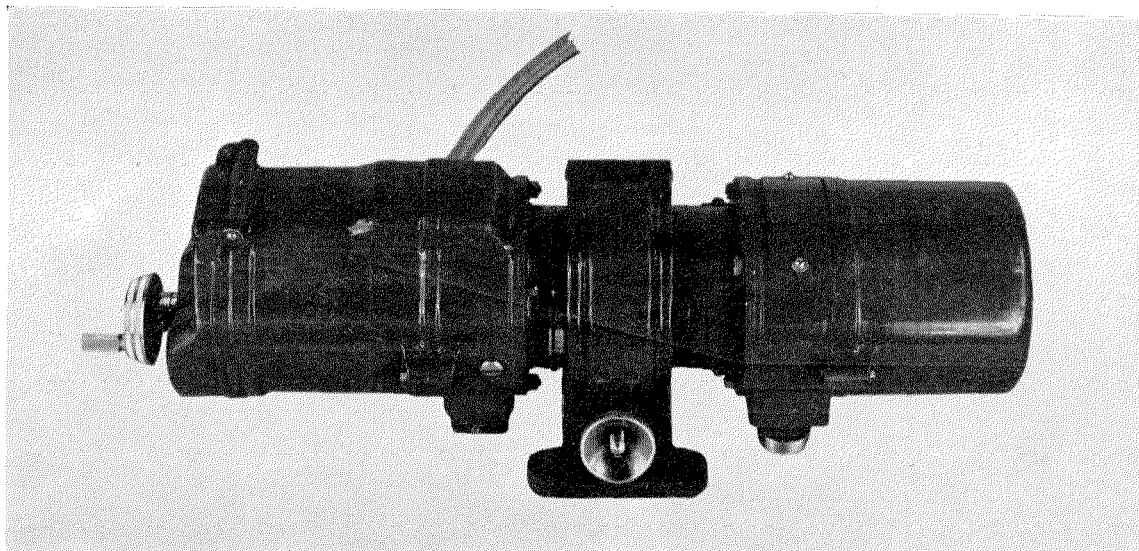

Fig. 2—Resistive type of sine-wave generator produced in 1939 by Le Matériel Téléphonique.

quality. The generator is not useful at high output frequencies unless the resistors (which are wire wound) are noninductive. This adds to the cost.

#### 4. Linear Distributor

The unit described in this paper is based on the parallel equipotential lines formed by a uniform flow of current in a plane resistive sheet as shown in Fig. 3. If two probes are used to explore such a resistive sheet, zero voltage will always be found between the probes when they are located on the same equipotential line. If the sheet is rotated about the central point and if the probes are located at the extreme ends of a line passing through that point, the voltage between the probes will vary in a sinusoidal manner. If a second pair of probes is arranged 90 degrees from the first, as shown dotted, a two-phase voltage can be obtained.

The current, which flows through the resistive sheet to produce the equipotential lines, may be derived from any suitable source. The resultant output voltage is easily calculable from the resistance of the strip between the probes and the current flowing through the strip. A schematic diagram of the utilization circuit is shown in Fig. 4, where  $R$  is the resistance of the strip,  $r$  is the resistance of the load between the probe points, and  $R_i$  is the internal resistance of the generator  $G$ . The voltage variation across the load resistor

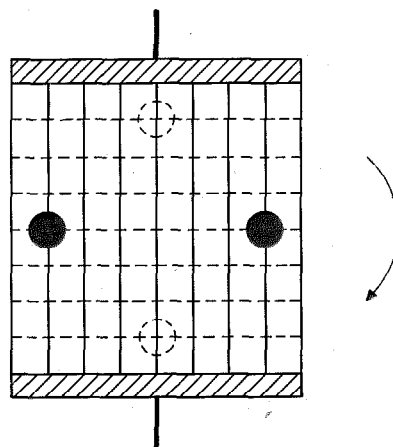

Fig. 3—Linear distributor. Uniform lines of current, indicated by solid lines, flow across a plane resistive sheet from copper connecting bars. Equipotential lines, shown dotted, are at right angles to the current flow. Probes are shown as large solid dots. Relative rotation of the probes about the central point on the sheet will develop a sine-wave voltage between the probes. For two-phase output, the additional pair of probes shown dotted may be used.

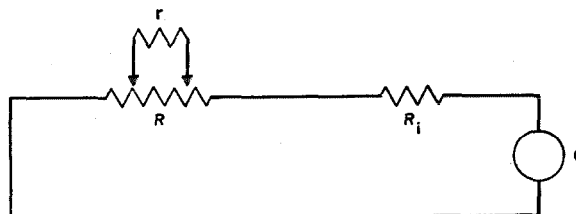

Fig. 4—Equivalent network of distributor circuit.  $R$  is the resistance of the strip,  $r$  is the load resistance, and  $R_i$  is the internal resistance of the generator  $G$ .



$r$  will be sinusoidal when  $r$  is large compared to the strip resistance  $R$ . This requirement is easily satisfied when the voltage is applied to the deflecting plates of a cathode-ray oscilloscope, i.e., when  $r$  is the deflecting-plate resistance. A simplified schematic of the circuits used with a direction finder is shown in Fig. 5.

1 degree is to be produced. The maximum speed of rotation is 1800 revolutions per minute or  $10.8 \times 10^3$  degrees per second. To obtain the definition required, it is then necessary that the circuit combination shall reproduce frequencies up to 11,000 cycles per second.

In another application, it is desired that 0.5-

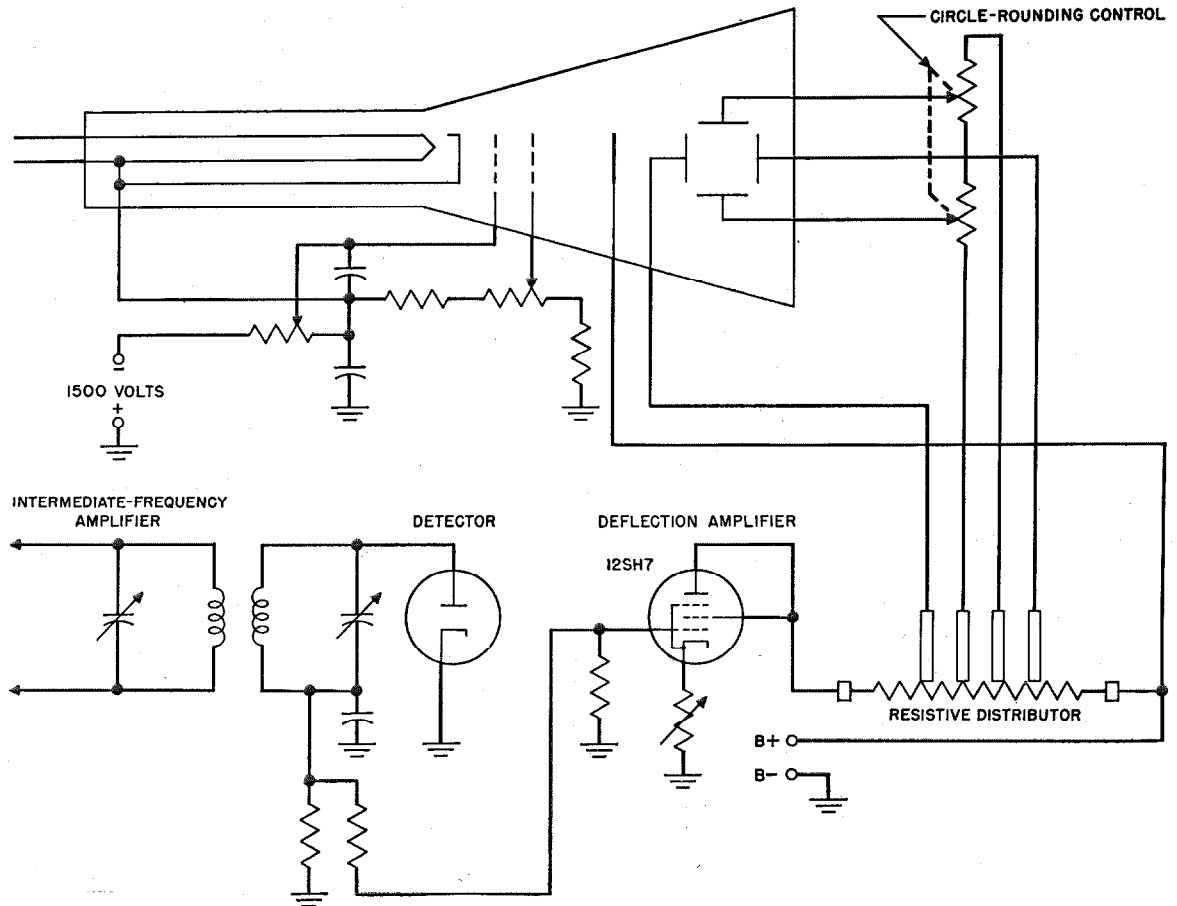

Fig. 5—Application of resistive distributor to a direction finder.

The source need not be direct current. It is satisfactory to pass the plate current of a vacuum-tube amplifier through the resistor strip, in which case the same design considerations should be followed as for any other type of load resistance. The load in the amplifier plate circuit consists of the resistor strip  $R$  and the load resistance  $r$ . The associated capacitances and inductances must be considered at high frequencies.

An idea of the circuit design considerations may be obtained from the following application examples. An azimuthal indication accurate to

microsecond square waves be visible on the cathode-ray-tube screen as a radial inward deflection from the circle. For this application, circuit compensation means were employed similar to those in common use in television practice. In the final design, using only the most simple compensation, the deflection amplitude at a frequency of 400 kilocycles was 0.5 of maximum, which was obtained at low audio frequencies. The response was quite flat to the highest frequency. If peaking coils are used, the response can be made better than 0.7 of maximum at 400 kilocycles.

4.1 DISTRIBUTOR AS A CONSTANT-VOLTAGE TWO-PHASE SOURCE

If the rotating resistor strip is energized from a constant direct-current source and the output from the brushes goes to the deflecting plates of a cathode-ray tube, a circle of constant diameter will appear on the screen. If, instead, the outputs of the two phases are applied to direct-current amplifiers, a higher frequency can be superposed on the very-low-frequency two-phase voltages. This method is useful when the two-phase voltage required is greater than can be accommodated safely across the distributor.

The highest frequency that can be superposed on a basic wave depends entirely on the characteristics of the direct-current amplifiers and superposition circuits. Circles have been generated at 150 revolutions per minute and deflected inwardly to zero with 0.5-microsecond square-wave pulses of 5 volts amplitude. The deflecting plates required 1000 volts, peak to peak, at 2.5 cycles with two phases to maintain the circle. The circuit<sup>2</sup> is shown in Fig. 6. It is, of course, very important in applications of this type to maintain a strict balance between the two amplifiers, which must be effective both at direct current and at 3 megacycles.

The pulses are applied simultaneously to the grids of the tubes that perform the superposition. There is one push-pull amplifier for each pair of deflecting plates. 6SK7 tubes are employed for

superposition because their remote-cutoff characteristic allows square-law modulation to be used. The output of each superposition stage consists of one phase of the 2.5-cycle voltage on which is superposed the pulse output of the receiver.

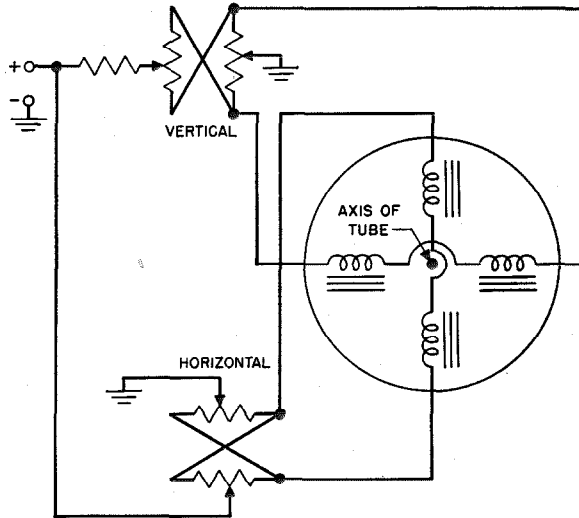

Fig. 7—Horizontal and vertical positioning controls for centering the circular sweep on the cathode-ray-tube screen.

The peak-to-peak voltage of this superposed wave is approximately 150 volts with respect to ground. With this high voltage applied directly to the 6SN7 grids, it is necessary to use a type 9003 pentode as cathode bias resistor. This has the effect of allowing the cathode voltage to follow exactly the large parallel voltages resulting from the superposition process.

<sup>2</sup> Developed by M. Dishal of Federal Telecommunication Laboratories.

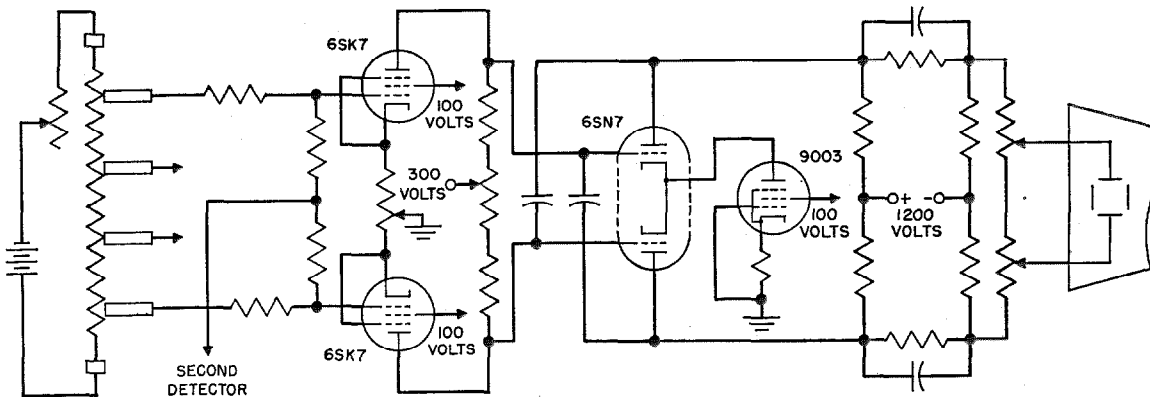

Fig. 6—The voltage from the distributor is amplified and applied to the deflecting plates of the cathode-ray tube. A similar amplifier operates on the quadrature phase from the other distributor probes, supplying voltage to the second pair of deflecting plates and producing a circular sweep. A 5-volt square-wave signal applied to both amplifiers from the second detector of a receiver will reduce the radial deflection to zero. The 9003 is used as a cathode bias resistor for the 6SN7.

#### 4.2 MEANS FOR CENTERING THE IMAGE

The circle, which is generated on the screen of the cathode-ray tube, will be centered only if the gun structure of the tube is centered and if there are no interfering magnetic fields, including that of the earth. These are long-term conditions, and it has been found satisfactory to compensate for them by the application of a magnetic field of controllable magnitude and direction. A suitable circuit is shown in Fig. 7. Adjustment may be made either by centering the position of the circular trace with regard to a calibration scale or by adjusting the spot to the center of the screen or scale when the radial deflection is zero.

A two-phase generator has been designed having only four brushes instead of the six that are required when two balanced phases are desired. The circuit shown in Fig. 8 has been found satisfactory for centering with cathode-ray tubes in which two deflecting plates are connected to the second anode within the tube. The circle produced can be centered along one diagonal of deflection by the voltage divider shown. The supplementary electromagnetic method described above is used to center it along the other diagonal.

#### 5. Development of Distributor

When the idea of a linear resistance strip was proposed, various means were considered for producing a device having long life and reliable characteristics. One proposal was to use a rectangular block of carbon or other resistive material and to electroplate onto it a metal that could be used as a contact and commutating surface. Copper was chosen as the plating metal. The entire device was then machined to produce regular discontinuities in the metallic surface to act as commutating segments. This scheme was unsuccessful because the metallic plating would adhere only by virtue of its continuity. When this continuity was interrupted the metal peeled away from the carbon block.

If an extremely hard resistive surface were available, it was thought that the surface could be used directly for contact with the brushes. A suitable material was produced by the International Resistance Company in the form of a thin carbon film on a bakelite strip. Conductive

bars could be plated or otherwise affixed to the terminal ends of the strip. This device was tried with various brushes. It was found that carbon brushes would deposit material on the face of the strip, producing a circle of low resistance and

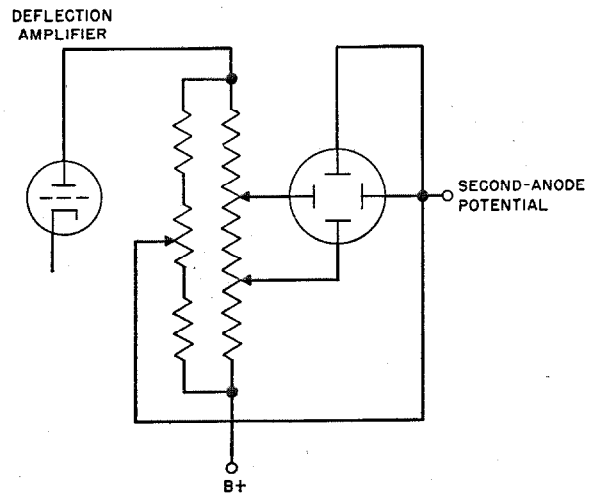

Fig. 8—Centering method used with simplified two-phase generator and tubes having two deflecting plates connected together internally.

distorting the resultant sweep on the cathode-ray tube. Small metallic brushes consisting of 0.002-inch-diameter tungsten wires were next tried. The resistive material proved so abrasive that the life of such brushes was a matter of hours.

Using either of the above resistive materials, it would be possible to wind a conducting wire around the entire block with the windings parallel to the desired equipotential planes. By cutting through each turn on the back of the strip, the resistance between the terminal ends is determined by the resistance of the material between the conducting wires, which serve only as commutating segments. Such a distributor was found to be satisfactory, provided the winding could be kept tight. Various clamping means were used, but fabrication was difficult and this design was abandoned.

Another form of the above design consists of winding a resistive wire on an insulating block. It is then unnecessary to cut the conductors because the resistance is determined by the length of the wire. The resistance between any two points on the same turn will be very small compared with the resistance between the ends of the

wire. Using 0.001-inch-diameter Nichrome wire, it was possible to wind a resistor card having adequate resistance for use as a vacuum-tube load. However, bare wire shorts very easily between turns. If insulated wire is used, it is necessary to remove the insulation over the path of the brushes. At the point where the wires are tangential to the circular path of the brushes, the wires are bare for a considerable distance and tend to short between turns. In addition, the brush material deposits between turns of the wire, reducing the resistance, and thereby causing distortion of the circular sweep.

To avoid these difficulties, the wires were covered after winding with a plastic insulating material, which would polymerize on baking. This insulating material was removed to permit brush contact with the conductors. Winding the resistance wire in one plane so that the insulation could be removed without disturbing the position or reducing the diameter of the wire posed a problem that was too difficult of solution and this method was abandoned.

The Formica Company supplied a laminated material made up of alternate layers of phenolic compound and thin copper sheet. A block of such material could be cut to form a commutating device with resistive material applied to one surface and the brushes in contact with the opposite side. Two difficulties presented themselves. First, brushes suitable for use with the copper segments were sufficiently abrasive to pick up the phenolic material, which adhered to them and eventually insulated the brush from the commutating segments. Second, the bond between the phenolic

material and the copper was not sufficiently good to allow the production of a mechanically rigid block without additional supports. The material tested was in experimental production only; if perfected, it may be useful for these distributing devices.

### 6. Final Model

A built-up commutator was designed which eventually proved to be successful. Fig. 9 shows the final model and the commutator assembly is shown in Fig. 10.

The commutator segments are punched from both conducting and insulating strips which are interleaved. The end bars and mounting rods are insulated from the commutator, insulating tubing being used over the mounting rods.

The whole assembly of laminations and two end bars is compressed between locking nuts on the ends of the mounting rods. This assembly is then installed in a jig and ground in a surface grinder so that the face to be in contact with the resistive material is plane and smooth. The resistive material is applied to a card which is placed in intimate contact with the conductive segments. The commutating assembly is then mounted on a base plate so as to compress a resilient backing pad and the resistive material between the base plate and the commutator. This assembly is then tested for contact and linearity of resistance with distance along the commutator.

The entire rotating assembly with the commutator in place is then installed in a jig and the commutator face is ground plane and smooth in the surface grinder. This is necessary because the pressure exerted by the resilient backing pad causes the commutator assembly to bow slightly. If this surface is not plane, the brushes will bounce in their holders. If the surface is not smooth, the brushes will wear and deposit brush material on the insulating segments of the commutator.

In most cases, the base plate is installed directly on

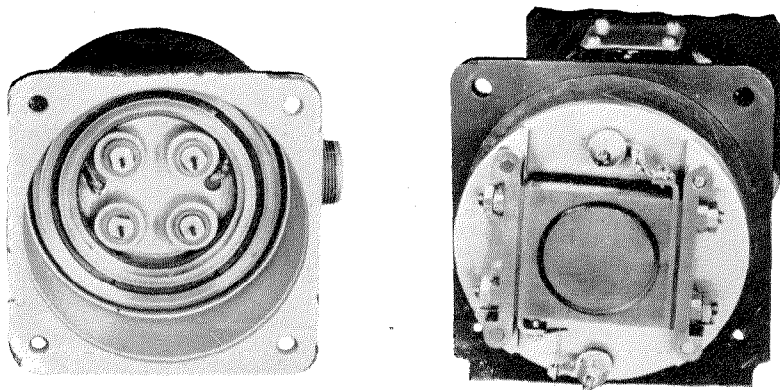

Fig. 9—Final design of commutator-type distributor. The two brushes on the commutator unit make contact with the slip rings on the brush-carrying assembly and provide a path for the input operating current.

the motor shaft. Motors have been procured having end bells machined for accurately positioning the brush holders with respect to the commutating surface. The rotating plate carries two brushes for supplying the current through the resistance strip. These brushes ride on concentric slip rings. This arrangement makes all the brushes contact their slip rings or commutators in the same plane and considerably simplifies the assembly procedure. The mounting means is indicated in the figures. The tandem assembly of a resistive distributor, motor, and goniometer is shown in Fig. 11.

## 6.1 DESIGN FACTORS

### 6.1.1 Vibration

It is necessary that the vibration of the entire assembly and its component parts be kept very small. This requires the surface of the commutator to be at right angles to the axis of the shaft within very close limits. In addition, each rotating assembly is dynamically balanced as a final constructional procedure.

### 6.1.2 Materials

The slip ring, brush, and commutator materials are chosen for low frictional resistance, low electrical resistance, long life, and reliability during life. This latter point has been one of the most difficult to achieve. A material, which gave good initial operation, often was found to be defective after a relatively short period of operation.

The problems of slip rings, brushes, and commutators have been so omnipresent during the entire history of the electrical age that one would think it should have been completely solved. However, one brush manufacturer stated that over 1800 different types of brushes were manufactured by his organization. The choice of the proper material seemed largely a "cut-and-try" proposition. Consequently, the problem received serious attention.

Commutator segments were made from the following materials: pure copper, phosphor bronze, beryllium copper, stainless steel, Monel metal, Nichrome, pure silver, coin silver, brass, bronze, and aluminum. Brushes in combination with each of the above materials have been tested as follows: graphite (20 different types), copper graph-

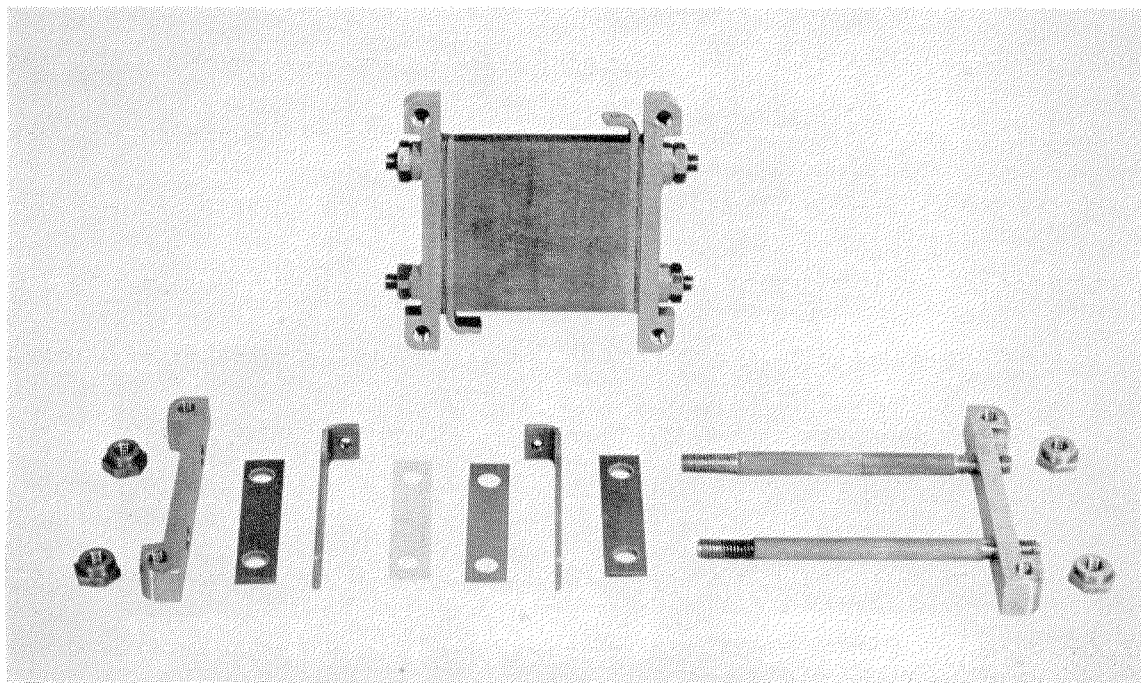

Fig. 10—Commutator assembly. Conducting and insulating laminations alternate. A resistive material makes contact with the conducting sheets on one side while the brushes bear on the other side.

ite, Paliny Number 7, silver graphite, Graphalloy, copper, brass, and Oilite. Insulating materials included: mica, polystyrene, Bakelite, acetate tape, and paper. Many of the above combinations gave devices that would operate more than

particular spring that it has become natural to speak of the assembly as a "brush."

The spring materials tested included: phosphor bronze, music wire, spring brass, stainless steel, and beryllium copper. Beryllium copper was

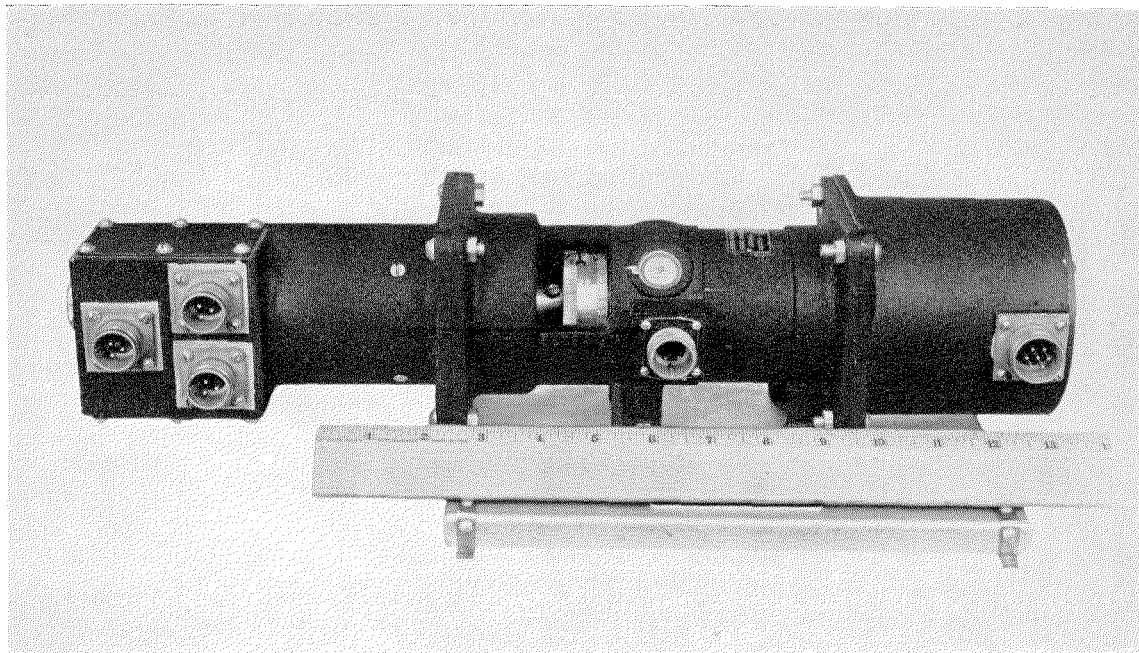

Fig. 11—Assembly of resistive distributor, motor, and goniometer.

1000 hours at 1800 revolutions per minute. The quality of operation was not altogether independent of life and many combinations having long life gave trouble until the brushes had "worn in" or they required cleaning at frequent intervals.

The combination eventually chosen consists of a commutator made of alternate layers of coin silver and acetate tape, each 0.005-inch thick. The slip rings are laminated copper and coin silver, silver being the contact surface. The brushes are of grade 411 Silver Graphalloy. With this construction, a number of distributors have operated for more than 1000 hours each without initial difficulties, cleaning, or any maintenance whatsoever. The life of brushes and commutator would appear to be very long.

### 6.1.3 Springs

Each brush type requires a specially designed spring. Indeed a brush is so closely allied with a

found to possess the most desirable spring characteristics. Correct pressure was determined in each case experimentally. Sufficient pressure to insure contact and yet light enough to prevent abrasion or carbon deposition was the goal.

When the commutator had been made plane so that the brushes did not bounce, and when proper brush and commutator materials had been found, it was relatively easy to find a beryllium-copper coil spring that gave excellent results. The springs used with the slip-ring brushes presented no particular problem.

## 7. Conclusion

The resistive distributor produced has a variety of uses. It can be used simply as a two-phase alternator of variable frequency. It can be mechanically synchronized with any rotating shaft. This is particularly valuable where extremely low frequencies are desired, where constant amplitude is required at variable low

frequencies, or where higher-order components or frequencies must be superposed on a basic wave.

It is possible to increase the number of phases simply by changing the machining of the casting that carries the brush holders or probes.

In practical use, the voltage across the strip is limited to 300 volts and no applications have been envisioned where the dissipation in the strip exceeds 5 watts. The resistance of the strip may be varied simply by changing the value of the resistance card. The lowest resistance that has been used is 1000 ohms and the highest, 500,000 ohms. The resistance of the load is de-

pendent on the resistance of the strip and the purity of the wave form desired. There is always a certain amount of commutator ripple, which may be removed by filtering. In most cases, where the voltages are applied to generate a circle in a cathode-ray tube, the ripple is not objectionable.

The device is particularly useful for the generation of two-phase voltages between zero and 20 cycles where, it seems, no other variable-frequency generators of constant output are available. It is also very useful where a distributor of this type is required to have long life at high rotational speeds.

---

### Passenger Telegram Service From Aircraft

Marking a milestone in the history of U. S. A. civil aviation, the Marine Division of Mackay Radio and Telegraph Company, in conjunction with American Overseas Airlines, has inaugurated a new communication service whereby plane passengers may send messages via radio-telegraph from aircraft in flight to any point in the world as well as to ships at sea.

For the present, handling of messages will be confined to transmission from air-to-ground only, with radio communications essential to the air-

craft in flight taking priority. Two-way service with American Overseas Airlines is expected to be available in the near future. All messages are now cleared through the Amagansett, Long Island, station of Mackay, which operates on a 24-hour schedule.

As American Overseas planes are staffed with two radio officers, no additional personnel will be required. The standard marine rate applies to these messages.

# Dimensional Analysis Applied to Very-High-Frequency Triodes\*

By GERARD LEHMANN

*Laboratoire Central de Télécommunications, Paris, France*

**D**IMENSIONAL analysis and the laws of similitude are of great service in the study of vacuum tubes. The principle of the method is briefly set forth. It is shown that the operation of similar tubes depends only on a single parameter  $\varphi = fd/V^{3/2}$ , in which  $f$  is the frequency,  $d$  a linear dimension of the tube, and  $V$  one voltage of the system. The efficiency, gain,  $Q$  factor under load, and other dimensionless parameters related to the operation of the tube, can be expressed as functions of  $\varphi$  alone,  $\varphi$  being proportional to the transit angle of the electrons. It is shown, further, that for tubes having the same types of cathodes, the products  $f^3d$  and  $f^4V$  must remain constant if unvarying efficiency is desired.

Recent improvements in the theory and construction of triodes have extended their utilization by two frequency octaves. A simplified analysis of the motions of electrons in a triode operating class  $B$  shows that the properties of a tube at low frequencies are maintained without any substantial deterioration up to values of  $\varphi$  close to 2.5, with  $\varphi = fd/V^{3/2}$ ,  $f$  being the frequency in megacycles per second,  $d$  the cathode-anode distance in centimeters, and  $V$  the anode voltage. For  $\varphi = 8$ , the gain falls to unity and oscillation efficiency becomes very low. For  $\varphi = 2.5$ , the  $Q$  under load of the output circuit is approximately 18. These results have been checked by experiments.

. . .

A few aspects of the theory of vacuum tubes used as very-high-frequency power generators will be contrasted with receiving amplifier tubes, which are not discussed. This problem raises many difficulties if a rigorous and complete solution is attempted, as the analysis must include the energy exchanges between circuits and electrons moving in electric fields, which vary rapidly over large amplitudes, and in the presence of space charges that are not negligible.

\* Reprinted from *L'Onde Electrique*, v. 26, pp. 175-187; May, 1946.

Dimensional analysis has been of great service in numerous technical fields for the study of phenomena not susceptible to complete analysis; it allows generalization of results of limited experiments and associates known theory with realizable experience. In the case of vacuum tubes, it provides knowledge useful not only to the designer of tubes, but also to those utilizing existing tubes.

## 1. Application of Dimensional Analysis

### 1.1 REVIEW OF PRINCIPLES

Satisfactory tubes and circuits exist for frequencies up to approximately 100 megacycles per second. Up to these frequencies, powers up to 100 kilowatts may be generated with efficiencies over 60 percent. A fruitful method of extending the frequency range consists in studying what happens with such tubes and circuits when they are used at higher and higher frequencies.

Such a study, called "dimensional analysis" or "mechanical similitude," has been used frequently and fruitfully in engineering. It has produced important results in hydraulics and aerodynamics, in developing theories of turbines and blowers, and in studies of ships and aircraft.

A brief outline follows of the main principle of the method; the reader may consult several treatises<sup>1-3</sup> for more complete information.

Any kind of apparatus is based on the application of a certain number of physical laws, each of which may be expressed as a mathematical relationship (generally differential) between a certain number of physical quantities.

One of these relationships is

$$f(G_1, G_2, \dots) = 0. \quad (1)$$

The  $G$ 's are physical quantities, each differing from the others.

<sup>1</sup> Villat, "Mécanique des Fluides," Gauthier-Villars, Paris, 1938.

<sup>2</sup> Monteil, "Ventilateurs, Soufflantes et Compresseurs centrifuges," Dunod, Paris, 1937.

<sup>3</sup> Riabouchinsky, "Sur Quelques Théorèmes d'Analyse Dimensionnelle," *Comptes rendus Hebdomadaires des Séances de l'Académie des Sciences*, v. 217, pp. 205-208; August 23 1943.



A physical law being a truth independent of the measurement system adopted to express the quantities involved, the mathematical character of function  $f$  is necessarily such that (1) is satisfied regardless of the system of units adopted; this is the principle of homogeneity.

The fundamental laws of mechanics show that, within the scope of this branch of science, we are free to choose arbitrarily units for measuring three quantities, the units for the measurement of any other quantity being then defined as functions of these three by the equations of mechanics.

The study of electricity introduces a fourth arbitrary quantity.

The quantities for which the units are arbitrarily chosen are called fundamental quantities, and any other unit is related to the fundamental units by a "dimensional equation," which is the basic equation defining the new quantity.

For example, if  $|L|$ ,  $|M|$ , and  $|T|$  are the fundamental quantities in mechanics, the dimensional equation for a force is

$$|F| = |M| \times |L| \times |T^{-2}|$$

from

$$F = m\gamma$$

and

$$\gamma = \frac{d^2A}{dt^2}$$

The choice of the fundamental quantities is entirely free so long as their number is observed. We shall use this property for writing dimensional equations with various fundamental quantities selected so as to simplify later reasonings and discussions. Thus, it is permissible to change the system of units without changing the meaning of an equation such as (1). For example, (1) may be stated as the relationship between factors  $P_1, P_2, P_3, \dots$

$$\varphi(P_1, P_2, P_3, \dots) = 0. \quad (2)$$

Each of the factors  $P$  is of the form

$$P = G_1^{\psi_1} \times G_2^{\psi_2} \times G_3^{\psi_3} + \dots$$

Then if the dimension of  $P$  is expressed by means of dimensional equations relating  $G$  to the fundamental quantities  $A, B, C$ , and  $D$ ,

$$P = A^\alpha \times B^\beta \times C^\gamma \times D^\delta,$$

and of necessity

$$\alpha = \beta = \gamma = \delta = 0.$$

In other words, any physical property can be expressed by means of a function  $\varphi$  of parameters  $P$ . The  $P$  parameters are *dimensionless numbers*, whose numerical values are unaffected by a change in the system of units. This theorem expresses only the coherence of the reasoning of theoretical physics and has, consequently, a great value of synthesis. One more step only has to be taken to apply it to the theory of similar systems.

Consider a physical system for which certain properties are defined by equations relating dimensionless numbers:

$$P_1, P_2, \dots, P_n.$$

Consider a second system whose corresponding dimensionless numbers are

$$P'_1, P'_2, \dots, P'_n.$$

If

$$P_1 = P'_1, P_2 = P'_2, \dots, P_n = P'_n,$$

the two systems are said to be similar with respect to the properties studied and all the corresponding equations are identical in pairs.

Any number such as  $Q = f(P_1, P_2, \dots, P_n)$  has the same value in two similar systems. If  $Q$  is a number that cannot be found theoretically, but can be obtained experimentally, the value of physical similarity is that a single experiment giving  $Q$  for one system also gives a knowledge of  $Q$  for the infinity of *all similar systems*. This method has considerable value either when direct experiment is impracticable as in the study of ships' hulls or in obtaining information of a general nature from a single experiment as in the case of turbines.

The method of similitude is powerful and in the theoretical field leads to very elegant proofs. However, any good geometrician knows that elegance is of value only in expert hands and wrong steps are all the easier as the reasoning is increasingly abridged. It should always be carefully ascertained that the use of similitude is justified for a particular study. It must be remembered that often physical properties exist that will not be included in the scope of systems that are similar in other respects. By way of example, consider two resonant cavities of similar geometry. Let  $K = |L_2|/|L_1|$  be the ratio of

similitude of the dimensions. What is the ratio of the resonant frequencies?

The electrical resonance of a cavity is a phenomenon determined by wave propagation and, in particular, by wave velocity  $C$ . Now the velocity  $C$  is constant for all cavities; giving the relationship

$$v = \frac{|L|}{|T|} = \text{constant.}$$

Thus

$$\frac{|T_2|}{|T_1|} = \frac{|L_2|}{|L_1|} = K \quad \text{or} \quad |f| = \frac{1}{|T|}.$$

This gives the well-known relationship between resonant frequency and geometrical dimensions.

$$\frac{f_2}{f_1} = \frac{|L_1|}{|L_2|} = \frac{1}{K}.$$

The voltage magnification factor  $Q$ , being a dimensionless number, might be considered to be the same for all cavities. This is not the case, even assuming all the cavities to be of the same metal, copper, for instance. In such a case, the metal constituting the walls of all cavities has the *same resistivity* but this experimental condition is outside the scope of our hypotheses on the similitude of cavities.

A study of this problem shows that  $Q$  is proportional to  $\lambda^{\frac{1}{2}}$ .

Despite the very real difficulties of this kind and the necessity for careful thinking, the method of similitude has shown itself very fruitful in the investigation of ultra-high-frequency power tubes, a theoretical analysis of which has not yet been made and which involve rather delicate experimental technics.

## 1.2 FUNDAMENTAL HYPOTHESES

The essential elements in one of the systems to be discussed are the cathode, empty space for the motion of electrons, and associated resonant cavities.

For a first simplified study, the following hypotheses and assumptions are made concerning these elements.

### 1.2.1 Cathode

The cathode consists of a metal surface whose chemical nature and temperature are such that the electron flow leaving it is *limited by space charge*. This condition is fulfilled for all current

densities  $A$  between zero and a fixed value called "maximum cathode emission." This maximum emission  $A$ , in amperes per square centimeter, is a characteristic of the type of cathode.

It is essential for the validity of the following calculations to assume that in no other point of the tube there exists an emissive surface obeying another law than space-charge limitation. This implies that no point of the cathode is saturated, and that there is no secondary emission at the points of impact of the primary electrons on an electrode.

### 1.2.2 Resonant Cavities

The resonant cavities are assumed to be made of copper. They thus have the properties discussed as examples in Section 1.1. The fact that these cavities are made of copper introduces conditions of primary importance relative to resistive losses.

This prevents the inclusion of oscillating cavities in a similitude system used for analysing electron ballistics in the tube. Accordingly, separate consideration must always be given to:

- A. Oscillating cavities, as being the seats of electric currents and resistive losses, and
- B. Empty space, which shall be called "tube," in which electrons move between electrodes made of a perfectly conducting material.

Only resistive losses appear in the *cavities*, and only losses by electron bombardment appear in the *tube*. This distinguishes between "tubes" and "circuits" for theoretical purposes.

This distinction can always be made, though in practice it constantly happens that a single surface element often belongs both to the tube and to the circuit. Nevertheless, this distinction is useful for understanding phenomena, for effecting calculations, and for separating losses.

Between tubes and oscillating cavities, relationships exist that are included under the title "coupling of electron beam with resonant cavities."

### 1.2.3 Empty Space in Which Electrons Move (Tube)

The electrons move freely in empty space within the tube under the action of existing fields. Their trajectories are from the cathode to a final electrode, called the anode from which there must be no secondary emission.

For the purposes of calculation, the following assumptions are made:

A. The effect of magnetic fields on the motion of electrons is negligible. This, for the time being, rules out the case of the magnetron. Similarly, the effect of the magnetic fields generated by the motion of the electrons themselves is neglected. These effects are small, numerically, and have been neglected also in the articles of Llewellyn and Brillouin.

B. The dimensions of the tube are sufficiently small with respect to wavelength to neglect the propagation time of the fields. In other words, the calculated potentials generated by the charges are assumed to differ negligibly from the actual retarded potentials.

C. The potential differences involved are large enough so that the effects of the initial velocities of the electrons are negligible. This assumes that the potentials used are, in general, larger than 10 volts.

D. The potential differences involved are small enough to make unnecessary a correction for relativity. This means that the electron potentials must not exceed 50,000 to 100,000 volts.

### 1.3 SIMILITUDE EQUATIONS FOR VACUUM TUBES

Two vacuum tubes may be considered to be similar and to oscillate in similar conditions when:

- A. Geometries of the two tubes are similar,
- B. Laws of variation of the currents and voltages with time are the same, the period being taken as a unit of time, and
- C. At corresponding instants of the cycle, the distribution patterns of the potentials inside the tube are similar.

Under such conditions, it is necessary only to write the homogeneous equations governing the tube operation to obtain very valuable information. There are three such equations.

Poisson's equation:

$$\Delta V = 4\pi\rho.$$

Equation for the motion of an electron in an electric field:

$$m\vec{\gamma} = e\vec{\mathcal{E}}.$$

Limiting condition at the surface of the cathode:

$$\vec{\mathcal{E}} \leq 0.$$

The fact that the electric field cannot be positive at the cathode surface expresses the hypothesis that the current emitted is limited by the space charge. This condition is independent of frequency.

The dimensionless products  $P$  of these equations, relative to various systems of fundamental

quantities, may then be formed. The theory of similitude states that for similar tubes, operating under similar oscillation conditions, these numbers  $P$  and any dimensionless number are the same.

#### 1.3.1 Choice of Fundamental Quantities

We shall choose as fundamental quantities those whose values are maintained constant by the very nature of the problem or whose variations can be fixed by the conditions of our study.

The first class involves the ratio  $e/m$ . In all vacuum tubes, only one kind of electrons move, and these have a constant ratio  $e/m$ . In all systems of fundamental quantities, we shall always choose  $|e/m|$ , which is a simple numerical constant, as a first quantity. This reduces to three the number of fundamental quantities whose units can be changed.

Current density  $|A|$  has a maximum value imposed by the physicochemical constitution of the cathode, and can thus be introduced in a simple manner.

The quantities whose value we are free to choose are:

$|L|$ , defining the dimensions of the tube, we shall designate by  $d$  to avoid any confusion with inductance;

$|f| = 1/|T|$ , defining the frequency of oscillation; the main parameter in our study;

$|V|$ , defining the scale of potentials inside the tube. With  $e/m$  and  $f$  common, there remain three fundamental systems:

$$\left. \begin{array}{l} \frac{e}{m} \quad f \quad d \quad V, \\ \frac{e}{m} \quad f \quad d \quad A, \\ \frac{e}{m} \quad f \quad A \quad V. \end{array} \right\} \quad (3)$$

#### 1.3.2 Poisson's Equation

In a vacuum where the electrons move, this equation is written

$$\Delta V = 4\pi\rho.$$

This equation, which defines the relationship be-

tween potentials and charges in the tube, can be written in dimensional notation as

$$Q = \frac{Vf}{Ad}, \quad (4)$$

$Q$  being the first dimensionless product. The relationship between the charge density per unit volume and the current density per unit area is

$$A = \rho \frac{dx}{dt}$$

or, in dimensional notation,

$$A = \rho \times d \times f.$$

Besides,  $\Delta V = V \cdot d^{-2}$ ; hence, substituting in Poisson's relationship, (4) is obtained.

It is useful to note that product  $Q$  is precisely the  $Q$  factor under load of the output cavity of the tube.  $A$  is proportional to the convection current of the electrons and, therefore, to the active current through this cavity.  $Vf/d$  is the current density through a capacitor, having a dielectric thickness  $d$ , under the action of a potential difference  $V$  at frequency  $f$ . But  $Q$  under load is the ratio of the reactive to the active current in the oscillating circuit.

Thus, any variation of  $Q$  in the operating conditions of a tube is accompanied by a proportional variation of  $Q$  factor under load, of the output cavity.

### 1.3.3 Equation of Motion

$$m\vec{\gamma} = e\vec{E}.$$

The equation of motion can be written immediately in dimensional notation as

$$\phi = \frac{m f^2 d^2}{e V}. \quad (5)$$

$V$  or  $d$  must be eliminated between (4) and (5) to obtain the dimensionless products corresponding to the systems of fundamental quantities in (3). Rewriting them according to (5), the following three relationships are obtained:

$$\phi = \frac{m f^2 d^2}{e V}, \quad (5)$$

$$\phi Q = \frac{m f^3 d}{e A}, \quad (6)$$

$$\phi Q^2 = \frac{m f^4 V}{e A^2}. \quad (7)$$

Finally, it is interesting to eliminate  $f$  between (4) and (5) so as to obtain a relationship giving the current density  $A$  independently of frequency. This relationship, which is independent of frequency, expresses the limiting conditions at the cathode surface.

$$\left. \begin{aligned} \frac{Q^2}{\phi} &= \frac{e}{m} \frac{V^3}{A^2 d^4} \\ \frac{Q}{\phi^{\frac{1}{2}}} &= \left(\frac{e}{m}\right)^{\frac{1}{2}} \frac{V^{\frac{3}{2}}}{A d^2} \end{aligned} \right\} \quad (8)$$

This is the Child-Langmuir relationship in its most general form and we may note that Langmuir<sup>4</sup> established it by means of dimensional analysis as early as 1913.

Relationships (5), (6), (7), and (8) contain considerable information, which we shall now try to express in a less subtle form.

We note, first, that  $e/m$  being an absolute constant, there are four parameters for describing the operating conditions of a tube:  $f$ ,  $d$ ,  $V$ , and  $A$ . Among these parameters there are three relationships: Poisson's equation (4), equation of motion (5), and, finally, the condition:  $\mathcal{E} = 0$  at the cathode surface, expressing the hypothesis that the emission is always limited by space charge.

Consequently, the problem depends on *only one independent variable*. This first piece of information simplifies considerably the study of a family of similar tubes. We have become accustomed in numerical applications to the use of the variable

$$\begin{aligned} \varphi &= \left(\frac{e}{m} \phi\right)^{\frac{1}{2}}, \\ \varphi &= \frac{fd}{V^{\frac{1}{2}}}, \end{aligned}$$

$f$  being the frequency in megacycles,  $d$  a dimension of the tube (the cathode-anode distance in a triode, for instance) expressed in centimeters, and  $V$  a voltage, such as the plate voltage, expressed in volts. The importance of this variable was pointed out in 1940 by Mr. Moisson at Les Laboratoires, Le Matériel Téléphonique, in Paris. In practical applications,  $\varphi$  varies between zero and a few units. It is easily determined that  $\varphi$  is proportional to the "transit angle" often used

<sup>4</sup> Langmuir, "The Effect of Space Charge and Residual Gas on Thermionic Current in High Vacuum," *Physical Review*, Series 2, v. 11, p. 450; December, 1913.

in the literature on this subject, though its exact definition is generally somewhat vague.

From the above considerations, the following results have been obtained in a family of tubes, geometrically similar, when the electrical oscillating conditions are similar:

A. The dimensionless products  $\phi$ ,  $Q$ , and their combinations have the same numerical values for all tubes of the family and for all operating conditions.

B. Any other dimensionless number expressing a property of the circuit within the scope of the hypotheses of similitude also has the same numerical value for all the tubes considered; such is the case, particularly, for the tube efficiency  $\eta$  and for the power-amplification factor  $G$ .

In other words, the  $Q$  factor under load,  $\eta$ , and  $G$  are single-valued functions of parameter  $\varphi$ . The same thing holds for  $\phi Q$  and  $\phi Q^2$ .

It is only necessary, therefore, experimentally or theoretically, to establish the relationships

$$Q = f_1(\varphi),$$

$$\eta = f_2(\varphi),$$

and

$$G = f_3(\varphi)$$

to be able to predict the values of these functions for any tube of the family at any voltage or frequency.

As already stated this increases considerably the extent of information acquired by a given experiment. Some practical applications of this theorem will be given to confirm the theory completely.

A consideration of the products  $\phi Q$  and  $\phi Q^2$  adds some useful information. For a constant value of  $\varphi$ , therefore of the efficiency  $\eta$ , the products

$$\phi Q = \frac{m f^3 d}{e A} \quad \text{and} \quad \phi Q^2 = \frac{m f^4 V}{e A^2}$$

are unchanged numerically.

If we assume all the tubes of the family have the same type of cathode, the value of maximum emission  $A$  is constant. Thus, to keep the efficiency constant,  $f^3 d$  and  $f^4 V$  must be kept constant.

This proves two propositions of major importance in the theory of tubes for very high frequencies. If it is desired to build similar tubes for operation at higher and higher frequencies  $f$  with a constant efficiency  $\eta$ , and if all the tubes have the same type of cathodes,

A. All the linear dimensions of the tubes must be reduced proportionally to  $1/f^3$ .

B. All the voltages applied to the tubes must be reduced proportionally to  $1/f^4$ .

These two theorems have particularly unfortunate consequences and indicate the difficulty of designing tubes for high frequencies. When a tube design approaches its limit of utilization, even a reduction to microscopic dimensions allows only small increases in frequency. Further, the power that can be generated vanishes abruptly in the neighborhood of the limiting frequency of the family because the linear dimensions vary as  $f^{-3}$  and the voltages as  $f^{-4}$ .

Because the areas of the tube decrease rapidly with linear dimensions, the power decreases between  $f^{-4}$  and  $f^{-10}$ . A complete expression of the factors  $\phi Q$ ,  $\phi Q^2$  also shows that a gain may be obtained for operation at extreme frequencies by an increase in cathode emission  $A$ . Improvement of cathodes is, consequently, an important means of extending the field of use of any type of tube except magnetrons at high frequencies.

Relationships (6) and (7) play an important part in the study of ultra-high-frequency tubes, and their complete meaning must be well understood to avoid experimental efforts whose uselessness can be foreseen.

#### 1.4 Q FACTOR, CIRCUIT LOSSES

In the above discussion, the tube alone has been considered, in contrast to the circuits. The resistive losses in the copper circuits must not be included in the scope of the laws of similitude used for the tube. Thus the term "tube efficiency" previously used must be understood as being the ratio of the power delivered by the tube to the circuit to the power delivered by the direct-current source. The only losses reducing efficiency are the losses by bombardment resulting from the residual velocity of the electrons at the time of their final impact. Resistive losses in the circuits have not yet been considered.

Obviously, these resistive losses are very important because, in general, we are interested not in the power delivered by the tube to the circuit, but in the power delivered by the circuit to the external load.

Here, again, dimensional analysis and (8) can give some information on the subject. Rewrite

(8) in the form

$$\frac{Q}{\varphi} = \frac{V^{\frac{3}{2}}}{Ad^2} \tag{9}$$

The above discussion showed that  $Q/\varphi$ , a dimensionless number, is a function of  $\varphi$  alone. It may also be shown that  $Q/\varphi$  is a constant, independent of  $\varphi$  for any value of  $\varphi$  between zero and a certain limit. When proving Langmuir's law for direct currents, i.e., for  $f=0$ , we find that

$$\frac{Q}{\varphi} = \frac{V^{\frac{3}{2}}}{Ad^2}$$

has a finite value, which is Langmuir's constant.

If the tube is oscillating at a frequency  $f$ , sufficiently low so that at any instant in the cycle the relationship between the instantaneous values of  $A$  and  $V$  are the same as for direct current,  $Q/\varphi$  has the same numerical value as for  $f=0$ . Such is the case so long as the transit angles are small and there is no appreciable difference between the actual velocity of the electrons, expressed in volts, and the value of their potential. When the frequency increases enough for the potentials to undergo important changes during the transit time of the electrons, the convection currents  $A$  have a tendency to decrease below the value calculated for the steady state, and  $Q/\varphi$  increases. The relationship between  $Q$  and  $\varphi$  is thus represented by a curve of the shape shown in Fig. 1.

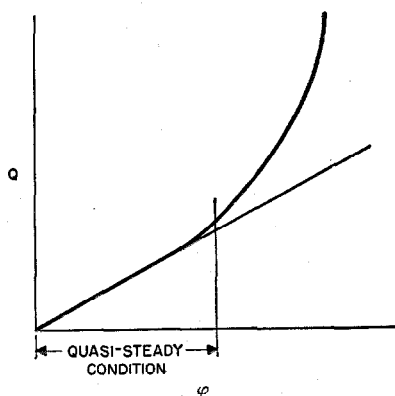

Fig. 1— $Q$  the voltage magnification factor of a loaded circuit is plotted against  $\varphi$ .

The result is that the  $Q$  under load of the output cavity of the tube increases more rapidly than  $\varphi$ . Now if  $Q_0$  is the  $Q$  of the output cavity in the unloaded condition, the efficiency of power

transfer from the tube to the load resistance is  $1 - Q/Q_0$ . For good efficiency,  $Q/Q_0$  must be kept small; otherwise an important fraction of the power is dissipated in resistive losses in the copper of the cavity.

To operate a tube with an increased  $\varphi$ , which is an easy method for increasing  $f$ , it is necessary to associate it with cavities having high  $Q_0$ 's in the unloaded condition. This stresses the necessity for a very thorough study of the resonant cavities associated with the tube. There is a practical limit to the  $Q_0$ 's that can be obtained with copper cavities. Moreover, the maximum value of  $Q_0$  decreases when the frequency increases.

For triodes, tetrodes, and klystrons in which all the energy is collected in a single output cavity, the resistive losses in the circuits are always almost of the same importance as the losses by bombardment inside the tube. It is necessary, therefore, for frequencies higher than 300 megacycles, to give the greatest attention to the practical design of the cavities and to limit the losses strictly to the unavoidable resistances of the copper.

Above a certain frequency, varying between 1000 and 3000 megacycles according to the type of tube, it becomes impossible to obtain good efficiency because of the chemical nature of the metal constituting the output circuit and of that of the emissive surface of the cathode.

There are only two possibilities of extending the frequency limit of vacuum tubes.

A. An increase in current density. This has been done in pulse tubes and explains the successes achieved in this field.

B. Use of multiple-cavity systems which increase considerably the frequencies at which the difficulties appear.

Point B will be considered later as it explains the enormous advantages shown experimentally by magnetrons.

To sum up, dimensional analysis has yielded the following information:

A. The results obtained with a family of similar tubes depend only on one parameter  $\varphi$ .

B. To increase  $f$ , while keeping  $\varphi$  at a reasonably low value,  $d$  and  $V$  must be decreased at a very rapid rate as their effect is proportional to  $1/f^n$ .

C. The increase of  $Q$  under load of the circuits limits the use of tubes with a high value of  $\varphi$ .

Fig. 6 shows curves of efficiency as a function of  $\phi$  for various triodes used as oscillators. These curves, from an article<sup>5</sup> published in 1945, are very incomplete because of a scarcity of available information.

## 2. Electron Transit Time in Triodes

Neglecting the diode, the triode is the oldest and simplest vacuum tube. It is formed of two spaces, the cathode-grid space and the grid-plate space. The cathode-grid space provides for modulation and the grid-plate space serves both for acceleration and output.

According to recent views, the tube is used by associating each of the two spaces with a resonant cavity which, as far as practicable, is a volume of revolution. Such an arrangement is quite different from the classical conception of a grid circuit and a plate circuit. However, the new conception is to be preferred for an analysis of the tube and circuits for very high frequencies.

Although, in the last few years, changes in construction of active electrodes have been very limited, considerable progress has been made in modifying the conductors connecting the electrodes to the rest of the circuits. Until recent years, the connectors were metal rods of small diameter passing through the glass as in the construction of incandescent lamps. The operation of the tube was based on the idea of "conducting wire"; this is completely obsolete for high frequencies.

The use of circular seals of copper or of a metal having a low temperature coefficient of expansion has made possible the insertion of triodes in revolution cavities. Powers and efficiencies obtained five or six years ago at a given frequency are obtained with this newer technic at frequencies four times greater. This is true for the entire scale of powers.

The smallest triodes now deliver a few deciwatts at 3000 megacycles compared to the same power obtained with acorn tubes at 700 megacycles. Recent tubes can deliver 100 kilowatts at 100 megacycles. Such power was not obtainable before the war above 25 megacycles. This considerable progress indicates the importance of investigating the principles that made it possible.

<sup>5</sup> Lehmann and Vallarino, "Study of Ultra-High-Frequency Tubes by Dimensional Analysis," *Proceedings of the I.R.E.*, v. 33, pp. 663-665; October, 1945.

## 2.1 MODULATION SPACE

The cathode-grid space is subjected to an alternating field on which an unvarying direct-current field is sometimes superimposed.

When the unvarying field is zero, class-*B* modulation occurs and this operation is very often used for generating high frequencies. The superposition of a retarding unvarying field leads to class-*C* modulation. Class *A* is not used when high efficiencies are desired.

In class-*B* operation, the field in the modulation space is purely alternating. During the positive half-cycle, emission takes place at the cathode; during the negative half cycle there is no emission and the field at the surface of the cathode is negative.

A general study of the phenomena involved has not yet been published. Llewellyn's calculations, limited to class *A* and to small amplitudes, do not apply. A first attempt by Wang<sup>6</sup> indicated the principle of a method of diagramming electron motions. A more-recent article by Brillouin<sup>7</sup> yielded very interesting results, but cannot be used at the highest practical frequencies.

### 2.1.1 Quasi-Steady State

The value of current emitted per square centimeter of cathode area is given by Langmuir's equation

$$A = 2.33 \cdot 10^{-6} \frac{V^{\frac{3}{2}}}{d^2}.$$

$V$  is the alternating potential of the grid,  $d$  is the cathode-grid distance, and  $V = V_E \sin \omega t$ .

The desired output modulation is thus produced. But, further, the electrons reaching the grid have a variable velocity corresponding to the variable grid potential. The superimposition of these two modulations gives rise to a large power consumption at the modulation source. This power can easily be calculated

$$dw = A V dt = 2.33 \cdot 10^{-6} \frac{V_E^{\frac{3}{2}}}{d^2} \sin^{\frac{5}{2}} \omega t dt.$$

<sup>6</sup> Wang, "Large-Signal High-Frequency Electronics of Thermionic Vacuum Tubes," *Proceedings of the I.R.E.*, v. 29, pp. 200-213; April, 1941.

<sup>7</sup> Brillouin, "Transit Time and Space-Charge in a Plane Diode," *Electrical Communication*, v. 22, n. 2, pp. 110-123; 1944.

Whence

$$W = 2.33 \cdot 10^{-6} \frac{V_E^{5/2}}{d^2} \cdot \frac{1}{\pi} \int_0^\pi \sin^{5/2} \theta \, d\theta,$$

or, finally, after integration, in watts per square centimeter

$$W = 10^{-6} \frac{V_E^{5/2}}{d^2}, \text{ approximately.}$$

This is a somewhat academic expression, assuming that the tube has a perfect theoretical cathode. It is very important to note that the excitation power is the power necessary for exciting an inverted amplifier; as the source of excitation, which establishes the potential difference between cathode and grid, has to deliver the total cathode current.

We finally reach the conclusion that the normal mode of excitation of a triode is between cathode and grid, with the considerable concomitant power absorption. This results from the conception of a cavity, by virtue of which the phenomena in the grid-plate cavity are independent of the phenomena in the cathode-grid cavity. These two are completely separated by the grid, except for the cathode-plate capacitance  $C$ , the effects of which will be studied elsewhere. Of course, all the energy delivered by the source of excitation to the modulation space exists as kinetic energy in the electrons at their exit from this space. At that moment, the electrons going through the grid enter the output space and the energy of excitation they bring with them will have to be included in the energy balance for this space. Limiting ourselves to the quasi-steady state, two main cases are of immediate interest.

First case: There is no alternating voltage in the output space  $V_o = 0$ . In such a case, no exchange of high-frequency energy can take place in this region, and  $W_P = W_B + W_E$ , where  $W_P$  is the power dissipated by bombardment,  $W_B$  is the power delivered by the direct-current source of acceleration, and  $W_E$  is the power of excitation. The excitation power is lost completely and exclusively by bombardment of the anode.

Second case: There exists in the output space an alternating voltage such that the plate is brought to a constant direct voltage  $V_B$  with

respect to the cathode; this condition may be written

$$V_o = -V_E,$$

$V_o$  being the useful oscillating voltage and  $V_E$  the oscillating excitation voltage.

In this case, the electrons reach the anode with a constant velocity corresponding to  $V_B$  and the power dissipated is only that delivered by the acceleration source.

$$W_P = W_B = I_B \cdot V_B.$$

We thus have, in this case,  $W_o = -W_E$ .

In the output space, power equal to that delivered to the modulation space is collected. At low and medium frequencies, a circuit arrangement called "grid excitation" permits the power developed in the output space to return to the modulation circuit. Consequently, the power dissipated by excitation is zero; this is the result of compensation (often involuntary), through the use of positive feedback, the existence of which is shown by analysis from the ultra-high-frequency viewpoint. In many cases, when the transit times are not infinitely small, this compensation does not take place, a phenomenon difficult to interpret by other theories. The compensation circuit is shown in Fig. 2. A careful

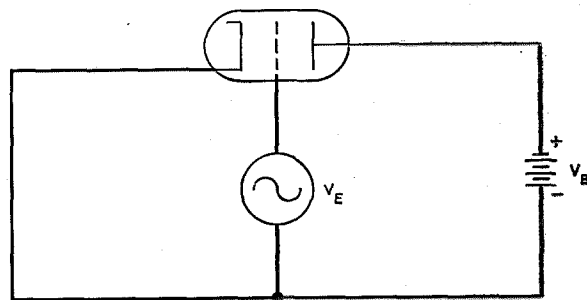

Fig. 2—This circuit arrangement, commonly used at medium and low frequencies, provides an inherent positive feedback that reduces the power required for excitation.

examination of these views with a frankly critical mind concerning the conceptions generally used at medium frequencies is recommended.

Fig. 2 shows that the grid-cathode circuit is completed through a wire that is also part of the output circuit. The impedance of this connection constitutes the positive feedback path that



vanishes if a two-cavity circuit is employed as in Fig. 3. The ultra-high-frequency technique requires the use of cavities, and wire circuits are completely ignored. Normal excitation between cathode and grid will, therefore, always include

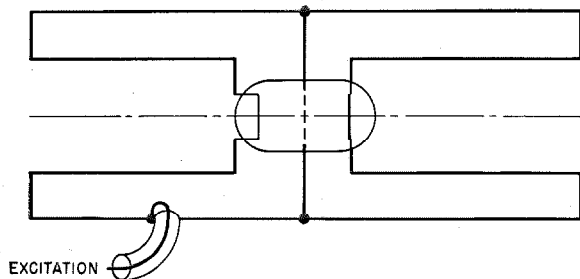

Fig. 3—Circuit employed at high frequencies. Resonant cavities for the cathode-grid and grid-anode spaces eliminate the positive feedback which characterizes the circuit of Fig. 2.

the corresponding power consumption. In some circuits, specially designed for high frequencies, a reduction of apparent excitation power is obtained by appropriate feedback.

### 2.1.2 Transit Angles Not Negligible

No complete solution<sup>6,7</sup> of the problem has been given for the case where the transit angle is not negligible.

To obtain in a simple manner a qualitative indication of the phenomena involved, consider class-B operation but neglect space charge. This assumption is not justified but it is useful for an understanding of the phenomena. The numerical coefficients obtained, it is true, are fairly different from the exact values.

Let  $\theta = 2\pi t/T$  be a variable representing time. A given electron is characterized by angle  $\theta = \tau$  corresponding to the time when it leaves the cathode with a zero velocity.

$\theta$  being the independent variable and  $x$  the ordinate as measured from the cathode,  $\tau$  is the parameter characteristic of an electron.

We shall calculate the law of motion of the electrons assuming a fixed value for the alternating field

$$\mathcal{E}_E = \frac{V_E}{d}$$

The differential equation for the motion is

$$m \frac{d^2x}{dt^2} = e\mathcal{E}_E \sin \omega t.$$

Integrating twice and writing  $v=0$  and  $x=0$  for  $\tau=0$ , we obtain:

$$v = \frac{e}{m} \frac{\mathcal{E}_E}{\omega} (\cos \tau - \cos \theta),$$

$$x = \frac{e}{m} \frac{\mathcal{E}_E}{\omega^2} [\sin \tau - \sin \theta + (\theta - \tau) \cos \tau].$$

This equation can be represented by a single graph, which can be used in all possible cases, by writing

$$\frac{x}{d} = \frac{e}{m} \frac{V_E}{4\pi^2 f^2 d^2} [\sin \tau - \sin \theta + (\theta - \tau) \cos \tau].$$

Let

$$\varphi_E = \frac{fd}{V_E^{1/2}}.$$

If  $f$  is expressed in megacycles,  $d$  in centimeters, and  $V_E$  in volts, we have

$$\left(\frac{2e}{m}\right)^{1/2} = 6 \cdot 10^7$$

whence

$$\varphi_E^2 \frac{x}{d} = 45 [\sin \tau - \sin \theta + (\theta - \tau) \cos \tau]. \quad (10)$$

Fig. 4 shows the corresponding curves  $y = f(\theta, \tau)$  letting

$$y = \varphi_E^2 \frac{x}{d}.$$

These curves may be used as follows.

Axis  $0\theta$  represents the cathode. After selecting the value of  $\varphi_E$  to be studied, a horizontal line  $y = \varphi_E^2$  is drawn. This corresponds to  $x/d = 1$  and represents the grid.

The portion of the diagram under this horizontal line represents the motion of the electrons between cathode and grid. The following essential points are to be noted.

The electrons emitted between  $\tau = 0$  and  $\tau = \pi/2$  never fall back on the cathode. They always reach the grid. If  $\varphi_E < 9.5$ , they reach the grid during the cycle in which they have been emitted; if  $\varphi_E > 9.5$ , they may oscillate in the cathode-grid space during several cycles. Obviously, this phenomenon is very troublesome and it seems that

$\varphi_E = 9.5$  constitutes the maximum practical value.

The electrons emitted between  $\pi/2$  and  $\pi$  reach the grid during the first cycle or fall back on the cathode, increasing its temperature by bombardment. It will be noticed that if  $\varphi_E < 9.5$ , the angle during which the electrons go through the grid is smaller than  $\pi$ . The effect of transit time is, thus:

- A. To change operating conditions from class B to class C.
- B. To cause a fraction of the emitted electrons to fall back on the cathode; this fraction may be as much as 50 percent.

The more rigorous study of Brillouin leads to the same conclusions.

Thus, the effect of transit time in the modulation space is:

- A. It cannot, in itself, explain a lowering of the efficiency  $\eta$  of the tube if  $\varphi_E < 9.5$ .
- B. It explains perfectly a decrease of the power gain  $G$ .

These conclusions are very important and seem to be confirmed experimentally.

Finally, take  $\varphi_E = 9.5$  as an extreme limit for the operation of the modulation space. Let us calculate  $\varphi_E$  for the case where 10 percent of the

total number of emitted electrons fall back on the cathode. The usual assumption is made that the electron flow obeys a sinusoidal law

$$n = n_0 \sin \omega t.$$

90 percent of the electrons pass before electron  $\tau_{90}$  such that

$$\int_0^{\tau_{90}} \sin \theta \, d\theta = 2 \times 0.9,$$

which gives  $\tau_{90} = 145$  degrees.

This electron,  $\tau = 145$  degrees, must be the last one to go through the grid; for this to happen, it must reach the grid with a velocity  $v = 0$ ; now we have  $v = 0$  for  $\cos \theta = \cos \tau$ , which gives  $\theta = 215$  degrees. Substituting these values for  $\theta$  and  $\tau$  in (10), and with  $x = d$ ,

$$\begin{aligned} \varphi_E^2 &= 45 \times 0.17 = 7.65, \\ \varphi_E &= 2.76. \end{aligned}$$

To sum up, for  $0 < \varphi_E < 2.76$  the quasi-steady state exists. For  $2.76 < \varphi_E < 9.5$ , operation is possible in the very-high-frequency regions and for  $\varphi_E > 9.5$ , the modulation space is useless for the production of power.

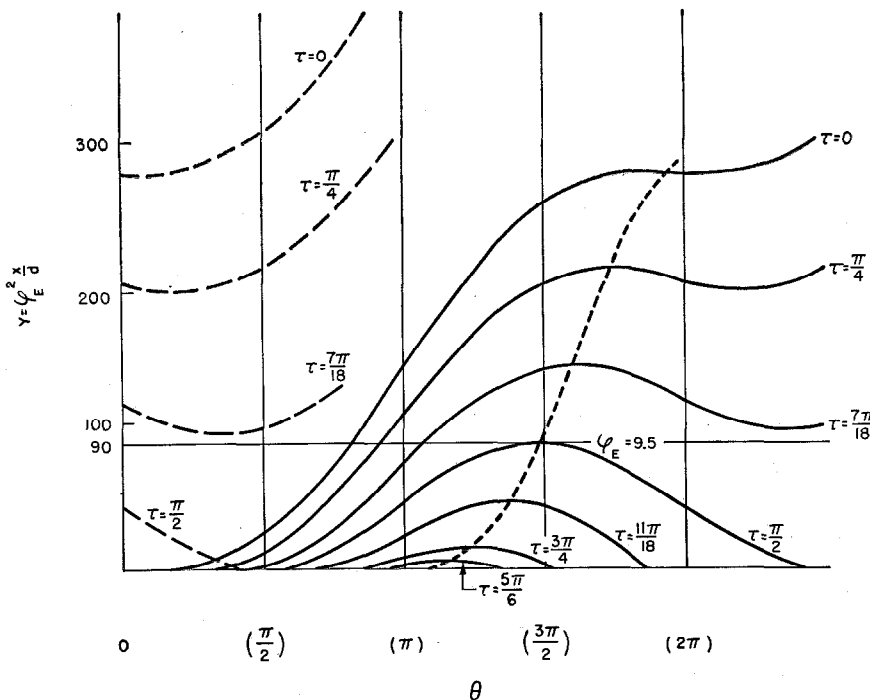

Fig. 4—Curves of  $y$  plotted against  $\theta$ .

### 2.1.3 Space Charges

Llewellyn has shown that in the quasi-steady state the space charge in the neighborhood of the cathode increases by exactly 50 percent the transit time calculated with no space charge.

Thus, the phenomena remain substantially unchanged, provided we multiply the  $\varphi$ 's by  $\frac{2}{3}$ . This approximation is open to criticism and we hope that a more complete theory and a graph, similar to Fig. 4 but with space charge, will be presented shortly. It would be most useful.

Contenting ourselves with multiplying the  $\varphi$ 's by  $\frac{2}{3}$ , we finally conclude:

$$\begin{aligned} 0 < \varphi_E < 1.84 &= \text{quasi-steady state,} \\ 1.84 < \varphi_E < 6.3 &= \text{high frequencies} \\ \varphi_E > 6.3 &= \text{unusable.} \end{aligned}$$

$\varphi_E$  is the particular  $\varphi$  adopted for the modulation space of the triode. Later on, we shall relate it to the number  $\varphi$  used for the whole tube.

## 2.2 OUTPUT SPACE

In addition to serving as an output space, this region provides room for acceleration. The field in this region results from the superposition of an unvarying field established by the accelerating source  $V_B$  and an alternating field created by the output source  $V_O$ . As  $V_B$  and  $V_O$  are of the same order of magnitude, the electron flow is a maximum at the instant the resulting potential difference  $V_B + V_O$  is close to zero. Consequently, the electrons go through this space with the substantially constant velocity they acquired in the modulation space. This velocity is necessarily small, and constitutes the major drawback of the triode as an ultra-high-frequency generator.

### 2.2.1 Quasi-Steady State

In the quasi-steady state, the conditions under which ultra-high-frequency triodes are most commonly used are as follows:

A. Class-B operation.

B. At the time of the cycle when the electron output is maximum, the cathode is brought to a potential  $-0.1V_B$  with respect to the grid; the grid-anode potential difference is lowered to zero (Fig. 5), which amounts to choosing  $V_B = V_O$  in absolute value.

A first consequence of this potential distribution is to impose a relationship between the distances  $d_{FG}$  and  $d_{GA}$  in the tube. Referring to the article by Fay, Samuel and Shakley<sup>8</sup> on the effect of space charge between grid and plate, if with respect to the cathode,  $V_{FG} = V_{FA}$ , i.e.,  $V_{GA} = 0$ , we cannot have

$$\frac{d_{GA}}{d_{FG}} > 2(2)^{\frac{1}{2}}.$$

<sup>8</sup> Fay, Samuel, and Shakley, "On the Theory of Space Charge Between Parallel Plane Electrodes," *Bell System Technical Journal*, v. 17, pp. 49-79; January, 1938.

If distance  $d_{GA}$  is greater than  $2(2)^{\frac{1}{2}}d_{FG}$ , a virtual cathode is formed between the grid and plate and part of the electrons are reflected to the grid. This condition is verified experimentally on triodes comprising a cathode with an equipotential sur-

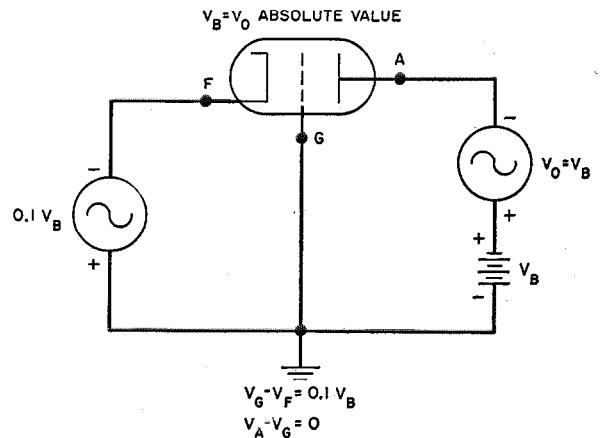

Fig. 5—Quasi-steady-state conditions under which triodes are commonly used at ultra-high frequencies.

face and a practically plane structure. The grid-anode distance may be larger if we use a filamentary cathode or a cylindrical structure of small radius. In practice, in most of the ultra-high-frequency triodes  $d_{GA} = 3d_{FG}$ ; we shall assume this condition to be fulfilled.

Let us consider the values of the transit angles in the output space at peak current for these conditions.

$$\begin{aligned} V_{FG} &= V_{AF} = 0.1V_B. \\ d_{GA} &= 3d_{FG}. \end{aligned}$$

Assume the velocity of the electrons to be constant between the grid and plate and equal to

$$v = \left(\frac{2e}{m}\right)^{\frac{1}{2}} (0.1V_B)^{\frac{1}{2}}.$$

Under these conditions, the transit angle of the electrons, corresponding to the current peak in the output space, is

$$\theta_0 = 2\pi f \frac{d_{GA}}{(0.1V_B)^{\frac{1}{2}} \left(\frac{m}{2e}\right)^{\frac{1}{2}}}.$$

Now

$$\begin{aligned} \left(\frac{2e}{m}\right)^{\frac{1}{2}} &= 6 \cdot 10^7, \\ d_{GA} &= 3d_{FG}; \end{aligned}$$

therefore:

$$\theta_0 = \frac{2\pi}{60} 3\varphi_E$$

or

$$\theta_0 = 0.3\varphi_E, \text{ approximately.}$$

It was shown that the limit of the quasi-steady-state region in the modulation space corresponds to  $\varphi_E = 1.84$  or  $\theta_0 = 0.56$  radian, 32 degrees, which also corresponds to the limit for the quasi-steady state in the output space. (On this subject, see Warnecke and Bernier.<sup>9</sup>) The fact that the limits for the quasi-steady state is reached simultaneously in the two spaces shows that the conditions of use selected are rational and explains their choice.

We can also note that

$$\varphi_0 = \frac{fd_{GA}}{V_B^{1/2}} = \frac{3}{10^{1/2}} \frac{fd_{FG}}{V_E^{1/2}} \neq \varphi_E$$

and  $\varphi_0 = \varphi_E$  in a triode tube.

### 2.2.2 $\varphi$ Coefficient

In practice, the  $\varphi$  coefficient of a triode has been evaluated in the following manner.

$$\varphi = \frac{fd_{FA}}{V_B^{1/2}}$$

where

- $f$  = frequency in megacycles
- $d_{FA}$  = cathode-anode distance in centimeters
- $V_B$  = plate volts.

This can be written

$$\varphi = \frac{f(d_{FG} + d_{GA})}{(10V_E)^{1/2}} = \frac{4}{10^{1/2}} \varphi_E,$$

$$\varphi_T = 1.26\varphi_E.$$

The limit of the quasi-steady state is thus reached for  $\varphi = 1.26 \times 1.84$  or  $\varphi = 2.3$ .

A long experimentation has shown that it is possible, if the circuits are correctly designed, to keep the same values for  $\eta$  (efficiency) and  $G$  (power gain) obtained for medium high frequencies, for any value of  $\varphi$  up to about  $\varphi = 2.5$ .

This constitutes an excellent experimental proof of the above theory which, despite its lack of fine detail, has a substantial practical value.

<sup>9</sup> Warnecke and Bernier, "Contribution à la Théorie des Tubes à Modulation de Vitesse," *Revue Générale de l'Electricité*, January and February, 1942.

Let us now calculate the voltage magnification factor under load  $Q$  for the output space. This plays a prominent part in television.

The reactive current through the output circuit is

$$A' = \omega VC_{GA}$$

$$= 10^{-6} \frac{fV_B}{d_{GA}}$$

$$= 1.33 \cdot 10^{-6} \frac{fV}{d_{FA}}$$

Assuming that the total circuit capacitance is *twice* the capacitance of the active elements of the tube, if

$$\varphi = \frac{fd}{V^{1/2}},$$

$$A' = \varphi \cdot 1.33 \cdot 10^{-6} \frac{V_B^{3/2}}{d_{FA}^2}.$$

Let us now calculate the active component of the electron current. The peak current emitted by the cathode is

$$A = 2.33 \cdot 10^{-6} \frac{(0.1V_B)^{3/2}}{(0.25d_{FA})^2},$$

$$= 2.33 \times 16 \times 0.03 \times 10^{-6} \times \frac{V_B^{3/2}}{d_{FA}^2},$$

$$= \frac{V_B^{3/2}}{d^2} \cdot 10^{-6}, \text{ approximately.}$$

We obtain the value of the fundamental component  $A_{fund}$  by multiplying by  $\frac{3}{4}$  to account for the current collected by the grid and by the coefficient  $\frac{1}{2}$  for the development in a Fourier series for class *B*. Whence,

$$A_{fund} = 0.37 \frac{V_B^{3/2}}{d^2} 10^{-6}.$$

Substituting the value for  $A'$ , we get

$$\frac{V_B^{1/2}}{d^2} = A_{fund} \times 2.66 \times 10^{-6},$$

whence

$$A' = A\varphi \times 1.33 \times 2.66,$$

whence

$$Q = 3.55\varphi.$$

$Q$  and  $\varphi$  are proportional as foreseen in Section 1.4.

This relationship gives the lowest value for  $Q$  that can possibly be expected for a triode operating at normal efficiency. This relationship is

valid for the quasi-steady states up to  $\phi = 2.5$  and  $Q = 9$ .

When using triodes with glass bulbs and circuits *outside* the tube, the total capacitance reaches four times the capacitance of the active elements, which doubles the above value and gives  $Q = 7.1\phi$ , whence  $Q = 18$  for  $\phi = 2.5$ .

This is a fundamental relationship in the technique of modern wide-band television transmitters operating at very high frequencies.

2.2.3 Transit Angles Not Negligible

Cases where transit angles are no longer negligible correspond to values of  $\phi_B$  between 1.84 and 6.3;  $\phi$  then varies from 2.32 to 8, and the transit angle in the output space varies from 32 to 110 degrees. This value of 110 degrees, which was calculated without taking into account the space charge, is a high value, but it is still lower than 180 degrees for which the efficiency of the output space is still appreciable.

This shows that the amplification of a triode  $G$  decreases much more rapidly than the efficiency. This has also been confirmed by experiment.

Of course, when  $G = 1$ , interest in the tube as an amplifier vanishes completely and the power it can deliver as an oscillator drops to zero. We do not know exactly the value of  $\phi$  corresponding to such a case. For  $\phi = 8$ , certain triode oscillators

still have an efficiency of 5 to 10 percent, which is outside the field in which we are interested. Table I shows relations of  $\phi$ ,  $Q$ , and general operating conditions;

$$\phi = \frac{fd}{V^{3/2}} \quad \text{and} \quad Q = \frac{f}{\Delta f},$$

where

$f$  = frequency in megacycles,

$d$  = filament-anode distance in centimeters,

$V$  = plate volts,

$\Delta f$  = total bandwidth in megacycles.

TABLE I

OPERATION OF TRIODES AT VERY HIGH FREQUENCIES

$\phi$	$Q$	Remarks
0	0	Quasi-steady state. Results similar to those obtained at low frequencies.
2.5	18	
2.5	18	Important transit times. Power gain drops rapidly. Output drops slowly.
8	above 60	

A complete study of the dimensioning of triodes would be beyond the scope of the present study.

It will be realized easily that it is possible to determine completely all the dimensions and operating conditions for the optimum case of a triode oscillating at a frequency  $f$ .

If we are dealing with a pulsed tube or if  $f$  is above 600 megacycles, the maximum emission is the dominant factor in computing the dimensions.

If we are dealing with a continuous-wave tube operating at a frequency lower than 600 megacycles, the maximum dissipation per unit surface is the dominant factor. It is then possible to calculate for each frequency the most favorable distances between electrodes, plate voltage  $V_B$ , cathode emission  $A$ , pass band  $\Delta f$ , etc.

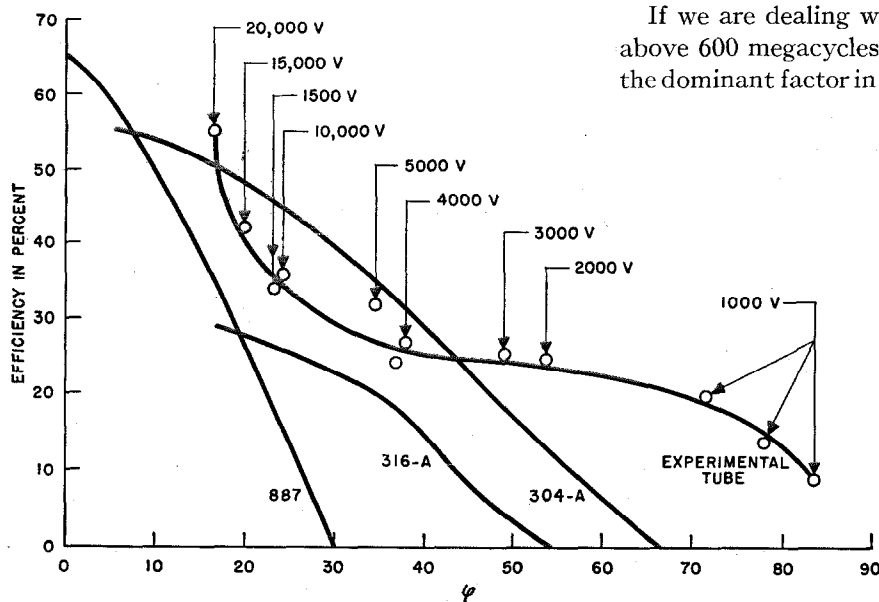

Fig. 6—Efficiency plotted against  $\phi$  for three prewar triodes and an experimental tube.

The total area of the tube is not controlled by the above calculations, and may be adjusted to the total power required; its design is influenced greatly by the mechanical conditions of the construction and by the stiffness of the elements.

Fig. 6 shows curves of efficiency as an oscillator of three prewar types and one experimental tube. It is interesting to note the accuracy with which the points relative to the latter tube are located on a single curve, despite the extreme values of the voltages used.

### 3. Conclusion

It is a known fact that it is often difficult to determine whether unsatisfactory operation is attributable to the tube or the circuit. Dimensional analysis has contributed to the solution of this problem, and despite the lack of refinement of the theory and the unsubstantial nature of certain hypotheses, the results are far from being useless.

New types of triodes<sup>10</sup> have been developed, which are useful in the construction of high-definition color-television transmitters<sup>11</sup> delivering 1 kilowatt on a wavelength of 0.6 meter with a modulation band extending to 10 megacycles,

<sup>10</sup> Frankel, Glauber, and Wallenstein, "Medium-Power Triode for 600 Megacycles," *Proceedings of the I.R.E.*, v. 34, pp. 986-991; December, 1946; also *Electrical Communication*, v. 24, pp. 179-191; June, 1947.

<sup>11</sup> Young, "Color-Television Transmitter for 490 Megacycles," *Electrical Communication*, v. 23, pp. 406-414; December, 1946.

and of frequency-modulated broadcast transmitters producing 100 kilowatts at 3 meters. To obtain such results, circuits of a new type must be used.

### 4. Acknowledgment

The use of dimensional analysis for the study of tubes has been the object of unpublished memoranda by Messrs. Goudet and Boggs. I also want to thank for their assistance in this work, my colleagues at Federal Telecommunication Laboratories and, more particularly, Messrs. Emile Labin and A. R. Vallarino.

### 5. Additional References

12. Llewellyn, "Electron Inertia Effects," Cambridge University Press, Cambridge, 1939.
13. Llewellyn and Peterson, "Vacuum-Tube Networks," *Proceedings of the I.R.E.*, v. 32, pp. 144-166; March, 1944.
14. Black and Morton, "Current and Power in Velocity-Modulation Tubes," *Proceedings of the I.R.E.*, v. 32, pp. 477-482; August, 1944.
15. Warnecke, "Sur Quelques Conceptions Nouvelles de la Physique et de la Technique des Tubes Emetteurs pour les Fréquences très Elevées," *Annales de la Radio-Diffusion*, v. 4, pp. 21-57; January, 1944.
16. Clavier, "Sur l'Influence du Temps de Transit des Electrons dans les Tubes à Vide," *L'Onde Electrique*, v. 16, pp. 145-149; March, 1937.
17. Clavier, "Sur l'Influence du Temps de Transit des Electrons dans les Tubes à Vide," *Bulletin de la Société Française des Electriciens*, v. 9, pp. 79-110; January, 1939.

# Flashing Signal for Railway Crossings

By V. C. MEEUWS

*Bell Telephone Manufacturing Company, Antwerp, Belgium*

**R**AILWAY CROSSINGS in Belgium, as in many other European countries, are commonly protected by gates operated by signalmen. The considerable increase in automobile and other road traffic and the expansion of the highway network have made desirable the replacement of the manually operated gates by signals that are controlled automatically.

Red and green lights are employed to control the traffic over highways that cross the railroad. In addition, an audible warning is given by an electric gong when a train approaches. The red light flashes at a rate of 80 times per minute and the green light flashes at 40 times per minute.

## 1. Flashing Mechanisms

Various types of circuit interrupters have been developed for flashing these lamps. The service is rather heavy and where mechanical interruption is used, trouble with electrical contacts has been encountered. The failure of the interrupter would bring about a hazardous condition and serious accidents might easily result. In addition, maintenance costs of such equipment are not insignificant. Consequently, the problem of flashing these lamps by nonmechanical means has been given careful attention.

The problem, in general, is to flash two, three, or four signal lamps, each of 60 watts rating, at 80 or 40 pulses per minute. The lamps are normally operated from the 130-volt alternating-current supply. If one or more lamps go out of service, the remaining lamps must continue to flash. The "On" and "Off" times are to be approximately equal. The control circuit should, so far as possible, be common to both the red and green lamps.

## 2. Electric Flasher

In Fig. 1, the current flowing through the lamp is in part controlled by the inductance of the two windings,  $W1$  and  $W4$ . When the power is applied

to the circuit, the inductance, and hence the impedance, of  $W1$  is so high that the lamp fails to light. Rectifier 1, which is connected across the power supply, applies a direct voltage to the capacitor  $C$  through  $R1$  and  $W2$ . As the capacitor charges, the voltage across it increases until it is high enough to ignite the gaseous discharge lamp shunted across  $C$  and  $W2$ . This discharges the capacitor until the voltage across it is too low to maintain the gaseous discharge. The cycle then repeats and its frequency may be controlled by varying either  $C$  or  $R1$ . This is the well-known relaxation oscillator.

Only a small amount of energy is available from the relaxation oscillator to produce a magnetic field in the iron core on which the three windings are mounted. The function of the magnetic field is to reduce the inductance and impedance of the winding  $W1$  to allow an increased current to flow through the signal lamp. Fortunately, the energy required is not directly related to that taken by the signal lamps but may be very much less. The frequency at which the oscillations occur is significant as more energy is required to change the magnetic field as the frequency is increased. This is a limitation on the control possible with a given gaseous discharge tube. To stabilize the control and increase the effective power range of operation, use is made of the two windings,  $W3$  and  $W4$ , and rectifier 2.

When  $C$  discharges through  $W2$  and the gaseous tube, the inductance of  $W1$  decreases and the current through  $W4$  and the lamp increases. This increases the voltage drop across  $W4$  and the direct current through  $W3$ .  $W3$  is arranged to provide a magnetic field in the same direction as that from  $W2$  under these conditions. Consequently, the inductance of  $W1$  is further reduced. An increased current through  $W4$  and the lamp results and this process continues until magnetic saturation of the core prevents any further reduction in the inductance of  $W1$ .

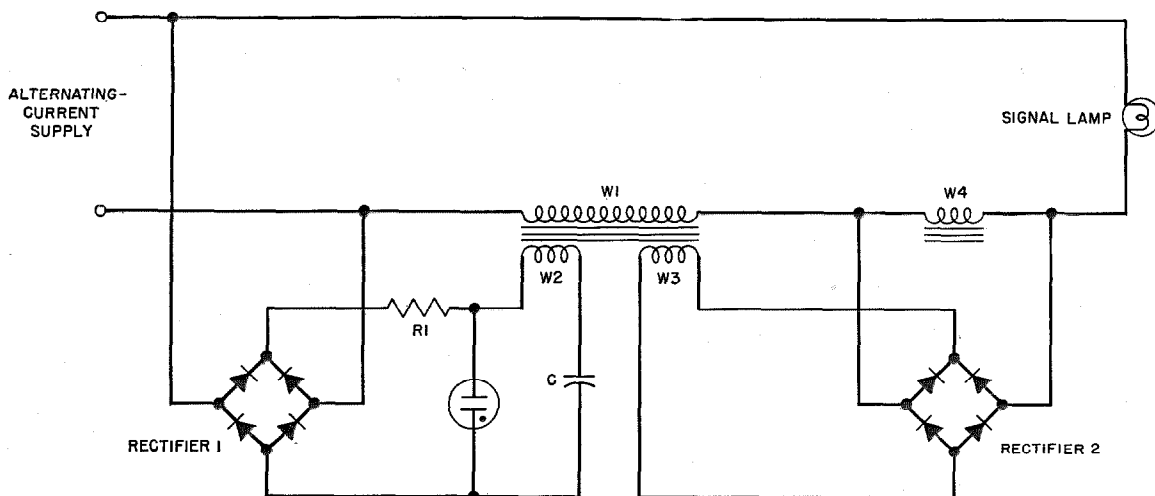

Fig. 1—Circuit used for flashing signal lamps. A relaxation oscillator employing a gaseous conduction tube controls the rate at which the lamp is flashed.

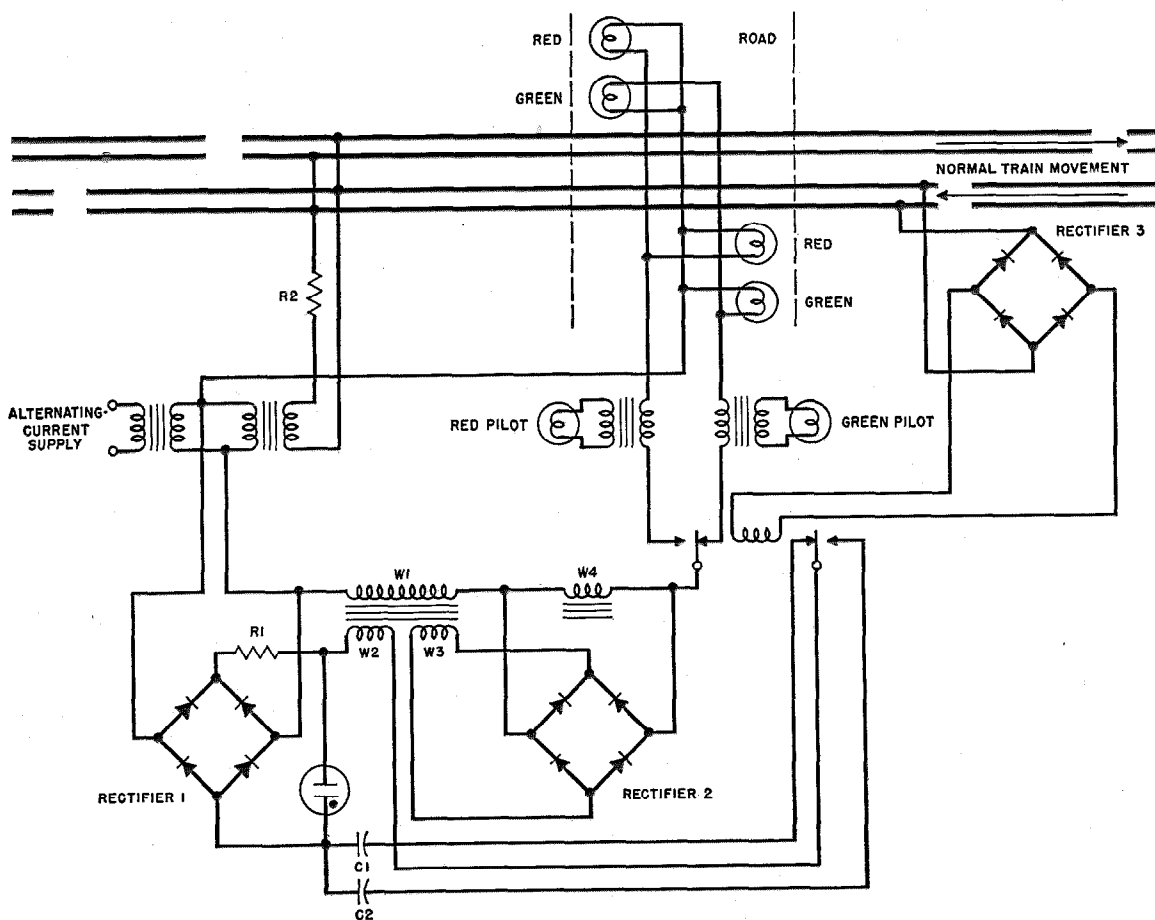

Fig. 2—Arrangement used at a typical railway crossing. The railway tracks are indicated by the heavy horizontal lines at the top and the dashed lines designate the highway for automobile and other traffic.



When the capacitor  $C$  discharges to a voltage at which the gaseous tube is no longer conducting, a current from the rectifier flows through  $R1$  and  $W2$  to recharge the capacitor. This current through  $W2$  is in the opposite direction to that which resulted from the discharge of the capacitor. Thus it produces a magnetic field which opposes that produced by the current flowing in  $W3$ . This increases the inductance of  $W1$ , which reduces the current through  $W4$  and the lamp. The reduced current through  $W4$  decreases the rectifier current through  $W3$ , further increasing the inductance of  $W1$ . This process continues until the inductance of  $W1$  is sufficiently high to extinguish the lamp.

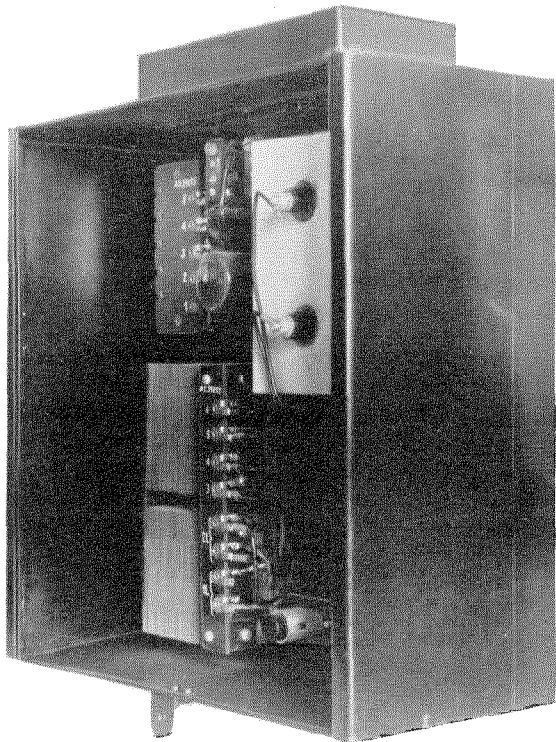

Fig. 3—The electronic flashing control equipment is mounted in a metallic case.

### 3. Railroad Crossing Installation

The arrangement used in a typical railroad crossing installation is shown in Fig. 2. Red and green signal lamps are located at each side of the railway facing the direction in which the traffic on the highway approaches the railroad.

At a suitable distance on each side of the crossing, the rails are insulated electrically from the rest of the railway system. These sections which are crossed by the highway are supplied with power at a voltage sufficiently low to offer no hazard to anyone making any contact with the rails. From these rails, rectifier 3 supplies power to a relay which under normal conditions supplies energy to the green signal lamps. When a train enters the protected region of either track, the input to the rectifier is short-circuited and the relay disconnects power from the green lights and applies it to the red signals. A resistor protects the transformer from burning out during this condition.

The pilot lamps are installed in the cabin of the nearest attendant to permit supervision of the operation of the signal lamps. The primary of the transformer to which the pilot light is connected is adjusted in accordance with the number of lamps that are being flashed.

A second set of contacts on the relay inserts a 40-microfarad capacitor in the relaxation oscillator circuit to flash the red lamp at a rate of 80 times per minute and an 80-microfarad capacitor to flash the green lamp at 40 times per minute.

The electronic flasher equipment is mounted in a metallic case 270 millimeters ( $10\frac{3}{4}$  inches) square by 157 millimeters ( $6\frac{1}{4}$  inches) deep (Fig. 3).

Although originally developed for the Société Nationale de Chemins de Fer Belges, its use is not limited to railway crossings but it may be applied to other purposes. It is also being used for street-traffic control.

## In Memoriam

Henry Mark Pease died on March 7, 1947, in New York after a brief illness. Born in Malta, Illinois, on December 19, 1875, he was a member of the ninth generation of the Pease family in the U. S. A.

Mr. Pease joined the Western Electric Company in Chicago in 1898, shortly after his graduation from the University of Illinois with a Bachelor of Science degree. After serving in the wiring shop, he was assigned to installation of central-office equipment in various American cities, and to supervision of installation in Cincinnati. Later, he returned to Chicago as an equipment engineer.

In December, 1902, Mr. Pease was transferred to the London branch of Western Electric to supervise the installation of central-battery telephone exchanges for the British Post Office and the National Telephone Company. After serving as chief engineer, he was transferred in 1907 to the sales department, becoming sales manager in 1909, and assistant manager of the company in 1913. In 1918, he was made managing director.

From 1908 to 1922, Mr. Pease also had charge of the extension of loaded-cable telephone transmission systems in Great Britain, Holland, Sweden, and Italy. In London, he organized the long-distance cable-laying department.

In 1922, he took an active part in forming the British Broadcasting Company, becoming one of its original directors. International Western Electric, London, installed one of the first broadcasting stations in England. The following year, Mr. Pease negotiated a contract with the British Post Office for the first transatlantic radiotelephone transmitting station.

In 1925, International Telephone and Telegraph Corporation purchased International Western Electric Company and changed its name to International Standard Electric Corporation.



HENRY MARK PEASE

Concurrently, the name of Western Electric, London, was changed to Standard Telephones and Cables, Limited. Mr. Pease continued as managing director of Standard Telephones and Cables until 1928 when he was appointed European general manager of International Standard Electric Corporation.

Mr. Pease returned to New York in 1933 as vice president and a director of the International Standard Electric Corporation. In 1941, he became president and last year assumed the post of first vice-chairman of the board. In 1937, he was elected vice president and a director of International Telephone and Telegraph Corporation. In addition, Mr. Pease served as vice president and a director of Federal Telephone and Radio Corporation, and as a director of both International Telecommunication Laboratories, Inc. and International Telephone and Telegraph Corporation, Sud America.

## Contributors to This Issue

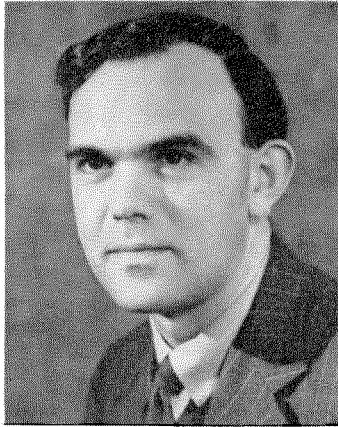

H. J. BARKER

H. J. BARKER was born at Halifax, Yorkshire, England, on April 14, 1915. He obtained an Honours degree in 1937 in physics from the Royal College of Science, London. He then did post-graduate work in electrical communications at City and Guilds College.

Since 1938, he has been with Standard Telephones and Cables, Limited, working in the carrier systems design and planning group at North Woolwich.

• • •

VERNON F. CLIFFORD was born on September 30, 1915, at Greenport, New York. He graduated from Brooklyn Technical High School.



VERNON F. CLIFFORD

After engaging in audio-frequency development work on motion-picture and sound-distribution systems for Transformer Corporation of America, he joined the direction-finder group of International Telephone and Radio Laboratories in 1941. He has worked on marine, mobile, aircraft, and fixed installations for the armed forces and for civilian use. At present, he is an engineer in the direction-finder division of Federal Telecommunication Laboratories.

• • •

MILTON DISHAL was born on March 20, 1918, in Philadelphia, Pennsylvania. Temple University conferred on him two degrees, the B.S. in 1939 and M.A. in 1941. He was a Teaching Fellow in physics in that University from 1939 to 1941.

Mr. Dishal entered Federal Telecommunication Laboratories in 1941 and is now a senior engineer in the development of radio receivers having special characteristics.

Mr. Dishal is a Senior Member of the Institute of Radio Engineers.

• • •

JOHN KEMP received his engineering training at the Imperial College of Science and Technology, London, receiving the diploma in 1921.

On completing college, he joined the International Western Electric Corporation. After a course of study in America, he specialized in the engineering and manufacture of toll cables. At the outbreak of the war, he was assigned to theoretical studies and is the author of several papers on wave guides.

He was elected a Member of the Institution of Electrical Engineers in 1935.

• • •

WILLIAM KIDD was born in Newcastle-on-Tyne, England, and was educated in mechanical and electrical engineering at Rutherford College and Durham College of Science.

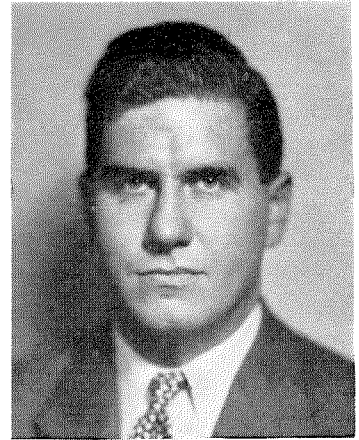

MILTON DISHAL

He served an apprenticeship in mechanical and marine engineering and obtained some commercial experience with the Yorkshire Brass and Copper Company. He was then employed as a draftsman at Palmers Steel and Iron Company. Later he became a draftsman and assistant to the works manager of the North Eastern Marine Engineering Company.

After a short period as a draftsman with the Manchester Corporation Electricity Department, he became assistant engineer at the Stuart Street generating station, then assistant to the deputy chief engineer, and finally chief construction engineer.

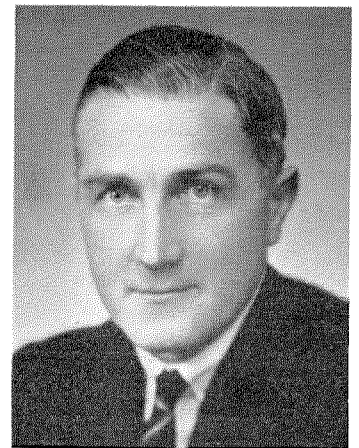

© Elliott & Fry, Ltd.  
JOHN KEMP



WILLIAM KIDD

Mr. Kidd is a Member of both the Institution of Mechanical Engineers and the Institution of Electrical Engineers. He has served on the Council of the Institution of Electrical Engineers, as chairman of the North-Western Centre and of the North-Western Transmission Group, and on the North-Western Committee. He is a member of the British Electrical Research Association Transformer Committee.

Mr. Kidd received from the Institution of Electrical Engineers the "Institution" premium in 1934 for his paper on "Automatic Voltage Control" and, jointly with E. M. S. McWhirter, the "John Snell" premium in 1945 for the paper "Operational Control of Electricity Supply Systems" reprinted in this issue of *Electrical Communication*.

• • •



GERARD J. LEHMANN

GERARD J. LEHMANN was born in Paris, France, on April 6, 1909. He received an engineering degree from Ecole Centrale in 1931.

On leaving school, he entered the employ of Sadir, becoming technical director in 1939.

In 1940, after leaving the French Army, he became a member of the Lyon laboratory staff of Le Matériel Téléphonique. He was transferred to Federal Telephone and Radio Laboratories in New York in 1943 and returned to France in 1945.

In addition to research work at Laboratoire Central de Télécommunications, Mr. Lehmann has been teaching at Ecole Centrale and in 1942 was appointed professor of direction finding and radio navigation at Ecole Supérieure d'Electricité.

Mr. Lehmann is a Senior Member of the Institute of Radio Engineers.

• • •

VICTOR CONSTANT MEEUWS was born at Antwerp (Berchem) on August 12, 1891. He was engaged by the Bell Telephone Manufacturing Company in 1913 and worked as a draftsman on the first rotary equipment manufactured by the company. After serving in the army from 1914 to 1919, he was placed in charge of the wiring section. In 1930, he was assigned to equipment design of the 7-D Rotary System. Four years later, he assumed the duties of power engineer.

In 1933, Mr. Meeuws was granted the title of Technical Engineer by a committee set up by law.

• • •

CARLOS PELAEZ PEREZ GAMONEDA joined Compañía Telefónica Nacional de España in 1924, having worked for some years previously with power supply companies and the Spanish military communications department. He served also as a professor in an engineering school in Spain. He has also worked on modulation transformers and high-powered radio equipment in Le Matériel Téléphonique in Paris.

In Compañía Telefónica Nacional de España, he was director of instruction, assistant chief engineer, and then chief engineer of the radio services. During the civil war in Spain, he was

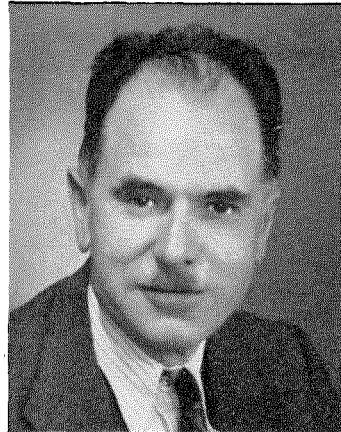

VICTOR C. MEEUWS

stationed in Madrid as subdirector general and also as vice president of International Telephone and Telegraph Corporation (España).

Mr. Pelaez is now in charge of the technical department of Standard Electrica in Lisbon and is assistant technical director of Standard Electrica S.A., Madrid, Compañía Radio Aerea Maritima Española and Sociedad Radio Argentina of Spain.

• • •

D. P. J. RETIEF was born in Pretoria, South Africa, on November 5, 1904. He received the B.Sc. (Eng) and B.A. degrees from the University of Capetown in 1929.

From 1930 to 1932, he was with Siemens in Berlin. He then returned to South Africa and joined the



CARLOS PELAEZ



D. P. J. RETIEF

Department of Posts and Telegraphs. He visited England in 1938 and 1944. As transmission engineer, he is now in charge of the development of long-distance communication.

Mr. Retief is an Associate Member of the Institution of Electrical Engineers and a Senior Member of the Engineers Association (South Africa).

• • •

GEORGE TAYLOR ROYDEN was born at Fort Clark, an army post in Texas, on June 20, 1895. He received a B.A. degree in 1917 and an engineering degree in 1924 from Stanford University.

He was employed by Federal Telegraph Company at Palo Alto, California, on part time in 1916 and full time after graduation from college. He was engaged in the design of arc transmitters of powers up to 1000 kilowatts.

From 1919 until 1925 he was at Mare Island Navy Yard. His duties

included work on Navy radio stations in San Diego, Hawaii, and Alaska.

He returned to Federal Telegraph Company in 1925 to do research work on broadcast receivers for operation on alternating current.

In 1927, he joined the newly organized Mackay Radio and Telegraph Company becoming division engineer. From 1936 to 1946, he was with Federal Telegraph Company in Newark, New Jersey. He then returned to Mackay Radio and Telegraph Company.

Mr. Royden is a Fellow of the Institute of Radio Engineers and a Member of the American Institute of Electrical Engineers and of Sigma Xi.

• • •

NORMAN H. YOUNG was born in Philadelphia, Pennsylvania, in 1913. He received the B.S. degree in electrical engineering from Pennsylvania State College in 1934 and the M.S. degree in 1935.

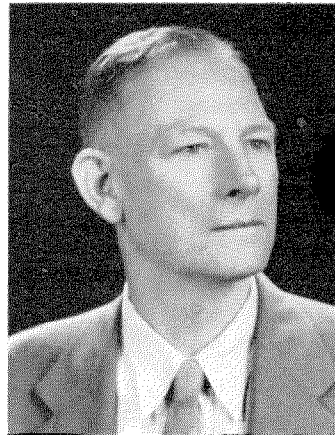

GEORGE T. ROYDEN

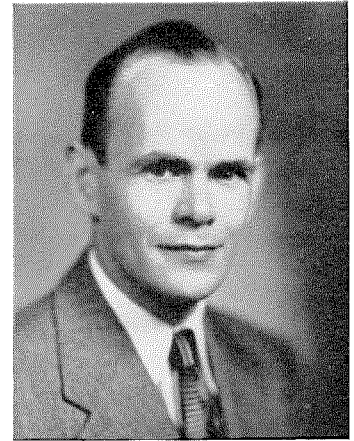

NORMAN H. YOUNG

From 1935 to 1942, he was engaged in television engineering for the Philco Corporation and had charge of the transmitter of television station WPTZ.

In 1942 he became a department head in Federal Telecommunication Laboratories and during the war was largely concerned with the application of pulse-time modulation to military communication equipment. At the termination of the war, he was responsible for the engineering of the color-television transmitter for the Columbia Broadcasting System. He has done additional work on receivers and studio equipment for color television.

Mr. Young is a member of Eta Kappa Nu and a Senior Member of the Institute of Radio Engineers.

• • •

For biographies and photographs of Trevor H. Clark and D. D. Grieg, see Volume 24, Number 2, pages 275 and 277.

# INTERNATIONAL TELEPHONE AND TELEGRAPH CORPORATION

## Associate Manufacturing and Sales Companies

### United States of America

International Standard Electric Corporation, New York, New York  
Federal Telephone and Radio Corporation, Newark and Clifton, New Jersey

### Great Britain and Dominions

Standard Telephones and Cables, Limited, London, England  
Branch Offices: Birmingham, Leeds, Manchester, England; Glasgow, Scotland; Dublin, Ireland; Cairo, Egypt; Calcutta, India; Johannesburg, South Africa  
Creed and Company, Limited, Croydon, England  
International Marine Radio Company Limited, Liverpool, England  
Kolster-Brandes Limited, Sidcup, England  
Standard Telephones and Cables Pty. Limited, Sydney, Australia  
Branch Offices: Melbourne, Australia; Wellington, New Zealand  
Silovac Electrical Products Pty. Limited, Sydney, Australia  
New Zealand Electric Totalisators Limited, Wellington, New Zealand  
Federal Electric Manufacturing Company, Ltd., Montreal, Canada

### South America

Compañía Standard Electric Argentina, Sociedad Anónima, Industrial y Comercial, Buenos Aires, Argentina  
Standard Electrica, S.A., Rio de Janeiro, Brazil  
Compañía Standard Electric, S.A.C., Santiago, Chile

### Europe and Far East

Vereinigte Telefon- und Telegraphenfabriks Aktien-Gesellschaft Czeija, Nissl and Company, Vienna, Austria  
Bell Telephone Manufacturing Company, Antwerp, Belgium  
China Electric Company, Limited, Shanghai, China

Standard Electric Doms A Spoleenost, Prague, Czechoslovakia  
Standard Electric Aktieselskab, Copenhagen, Denmark  
Compagnie Générale de Constructions Téléphoniques, Paris, France  
Le Matériel Téléphonique, Paris, France  
Les Téléimprimeurs, Paris, France  
Lignes Télégraphiques et Téléphoniques, Paris, France  
Ferdinand Schuchhardt Berliner Fernsprech- und Telegraphenwerk Aktiengesellschaft, Berlin, Germany  
Lorenz, C., A.G. and Subsidiaries, Berlin, Germany  
Mix & Genest Aktiengesellschaft and Subsidiaries, Berlin, Germany  
Süddeutsche Apparatefabrik Gesellschaft M.B.H., Nuremberg, Germany  
Telephonfabrik Berliner A.G. and Subsidiaries, Berlin, Germany  
Nederlandsche Standard Electric Maatschappij N.V., Hague, Holland  
Dial Telefonkereskedelmi Részvény Társaság, Budapest, Hungary  
Standard Villamossági Részvény Társaság, Budapest, Hungary  
Telefongyár R.T., Budapest, Hungary  
Fabbrica Apparecchiature per Comunicazioni Elettriche, Milan, Italy  
Standard Elettrica Italiana, Milan, Italy  
Societa Italiana Reti Telefoniche Interurbane, Milan, Italy  
Nippon Electric Company, Limited, Tokyo, Japan  
Sumitomo Electric Industries, Limited, Osaka, Japan  
Standard Telefon- og Kabelfabrik A/S, Oslo, Norway  
Standard Electrica, Lisbon, Portugal  
Standard Fabrica de Telefoane si Radio S.A., Bucharest, Rumania  
Compañía Radio Aerea Maritima Española, Madrid, Spain  
Standard Eléctrica, S.A., Madrid, Spain  
Aktiebolaget Standard Radiofabrik, Stockholm, Sweden  
Standard Telephone et Radio S.A., Zurich, Switzerland

## Telephone Operating Systems

Compañía Telefónica Argentina, Buenos Aires, Argentina  
Compañía Telefónico-Telefónica Comercial, Buenos Aires, Argentina  
Compañía Telefónico-Telefónica del Plata, Buenos Aires, Argentina  
Companhia Telefonica Paranaense S.A., Curitiba, Brazil  
Companhia Telefonica Rio Grandense, Porto Alegre, Brazil  
Compañía de Teléfonos de Chile, Santiago, Chile  
Compañía Telefónica de Magallanes S.A., Punta Arenas, Chile  
Cuban Telephone Company, Havana, Cuba  
Cuban American Telephone and Telegraph Company, Havana, Cuba  
Mexican Telephone and Telegraph Company, Mexico City, Mexico  
Compañía Peruana de Teléfonos Limitada, Lima, Peru  
Puerto Rico Telephone Company, San Juan, Puerto Rico  
Shanghai Telephone Company, Federal, Inc., U.S.A., Shanghai, China

## Radiotelephone and Radiotelegraph Operating Companies

Compañía Internacional de Radio, Buenos Aires, Argentina  
Compañía Internacional de Radio Boliviana, La Paz, Bolivia  
Companhia Radio Internacional do Brasil, Rio de Janeiro, Brazil  
Compañía Internacional de Radio, S.A., Santiago, Chile  
Radio Corporation of Cuba, Havana, Cuba  
Radio Corporation of Porto Rico, San Juan, Puerto Rico<sup>1</sup>

<sup>1</sup>Radiotelephone and Radio Broadcasting services.

## Cable and Radiotelegraph Operating Companies

(Controlled by American Cable & Radio Corporation)

The Commercial Cable Company, New York, New York<sup>2</sup>  
Mackay Radio and Telegraph Company, New York, New York<sup>3</sup>  
All America Cables and Radio, Inc., New York, New York<sup>4</sup>  
The Cuban All America Cables, Incorporated, Havana, Cuba<sup>2</sup>  
Sociedad Anónima Radio Argentina, Buenos Aires, Argentina<sup>5</sup>

<sup>2</sup>Cable service. <sup>3</sup>International and Marine Radiotelegraph services.

<sup>4</sup>Cable and Radiotelegraph services. <sup>5</sup>Radiotelegraph service.

## Laboratories

International Telecommunication Laboratories, Inc., New York, New York  
Federal Telecommunication Laboratories, Inc., Nutley, New Jersey  
Standard Telecommunication Laboratories Ltd., London, England  
Laboratoire Central de Télécommunications, Paris, France