



# ELECTRICAL COMMUNICATION

*Technical Journal of the  
International Telephone and Telegraph Corporation  
and Associate Companies*

---

ALEXANDER GRAHAM BELL—SCIENTIST  
FRANCE-ENGLAND SUBMARINE CABLE AND PARIS-CALAIS CABLE  
YARN-NUMBERING SYSTEM  
BEHAVIOUR OF TELEPHONE EXCHANGE TRAFFIC  
TECHNICAL COORDINATION ON AN INTERNATIONAL BASIS  
EXTENSION OF NORTON'S METHOD OF IMPEDANCE TRANSFORMATION  
BIKINI OBSERVATIONS AND THEIR SIGNIFICANCE  
LANDING AIRCRAFT WITH GROUND RADAR  
FREQUENCY-MODULATED BROADCAST TRANSMITTERS  
THEORY AND DESIGN OF THE REFLECTOMETER  
CATHODE DESIGN PROCEDURE FOR ELECTRON-BEAM TUBES  
CONTROL OF ELECTRON-BEAM DISPERSION AT HIGH VACUUM BY IONS  
TELEPHONE STATISTICS OF THE WORLD  
C.C.I.F. HONORS TWO PIONEERS  
RECENT TELECOMMUNICATION DEVELOPMENTS

---

MARCH, 1947

VOL. 24

No. 1



# ELECTRICAL COMMUNICATION

*Technical Journal of the*  
INTERNATIONAL TELEPHONE AND TELEGRAPH CORPORATION  
*and Associate Companies*

H. T. KOHLHAAS, Editor

F. J. MANN, Managing Editor

H. P. WESTMAN, Associate Editor

REGIONAL EDITORS

- E. G. PORTS, Federal Telephone and Radio Corporation, Newark, New Jersey
- B. C. HOLDING, Standard Telephones and Cables, Ltd., London, England
- P. F. BOURGET, Laboratoire Central de Télécommunications, Paris, France
- H. B. WOOD, Standard Telephones and Cables Pty. Ltd., Sydney, Australia

EDITORIAL BOARD

- |                |                   |             |                 |                  |
|----------------|-------------------|-------------|-----------------|------------------|
| H. Busignies   | H. H. Buttner     | G. Deakin   | E. M. Deloraine | W. T. Gibson     |
| Sir Frank Gill | W. Hatton         | E. Labin    | E. S. McLarn    | A. W. Montgomery |
| G. Rabuteau    | F. X. Rettenmeyer | T. R. Scott | C. E. Strong    | E. N. Wendell    |
|                |                   |             |                 | Haraden Pratt    |
|                |                   |             |                 | W. K. Weston     |

Published Quarterly by the

## INTERNATIONAL TELEPHONE AND TELEGRAPH CORPORATION

67 BROAD STREET, NEW YORK 4, N.Y., U.S.A.

Sosthenes Behn, President

Charles D. Hilles, Jr., Vice President and Secretary

Subscription, \$2.00 per year; single copies, 50 cents

Copyrighted 1947 by International Telephone and Telegraph Corporation

Volume 24

March, 1947

Number 1

### CONTENTS

	PAGE
ALEXANDER GRAHAM BELL—SCIENTIST .....	3
<i>By F. J. Mann</i>	
FRANCE-ENGLAND SUBMARINE CABLE (1939) AND PARIS-CALAIS CABLE .....	24
<i>By A. Fromageot</i>	
YARN-NUMBERING SYSTEM .....	40
<i>By A. A. New</i>	
BEHAVIOUR OF TELEPHONE EXCHANGE TRAFFIC WHERE NON-EQUIVALENT-CHOICE OUTLETS ARE COMMONED .....	42
<i>By E. P. G. Wright</i>	
TECHNICAL COORDINATION ON AN INTERNATIONAL BASIS IN COMMUNICATION AND ALLIED FIELDS .....	55
<i>By E. M. Deloraine</i>	
EXTENSION OF NORTON'S METHOD OF IMPEDANCE TRANSFORMATION TO BAND-PASS FILTERS .....	59
<i>By Vitold Belevitch</i>	
BIKINI OBSERVATIONS AND THEIR SIGNIFICANCE .....	66
<i>By Haraden Pratt and Arthur Van Dyck</i>	
LANDING AIRCRAFT WITH GROUND RADAR .....	72
<i>By J. S. Engel</i>	
FREQUENCY-MODULATED BROADCAST TRANSMITTERS FOR 88-108 MEGACYCLES..	82
<i>By Leonard Everett</i>	
THEORY AND DESIGN OF THE REFLECTOMETER .....	94
<i>By B. Parzan and A. Yalow</i>	
CATHODE-DESIGN PROCEDURE FOR ELECTRON-BEAM TUBES .....	101
<i>By Robert Helm, Karl Spangenberg, and Lester M. Field</i>	
CONTROL OF ELECTRON-BEAM DISPERSION AT HIGH VACUUM BY IONS .....	108
<i>By Lester M. Field, Karl Spangenberg, and Robert Helm</i>	
TELEPHONE STATISTICS OF THE WORLD .....	122
C.C.I.F. HONORS TWO PIONEERS .....	123
RECENT TELECOMMUNICATION DEVELOPMENTS .....	123
CONTRIBUTORS TO THIS ISSUE .....	125



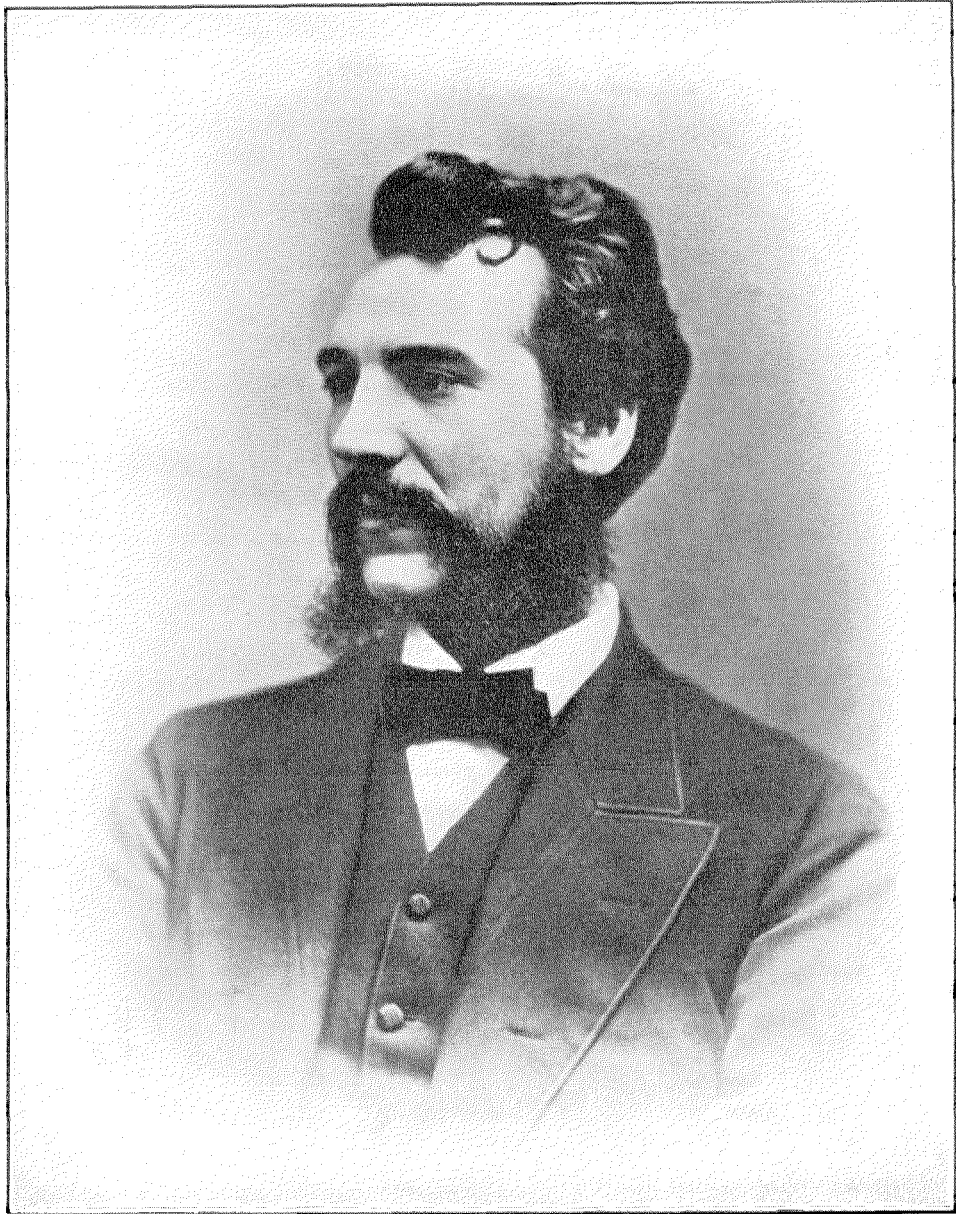

**Alexander Graham Bell as he appeared in 1876, the year the telephone patent was granted.**

# Alexander Graham Bell—Scientist\*

By F. J. MANN

*Managing Editor, Electrical Communication*

ALEXANDER GRAHAM BELL was born one hundred years ago, March 3, 1847, in Edinburgh, Scotland. In commemorating the centennial of his birth, he will be eulogized as a philanthropist, a teacher, and as a man who did much to aid the deaf and hard of hearing, as well as the inventor of the telephone. These he was, it is true. But, judging from his own life and writings, he would have preferred to be remembered primarily as a scientist.

By present standards, Bell might not have qualified as a great scientist. It must be remembered, though, that he was born into a world only slowly awakening to the wonders of scientific discovery. Only a few years before his birth, the Morse telegraph (1832), the McCormick reaper (1833), photography (1839), ether used as an anaesthetic (1842), and Howe's sewing machine (1845) had come into being. Compared with research on atomic fission and development of radar, these inventions were the results of crude efforts often carried on over relatively long periods of time in attics or small sheds. But, like Bell's invention of the telephone, they had something in common. They were basic accomplishments, the results of creative thought, often of a single mind.

Nothing in history indicates that these achievements, and many others that followed, rose full-blown from flash-of-genius ideas. Each involved its own painstaking effort. Often never recorded, were the heartbreaking stories of failure by those who struggled toward common goals, but lacked the creative spark essential to success. Bell, before he invented the telephone, overcame numerous difficulties. He had his contemporary rivals, who strove for the same objective—to send the human voice over wires. Credit Bell's triumph to a singularly inventive mind, if you will, or to a "lucky break," as some thought. It was Bell's belief, as well as that of many of his colleagues, that his

success was due to his unique training and life-long association with the science of speech and acoustics.

Bell was born into a family preoccupied with the correction and teaching of speech. Bell's grandfather, Alexander Bell (1790–1865), who started life as a shoemaker in St. Andrews, Scotland, where for generations his ancestors had been shoemakers, forsook this occupation for that of a Shakespearean actor. After he had married and moved to Edinburgh, he abandoned the stage to become an elocutionist and a "corrector of defective utterance." The grandfather, then, was the first in the family to study the mechanism of speech with the object of correcting defects by explaining to his pupils the correct positions of the vocal organs in uttering sounds.

This profession, founded by the grandfather, became a family profession which was carried on by his children and grandchildren. Both of his sons, for example, David Charles Bell (1817–1902) and Melville Bell (1819–1905), were elocutionists and correctors of defective speech. It should be pointed out, though, that neither the grandfather nor his sons could be called mere reciters or practitioners of cures for defects of speech. They studied the anatomy of speech with scientific thoroughness. Among them they are said to have exerted a strong influence on English speech.

Melville Bell, Alexander Graham Bell's father, won a world-wide reputation in his profession. His *Standard Elocutionist* had run through 168 editions by 1893 and it has sold impressively since then. By the end of his life, some 26 of his textbooks and charts on speech and phonetics were in use in schools and colleges.

## ***Bell's Father Invents Visible Speech***

When Alexander Graham Bell was in his early teens, his father branched off from the profession of teaching into that of inventor. He called his creation "visible speech," a remarkable system

\* Reprinted from *Electrical Engineering*, v. 66, n. 3; March, 1947.

of symbols for depicting the actions of the vocal organs in uttering sounds. These symbols could be used in printed form like letters of the alphabet. He claimed that what he had really devised was a universal single alphabet capable of expressing the sounds of all languages and that his letters, instead of being arbitrary characters, were symbolic representations of the organs of speech and their positions in uttering sounds. Visible speech was actually a code of symbols made up of curved and straight lines—resembling shorthand—that indicated the position and action of the throat, tongue, and lips in pronouncing syllables or various sounds.

Visible speech proved useful as a key to the pronunciation of words in all languages. It also developed that the symbols could be used to guide the deaf in learning to speak. Alexander Graham Bell, as he grew up, became expert in the use of visible speech, particularly in aiding deaf pupils, a fact which had a most important bearing on his life after he came to America.

### *Early Interest in Music*

Despite this environment of speech correction and scientific investigation, it seemed that young Alexander would follow the arts instead of the family profession. As a boy, Bell exhibited an outstanding aptitude for the piano. "Music especially was my earliest hobby," said Bell. He learned to play at such an early age that, in later life, he was unable to recall a time when he could *not* play. He seemed to have picked it up by himself without any instruction, and, although he knew nothing of written music, he could play anything he heard and could improvise at length. This acute ear for music was destined one day to pick up the faint "ping" of a reed accidentally plucked in a Boston attic and to recognize in it the possibility of electrical transmission of speech.

Signor Auguste Benoit Bertini, a distinguished professor of music, heard young Bell play and offered to give him instruction in his system of reading music by sight. Bell worked hard at his lessons and became such a promising pupil that Bertini wanted him to become his successor. However, Bertini died before this hope might have been realized. After Bertini's death, Bell received no further formal instruction in music

except from his mother who sought to carry out Bertini's ideas as well as she could. But the old professor seems to have inspired young Bell with a passion for music, which led him, for a time, to consider a musical profession. In fact, he did teach music for two years at Weston House, a boy's school in Elgin, Scotland, starting in 1863 when he was only 16 years old.

### *Urged to Follow Family Profession*

When we consider today how the same amplifier and loudspeaker reproduce both speech and music, a musical career and the teaching of speech correction are evidently more nearly related than was then apparent. At any rate, Bell's father urged him to give up music as a profession and carry on the family practice in the art and science of speech.

Aleck, as the family called him, had good reason to follow his father's advice. Not only had the father achieved distinction in his profession, but he seems to have been singularly successful in what is often a much more difficult task, that of instilling in his sons a sense of intellectual curiosity and integrity as well as individuality of thought. His influence was exerted in various ways. One was to encourage his boys to make collections of all sorts and to arrange the specimens in accordance with their own ideas rather than in conformity with those of others. Aleck's collection consisted of a large number of skeletons, neatly arranged and classified as in a museum. It included a goodly number of skulls of squirrels, rabbits, cats, and dogs, but the gem of the collection was a real human skull presented to him by his father.

Alexander Graham Bell put great store in this phase of his education. In the last year of his life he wrote:<sup>1</sup>

I can see in these natural-history collections a preparation for scientific work. The collection of material involved the close observation of the likenesses and differences of objects of very similar kind, and the orderly arrangement, as in a museum, stimulated the formation of generalizations of various kinds. . . . I am inclined to think that the making of these collections formed an important part of my education and was responsible for my early bent toward scientific pursuits.

---

<sup>1</sup> A. G. Bell, "Prehistoric Telephone Days," *The National Geographic Magazine*, v. 16, pp. 226-227; March, 1922.

### *Indifferent to Classical Studies*

While Aleck excelled in these exceptional pursuits, he was not considered brilliant at his formal studies. From 1855 to 1859, he attended McLaren's Academy and the Royal High School in Edinburgh, but he lacked enthusiasm for the prescribed subjects and especially disliked Latin and Greek, then considered the mainstays of formal education. His opinion of the advantage of scientific over classical training as a preparation for life was expressed in his prophetic address to the graduates of McKinley Manual Training School at Washington, D. C., in 1917:

The nation that fosters science becomes so powerful that other nations must, if only in self-defense, adopt the same plan. . . . Scientific and technical experts are destined in the future to occupy distinguished and honorable positions in all the countries of the world.

It is to his grandfather that a great deal of the credit must go for inspiring and encouraging Aleck to overcome his indifference to formal education. In 1860, when 13, Aleck spent a year with his grandfather in London. His grandfather helped him map out his time and devote certain hours to the ordinary school subjects. He also gave him personal lessons in elocution and English literature. At the same time, Aleck received instruction in the mechanism of speech from his grandfather, who permitted the boy to be present at the instruction of some of his pupils so that he might observe the methods of correcting defective utterance.

This year with his grandfather converted Aleck from what he described as "an ignorant and careless boy into a rather studious youth, anxious to improve his educational standing by his own exertions and fit himself for college." The conversion was really from indifference to enthusiasm, for throughout every stage of his development and education, even in later years, his enthusiasm governed his working habits. In fact, in the subjects he loved, like music and science, he was almost too enthusiastic so that, for many years, he was constantly threatened with breakdowns. However, rather than an over-studious, bookish person, he was fun-loving and ardent, so gifted that he took vast pleasure in whatever happened to interest him.

Bordering on the precocious was an incident Bell often recalled; it led to what he considered to be his first invention and was related by him in 1922:<sup>2</sup>

When I was quite a little fellow, it so happened that my father had a pupil of about my own age with whom I used to play. He was the son of a Mr. Herdman, who owned large flour mills near Edinburgh, and, of course, I went over to the mills pretty often to play with him there. We romped about and got into all sorts of mischief, until at last one day Mr. Herdman called us into his office for a very serious talk.

"Why can't you boys do something useful," he said, "instead of always getting into mischief?"

I mildly asked him to tell us some useful thing to do, and he replied by putting his arm into a bag and pulling out a handful of wheat. He showed us that the grains were covered with husks, and said: "If you could only take the husks off that wheat, you'd be doing something useful indeed."

That made rather an impression upon my mind, and I began to think, "Why couldn't we take the husks off by brushing the seeds with a nailbrush?"

We tried the experiment and found it successful, although it involved a good deal of hard work from the two mischief-makers. We persevered, however, and soon had a nice little sample of cleaned wheat to show Mr. Herdman. I then remembered that during our explorations at the mills we had come across a large vat or tank with a paddle-wheel arrangement in it that whirled round and round in a casing of quite rough material, brushes of fine wire netting, or something of that sort. If we could only put the wheat into the machine, I thought, the whirling of the paddle should cause the seeds to rub against the rough surface of the casing, and thus brush off the husks.

It was a proud day for us when we boys marched into Mr. Herdman's office, presented him with our sample of cleaned wheat, and suggested paddling wheat in the dried-out vat.

"Why," said Mr. Herdman, "that's quite a good idea," and he immediately ordered the experiment to be made. It was successful, and the process, I understand, or a substantially similar one, has been carried on at the mills ever since.

### *Meets Well-Known Scientists*

If this first "invention" had nothing to do with the telephone, later experiments made by Bell when he was 15 years old most certainly did. The father's fame as a scientist of speech problems brought him in contact with some of the

<sup>2</sup> Reference 1, pp. 239-241.

most outstanding men of his day. His evident pride in his sons and his interest in their development led him to share these valuable and pleasant associations with them. Thus it was that Aleck, when still a boy, met such men as Alexander J. Ellis, the translator of Helmholtz; Max Muller, Sanskrit scholar; Henry Sweet, phonetician; Dr. Furnival, secretary of the Philological Society of London; Dr. Murray, afterwards Sir James Murray, editor of the great Oxford Dictionary; Prince Lucian Bonaparte, student of Scottish dialects; and Sir Charles Wheatstone.

### *Visits Wheatstone*

Each meeting made a vivid impression on Aleck. Probably the one to have the most immediate effect was his first contact with Sir Charles Wheatstone, who had constructed what was then called an automaton speaking machine from a description in a book on the mechanism of human speech by Baron von Kempelen. Aleck's father took him to visit Sir Charles to see the machine and hear it talk.

Aleck saw Sir Charles manipulate the machine and he heard it speak. Although the articulation was crude, it made a great impression on him. Sir Charles loaned Baron von Kempelen's book to the Bells and Aleck devoured it when he reached home. The book was in French, but he knew the language well enough to be able, with his father's assistance, to read and enjoy it.

Stimulated by their father, Aleck and his brother, Melville, attempted to construct a speaking machine of their own. They divided up the work, Melville's special part consisting of the larynx and vocal chords, to be operated by the wind chest of a parlor organ, while Aleck undertook the mouth and tongue.

### *Brothers Work on Speaking Machine*

Melville was quite skillful in the use of tools, while Aleck was clumsy with his hands and ineffective where tools were concerned. Aleck hit upon a plan, however, that obviated the disadvantages of this defect in a great degree: he made his models of gutta-percha wherever possible.

The father took an extraordinary interest in the proposed talking-machine and encouraged the boys in every way. Bell stated that it was not until much later in life that he realized that the father looked upon the machine as a valuable educational toy which would compel his sons to become familiar with the operation of the vocal organs. It was for this reason that the father encouraged them to copy Nature itself rather than to follow in the footsteps of von Kempelen and Wheatstone.

The boys attempted to make an exact copy of the vocal organs and work the artificial lips, tongue, and soft palate by means of levers controlled by a keyboard. Aleck started on his part of the work by making a cast from the human skull his father had given him. The mouth parts of the skull were reproduced in gutta-percha. This gave a firm foundation, consisting of the upper teeth, the upper gum, the hard palate, and the back of the pharynx, with a large hole at the top representing the rear entrance into the nasal cavities. This hole was covered by a valve, consisting of a piece of wood hinged to the palate and covered with a skin of soft rubber stuffed with cotton batting. The operating lever passed through the nasal passages beyond the nose. The lips were formed of a framework of iron wire covered with rubber stuffed with cotton batting, and rubber cheeks were provided, completely closing the mouth cavity.

It was proposed to make the tongue of wooden sections, arranged side by side like the dampers of a piano. Each section was to be elevated by its appropriate lever, and the whole tongue covered by a thin skin of rubber stuffed with cotton batting. This part of the mechanism was never actually completed, but sections of the tongue were made and experimented with.

While Aleck was thus engaged, his brother made an artificial larynx, or throat, of tin, with a flexible tube attached as a windpipe. Inside the larynx were two flat sheets of tin sloping upward toward one another, but not touching at the middle. Stretched tightly upon this structure were two sheets of rubber, the edges of which did touch at the middle.

When the windpipe was blown into, the rubber vocal chords were thrown into vibration, producing a musical sound. By varying the tension of

the rubber strips and by changing the force of the breath, it would squeak like a Punch and Judy show, or produce a reed-like musical tone.

When this stage had been reached, the boys were anxious to put the throat and the mouth together to see what the effect would be. Without waiting to complete the tongue, or for the arrival of the organ bellows, they fastened the tin larynx to the gutta-percha mouth and one of them blew through the windpipe. At once the character of the sound was changed; it no longer resembled a reed instrument, but a human voice. Vowel quality also could be reproduced. It could be made to sound as though someone were singing the vowel "ah."

### *Talking Machine a Success*

Aleck opened the rubber lips a number of times in succession while his brother blew through the windpipe. The machine responded by uttering the syllables "ma-ma-ma-ma" quite clearly and distinctly. By using only two syllables and prolonging the second, they obtained good reproduction of the word "mamma," pronounced

in the British fashion, with the accent on the second syllable. The next step, of course, was to try the effect on the neighbors.

The house they lived in consisted of a number of flats that opened on a common stairway. They took the apparatus out on the landing. Melville put the windpipe to his mouth and blew for all he was worth, while Aleck manipulated the lips. The hallway resounded with loud cries of "Mamma! Mamma! Mamma!"—imitating a child in great distress.

Soon a door opened upstairs and the boys heard a woman exclaim, "My goodness, what's the matter with that baby!"

That was all they needed. Delighted with their success, they stole quietly back into their home and gently shut the door.

Although no further work was done on the speaking machine, it had undoubtedly been successful in realizing the father's desire that through it his boys should become familiar with the structure and functions of the various vocal organs.

Aleck was always much interested in his

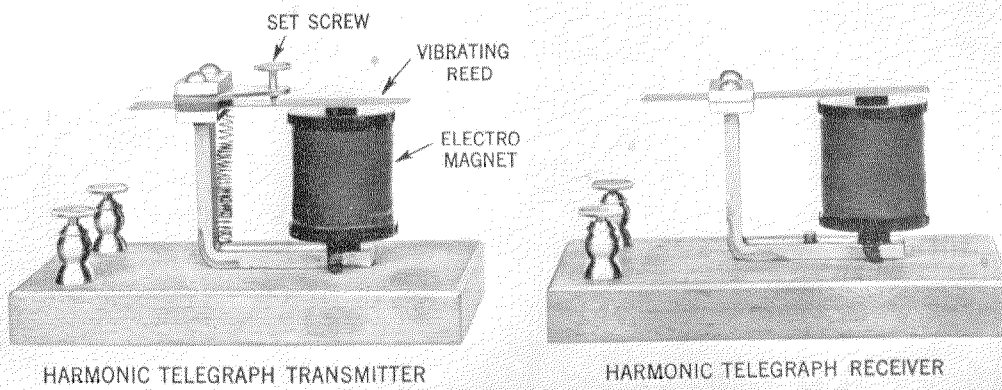

Replicas of the harmonic telegraph instruments used by Bell and Watson in the historic experiments of June 2, 1875. When the transmitter reed vibrated, it was supposed to touch the set-screw contact and send a pulse of current along the line. During the experiments, the reed stuck to the contact and Watson's efforts to free the reed by plucking made the current undulate. Bell, listening to the receiver, placed the free end of the reed against his ear. This made the receiver reed act like a telephone receiver diaphragm. With this arrangement, sound was actually transmitted from the transmitter to the receiver, confirming Bell's carefully worked out theories about the electrical transmission of sound.



father's examinations of the mouths of his elocution pupils. They differed in an extraordinary degree in size and shape, and yet all these variations seemed to be quite consistent with perfect speech. He then began to wonder whether there was anything in the mouth of a dog to prevent it from speaking, and started to make experiments with his intelligent Skye terrier.

### *Bell's Talking Dog*

Stimulated by rewards of titbits, the dog was soon taught to sit up on his hind legs and growl continuously while Aleck manipulated his mouth, and to stop growling when he took his hands away. Aleck would take the dog's muzzle in his hands and open and close the jaws a number of times in succession. This resulted in the production of the syllables "ma-ma-ma" as in the case of the speaking machine.

The dog's mouth proved too small to enable Aleck to manipulate individual parts of the tongue, but by pushing upward between the bones of the lower jaw, near the throat, he found it possible to close the passageway completely at the back of the mouth. A succession of pushes of this character resulted in the syllables "ga-ga-ga."

The simple growl was an approximation of the vowel "ah" and, followed by a gradual constriction and "rounding" of the labial orifice by the hand, became converted into the diphthong "ow," as in the word "how" (ah-oo). He soon obtained the final element by itself—an imperfect "oo." The dog's repertoire of sounds finally consisted of the vowels "ah" and "oo", the diphthong "ow," and the syllables "ma" and "ga."

### *Dog Learns Sentence*

Bell then proceeded to manufacture words and sentences composed of these elements, so that the dog could finally say the sentence "Ow-ah-oo-gamama," which, by the exercise of some imagination, readily passed for "How are you, grandmamma."

Of this talking dog, Bell wrote:<sup>3</sup>

The dog soon learned that his business in life was to growl while my hands were upon his mouth, and to stop growling the moment I took them away, and we both of us became quite expert in the production of the famous sentence, "How are you, grandmamma?"

The dog took quite a bread-and-butter interest in the experiments and often used to stand up on his hind legs and try to say this sentence by himself, but without manipulation was never able to do anything more than growl.

The fame of the dog soon spread among my father's friends, and people came from far and near to witness the performance.

As previously stated, Bell started his teaching career at Weston House in 1863. He actually was rated as a student-teacher, that is, as compensation for teaching, he received advanced instruction at the school. A plan was worked out whereby his brother, Melville, went to the University of Edinburgh while Aleck taught music and elocution and continued his studies. At the end of the year, Bell went to the University for further classical education while Melville taught at Weston House. In 1866, he returned to Weston House as a full-time teacher. In addition, his formal education included a course in anatomy at University College, London, and he matriculated as an undergraduate at London University.

### *Bell Proves Vowel Sounds Compound*

In 1866, while Bell was still at Weston House, an incident occurred that was destined to lead him closer to thinking about the telephone than any of his previous experiments. Recalling his efforts to make a dog talk, and how close he and his brother had come to making a talking machine, it is not surprising that he should have been curious about the sounds produced in his own mouth. Consequently, he carried on a series of experiments to determine the resonant pitches of the mouth cavities during the production of vowel sounds. He would put his mouth and tongue in position to pronounce the vowel and then tap his throat or cheek with his finger or a pencil. Since the two principal cavities are forward and back of the tongue, which moves to help form the sounds, Bell's ear could distinguish the tone of each cavity in the resonant sound that resulted from tapping in various ways. The experiments proved that vowel sounds are

<sup>3</sup> Reference 1, p. 239.

compound; that is, they are a combination of resonances from different vocal cavities, and modifications of a single pitch or tone.

### ***Hears About Helmholtz Experiments***

At the time Bell believed that these experiments were original. He wrote a long letter to his father explaining his "discovery about resonance pitches." His father showed the report to Alexander John Ellis, president of the London Philological Society. Ellis told Bell that the same discovery had been made by Hermann L. F. von Helmholtz and described in his classic work, *On the Sensations of Tone as a Physiological Basis for the Theory of Music*. Since Helmholtz's book had not then been translated into English (Ellis made the English translation in 1875), Ellis tried to explain the experiment to young Bell. Helmholtz, he pointed out, had not only made the same observations, but had gone further. He had built up a synthetic vowel sound from its constituents using three electrically operated tuning forks. One fork represented the pitch of the voice while the other two corresponded in pitch to the front and back cavities of the mouth in uttering a vowel sound.

Bell did not at the time have sufficient electrical knowledge to understand Ellis's description of the apparatus used by Helmholtz. He borrowed a copy of the German text of Helmholtz's book. He knew little German, but he made out just enough from the plates, or thought he did, to confuse the description Ellis had given him and to conclude that Helmholtz had sent the vowel sounds by telegraph. Bell then reasoned that if vowel sounds could be sent by telegraph, why not consonants or even speech?

Bell determined to study electricity, for he felt that it was his duty, as a student of speech, to acquaint himself with the researches of Helmholtz and to repeat Helmholtz's experiments. Consequently, 1867 found Bell, then an instructor in Somersetshire College, Bath, England, experimenting with ordinary telegraph apparatus and vainly striving to use an electromagnet to cause a tuning fork to vibrate continuously.

Three years later he learned from a French translation of the Helmholtz book that the German scientist had not telegraphed the vowel sounds. In the meantime his imagination had been stimulated by the idea. "I thought that Helmholtz had done it," Bell said later, "and that my failure was due only to my ignorance of electricity. It was a very valuable blunder. It gave me confidence. If I had been able to read German in those days, I might never have commenced my experiments!"

During this period, Bell's two brothers succumbed to tuberculosis, the younger brother, Edward Charles, in 1867 and, in 1870, the elder brother, Melville James.

### ***Family Moves to Canada***

Alexander Graham Bell also was threatened with tuberculosis. Fearing that his only remaining son might fall a victim, Bell's father resigned his lectureships, disposed of his practice in London, and emigrated to Canada. The family landed at Quebec in August, 1870, and soon settled at Tutelo Heights, near Brantford, in Ontario. The change of climate proved beneficial and Bell recovered his health in a few months.

While in Canada, Bell became interested in the dialect of the Mohawk Indians on a nearby reservation. He transcribed many of their words and phrases into visible speech. For this, the grateful Mohawks made Bell an honorary chief of North American tribes. They also taught him the war dance which he often performed thereafter in moments of triumph and which gave a number of Boston landladies some moments of anxiety.

### ***Bell Begins Teaching in Boston***

Bell went to Boston, Massachusetts, in April, 1871, to teach visible speech at the Boston School for the Deaf (now the Horace Mann School). This first assignment was temporary and lasted only two months, but other assignments followed. He became so expert in using visible speech to train deaf children to pronounce

properly that in a few weeks he taught them to use more than 400 English syllables, some of which they had failed to learn in two or three years through other teaching methods. Bell's method was to teach the pupil to relate the symbol, by touch or demonstration, to the vocal process it indicated. For example, the consonant "P" calls for placing the tongue against the lower teeth, closing the lips, and then opening them to ejaculate a puff of air. After writing the symbols for these processes on a blackboard, Bell would open his own mouth to show the tongue position, then hold the pupil's hand in position to feel the puff of air. Similar procedures were repeated for other letters.

### ***Becomes Professor at Boston University***

On October 1, 1872, Bell opened his own school of vocal physiology at 35 West Newton Street, Boston, to receive as pupils deaf mutes, persons with defective speech but with normal hearing, and teachers of the deaf and dumb. The following year, he became Professor of Vocal Physiology in the School of Oratory at Boston University. Bell then conducted his classes there, and retained his position on the faculty until 1877.

It was about this time that Bell met two men who were to have a marked influence on his life and the invention of the telephone. The first was Gardiner Greene Hubbard, an attorney inclined toward promotion of civil and governmental progress. The second was Thomas Sanders, a Boston leather merchant.

Hubbard's daughter, Mabel, had been left deaf after an attack of scarlet fever when she was four years old. In his efforts to help his daughter, Hubbard was confronted with school authorities who held the opinion that the deaf had no place in normal society—that the best that could be done for them was to send them to an institution where they could be taught the sign language. Hubbard, however, refused to accept this fate for his daughter and proceeded to do everything possible to save Mabel's power of speech. He even sent her to Germany for instruction in an oral method.

When Bell arrived in Boston with his visible-speech method, Hubbard naturally became his strongest champion. As a matter of fact, Hub-

bard had, shortly before, succeeded in having a bill passed in the Massachusetts legislature for the establishment of an oral school for the deaf, over strong opposition based on the premise that any attempt to teach "deaf mutes" to speak "flouted the decrees of Providence." The common interest of the two men in oral-speech training for the deaf resulted in the growth of a strong bond of friendship between them.

Bell was often a welcome guest at the spacious Hubbard home in Cambridge, Massachusetts. During one of these many visits, Bell illustrated some of the mysteries of acoustics with the aid of a piano. "Do you know," he said, "that if I sing the note *G* close to the strings of the piano, that the *G* string will answer me?"

"Well, what then?" asked Hubbard.

"It is a fact of tremendous importance," replied Bell. "It is evidence that we may some day have a musical telegraph which will send as many messages over one wire as there are notes on that piano."

Hubbard could see the value of such a device and later financed Bell's experiments with the harmonic telegraph. Being a practical man of business he could see how such a device might simplify the telegraph business and reduce costs. But he could not, at the same time, see Bell's idea of sending speech over an electric wire as anything but a worthless scientific toy. Such opposition, for a long time, retarded any attempts on the part of Bell to develop a telephone. Nevertheless, Hubbard's legal as well as financial encouragement were invaluable to Bell in filing his patent claims properly, gaining recognition from important persons, and in many other ways.

### ***Frequent Visitor at Hubbard Residence***

Not by any means the least important advantage to Bell of Hubbard's friendship was the opportunity to visit at the Hubbard residence. Bell was often invited for Sunday dinner which, at that busy time of his life, was just about the only social recreation and relaxation he had. On these visits he came to know the four Hubbard daughters and, in time, fell in love with Mabel. They were married July 11, 1877.

Bell's friendship with Thomas Sanders also started through his work of teaching the deaf to

speak. For Sanders had a son, George, who had been born deaf. George Sanders became a private pupil of Bell's when the boy was five years of age. This was in 1872. In 1873, Sanders arranged that George should live with his grandmother, who had a big house in Salem, Massachusetts, and that Bell should board there as the most convenient arrangement to continue George's instruction.

### *Resumes Electrical Experiments*

The arrangement included permission for Bell to use the Sanders basement for his electrical experiments, which he now resumed. In addition, he commuted 16 miles to Boston every day, taught at the University, and instructed George Sanders. Although one can well wonder where he found the time, the basement in Salem became cluttered with wires, batteries, and tuning forks. Soon, it was overflowing with apparatus and Mrs. Sanders added the entire third floor to Bell's domain.

Even before going to Boston, Bell had conceived the idea of a system of harmonic multiple telegraphy, in which a number of telegraphic signals could be sent simultaneously over the same circuit in either or both directions. This is the plan he had had in mind when he discussed acoustics with Gardiner Hubbard.

Bell's first experiments were with groups of transmitting and receiving tuning forks so arranged that each fork could vibrate between the poles of an electromagnet. The transmitting forks had connecting wires dipping into small cups of mercury so that current from a battery caused a fork to vibrate in much the same manner as an electric bell. However, each tuning fork vibrated only at its normal pitch and emitted its own characteristic musical tone. A telegraph key was placed in the circuit of each transmitting tuning fork and the group was connected through wires to the receiving forks, placed some distance from the transmitting point.

The transmitting and receiving tuning forks were arranged in pairs, that is, for each transmitter fork there was a receiver fork that vibrated at the same pitch. Each transmitter fork

produced a different frequency; and, through the principle of sympathetic vibration or resonance, when the key of one of the transmitting forks was pressed, setting the fork in vibration, the fork tuned to the same frequency at the receiving end also vibrated, the other forks remaining at rest. If two transmitting forks were vibrated, the two corresponding receiving forks responded, and so on. As the forks were all connected over the same pair of wires, such a system would have made it possible to effect a considerable saving in telegraph lines.

While Bell's theory of the harmonic telegraph was sound enough in principle, he never actually succeeded in perfecting it. Practical harmonic telegraph systems were developed by others, notably Elisha Gray. Today somewhat the same principle is employed in carrier telephone and telegraph systems, voice-frequency-operated devices; and, of course, radio transmission on various frequencies to avoid interference with one another is a precise and extended application of resonance or sympathetic vibration.

There could have been many reasons why, hard as he tried, Bell did not succeed with his harmonic telegraph. First, his knowledge of electricity and mechanics was *not too great*. Then, he had never been particularly adept with the use of his hands. Further, his great interest in acoustics and speech naturally made the problem of "telegraphing speech" directly more intriguing than an indirect system of communication requiring code characters.

### *Designs Simplified Apparatus*

Nevertheless, in 1873 and 1874, Bell persisted in his attempts to build a practical harmonic telegraph. From tuning forks he turned to tuned vibrating reeds equipped with double electromagnets and, for transmitting, adjustable make-and-break contacts. The receiving vibrator, of course, required no contacts. Actually, these devices were similar to modern high-frequency buzzers. While they proved somewhat better than tuning-fork vibrators, Bell made an even simpler version using only one magnet for each vibrator. Also, the reed and the spacing between reed and magnet were made adjustable.

### ***Develops Method of Tuning Reeds— Important to Telephone Invention***

While experimenting with these instruments, Bell discovered that when the reed vibrated freely it responded to a single pitch. If the transmitted pitch differed only slightly from the pitch to which the receiving reed was adjusted, no signal could be heard. He found, however, that the reeds could be forced to respond to a band of frequencies by damping the free end of the reed. This he accomplished by pressing the reed firmly against his ear while the transmitting instrument was in operation. Then, plucking the reed with his finger, he noted the pitch of the sound produced by its free vibration. If the sound, when the vibrations of the reed were damped, was higher or lower in tone than the normal pitch of the free reed, he raised or lowered the free pitch by shortening or lengthening the vibrating portion of the reed; his object in either case being to bring the free period of the reed into unison with the vibrations of the transmitting instrument. This practice was to have an important bearing on the invention of the telephone.

In all of his experiments thus far, Bell had connected his transmitters and receivers directly into the line, using two wires between the transmitting and receiving stations to form a complete circuit. However, telegraph apparatus operated with a single wire and a ground return. The resistance of such a circuit was too high to permit operation of the simple battery circuits Bell was using and, if two wires were required in the harmonic telegraph system, the advantage of such a system would be greatly reduced. About December, 1873, the idea occurred to Bell of operating his harmonic telegraph by causing the transmitting interrupters each to make and break the primary circuit of an induction coil, the secondary circuit of which could be placed in the main line by depressing a key. This arrangement permitted use of a ground return, but the induction coils introduced a new difficulty. Whereas in the first instance Bell was sending a simple, interrupted direct current between

transmitter and receiver, now he was producing a ragged alternating current that the receiver reed could not readily follow.

Bell considered and tried various methods of overcoming this difficulty. It occurred to him that a permanently magnetized reed, if caused to vibrate by mechanical means, could itself occasion electrical impulses of the kind required in the coils of its electromagnet. He planned to set his transmitting reeds in vibration by directing a current of air on them as in the case of organ reeds. But he doubted whether an electric current generated by the vibration of a magnetized reed in front of an electromagnet would be powerful enough to produce at the receiving end of the circuit a vibration sufficiently intense to be practical for use on real lines for multiple-telegraph purposes. So, instead of pursuing the idea further at that time, he devised a rotary circuit breaker to interrupt the current rapidly enough to provide intermittent currents equal in frequency to that of the receiving reed.

### ***The Phonautograph and Manometric Capsule***

During the winter of 1873-1874, while Bell was experimenting with his harmonic telegraph, he also investigated the possibilities of two devices then in use in the physics laboratory at the Massachusetts Institute of Technology. They were the phonautograph and the manometric capsule. Both instruments produced visible patterns from sounds. Bell saw the possibility of utilizing them in his work of teaching speech to deaf children.

The phonautograph consisted of a speaking trumpet closed at one end by a stretched membrane to which was attached a light wooden lever bearing a bristle stylus at its far end. The point of the bristle just touched a plate of smoked glass which could be moved at a uniform rate across it. When the bristle was vibrated by the voice speaking into the trumpet, it traced a shape on the plate that varied with the sound uttered.

The manometric capsule consisted of a cavity

in a piece of wood, divided in half by a diaphragm of gold-beater's skin. One side had a gas inlet and a burner connected to it, while the other compartment was connected to a speaking tube. When sound entered the tube, the air vibrations were communicated through the membrane to

He felt that, if he could produce a clearly defined pattern of sound, for instance the sound of  $\bar{e}$ , then the deaf child could practice uttering the sound into a phonautograph or manometric capsule until he could duplicate the pattern with certainty. However, neither device produced useful patterns.

### *Human-Ear Phonautograph*

Bell noticed that the phonautograph somewhat resembled the structure of the human ear. Once again returning to Nature, as he did when he built the speaking machine, Bell decided to study the human ear mechanism more closely with the idea of constructing a phonautograph more like an ear. He, therefore, discussed the problem with Dr. Clarence J. Blake, a noted Boston ear specialist. Blake suggested that Bell attempt to construct a mechanism from an ear taken from a dead person. Dr. Blake prepared a specimen for Bell who used it successfully in making tracings of sound vibrations on smoked glass.

The human-ear phonautograph never produced patterns suitable for teaching speech to deaf children, but it had two qualities that were directly instrumental in leading Bell's thinking toward the invention of the telephone. First, Bell marvelled at the ability of the tiny ear-drum diaphragm to move the proportionally huge bones of the inner ear, as a result of the vibration of sound waves. The evidence of this motion was translated by the phonautograph into a visible pattern right before his eyes. Further, since the phonautograph was a crude form of oscillograph, he could see that sound waves followed a pattern that was undulatory in character. It has been said that, in relating this point to his knowledge of acoustics, and then further relating it to the undulating pattern electrical currents would have to follow to reproduce sound, Bell hit upon the basic factors that made the electric telephone possible. In the light of present knowledge, where these relationships are commonplace, the importance of Bell's reasoning and discovery might easily be missed. But considered in the light of the historical facts, it has been proved that none of Bell's contemporaries, attempting to produce a talking telegraph, employed the principle of the undulatory current.

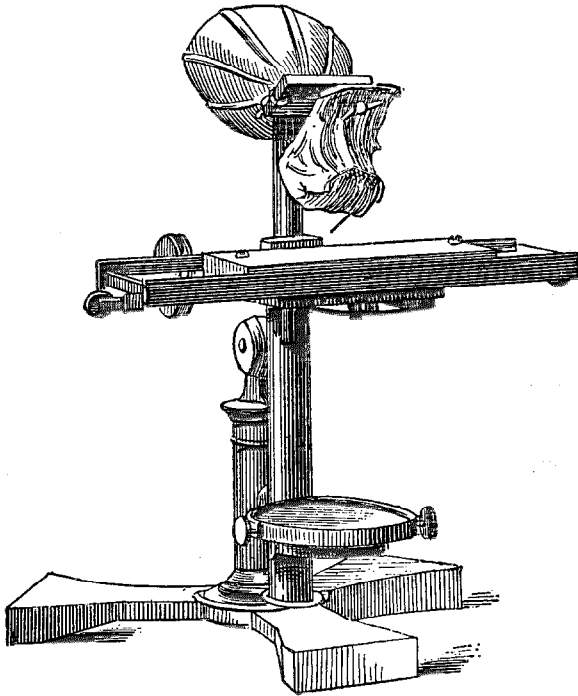

Drawing of the human-ear phonautograph built by Alexander Graham Bell in 1874. The stylus wrote sound patterns on a plate of smoked glass which was moved across the upper platform. The above drawing appeared in the published pamphlet of Bell's lecture on the telephone presented before the Society of Telegraph Engineers, Westminster, England, 1877.

the gas and thence to the flame of the lighted burner. The flame, accordingly, followed the sound variations. On viewing the reflection of the flame in a mirror revolving at a suitable speed, the resulting stroboscopic effect showed definite sound patterns. For example, the vowel  $\bar{e}$  presented the appearance of a long band of light with teeth like a saw. When the sound was changed to  $\bar{i}$ , as in "it," each tooth of the saw became notched. The vowel  $\bar{e}$ , as in "bed," caused the appearance of a pleasing and complicated pattern that resembled lace.

Bell hoped to use one device or the other to photograph wave patterns for his deaf pupils.

### Further Concepts of Undulatory Current

Bell's experiments with the human-ear phonograph were performed during the summer of 1874 while he was at Brantford, Ontario, visiting his father during a vacation period. In the course of that summer, in connection with his work on the harmonic telegraph, his thoughts went back to the idea of mechanically vibrating a polarized reed in front of a magnet. He came to realize that the vibration of the reed would produce on the line wire an undulatory current of electricity corresponding to the undulatory motion of the reed. That is, the direction of polarity of the induced current sent over the line would correspond to the direction of the motion of the reed, being positive when the reed moved in one direction and negative when it moved in the other. Also, the intensity of the current would correspond, from instant to instant, to the velocity of the movement of the reed, being greatest when the reed was moving fastest.

Bell next considered the effect of two or more reeds set into vibration simultaneously. He could see that, when two reeds were in phase, their currents would aid each other, while when

they were out of phase the currents might be opposed. He then concluded that <sup>4</sup>

the resultant electrical effect produced upon the line wire by the simultaneous vibration of both reeds would then be expressed by a curve representing the algebraical sum of the two curves considered.

Studying this effect further, Bell saw that a similar result would follow if he had a multitude of reeds of different pitch, each with its own coil, and all the coils connected in one circuit. The thought then occurred to him of having a single electromagnet for all reeds instead of a separate coil for each reed. This line of thought led Bell to the conception of the "harp" apparatus.

In the harp apparatus, identical instruments were to be used at each end of the line and each instrument was to be capable either of transmitting or receiving. Two series of steel reeds, each having a different pitch, and all polarized from a single permanent magnet, were to be placed opposite the pole pieces of a wide electro-

<sup>4</sup> Deposition, Circuit Court of the United States, District of Massachusetts. No. 2356A, page 33. Printed by the American Bell Telephone Co., 1908, as the "Red Book."

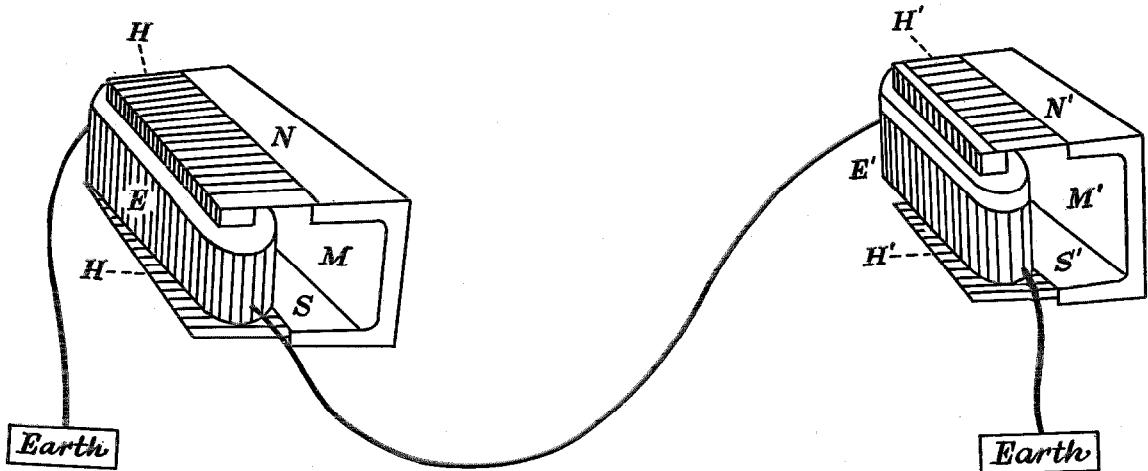

Bell's conception of his "harp" telegraph apparatus. *H, H* were two series of steel reeds, each reed having a different pitch. A single permanent magnet *M* was to be employed. An elongated electromagnet *E* was to be placed between the two series of reeds so that the free end of each reed might be close to the pole of the electromagnet without touching it. Bell never reduced this idea to practice, because it became evident to him that a single diaphragm could function as well as the many reeds.

magnet so that the free end of each reed would be close to one of the poles of the electromagnet.

The concept of the harp apparatus brought him back to the phenomenon which he had

resultant sound patterns of all vibrations impressed on them, regardless of their complexity.

He concluded that a single reed, if it could be made to vibrate like these diaphragms, would

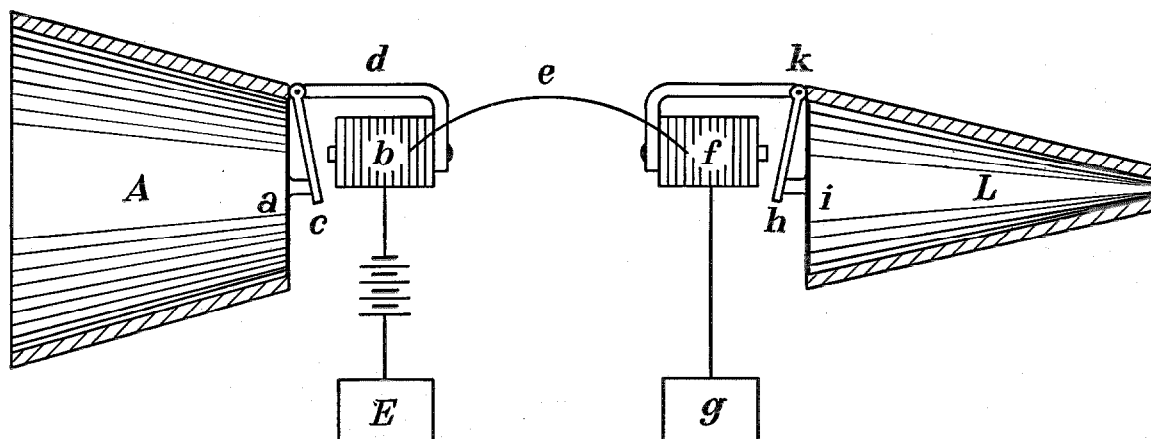

Copy of the drawing of "Figure 7" from Bell's patent of the telephone issued March 7, 1876. The transmitter is shown at the left and the receiver at the right. In actual practice, Bell found that equipment similar to this would transmit speech without the battery shown connected to the transmitter.

originally used to illustrate the idea of the harmonic telegraph, the sympathetic vibration of piano strings when notes are sung close to them. In like manner, if a harp had enough reeds, it should pick up every sound of the voice. One could talk into it, and the vibrations would be carried by a complex current to a similar receiver which then would vibrate in such a way that the sound would be repeated. Bell never built the harp apparatus. He felt it would be too complicated to be practical, and, at the time, it would have been too expensive for his limited resources.

### *The Membrane Speaking Telephone*

Since Bell was not actually attempting to build the harp apparatus that summer in Canada, he was left free to speculate on further refinements. He knew that the manometric capsule and the phonograph, employing a single diaphragm, were able to reproduce graphically

generate the same complicated currents as an infinite number of reeds on the harp.

From this line of reasoning came the conception of the membrane speaking telephone. Before he left Brantford, Bell had worked out the plan for such a telephone. His plan was to attach the free end of a reed to the center of a stretched membrane, but instead of firmly fastening the reed to the pole of a permanent magnet, the magnet pole was simply to be brought into close proximity to the hinged end of the reed, so as to polarize it by magnetic induction. The arrangement thus conceived was substantially similar to that subsequently shown as "Figure 7" of his U. S. patent 174 465 of March 7, 1876.

While Bell was satisfied that the apparatus he had conceived would produce voice currents, he doubted that strong enough electrical currents would be generated to be heard at the end of a real line. Since experimentation was costly in time and funds, he decided to return to the apparently more practical task of the harmonic



telegraph. He did not, therefore, construct the projected telephone when he returned to Boston.

Although Bell received some income from teaching, it is doubtful if he would have been able to proceed so rapidly with his work if he had not obtained financial help. This aid he began receiving in the fall of 1874 from both Hubbard and Sanders. The two men had separately volunteered to give Bell financial assistance. So Bell, somewhat embarrassed by two such offers, brought them together. At this meeting Hubbard and Sanders agreed to share equally in Bell's expenses, which he put at an extremely modest figure. They also agreed at the time that the shares in any resulting patents would be divided equally three ways.

#### ***Bell Meets Thomas A. Watson***

Bell began by building his own equipment, but, at length, it became clear to him that he lacked both the skill and the time to do this work properly. So he took some of his apparatus to the shop of Charles Williams, Jr., at 109 Court Street, Boston, to be refashioned by an expert electrician. The young man assigned to this work was Thomas A. Watson. Later, Bell asked Watson to leave the Williams shop and come to work for him. They not only became fast friends, but after a time Watson was made the fourth member of the group to share in the patents as part payment for his work.

By February 1875, when Bell was only 28 years old, his harmonic telegraph had advanced to the point where he thought patent applications should be filed on it. Consequently, during that month, he put off all pupils and classes and visited Washington, D. C., to draft specifications and file three patent claims. While there he saw Joseph Henry, then secretary of the Smithsonian Institution. Henry saw Bell's hastily set up telegraph apparatus and Bell talked to the aged scientist about his telephone theory and asked if he should publish it. Henry advised against it, telling Bell that he had the germ of a valuable idea. Bell replied that he feared he lacked the electrical knowledge to work it out. Henry simply said, "Get it!" and encouraged him in other ways. Later Bell wrote, "But for Joseph

Henry, I should never have gone on with the telephone."

Bell received a patent on his harmonic-telegraph apparatus a few days after his talk with Henry. While still in Washington, Bell demonstrated the apparatus to William Orton, president of the Western Union Telegraph Company. Western Union was then the largest corporate body in the U. S. A. Consequently, it was the logical and, perhaps, the only customer in this country for any telegraph invention. Moreover, the telegraph company's wires were known to be terribly overloaded with messages and it was generally understood that Western Union would pay as much as a million dollars for a device capable of increasing the number of messages that could be sent over a single line in a given time.

It was natural that a practical business man like Hubbard, under these circumstances, would prefer to see Bell develop the harmonic telegraph rather than the telephone, which was regarded even years after it became a reality as a toy or, at most, a diverting lecture subject. So, despite all of Bell's dreaming about the telephone, the insistence by Hubbard and others that he continue with the harmonic telegraph could not be ignored. Besides Bell, who was greatly in need of funds, saw the possibility of selling the telegraph patents for a large sum which would provide for his experimenting to his heart's content with the telephone.

Bell was heartened when the demonstration before Orton in Washington went well and he received an invitation to bring the harmonic telegraph to Western Union's laboratory in New York City. He was told by Western Union engineers in New York that the apparatus still had bugs and he received a number of suggestions for making improvements.

#### ***Transmission of Sound***

When Bell returned to Boston, he had Watson make up three sets of multiple-telegraph apparatus of the make-and-break variety employing tunable reeds. These were set up in the attic of the Williams building, where Bell had obtained the use of two adjoining rooms; a wire line was strung between them.

On June 2, 1875, Bell and Watson were ready for a test of this apparatus. Bell, at one end of the line, was tuning up the metal reeds on a group of receivers. Watson, in the adjoining room, was sending the tones of the transmitters to Bell. What followed was probably the most crucial moment in the invention of the telephone. That moment was described by Watson as follows:<sup>5</sup>

I had charge of the transmitters as usual, setting them squealing one after the other, while Bell was retuning the receiver springs one by one, pressing them against his ear. . . . One of the transmitter springs I was attending to stopped vibrating and I plucked it to start it again. It didn't start and I kept on plucking it, when suddenly I heard a shout from Bell in the next room, and then out he came with a rush, demanding: "What did you do then? Don't change anything! Let me see?" I showed him. It was very simple.

The make-and-break points of the transmitter spring Watson was trying to start had accident-

<sup>5</sup> Thomas A. Watson, "The Birth and Babyhood of the Telephone," *Proceedings of the Telephone Pioneers of America*, p. 36; Oct. 17, 1913.

tally been brought into permanent contact, so that when he snapped the spring the circuit had remained closed. Of this, Watson said:<sup>5</sup>

. . . that strip of magnetized steel, by its vibration over the pole of its magnet, was generating that marvelous conception of Bell's—a current of electricity that varied in intensity precisely as the air was varying in density within hearing distance of that spring. That undulatory current had passed through the connecting wire to the distant receiver which, fortunately, was a mechanism that could transform that current back into an extremely faint echo of the sound of the vibrating spring that had generated it, but what was still more fortunate, the right man had that mechanism at his ear during that fleeting moment, and instantly recognized the transcendent importance of that faint sound thus electrically transmitted. The shout I heard and his excited rush into my room were the result of that recognition. The speaking telephone was born at that moment.

Bell, in holding the harmonic receiver tightly against his ear, effectively clamped the free end of the reed or spring, thus damping its natural rate of vibration and causing it, instead, to vibrate in a manner analogous to the diaphragm of the modern telephone receiver. Instead of the customary whine of the intermittent battery current, he had heard an unexpected sound—the twang of a plucked reed—a tone with overtones.

What removes this occurrence from the realm of chance discovery is the fact that Bell, who not only had reasoned that such a current could be generated but foresaw the results it would produce, was probably the one man in the world at that time qualified by training and acuteness of ear to recognize in the faint sound that came to him a confirmation of his theories.

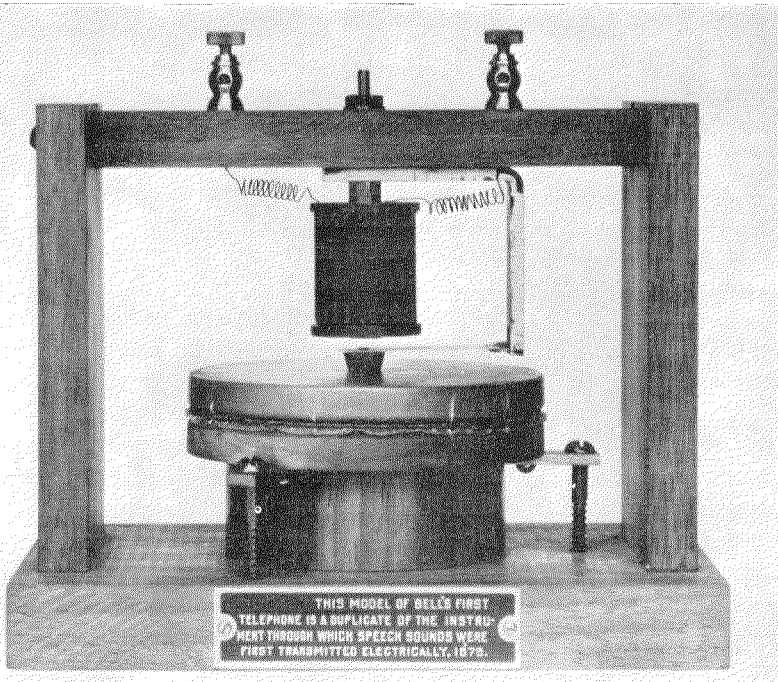

It was an instrument like this that Thomas A. Watson made for Alexander Graham Bell overnight from June 2 to June 3, 1875. It transmitted speech sounds, thus encouraging Bell to go on with development of the telephone.

As Bell subsequently wrote about the event in the language of a patent suit deposition:<sup>6</sup>

These experiments at once removed the doubt that had been in my mind since the summer of 1874, that magneto-electric currents generated by the vibration of an armature in front of an electromagnet would be too feeble to produce audible effects that could be practically utilized for the purpose of multiple telegraphy and of speech transmission.

### *First Voice Sounds Received*

Before that history-making day was ended, Bell and Watson had tried and retried the same experiment many times. The next step was to construct the first speaking telephone. Bell gave Watson directions, which followed closely the design of the membrane telephone he had conceived in Brantford the summer before. One of the harmonic receivers was to be mounted in a wooden frame, the free end of its spring to be fastened to a small bit of cork attached to the middle point of a drumhead or diaphragm of tightly stretched parchment also mounted in the wooden frame. There was to be a mouthpiece for concentrating the voice waves on the opposite side of the diaphragm.

The next day, June 3, 1875, Watson built the first electric speaking telephone. It had many deficiencies, but before that day was ended enough faults had been corrected so that it could transmit the sound of Bell's voice to Watson. Because the energy generated by the transmitter was weak and the receiver was insensitive, Watson could not hear words, just recognizable voice sounds. Today, however, an exact replica of this first telephone, when connected as the microphone of a public address system, transmits perfectly clear and intelligible speech with a slightly boomy resonance. Connected as a receiver to the output of an amplifier, reproduction is clear enough, but weak and predominant in lower-register frequencies.

Bell and Watson went on experimenting with the telephone all summer. In September, while again at Brantford, Bell started writing the specifications for his first telephone patent. The claims thus written ultimately resulted in his basic U. S. patent 174 465 granted on March 7,

1876. From the draft which he wrote and re-wrote, resulted the important fifth claim of that patent:

The method of, and apparatus for, transmitting vocal or other sound telegraphically, as herein described, by causing electrical undulations, similar in form to the vibrations of the air accompanying the said vocal or other sounds, substantially as set forth.

Bell had spent about five months casting and recasting the patent specifications. During these months he had sought a method of putting a stronger undulating current on the line than was possible with magnetic induction. He had decided this could be done by causing a resistance to fluctuate, so that a current through it would be stronger and weaker as the transmitter diaphragm vibrated. After considering several means of providing such a variable resistance, he decided to use a wire, working like a plunger, up and down in a conducting fluid. So Bell included in his patent specification the description of a transmitter wherein—as the voice made the transmitter vibrate—the wire attached thereto would move up and down in a fluid conductor. As it went deeper, it lessened resistance; as it rose again, the resistance increased. Current passing through the wire and fluid would thus undulate as the sound waves varied.

### *Financial Difficulties*

The winter of 1875–1876 was a difficult time for Bell. He wanted to get on with his telephone and develop it to the point where it actually transmitted words. But he felt an obligation to his backers, Hubbard and Sanders, and Hubbard still favored the harmonic telegraph. Unfortunately, in the agreement they had made, Bell had neglected to request funds for himself and now needed money. Consequently, he gave a series of lectures in the fall of 1875. About this time he also completed arrangements with the Honorable George Brown of Toronto, Ontario, and his brother Gordon to pay the expenses of private rooms for housing his electrical apparatus. He felt he needed these rooms because he had heard of strangers visiting the Williams shop and examining his apparatus. With funds provided by the Browns, he engaged two rooms at a boarding house at 5 Exeter Place, Boston,

<sup>6</sup> Deposition, Circuit Court of the United States, District of Massachusetts, No. 2356A, page 59. Printed by the American Bell Telephone Co., 1908, as the "Red Book."

Massachusetts, to which he moved his apparatus in January, 1876.

He then gave up his lectures and devoted his entire time to experimenting. Watson continued to construct his apparatus and assisted in testing it. Bell's zeal at this time has been attributed to his desire to marry Mabel Hubbard. He knew that his professional work, if continued, could yield him a modest income; but he was confident that, if he devoted his attention exclusively to his electrical inventions, they would bring him a fortune—and a fortune was the only thing the modest Bell cared to offer Mabel, daughter of the wealthy Gardiner Greene Hubbard.

### *First Sentence Received*

The first experiments at the Exeter Place rooms were, strangely enough, not with the telephone, but with the harmonic telegraph which Bell was still trying to perfect and sell to Western Union. At the time he was working on an electric spark arrester for the contacts of the make-and-break circuits of the transmitters. This was so similar to the variable-resistance transmitter he had described in his patent specification that out of it he developed such a transmitter.

It was on March 10, 1876, three days after the telephone patent was granted to Bell, that the first complete and intelligible sentence ever transmitted by telephone was heard. The circumstances were as dramatic as any connected with Bell's previous efforts to transmit speech. Watson had built a variable-resistance transmitter and both Bell and he were planning to spend the night at Exeter Place testing it.

Neither of them had any idea that they were about to use the best transmitter yet devised. They diluted the sulphuric acid for its cup, connected it to the battery and to the wire running between the rooms, and then Watson went to the other room to listen.

Almost immediately Watson heard Bell's voice come shouting from the receiving instrument, "Mr. Watson, come here, I want you."

It was a call for assistance. Bell had spilled some battery acid over his clothes as he completed setting up the test transmitter. Since it was only a one-way line, Watson ran to Bell's end of it to shout, "Mr. Bell, I heard every word you said—distinctly." The electric telephone had spoken at last, and so clearly that doubt no longer existed as to its capability of transmitting articulate speech.

### *Iron-Box Receiver*

Bell and Watson continued to improve their apparatus and it was about that time that Bell designed the receiver that was to be the forerunner of all telephone receivers. He called it the

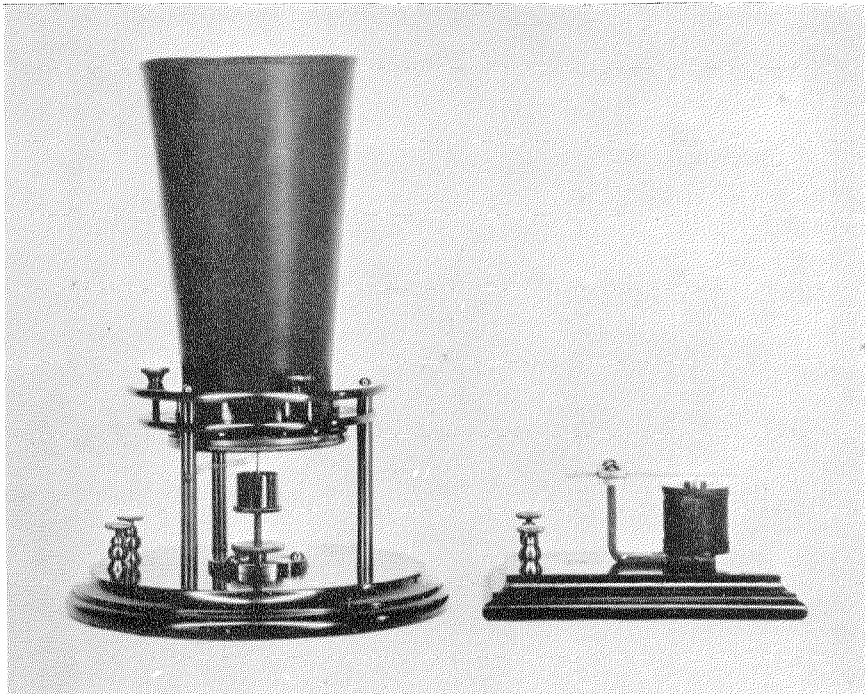

Replicas of the variable-resistance transmitter and reed receiver. It was over equipment such as this that Bell shouted, "Mr. Watson, come here, I want you." This was the first intelligible sentence received over the telephone.

"iron-box" receiver. It employed a metal diaphragm and operated on exactly the same principle as the telephone receiver in use today.

As already described, it had been Bell's habit, while using a tuned-reed receiver, to prevent free vibration of the reed by pressing it closely against his ear. It occurred to him to overcome this difficulty by fettering the free end. At first he proposed clamping both ends of the reed and attaching them to the outer two poles of a W-shaped electromagnet. He soon concluded, though, that a cylindrical iron box with a central core would be better. As he worked it out, the end of the central core became one pole of the tubular magnet thus formed and the rim of the iron box the other pole. By placing a lid or diaphragm on the end of this magnet, he had an armature that was damped all around its periphery and polarized by contact with the rim of the box. The iron-box receiver worked better than any he had used previously. It was this receiver that he demonstrated at the Philadelphia Centennial Exposition in June, 1876.

#### *Tries to Sell Patents for \$100,000*

Bell now had apparatus that worked effectively. He had a patent covering the telephone.

But he had a long struggle ahead of him. First, he had to prove that the telephone would operate over long stretches of wire. Then, he had to convince the skeptics that the telephone was more than a scientific toy. People generally refused to believe that transmitting the voice over wires was possible. When they actually heard the telephone work, they thought it was accomplished by trickery. At one time, Bell was so discouraged that he offered his patents to Western Union for \$100,000. Fortunately for him, Western Union turned him down. It has been said that a few years later Western Union would have been glad to pay twenty-five million dollars for the Bell patents.

Bell's magnificent speaking voice and his experience as a lecturer served him well during these discouraging years. He gave numerous lectures and demonstrations and actually "sold" the telephone to the public.

These efforts kept Bell from new experiments for several years. Shortly after his return from his honeymoon in England, he began to relinquish to others the task of improving the telephone and developing the necessary associated apparatus. Throughout his life, however, he maintained his interest in scientific matters covering a wide range of subjects.

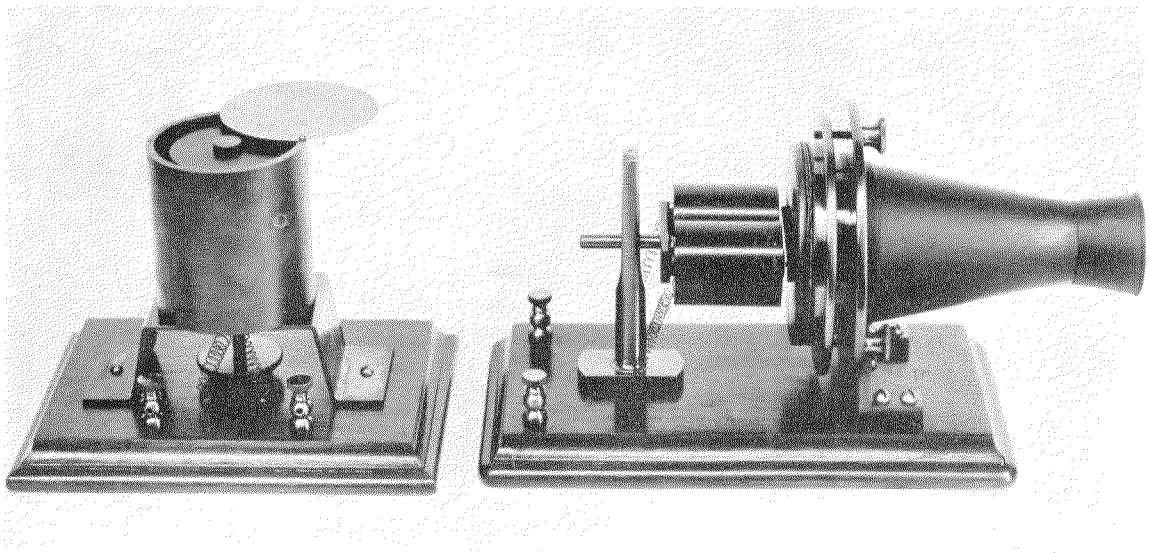

Replicas of the "iron-box" receiver and an improved magnetic transmitter. The iron-box receiver was developed by Bell shortly after the first intelligible speech was transmitted over the telephone. It employed a metal diaphragm and permanent magnet in a form comparable to the most modern receivers used in telephones today.

### *Founds Volta Laboratory*

In 1880, he perfected and patented the photophone, a device for transmitting speech over a beam of light. Bell used the well-known principle that the resistance of crystalline selenium varies with change in light intensity. Little or no practical return came to Bell from his invention. It is interesting to note, however, that this same principle of transmitting speech over light rays was used by both sides for communication purposes during World War II. Also, at present, experiments are under way with a view to using infra-red rays, as Bell used them in his photophone, for applications such as the relaying of television programs.

An offshoot of his work with the photophone, Bell called the spectrophone, which he described in a paper before the National Academy of Sciences on April 21, 1881. He had noted in the course of his experiments that many substances, when subjected to an intermittent beam of light, would give off a tone in a telephone receiver. He drew attention to the use of such equipment, particularly, in the detection of invisible rays. As far as is known, nothing came of these experiments.

In 1880, Bell received the Volta prize of 50 000 francs from the French government for his invention of the telephone. With the money, he established the Volta Laboratory at Washington, D. C., in collaboration with Sumner Tainter, a maker of optical instruments, and Chichester A. Bell, a cousin who was a specialist in organic chemistry. Each of the three was to work on his own line of pure research. However, when funds began to run out, they decided to take up some line of applied science jointly to finance the institution.

### *Volta Group Develops First Disk Phonograph Records*

They developed an improvement in the making of records for Thomas A. Edison's phonograph which, invented in 1877, was still using metal foil as a recording medium. The Volta group took out the basic patents for phonograph recording on wax cylinders and disks, and sold these to an operating company that launched the recording industry as it is known today. The original idea

for using a disk was to permit voice recordings to be mailed conveniently. They were intended as a substitute for written messages, a practice which has only begun to come into use recently.

Bell put his share of the proceeds of the sale of the recording patents into a branch of the laboratory he named the Volta Bureau, set up specifically to carry on his work for the deaf. The Bureau at that time was making a statistical study of deafness, particularly of the probability of inherited deafness. The Volta Bureau, still at Washington, continues its work to this day in behalf of the deaf.

### *Electric Probe*

When President Garfield was shot in 1881, Bell, who was then living in Washington, hit upon the idea of locating the bullet with an induction balance. In the heat of that Washington summer, Bell labored day and night to test the ability of the induction balance to locate metallic masses in the human body. However, Bell's attempts to locate the bullet in the president failed because the doctors in attendance, although trying to comply with Bell's request to remove all metal from Garfield's surroundings, overlooked a steel bedspring directly beneath him. When discovered, further tests were hampered by the fact that Garfield's condition made it difficult to move him. After Garfield's death, Bell perfected an electric probe which was used in surgery for several years and for which he received an honorary degree of Doctor of Medicine from Heidelberg University in 1886. X-ray technique supplanted the probe about the turn of the century.

### *Stops Work on Telephone*

Although Bell continued scientific research for the rest of his life, it was about this time that he stopped further work on the telephone and other electroacoustic devices. One reason may have been the discouraging round of patent suits he and his associates had to face. Although Bell's right to the telephone patent was upheld by the highest courts, his sensitive nature recoiled from such experiences.

Another explanation is given in a letter written by Mrs. Bell shortly after his death:

I verily believe (she wrote) that the reason Dr. Bell did not follow up his invention of the photophone—the reason he did not follow that up, and the reason he took up aviation instead was that I could not hear what went on over the radiophone (as the photophone was called later) but that I could see the flying machine.

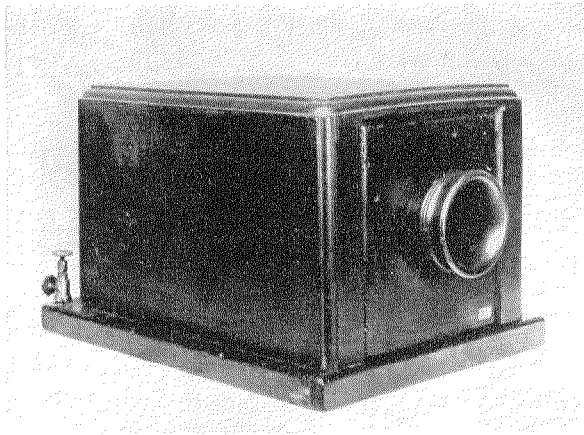

The first commercial telephone was this wooden-box model, used in 1877. It was soon supplanted by other forms of boxes, then by hand telephones turned out of wood, that resembled closely the receivers later used on desk telephones.

General John J. Carty, who received this letter, commented as follows:<sup>7</sup>

It was a very touching letter and reminds me of what happened on his great day of triumph when Bell talked across the continent to Washington and when he received the congratulations of the Chief Magistrate of our Nation. Mrs. Bell was there and Bell, with poignant sadness, looking toward his wife, said to me, "And to think that she has never heard through the telephone."

Bell had great faith in the future of aviation and spent much of his time in research on this subject. All his life Bell had been interested in flight, and his support to aviation was given at a time when to do so risked his scientific reputation. In 1891, he contributed \$5000 for Langley's aviation experiments and on May 6, 1896, saw the successful flight of Langley's steam-driven 16-foot model which, however, did not carry a man.

<sup>7</sup> John J. Carty, "Episodes in Early Telephone History," *Bell Telephone Quarterly*, v. 5, pp. 66-67; April, 1926.

### *Elected Regent of Smithsonian Institution*

When, in 1898, Bell was elected a Regent of the Smithsonian Institution, his enthusiasm for Langley's experiments had much to do with obtaining from the War Department an appropriation of \$50,000 to be used by Langley for the development of aeronautics.

In 1898, he became president of the National Geographic Society and served in that capacity until 1903. He helped finance the society and was instrumental in building its magazine into a national institution.

Much of Bell's later life was spent at his estate near Baddeck, on Cape Breton Island, Nova Scotia. He acquired the estate after a visit there in 1885 and named it Beinn Bhreagh. It was at Beinn Bhreagh that he set up a laboratory and carried on many experiments. While there, he kept a staff of experimenters busy on such diverse ideas as devising a means of condensing fog to furnish fresh water for men adrift at sea, and attempting to breed sheep that would bear more than one lamb at a time.

### *Varied Scientific Interests*

Besides numerous speeches and papers on subjects related to training the deaf to speak and the telephone, Bell wrote articles on the photophone, spectrophone, medical and surgical subjects, eugenics and longevity (based on his studies of the census), his experiments in sheep breeding, aerial locomotion, as well as many general subjects.

The breadth of his interests and the originality of his thinking are indicated by the fact that in 1882 he published "A Proposed Method of Producing Artificial Respiration by Means of a Vacuum Jacket" in which he describes a device anticipating today's iron lung. In 1885, following the collision of a steamer with an iceberg, he wrote advocating a method of determining the location of such an object at sea by detecting a sound echo from it. In a talk in 1906, he advocated measuring the depth of the ocean by echo. Toward the end of his life, he interested himself in the heating and ventilating of houses and, when he had to spend some weeks in Washington, D. C., one hot summer, he air-conditioned his study by directing an electric fan over cakes of ice.

### **Honors**

Among the honorary degrees conferred on Alexander Graham Bell were: Doctor of Laws: Illinois College, 1881; Harvard College, 1896; Amherst College, 1901; St. Andrew's University, 1902; Edinburgh University, 1906; Queen's University, Canada, 1908; George Washington University 1913; Dartmouth College, 1914. Doctor of Philosophy: National Deaf-Mute College (now Gallaudet College), 1880; Wurzburg University, 1882. Doctor of Science: Oxford University, 1906. Doctor of Medicine: Heidelberg University, 1886.

In addition to receiving the Volta prize in 1880, he was made an officer of the Legion of Honor by the government of France in 1881.

The medals awarded Bell were: Centennial Exposition, Philadelphia, 1876, gold medal for speaking telephone and gold medal for visible speech. Royal Cornwall Polytechnic Society, 1877, James Watt silver medal for the telephone. Massachusetts Charitable Mechanics Association, 1878, gold medal for the telephone and gold medal for visible speech. Society of Arts, London, 1878, Royal Albert silver medal for his paper on the telephone. République Française Exposition Universelle International, Paris, 1878, gold

medal for the telephone and a silver medal. Society of Arts, London, 1881, Royal Albert silver medal for his paper on the photophone. The Karl Koenig von Wuerttemberg gold medal. Society of Arts, London, 1902, Royal Albert gold medal for his invention of the telephone. John Fritz gold medal, 1907. Franklin Institute of Philadelphia, 1912, Elliott Cresson gold medal for the electrical transmission of speech. David Edward Hughes gold medal and a silver medal, 1913. American Institute of Electrical Engineers, 1914, Thomas Alva Edison gold medal.

Alexander Graham Bell's life ended on August 2, 1922, at Baddeck, Nova Scotia, where his body was laid at rest on the summit of a near-by hill.

### **Additional References**

- J. E. Kingsbury, "The Telephone and Telephone Exchanges—Their Invention and Development," Longmans, Green, and Co., London and New York, 1915.  
Catherine Mackenzie, "Alexander Graham Bell—The Man Who Conquered Space," Houghton Mifflin Co., Boston and New York, 1928.  
Frederick L. Rhodes, "Beginnings of Telephony," Harper and Brothers, New York and London, 1929.  
"The Career of Alexander Graham Bell," American Telephone and Telegraph Company, New York, 1946.



# France-England Submarine Cable (1939) and Paris-Calais Cable\*

By A. FROMAGEOT

*Laboratoire Central de Télécommunications, Paris, France*

**T**HE France-England submarine cable (1939) and the Paris-Calais cable are the first cables of French manufacture to include 12-channel telephone circuits; it also appears that they are the first cables in which the two transmission directions of a 12-channel carrier link were provided under the same lead sheath.

In this paper, the problems presented by the transmission of 12-channel carrier telephony over cable circuits is first reviewed; particularly the requirements for the Paris-Calais cable, as set forth in the special specification for it. The cable structure is then given in greater detail and some aspects of the manufacture of the submarine cable are described. Finally, the results obtained and the methods used are discussed.

The calculation of near-end cross-talk compensation between circuits having different propagation constants is developed in an appendix.

Communication between Paris and northern France has and continues to play a very important part in that country's economic life. In 1937, there were three cables for telephone conversations: a Paris-Boulogne cable (1927) and two Paris-Lille cables (1926 and 1933). However, the number of circuits available was still inadequate for handling the traffic requirements; consequently, the manufacture and installation of a new cable, the Paris-Calais-Saint Margaret cable, was considered. On the one hand, the circuit length and the Paris-London traffic density justified the use of 12-channel telephony, and, on the other hand, the accommodation of such important centers as Clermont, Amiens, and Calais required 2- and 4-wire circuits usually included in interurban telephone cables. The French Telephone Administration, therefore, decided to group in this cable both loaded circuits

for normal 2-wire working (H.88/36) and 4-wire working (H.22/9), and nonloaded circuits for 12 telephone channels used for Paris-London through connections.

The Sangatte-Saint Margaret cable was made in 1938-1939 and laid in July, 1939; then came the Paris-Calais cable, the manufacture of which began in 1939, and the through-splicing finished in 1941. The Paris-Calais cable is at present only partially used, circumstances having prevented the installation of equipment for 12-channel operation. These are the first cables of French manufacture which include 12-channel circuits. Therefore, some detailed information will be given concerning them.

## 1. Transmission Requirements for 12-Channel Circuits

### 1.1 TRANSMISSION PROBLEM

The problem is to transmit the same band of frequencies (48 kilocycles per second) over a number of pairs, some of the pairs being assigned to transmission in one direction, the other pairs to the opposite direction. The choice of frequency band is the result of a compromise. To facilitate the manufacture of repeaters (amplifiers), it is most convenient to use a relatively high frequency and thus decrease the bandwidth as a percentage of the transmission frequency. However, the circuit attenuation increases with frequency and this suggests the use of low frequencies. The band from 12 to 60 kilocycles was finally chosen, the attenuation between two successive repeater points being some 6 to 7 nepers.† Table I gives a comparison of these values with the corresponding values for the most commonly used loaded circuits.

The transmission of such a wide frequency band raises a problem of far-end cross talk. The operation of circuits with such high attenuation adds a near-end cross-talk problem.

† 1 neper = 8.686 decibels.

\* Originally published under the title, "Le câble sous-marin France-Angleterre 1939 et le câble Paris-Calais," *Revue Générale d'Électricité*, v. 54, pp. 271-280; September, 1945.

Far-end cross talk had already been studied for cables laid in the United States,<sup>1</sup> in England,<sup>2</sup> and in the Netherlands,<sup>3</sup> but near-end cross-talk difficulties between circuits transmitting in opposite directions had been avoided by placing these circuits in separate cables. For the Paris-Calais-Saint Margaret link, however, it was decided to include in one cable, i.e., under the same lead sheath, the 12-channel circuits of opposite directions. The solution of this problem is of particular interest for submarine cables, as there is an obvious advantage in not increasing unnecessarily the number of cables submerged in the Dover Strait; it is also of interest for land cables as it reduces the cost of the cable sheath and simplifies laying.

Experience with the previous cables<sup>1,2,3</sup> made it possible to determine the requirements for insuring an acceptable transmission quality with 12-channel pairs. These conditions are relative,

<sup>1</sup> A. B. Clark and B. W. Kendall, "Carrier in Cable," *Bell System Technical Journal*, v. 12, pp. 251-263; July, 1933.

<sup>2</sup> A. S. Angwin and R. A. Mack, "Modern Systems of Multi-Channel Telephony on Cables," *Journal of The Institution of Electrical Engineers*, v. 81, pp. 575-606; November, 1937.

<sup>3</sup> Groningue-Leeuwarden cable, laid in 1935.

TABLE I

TRANSMISSION CHARACTERISTICS OF TELEPHONE CIRCUITS

Type of Circuit	Frequency Band Assigned to Telephone Work (Kilocycles)	Attenuation Between Repeater Points (Nepers)
2-Wire H.88/36	0.3-2.7	1-2
4-Wire H.22/9	0.3-5.7	2.5-3.5
12-Channel Nonloaded Pair	12-60	6-7

TABLE II

CAPACITANCE UNBALANCES MEASURED AT 800 CYCLES

Circuit	For 100 Percent of the Lengths		For 90 Percent of the Lengths	
	Average ( $\mu\mu\text{f}$ )	Maximum ( $\mu\mu\text{f}$ )	Average ( $\mu\mu\text{f}$ )	Maximum ( $\mu\mu\text{f}$ )
Between side circuits of the same quad	46	180	34	135
Between pairs of adjacent quads	14	90	14	90
Between adjacent pairs	—	30	—	30
Between pairs of nonadjacent quads				
Between nonadjacent pairs	180	670	140	500
Between the two wires of one pair and ground				

first, to the electrical characteristics of manufactured cable lengths and, second, to the transmission characteristics of the cable sections between two repeater points. Requirements relative to conductor resistance, resistance unbalance, insulation resistance, leakage, and voltage breakdown are the same as for interurban cable circuits and will not be discussed. Only those characteristics especially applicable to 12-channel transmission will be considered.

## 1.2 ELECTRICAL CHARACTERISTICS OF CABLE LENGTHS

The values given below are those of the Paris-Calais cable specification. This cable was manufactured in lengths of about 230 meters (750 feet); the values for the submarine cable are slightly different because that cable was manufactured in lengths of 400 meters (1300 feet).

Diameter of conductors = 1.3 millimeters.

A. Effective capacitance (average of pair capacitances for one direction of transmission):

$35 \cdot 10^{-9}$  farad per kilometer  $\pm 5$  percent for 90 percent of the lengths manufactured.

$35 \cdot 10^{-9}$  farad per kilometer  $\pm 8$  percent for 100 percent of the lengths manufactured.

B. Difference between the capacitance of one pair and the average of the capacitances of all pairs assigned to the same direction of transmission (for each cable length):

average = 2.5 percent  
maximum = 7.5 percent.

C. Capacitance unbalances, measured at 800 cycles per second, are given in Table II.

D. Mutual impedances between circuits:

Circuits for the same direction of transmission, measured in units of  $10^{-9}$  henry at 5000 cycles: Between side circuits in the same quad—150 average, 540 maximum.

Between pairs of different quads, and between pairs: 115 average, 400 maximum.

Circuits for opposite directions of transmission, measured at 10 000 cycles: 0.9 average, 8 maximum.

### 1.3 CABLE CHARACTERISTICS AFTER INSTALLATION

Values for one repeater section:

- A. Characteristic impedance at 60 kilocycles:  $\pm 5$  percent difference from the mean value.
- B. 60-kilocycle attenuation: Less than 0.2 neper per kilometer.
- C. Far-end cross talk between pairs for the same direction of transmission: The lower limits, in nepers (to be maintained in the 12–60-kilocycle band), are as follows—Cross-talk deviation before compensation is 6.3 for all measurements, and 6.9 for 95 percent of all measurements; and cross-talk deviation after compensation is 7.5 for all measurements, and 8.1 for 95 percent of all measurements.
- D. Near-end cross talk between pairs of the same direction of transmission: The lower limits of this near-end cross-talk attenuation, expressed in nepers, are as follows—At 30 kilocycles, all measurements should be above 6.5, and 95 percent should be above 6.8. At 40 kilocycles, the values are 6.1 and 6.5, respectively; at 60 kilocycles, 5.8 and 6.1.
- E. Near-end cross talk between pairs of opposite directions of transmission: The lower limits of this near-end cross-talk attenuation are 13.8

nepers for all of the measurements, and 14.4 nepers for 95 percent of all measurements.

### 2. Design and Manufacture

The structure of the Paris-Calais and of the Sangatte-Saint Margaret cables is indicated in Table III. The loaded circuits are normal telephone circuits consisting of 0.9-millimeter copper conductors grouped into multiple twin quads with a nominal capacitance of  $38.5 \cdot 10^{-9}$  farad per kilometer. This cable also contains pairs (for the transmission of radio-broadcast sound) made of 1.4-millimeter copper conductors. The non-loaded circuits, designed for 12-channel telephone operation, are cabled in star quads and pairs. One group of 7 or 8 star quads, assigned to the same direction of transmission, forms the cable center, over which an electromagnetic shield consisting of alternate layers of copper and steel tape is applied. Over the shield is a group of 16 pairs assigned to the direction of transmission opposite to that of the star quads. The loaded telephone circuits are grouped in the outer layers. Fig. 1 shows the cable cross section (Paris-Clermont section). This is the first cable in which the two transmission directions of one 12-channel link have been included under a common lead sheath; and, so far as is known, it is the only cable of its kind in Europe or in America.

TABLE III  
STRUCTURE OF PARIS-CALAIS AND SANGATTE-SAINT MARGARET CABLES

Sections	Length Kilo- meters	Nonloaded 12-Channel Circuits		Loaded Circuits						Number of Con- nections
		North to South	South to North	2-Wire Circuits (Quads)		4-Wire Circuits				
				0.9 mm Copper	1.0 mm Copper	North-South		South-North		
		Quads	Broad- casting Pairs			Quads	Broad- casting Pairs			
Paris-Luzarches	33.54	8Q	16P	68	3	11	2	11	2	471
Luzarches-Clermont	33.25	16P	8Q	68	3	11	2	11	2	471
Clermont-Vendeuil	30.9	8Q	16P	40	5	11	2	11	2	393
Vendeuil-Amiens	31.72	16P	8Q	40	5	11	2	11	2	393
Amiens-Beauval	29.72	8Q	16P	31	3	11	2	11	2	360
Beauval-Saint Pol	29.10	16P	8Q	31	3	11	2	11	2	360
Saint Pol-Lillers	24.90	8Q	16P							
Lillers-Tilques	35.45	16P	8Q	40	5	11	2	11	2	393
Tilques-Calais	34.41	8Q	16P	35	3	9	2	9	2	360
Calais-Sangatte	9.14	16P	8Q	35	3	9	2	9	2	360
Sangatte-St. Margaret	36.00	7Q	16P	4	0	12	0	12	0	252
		16P	7Q	0	0	0	0	0	0	168

Q refers to quads, and P to pairs (12-channel carrier circuits).

The manufacture of the Paris-Calais cable does not present any new aspects; the requirements of 12-channel circuits demand cabling machines (more especially twisting machines) having a precision greater than that necessary for the production of voice-frequency circuits, but does not require the utilization of special machines.

The production of the submarine cable, however, was a delicate operation; to avoid splicing during the laying operations, an effort was made to produce the Sangatte-Saint Margaret cable in only one length. The problem was to manufacture an uninterrupted cable length of approximately 45 kilometers. This work was accomplished in several stages.

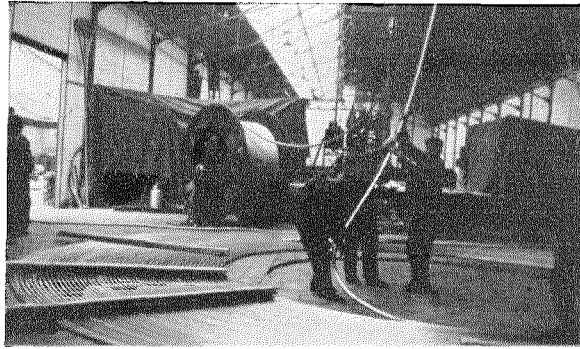

Fig. 2—Coiling of the first manufactured cable length preparatory to splicing; 41 similar lengths were laid over each other as a stack.

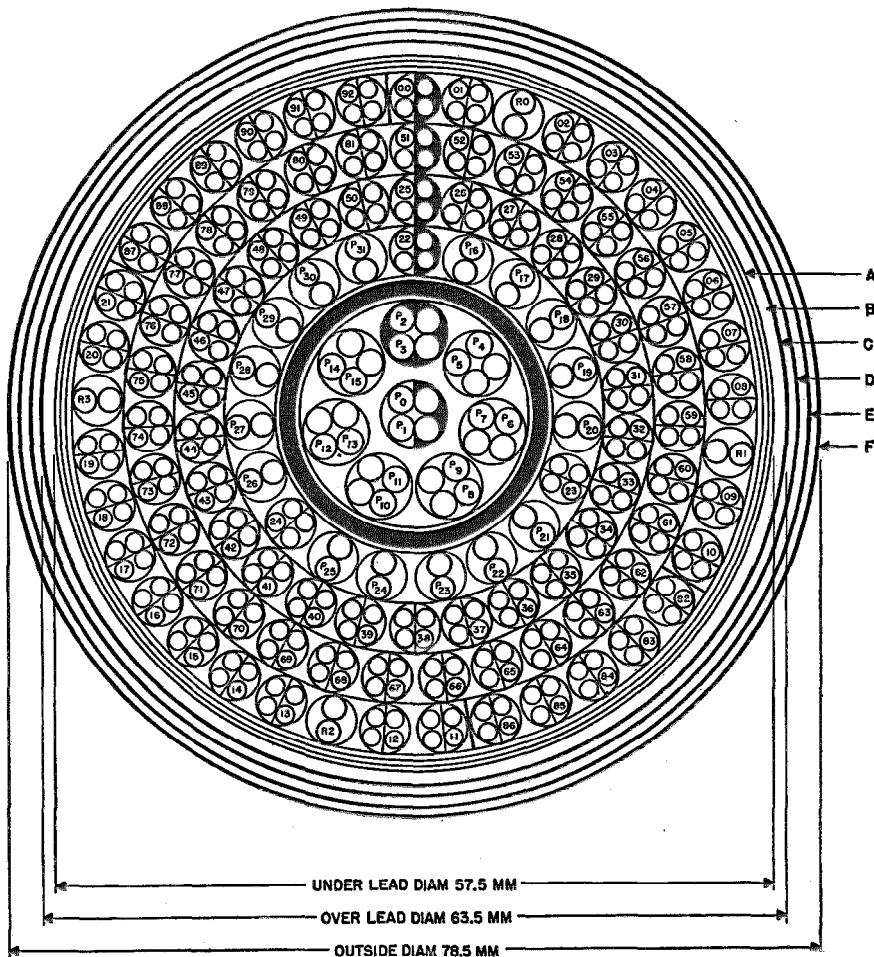

Fig. 1—Cross section of the Paris-Clermont (Oise) cable, consisting of 8 star quads (1.3-millimeter diameter), 16 pairs (1.3 millimeters), 3 DM quads (1 millimeter), 90 DM quads (0.9 millimeter), and 4 broadcast-program pairs (1.4 millimeters). The protective layers consist of: *A*—4 high-voltage paper tapes and 1 cloth tape; *B*—1-percent lead-tin sheath, 3 millimeters thick; *C*—2 impregnated-paper tapes; *D*—2 layers of impregnated jute; *E*—2 painted iron tapes; and *F*—2 layers of impregnated jute.

The cable core, i.e., the 7-quad central group, the electromagnetic shield, the 16-pair group outside the shield, and the paper wrappings were cabled in 400-meter lengths at the Conflans-Sainte-Honorine works of Lignes Télégraphiques et Téléphoniques. The lengths thus prepared were placed under a temporary lead sheath and sent by railroad to the submarine-cable plant of the firm, Les Câbles de Lyon, at Calais. The following operations were then performed: All splices were made; then, in a continuous sequence, the temporary lead sheath was removed, and a continuous lead sheath applied. Finally, the prescribed protective armoring was bound over the sheath.

Fig. 2 shows the coiling of the first cable length on the ground during splicing. The first 41 cable lengths were thus placed over each

other and formed a first stack; these coils were so disposed that the ends of all lengths were brought out in the vicinity of two points equipped for the splicing operations and designated (Fig. 3) as stations 1 and 2. The next 41 lengths were disposed in the same manner, so as to form a second stack.

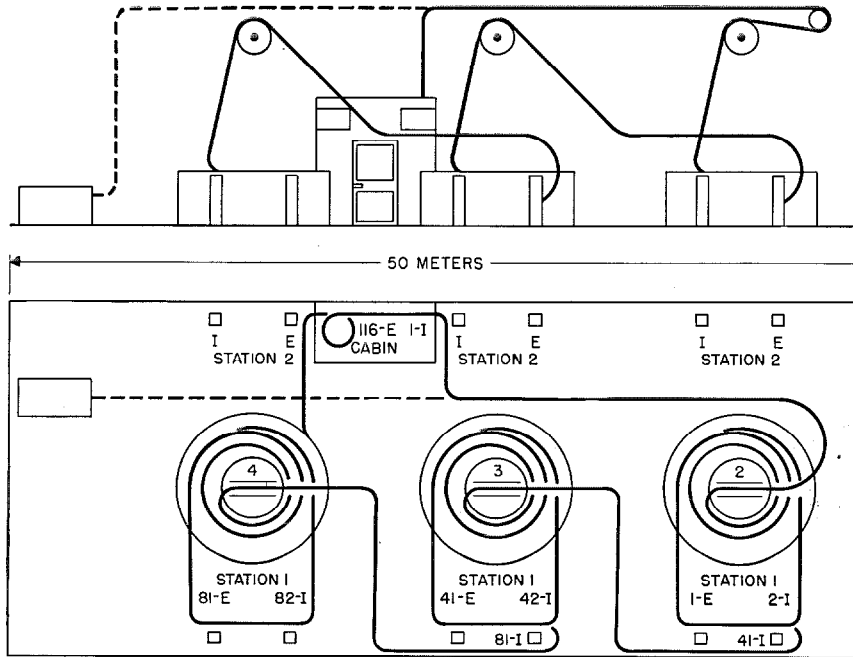

Fig. 3—Arrangement of 3 stacks of cable for splicing at stations 1 and 2. There were 41 lengths of cable in each of the stacks designated 2 and 3 and 34 lengths in 4.

Fig. 4 shows the coiling of the first length of this second stack. Behind it can be seen the stack formed by the first 41 lengths. Finally, a third stack similar to the others, contained the last 34 lengths. At each joining point, the conductor splicings were staggered over approximately two meters of cable so as not to cause any excess over-all thickness; at these points, the circuit twist was carefully preserved, and the continuity of the shield separating the two directions of transmission was restored. An absolute rule was made that there should be no overlapping of quads or pairs, each splicing point being covered with a lead sleeve having the same transverse dimensions as the cable sheath. This sleeve was closed lengthwise with tin solder and its ends were similarly soldered to the lead sheath of the cable.

Starting on December 23, 1938, by February 23, 1939, the cable was entirely spliced and ready

for further operations. Transmission tests had shown it to be satisfactory. This cable was approximately 45 000 meters long.

The following operations were performed by the firm, Les Câbles de Lyon. The 45 kilometers of cable were unwound, stripped of the temporary lead sheath, and the final lead sheath was applied. The operations for the whole cable were made in one run and required eight days.

On coming out of the lead press, the cable was coiled inside a tank and the water-tightness test was made. This test was made under a pressure of 1 to 2 kilograms per square centimeter (approximately 15 to 30 pounds per square inch), and, because of the propagation velocity, the pressure test lasted for two months.

Before armoring, the cable was wrapped in a rubber sheath of 6-millimeter thickness. This sheath consisted of 6 vulcanized-rubber tapes.

To obtain a uniform and compact sheath, the rubber tapes were covered with an accelerating self-vulcanizing solution. An intermediate tape, removed before applying each rubber tape, prevented the tapes from sticking together.

A layer of jute thread, 3 millimeters thick, was

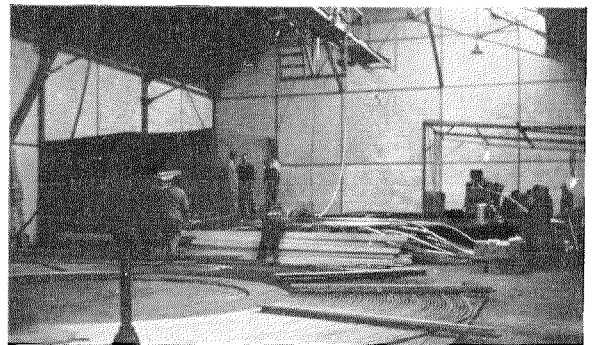

Fig. 4—Starting the second stack, the first stack of 41 cable lengths is in the background.

then applied over the cable. Armor wires, 7 millimeters in diameter, and finally several jute layers soaked with coal-tar and pitch were applied.

The insulation resistance between armor and cables, after a 48-hour immersion, was required to be at least 2 megohms. At the time of laying, it remained above 1000 megohms after several weeks of immersion.

The manufacture of the cable was entirely completed on June 25, 1939. The French Telephone Administration then made complete check tests and found that the cable satisfied the requirements laid down in the specification. The cable was then coiled on board the cable ship, *Ampère*, and was laid on July 25, 1939.

Cable laying in the Strait of Dover is especially difficult because of strong currents flowing between the North Sea and the English Channel, the current direction varying with the tides. This operation was successfully accomplished without serious incident.

On July 26, 1939, it was possible to talk over the circuits between Sangatte and Saint Margaret's Bay. Tests showed the circuit quality to be satisfactory and in December, 1939, this cable was partially used for 12-channel links between Calais and London.

### 3. Results

Some of the properties given in Section 1, such as capacitance, characteristic impedance, and attenuation, are primarily of interest in considering propagation over one circuit. Others, such as capacitance unbalances, mutual impedances, and cross talk, are related to mutual circuit interactions. These two types of conditions will be discussed successively.

#### 3.1 PROPAGATION OVER ONE CIRCUIT

Propagation over one circuit is influenced by the characteristic impedance and attenuation. Figs. 5 and 6 show variation of these factors as a function of frequency for 1.3-millimeter copper conductors grouped in circuits and having a capacitance of  $35.0 \cdot 10^{-9}$  farad per kilometer.

Longitudinal uniformity of each circuit is essential to good quality; characteristic-impedance deviations between successive circuit elements cause reflections of the transmitted signals. These reflections, in turn, cause echo phenomena troublesome in themselves and liable to cause an

instability of the 2-wire circuits between which is inserted the 4-wire circuit formed by the 12-channel link. Furthermore, they cause near-end cross-talk voltages due to reflected far-end cross-talk voltages and these cross-talk voltages cannot be compensated. This is why a special effort was made to decrease irregularities in the

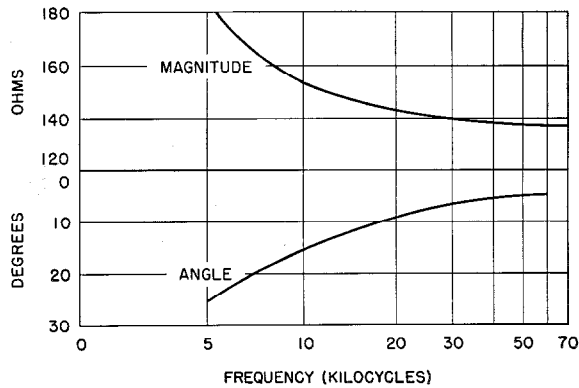

Fig. 5—Characteristic impedance of a nonloaded circuit, the copper conductors are 1.3 millimeters in diameter and their capacitance per kilometer =  $35 \cdot 10^{-9}$  farad.

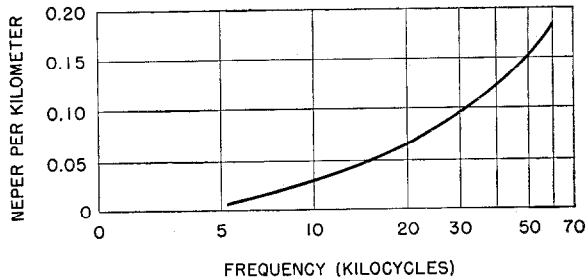

Fig. 6—Attenuation of a nonloaded circuit, the copper conductors are 1.3 millimeters in diameter and their capacitance per kilometer =  $35 \cdot 10^{-9}$  farad.

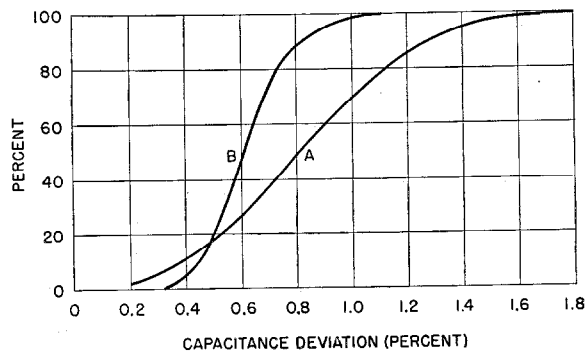

Fig. 7—Average capacitance deviations: A—in the 12-channel star-quad group; B—in the 12-channel pair group.

characteristic impedance; first by insuring manufacturing uniformity, then by distributing the factory lengths so as to decrease the differences between the average capacitances of successive

the reflection effects on two successive lengths add. Suppose the allocation of the factory lengths has made it possible to make the average capacitance deviations (or the average characteristic-

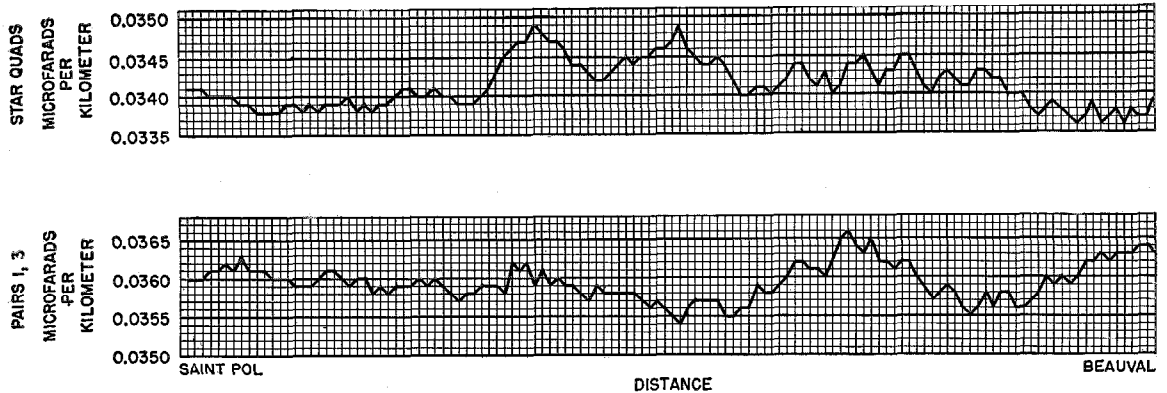

Fig. 8—Carrier-channel circuits, average effective capacitances per length for the section between Saint Pol and Beauval.

lengths, and finally, by a special selection at certain junction points of the circuits to be spliced together. As the characteristic impedance of a circuit cannot conveniently be measured directly, the circuit capacitance is generally controlled; capacitance being a basic element of the characteristic impedance.

Fig. 7 shows a statistical diagram of the capacitance deviations of the factory lengths, i.e., of the differences between the average circuit capacitance and the capacitance of each circuit for each factory length. The ordinates give the percentage of lengths for which the average value of the capacitance deviation is less than the corresponding value shown as abscissa. Fig. 8 shows the average capacitances of the successive lengths of one repeater section. These two diagrams illustrate the uniformity of manufacture.

At the junction points of two successive lengths, three methods of connecting may be used; connecting high-capacitance pairs together and low-capacitance pairs together, or connecting high-capacitance pairs to low-capacitance pairs, or not making any systematic selection. The first method gives different characteristics for the various circuits of the cable, and this may be objectionable. The second method may be used with advantage if the phase variation along a cable length is small enough for the reflection effects on two successive lengths to cancel. It is objectionable if this phase variation is such that

impedance deviations) practically negligible between two successive lengths. With the notations of Fig. 9, which represents the impedance contour for two consecutive lengths  $AB$  and  $BC$ , we may calculate the resultant reflection coefficient

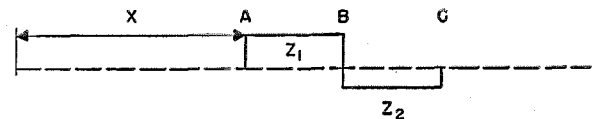

Fig. 9—Reflections on two successive lengths. The dashed line is the average characteristic impedance.  $Z$  = characteristic impedance,  $\gamma$  = propagation constant  $= \beta + j\alpha$ ,

$$r_1 = \frac{Z_1 - Z}{Z_1 + Z}, \quad r_2 = \frac{Z_2 - Z}{Z_2 + Z}.$$

for these two lengths. The ratio, at point  $A$ , of the reflected to the incident voltages is

$$R_1 = r_1(1 - e^{-2\gamma l}) + r_2 e^{-2\gamma l}(1 - e^{-2\gamma l}) \\ = (1 - e^{-2\gamma l})(r_1 + r_2 e^{-2\gamma l}).$$

If the circuits are selected so that  $r_2 = -r_1$ , the modulus of this expression assumes the value  $4r_1 \sin^2 \alpha l$ , if the attenuation  $\beta l$  is neglected as compared to the phase variation  $\alpha l$ .

If, however, the circuits are spliced without any systematic selection of the capacitances, the modulus of  $R_1$  will vary between an expression close to the above and the value  $4r_1 \sin \alpha l \cos \alpha l$ . For the condition  $r_2 = -r_1$  to offer an advantage, it is necessary that  $4r_1 \sin^2 \alpha l \ll 4r_1 \sin \alpha l \cos \alpha l$ , or  $\alpha l \ll \pi/4$ . Or, replacing  $\alpha$  by its 60-kilocycle value, i.e., 1.8 radians per kilometer,  $l \ll 440$  meters.

For the Paris-Calais cable, manufactured in 230-meter lengths, an attempt was made at the junction points of two successive individual lengths to fulfill the condition  $r_2 = -r_1$ . The advantage thus obtained is probably not very considerable, but it seemed to be worth the attempt. The differences between the input impedances of the various circuits at one end of the cable are shown on Table IV. They show the impedance uniformity obtained.

### 3.2 MUTUAL CIRCUIT INTERACTIONS

In view of the importance of cross-talk problems, attention should be given to certain fundamental definitions.

#### 3.2.1 Cross-Talk Definitions and Principles

##### 3.2.1.1 Cross-Talk Ratio and Attenuation

Considering two circuits 1 and 2 in the same cable (Fig. 10), the cross-talk ratio  $E_{12}$  between these two circuits is the difference between the effective signal level in circuit 2 and the noise level induced in circuit 2 by the signal in circuit 1. The  $E_{21}$  cross-talk ratio is not necessarily equal to the  $E_{12}$  cross-talk ratio.

The cross-talk attenuation  $A_{12}$  between a point  $P$  of circuit 1 and a point  $Q$  of circuit 2 is the difference between the level at  $P$  of the signal in circuit 1 and the level at  $Q$  of the noise induced in circuit 2 by the signal in circuit 1.

##### 3.2.1.2 Near-End and Far-End Cross Talk

If a signal is sent out on circuit 1 at the origin  $O_1$  of a cable, the disturbance appearing on circuit 2 at the cable origin  $O_2$  is called near-end cross talk, and the disturbance appearing at the distant end  $E$  is called far-end cross talk.

In case these circuits are assigned to the same direction of transmission, the relationship between the cross-talk ratio  $E_{12}$  at the distant end and the cross-talk attenuation  $A_{12}$  between the origin and the distant end of these circuits is  $E_{12} = A_{12} - b_2 + N_2 - N_1$ , the factor  $b_2$  designating the attenuation of circuit 2, and  $N_1$  and  $N_2$  representing the signal levels sent out on circuits 1 and 2, respectively.

If the circuits are assigned to opposite transmission directions, this same relationship still exists between cross-talk ratio and cross-talk

attenuation at one end of the cable, i.e., at the sending end of circuit 1 and at the receiving end of circuit 2.

For circuits assigned to the same transmission direction, far-end cross talk is the most important, near-end cross talk acting only through the

TABLE IV  
IMPEDANCE MEASUREMENTS AT 60 KILOCYCLES

Repeater Section	Point Measured	Quad Group Impedance		Pair Group Impedance	
		Average in Ohms	Percent Maximum Difference	Average in Ohms	Percent Maximum Difference
Paris-Luzarches	Paris	142.3	2.2	131.4	1.6
	Luzarches	141.7	1.7	130.6	3.2
Luzarches-Clermont	Luzarches	139.6	1.3	134.6	2.7
	Clermont	141.2	1.1	135.0	1.5
Clermont-Vendeuil	Clermont	142.5	1.0	135.3	1.0
	Vendeuil	140.0	1.7	133.3	1.5
Vendeuil-Amiens	Vendeuil	142.2	1.2	133.7	1.9
	Amiens	144.2	1.7	137.4	1.2

far-end cross talk caused by near-end cross-talk voltages reflected at the origin  $O_2$  of the disturbed circuit. In circuits assigned to opposite transmission directions, near-end cross talk alone has to be considered.

##### 3.2.1.3 Far-End Cross-Talk Couplings

Considering two identical homogeneous circuits 1 and 2, assigned to the same transmission direction and having, at a given point of their route, a coupling  $M$  caused by a mutual admittance or impedance, the voltage appearing at the

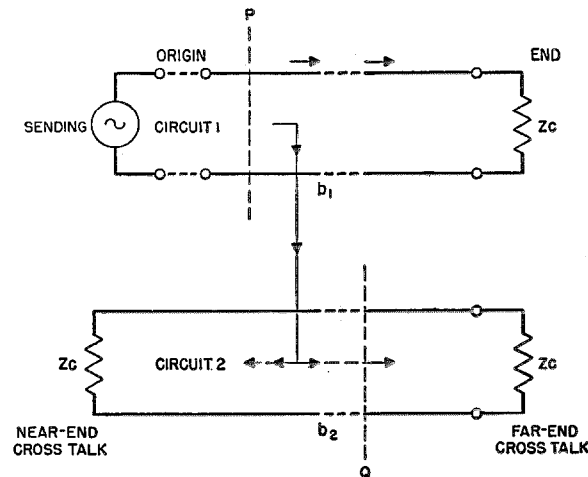

Fig. 10—Near-end and far-end cross talk.



distant end of circuit 2 when circuit 1 is the disturbing circuit (direct cross talk) is the same as that appearing at the distant end of circuit 1 when circuit 2 is the disturbing circuit (inverse

cross-talk). This voltage is independent of the location of the coupling  $M$ . It is important to note that this is no longer true when the two circuits considered are in the presence of other circuits, or when they have impedance nonuniformities, or when they do not have the same transmission characteristics.

Accordingly, the resultant equivalent coupling is equal to the algebraic sum of all such elementary couplings distributed along the cable. This is the basis for compensation of far-end cross talk by transpositions at splicing points, and by insertion of a correcting network. It permits a relationship to be established between the average coupling in each shop length and the mean far-end cross talk on a repeater section. As a first approximation, the far-end cross-talk voltage on a cable section is proportional to the square root of the length of the section.

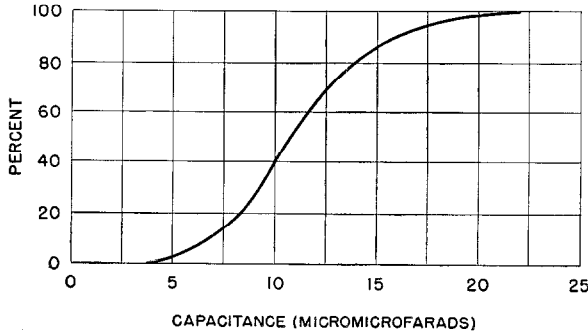

Fig. 11—Real-to-real capacitance unbalances of 12-channel star quads (real circuits of one quad).

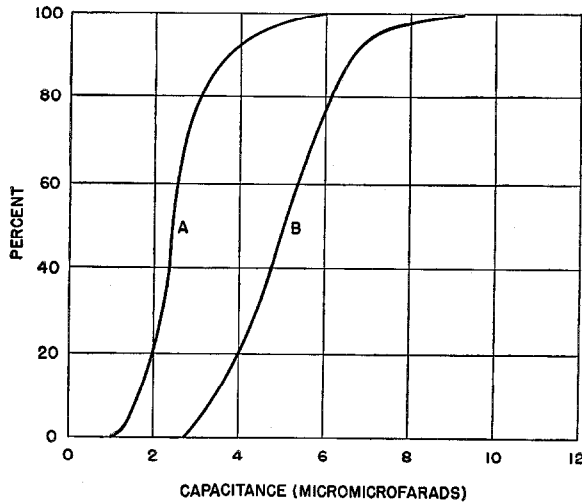

Fig. 12—Real-to-real capacitance unbalances of 12-channel star quads; A—between center quad and first-layer quad; B—between adjacent first-layer quads.

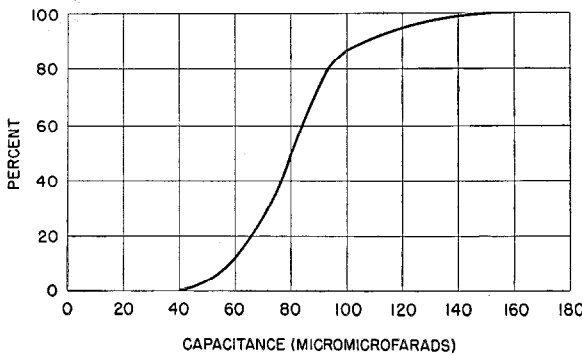

Fig. 13—Real-to-earth capacitance unbalances of the 12-channel star quads.

3.2.1.4 Near-End Cross Talk. Segregation of Circuits by Direction

To obtain an adequate cross-talk ratio between circuits of opposite transmission directions, very severe requirements are imposed on interactions between circuits. Consider, for instance, the case of two identical circuits 1 and 2, operated at the same transmitting levels, and the requirement of a maximum cross-talk ratio of 8 nepers at one end of the cable.<sup>4</sup> As the difference between the signal levels on the disturbing and disturbed circuits may be as high as 7 nepers (the maximum attenuation of a repeater section), a minimum cross-talk attenuation of  $8+7=15$  nepers between these two circuits at the distant end, permits only an extremely small value of interaction.

<sup>4</sup> C.C.I.F. Document No. 72, Oslo; June 20-July 2, 1938.

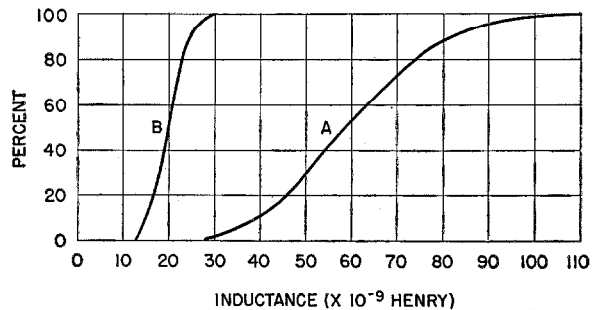

Fig. 14—Real-to-real mutual inductance of 12-channel star quads; A—between real circuits of one quad; B—between real circuits of different quads.

This explains the necessity for segregating circuits of opposite transmission directions and for interposing between such circuits a highly effective electromagnetic shield.

### 3.2.2 Shop-Lengths Problems

The problem consists of manufacturing circuits in such a manner that the mutual admittances and impedances of these circuits be as small as possible. From a practical point, these admittances and impedances involve only capacitance unbalances and mutual inductances.

#### 3.2.2.1 Same Transmission Direction

For circuits cabled in individual pairs, the most favorable lengths of twist must be used. The solution to this problem is made particularly complex by the large number of pairs to be considered simultaneously. For circuits cabled in star quads, it is necessary not only to obtain favorable twist lengths corresponding to small interaction values between pairs of different quads, but also to insure the symmetry of each star quad with a view to decreasing the interactions between the two pairs of one quad. To give concrete figures, the number of pairs of twists to be considered is  $8 \times 7/2 = 28$  for interactions between quads, and  $16 \times 15/2 = 120$  for interactions between pairs.

The results obtained are shown statistically in Figs. 11 to 17. On these diagrams, the ordinates show the percentages of lengths for which the mean value of capacitance unbalance or of mutual inductance is lower than the corresponding value shown as abscissa. Statistics of capacitance unbalances and mutual inductances between pairs or between side circuits of star quads have been established on lengths of the Clermont-Amiens cable (176 lengths of 223 meters each).

#### 3.2.2.2 Opposite Transmission Directions

To decrease interactions between circuits of opposite directions of transmission, the corresponding twists must first be chosen in an appropriate manner. The number of pairs of twists to be considered is  $8 \times 16 = 128$ . An appropriate shield must be designed and is an important element of the cable cost, because of its raw materials and of the manpower necessary for its manufacture. It is necessary, therefore, to make

a thorough study and to insure maximum shielding.

Theories of shield efficiency have been proposed by Nyquist,<sup>5</sup> Schelkunoff,<sup>6</sup> and Kaden.<sup>7</sup> These theories show the superiority of composite shields consisting of alternate layers of materials

<sup>5</sup> Nyquist, United States Patent 1 979 402; June 7, 1932.

<sup>6</sup> Schelkunoff, "The Electromagnetic Theory of Coaxial Transmission Lines and Cylindrical Shields," *Bell System Technical Journal*, v. 13, pp. 532-579; October, 1934.

<sup>7</sup> H. Kaden and F. Sommer, "Die Schirmwirkung mehrschichtiger Lagenschirme in Fernmeldekabeln," *Elektrische Nachrichten Technik*, v. 17, pp. 6-16; January, 1940.

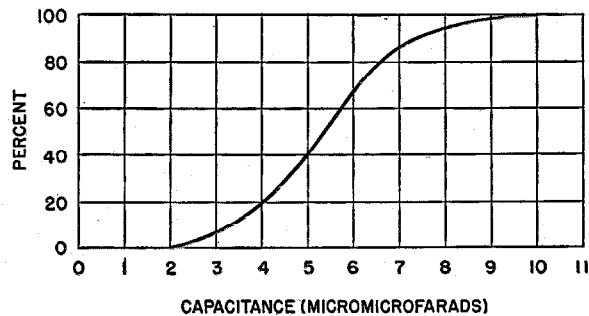

Fig. 15—Capacitance unbalances of two adjacent 12-channel pairs (pair layer).

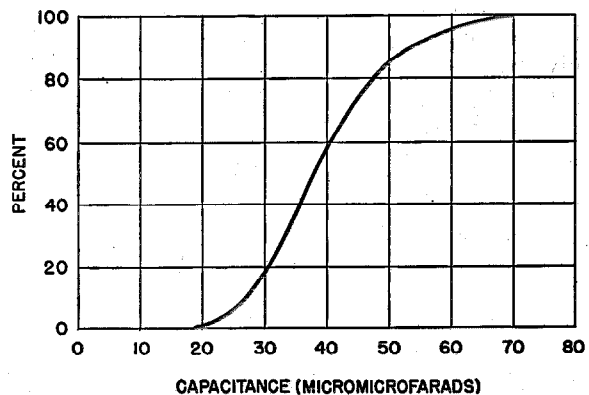

Fig. 16—Ground capacitance unbalances of 12-channel pairs (pair layer).

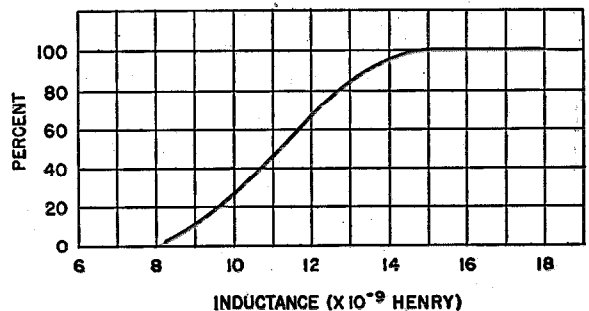

Fig. 17—Mutual inductance between 12-channel pairs (pair layer).

having high electrical conductivity and high magnetic permeability. The top and bottom layers should have high electrical conductivity. It is difficult to derive from these theories an accurate value for the efficiency of a shield as practically manufactured, i.e., by means of tape wrappings. Therefore, an experimental determination is of particular interest; Biskeborn<sup>8</sup> indicated a method of measurement involving only short shield samples.

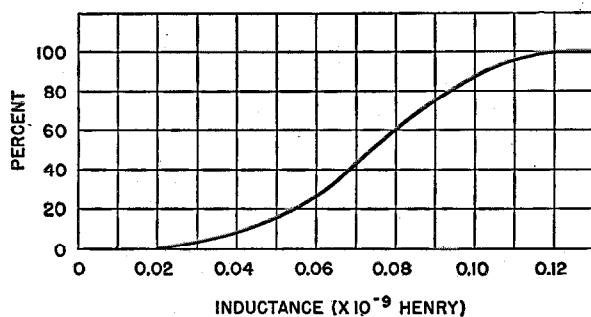

Fig. 18—Mutual inductance between 12-channel pairs and real circuit of star quads (12-channel).

Fig. 18 shows the statistical results obtained for the mutual inductance between circuits on both sides of the shield. These statistics are given in the same manner as above; they were established on lengths of the Paris-Clermont cable (100 lengths of 223 meters each).

### 3.2.3 Repeater Sections

#### 3.2.3.1 Splicing Lengths. Far-End Cross-Talk Compensation

Sections of eight lengths were first formed and corresponded to loading sections of loaded cables. The eight lengths in each section were spliced in such a manner as to decrease the capacitance unbalances by appropriate circuit transpositions. Then these eight-length sections were connected, two by two, with appropriate transpositions to decrease the differences between direct and inverse far-end cross talk, and, when needed, the high far-end cross-talk couplings.

The sixteen-length sections thus formed were connected, two by two, according to the same principle, and so on until the splicing of a repeater section was complete. It is interesting to

compare this method with that used in splicing the first 12-channel cable laid in Sweden.<sup>9</sup>

The results thus obtained on the various repeater sections are shown in Table V. It must be noted that higher values for far-end cross-talk ratios would be needed if compensating elements for far-end cross talk were not inserted at the circuit end. If these compensating elements are not used, an attempt should be made at the splicing points of two cable sections to associate circuits so as to cancel the far-end cross-talk coupling of these two sections. If the insertion of compensating elements is contemplated, an effort is made to remove all factors that limit the improvement caused by these elements: namely the differences between direct and inverse far-end cross talk.

The far-end cross-talk compensation of a repeater section is based on the fact that far-end cross talk at the ends of two identical circuits is independent of the location of the coupling causing it, and remains unchanged when the disturbing and disturbed circuits are interchanged. Thus, far-end cross talk can be compensated by the insertion of coupling elements placed at any point of the circuits, at the ends, for instance. As the characteristic impedance of these circuits is practically a resistance, and as the coupling between circuits is mainly of a capacitive or inductive character, they can all be partly compensated within a wide frequency band by a capacitance unbalance.

A better compensation, however, and practically without any additional cost, is obtained by associating a conductance unbalance with the capacitance unbalance; the compensating element is thus formed by a differential capacitor and one or two resistances connected as shown in Fig. 19. These elements are adjusted so as to obtain a maximum cross-talk ratio in the 12–60-kilocycle band. The values are given in Table V.

The compensation of far-end cross talk between 16 pairs requires the insertion of  $16 \times 15/2 = 120$  elements. A relatively convenient mounting of these elements was obtained by passing all circuits through a bare-wire network, a kind of grid in which all circuits are crossed two by two; the balancing differential capacitor is mounted at the crosspoint of two circuits, and the com-

<sup>8</sup> M. C. Biskeborn, "Testing Shields for Carrier-Frequency Line Structures," *Bell Laboratories Record*, v. 18, pp. 88–90; November, 1939.

<sup>9</sup> U. Meyer and W. Rihl, E. F. D., p. 98; July, 1940.

compensating resistors (of the conductance component) are soldered to the differential-capacitor terminals.

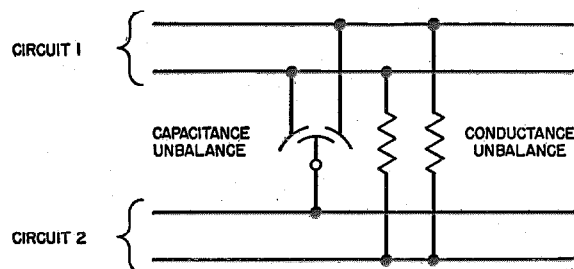

Fig. 19—Complex compensating element for far-end cross talk, inserted between the wires of two circuits.

3.2.3.2 Submarine Cable

In the case of the submarine cable, the splicing of the central quad of the 7-quad group presented a special problem. Following a rectilinear path, this quad does not possess the mechanical elasticity of the first-layer quads (cabled along a helix). Thus, in case the cable expands in length, there is danger of this quad breaking. It was therefore decided, in order not to weaken all circuits, to connect together all the central quads of the successive lengths, thus forming a central quad going from one cable end to the other.

While this solution offered a mechanical advantage, the central-quad circuits had a propagation constant slightly different from that of the circuits formed by quads of the first layer. For example, the phase difference between these circuits at 60 kilocycles was of the order of 2 per cent, or about 80 electrical degrees.

It then became impossible to compensate for direct and inverse cross talk simultaneously by a coupling located at a single point of the circuits. A simple theoretical calculation shows that such a compensation is possible by using two couplings located at two points of the circuits, for instance at the two ends (see Section 4, Appendix). This calculation is confirmed by practical experience.

As an example, the worst 60-kilocycle cross-talk value corresponded to a cross talk expressible by the admittance unbalances: +53.1 micromhos and  $174 \cdot 10^{-12}$  farad for direct measurement (cross-talk ratio=6.5 nepers); and -71.6 micromhos and  $105 \cdot 10^{-12}$  farad for inverse measurement (cross-talk ratio=6.3 nepers).

After compensation, the cross-talk ratio obtained was 9.0 nepers; an improvement of 2.7 nepers.

TABLE V  
CROSS-TALK MEASUREMENTS ON 12-CHANNEL CIRCUITS (MINIMUM RESULTS, IN NEPERS)  
PARIS-CLERMONT AND CLERMONT-AMIENS SECTIONS

Characteristic	Frequency (Kilocycles)	Paris-Luzarches		Luzarches-Clermont		Clermont-Vendeuil		Vendeuil-Amiens		Specifications	
		Paris Station	Luzarches Station	Luzarches Station	Clermont Station	Clermont Station	Vendeuil Station	Vendeuil Station	Amiens Station	All Measurements	95 Percent of All Measurements
Near-end cross talk between circuits of opposite transmission directions	60	15.48	16.20	15.45	16.14	15.12	15.30	15.26	15.34	13.8	14.4
Near-end cross talk between circuits of same transmission direction (high-level end)	30	P 8.74	Q 8.36	Q 8.62	P 9.00	P 8.84	Q 8.70	Q 8.16	P 8.64	6.5	6.8
	40	8.46	8.16	7.90	8.42	8.56	8.00	7.96	8.36	6.1	6.5
	60	8.30	7.84	7.46	8.44	8.36	7.70	7.30	8.20	5.8	6.1
Near-end cross talk between circuits of the same direction after compensation (low-level end)	30	Q 7.62	P 7.87	P 7.48	Q 7.78	Q 7.76	P 8.10	P 8.16	Q 7.92	6.5	6.8
	40	7.52	7.58	7.34	7.42	7.66	7.74	7.74	7.70	6.1	6.5
	60	7.08	7.36	7.16	7.26	7.44	7.42	7.48	7.46	5.8	6.1
Far-end cross talk between circuits of the same transmission direction before compensation	60	Q 7.20	P 7.54	P 7.32	Q 7.36	Q 7.42	P 7.38	P 7.50	Q 7.42	6.3	6.9
	at all frequencies	7.20	7.54	7.32	7.36	7.42	7.38	7.50	7.42	6.3	6.9
Far-end cross talk between circuits of the same transmission direction after compensation	12	Q 9.46	P 9.62	P 9.40	Q 9.60	Q 9.66	P 9.30	P 9.16	Q 9.74	7.5	8.1
	30	9.40	9.86	9.50	9.72	9.96	9.46	9.14	10.02	7.5	8.1
	40	9.58	9.74	9.50	9.72	9.94	9.28	9.21	10.06	7.5	8.1
	50	9.50	9.78	9.30	9.66	9.92	9.32	9.08	9.98	7.5	8.1
	60	9.40	9.66	9.32	9.64	9.86	9.30	9.14	9.92	7.5	8.1

P refers to outer pairs of the cable, and Q to the pairs of the central quads.

### 3.2.3.3 Near-End Cross Talk

Table V gives the near-end cross-talk attenuation obtained between circuits of opposite transmission directions; the equivalent cross-talk ratios are derived from these figures by subtracting the effective attenuations of the circuit, as shown in Table VI.

TABLE VI  
EFFECTIVE ATTENUATION OF REPEATER SECTIONS  
AT 60 KILOCYCLES

Repeater Section	Length (Meters)	Attenuation (Nepers)			
		Per Kilometer		Total	
		Pairs	Quads	Pairs	Quads
Paris-Luzarches	33 540	0.181	0.191	6.06	6.40
Luzarches-Clermont	33 249	0.181	0.192	6.02	6.39
Clermont-Vendeuil	30 905	0.179	0.191	5.54	5.91
Vendeuil-Amiens	31 723	0.178	0.190	5.65	6.03

It will be noticed that the results obtained are appreciably better than the limits specified and that they also exceed the 8-neper cross-talk-ratio limit recommended by the C.C.I.F. (Comité Consultatif International pour La Téléphonie à Grande Distance).

Table V also gives the near-end cross-talk attenuations between circuits of the same transmission direction; the values measured at the "high-level" end are noticeably better than those measured at the "low-level" end. This is due to the fact that the far-end cross-talk-compensating elements are inserted at the low-level end and that their action is superimposed on the circuit near-end cross talk proper.

The construction of the Paris-Calais cable afforded an opportunity for studying the problems presented by the 12-channel circuits, for improving the known solutions, and for applying new solutions. These problems concern more particularly the impedance uniformity of the circuits, the far-end cross talk between circuits having the same direction of transmission, and the near-end cross talk between circuits of opposite transmission directions. The design and manufacture of the Paris-Calais cable has given new experience in 12-channel-circuit technique. This technique is quite varied; it includes special manufacturing methods relative to the twisting and cabling of circuits, the manufacture of an efficient and economical shield, processes for the splicing of lengths in such a manner as to allow

an improvement of circuit uniformity and a decrease of coupling between circuits, and adjustments of the far-end cross-talk-compensating elements. It will be noted that the Paris-Calais cable meets not only the requirements laid down by the French Telephone Administration, but also the requirements recommended by the Comité Consultatif International pour La Téléphonie à Grande Distance after the special Paris-Calais cable specification was established. Especially interesting is the cross-talk ratio, the minimum value of which was fixed at 8 nepers for near-end cross talk between circuits of opposite transmission directions and also for far-end cross talk between circuits of the same direction. These values, however, concern only the repeater sections considered separately; the cross-talk disturbances of the various repeater sections add, and it would be particularly interesting to measure all circuits from Paris to Calais, with their intermediate repeaters. Perhaps these transmission tests on 12-channel circuits may be made in the near future; they will form a fundamental basis for the development of new links for 12-channel circuits.

#### 4. Appendix; Far-End Cross-Talk Compensation Between Circuits Having Different Propagation Constants

It is known that compensation for far-end cross talk between circuits having similar transmission characteristics can be achieved by placing a complex compensating element at any point along these circuits. If the two circuits have different propagation constants, such compensation is no longer possible and a single compensating element at any point cannot generally balance out simultaneously the far-end cross talk caused on circuit 2 (see Fig. 11 and Paragraph 3.2.1.3) when circuit 1 is the disturbing circuit (direct cross talk), and the far-end cross talk caused in circuit 1 when circuit 2 is the disturbing circuit (inverse cross talk). The calculations given below are relative to the more general case of two circuits with different propagation constants and characteristic impedances. The possibility of compensation by a coupling element inserted at a single appropriately chosen point is first discussed, then, compensation by two coupling elements inserted at two points in the circuits is considered.

Indices 1 and 2 will be assigned to each circuit, respectively; the propagation constant will be designated by  $\gamma = \beta + j\alpha$ , the characteristic impedance by  $Z$ , and the assumption will be made that  $\alpha_1 > \alpha_2$  and  $\beta_1 > \beta_2$ .

#### 4.1 COMPENSATION AT A SINGLE POINT

Let us place a mutual admittance  $ke^{j\varphi}$  at a distance  $x$  from the circuit origin. Assuming the same power levels at the origins of the circuits, i.e., a transmission at voltage  $E_0$  on circuit 1 and at voltage  $E_0(Z_1/Z_2)^{1/2}$  on circuit 2. If circuit 1 is the disturbing circuit, then:

Voltage at  $x$  in circuit 1 is  $E_0 e^{-\gamma_1 x}$ .  
 Current at  $x$  in circuit 2 is  $K E_0 e^{-\gamma_1 x + j\varphi}$ .  
 Current at distant end of circuit 2 is

$$i_{12} = k E_0 e^{-\gamma_1 L} \times e^{\left[ \exp(\gamma_1 - \gamma_2)(L - x) + j\varphi \right]}.$$

If circuit 2 is the disturbing circuit:

Current at distant end of circuit is

$$i_{21} = k E_0 (Z_2/Z_1)^{1/2} e^{-\gamma_2 L} \times e^{\left[ \exp(\gamma_2 - \gamma_1)(L - x) + j\varphi \right]}.$$

The mutual admittance placed at the ends of the circuits and equivalent to the far-end cross talk may also be measured. Assume  $K_1 e^{j\phi_1}$  when circuit 1 is the disturbing circuit, causing at the distant end of circuit 2 the current  $K_1 E_0 e^{-\gamma_1 L + j\phi_1}$ . Let us assume  $K_2 e^{j\phi_2}$  when circuit 2 is the disturbing circuit, causing at the distant end of circuit 1 the current

$$K_2 E_0 (Z_2/Z_1)^{1/2} e^{-\gamma_2 L + j\phi_2}.$$

For the mutual admittance  $ke^{j\varphi}$  to compensate simultaneously for the direct and inverse far-end cross talk, it is necessary and sufficient that

$$k E_0 e^{-\gamma_1 L} e^{\left[ \exp(\gamma_1 - \gamma_2)(L - x) + j\varphi \right]} = K_1 E_0 e^{-\gamma_1 L + j\phi_1},$$

and

$$k E_0 (Z_2/Z_1)^{1/2} \times e^{\left[ \exp(\gamma_2 - \gamma_1)(L - x) + j\varphi \right]} = K_2 E_0 (Z_2/Z_1)^{1/2} e^{-\gamma_2 L + j\phi_2},$$

which, by multiplying and dividing, can be brought to the form

$$k^2 e^{\left[ \exp 2j\varphi \right]} = K_1 K_2 e^{\left[ \exp j(\phi_1 + \phi_2) \right]}, \quad (1)$$

$$\left. \begin{aligned} e^{\left[ \exp 2(\gamma_1 - \gamma_2)x \right]} \\ = (K_1/K_2) e^{\left[ \exp 2(\gamma_1 - \gamma_2)L - j(\phi_1 - \phi_2) \right]}. \end{aligned} \right\} \quad (2)$$

The first relationship yields

$$k = (K_1 K_2)^{1/2}, \quad \varphi = \frac{\phi_1 + \phi_2}{2} + \lambda\pi, \quad (3)$$

$\lambda$  being an integer. The second relationship gives two equations for the determination of  $x$ , namely:

$$2(\alpha_1 - \alpha_2)x = 2(\alpha_1 - \alpha_2)L - (\phi_1 - \phi_2), \quad (4)$$

$$2(\beta_1 - \beta_2)x = 2(\beta_1 - \beta_2)L - \log_n (K_1/K_2). \quad (5)$$

By eliminating  $x$  between these two equations, there is obtained the condition

$$\frac{\log_n K_1 - \log_n K_2}{\phi_1 - \phi_2} = \frac{\beta_1 - \beta_2}{\alpha_1 - \alpha_2}. \quad (6)$$

When this condition is fulfilled, the value of  $x$  is given by either (4) or (5). To yield a practical solution, this value of  $x$  must be such that

$$0 < x < L. \quad (7)$$

To discuss (6), an expression is given for the mutual admittances  $K_1 e^{j\phi_1}$  and  $K_2 e^{j\phi_2}$ . To this end, the total circuit is broken into circuit elements of length  $dx$ , along which propagation is neglected, and the mutual admittance designated by  $k(x)e^{j\varphi(x)}$  is assumed to be constant. Then

$$\left. \begin{aligned} K_1 e^{\left[ \exp j\phi_1 \right]} &= \int_0^L k(x) e^{\left[ \exp j\varphi(x) \right]} \\ &\quad \times e^{\left[ \exp(\gamma_1 - \gamma_2)(L - x) \right]} dx, \\ K_2 e^{\left[ \exp j\phi_2 \right]} &= \int_0^L k(x) e^{\left[ \exp j\varphi(x) \right]} \\ &\quad \times e^{\left[ \exp(\gamma_2 - \gamma_1)(L - x) \right]} dx. \end{aligned} \right\} \quad (8)$$

##### 4.1.1 Study of a Few Particular Cases

###### 4.1.1.1 Coupling Uniformly Distributed Along the Circuits

In this case, it can be seen directly that there is equality between the direct and inverse far-end cross-talk currents caused by two elements placed symmetrically with respect to the circuit midpoints. Compensation can then be effected by one additional mutual admittance located at that midpoint.

It can also be seen, starting from (8), that condition (6) is fulfilled, and that (4) and (5) give  $x = L/2$ .

#### 4.1.1.2 Two Circuits Having Same Attenuation But Different Phase Constants

For  $\beta_1 = \beta_2$ ,  $\alpha_1 \neq \alpha_2$ , condition (6) becomes

$$K_1 = K_2. \quad (9)$$

This condition being assumed as fulfilled, (4) gives  $x = L - \frac{\phi_1 - \phi_2}{2(\alpha_1 - \alpha_2)}$ . Condition (7) can then be written

$$0 \leq L - \frac{\phi_1 - \phi_2}{2(\alpha_1 - \alpha_2)} \leq L,$$

or

$$0 \leq \frac{\phi_1 - \phi_2}{2} \leq (\alpha_1 - \alpha_2)L. \quad (10)$$

In discussing (9), it should be noted that, practically, the function  $k(x)$  varies at random; (8) then shows that the condition  $k_1 = k_2$  can be fulfilled for certain only if  $\varphi(x)$  keeps a constant value  $\varphi_0$  or  $\varphi_0 + \pi$ . Indeed, in such a case,  $e^{j\varphi(x)}$  is equal to  $\pm e^{j\varphi_0}$ , the + and - signs appearing simultaneously in the two (8) integrals;  $e^{j\varphi_0}$  can be taken outside the integral sign,  $k(x)$  being positive or negative according to whether the corresponding value of  $\varphi(x)$  is equal to  $\varphi_0$  or to  $\varphi_0 + \pi$ . Besides, due to the fact that  $\beta_1 = \beta_2$ ,  $\gamma_1 - \gamma_2 = j(\alpha_1 - \alpha_2)$ , so that  $K_1 e^{j(\phi_1 - \varphi_0)}$  is the conjugate of  $K_2 e^{j(\phi_2 - \varphi_0)}$  which involves  $K_1 = K_2$  and  $\phi_1 + \phi_2 = 2\varphi_0$ .

In discussing (10), the condition  $\phi_1 - \phi_2 > 0$  amounts to fixing a choice on the various possible manners of selecting the angles  $\phi_1$  and  $\phi_2$ .

In regard to the second inequality of (10), even assuming the hypothesis  $\varphi(x) = \varphi_0$  or  $\varphi_0 + \pi$ , the difference between  $\phi_1$  and  $\phi_2$  can have any value between 0 and  $2\pi$ . To fulfill this inequality with certainty, it is therefore necessary that the cable be sufficiently long since

$$(\alpha_1 - \alpha_2)L \geq \pi. \quad (11)$$

If (11) is not fulfilled, it will be impossible to find a point of compensation in the circuits, when  $\phi_1 - \phi_2 > 2(\alpha_1 - \alpha_2)L$ .

The condition  $k_1 = k_2$  corresponds to a case very close to practice, when the couplings between the two circuits are limited to capacitance unbalances and to mutual inductances, and when the characteristic impedances of these circuits are real quantities, since the  $\phi(x)$  function in the (8) integrals is then equal to  $\pm \pi/2$ .

#### 4.1.1.3 Two Circuits Having the Same Phase Constant But Different Attenuations

For  $\alpha_1 = \alpha_2$ ,  $\beta_1 \neq \beta_2$ , condition (6) becomes

$$\phi_1 = \phi_2. \quad (12)$$

This condition being assumed as fulfilled, (5) gives the value of  $x$  and condition (7) can finally be written

$$0 \leq \log_n K_1 - \log_n K_2 \leq 2(\beta_1 - \beta_2)L. \quad (13)$$

In regard to (12), as the function  $k(x)$  in practice varies at random, condition  $\phi_1 = \phi_2$  can be insured only if  $\varphi(x)$  keeps a constant value  $\varphi_0$ . But this condition is never realized in practice: Suppose the mutual admittance  $k(x) [\exp j\varphi_0]$  occurs systematically between the circuits considered; there will also occur the mutual admittance  $k(x) e^{j(\varphi_0 + \pi)} = -k(x) e^{j\varphi_0}$ , derived from the above by crossing the wires of one circuit. Then, if we require that  $\varphi$  keep a constant value  $\varphi_0$ , this necessitates the splicing of successive circuit elements in such a manner that the couplings add without ever subtracting, which cannot be accepted.

Condition (13) will always be fulfilled as soon as  $\varphi(x) = \varphi_0$ . But, as shown above, this does not correspond to a practical case. As an example, take the simplified case where the couplings distributed along the cable reduce to two capacitance unbalances, one at the origins of the circuits,  $\epsilon k_1 e^{j\pi/2}$ , and the other at the distant end,  $\epsilon' k_2 e^{j\pi/2}$ ,  $\epsilon$  and  $\epsilon'$  taking indifferently the values  $\pm 1$ . The distant-end mutual admittances (equal to the direct and inverse far-end cross talk) are, respectively,

$$K_1 e^{j\phi_1} = j\{\epsilon k_1 e^{j(\beta_1 - \beta_2)L} + \epsilon' k_2\},$$

and

$$K_2 e^{j\phi_2} = j\{\epsilon k_1 e^{j(\beta_2 - \beta_1)L} + \epsilon' k_2\}.$$

In case  $\epsilon$  and  $\epsilon'$  have the same sign, it can be seen that (12) and (13) are fulfilled irrespective of the values of  $k_1$  and  $k_2$ . In the contrary case, it can be seen that (12) may happen to be fulfilled (but not necessarily), condition (13) being no longer fulfilled.

## 4.2 TWO-POINT COMPENSATION

In practice, a phase-constant difference is always accompanied by an attenuation difference. Thus, we cannot rely on single-point compensation to produce an appreciable improve-

ment in circuit quality from the standpoint of far-end cross talk. Besides, this method has the drawback that the compensation point is not the same for all circuits in one cable.

It is therefore necessary, if it is desired to effect a systematic and simultaneous compensation of the direct and inverse far-end cross talk, to consider the insertion of balancing elements at several points of the circuits. It can be shown that it is sufficient to locate these elements at two points such as the two ends, for instance.

Let  $Ke^{i\varphi}$  be the mutual admittance placed at the near end, and  $Je^{j\psi}$  the mutual admittance placed at the far end; the values of  $K$ ,  $\varphi$ ,  $J$ , and  $\psi$  are defined by the equations

$$\begin{aligned} KE_0 e[\exp \gamma_2 L + j\varphi] + JE_0 e[\exp -\gamma_1 L + j\psi] \\ = K_1 E_0 e[\exp -\gamma_1 L + j\phi_1], \\ KE_0 (Z_2/Z_1)^{\frac{1}{2}} e[\exp -\gamma_1 L + j\varphi] \\ + JE_0 (Z_2/Z_1)^{\frac{1}{2}} e[\exp -\gamma_2 L + j\psi] \\ = K_2 E_0 (Z_2/Z_1)^{\frac{1}{2}} e[\exp -\gamma_2 L + j\phi_2]. \end{aligned}$$

In practice, the near-end mutual admittance is first adjusted to compensate for the difference between direct and inverse far-end cross talk. Then the common value of these far-end cross talks is compensated by means of the mutual admittance at the far end.

If the locations of the two compensation points can be chosen, the variation of the compensating voltage as a function of frequency may be made similar to that of the far-end cross-talk voltage to be compensated.

It should be noted that by locating the compensating elements at two points in the circuits, the direct and inverse far-end cross talk will be simultaneously compensated, whatever the cause of the difference between them, provided, however, that the circuit propagation constants be different.



# Yarn-Numbering System

By A. A. NEW, M.S.C., F.R.I.C., A.Inst.P.

Standard Telephones and Cables Limited, London, England

*Editor's Note: This article, including the following editorial note, is reprinted from Industrial Standardization, v. 17, pp. 261-262; October, 1946, by permission of the American Standards Association.*

*A standard system of numbers for textile yarns would help the electrical industry as well as the textile industry, declares A. A. New, member of the engineering staff of Standard Telephones and Cables Ltd., London, England, in this article.*

*Mr. New's discussion of the need for a uniform numbering system in Great Britain is especially timely. The American Society for Testing Materials, after several years of study, has just given official approval to such a system—the Grex Universal Yarn Numbering System. This system meets many of the requirements outlined by Mr. New. It is now being discussed with the British Committee on Definitions, which has proposed a similar universal system of numbering.*

*In the opinion of A. G. Scroggie, chairman of Subcommittee B-2 of ASTM Committee D-13 on Textile Materials, the system is applicable to any type of yarn, including those types used in the insulating of wire and cable. Some of the members of the committee have even suggested that the system might be used for the wire and cable itself, as well as for the insulating yarns, and thus help to bring harmony out of the large number of wire gages currently in use in that industry.*

*The term "Grex" (plural grex, abbreviation gx) applies to both the unit and the system. It is derived from:*

*GRams pEr 10,000 meters*

*GR. . .E. X*

*The Grex system meets Mr. New's recommendations in that it is a direct system defined in terms of weight per unit length; it is a metric system; and it permits a large range of magnitudes by the use of multiples or submultiples of the base unit.*

**T**HE electrical industry uses large amounts of textile yarns in a wide range of different types of yarn and for this reason suffers particularly from the disadvantages arising from the multiplicity of yarn-numbering systems. It is natural, therefore, that an electrical manufacturing firm should take an interest in adoption of a universal yarn-count system.

The following list shows the number of different yarn sizes typical of those used by a large electrical factory, the total consumption of which may amount to a total of some 1000 tons per annum (excluding fabrics and fabric-base insulating materials): Soft cotton (16 different yarn sizes); flameproofed cotton (2 sizes); mercerized cotton (5 sizes); glazed cotton (4 sizes); cotopa (14 sizes); crestol (5 sizes); natural Chappe silk (1 size); acetate, cuprammonium, fortisan, and nylon (22 sizes); natural silk (Grega selecta) (10 sizes); worsted yarn (2 sizes); linen thread (3 sizes); hempline and seaming twine (3 sizes); jute yarn (2 sizes in Lea count); jute yarn (6 sizes, spindle; pounds per 14400-yard, count).

Of this list of yarns used in a large British

electrical factory, the first seven use English cotton count, based on the number of 840-yard hanks weighing 1 pound. However, when used for Chappe silk, the plying numbers have the opposite meaning to that normally employed.

The rayons, Trame, and Grega selecta (but not Chappe) natural silk are numbered in the denier system which is based on the number of half decigrams per 450-meter skein, which is equivalent to grams per 9000 meters. Worsted yarn is supplied on the English worsted count based on the number of 560-yard hanks weighing 1 pound. Linen yarn, linen thread, hempline, and the finer jutes employ the Lea count of the number of 300-yard Leas in 1 pound, while the coarser jutes are denoted by the number of pounds that a spindle of 14400 yards weighs.

Thus we have five systems of counts in regular use, of which two are of direct (or "normal") type (denier count and Dundee jute count) and three of a reciprocal type (English cotton count, English worsted count, and the Lea count). The plying number can have exactly opposite meanings in different cases, and in the case of two different counts are employed for

the same kind of yarn in a slightly different state. By a direct (or "normal") type count is meant one in which large count numbers mean coarse, heavy yarns and small numbers mean fine yarns, and by a reciprocal-type count is meant one in which the reverse is the case.

The variety of these different counts affects the work of personnel in the purchasing department, the raw-material inspection department, and the stores and design engineers. The present complexity of what is fundamentally a simple matter in each case causes extra work and increases the possibility of errors.

The effect is noticed chiefly by those concerned with raw-material inspection and with wire and cable design. The ambiguities connected with the methods of expressing the count of multi-ply yarns are also a particular worry of the purchasing department. From the raw-material inspection point of view there are five curious sets of arbitrary constants to be applied in determining counts, where from a common-sense point of view one only would be quite sufficient. This means that a better class of operator has to be used on such work than is really necessary, with a consequent tendency to boredom.

Mechanization of such jobs is difficult or impossible. For a wire or cable, or instrument-cord designer, the multiplicity of count systems and lack of simple relationships makes it more difficult to derive simple fundamental formulae with regard to covering power, diameters, filling power, etc., than would be the case if these were reduced to one system. In addition to these internal effects in an electrical manufacturing unit, there are also external effects of a similar nature if the British firm is concerned with directing or organizing manufacture at a Continental factory. In this case, the complexity of counts is a handicap, although perhaps a minor one, in getting the job done and in getting British yarns into use.

There is, therefore, a strong argument on many grounds for the adoption of a single count system, whatever the system may be. As to which of the many possible count systems should be preferred is a matter of relatively secondary importance. The following points seem worthy of consideration, however:

A. The natural thing is to expect a large number to stand for a large or coarse yarn and a

small number for a fine one, or in other words, that the count numbers should vary as a direct function of the size or weight of the yarn; i.e., like the denier system and not as an inverse system like the cotton and worsted counts.

B. Since we are at liberty to choose any numbers, the choice should be the very simplest to calculate and remember, such as the weight per 1, 10, 100, or 1000 units of length.

C. Since the metric system of weights and measures is taught in the schools in Great Britain, is well established in scientific work in that country and for general purposes on the Continent, and export trade is going to be very important in the future, a metric basis seems preferable.

D. A universal system for all textiles includes a very large range of magnitudes. For this reason, the fine silks or cottons at one end of the scale would be hampered by the use of fractional counts, or the coarse jute yarns at the other end would have inordinately large count numbers. This difficulty might be overcome simply by basing the count on the weight of one kilometer of the yarn in grams or kilograms, a "1000" yarn being called a "1K." This would mean that the finest silks and cottons would be about ones or twos while the coarsest jutes (used in electrical work) would become about "30K." Such a system is, of course, merely the present metric denier system with the count numbers divided by 9. It may be argued that this makes the counts of filaments of rayons have numerical values less than 1. This would be avoided by using a 10-kilometer base which would mean that the count numbers would be very close to the present metric denier count (actual  $1.1\times$ ). This consideration does not seem important, however, compared with the simplicity of the "grams-per-kilometer" basis.

E. With regard to the method of expressing plying, the only logical way is surely that two tens means a twenty. This is a characteristic of the weight-per-unit-length systems and not of the length-per-unit-weight systems with their anomalous principle that "two tens is a five."

To bring about a change to a single simple system would call for some mental readjustment and for the alteration of records and measuring equipment such as wrap reels, yarn scales, etc., but the gain from such a change would be very definite and would be fairly quickly realized.

# Behaviour of Telephone Exchange Traffic Where Non-Equivalent-Choice Outlets Are Commoned

By E. P. G. WRIGHT, M.I.E.E.

*Standard Telephones and Cables Limited, London, England*

TO give the reader a clear picture of the subject under examination, no better example can be taken than the inevitable result of introducing alternative trunking on inter-exchange circuits. According to theory, the majority of traffic is passed by direct circuits, the remainder being offered an overflow circuit to a tandem exchange, through which the connection can be completed. The number of direct circuits found to be most economical will depend on the type of line construction, the length of the circuit, and similar considerations. It is evident that the overflow traffic offered to the tandem circuit from a number of different groups will be of non-equivalent choice, i.e., some may be the overflow from three direct circuits, some the overflow from four direct circuits, and so on, this overflow traffic being fourth choice, fifth choice, etc.

To determine the proper number of circuits to the tandem centre, it is necessary to establish some basis for equating the relative value of the overflow traffic. A reasonable mean distribution of calls has been deduced by a 50-hour artificial-traffic study. A summary of the results is given in a table and the method for building up the study is described in the appendix.

A theory for equating the traffic on the basis of equivalent first-choice value is explained and compared with the summarised figures of the artificial-traffic study. The probable causes of errors and their extent are examined. This leads to a consideration of the history and unmasking of calls in individual and combined groups. It may be argued that the word "history" is inappropriate, but there are corresponding objections to other terms. The examination considers the case of a combination of two sources of traffic; the identification of the calls that are carried by the first combined choice; and what choice these calls would have been in the two separate groups if they had remained uncombined. The examination also indicates to what

extent calls which are masked in the individual group become unmasked in the combined group, and so discloses how the character of the traffic contributes to the efficiency of a group of circuits.

It is not sufficient to ascertain the required number of circuits to the transit centre if the conditions are such that although the over-all loss is accurate, the loss on some portions of the traffic is excessive. This feature is studied by taking practical examples.

A set of tables is included for avoiding the rather eye-straining process of reading off a number of curves to establish equivalent first-choice traffic values. These tables will also be found convenient for other calculations.

The artificial-traffic study deals in units of 2-minute calls, and the summary expresses quantities of 2-minute calls carried by different circuits. The theoretical portion deals with call-hour units because use of this base is more convenient for calculation. It follows that in comparisons it is necessary to transform from one base to the other. Call-hour units are the total number of calls multiplied by the call time expressed in hours.

As far as possible, formulae have been avoided. The reader is invited, nevertheless, to contemplate the formula  $a/(1+a)$  which forms a ready means for calculating the traffic deposited on a contact offered  $a$  call-hours of first-choice traffic. Frequent use is made of this formula to determine the traffic deposited after the first-choice traffic offered has been ascertained. The formula is derived from the general Erlang formula of loss probability.

This article summarises the conclusions of studies carried out intermittently during the last 15 years. Since these studies were commenced, further examples of cases in which non-equivalent-choice outlets are commoned together have emerged, for example, line-finder systems with partial secondaries, partial outgoing secondaries, etc.

• • •

**1. Illustration of the Case Considered**

The importance of adopting an efficient arrangement of inter-connecting selector outlets has been fully appreciated for many years, and, in consequence, formulae have been developed for determining the number of outlets which are necessary for any particular volume of traffic.

As automatic telephony extends, somewhat abnormal types of inter-connecting selector outlets have been introduced, resulting in new conditions about which little has been published. Some of the artificial-traffic studies which have been undertaken to check the accuracy of various theories thought to be applicable to the new conditions will be summarised.

Most systems of grading outlets assumed that early-choice contacts would be less extensively "commoned" than the later choices.

For example, Fig. 1 shows an arrangement whereby 40 outlets in 4 groups of 10 are commoned to provide 23 circuits. It will be noted that certain fourth-choice outlets are connected together. Similarly, fifth-, sixth-, and seventh-choice outlets are also connected in pairs. All the eighth-, ninth-, and tenth-choice outlets are connected together.

In a commoning arrangement such as that shown in Fig. 2, certain fourth-choice outlets are connected with first-choice outlets. Similarly, fifth and second choices are combined, and so on. The need for providing this type of commoning arises principally with switching arrangements in which there are direct and indirect routes. The scheme is sometimes referred to as a grading with "slipped" commons.

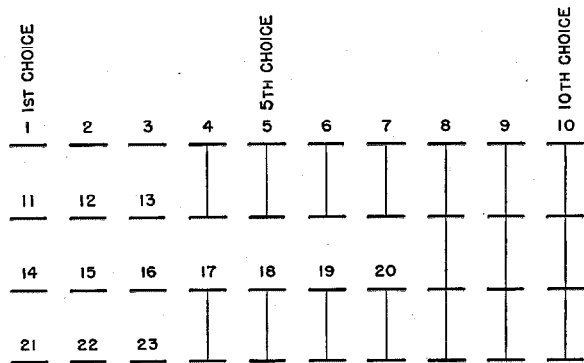

Fig. 1

Methods of computing the number of calls which can be expected to be carried on circuits provided by slipped gradings in which unequal outlets are commoned will be considered.

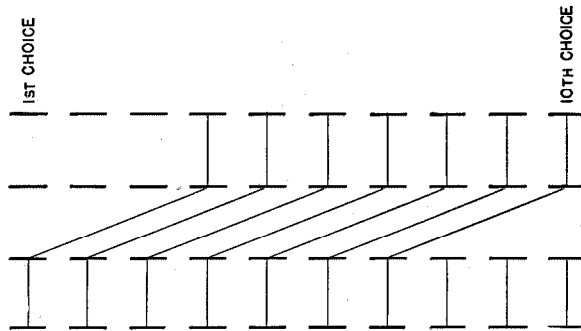

Fig. 2

**2. Analysis of Traffic Values**

To appreciate the general nature of the problem, it is essential to realise that the number of circuits necessary for any particular traffic load cannot be gauged solely by the number of calls of specified duration, as the ability of a circuit to accept such calls also depends on the number of circuits to which the calls have previously been offered. This fact can be illustrated:

If 30 calls of 2-minute duration are offered to two circuits in sequence, the first will accept 15 of the calls ( $30 \times 5/10$ ), while the second will accept 9 calls ( $30 \times 3/10$ ), and the remaining 6 will pass over the two circuits. Had the number of calls been smaller, the occupancy of the circuits would have been less, but not proportionally. For example, 15 calls of 2 minutes each would have deposited 10 calls ( $15 \times 10/15$ ) on the first circuit. An increase of the total calls from 30 to 60 would have resulted in the first circuit taking 20 calls ( $60 \times 5/15$ ). The figures in brackets illustrate the variation in the ratio of the calls offered to those deposited.

In the first example, 15 of the 30 calls are accepted by the first choice, and the remaining 15 calls are offered to the second choice. The second choice accepts 9 calls. In the second example, 15 calls are offered to the first choice and 10 are accepted.

If a remainder of 15 calls is offered to a third circuit, less than 9 would be accepted, and so on; the later the choice, the smaller being the

TABLE I  
48-HOUR ARTIFICIAL-TRAFFIC STUDY

Hours	Calls Offered	Distribution among Outlets										
		1	2	3	4/1	5/2	6/3	7/4	8/5	9/6	10/7	11/8
Sub-Section 1 = 12 Hours												
2 + 3	132 + 62	40	34	27	9/28	11/12	7/11	3/7	1/3	-/1	-/1	-
8 + 9	111 + 60	43	30	17	6/26	7/17	5/11	2/2	1/2	-/1	-/1	-
10 + 11	141 + 72	42	33	27	8/30	10/18	6/15	7/5	4/3	2/1	2/-	-
12 + 13	117 + 65	42	32	22	7/27	7/20	5/12	2/5	-/1	-/1	-/1	-
30 + 31	115 + 64	37	30	23	10/23	6/20	4/13	3/6	2/2	-/1	-/1	-
50 + 51	121 + 52	42	31	22	6/26	8/14	6/7	4/4	-/1	1/-	1/-	-
Total	737 + 375	246	190	138	46/160	49/101	33/69	21/29	8/12	3/3	3/1	-
Mean	185.3	41	31.7	23	7.7/26.7	8.2/16.8	5.5/11.5	3.5/4.8	1.3/2	0.5/0.5	0.5/0.2	-
Aggregate	185.3	41	31.7	23	34.4	25	17	8.3	3.3	1	0.7	-
Sub-Section 2 = 12 Hours												
14	133 + 60	42	34	26	14/24	6/21	8/8	3/2	-/4	-/1	-/1	-/1
16	126 + 59	40	32	24	6/26	8/19	7/7	5/5	3/1	1/1	-/1	-/1
20	109 + 67	37	28	21	8/25	7/16	5/12	2/7	1/3	-/2	-/1	-/1
36	128 + 58	43	33	24	8/28	7/16	7/10	5/2	1/1	-/1	-/1	-/1
38	121 + 57	40	31	24	10/24	7/15	6/9	3/5	-/4	-/1	-/1	-/1
44	119 + 74	40	29	20	7/29	8/18	9/10	4/10	1/4	1/2	-/1	-/1
Total	736 + 375	242	187	139	53/156	43/105	42/56	22/31	6/17	2/7	-/2	-/1
Mean	122.7 + 62.5	40.3	31.2	23.2	8.8/26	7.2/17.5	7/9.3	3.7/5.1	1/2.8	0.3/1.2	-/1.2	-/0.2
Aggregate	185.2	40.3	31.2	23.2	34.8	24.7	16.3	8.8	3.8	1.5	0.3	0.2
Sub-Section 3 = 12 Hours												
18 + 19	114 + 61	42	35	21	5/24	4/18	4/12	1/7	2/-	-/1	-/1	-/1
22 + 23	126 + 69	42	32	21	8/26	7/18	4/15	4/6	5/2	1/2	1/-	1/-
24 + 25	125 + 61	40	34	25	10/25	6/19	7/8	2/6	1/1	-/1	-/1	-/1
26 + 27	121 + 65	41	29	23	9/30	10/18	5/12	3/4	1/1	-/1	-/1	-/1
42 + 43	120 + 58	39	33	22	7/29	6/18	7/2	2/4	2/3	2/2	-/1	-/1
48 + 49	130 + 62	41	34	25	7/27	7/18	5/10	4/4	4/1	1/1	1/1	1/-
Total	736 + 376	245	197	137	46/161	40/109	32/59	16/31	15/8	4/6	2/2	2/-
Mean	122.6 + 62.7	40.8	32.8	22.8	7.7/26.8	6.6/18.2	5.3/9.8	2.6/5.2	2.5/1.3	0.7/1	0.3/0.3	0.3/-
Aggregate	185.3	40.8	32.8	22.8	34.5	24.8	15.1	7.8	3.8	1.7	0.6	0.3
Sub-Section 4 = 12 Hours												
4 + 5	131 + 62	44	33	22	8/24	9/14	5/13	5/6	3/2	1/2	1/1	-/1
6 + 7	126 + 63	41	29	24	6/28	9/17	9/7	3/6	1/3	2/1	2/-	-/1
28 + 29	117 + 60	36	32	25	11/24	9/17	2/11	1/5	1/2	-/1	-/1	-/1
34 + 35	114 + 61	40	33	20	4/30	7/17	5/10	3/3	2/-	-/1	-/1	-/1
40 + 41	127 + 59	41	33	23	7/24	6/17	6/9	6/4	4/2	1/1	-/1	-/1
46 + 47	122 + 69	42	33	24	6/28	7/17	6/10	3/6	1/5	-/2	-/1	-/1
Total	737 + 374	244	193	138	42/158	47/99	33/60	21/30	12/14	4/8	3/3	-/2
Mean	122.8 + 62.3	40.7	32.2	23	7/26.3	7.8/16.5	5.5/10	3.5/5	2/2.3	0.7/1.2	0.5/0.5	-/0.3
Aggregate	185.1	40.7	32.2	23	33.3	24.3	15.5	8.5	4.3	1.9	1	0.3
Mean												
Sub-Sections 1 and 2	185.25	40.65	31.45	23.1	34.6	24.85	16.65	8.55	3.55	1.25	0.5	0.1
Sub-Sections 3 and 4	185.2	40.75	32.5	22.9	33.9	24.55	15.3	8.15	4.05	1.8	0.8	0.3
Sub-Sections 1-4												
Total	2946 + 1500	977	767	552	187/635	179/414	140/244	80/121	41/51	13/24	8/8	2/3
Mean (6)	736.5 + 375	244	192	138	47/159	45/103.5	35/61	20/30	10/13	3.3/6	2/2	0.5/0.75
Mean (6)	122.8 + 62.5	40.7	32	23	7.8/26.5	7.45/17.25	5.8/10.2	3.3/5	1.7/2.2	0.6/1	0.3/0.3	0.08/0.13
Aggregate	185.25	40.7	32	23	34.25	24.7	16	8.35	3.8	1.5	0.6	0.2

The distribution of calls is shown with 2-hourly totals because the figures for 1-hourly periods are much more irregular but there appears to be little significance in the greater variation.

Of the 24 2-hourly periods shown, only the hours 26 and 27 are a reasonable representation of the mean. For comparison with the theoretical distribution it would have been preferable to have reduced the number of calls to 120 and 60 so that each group would have been identical.

Traffic data as measured from peg counts or meter readings are frequently the mean, and the 2-hourly totals in the table are a fair representation of this type of variation.

The deviation from the mean appears to indicate that 300 to 400 calls are necessary to provide a mean likely to be within 1 per cent of the true mean. The figures beyond outlet 8, can only be considered as very approximate as the number of calls recorded is so small.

acceptance. It is clear, therefore, that if 15 fourth-choice calls are combined with 15 first-choice calls, the combination cannot be considered as 30 fourth-choice calls as this would result in too small an acceptance, whereas if considered as 30 first-choice calls, the acceptance would be too large. Also, if it is determined that the 30 calls combined as described will deposit, say, 12 calls on the outlet to which the calls are offered, will 6 calls come from each group of 15, or will the first-choice calls preponderate, and, if so, to what extent?

**3. Artificial-Traffic Study—Summary of Results**

Table I shows the summarised results of an artificial-traffic study extending over 48 hours. During each hour, the fourth-choice traffic of one group offering approximately 60 2-minute calls per hour is combined with the first-choice traffic of another group offering approximately 30 2-minute calls per hour. The results are presented in four sub-sections, each containing six sets of two hours. The sub-sections have been built up in such a way that the four aggregates are approximately equal and may be compared.

**4. Traffic Calculation Theories**

**4.1 APPROXIMATING TRAFFIC BY WEIGHTING METHODS**

A rough approximation of the number of circuits necessary for traffic such as that shown in Table I can be obtained by a direct weighting method. The number of calls which may be expected to be deposited on the independent uncommoned outlets may be calculated by established theories. The number of calls that pass to the fourth outlet during each 2-hour period is:

Total traffic, 2-minute calls	122.8
Less: 2-Minute calls deposited on 1st choice, 40.7	
2-Minute calls deposited on 2nd choice, 32	
2-Minute calls deposited on 3rd choice, 23	95.7
Calls reaching 4th choice	27.1

The traffic at the point of combination is

- 62.5 1st-choice calls, and
- 27.1 4th-choice calls.

The weighting process involves multiplying the calls by the choice number; the results are

added together and the combined choice number determined. For example:

62.5 (calls) × 1 (1st choice) =	62.5
27.1 (calls) × 4 (4th choice) =	108.4
89.6 (calls)	170.9 (calls multiplied by choice)

Combined choice = 170.9/89.6 = 1.9, or approximately 2, i.e., 2nd choice.

It is known how to determine the exact distribution of 89.6 second-choice calls, but this weighting method suffers from the disadvantage that the combined choice may be 1.9, or 2.3, or some other value for which there are no published distributions and, secondly, the division between the fourth-choice and first-choice sources cannot be established unless an assumption is made that for each outlet the division is in the same ratio as that of the calls offered.

**4.2 EQUIVALENT FIRST-CHOICE TRAFFIC THEORY**

An alternative means of calculating may be used. This arrangement assumes that there is an equivalent value of first-choice traffic for each number of calls offered to a particular later-choice outlet. In an earlier paragraph, attention is drawn to the fact that in certain circumstances, 15 calls to the second choice deposit 9 calls, while 15 calls offered to the first choice deposit 10 calls. But a number of calls may be offered to the first choice which will deposit 9 calls, and this number may be considered as the equivalent first-choice traffic which can readily be combined with other equivalent first-choice traffic. Furthermore, the ratio between the two groups may be considered on the basis of the equivalent first-choice value.

As an example which may be compared conveniently with the artificial-traffic study, two groups (shown at the base of Table I) have been combined, viz.: 62.5 calls of first-choice traffic (62.5 2-minute calls in 2 hours equal 1.042 call-hours), and that portion of the total of 122.8 calls which passes to the fourth outlet (122.8 2-minute calls in a 2-hour period equal 2.046 call-hours per hour). According to Erlang's theory of probability, the traffic passing to the fourth outlet is 0.452 call-hour.

The combination expressed in call-hours is set out in Table II; the various steps in the calculation being as follows:

- A. Taken from column C of previous calculation (next line above).  
 B. Taken from columns H and J of previous calculation.  
 C. Column A less column B.  
 D. From traffic-offered curves.  
 E. Column C less column D.  
 F.  $\frac{\text{column E}}{1 - \text{column E}}$  (derived from  $\frac{a}{1+a}$  for traffic carried).  
 G.  $\frac{\text{total of column F}}{1 + \text{total of column F}}$ .  
 H and J.  $\frac{\text{individual figures in column F}}{1 + \text{total of column F}}$ .

### 5. Comparison between Theory and Artificial Study

A comparison may be made between the distribution of calls during a 2-hour period based on:

A. The combined first- and fourth-choice traffic considered as second choice, which is indicated by the weighting process.

B. The groups of late-choice traffic being expressed as equivalent first-choice, and combined together. The figures are taken from the last three columns of Table II, after multiplication by 30 and by 2 to convert from call-hours to 2-minute calls during a 2-hour period.

C. The artificial-traffic study. (See Table I.)

TABLE II  
CALCULATION OF EQUIVALENT FIRST-CHOICE TRAFFIC

Traffic to	A Traffic Offered to Previous Outlet	B Traffic Deposited on Previous Outlet	C Traffic Offered to this Outlet	D Hypothetical Traffic to Next Outlet (each sub-group calculated independently)	E Hypothetical Traffic Deposited on this Outlet (each sub-group calculated independently)	F Equivalent First Choice (E.F.C.)	G Total Traffic Deposited on this Outlet	H Separate Traffic Deposited on this Outlet	J Separate Traffic Deposited on this Outlet
4th	—	—	0.452	0.213	0.239	0.314	—	0.133	—
1st	—	—	1.042	—	—	1.042	—	—	0.442
						1.356	0.575		
5th	0.452	0.133	0.319	0.139	0.180	0.220	—	0.126	—
2nd	1.042	0.442	0.6	0.255	0.345	0.526	—	—	0.301
						0.746	0.427		
6th	0.319	0.126	0.193	0.082	0.111	0.125	—	0.091	—
3rd	0.6	0.301	0.299	0.104	0.195	0.242	—	—	0.177
						0.367	0.268		
7th	0.193	0.091	0.102	0.038	0.064	0.068	—	0.0587	—
4th	0.299	0.177	0.122	0.038	0.084	0.092	—	—	0.0793
						0.160	0.138		
8th	0.102	0.059	0.043	0.0145	0.0285	0.032	—	0.0301	—
5th	0.122	0.079	0.043	0.0115	0.0315	0.0325	—	—	0.0305
						0.0645	0.0606		
9th	0.043	0.0301	0.0129	0.0038	0.0091	0.0092	—	0.009	—
6th	0.043	0.0305	0.0125	0.0028	0.0097	0.0098	—	—	0.0096
						0.0190	0.0186		
10th	0.0129	0.009	0.0039	0.0011	0.0028	0.0029	—	0.0028	—
7th	0.0125	0.0096	0.0029	0.0005	0.0024	0.0025	—	—	0.0024
						0.0054	0.0052		
11th	0.0039	0.0028	0.0011	0.0002	0.0009	—	—	0.0009	—
8th	0.0029	0.0024	0.0005	0.0001	0.0004	—	0.0013	—	0.0004

In the case of *A* above, the traffic carried is divided proportionally to the volume offered; in the case of *B*, proportionally to the equivalent first choice.

When comparing these tables (in Table III), the reader should remember that columns *A* and *B* are based on theory so directly that the quantities in each column will form a continuous curve, while those in column *C*, being "observations,"

are liable to lie above and below a curve which might be formed by an infinite number of observations. Owing to the small value of the later readings in column *C*, it should be appreciated that their significance is minor.

It will be observed that the divergence between column *A* and the other two columns is considerable where the figures are of highest value. The total volume in all columns being equal, it is not unnatural to find that as a result of column *A* being less than column *B* for the first reading, it becomes greater for the fourth, fifth, sixth, seventh, and eighth readings. In these circumstances, the "closeness of fit" in the second and third readings is not very significant.

TABLE III

COMPARISON OF DISTRIBUTION OBTAINED BY DIFFERENT METHODS

Calls offered in a 2-hour period:  
1st Choice = 62.5 (1.042 call-hours per hour)  
4th Choice = 27.1 (0.452 call-hour per hour)

Choice	A Distribution by Weighting Process	B Distribution by Equivalent- First-Choice Process	C Distribution by Artificial- Traffic Study
1st	23.54	26.52	26.5
4th	10.24	7.98	7.8
Total	33.78	34.50	34.3
2nd	17.48	18.06	17.3
5th	7.60	7.56	7.5
Total	25.08	25.62	24.8
3rd	10.87	10.62	10.2
6th	4.73	5.46	5.8
Total	15.6	16.08	16.0
4th	5.94	4.76	5.0
7th	2.58	3.52	3.35
Total	8.52	8.28	8.35
5th	2.84	1.83	2.1
8th	1.24	1.806	1.7
Total	4.08	3.64	3.8
6th	1.02	0.576	1.0
9th	0.44	0.54	0.5
Total	1.46	1.12	1.5
7th	0.336	0.144	0.3
10th	0.144	0.168	0.3
Total	0.48	0.31	0.6
8th	0.10	0.024	0.13
11th	0.04	0.054	0.08
Total	0.14	0.08	0.21
Overflow	0.04	0.02	—
Total	89.18	89.65	89.56

The small total in Column *A* is attributable to the inaccuracy of the method. A correcting factor could be applied to increase the figure to total 89.6 exactly.

6. Degree of Error in Equivalent First-Choice Theory

The use of an equivalent first choice is an approximation which is convenient because the traffic carried by an outlet can be easily calculated from any value of offered first-choice traffic. In fact, the equivalent first-choice value is not dependent solely on the volume of the later-choice traffic; it is dependent also, to a very small extent, on the size of the group with which it is combined. The equivalent first choice for 0.5 call-hour offered to the second choice is 0.428571 call-hour. If these two are truly equivalent, two groups of 0.5 call-hour (i.e., 1 call-hour) to the second choice should be equivalent to 2 × 0.428571 call-hour of first-choice traffic, but it will be seen that there is a small difference. The variation in this difference can be studied in Table IV.

TABLE IV

Traffic Offered to Second Choice	Traffic Carried by Second Choice	Equivalent First Choice Pro Rata on Traffic Offered to Second Choice	Traffic Carried by Equivalent First Choice	Difference
0.5	0.3	0.428571	0.3	0.0
0.761905	0.394089	0.653061	0.39506	+0.00097
1.0	0.460655	0.857142	0.461538	+0.00087
1.3	0.53	1.142857	0.53	0.00
2.0	0.633979	1.714285	0.6315789	-0.0024
3.2	0.7384615	2.742857	0.732825	-0.005636
6.125	0.848077	5.249984	0.8388	-0.009277
0.321428	0.2175825	0.27551	0.216	-0.00158
0.00909	0.00864	0.00779	0.007732	-0.00091

The differences shown in the last column are so small that they are negligible when compared to the inaccuracy of reading curves. As may be expected, the differences are magnified when considering the equivalent first choice for a later choice such as the fourth. See Table V.



In Tables IV and V there is absolutely no significance in the value "0" in the top line of the *Difference* column because the value of equivalent first-choice traffic in this line is chosen

TABLE V

Traffic Offered to Fourth Choice	Traffic* Carried by Fourth Choice	Equivalent First Choice Pro Rata on Traffic Offered to Fourth Choice	Traffic Carried by Equivalent First Choice	Difference
0.5	0.258	0.34771	0.258	0.000
0.75	0.34	0.52156	0.34278	+0.00278
1.0	0.411	0.69542	0.41017	-0.00083
1.3	0.482	0.92723	0.48112	-0.00088
2.0	0.585	1.39084	0.58174	-0.00326
3.2	0.707	2.22534	0.68996	-0.01704
6.0	0.825	4.17252	0.80667	-0.01833
0.32	0.187	0.22253	0.182025	-0.004975
0.01	0.0087	0.00695	0.006906	-0.001794

\* Read off traffic tables.

In the calculation of the division of traffic in the case taken for the artificial-traffic study, a fourth-choice traffic, rather less than 0.5 call-hour, is combined with approximately 1 call-hour actual first-choice traffic. The equivalent first-choice is seen to give an under-value of 0.00326 (approximate) but, as only 0.34771/1.39084, i.e., 1/4, is equivalent first choice, the probable error is 0.00326/4, or -0.0008, which is still insignificant.

so that the traffic carried, as indicated in the second and fourth columns, is equal. In both tables values slightly greater than 0.5 offered call-hour show a positive difference, while much higher and lower values show negative differences. From later tables it would seem that the greatest positive value occurs at the point where the equivalent first choice, when expressed as a percentage of the traffic offered, is at a minimum. To avoid the small error disclosed in Table IV, it is desirable to seek the equivalent first choice for a number of groups as a total, rather than by multiplying the value for a single group by the number of groups. For example, 12 groups each overflow 0.5 call-hour of fourth-choice traffic. This should be calculated as the equivalent first choice to 6 call-hours of fourth-choice traffic (4.69), rather than the individual equivalent first choice, 0.34771 multiplied by 12, or 4.17. When combining traffic values contributed from a number of differing outlets, this inaccuracy can be disregarded; if the traffic total is small, the error is insignificant; if the values are greater, the inaccuracy is swamped by the fact that relative occupancy is calculated on the flat portion of the curve.

### 7. Individual Calls in an Individual Group and in a Combined Group

The variable behaviour of the pro-rata value of the equivalent first choice raises interest in the history of calls when groups are combined. It seems logical to imagine that certain calls, which would have been deposited on the first choice in individual groups, will be displaced by calls from other groups. Furthermore, it is probable that some calls previously screened will now become deposited on the first choice. Tables VI,

TABLE VI

DISTRIBUTION OF FIRST-CHOICE TRAFFIC WHEN COMBINED WITH FOURTH-CHOICE TRAFFIC

Distribution in Individual Groups	Number of Calls	Distribution in Common Group							
		Outlet							
		1	2	3	4	5	6	7	8
Outlet 1	383	298	54	20	6	3	1	1	—
2	246	21	160	39	12	10	3	1	1
3	110	6	3	73	21	3	3	1	—
4	41	1	—	3	27	5	3	1	1
5	11	1	—	—	—	5	3	2	—
6	3	—	1	—	—	—	2	—	—
7	1	—	—	—	—	—	—	—	1
	795	327	218	135	66	26	15	5	3

Of the 795 calls, 298 are deposited on the first choice either in an individual or combined group; 21 which are second choice in the individual group become first choice in the combined group; 6 calls are promoted from third choice to first choice; and so on.

TABLE VII

DISTRIBUTION OF OVERFLOW TRAFFIC FROM THIRD OUTLET

Distribution in Individual Groups	Number of Calls	Distribution in Common Group							
		Outlet							
		1	2	3	4	5	6	7	8
Outlet 4	180	89	55	22	9	4	1	—	—
5	97	7	36	40	6	8	—	—	—
6	42	3	4	12	16	5	1	1	—
7	18	1	—	—	8	5	4	—	—
8	7	—	—	—	—	1	1	5	—
9	2	—	—	—	1	—	—	—	1
	346	100	95	74	40	23	7	6	1

In this case 89 calls are deposited on the fourth choice or on the first common outlet, 7 calls are promoted from fifth choice to first common outlet, and so on.

TABLE VIII  
PERCENTAGE DEPOSITED ON FIRST COMMON CHOICE FROM EACH SOURCE

From	1st-Choice Traffic In Per Cent	4th-Choice Traffic In Per Cent
1st (or 4th)	298 ÷ 327 = 91.13	89
2nd (or 5th)	21 ÷ 327 = 6.42	7
3rd (or 6th)	6 ÷ 327 = 1.805	3
4th (or 7th)	1 ÷ 327 = 0.3	1
5th (or 8th)	1 ÷ 327 = 0.3	—

The agreement between these figures suggests that there is not any major difference between the distribution of groups of varying origin, and that about 10 per cent is deposited from promoted calls. As would be expected, the last column shows a smaller contribution from the fourth choice and a higher contribution from the later choices.

VII, and VIII show the summarised results of 25 hours with the artificial-traffic study.

8. Unmasking Calls in a Group Combination

With some general knowledge as to the probable constitution and history of the calls deposited on a combined outlet produced by a slipped grading, it is possible to study whether an overflow traffic and its equivalent first choice are substantially the same. The theory of the equivalent first-choice traffic for combining different-choice traffic disregards the possibility of any difference in the contribution from calls which fall on other than the first choice when the two groups are uncombined. It is evident, however, that some of these calls are unscreened as a result of the combination. To study the subject, 0.5 call-hour of second-choice traffic may be compared with its equivalent first choice, 0.428571 call-hour. It is natural that the pattern of the second-choice traffic will be more attenuated than the equivalent first choice, and this is clear from Table IX.

TABLE IX

Choice Upon Which Calls Are Deposited	0.5 Call-Hour Second-Choice Traffic	0.428571 Call-Hour First-Choice Traffic
1st		0.3
2nd	0.3	0.104
3rd	0.1375	0.022
4th	0.04712	0.0025
5th	0.01231	—
6th	0.00256	—
Overflow	0.00051	0.000071
Totals	0.5	0.428571

It is to be expected that the contribution from the unscreened calls will be greater from the overflow traffic than from its equivalent first-choice traffic because of the greater number of calls available.

TABLE X

Choice	Calls Offered	E.F.C.	E.F.C. +1	Ratio	Calls Taken
1	2.2	2.2		2.2/3.373	0.653
4	0.148	0.109		0.109/3.373	0.031
21	0.169	0.064		0.064/3.373	0.019
		2.373	3.373		0.703
2	2.2 - 0.653 = 1.547	1.32		1.32/2.47	0.534
5	0.148 - 0.031 = 0.117	0.084		0.084/2.47	0.034
22	0.169 - 0.019 = 0.15	0.065		0.065/2.47	0.026
		1.469	2.47		0.594
3	1.547 - 0.534 = 1.013	0.77		0.77/1.884	0.4087
6	0.117 - 0.034 = 0.083	0.0575		0.0575/1.884	0.0305
23	0.15 - 0.026 = 0.124	0.056		0.056/1.884	0.0297
		0.8835	1.884		0.4689
4	1.013 - 0.4087 = 0.6043	0.417		0.417/1.496	0.279
7	0.083 - 0.0305 = 0.0525	0.0368		0.0368/1.496	0.0246
24	0.124 - 0.0297 = 0.0943	0.0417		0.0417/1.496	0.0279
		0.4955	1.496		0.3315
5	0.6043 - 0.279 = 0.3253	0.223		0.223/1.27	0.1756
8	0.0525 - 0.0246 = 0.0279	0.0196		0.0196/1.27	0.0154
25	0.0943 - 0.0279 = 0.0664	0.0303		0.0303/1.27	0.0238
		0.2729	1.27		0.2148
6	0.3253 - 0.1756 = 0.1497	0.0997		0.0997/1.13	0.0882
9	0.0279 - 0.0154 = 0.0125	0.0105		0.0105/1.13	0.0093
26	0.0664 - 0.0238 = 0.0426	0.0198		0.0198/1.13	0.0175
		0.13	1.13		0.115
7	0.1497 - 0.0882 = 0.0615	0.0428		0.0427/1.057	0.0405
10	0.0125 - 0.0093 = 0.0032	0.0024		0.0024/1.057	0.0023
27	0.0426 - 0.0175 = 0.0251	0.0119		0.0119/1.057	0.0113
		0.0571	1.057		0.0541
8	0.0615 - 0.0405 = 0.021	0.0148		0.0148/1.022	0.0145
11	0.0032 - 0.0023 = 0.0009	0.0007		0.0007/1.022	0.0007
28	0.0251 - 0.0113 = 0.0138	0.0066		0.0066/1.022	0.0064
		0.0221	1.022		0.0216
9	0.021 - 0.0145 = 0.0065	0.0048		0.0048/1.009	0.0048
12	0.0009 - 0.0007 = 0.0002	0.0002		0.0002/1.009	0.0002
29	0.0138 - 0.0064 = 0.0074	0.0037		0.0037/1.009	0.0037
		0.0087	1.009		0.0087
10	0.0065 - 0.0048 = 0.0017				
13	0.0002 - 0.0002 = 0.0000				
30	0.0074 - 0.0037 = 0.0037				
	0.0054			Remainder	

Total traffic offered = 2.517

Overflow = 0.0054/2.517 = 1 in 500, approximately, and considering each group:

- 2.2 to 1st choice, loss = 1 in 1000
- 0.148 to 4th choice, loss = 1 in 1000
- 0.169 to 21st choice, loss = 1 in 50.

These figures indicate that the combination of late-choice traffic with first-choice traffic is unlikely to have an adverse effect on the first-choice traffic.

### 9. Probability of Late-Choice Calls Crowding out Early-Choice Calls

The approximation using an equivalent first-choice value for determining the behaviour of traffic gradings when groups of traffic are combined can be applied to an example:

2.2 call-hours of 1st-choice traffic  
 0.148 call-hour of 4th-choice traffic  
 0.169 call-hour of 21st-choice traffic.

It is probable that the third group, being the overflow from a large traffic group, will be liable to considerable variation. Any increase in the number of calls should not swamp the combined group so that the first-choice traffic bears a high probability of loss. The calculations which follow indicate that a large proportion of the calls in the second group are taken; thereafter the calls in the first group are taken, leaving the

majority of the remaining calls in the third group. If the number of calls in the third group were to be increased, it is clear that the other two groups would not be seriously reduced. See Table X.

### 10. Calculation of Equivalent First Choice

Table XI shows the equivalent first-choice traffic for ascending values of traffic when offered to different choices. A further column shows the ratio between the traffic offered and the corresponding equivalent first choice. The ratio figures are read off a series of curves drawn through the plots obtained by dividing the equivalent first-choice figure by the traffic offered to the choice under consideration. Any equivalent first-choice value may be calculated quickly by approximating the ratio in per cent and multiplying this figure by the traffic offered.

TABLE XI  
 CALCULATION OF EQUIVALENT FIRST CHOICE

Originating Traffic	2nd Choice				3rd Choice				4th Choice			
	Offered	Carried	E.F.C.	Ratio in %	Offered	Carried	E.F.C.	Ratio in %	Offered	Carried	E.F.C.	Ratio in %
0.1	0.0091	0.00864	0.0087	95.6	0.00046	0.00043	0.00043	93.5	—	—	—	—
0.25	0.05	0.0439	0.0459	91.8	0.0061	0.0056	0.00563	91.0	—	—	—	—
0.3	0.069	0.0592	0.0628	90.8	0.01	0.009	0.0091	90.0	0.001	0.00092	0.00092	92.0
0.4	0.1143	0.0927	0.1021	89.3	0.0216	0.01876	0.0191	88.6	0.00286	0.00257	0.00258	90.2
0.5	0.167	0.128	0.146	88.3	0.0385	0.0321	0.0331	87.0	0.00633	0.00554	0.00556	87.8
0.75	0.321	0.218	0.279	86.6	0.104	0.079	0.0857	83.1	0.0251	0.0204	0.0208	82.9
1.0	0.5	0.3	0.429	85.8	0.2	0.138	0.16	80.0	0.0625	0.0471	0.0494	79.0
1.25	0.694	0.372	0.592	85.3	0.322	0.201	0.252	78.2	0.1212	0.0845	0.092	75.9
1.5	0.9	0.434	0.767	85.2	0.466	0.264	0.359	77.0	0.201	0.13	0.15	73.7
1.75	1.114	0.488	0.953	85.4	0.626	0.324	0.48	76.5	0.302	0.179	0.218	71.5
2.0	1.333	0.533	1.142	85.7	0.8	0.379	0.61	76.3	0.421	0.23	0.295	70.2
2.25	1.558	0.573	1.341	86.0	0.985	0.429	0.752	76.3	0.556	0.28	0.389	70.0
2.5	1.786	0.606	1.54	86.2	1.179	0.474	0.902	76.5	0.705	0.33	0.492	69.9
2.75	2.017	0.636	1.75	86.5	1.38	0.514	1.06	76.8	0.867	0.377	0.604	69.9
3.0	2.25	0.662	1.96	86.8	1.59	0.55	1.22	77.0	1.04	0.42	0.724	70.0
3.5	2.72	0.705	2.39	87.5	2.02	0.61	1.56	77.7	1.40	0.496	0.984	70.2
4.0	3.2	0.738	2.81	88.1	2.46	0.659	1.93	78.4	1.8	0.56	1.27	70.6
4.5	3.68	0.766	3.27	88.8	2.92	0.7	2.33	79.1	2.22	0.613	1.58	71.2
5.0	4.17	0.788	3.72	89.4	3.38	0.73	2.7	80.0	2.65	0.657	1.92	72.1
5.5	4.65	0.807	4.18	89.9	3.85	0.757	3.12	80.8	3.09	0.693	2.27	73.0
6.0	5.14	0.823	4.66	90.4	4.32	0.779	3.52	81.5	3.54	0.724	2.62	74.0
7.0	6.12	0.848	5.58	91.2	5.28	0.814	4.38	82.9	4.46	0.77	3.35	75.7
8.0	7.11	0.867	6.52	91.8	6.24	0.84	5.25	84.1	5.4	0.81	4.17	77.2
9.0	8.1	0.882	7.48	92.3	7.22	0.86	6.14	85.3	6.36	0.833	5.0	78.7
10.0	9.09	0.894	8.43	92.7	8.2	0.876	7.07	86.4	7.3	0.854	5.85	79.9
11.0	10.08	0.904	9.41	93.1	9.18	0.889	8.01	87.4	8.3	0.87	6.7	81.1
12.0	11.08	0.912	10.36	93.5	10.16	0.899	9.0	88.4	9.3	0.884	7.6	82.1
13.0	12.07	0.919	—	—	11.15	0.908	—	—	10.2	0.895	8.5	83.1
14.0	13.07	0.925	—	—	12.14	0.915	—	—	11.2	0.904	9.4	84.0

TABLE XI—Continued

Originating Traffic	5th Choice				6th Choice				7th Choice			
	Offered	Carried	E.F.C.	Ratio in %	Offered	Carried	E.F.C.	Ratio in %	Offered	Carried	E.F.C.	Ratio in %
0.75	0.0047	0.004	0.00402	85.5	0.0007	0.00061	0.00061	87.1	—	—	—	—
1.0	0.0154	0.0123	0.0125	81.2	0.00307	0.00256	0.00257	83.7	—	—	—	—
1.25	0.0368	0.0277	0.0285	77.4	0.0091	0.00722	0.0073	80.2	0.0019	0.00156	0.00156	82.1
1.5	0.072	0.0507	0.0534	74.3	0.00213	0.01597	0.0162	76.4	0.0053	0.00417	0.0042	79.2
1.75	0.123	0.081	0.088	71.4	0.042	0.0298	0.0307	73.1	0.0122	0.00913	0.0092	76.0
2.0	0.19	0.117	0.133	69.6	0.0734	0.0492	0.0517	70.4	0.0242	0.0173	0.0176	72.7
2.25	0.275	0.1575	0.187	68.0	0.117	0.0741	0.08	68.4	0.043	0.0293	0.0302	70.1
2.5	0.375	0.2	0.25	66.7	0.174	0.1037	0.116	66.6	0.071	0.0456	0.0478	67.4
2.75	0.49	0.244	0.323	65.9	0.245	0.1373	0.159	64.9	0.108	0.0662	0.071	65.4
3.0	0.618	0.288	0.404	65.4	0.33	0.1737	0.21	63.7	0.156	0.09088	0.1	63.8
3.5	0.91	0.372	0.592	64.9	0.539	0.2507	0.335	62.1	0.289	0.15	0.177	61.2
4.0	1.24	0.446	0.804	64.8	0.796	0.3276	0.488	61.3	0.469	0.2177	0.278	59.2
4.5	1.61	0.512	1.05	65.2	1.09	0.3998	0.667	61.2	0.694	0.288	0.404	58.2
5.0	1.99	0.567	1.31	65.9	1.42	0.465	0.87	61.3	0.959	0.3567	0.565	57.8
5.5	2.4	0.615	1.6	66.6	1.78	0.523	1.1	61.7	1.26	0.421	0.727	57.7
6.0	2.82	0.655	1.9	67.3	2.16	0.573	1.34	62.2	1.59	0.479	0.919	57.8
7.0	3.69	0.718	2.55	69.1	2.97	0.654	1.89	63.6	2.32	0.577	1.36	58.6
8.0	4.6	0.765	3.25	70.7	3.83	0.714	2.5	65.2	3.12	0.653	1.87	59.9
9.0	5.52	0.8	4.0	72.4	4.72	0.76	3.16	67.0	3.96	0.71	2.45	61.8
10.0	6.47	0.827	4.78	74.0	5.64	0.794	3.86	68.5	4.85	0.755	3.08	63.6
11.0	7.42	0.848	5.58	75.3	6.57	0.8215	4.6	70.0	5.75	0.789	3.74	65.2
12.0	8.38	0.865	6.4	76.6	7.52	0.843	5.37	71.4	6.67	0.8165	4.45	66.7
13.0	9.35	0.879	7.27	77.7	8.47	0.861	6.19	72.8	7.61	0.8385	5.19	68.2
14.0	10.3	0.891	8.18	78.9	9.43	0.875	7.0	74.1	8.56	0.856	5.95	69.6
15.0	11.3	0.9	9.0	80.0	10.4	0.886	7.78	75.3	9.51	0.871	6.75	71.0
16.0	—	—	—	—	11.4	0.897	8.6	76.4	10.47	0.883	7.55	72.2
17.0	—	—	—	—	12.3	0.905	9.53	77.5	11.4	0.893	8.35	73.6
18.0	—	—	—	—	—	—	—	—	12.4	0.902	9.3	75.0
Originating Traffic	8th Choice				9th Choice				10th Choice			
	Offered	Carried	E.F.C.	Ratio in %	Offered	Carried	E.F.C.	Ratio in %	Offered	Carried	E.F.C.	Ratio in %
1.75	0.00303	0.00237	0.00237	78.2	—	—	—	—	—	—	—	—
2.0	0.0069	0.00516	0.0052	75.3	0.00172	0.00134	0.00134	77.9	—	—	—	—
2.25	0.0138	0.0099	0.01	72.6	0.00387	0.0029	0.0029	74.9	—	—	—	—
2.5	0.025	0.0172	0.0175	70.1	0.0078	0.00562	0.00565	72.4	0.00216	0.00162	0.00162	75.0
2.75	0.0418	0.0275	0.0283	67.8	0.0143	0.00993	0.01	70.0	0.00434	0.00316	0.00317	73.0
3.0	0.0656	0.0412	0.043	65.5	0.0244	0.0163	0.0166	67.8	0.0081	0.00568	0.00572	70.0
3.5	0.139	0.079	0.086	62.0	0.0596	0.0366	0.038	63.7	0.023	0.015	0.0152	66.0
4.0	0.251	0.1293	0.1485	59.6	0.122	0.0683	0.073	59.7	0.0534	0.0321	0.0332	62.3
4.5	0.406	0.1885	0.232	57.9	0.217	0.1112	0.125	57.3	0.106	0.0588	0.0625	58.9
5.0	0.603	0.2523	0.341	56.5	0.35	0.163	0.195	55.6	0.187	0.0954	0.104	55.6
5.5	0.839	0.3168	0.464	55.4	0.522	0.2205	0.283	54.1	0.3	0.1405	0.164	52.6
6.0	1.11	0.3791	0.611	55.1	0.73	0.2804	0.39	53.4	0.45	0.192	0.238	51.8
7.0	1.74	0.4903	0.963	55.3	1.25	0.397	0.658	52.6	0.85	0.304	0.436	51.2
8.0	2.47	0.581	1.39	56.3	1.88	0.499	1.0	53.2	1.39	0.412	0.711	51.2
9.0	3.25	0.652	1.87	57.6	2.6	0.584	1.4	54.1	2.02	0.507	1.03	51.4
10.0	4.09	0.707	2.42	59.0	3.38	0.651	1.87	55.3	2.73	0.587	1.42	52.0
11.0	4.96	0.7505	3.0	60.6	4.21	0.705	2.39	56.7	3.5	0.651	1.86	53.3
12.0	5.86	0.785	3.64	62.1	5.07	0.747	2.91	58.0	4.3	0.702	2.36	54.5
13.0	6.77	0.812	4.32	63.7	5.96	0.781	3.51	59.4	5.2	0.743	2.9	55.8
14.0	7.7	0.834	5.03	65.3	6.87	0.808	4.2	61.0	6.1	0.777	3.48	57.0
15.0	8.64	0.852	5.76	66.8	7.79	0.83	4.88	62.7	7.0	0.804	4.1	58.4
16.0	9.59	0.867	6.53	68.1	8.7	0.848	5.58	64.1	7.9	0.826	4.74	60.0
17.0	10.5	0.88	7.3	69.3	9.7	0.863	6.32	65.5	8.8	0.845	5.43	61.7
18.0	11.5	0.89	8.1	70.4	10.6	0.876	7.1	67.0	9.7	0.86	6.13	63.1
19.0	12.5	0.899	8.9	71.5	11.6	0.887	7.8	68.4	10.7	0.873	6.88	64.3
20.0	13.4	0.907	9.74	72.6	12.5	0.896	8.6	68.7	11.6	0.884	7.6	65.5
21.0	—	—	—	—	13.5	0.904	9.5	70.6	12.6	0.894	8.4	66.6
22.0	—	—	—	—	—	—	—	—	13.6	0.902	9.2	67.6

TABLE XI—Continued

Originating Traffic	12th Choice				14th Choice				16th Choice			
	Offered	Carried	E.F.C.	Ratio in %	Offered	Carried	E.F.C.	Ratio in %	Offered	Carried	E.F.C.	Ratio in %
3.5	0.00256	0.00181	0.00181	70.7	—	—	—	—	—	—	—	—
4.0	0.0077	0.00514	0.00517	67.1	—	—	—	—	—	—	—	—
4.5	0.01925	0.012	0.0121	62.9	0.0025	0.00169	0.00169	67.0	—	—	—	—
5.0	0.0414	0.0242	0.0248	59.9	0.0066	0.00425	0.0043	64.0	—	—	—	—
5.5	0.079	0.0432	0.0452	57.1	0.0152	0.00926	0.00935	61.0	0.00219	0.00144	0.00144	65.0
6.0	0.138	0.0698	0.075	54.2	0.0313	0.0179	0.0182	58.0	0.00535	0.00334	0.00335	62.0
7.0	0.334	0.1445	0.169	50.6	0.101	0.0507	0.0534	53.0	0.0232	0.01308	0.0133	57.3
8.0	0.65	0.239	0.314	48.3	0.245	0.1075	0.1205	49.1	0.073	0.0366	0.038	52.3
9.0	1.09	0.340	0.515	47.2	0.49	0.1855	0.228	46.6	0.179	0.0794	0.086	47.9
10.0	1.63	0.435	0.77	47.2	0.84	0.2752	0.379	45.1	0.365	0.142	0.166	45.4
11.0	2.27	0.519	1.08	47.6	1.3	0.3666	0.58	44.6	0.647	0.2194	0.281	43.6
12.0	2.97	0.59	1.44	48.4	1.86	0.4523	0.83	44.6	1.03	0.3038	0.44	42.3
13.0	3.74	0.649	1.85	49.5	2.49	0.528	1.12	45.0	1.51	0.388	0.63	41.7
14.0	4.54	0.698	2.31	50.8	3.19	0.594	1.46	45.8	2.07	0.466	0.87	42.0
15.0	5.38	0.7365	2.8	52.1	3.95	0.649	1.85	46.7	2.7	0.536	1.15	42.6
16.0	6.25	0.77	3.35	53.5	4.74	0.694	2.27	47.8	3.4	0.596	1.48	43.3
17.0	7.14	0.797	3.93	54.8	5.57	0.7326	2.73	48.9	4.15	0.648	1.84	44.3
18.0	8.04	0.8192	4.53	56.2	6.43	0.7643	3.24	50.3	4.93	0.6915	2.24	45.4
19.0	9.0	0.8378	5.17	57.5	7.3	0.7908	3.78	51.8	5.75	0.728	2.68	46.6
20.0	9.9	0.8536	5.82	58.8	8.2	0.812	4.3	53.1	6.6	0.7593	3.15	47.7
21.0	10.8	0.867	6.5	60.2	9.1	0.832	4.95	54.4	7.46	0.7854	3.65	48.9
22.0	11.8	0.8785	7.2	61.5	10.0	0.8478	5.57	55.6	8.4	0.8076	4.2	50.1
23.0	12.7	0.8884	8.0	62.8	11.0	0.8615	6.2	56.7	9.3	0.8264	4.76	51.3
24.0	13.7	0.897	8.7	63.9	11.9	0.8733	6.9	58.0	10.2	0.8426	5.35	52.5
25.0	14.6	0.9045	9.5	65.0	12.8	0.8835	7.6	59.1	11.1	0.8565	6.0	53.7
26.0	—	—	—	—	13.8	0.8925	8.3	60.1	12.0	0.8686	6.6	54.9
27.0	—	—	—	—	14.75	0.9003	9.0	61.1	13.0	0.879	7.3	56.1
28.0	—	—	—	—	15.7	0.9072	9.8	62.4	13.9	0.8882	7.9	57.3
29.0	—	—	—	—	—	—	—	—	14.9	0.8963	8.6	58.4
30.0	—	—	—	—	—	—	—	—	15.8	0.9035	9.4	59.4
Originating Traffic	18th Choice				20th Choice				22nd Choice			
	Offered	Carried	E.F.C.	Ratio in %	Offered	Carried	E.F.C.	Ratio in %	Offered	Carried	E.F.C.	Ratio in %
7.0	0.00418	0.00256	0.00257	61.5	—	—	—	—	—	—	—	—
8.0	0.017	0.00946	0.00915	55.8	0.00318	0.00191	0.00191	60.0	—	—	—	—
9.0	0.0524	0.02626	0.027	51.7	0.0124	0.0068	0.0068	55.0	0.00238	0.00141	0.00141	59.0
10.0	0.129	0.0581	0.0617	47.8	0.037	0.01876	0.0191	51.7	0.0089	0.00485	0.0049	55.0
11.0	0.270	0.1073	0.12	44.3	0.093	0.0422	0.0441	47.4	0.0267	0.01335	0.0135	50.7
12.0	0.49	0.1723	0.208	42.4	0.198	0.0803	0.087	44.0	0.067	0.0305	0.0315	46.9
13.0	0.8	0.2477	0.329	41.1	0.369	0.1335	0.154	41.7	0.144	0.0595	0.063	43.9
14.0	1.21	0.327	0.486	40.2	0.619	0.1988	0.248	40.1	0.275	0.1021	0.114	41.4
15.0	1.7	0.405	0.68	40.0	0.955	0.2715	0.373	39.0	0.473	0.1573	0.187	39.3
16.0	2.27	0.477	0.91	40.1	1.38	0.346	0.53	38.4	0.75	0.223	0.287	38.2
17.0	2.9	0.542	1.18	40.7	1.88	0.419	0.72	38.3	1.1	0.292	0.412	37.5
18.0	3.6	0.598	1.49	41.4	2.45	0.486	0.95	38.5	1.54	0.363	0.57	37.0
19.0	4.3	0.647	1.83	42.3	3.09	0.547	1.2	38.9	2.05	0.431	0.76	37.0
20.0	5.1	0.689	2.22	43.2	3.78	0.6	1.5	39.6	2.63	0.494	0.98	37.2
21.0	5.9	0.725	2.63	44.3	4.51	0.648	1.84	40.5	3.27	0.551	1.23	37.6
22.0	6.8	0.755	3.08	45.4	5.29	0.687	2.19	41.5	3.95	0.602	1.51	38.2
23.0	7.6	0.781	3.55	46.7	6.09	0.721	2.58	42.4	4.7	0.646	1.83	39.0
24.0	8.5	0.803	4.06	48.1	6.9	0.751	3.01	43.5	5.45	0.685	2.18	40.0
25.0	9.4	0.8215	4.6	49.3	7.8	0.776	3.46	44.6	6.25	0.72	2.56	40.9
26.0	10.3	0.8378	5.16	50.5	8.65	0.798	3.95	45.8	7.1	0.747	2.96	41.9
27.0	11.2	0.852	5.75	51.5	9.5	0.817	4.47	47.0	7.9	0.772	3.39	42.9
28.0	12.1	0.864	6.36	52.5	10.4	0.833	5.0	48.0	8.8	0.794	3.87	43.9
29.0	13.1	0.875	7.0	53.4	11.3	0.847	5.55	49.1	9.7	0.813	4.34	44.8
30.0	14.0	0.884	7.6	54.3	12.25	0.86	6.1	50.0	10.6	0.839	4.85	45.7

TABLE XI—Continued

Originating Traffic	24th Choice				26th Choice				28th Choice			
	Offered	Carried	E.F.C.	Ratio in %	Offered	Carried	E.F.C.	Ratio in %	Offered	Carried	E.F.C.	Ratio in %
10.0	0.00176	0.00103	0.00103	58.5	—	—	—	—	—	—	—	—
11.0	0.00637	0.00346	0.0035	54.9	—	—	—	—	—	—	—	—
12.0	0.0189	0.00947	0.0095	50.4	0.00454	0.00245	0.00246	53.9	—	—	—	—
13.0	0.0477	0.0219	0.0224	46.9	0.0134	0.00669	0.0067	50.0	0.00322	0.00173	0.00173	53.7
14.0	0.1044	0.0437	0.0438	44.0	0.0339	0.01565	0.0159	46.9	0.00944	0.00472	0.0048	50.8
15.0	0.203	0.0772	0.084	41.2	0.075	0.03194	0.0327	44.0	0.024	0.01114	0.0113	47.1
16.0	0.358	0.1227	0.14	39.1	0.149	0.0578	0.0613	41.1	0.054	0.0231	0.0236	43.7
17.0	0.580	0.179	0.218	37.6	0.269	0.095	0.105	38.8	0.109	0.043	0.045	41.0
18.0	0.878	0.242	0.319	36.5	0.445	0.142	0.165	37.1	0.2	0.0723	0.078	39.0
19.0	1.25	0.31	0.45	35.9	0.689	0.197	0.248	36.0	0.339	0.112	0.126	37.2
20.0	1.7	0.377	0.605	35.5	1.0	0.2605	0.353	35.2	0.536	0.1604	0.191	35.6
21.0	2.216	0.441	0.798	35.4	1.39	0.325	0.48	34.7	0.8	0.2163	0.276	34.5
22.0	2.79	0.501	1.0	35.8	1.85	0.389	0.6361	34.4	1.13	0.277	0.383	33.9
23.0	3.434	0.555	1.25	36.3	2.38	0.45	0.82	34.4	1.53	0.339	0.51	33.5
24.0	4.12	0.603	1.52	36.8	2.96	0.507	1.025	34.6	2.0	0.4	0.67	33.4
25.0	4.85	0.646	1.82	37.5	3.6	0.558	1.26	35.0	2.53	0.458	0.85	33.5
26.0	5.61	0.683	2.16	38.4	4.28	0.605	1.53	35.6	3.11	0.512	1.05	33.8
27.0	6.4	0.716	2.52	39.3	5.0	0.646	1.82	36.4	3.75	0.561	1.28	34.1
28.0	7.22	0.744	2.9	40.2	5.76	0.682	2.14	37.2	4.43	0.606	1.53	34.6
29.0	8.06	0.769	3.3	41.1	6.55	0.714	2.49	38.0	5.15	0.645	1.83	35.2
30.0	8.92	0.79	3.76	42.1	7.36	0.741	2.86	38.9	5.91	0.681	2.12	35.9

10.1 EXAMPLE OF CALCULATION

Combine: 0.2 to 30th choice  
 1.5 to 12th choice  
 0.6 to 4th choice.

Equivalent-First-Choice Value  
 0.076  
 0.708  
 0.419  
 1.203

0.2 (to 30th) should be multiplied by 38.1 =  
 1.5 (to 12th) should be multiplied by 47.24 =  
 0.6 (to 4th) should be multiplied by 69.9 =

Traffic carried 1.203/2.203 = 0.547 which can be distributed as follows:

From 30th, Calls carried 0.076/2.2 = 0.035,  
 Overflow = 0.165  
 From 12th, Calls carried 0.708/2.2 = 0.322,  
 Overflow = 1.178  
 From 4th, Calls carried 0.419/2.2 = 0.19,  
 Overflow = 0.41

Total = 0.547

TABLE XI—Continued

Originating Traffic	30th Choice			
	Offered	Carried	E.F.C.	Ratio in %
15.0	0.00664	0.00332	0.00333	50.1
16.0	0.0169	0.0079	0.0080	47.3
17.0	0.0385	0.0167	0.017	44.3
18.0	0.079	0.0317	0.0328	41.5
19.0	0.148	0.0547	0.058	39.1
20.0	0.256	0.0867	0.095	37.2
21.0	0.413	0.128	0.147	35.6
22.0	0.63	0.1772	0.218	34.4
23.0	0.91	0.2324	0.303	33.5
24.0	1.25	0.291	0.41	32.8
25.0	1.67	0.351	0.54	32.3
26.0	2.14	0.409	0.69	32.2
27.0	2.68	0.465	0.87	32.4
28.0	3.26	0.517	1.07	32.8
29.0	3.9	0.564	1.3	33.2
30.0	4.58	0.607	1.54	33.6

11. Appendix—Artificial-Traffic-Study Procedure

In conclusion, some notes on the arrangement of the artificial-traffic study may be of interest. Sets of 100 pairs of digits were extracted from the London telephone directory. The pairs of digits chosen were the "hundreds" and "tens" of subscribers' numbers. If adjacent entries were

identical they were rejected, as were also all those entries without a "thousand" digit. To obtain a greater chance distribution of digits, it is preferable to modify the pairs of digits as read by adding consecutively 1, 2, 3, 4, 5, etc., to each pair of digits and disregarding any carry over. See Table XII. From the 100 sets of pairs of

TABLE XII

Digits as Read	Add	Use
14	1	25
62	2	84
49	3	72
80	4	24
28	5	73

digits used, all those under 60 were considered to be calls arriving at the minute of the hour indicated by the value of the two digits. The process was then repeated to provide an indication of the number of seconds after the minute for each call. In cases where the minute and second indication for two or more calls were identical, a further two digits were established

to indicate the "ten millisecond" period after the coincident minute and second values.

The process described above was chosen to give a mean of approximately 60 calls per hour. It seems that for the purpose of measuring the number of calls falling on each of a number of contacts, it would be more satisfactory to choose exactly sixty values, thereby allowing no variation between the hours.

For any other number of calls for the hour period, it is only necessary to vary the quantity selected accordingly.

The calls forming the different groups are then combined in chronological order, the times being shown in different columns, and the outlet numbers being marked in corresponding columns. Prior to starting the first-hour period, a trial 30-minute period is put in to give the first hour a normal start.

It takes about 100 hours to record the distribution of a fifty-hour traffic record incorporating approximately 180 calls per hour, and an equivalent time can easily be spent in the compilation of the statistics so created.

# Technical Coordination on an International Basis in Communication and Allied Fields\*

By E. M. DELORAINÉ

*President, International Telecommunication Laboratories, Inc., New York, New York*

THE New York Section of The Institute of Radio Engineers has heard many valuable papers on technical subjects, but there have been only a few on a problem which is of importance, namely, the degree of international coordination in communication and related systems that is desirable or beneficial to all concerned.

The first question which comes to mind is whether there is a real need for any appreciable effort in this type of coordination; whether, in fact, the problems do not resolve themselves in the course of time without special steps being taken. In the case of communication by wire or cable, one might assume that it is sufficient to specify the transfer conditions at the junction between two systems. The other characteristics of the system might be considered of secondary importance.

In the case of radio transmission, the problem might be considered as even simpler. The characteristics of the transmission medium are fixed for all concerned and both ends must necessarily match the transmission medium. Consequently there is no real problem for interworking.

Such a superficial approach does not correspond to facts, and the past has taught us several lessons in this connection. It has been found in practice that unless agreement is reached, and at the proper time, on a large number of points, the international communication system will not function efficiently or economically. A few examples will illustrate this.

Long-distance communication by wire or cable is being handled more and more by means of carrier systems, either over pairs or coaxial cables. The individual voice bands are transposed to occupy a series of positions in the frequency spectrum. The characteristics of the voice bands and the manner in which they are

transposed must be specified in great detail if two systems are to interwork.

A long-distance telephone conversation is preceded, accompanied, or followed by a series of signals; they have to do with the selection of the wanted subscriber, the selection of the toll line, the ringing of the subscriber, the metering of the call on the basis of time and distance, and in some cases with the operation of the automatic toll-ticket printer, etc. If, at the time these various signals were introduced and the methods for their transmission selected, a broad plan had been made for interconnection of large networks on an international basis, it is almost certain that the importance of using only one or very few methods would have been fully appreciated. As no such plan was made, simply because it was not appreciated then that the problem would arise, a great many systems have been introduced with resultant complications.

The problems involved in interworking become more important and more pressing as the complexity of the networks and the number of countries involved increase. The introduction of a multiplicity of uncorrelated systems can affect the system to a point where the automatic operation of a large network, involving many countries, such as the European network at present, and probably the western hemisphere network in the future, may become very difficult. One can say, at least, that the lack of broad planning at the early stages later involves an appreciable amount of additional investment in interworking equipment, and some additional operating costs.

The radio communication situation parallels, to a large extent, the wire and cable network situation. As a matter of fact, in many cases, the radio operating method follows the same pattern as the methods introduced first on wires and cables, bringing, at the same time, all the complexities already indicated. The general introduction of printers on radio circuits is an example

\* Reprinted from *Proceedings of the I.R.E. and Waves and Electrons*, v. 34, pp. 872-873; November, 1946. Presented before New York Section, Institute of Radio Engineers, June 5, 1946.



involving coordination especially when the service is not terminal-to-terminal, but envisages interconnecting any two subscribers on an international basis.

The general introduction of single-sideband multichannel international telephone circuits involves problems which are closely parallel to those already mentioned in the case of carrier telephone systems on wire or cable.

In the not-too-distant future, the development of long-distance beamed multichannel ultra-high-frequency telephone circuits with relays will also involve a high degree of international coordination, if these systems are to extend over several countries.

It is not only essential in these problems to recognize the necessity of technical agreements, but it is also equally important to make plans for the probable communication networks of the world, far enough ahead, to recognize those elements which require international agreement.

Some may point out that in many cases the information available is not sufficient to allow making such plans with the required degree of accuracy. While this point must be conceded, it is also true that broad plans of this nature help substantially in visualizing future problems.

An interesting example taken from the past is that of the signals, and their methods of transmission, associated with telephone or telegraph communication, particularly in Europe. Apparently, when the various signals were chosen by the numerous parties interested for selection, ringing, metering, supervision, ticket printing, releasing, and the like, the problems were considered essentially on a regional basis. It was not realized soon enough that, when all networks would have to exchange many of these signals, the lack of coordination at the early stages would raise problems almost impossible to solve without adding much equipment for translating signals and insuring interworking conditions.

What happened in Europe is likely to happen in the world in the future as the scale of distances rapidly decreases, particularly with the introduction of fast air travel.

Large regions of the world are without adequate communication facilities and development of these facilities on a regional basis would later reproduce on a larger scale what happened in prewar Europe, for instance. The air traffic ex-

tending over all the world will create new exchanges of goods and commodities and thereby will call for additional communication facilities, following generally the pattern of the airways themselves. In consequence, plans of the probable world communication network in the less-developed countries of the world in relation to air transport appear to be very timely.

Let us consider now, methods which are capable of dealing with the problems just described.

Conferences were called and agreements were reached on certain communication matters before World War I, especially in relation to safety of life at sea. It was not, however, until after World War I that, due to a recognition of the great expansion of communication which was going to take place, the principal international committees were created dealing first with telephony, then telegraphy and radio.

These steps were in a large part the direct result of the presidential address of Sir Frank Gill to the Institution of Electrical Engineers in London in 1922. His proposals for international coordination in communication received a quick response and the Comité Consultatif International pour La Téléphonie à Grande Distance (CCIF) was formed and did exceedingly good work during the period between the two wars. The pattern set by this first committee was followed to a large extent in the creation of two other committees for telegraph and radio, known respectively as Comité Consultatif International Télégraphique (CCIT) and Comité Consultatif International Radio (CCIR).

These committees are, of course, a grouping of the operating agencies. They appoint technical commissions which study the problems listed by the committee. These commissions are permanent. They include operating, manufacturing, and laboratory experts, and they issue information and recommendations on the problems submitted. The recommendations are adopted or rejected by plenary assemblies of the operating agencies. These assemblies take place at intervals of one or two years. The recommendations when adopted are issued as international recommendations. They are widely distributed, and it is a fact that the operating authorities almost invariably specify when procuring equipments that all materials delivered will have to meet the CCI recommendations.

The real difficulties encountered at these meetings are not generally of a technical nature, but more often are due to the fact that a group of nationals may be reluctant to give up some temporary advantage for a general benefit or subordinate any portion of the sovereign rights of their country to matters of international character. Sir Frank Gill, who, since the creation of these committees has consistently been active in these matters, expresses himself in a recent letter as follows:

I think an illustration of this difficulty of sovereignty may even lie in the sphere of economics. It is conceivable that each of several different countries might find it economical to employ somewhat different systems of communication such that the whole would not give satisfactory results when put together. They must, therefore, find a compromise in economics to get the technical solution required by means of the best *joint* economics they can devise. In other words, the engineers must in such cases cease to think of themselves as working for any particular nation, they must work for the whole group.

I think it is along this line that the CCIF, CCIT, and probably the CCIR (though I am not so familiar with the latter) have done good work. They have faced the difficult subject of international standardization by concentrating on the essential clauses in specifications and they have not attempted to standardize rigidly any piece of apparatus. In the absence of any powers to compel nations to adopt their advice, they have worked in a very splendid manner along the lines of goodwill and although very much remains to be done, they have made very great progress in international (telephone) communication.

In spite of the shortcomings which we have stated, a large degree of order was introduced in Europe and in the world, prewar, due to the work of these organizations. The last war unfortunately partly destroyed this order through the introduction, principally by the Germans, of many non-CCI systems during the war period.

Experience was accumulated prewar on these very important matters. Consideration should now be given to the situation before us to see whether most questions requiring international agreements in our particular field are already solved, or have reached a stage where no further progress in standardization can be made, or whether there is at this stage, a possibility of great development requiring, in turn, that many steps be taken at the present time to prevent confusion in the future.

The latter appears to be the case and results from the many new aspects connected with the

development of communication with mobile and air transport. This example of air navigation can be translated to an extent also in terms of telephone communication with cars, trucks, busses, or railroad cars. This latter new facility does not involve problems by far as complicated as aviation, but it does call also for a large degree of coordination. A person interested in telephoning from his car might be surprised to find, in ten years, that he must buy or rent a multiplicity of equipments or adaptors to maintain contacts with the telephone network even over a limited area in the United States, not to speak of the difficulties he might run into if he attempts to cross the borders.

H. M. Pease, Chairman of the Board of International Standard Electric Corporation and a veteran in international communication, says in a memorandum:

I believe that the main communication arteries in future decades will follow the air routes and that the planning engineer can play an important part in bringing about standardization of systems and apparatus used by the various operating agencies throughout the world.

It is my opinion, after some study of the problem, that the questions of ground communication along the airways, for airways operation or for public use, communication with aircraft, weather reporting, air navigation, airport traffic control, and instrument approach are all interrelated.

These methods cannot be selected on a national basis either, as airplanes already travel from country to country and will do so more and more as time goes on. In consequence, the problems must be considered on a world basis. This requires an elaboration and study of typical world plans of air traffic. These plans cannot be accurate at this stage, but they will surely help to visualize the problems to be solved.

These problems when clearly understood and listed must be studied by the appropriate technical commissions including operating, manufacturing, and research people. These technical commissions should operate very much in the same manner already found so useful in the CCI committees. They would issue their recommendations to be approved by an assembly of operating agencies and these recommendations would in all probability become the basis of future procurement by all airlines.

If this is not done, our effort will be in vain; air

transport will be developed on the basis of a multiplicity of systems and methods involving as an immediate consequence a multiplicity of types of equipment, both on the ground and in the airplane. This will cause extra investment, extra load, unnecessary expenses, and a slowing down of the development in the whole field.

Imagine for a moment the complexities that will inevitably result from a lack of agreement in the assignment of radio channels or in the transmission characteristics of the numerous services already mentioned. Imagine, for instance, airports on the north Atlantic lanes, or in South America, or in Africa handling traffic of airlines of ten different nationalities, each differently equipped and utilizing different characteristics for their long-range and short-range communication, for navigation, radio altimeters, distance indicators, apparatus for anticollision or the equivalent, for airport approach, instrument landing, or weather reporting. It makes a rather discouraging picture by its very complexity and one realizes that the problems involved in handling such traffic would be almost impossible to solve.

It is clear, in consequence, that plans must be developed, agreed to, and followed, at least in our particular field, to permit orderly development of air transport.

International organizations already exist for making this study and preparing such plans. The most important bodies are the International Air Transport Association, working principally in terms of requirements, and the Provisional International Civil Aviation Organization, which

already has issued some general international recommendations. It is possible however that the importance of the task has not been recognized except by those directly involved, and we may encounter all the difficulties set forth by Sir Frank Gill in the above quotation.

The various technical societies, such as The Institute of Radio Engineers, can help in stressing the importance of technical agreements in these fields.

The objection one can raise to forward planning and standardization is that it presumes knowing the solution to many technical problems yet to be solved. Also, that the advantages of standardization are partly balanced by its tendency to retard technical progress. There is, of course, some truth in both points. A broad plan, however, can be prepared usefully, even with the present knowledge, or in some cases an extension of this knowledge into the immediate probable future. Such plans must not be crystallized but must change as new technical information becomes available. Regarding the second objection, it is necessary to introduce a large amount of free wheeling between development and operation, permitting development to proceed while the operating standard remains unchanged for periods.

The engineers, in general, and those of this Institute in particular, have to play their part in the development of world plans in communication and allied systems to bring about the full benefits which can be derived from the technical progress resulting in large part from their own labors.

# Extension of Norton's Method of Impedance Transformation to Band-Pass Filters

By VITOLD BELEVITCH

*Bell Telephone Manufacturing Company, Antwerp, Belgium*

SOME applications of a method of network transformation first discovered by E. L. Norton<sup>1</sup> and sometimes used in the design of band-pass filters are considered. Norton's method can be extended in different ways, and indicates in certain cases the design of new and more economical structures for composite band-pass filters.

## 1. Norton's Method

One alternative of Norton's method is based on the equivalence between the networks of Figs. 1A and B, where the transformer is assumed to be ideal. Another alternative can be deduced from the first case by the principle of duality.

In the network of Fig. 1B, at least one of the elements is negative, and thus physically unrealizable. The transformation can, however, be applied to a part of a network if the negative impedance can be absorbed into some positive impedance of the remaining part of the network.

For a positive transformation ratio, the series impedance in Fig. 1B is positive and only one of the shunt arms is negative. Physical realization requires that the negative arm should be combined in parallel with a smaller positive impedance. In the limiting case, the negative and positive shunt impedances may cancel each other and the result is an open circuit.

This equivalence was used by Norton to incorporate ideal transformers in ladder networks in which one shunt arm and the next series arm are simple elements of the same kind, e.g., both inductances or both capacitances. This occurs in some band-pass filters, and the design of such impedance-transforming filters is described in most textbooks.<sup>2</sup>

## 2. Transformation of a $\pi$ Network Consisting of Antiresonant Circuits

In the equivalence between Figs. 1A and B, the impedance  $Z$  is not required to be a single inductance or a single capacitance, but may be, for instance, an antiresonant circuit. As a parallel combination of antiresonant circuits is also an antiresonant circuit, the use of this method does not introduce new elements when applied to ladder networks composed of antiresonant circuits and terminated at midshunt.

The simplest case is a single  $\pi$  network (Fig. 2). This network will be modified by replacing the series arm with a network associated with an ideal transformer of arbitrary ratio as in Fig. 1B. The transformer can then be suppressed if all the impedances on the right-hand side and the output impedance are divided by  $k^2$ . By combining adjacent arms in parallel, a final structure

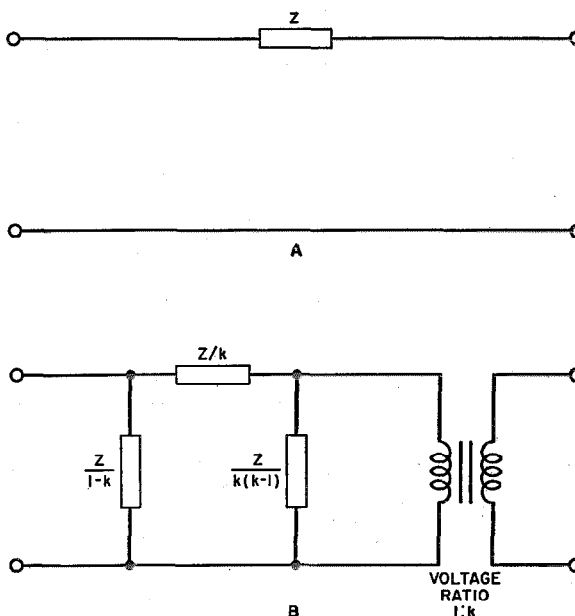

Fig. 1—Equivalent networks.

<sup>1</sup> United States Patent 1681 554.

<sup>2</sup> T. E. Shea, "Transmission Networks and Wave Filters," D. Van Nostrand Company, New York, New York, 1929; pp. 325-334.

is obtained which is obviously a  $\pi$  network similar to the original (Fig. 2). Both networks are electrically equivalent except for the transformed output impedance.

The values of the new circuit elements are easily computed from Fig. 1B, and the range of possible values for  $k$  is found to be restricted by the condition that all inductances and capacitances have positive values.

Before writing down these conditions explicitly, a general statement will be made regarding physical realizability. The following theorems are easily proved:

A. The frequency of antiresonance of the parallel combination of two physical antiresonant circuits always lies between their individual frequencies of antiresonance.

B. If a physical antiresonant circuit be considered as a parallel combination of two physical antiresonant circuits and one of these circuits be removed, the frequency of antiresonance of the remaining part, as compared to the frequency of the entire circuit, is either *increased* or *decreased*, depending on whether the frequency of antiresonance of the part removed is *lower* or *higher* than that of the original circuit.

Returning now to the transformation of the network of Fig. 2, suppose that  $k$  is less than unity so that the output impedance will be increased (in the opposite case, simply replace  $k$  by  $1/k$  and interchange input and output). The only negative impedance in Fig. 1B is thus the shunt arm on the right-hand side, and the only limiting conditions for  $k$  are the positive character of the new values  $L_3'$  and  $C_3'$  which arise from the parallel combination of the original  $L_3 C_3$  circuit with a negative circuit resonating at the same frequency as  $L_2 C_2$ . Denote these respective frequencies by  $f_3$  and  $f_2$ . To recognize whether the positive character of either  $L_3'$  or  $C_3'$  is more

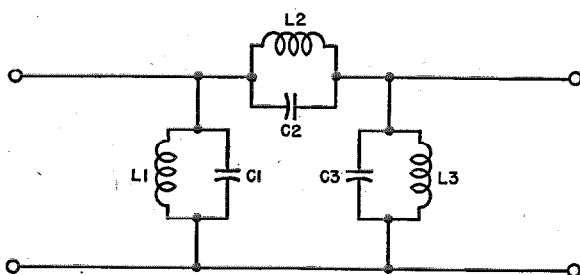

Fig. 2—Single  $\pi$  network using antiresonant circuits as elements.

restrictive, apply the last theorem. If  $f_2 > f_3$ , the combination of the positive and of the negative circuit is equivalent to the removal of a positive circuit with higher antiresonance frequency; the resulting frequency  $f_3'$  is thus decreased with re-

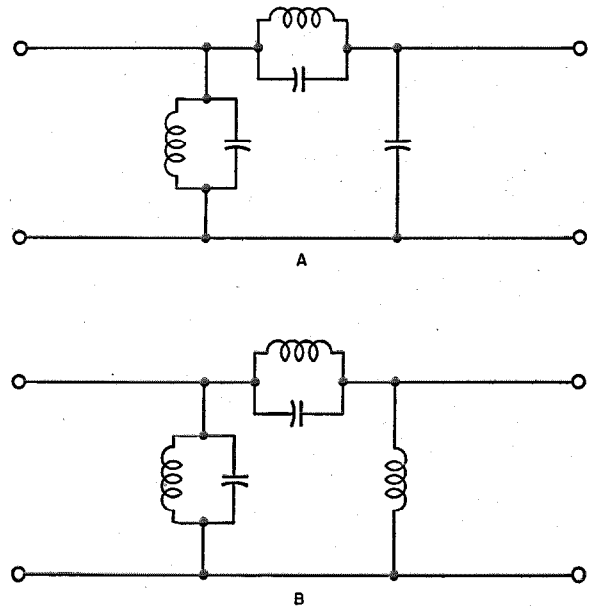

Fig. 3—Reduction of circuit of Fig. 2; A for cases where  $f_2 > f_3$ , and B if  $f_2 < f_3$ .

spect to  $f_3$  and can, in the limiting case, be reduced to zero. The new circuit is then reduced to a pure capacitance and a further decrease is impossible unless  $L_3'$  becomes negative. In this case the most severe restriction arises from the inductance. The opposite result occurs if  $f_3 > f_2$ .

In conclusion, the network of Fig. 2 may be reduced to the form of Fig. 3A if  $f_2 > f_3$ , or of Fig. 3B if  $f_2 < f_3$ , by a proper choice of the transformation ratio. In either case this transformation increases the output impedance as compared to Fig. 2.

An elementary calculation shows that in the case of Fig. 3A the ratio should be

$$k = \frac{L_3}{L_2 + L_3}$$

and in the case of Fig. 3B,

$$k = \frac{C_2}{C_3 + C_2}$$

By duality, inverse results are obtained for a T network composed of series-resonant circuits.

3. General Transformation

Consider a ladder network composed exclusively of antiresonant circuits (Fig. 4). This network will be modified by replacing each series arm by a  $\pi$  network associated with a transformer of arbitrary ratio, as in Fig. 1. All the transformers can be omitted if each impedance (and the output impedance) is divided by the square of the product of the ratios of all the preceding transformers. After combining adjacent arms in parallel, a final structure is obtained, which is obviously similar to the first one.

The whole process thus provides a means of transforming a ladder network of the type considered into an equivalent network of the same type, with a modified output impedance. As a special case, the output impedance is unchanged if the product of all the ratios is equal to unity. With the exception of this possible requirement, the arbitrary choice of the transformer ratios is only restricted by physical realizability of the new network elements. In spite of that restriction, a great diversity of equivalent networks can be obtained by this method.

Since the separation between negative and positive values for the new elements is found by equating them either to zero or infinity (on the limit of physical realizability), a suitable choice of the ratios should reduce a number of elements to short or open circuits. This number is generally equal to the number of independent ratios. Which elements can be suppressed by this method is a point to be discussed later.

Formulas will now be considered for the values of the new elements (denoted by primes) under the assumption that all the ratios are known, and without taking into account physical realizability. The network being composed of  $n\pi$  sections, there will be  $n$  impedance transformations,

with respective ratios  $k_1, k_2, \dots, k_n$  simultaneously applied. The values of the new elements are obtained from parallel combinations of arms appearing in Fig. 1B, and are thus more adequately expressed in terms of admittances. Denoting the admittance of the  $p$ th arm by  $Y_p$ ,

$$Y_p = C_p j\omega + 1/j\omega L_p = C_p j\omega + S_p/j\omega,$$

where  $S_p$  is the inverse inductance  $1/L_p$ , and introducing the notation

$$\left. \begin{aligned} q_0 &= 1 \\ q_1 &= k_1 \\ q_2 &= k_1 k_2 \\ q_3 &= k_1 k_2 k_3 \\ &\dots \\ q_n &= k_1 k_2 k_3 \dots k_n, \end{aligned} \right\} (1)$$

the new admittances are given by the following set of formulas:

$$Y'_{2p} = q_{p-1} q_p Y_{2p}, \quad (2)$$

where  $p = 1, 2, \dots, n$ ;

$$Y'_1 = Y_1 + Y_2 - q_1 Y_2; \quad (3)$$

$$Y'_{2p+1} = q_p [q_p (Y_{2p} + Y_{2p+1} + Y_{2p+2}) - q_{p-1} Y_{2p} - q_{p+1} Y_{2p+2}], \quad (4)$$

where  $p = 1, 2, \dots, n-1$ ; and

$$Y'_{2n+1} = q_n [q_n (Y_{2n} + Y_{2n+1}) - q_{n-1} Y_{2n}]. \quad (5)$$

Formula (2) corresponds to series arms, and (4) to shunt arms, the two extreme shunt arms having special expressions, (3) and (5). Each formula can be separated into two similar ones for capacitances and inverse inductances; for instance, (2) gives

$$S'_{2p} = q_{p-1} q_p S_{2p}, \quad C'_{2p} = q_{p-1} q_p C_{2p}.$$

Consider now the possible suppression of some inductances or capacitances in the modified

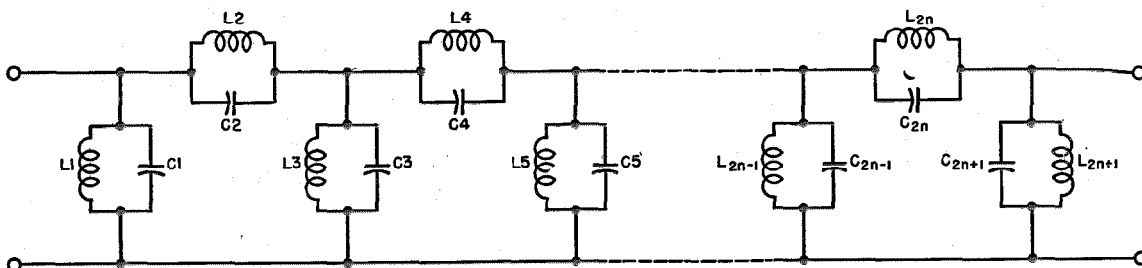

Fig. 4—Ladder network of antiresonant circuits.

network. As general results are difficult to obtain, some simple special cases will be analysed and a qualitative extension of their properties to similar cases will be discussed. We are primarily interested in suppressing elements and not in changing the output impedance, so we will suppose in the following analysis that the over-all transformation ratio  $q_n$  is equal to unity.

#### 4. Transformation of a Double $\pi$ Network

The first simple case is a two-section network, represented by the left-hand side of Fig. 4 with  $L_5 C_5$  as the last arm. If the output impedance is unchanged,  $q_2$  must be equal to 1, and (2) to (5) become

$$\left. \begin{aligned} S_1' &= S_1 + (1 - q_1)S_2 \\ S_2' &= q_1 S_2 \\ S_3' &= q_1(q_1 - 1)(S_2 + S_4) + q_1^2 S_3 \\ S_4' &= q_1 S_4 \\ S_5' &= S_5 + (1 - q_1)S_4 \\ C_1' &= C_1 + (1 - q_1)C_2 \\ C_2' &= q_1 C_2 \\ C_3' &= q_1(q_1 - 1)(C_2 + C_4) + q_1^2 C_3 \\ C_4' &= q_1 C_4 \\ C_5' &= C_5 + (1 - q_1)C_4 \end{aligned} \right\} (6)$$

The central shunt inductance  $L_3'$  will be reduced to an open circuit if  $S_3' = 0$ , i.e., if  $q_1$  is determined by

$$q_1 = \frac{S_2 + S_4}{S_2 + S_3 + S_4} \quad (7)$$

Since this value is less than unity, all the other new elements, except possibly  $C_3'$ , will be positive. Physical realizability of  $C_3'$  requires that

$$q_1 \geq \frac{C_2 + C_4}{C_2 + C_3 + C_4} \quad (8)$$

Eliminating  $q_1$  from (7) and (8), this condition becomes

$$\frac{S_3}{C_3} \geq \frac{S_2 + S_4}{C_2 + C_4}$$

or

$$L_3 C_3 \geq (C_2 + C_4) \frac{L_2 L_4}{L_2 + L_4} \quad (9)$$

and signifies that the antiresonant frequency of the initial central shunt arm  $L_3 C_3$  must be lower than the antiresonant frequency of both series arms  $L_2 C_2$  and  $L_4 C_4$ , in parallel. In the limiting case, where equality holds in (9), both  $S_3'$  and  $C_3'$  vanish. If (9) does not hold, a similar analy-

sis shows that the capacitor  $C_3'$  can be suppressed instead of the inductance.

A single  $\pi$  section composed of antiresonant circuits is a classical form of band-pass filter. The frequency of antiresonance of the series arm produces an attenuation peak which may be located at either side of the transmitted band, but the formulas for computing the elements are different in each case. When two  $\pi$  sections are combined, they form a structure of the type considered in this paragraph. The possibility of suppressing an inductance and a capacitance depends on the respective location of the attenuation peaks and the cut-off frequencies.

If both peaks are above the higher cut-off frequency, (9) is satisfied as a consequence of the first theorem of paragraph 2, and the central inductance may be suppressed.

When both peaks are separated by the transmitted band, it can be shown that the special case of equality in (4) is always satisfied, whatever the exact location of the peaks in their respective regions may be. This results directly from the formulas for the elementary sections. The final network in this case is represented in Fig. 5B, and is a well-known structure; the method of impedance transformation permits more easily the derivation of the rather intricate formulas for this structure and throws new light on the known fact that it can only be realized when the attenuation peaks lie in two opposite regions.

Final results are summarized in Fig. 5. In the figure, *A*, *B*, and *C* represent the structures obtained in the three cases distinguished above; corresponding attenuation characteristics are sketched in *D*, *E*, and *F*; *G*, *H*, and *I* represent the equivalent inverse T networks with series-resonant arms deduced from the first networks by the duality principle. It should be noted that, as inductors are usually more expensive than capacitors, the series type is to be preferred in the case of *F* and the shunt type in the case of *D* if only attenuation requirements are to be considered.

#### 5. Transformation of an Iterative Structure

A second particular case where a complete analysis is possible is the transformation of a midshunt-terminated iterative structure, i.e., a band-pass filter composed of  $n$  identical  $\pi$  sections.

Then

$$\left. \begin{aligned} Y_2 = Y_4 = Y_6 = \dots = Y_{2n} = Y_a, \\ 2Y_1 = Y_3 = Y_5 = \dots = Y_{2n-1} = 2Y_{2n+1} = Y_b. \end{aligned} \right\} (10)$$

By imposing the condition  $q_n = 1$ , there are  $n-1$  ratios  $q_1, q_2, \dots, q_n$  to be determined by the suppression of some of the elements. In suppressing the  $n-1$  intermediate shunt inductances in the modified structure,  $n-1$  linear equations are obtained for the ratios:

$$q_p(2 + S_b/S_a) - q_{p-1} - q_{p+1} = 0, \quad (11)$$

where ( $p = 1, 2, \dots, n-1$ ).

This set of equations will be considered as a linear difference equation for  $q_p$  with respect to

the index  $p$ , the boundary conditions being  $q_0 = q_n = 1$ . By writing

$$\left. \begin{aligned} 1 + S_b/2S_a &= \cosh \varphi, \\ \sinh \varphi/2 &= \sqrt{S_b/2S_a}, \end{aligned} \right\} (12)$$

the solution works out in compact form:

$$q_p = \frac{\cosh \left( \frac{n-p}{2} \right) \varphi}{\cosh n\varphi/2}. \quad (13)$$

As all values of  $q_p$  lie between 0 and 1, the positive value of only the intermediate shunt capacitances  $C'_{2p+1}$  ( $p = 1, 2, \dots, n-1$ ) need be checked. One easily obtains the formula

$$C'_{2p+1} = q_p^2 C_b (1 - f_b^2/f_a^2), \quad (14)$$

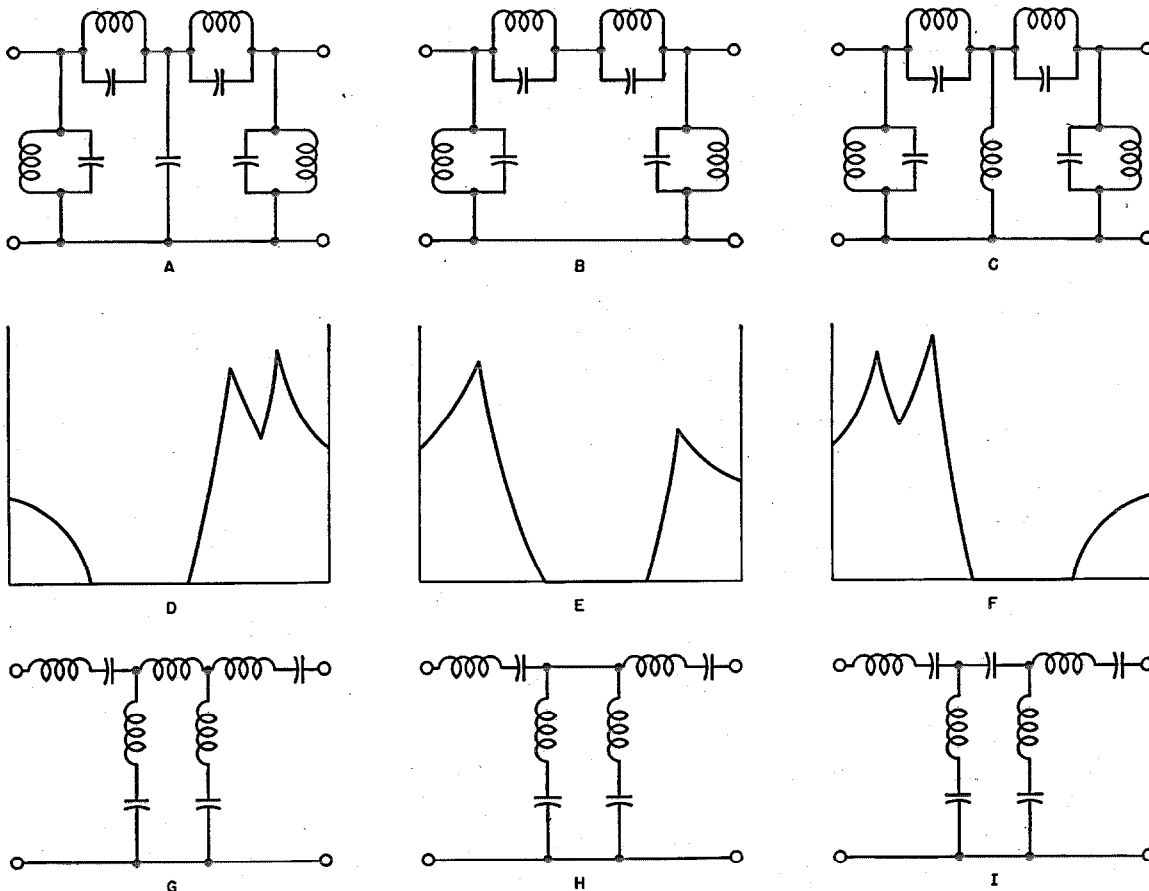

Fig. 5—A, B, and C are single  $\pi$  networks composed of antiresonant elements. D, E, and F are graphs of attenuation versus frequency, and G, H, and I are the equivalent T networks. The equivalent  $\pi$  and T networks and their attenuation characteristics are arranged vertically.



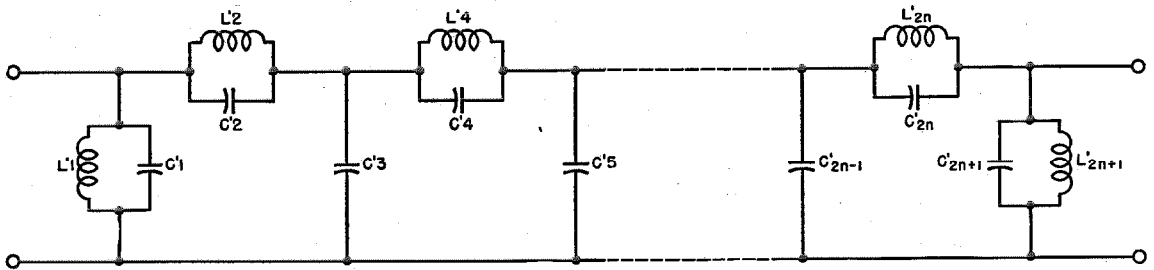

Fig. 6—Structure similar to a low-pass filter derived by suppressing the intermediate shunt inductances.

where  $f_a$  and  $f_b$  are the respective antiresonant frequencies of the original series and shunt arms. As a consequence of (14), the intermediate shunt inductances can be suppressed if  $f_a > f_b$ , i.e., if the frequency of infinite attenuation, common to all sections, lies above the transmitted band. The iterative filter is then transformed into a structure represented in Fig. 6, and explicit formulas may be obtained in terms of the usual design parameters. Notations and formulas are listed below:

$f_1, f_2 =$  cut-off frequencies ( $f_1 < f_2$ ).

$f_\infty =$  frequency of infinite attenuation ( $f_\infty > f_2$ ).

$$m = \sqrt{\frac{f_\infty^2 - f_2^2}{f_\infty^2 - f_1^2}} = \tanh \varphi/2.$$

$n =$  number of sections.

$R =$  nominal filter impedance.

$$L_0 = \frac{R}{2\pi(f_2 - f_1)}.$$

$$C_0 = \frac{f_2 - f_1}{2\pi R f_1^2}.$$

$$x = f_1/f_\infty.$$

$$q_p = \frac{\cosh (n/2 - p)\varphi}{\cosh n\varphi/2}, \quad (p = 0, 1, 2, \dots, n).$$

$$L'_{2p} = \frac{2mL_0}{q_p q_{p-1}}, \quad (p = 1, 2, \dots, n).$$

$$C'_{2p} = q_p q_{p-1} x^2 C_0 \cosh^2 \varphi/2, \quad (p = 1, 2, \dots, n).$$

$$C'_1 = C'_{2n+1} = \frac{C_0}{2} [(1 - q_1)x^2/m + \sinh \varphi].$$

$$L'_1 = L'_{2n+1} = \frac{2mL_0}{\cosh \varphi - q_1}.$$

$$C'_{2p+1} = q_p^2 (1 - x^2) C_0 \sinh \varphi, \quad (p = 1, 2, \dots, n - 1).$$

### 6. Conclusions

From the preceding analysis, it should be expected that in any composite band-pass filter for which the various infinite-attenuation frequencies are about the same and are all located above the transmitted range, all intermediate shunt inductances can be suppressed by simultaneous impedance transformations with an overall ratio equal to 1. This is also roughly suggested by the structure of Fig. 6, which is very similar to that of a low-pass filter. Although all attempts to prove this statement for an arbitrary alloca-

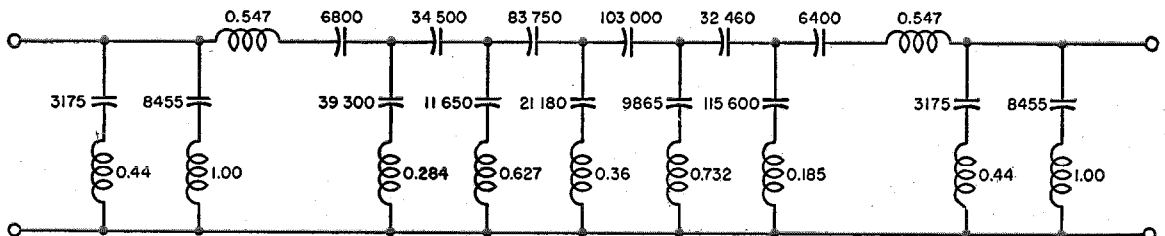

Fig. 7—Band-pass filter of 600 ohms impedance passing frequencies from 60.6 to 108 kilocycles. Inductances are in millihenries and capacitances are in micromicrofarads.

tion of attenuation peaks have been unsuccessful, its correctness was practically confirmed by the author's own experience in designing such filters.

By the duality principle and frequency transformation, the suppression of intermediate series inductances should be possible in a composite band-pass filter of the inverse type when all the frequencies of infinite attenuation lie below the transmitted band.

An illustrative example of this last case will be discussed briefly. A band filter (60.6–108 kilocycles per second, 600 ohms) having high attenuation (60 decibels in the range 12–59.4 kilocycles) for the lower side, and only a moderate attenuation (about 20 decibels) above 120 kilocycles, was required.

This filter is represented in Fig. 7, and the measured insertion loss in Fig. 8. Attenuation peaks at 124.5 and 54.7 kilocycles, and  $m$ -derived terminal impedances, are produced by two terminal

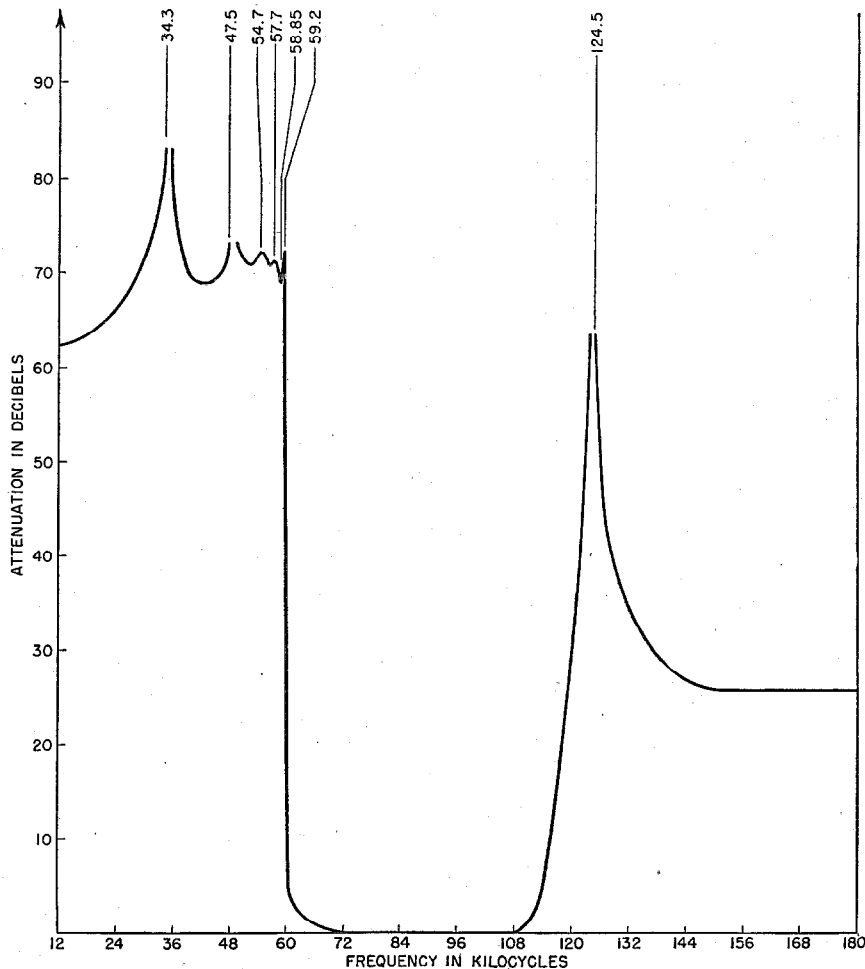

Fig. 8—Measured insertion loss of filter shown in Fig. 7.

half-sections of the classical type. The central part of the filter, producing attenuation peaks in the lower range only, has been successfully transformed by the use of the present theory.

# Bikini Observations and Their Significance\*

By HARADEN PRATT and ARTHUR VAN DYCK

*Official United States Scientific Observers*

THE OBSERVERS of Operation Crossroads were accommodated on ships of the general communications type. Designed to carry large military, naval, and air staffs in amphibious operations, they provided ideal quarters for this purpose. The observers were of several kinds: scientific men from the United States and the United Nations, United States congressional representatives, officers of the United States War and Navy Departments, and representatives of the press. In spite of the size and complexity of Operation Crossroads, it was executed in most efficient fashion throughout, and the excellent handling of observers was but one example of the general effectiveness of the organization, which was under the able command of Vice Admiral Blandy.

The *U. S. S. Panamint*, to which we were assigned, arrived at Bikini lagoon on the morning of June 29th and immediately steamed to an anchorage a short distance from Bikini Island by very slowly moving through the entire target array of some 72 ships. The sight was impressive in all respects. A mighty fleet was anchored row upon row on the azure waters of an immense tropic lagoon fringed with palm tree islands, waiting for the awesome test scheduled only two days away. Battleships, cruisers, carriers, destroyers, submarines, transports, and ships of other smaller types—even to a concrete drydock—were variously grouped around the target's bull's-eye to which the eye continually reverted, namely, the majestic battleship *Nevada*, conspicuous in bright orange paint and white turret tops and guns, the better to guide the bombardier on the fateful day.

It was obvious that these ships had been prepared for this special event since they were disposed in a pattern intended to reveal maximum information on damage at all distances. Their decks were fitted with all kinds of equipment and

materials of war to be subjected to the explosion. Each ship had graduated scales painted on bow and stern so that settlement could be noted from time to time through observation from aircraft. Even the islands bore evidence of the vast preparation that preceded our visit, as several steel towers to accommodate cameras and other instruments were easily visible.

That afternoon we visited the *Nevada*, the Japanese battleship *Nagato*, and the carrier *Independence*, where we saw the large number of test specimens mounted on their decks. These included samples of clothing, food, armor plate, airport fuel trucks, medical supplies, airplanes, and hundreds of other items of military weapons and supplies. The *Nagato*, commissioned about 1921, was of particular interest with her war wounds of the two direct hits from aerial bombs, including the skip bomb that went right through the ship via Admiral Yamamoto's quarters.

Long studies of Bikini July weather indicated that perhaps as many as twenty days could elapse before a suitable one for the drop would arrive. Besides adequate visibility it was required that the wind blow in the same direction from sea level to 20 000 feet so that radioactive products of the atomic fission would move away from all observers and not endanger them in the event of rain. However, on June 30th such weather was predicted for July 1, and the fleet of some 140 attending vessels steamed out of the lagoon maneuvering during the night to be at their assigned locations for the big event at 8:30 the next morning.

We on the *Panamint* saw the blast from the bridge deck through very dark special goggles at a point about twenty miles from the *Nevada*. Not being able at this distance to see any of the target fleet, many of us were not looking directly at the correct spot and so missed the initial point of flash. By the time eyes had moved over, the burst had already become a disk somewhat larger than the sun and considerably brighter, a conclusion made possible by being able to glance at the sun several times before the ship's public-address system announced "bomb away."

\* Reprinted in part from *Proceedings of the I.R.E. and Waves and Electrons*, v. 34, pp. 930-933; December, 1946. Presented at a joint meeting of the Institute of Radio Engineers, American Institute of Electrical Engineers, and Radio Club of America in New York, New York, on November 6, 1946. All photographs in this article courtesy of Joint Army-Navy Task Force One.

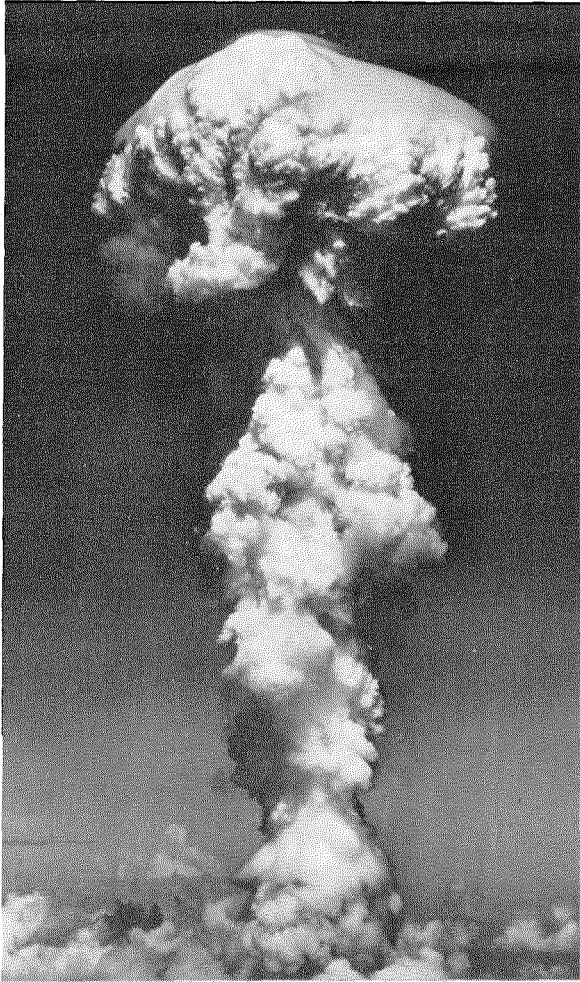

The first Bikini bomb, detonated above the water, sent a billowing cloud of smoke and flame almost forty thousand feet into the air.

The disk of intense light was immediately blotted out by the instantaneously formed luminous dome or hemisphere of incandescent gases which rested on the water, covering much of the target area. Quick loss of luminosity occurred, and with bare eyes we viewed the majestic column of atomic cloud with its mushroom top rise and shoot several thousand feet skyward in a matter of seconds. We estimated that this structure rose to a total of some 38 000 feet, displaying from the start interesting shades of pinkish colors against a fleecy white. The yellowish aspect of previous atomic explosions, ascribed to dirt and debris, was, of course, absent at Bikini.

By eleven that morning, we had moved up to the reef and examined the target fleet through binoculars while seeing at the same time yellow-colored drone boats darting about picking up water samples to test for radioactivity. These boats were remotely controlled from a distant destroyer with air units observing and directing. Test results were favorable for certain parts of the lagoon and our ships took anchorage there soon after lunch. Here we were able to survey the fleet clearly and note the many wrecked superstructures. The outstanding spectacles were the Japanese cruiser *Sakawa* with a list, down at the stern, and a completely wrecked top, and the carrier *Independence* with bad fires which culminated toward evening in spectacular explosions leaving the ship a shambles. The *Sakawa* turned turtle and sank the next morning.

Interesting and spectacular as all these events were, the full realization of the enormous significance of what had taken place unfolded rather slowly during succeeding days as we visited and examined ship after ship. Lessened radioactivity enabled ships to be boarded 48 hours after the burst. Within three-quarter mile radius, exposed wood was scorched black, crates and boxes were burned, and the *Nevada's* after deck, hit by the blast at an angle of about 25 degrees, was crushed down and blackened. Her funnels were pushed into her superstructure and the airplane crane on her stern bent double. It should be explained that after striking bull's-eyes on many practice runs, the bombing plane had the hard luck, on the real drop, of missing the *Nevada* by some hundreds of feet, a sore disappointment to the Army Air Forces.

Conditions were the same on the *Arkansas*, and worse on the *Pensacola* which was within a half-mile radius. All these vessels' decks and superstructures were a mass of wreckage, with bent bulkheads, twisted railings, smashed doors, stacks down, antenna gear deformed or broken—not to speak of peeling paint from the heat wave and the damaged or burned-out specimens placed on their decks. The blast wave even penetrated below, wrecking furnishings and doing other damage in spots here and there. Many vital items were seriously damaged, such as bulkhead-mounted motor-control cabinets, the switches and other parts of which were broken loose and completely inoperative. Broken castings in quantity

taught that naval ships of the future must avoid the use of metal fabricated in brittle forms.

It was unfortunate that our public was misled during the weeks preceding the tests by statements appearing in the press forecasting dire results and the possible unleashing of forces of nature such as earthquakes, tidal waves, and volcanic eruptions. It must be remembered that the effects of explosions diminish very rapidly with distance, and while the atomic holocaust sank and wrecked vessels up to one-half mile, damage to ships beyond one mile was relatively light. Heat, blast, and wave action at Bikini Island three miles away left almost no visible traces. Even direct blast and heat damage from huge volcanic explosions such as Krakatoa and Katmai extended over only small areas. Certain

excited spectators, therefore, had no logical basis for reporting disappointment because Bikini trees were not uprooted or because the blast at twenty miles did not blow them off their feet.

It must be remembered that, while five ships were sunk in the air test and about nine sunk plus two beached in the underwater test, conclusions as to the power of atomic bombs should not be based on the number of ships sunk. Obviously, if the whole fleet had been closely bunched most would have been sunk, whereas if widely dispersed not more than one such casualty would have occurred.

However, all these arresting phenomena, significant in their seriousness as they are, represent only the effect of heat and explosive action arising from the concentration of stupendous power at

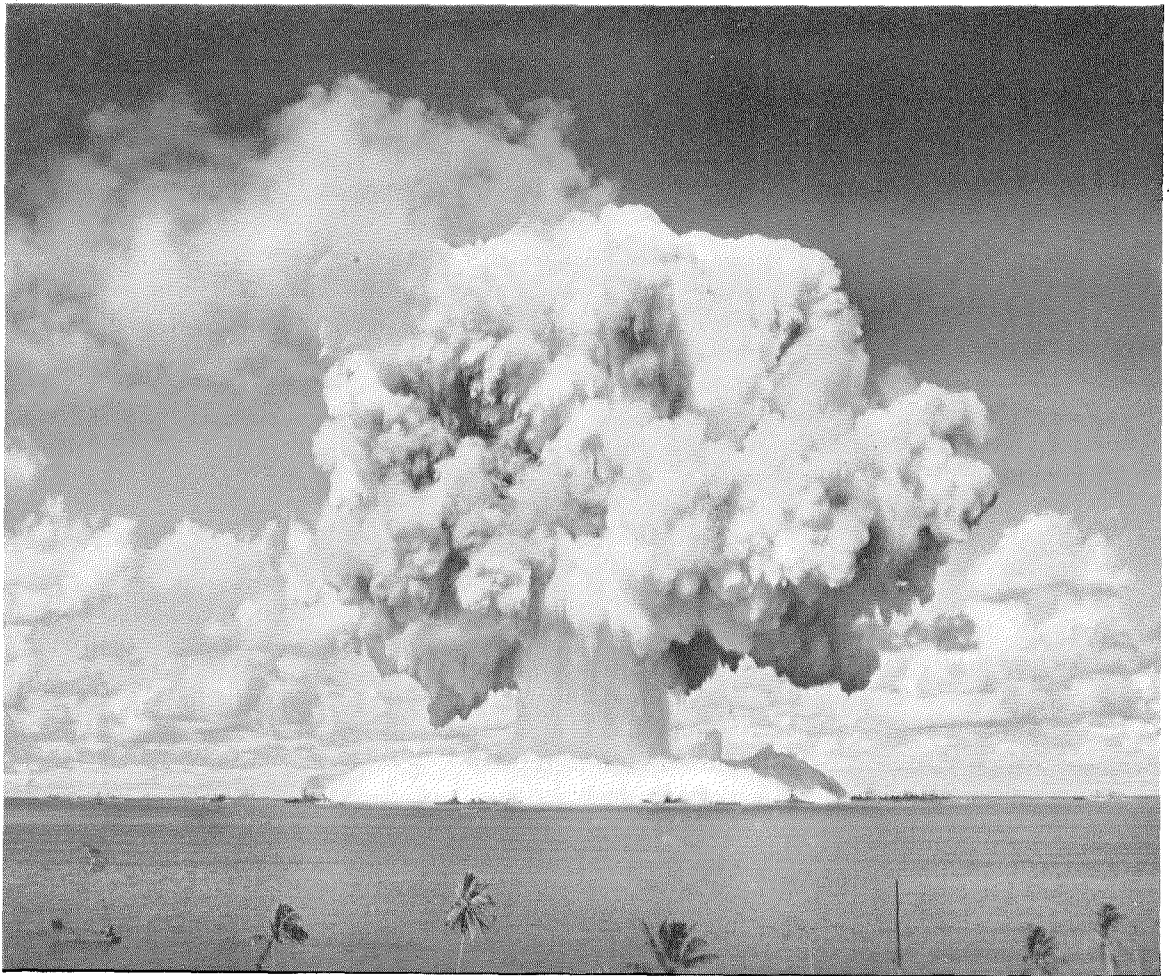

The huge column of radioactive water lifted by the atomic bomb was just starting to fall as this picture was taken by an automatically operated camera located on the atoll.

a single point. The effects of radioactive radiations, primarily neutrons and gamma rays, constitute the new feature which justifies the appellation of "Poison Bomb" as conveying the real meaning of this colossal development. Even though radiation diminished so fast after the first test as to enable ships to be safely visited a few hours later, it is doubtful whether but a few could have survived had the ships been manned when the bomb was dropped, even though the bulk of the crews might have lived long enough to render ships operative and resist post-explosion attack.

Any doubts as to the sweeping nature of the poison effect which may have existed were removed after the second atom bomb was ex-

ploded below the surface of Bikini lagoon. Millions of tons of sea water, hurled skyward over one mile in a column almost a half mile in diameter, were heavily contaminated with the fission products estimated as equivalent to hundreds of tons of radium. In the first test these products distributed in the atmosphere and were dispersed by the winds. This death-laden water in the second test fell directly on all ships in the lagoon and engulfed some in waves 70 to 100 feet high. This resulted in radioactive products being washed down ventilators, pipes, funnels, and scuppers, in saturation of all topside hamper, and in penetration to hidden places such as circulating systems, pumps, and evaporators.

Even ships not in the target fleet became dangerously contaminated by entering affected

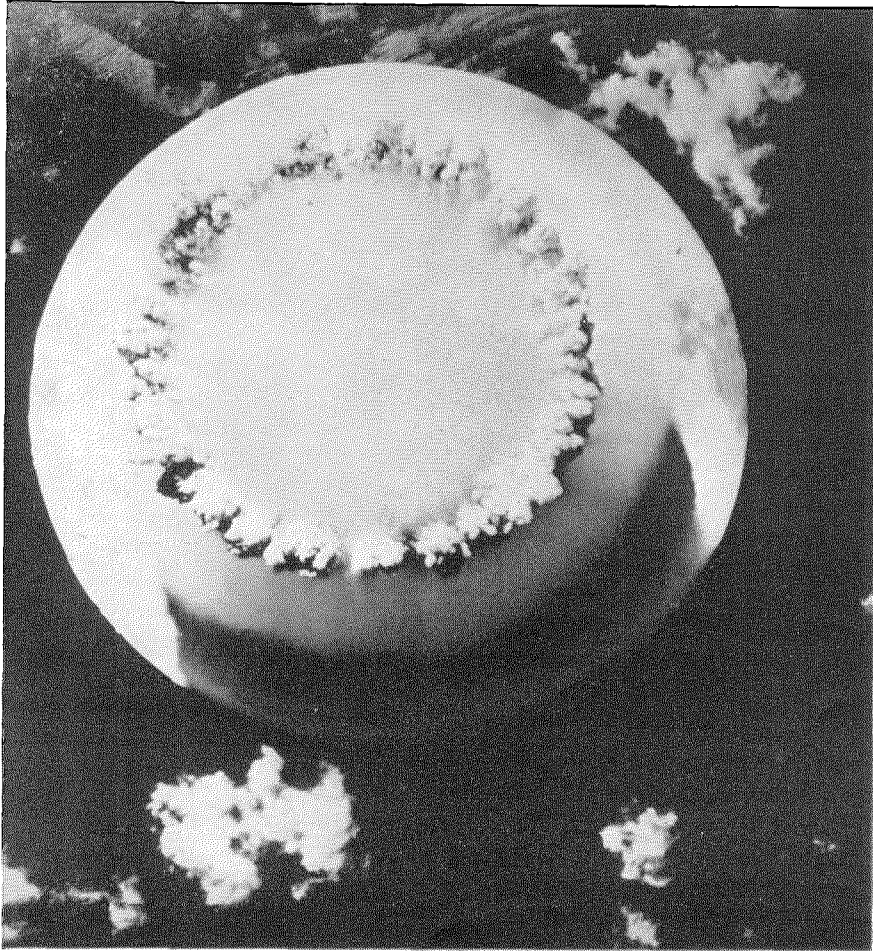

An airplane flying almost directly above the underwater explosion took this picture of the radioactive water and gasses which surged upward in a column a half mile in diameter.

lagoon areas afterwards. Many of the surviving vessels are still uninhabitable and others present vexatious problems of reconditioning because of gamma rays coming from materials lodged in the scale and incrustations inside sea-water piping.

Much has been said as to whether the tests were necessary and their cost justified, even though the cost was less than the value of a single modern battleship. Our considered opinion is that the tests were indispensable. Aside from arguments that scientists might fairly well predict results, and apart from the tremendous value of the precise technical information acquired, the mere holding of the operation under controlled conditions with many observers from all walks of life was of incalculable value to all mankind because the impact of the atom bomb reaches

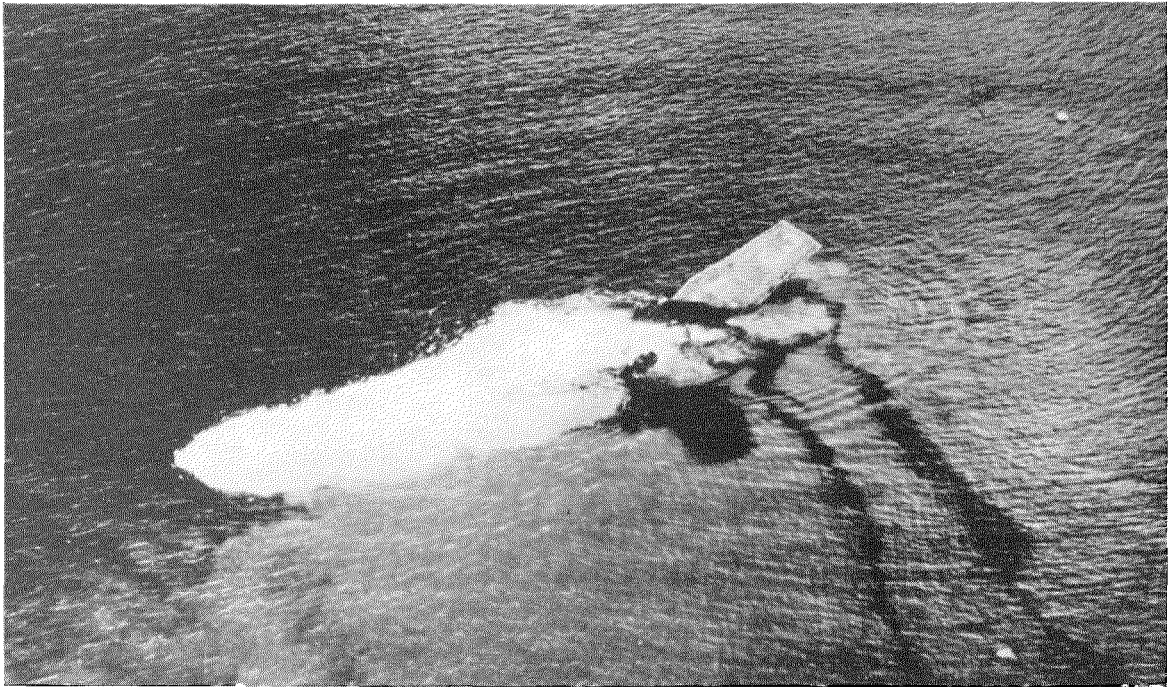

Seven and a half hours after the underwater explosion, the gallant old aircraft carrier *Saratoga* slipped beneath the radioactive waters of Bikini lagoon.

human beings everywhere. And there is no substitute for actual results indisputably to drive home the facts.

The significance of the Bikini tests is clear and powerful. Nevertheless, it has been the universal experience of the United States observers, on return from Bikini, that people with whom they have discussed the matter have been uncertain as to the significance of the tests and of the atom bomb generally. We have even found many people who are unwilling to talk or think about the subject, saying that it is just too horrible to contemplate. We would like to convince such people, and all people, that the atom bomb not only is horrible, but that it is so terrible that something must be done about it. That something is not to hide our heads in the sand—it is that we must insure ourselves against its use. And that means we must somehow prevent all war in the future.

The facts are very clear, and the best presentation may be merely to list them in simple language.

An atom bomb of the present type, exploding in the air, destroys everything within about one-quarter mile, does very heavy damage to one-half

mile, and heavy damage to one mile. Beyond one mile, the degree of damage depends upon the character of structures. Windows and light structures will be shattered at several miles.

An atom bomb of the present type kills practically all the human beings within one-quarter mile, a very high percentage of those within one-half mile, and a great many of those within one mile or more.

The present-type bomb, bursting in the air over New York City, would blow out every window within one or two miles and would knock off most of the roof structures and brick and stone facings of buildings, particularly skyscrapers. Casualties from glass and falling debris would be high. Fires from short circuits, broken gas mains, and other causes would be numbered in hundreds.

The present-type bomb, bursting under the water in New York City, would destroy subways, and would render uninhabitable for months an area of at least ten square miles. Each seaport city of the country would be similarly exposed.

The atom bomb is not the only new weapon of vastly greater destructiveness. The guided missile, like the German V-1 and V-2, is another.

The power and destructiveness of weapons has

been increasing rapidly for the last 100 years. World War I saw the first wide use of high explosives.

World War II achieved vast destruction. Most people of the United States do not realize this. The people of London, Coventry, Rotterdam, Warsaw, Stalingrad, Berlin, Tokio, and Pearl Harbor *do* realize it.

World War II dislocated civilization, and almost completely wrecked it through destruction of so much of the economic structure of the world.

A third World War will be vastly more destructive of both economic structures and of human beings. Since World War II was almost enough to destroy civilization, a vastly worse War III is certain to do so.

There is no defense against the atom bomb or against the guided missile, or, of course, against a combination of the two. Defense has never been perfect against any weapon. Against the atom bomb, unless the defense is perfect, it is no defense. Not one German V-2 missile was shot down of the many that approached London. If two or three of them had had atom bombs in them, London would have become an empty shell.

We have now reached that advanced state of civilization wherein we have made it possible for a few uncontrolled members of our society to destroy or to subjugate the rest of us, before we

can do anything about it. The fact is that material development has reached a dangerously high level. We have been settling arguments by force from the beginning of man on earth, but usually the side of moral right has been able to marshal enough might to prevail sooner or later. Now we have a new situation, and there is little protection left in material things.

All this has been said before. Indeed, it has been said so many times that the thought has become familiar and has lost its true meaning to many people. This complacency is dangerous. These facts mean that a revolution in human affairs has occurred. Hereafter civilization must struggle not to advance, but actually to survive. These are not mere words, they are elementary truths. All this should be obvious to everyone, and particularly to those men charged with the responsibility of government. It is evident that the only safety is in means which will make it impossible for any nation to attack another.

The only possible safe policy for the future must be one which rests on the law and the conscience of man. Nations must be controlled, as we now control states, counties, cities, and individuals.

We must have world law and order. That is the simple significance of nuclear fission—and of Bikini.



# Landing Aircraft with Ground Radar

By J. S. ENGEL

*Federal Telephone and Radio Corporation, Newark, New Jersey*

**G**UIDANCE in the landing of aircraft under conditions of poor visibility and without special airborne equipment of any kind is the function of Radio Set AN/MPN-1C, a mobile equipment. A search radar system picks up the airplane at distances to 30 miles, and at 10 miles control is shifted to a precision radar system and a team of three operators. Standard air-ground radiotelephone communication is used to inform the pilot constantly of his position until, at 50 feet above the runway, the pilot is ordered to complete the landing without further aid.

• • •

Ground radar for informing a pilot of the position of his aircraft in making an approach for a blind landing was first suggested in 1941 by Dr. Luis W. Alvarez of the Radiation Laboratory at Massachusetts Institute of Technology. His proposal was stimulated by the needs of the

air forces. The radio range and marker-beacon systems then in use required additional airborne receiving and indicating equipment as well as special training of pilots—handicaps which the air forces could ill afford. By 1943, the new ground-controlled-approach equipment, developed under the direction of Dr. Alvarez, and later to be manufactured in the U.S.A. by Federal Telephone and Radio Corporation and others, was operating successfully in England, guiding bombers, back from raids over Germany, to safe landings through zero visibility.

As embodied in Radio Set AN/MPN-1C, radar is used to track incoming aircraft, which may carry only standard airborne two-way communication equipment to receive all necessary information. The set has given dependable service under most types of instrument landing conditions. Its mobility is an added feature, permitting rapid shifting from one runway to another and from one airfield to another, as

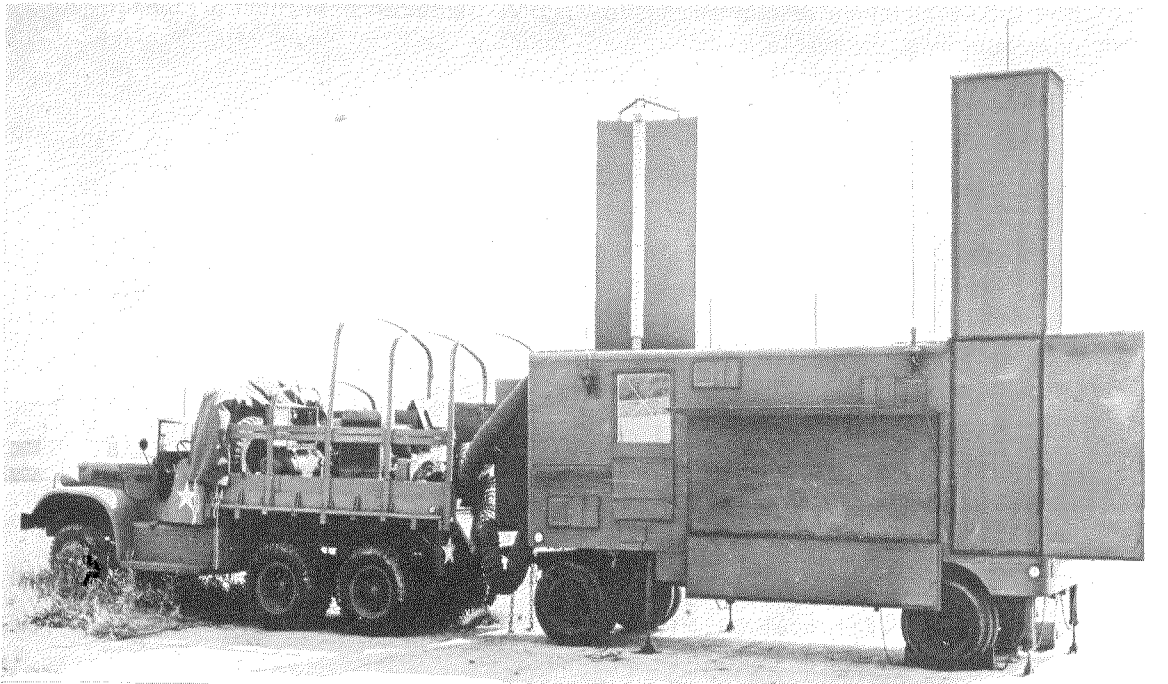

Fig. 1—Ground-controlled approach equipment in operating position showing the prime mover with its power equipment and air conditioner, and the main trailer with its search, precision, and communication antennas. The trailer-leveling jacks may also be seen.

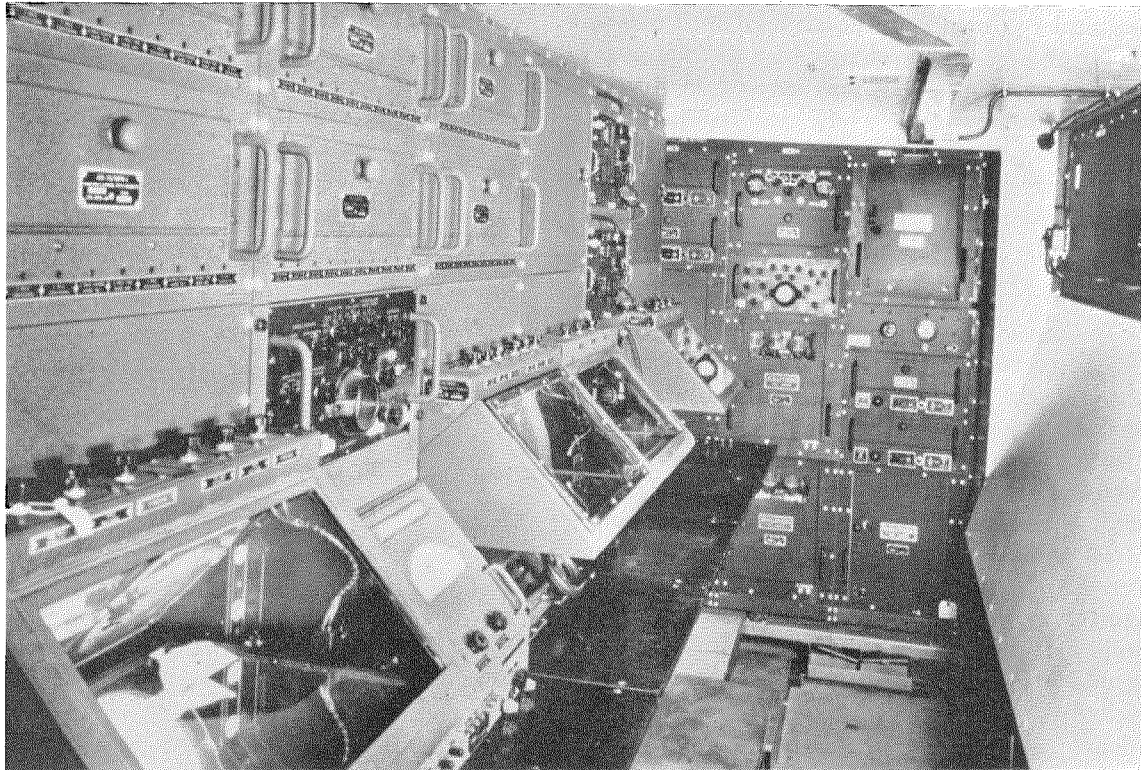

Fig. 2—Interior of the trailer. The various indicators, synchrosopes, radar transmitters, receivers, transmission lines, and communications equipment are much in evidence.

conditions require. Fig. 1 shows the equipment set up for operation.

### 1. Operation

The ground equipment comprises a search radar, a precision radar, and standard two-way radiotelephone air-ground facilities installed in a single trailer which is located near the windward end of a landing runway. The precise location of the trailer is determined with respect to the beam-scan coverage of the precision-radar azimuth antenna. The search radar obtains information for controlling air traffic within a 30-mile radius at altitudes up to 4000 feet. The precision radar supplies data to direct an aircraft along the proper glide path for a safe approach. Each radar, operating in the microwave range, has its own transmitting, modulating, receiving, and indicating systems. The search-radar antenna scans 360 degrees in azimuth. The two antennas of the precision radar scan sectors in azimuth and elevation, respectively. A synchronizer unit triggers the modulators and indicators of both radars. Further to insure synchronization, the pulse modulator is common

to both radars. The communications equipment is used to relay information to the aircraft being landed. Fig. 2 is an interior view of the trailer.

#### 1.1 LANDING PROCEDURE

An aircraft entering the traffic-control area of the airport establishes radio contact with the control tower and requests landing instructions. The operator in the tower transfers control of the aircraft to the traffic director in the trailer. Viewing the plan-position indicator, which is part of the search radar, the traffic director first identifies the aircraft and then, by radio, instructs the pilot as to correct heading and elevation.

A common method of establishing identity is to have the aircraft fly along a leg of a nearby radio range so as to come in directly over the range station, which the pilot identifies by the cone of silence above it. The pilot informs the traffic director as soon as the aircraft enters the cone of silence. After verifying this position on the plan-position indicator, the traffic director gives the pilot headings which enable him to fly

an orbital course about the airfield until clearance for an approach is signaled by the operator in the control tower. In this way, several aircraft may be managed while awaiting landing instructions. As all aircraft flying in the vicinity of the airfield are visible as radar targets, the traffic director is enabled to give the instructions needed to avoid collisions.

### 1.1.1 Search Radar

The presentation on the plan-position indicator is in the form of a polar map having the radar at the center and showing range and azimuth. Distances from the radar to the various targets are measured along the radii of the sweep; the azimuth indication is synchronized with the beam direction of the search-radar antenna. The plan-position indicator may be operated on any one of three ranges: 7.5, 15, or 30 miles. It is not viewed directly, but through a semisilvered mirror mounted in a horizontal position. The indicator tube is mounted at a 45-degree angle above the mirror, and a map (which shows the proper approach to the field) is mounted at a 45-degree angle below the mirror. As seen through the mirror, the map appears to be superimposed on the face of the indicator tube.

When the tower signals that the field has been cleared for an approach, the radio communications channel controlled by the traffic director is taken over by the plane selector, who works from another plan-position indicator in the trailer. The plane selector then gives one of the waiting aircraft instructions for starting an approach. The pilot is given headings and altitudes until the plane is within range of the precision radar. The starting position is approximately at a 1000-foot altitude, 8 to 9 miles from the field and in line with the end of the runway. The plane selector then directs the pilot to head toward the runway and, over the intercommunication system in the trailer, informs the operators of the precision radar that the aircraft is ready to complete the approach.

### 1.1.2 Precision Radar

The precision operators comprise a team of three men: an azimuth tracker, an elevation tracker, and an approach controller. By operating the handwheel cursors and pedals which control antenna positions, the azimuth tracker follows the aircraft first on the 10-mile indicator, and then on the 2-mile indicator. During the last part of the approach he places the "fast-slow scan" switch in the "fast" position; which gives

him greater tracking accuracy. To facilitate resolution of the aircraft from other targets at this close range, the azimuth tracker also operates the receiver gain control, enabling him to regulate the amplitude of the received echo. The elevation tracker performs similar operations at the 10- and 2-mile elevation indicators, except that he is relieved of the control of the scan rate.

Like the plan-position indicator of the search radar, the indicators of the precision radar are viewed through semi-silvered mirrors. The

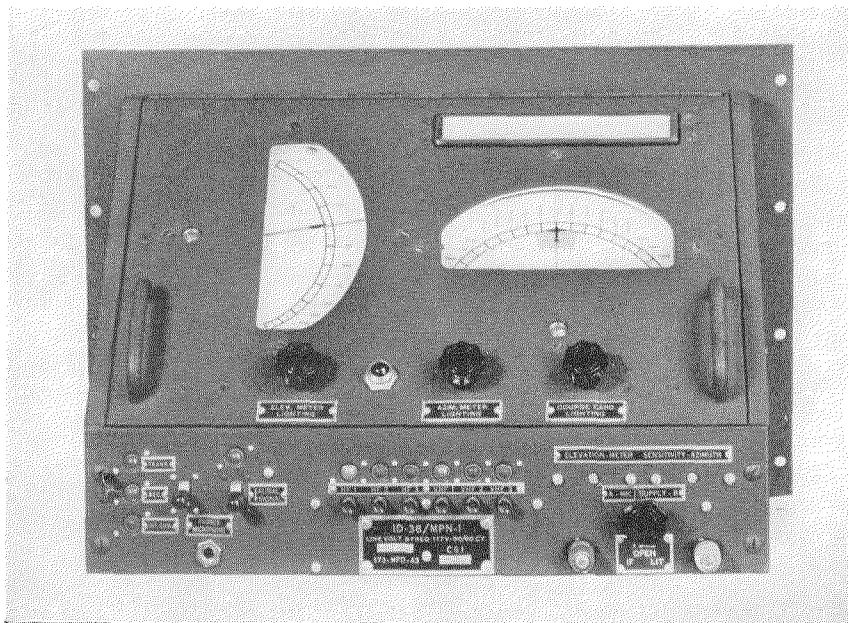

Fig. 3—A view of the approach-controller's indicator showing the error meters and communication-channel-selection controls.

azimuth and elevation indicators employ four 7-inch cathode-ray tubes. The two azimuth indicators show azimuth with respect to range as determined by the azimuth-scanning antenna, and the two elevation indicators show elevation with respect to range as determined by the elevation-scanning antenna. This type of presentation is known as expanded partial plan-position indication. On this indicator the angular coverage is expanded, and the trace origin is located near the edge, instead of at the center, of the face of each tube thus utilizing a greater area of each tube face.

The intensity-modulated picture which appears on each tube face reveals the radar-calibrating reflectors which are placed at appropriate positions along the runway, the obstructions and terrain along the glide path, as well as the approaching aircraft. The azimuth and elevation trackers see each radar picture with a superimposed illuminated cursor and a V-notch follower. The cursor, on which a line is engraved, is mounted so that it can be moved parallel to the range marks on the radar map. The V-notch follower is mounted so as to pivot about the trace origin. When the aircraft signal comes into view each tracker first bears on it with the V-notch follower by working the antenna-control pedals. The azimuth tracker's pedals control the elevation antenna, while the elevation tracker's pedals control the azimuth antenna. Each tracker then turns the handwheel which adjusts the cursor so that the engraved line is centered on the received signal. If the aircraft changes course, he readjusts the pedals and handwheel to keep the cursor and follower "on target."

When both trackers are definitely "on target" they operate the "data good" switches which illuminate the error meters on the approach indicator. (See Fig. 3.) The error meters are operated by the cursors on the indicators of the azimuth and elevation trackers, are calibrated in feet, and indicate deviations of the aircraft from the desired path. This information is interpreted by the approach controller.

After receiving "good data," the approach controller is ready to take over the control of the aircraft and "talk down" the pilot. Using the intercommunication system, the approach controller informs the plane selector accordingly,

and takes over control of the radio communication channel to give the pilot preliminary instructions for completing the approach. These include landing drill (wheels and flaps), correct air speed, and proper rate of letdown. The approach controller continues to relay correct headings and rate of descent to the pilot so that he remains in the proper path. Towards the end of the approach the pilot is directed not to use his radio to acknowledge instructions. When the aircraft is about 50 feet above the runway, the approach controller tells the pilot how many feet he is from the center line of the runway and orders him to complete the approach visually.

Thus from the instant that the pilot establishes standard radio contact with the ground-controlled-approach equipment, his navigation is accomplished for him from the ground, except for the last few feet of his course when he can see his way to a visual landing. Fig. 4 illustrates the manner in which the equipment performs its functions of guiding aircraft to a safe landing under conditions of zero visibility.

## 2. Equipment

To insure dependable operation, all electronic components of the search and precision radars, except for indicators and antennas, are duplicated as two complete channels. Either channel may be operated while the other is on stand-by or off. Normally, one channel is operated at a time. Should the operating channel fail, the stand-by channel is placed in service, and the defective channel is secured for repairs.

Each channel of the search radar includes a modulator, transmitter-converter, and receiver. Both channels employ the same antenna and indicators.

Each channel of the precision radar includes a synchronizer which triggers the search radar, a modulator, a transmitter-converter, a receiver, two sweep amplifiers, two channel switch units, two angle-coupling units, and a set of power supplies. The antenna assembly and indicators are common to both channels of this radar.

The communications system comprises three very-high-frequency radio transmitter-receiver equipments (SCR-522-A), each transmitter of which may be operated on any one of four pre-tuned channels between 100 and 156 megacycles

with 8 to 10 watts of power and amplitude modulation, and three high-frequency radio transmitter-receiver equipments (SCR-274-N transmitters and BC-342 receivers). Each of these transmitters may be operated on any one of three pretuned channels between 2 and 9 megacycles with 15 to 25 watts of power and amplitude modulation.

## 2.1 SEARCH RADAR

The 10-centimeter search radar is fired by the synchronizer unit, which is part of the precision radar. A blocking-oscillator circuit in the synchronizer generates a positive trigger voltage at a repetition rate of 2000 cycles per second. This trigger voltage is fed to a line-controlled blocking oscillator in the modulator, which generates a 0.5-microsecond positive pulse. The pulse is applied to the grids of two pulse-modulator tubes connected in parallel to a capacitor which has been charged to 15 kilovolts through a resistive network from the high-voltage power supply. When the modulator tubes conduct, the capacitor is discharged, so that a negative 15-kilovolt pulse is applied to the magnetron which in turn generates a 10-centimeter radio-frequency pulse of 0.5-microsecond duration. After each pulse, the capacitor recharges. In this way the magnetron transmits a radio-frequency pulse of 85 to 100 kilowatts of peak power (85 to 100 watts average power) 2000 times each second.

Energy from the magnetron is coupled through a duplexing circuit and a transmission line to the antenna. The function of the duplexer is to switch the single antenna from the transmitting circuit to the receiving circuit. Only a small part of the total transmitted energy which strikes the target is reflected to the antenna and coupled through the duplexer to the receiving circuit.

In the receiver, a McNally klystron generates a continuous-wave signal which differs from the magnetron frequency by 30 megacycles. This signal is heterodyned with the received signal in a crystal mixer. The resultant 30-megacycle beat frequency is coupled to a preamplifier located near the mixer, and then to the signal intermediate-frequency amplifier. The preamplifier is also coupled to the automatic-frequency-control circuits which maintain a constant difference of 30 megacycles between the klystron and

magnetron frequencies regardless of frequency drift in the magnetron or klystron. After detection, the video-frequency signal is applied to the intensity grid of the cathode-ray tube of each search indicator.

The search central of each search-indicator assembly generates the sweep voltages, range marks, and intensification gate applied to the indicator tube. These voltages are initiated by a negative trigger voltage from the synchronizer. The voltages from a sine-wave voltage divider, which is mechanically coupled to the search-antenna drive, are mixed with the sweep voltages and the resultant voltage applied to the indicators. A single radial sweep is thus initiated each time the transmitter fires. A direct voltage is applied to the sine-wave voltage divider, and as the antenna scans, the divider output consists of two voltages, which are functions of the search-antenna position and are 90 degrees out of phase with each other. The angular data are thus transmitted electrically to the search indicators.

### 2.1.1 Antennas

The antenna is mounted on a motor-driven assembly installed in the roof of the trailer. This drive rotates the antenna at 30 revolutions per minute, so that it scans 360 degrees every 2 seconds. Energy is coupled to the antenna through a rotating coaxial joint. The antenna consists of a vertical array of 10-centimeter dipoles coupled to a  $1\frac{1}{2}$ - by 3-inch wave guide, and mounted along the focal line of an 8- by 4-foot reflector of parabolic cross section. The dipoles are spaced and energized so as to produce a vertical radiation pattern having sharp cutoff below the horizon and a cosecant-squared characteristic above the horizon. When the antenna is adjusted so that the nose of the vertical beam just clears the horizon, an area within a range of 30 miles and up to an altitude of 4000 feet can be scanned. The horizontal cross section of the beam generated by the reflector is symmetrical and less than 7 degrees wide at its half-power points.

Fig. 4—On the opposite page is a view of an airport and environs showing the relative position of the ground-controlled-approach equipment and the sky coverage provided by the search and precision systems.

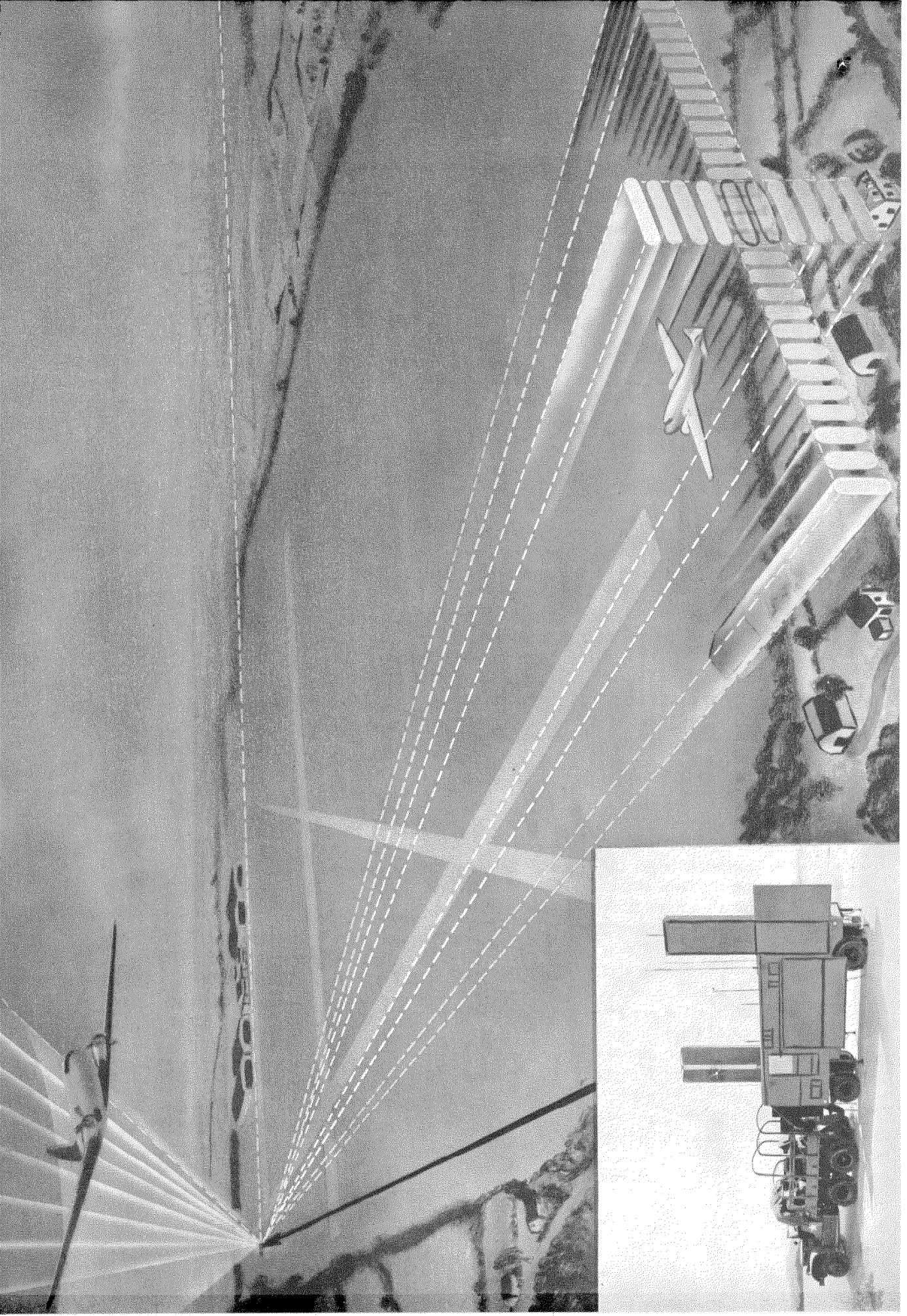

The merit of the cosecant-squared pattern is that there is no gap in coverage at higher altitudes and close range. All targets, regardless of range, are thus scanned more uniformly than

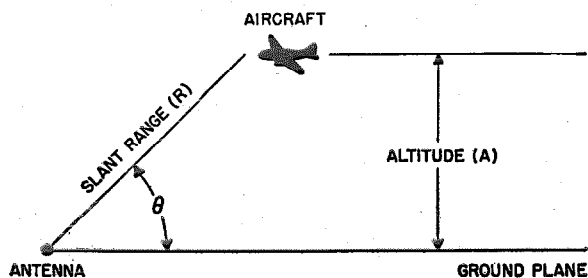

Fig. 5—The slant range of an aircraft flying at a constant altitude is equal to  $A \operatorname{cosec} \theta$ .

they would be by a pencil beam. Another advantage of the pattern is the sharp cutoff at the horizontal which reduces ground clutter and permanent echoes.

The cosecant-squared characteristic of the antenna distinguishes it from other types of antennas generally used with air-search radars. Most such equipments are designed to give early warning, and therefore use antennas whose sharp pencil-shaped beam patterns are directed near the horizon. Good echoes are thus received from targets at low altitude and considerable range, but not from targets at high altitude and close range. To overcome the danger of losing aircraft orbiting close to the airfield at an altitude of 4000 to 5000 feet, the cosecant-squared pattern has been made a characteristic of the present antenna.

As shown in Fig. 5, when the slant range  $R$  of the aircraft is large, the angle of elevation  $\theta$  is very nearly zero. However, if the altitude  $A$  of the aircraft approaching the radar remains constant, angle  $\theta$  increases to an appreciable value. The slant range  $R$  is equal to  $A/\sin \theta$  or, since the cosecant of an angle is equal to the reciprocal of its sine, to  $A \operatorname{cosec} \theta$ . As  $\theta$  becomes large, i.e., greater than 1 degree, the transmitted power is propagated through free space, and the received power becomes directly proportional to the square of the gain  $G$  of the antenna, but inversely proportional to the fourth power of  $R$ . If a constant  $C$  is used to represent the other factors involved, the echo power  $P_r$  becomes

$$P_r = C \frac{G^2}{R^4}$$

therefore

$$G = R^2 \sqrt{\frac{P_r}{C}}$$

As  $R = A \operatorname{cosec} \theta$ ,

$$G = A^2 \operatorname{cosec}^2 \theta \sqrt{\frac{R}{C}}$$

As it has been assumed that the aircraft is approaching at a constant altitude and that an echo of uniform amplitude is required, it is convenient to consider  $A^2 \sqrt{P_r/C}$  as a constant  $K$ . Therefore,  $G = K \operatorname{cosec}^2 \theta$ . Thus to receive an echo of uniform amplitude from an aircraft approaching at a constant altitude, irrespective of its range, it is necessary to use an antenna whose gain in the vertical plane is proportional to the square of the cosecant of the angle of elevation. This function is obtained in the search-radar antenna by adjusting the spacing between the dipoles and the amount of power coupled to each dipole.

## 2.2 PRECISION RADAR

The precision radar operates in the 3-centimeter band at a repetition rate of 2000 cycles per second. The 15- to 20-kilowatt, 0.5-microsecond radio-frequency pulse transmitted by the magnetron, with a duty cycle of 1/1000, through the duplexer to the antenna system is generated in the same way as in the search radar. The precision radar, however, employs two antennas; one comprising an azimuth-scanning array and the other an elevation-scanning array.

Energy from the transmitter-converter is fed alternately to each antenna for approximately 0.125 second. This is accomplished by the radio-frequency switch, which consists of a waveguide Tee whose branch arms are alternately shorted. Shorting is accomplished by semicircular metallic blades inserted alternately between two pairs of choke flanges which are separated by an air gap. The blades are mechanically coupled by a shaft. Radio-frequency energy is transmitted across each gap without loss when a blade is removed. The length from the center of the Tee to each pair of choke joints is adjusted so that when a blade is inserted all the energy is fed to the open arm. Associated with this switch is a commutator which unblanks the indicator connected to the energized antenna.

### 2.2.1 Antennas

The precision antennas must scan rapidly because of the high speeds at which modern aircraft land. Antennas of the early equipments were designed for mechanical scanning but their mass was found to be too great. In Radio Set AN/MPN-1C, electrical scanning at two speeds of 1 and 4 scans per second is used. The dipole arrays of the precision antennas are coupled to wave-guide sections so that the axis of each array is along the line of focus of a semiparabolic reflector. This produces a very narrow beam in the plane parallel to the axis of the array (as determined by the length of the antenna). In the axis normal to the array, the beam width is determined by the width of the reflector.

The azimuth antenna, which is mounted in the trailer so that the axis of its array is in the horizontal plane, radiates a horizontally polarized beam whose half-power width is 1 degree in azimuth and 2 degrees in elevation.

The elevation antenna, which is mounted in the trailer so that the axis of its array is in the vertical plane, radiates a vertically polarized beam 0.6 degree wide in elevation and 3.6 degrees wide in azimuth at the half-power points. Fig. 6 shows the installation of the antennas in the trailer.

When electrical energy is propagated through a wave guide at a given frequency, the velocity and wavelength of the energy in the guide are functions of the physical dimensions of the guide. If the frequency is kept constant and the dimensions of the wave guide are changed, the guide wavelength  $\lambda_g$  is changed in direct proportion to the dimensions, as expressed

by

$$\lambda_g = \frac{\lambda}{\sqrt{1 - \lambda^2 \left[ \left( \frac{m}{a} \right)^2 + \left( \frac{n}{b} \right)^2 \right]}}$$

where  $a$  and  $b$  are the depth and width, respectively, of the wave guide, and  $m$  and  $n$  are subscripts denoting the particular mode of propagation. The scanning technique employed by the precision antennas is based on this formula.

Each precision antenna comprises an array of dipoles spaced at fixed distances and coupled to a length of wave guide whose dimensions can be easily changed to vary the phase of the energy exciting each dipole. The angular position of the beam of each precision antenna is thus shifted with respect to the axis of its array by changing the wave-guide dimension. A cam drive coupled to the radio-frequency switch mechanically increases and decreases the broad dimension of the wave guide. The sector which is scanned by the beam of each precision antenna is therefore a function of the motion of the cam drive. The scanning mechanisms are constructed so that the horizontally polarized beam of the

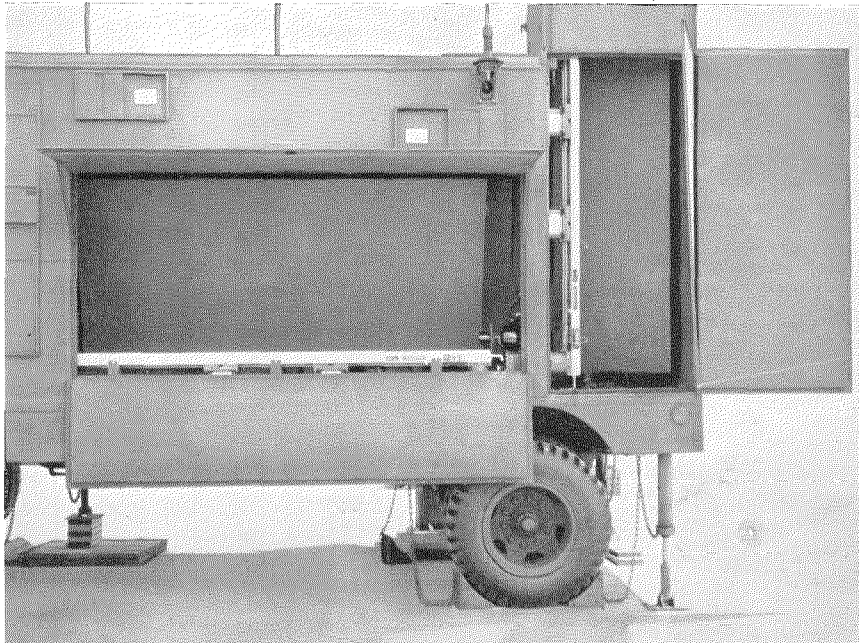

Fig. 6—Precision antennas mounted in the trailer. The azimuth antenna (horizontal) and elevation antenna (vertical) are shown in their compartments.



azimuth antenna and the vertically polarized beam of the elevation antenna sweep alternately. While one beam sweeps the other is unenergized.

During a complete cycle, the scanning sequence is as follows; the azimuth antenna scans from 5 degrees to the right to 15 degrees to the left of the runway; the elevation antenna then scans from 1 degree below to 6 degrees above the horizon; the azimuth antenna scans back from 15 degrees to the left to 5 degrees to the right of the runway; and the elevation antenna completes the cycle by scanning back from 6 degrees above to 1 degree below the horizon.

To obtain reasonable gain from the arrays, the associated reflectors must be quite large. This reduces the beam width of each array along the nonscanning axis. To prevent loss of signal when the aircraft deviates appreciably from course (that is when it is flying in a weak part of the antenna beam), the antenna-directing pedal

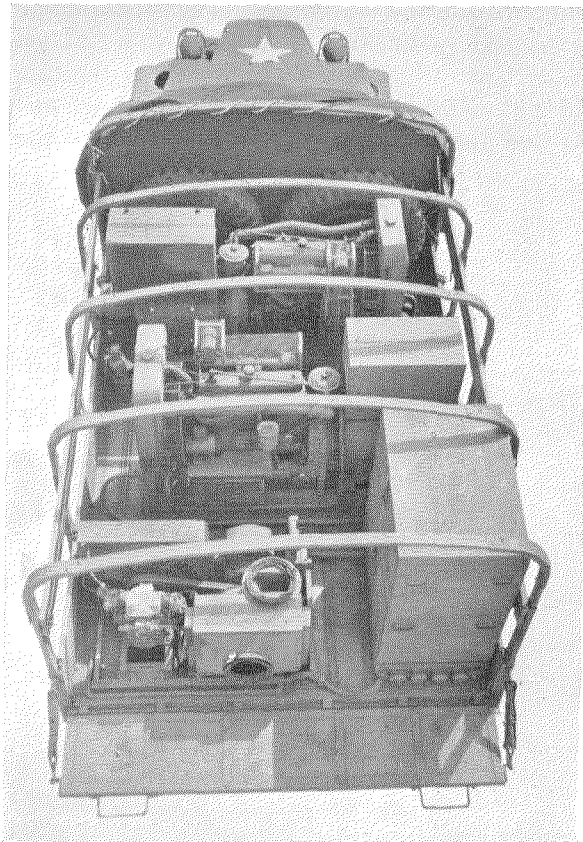

Fig. 7—A view of the prime mover showing the installation of the engine-generator sets and the air-conditioning equipment.

system is provided to rotate the elevation scanner in azimuth and azimuth scanner in elevation.

As in the search radar, the received signals from targets in the area scanned by the precision antennas are fed from the antennas to the receiver through the duplexer. As the precision radar operates in the 3-centimeter band, a Sheppard-Pierce klystron serves as a local oscillator instead of the McNally tube used with the 10-centimeter search radar. The receiver of the precision radar is identical with that of the search radar. The receiver is provided with a sensitivity-time-control circuit, which is triggered by the synchronizer, and varies the sensitivity of the intermediate-frequency as the fourth power of the time following each pulse (corresponding to the fourth power of range). The effect is uniform signal amplitude from targets of the same size and aspect, regardless of the target range. The sensitivity-time-control circuit is not used in the search receiver. The receiver video-frequency output is fed to the synchronizer, where an amplifier and cathode-follower couple the signals to the precision indicators.

Horizontal and vertical electromagnetic deflection coils are mounted on the neck of each indicator tube. A single sweep-generator-amplifier is used to drive both cathode-ray tubes of each indicator. Trigger voltages are supplied by the synchronizer, and antenna-position data are supplied to each indicator by an angle-coupling unit which delivers a direct voltage, the amplitude of which is a function of the position of the antenna beam. This voltage modulates the amplitude of the sweep currents in the deflection coils, and thus transmits the instantaneous position of the antenna beam to the indicator map.

The elevation and azimuth antennas are each equipped with an angle-coupling unit. This arrangement is duplicated for the stand-by channel. The angle-coupling units compensate for the nonlinear scanning mechanisms of the antennas. Each unit consists of a capacitive dividing network, mechanically coupled to its respective scanning mechanism and electrically fed from a 1-megacycle oscillator.

As the precision antennas operate alternately and the same receiver feeds both azimuth and

elevation indicators, the indicator which is not receiving data must be blanked until the associated antenna is used. This is accomplished by a phototube blanking commutator which is mechanically coupled to the antenna-scan drive. Thus when the elevation antenna is energized, the elevation indicator is unblanked, and when the energy is switched to the azimuth antenna, the azimuth indicator is unblanked. The rapid scan rate makes it difficult to use a mechanical switch for unblanking the indicators. Instead, a phototube light-beam switch is used. Two blanker switch blades coupled to the radio-frequency switch in the antenna drive are used alternately to interrupt a light beam and thus unblank the appropriate indicator.

The gain of the elevation antenna differs from that of the azimuth antenna, and since the same transmitter-receiver is used with both antennas, it is necessary to control the system gain for each part of the cycle independently. A gain control on each indicator is connected to the receiver for this purpose by the phototube switching unit when an indicator is unblanked. The 2500-foot and 2-mile range marks applied to the indicators are generated in the synchronizer.

The error voltages which are applied to the meters of the approach indicator are obtained from nonlinear voltage dividers which are mechanically coupled to the tracking cursors on the precision indicators. In aligning the system for operation, adjustments are made so that the error meter will read zero when the cursor is set by the handwheel on the proper glide path.

### **3. Mechanical and Power Supplies**

All electronic equipment is mounted in and on a trailer with a total weight of about 21 000 pounds. In setting up for operation, hydraulic jacks are used for leveling. The trailer is 237 inches long, 98 inches wide, and 125 inches high. It is hauled by a prime mover which carries two engine-driven generators and air-conditioning equipment. (See Fig. 7.) The loaded tractor weighs approximately 24 000 pounds and is 268 inches long, 96 inches wide, and 128 inches high. On the road, the coupled vehicles will turn in a radius of less than 37 feet.

The engine-driven generators supply 117/220 volts at 60 cycles. Two 9-kilovolt-ampere generators operating at power factors between 0.73 and 0.85 deliver a maximum of 13.5 kilowatts.

# Frequency-Modulated Broadcast Transmitters for 88-108 Megacycles

By LEONARD EVERETT

*Federal Telephone and Radio Corporation, Newark, New Jersey*

**D**ESIGNATION of the frequency band from 88 to 108 megacycles per second for frequency-modulated broadcasting in the U.S.A., required the design of completely new transmitting equipment. Transmitters of 1, 3, 10, 20, and 50 kilowatts output are based on the "Frequematic" modulator which provides for wide frequency swings for modulation but prevents drifting from the assigned center frequency. Use of multiple square-loop antennas permits radiation in the vertical plane to be concentrated at the horizon while maintaining a circular azimuthal pattern.

Frequency-modulated broadcast transmitters have been designed for output powers of 1, 3, 10, 20, and 50 kilowatts. A still wider range of effective radiation results from the use of multiple square-loop antennas<sup>1</sup> having useful power gains up to 12 times that of a simple dipole antenna. The power gain at the horizon over the field produced by a dipole is approximately equal to the number of square loops stacked vertically. The use of 12 loops, giving a power gain of 12, is practicable. Thus, it is possible to select the most economical transmitter and antenna

<sup>1</sup> R. F. Lewis, "Square Loops for Frequency-Modulated Broadcasting at 88-108 megacycles," *Electrical Communication*, v. 23, pp. 415-425; December, 1946.

combination to meet conditions for any particular installation.

The performance of a frequency-modulated transmitter is dependent to a very large extent on the type of modulator and center-frequency-stabilization system employed. Use of the all-electronic Frequematic modulator and center-frequency-stabilization system permits these

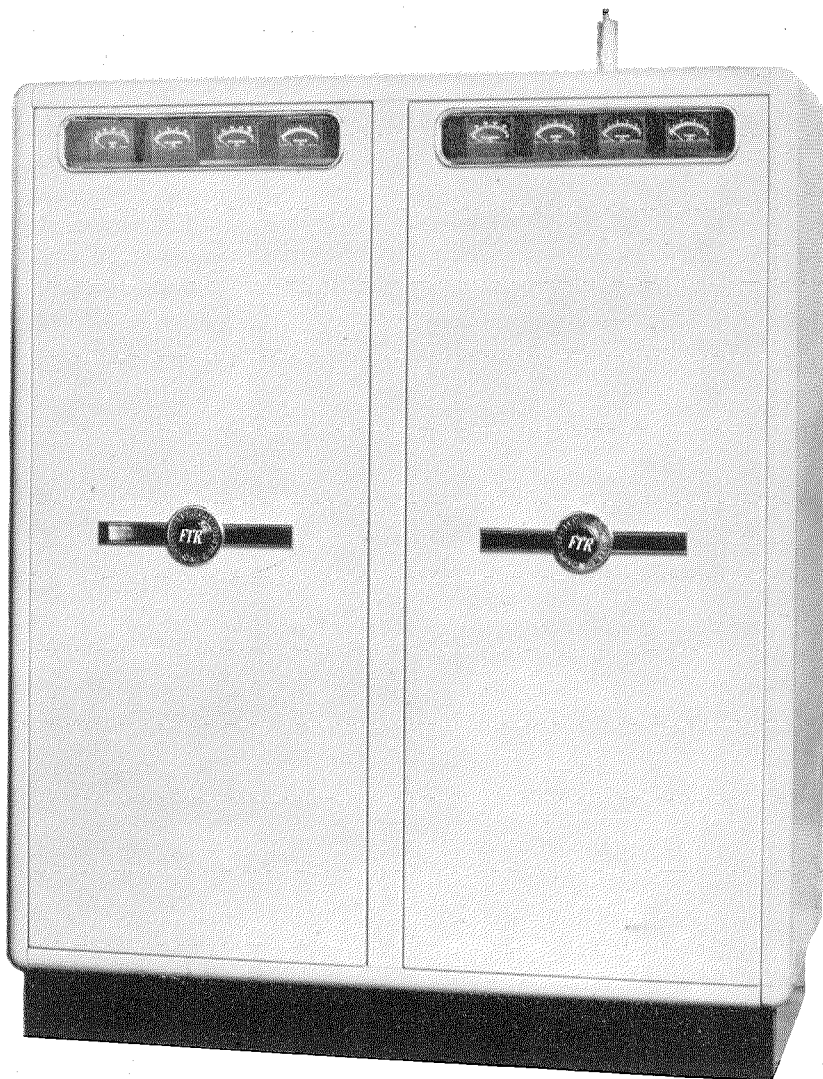

3-kilowatt frequency-modulated transmitter, front view, doors closed.

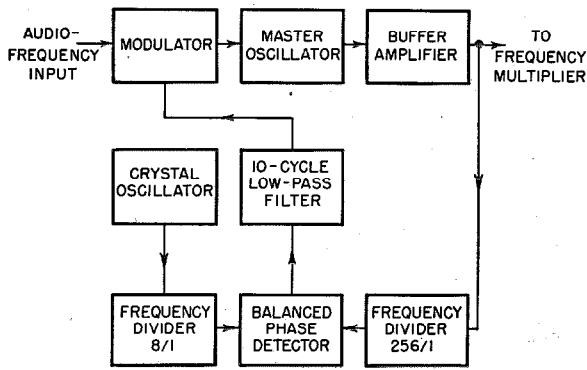

Fig. 1—Block diagram of Frequematic modulator and center-frequency-stabilization system.

distortion, including harmonics up to 30 kilocycles, is less than 1.5 percent of the root-mean-square values for fundamental frequencies between 50 and 15 000 cycles; and below 1.0 percent for fundamental frequencies between 100 and 7500 cycles.

The frequency- and amplitude-modulated noise present in the transmitted signal, measured under normal operating conditions, are at least 65 and 50 decibels, respectively, below full carrier modulation.

2. Modulator

Fig. 1. shows a block diagram of the Frequematic modulator and center-frequency-stabilization system. The audio-frequency input signal is applied to a modulator tube which, by means of the well-known Miller effect, produces a capacitive variation across the tank of a master oscillator, these variations being proportional to the applied audio-frequency signal. Fig. 2 is a schematic illustration of this circuit, from which it may be seen that the audio-frequency signal is applied to the grid of the modulator tube. The signal produces a variation in the transconductance of the tube with a resultant variation in its input capacitance. By proper selection of tube type and circuit components, the variation in input capacitance is made proportional to the amplitude of the applied signal. From Fig. 2 it may be seen that the grid of the modulator tube is coupled through a capacitor  $C_c$  to the tank circuit of a Hartley oscillator. Capacitor  $C_{gp}$ ,

transmitters to operate well within the standards set by the Federal Communications Commission for frequency-modulated broadcasting in the U.S.A.

1. Electrical Characteristics

The center-frequency-stabilization system associated with the Frequematic modulator literally locks the center frequency in synchronism with the frequency of a temperature-controlled quartz crystal. This piezoelectric oscillator is maintained at a frequency within 0.001 percent of its required value, resulting in the transmitter center frequency being held to within  $\pm 1000$  cycles.

In accordance with standards of the Radio Manufacturers Association, the normal program input level to the transmitter is approximately 0 volume units for full modulation. A 75-microsecond pre-emphasis circuit is provided at the audio-frequency input. Use of this circuit is optional and it can be readily disconnected if pre-emphasis is provided ahead of a limiting amplifier, or if it is desired to check the response-frequency characteristics of the transmitter. The response-frequency characteristics of the transmitter follow the standard 75-microsecond pre-emphasis curve to within 1 decibel between 50 and 15 000 cycles. The

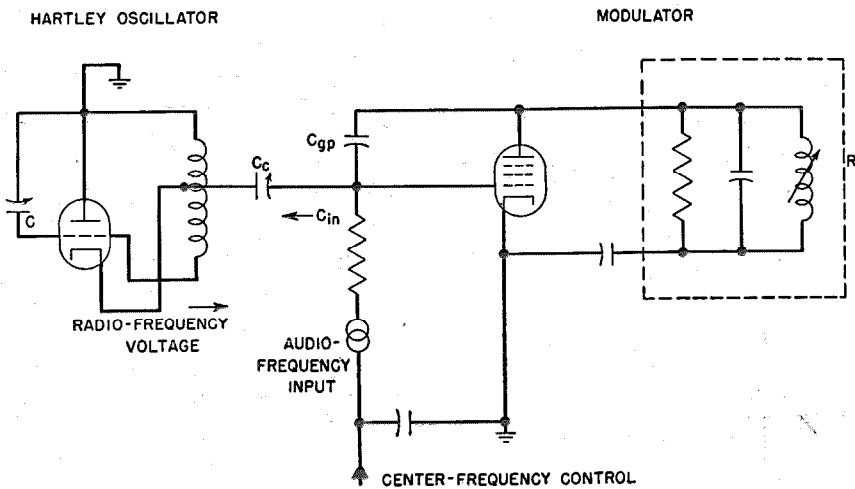

Fig. 2—Basic circuit of modulator.

which is connected between the grid and plate, serves to add to the interelectrode capacitance and to magnify the Miller effect produced in the tube.

To function properly, the modulator plate circuit must be tuned to the resonant frequency of the oscillator, because only under the conditions of resonance will a purely capacitive impedance be reflected onto the grid of the tube. If the plate circuit is detuned, the impedance reflected onto the grid becomes partly resistive, resulting in the introduction of amplitude modulation. For this reason, the modulator plate tank circuit has been given a relatively low  $Q$ , making its tuning broad and thus preventing any appreciable detuning effect as a result of the shift in frequency of the oscillator with modulation. Use of the low- $Q$  circuit also makes the

tuning noncritical and greatly facilitates adjustment of this stage.

The oscillator stage is of the conventional Hartley type, but with a grounded plate and the cathode tapped across the tank inductance. The tank circuit is temperature compensated to reduce frequency drift to a minimum. A variable powdered-iron core in the tank inductance permits frequency adjustment between 3.4 and 4.7 megacycles. The output of the oscillator is fed through a buffer amplifier stage to the frequency-multiplying stages of the transmitter, where a multiplication of 24 times produces the required transmitter output frequency.

### 3. Center-Frequency Stabilization

From the block diagram of Fig. 1, it will be seen that a portion of the buffer-stage output is applied to a frequency-dividing network. This consists of a series of multi-vibrators which reduce the frequency by a factor of 256 and produce an output in the neighborhood of 15 kilocycles. This output is applied to a balanced phase detector.

The output of a crystal-controlled oscillator, after being divided in a similar network by a factor of 8, is also applied to the balanced phase detector. The frequency of the crystal oscillator is such that, when the master oscillator is operating at its proper frequency, the two voltages applied to the phase detector will be of the same frequency. This is accomplished by employing a crystal having  $1/768$  and a master oscillator of  $1/24$  of the transmitter output frequency.

Fig. 3 shows the basic circuit of the balanced phase detector. The output of this circuit is ap-

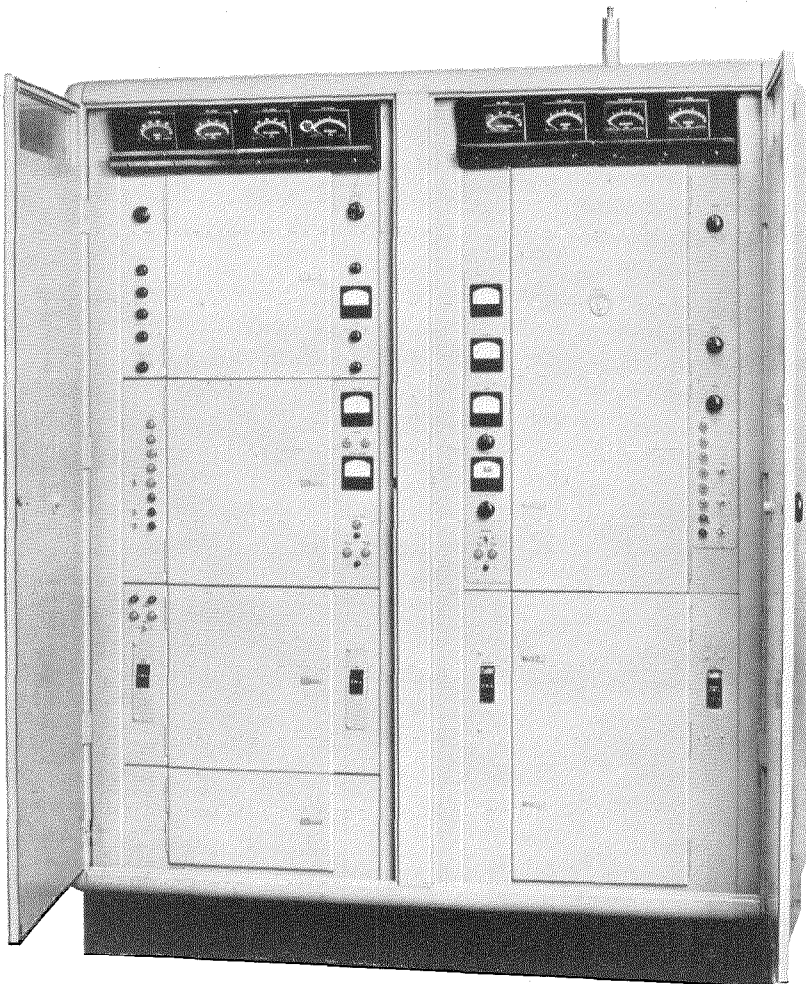

3-kilowatt frequency-modulated transmitter, front view, outer doors open.

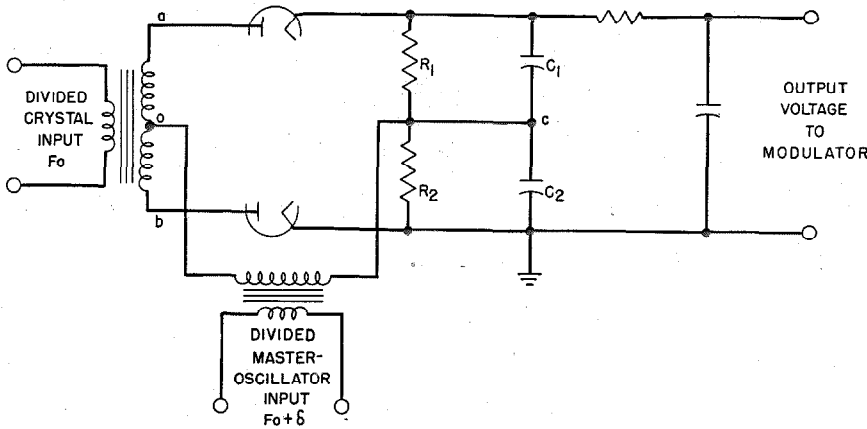

Fig. 3—Basic circuit of balanced phase detector.

plied to the grid of the modulator tube in series with the audio-frequency input signal. Under normal operating conditions, the two voltages applied to the phase detector are identical in frequency and differ only in relative phase. For purposes of explanation, assume that this condition exists. The two voltages will then add vectorially, producing a resultant voltage which is rectified and applied to the modulator tube.

The amplitude and polarity of the voltage applied to the modulator tube will depend on the relative phase of the two voltages as shown by the curve of Fig. 4. From this curve it will be seen that, when the two voltages have a phase relationship of  $\pi/2$  radians, or 90 degrees, the resultant output voltage is zero. Other phase relationships will cause a positive or negative correcting voltage to be applied to the grid of the modulator tube. The application of a correcting voltage to the grid of the modulator tube causes a change in the amount of capacitance injected across the tuned circuit of the master oscillator. The correcting voltage acts on the modulator in the same manner as the applied audio-frequency input voltage, except that the correcting voltage, being a direct voltage, tends to change the frequency in one direction only. As in the case of the audio-frequency input voltage, the capacitive change in the oscillator tank is proportional to the amplitude of the correcting voltage.

The arrangement of the circuit is such that the application of a correcting voltage to the modulator will tend to change the tuning of the oscillator in a direction which reduces the amplitude of the correcting voltage. When the

master oscillator is operating at its proper frequency, the voltages applied to the phase detector will be of the same frequency, and will have a definite phase relationship. Any attempt of the master oscillator to drift will produce a change in the phase of the voltages applied to the phase detector, and a resultant change in the capacitance injected into the tank circuit of the master

oscillator. This corrects the tendency to drift and maintains the master oscillator at its original frequency. As a result of this action, the output voltage of the master oscillator can do no more than change very slightly in phase with respect to the crystal oscillator. Thus the frequency of the

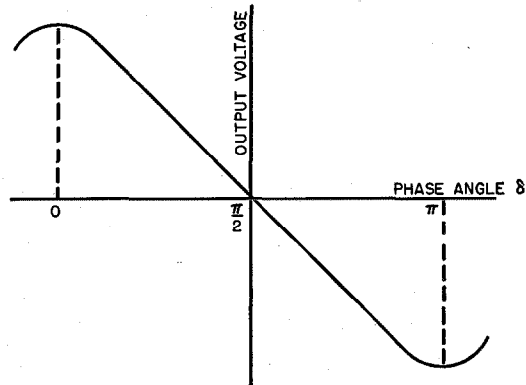

Fig. 4—Response curve of phase detector.

master oscillator must remain constant and is effectively locked in synchronism with the frequency of the crystal oscillator.

When the transmitter is modulated, instantaneous phase variations are produced in the output of the master oscillator, and these variations are applied through the buffer amplifier and frequency-dividing network to the phase detector. The action of the dividing network is such as to reduce the angle of phase variation by  $1/256$ ; consequently, only a relatively small phase change is present at the phase detector. From a mathematical analysis, it can be readily shown that the maximum phase variation at the

detector for full modulation is approximately 0.4 radian or 24 degrees.

Under normal operating conditions, the voltages applied to the phase detector have an average phase relationship of approximately 90 degrees, and the detector operates at very near the center of the response curve shown in Fig. 4. The phase variations produced by modulation cause the operating point to be shifted along the response curve, producing corresponding variations in the output voltage of the detector. If these variations were applied to the modulator, they would tend to counteract efforts to modulate the transmitter. In other words, the control system would not only maintain a constant center frequency, but would also try to oppose the desired change in frequency resulting from modulation. To avoid this effect, the output of the phase detector is taken through a 10-cycle low-pass filter, which suppresses all variations except the slow mean changes produced by frequency drift.

In the above description, it was shown that the master oscillator will remain locked in synchronism with the crystal oscillator once it has been brought to its correct frequency. These conditions are fulfilled in normal operation. However, when the transmitter is first turned on, the master oscillator will be out of synchronism with the crystal oscillator. Under these conditions the voltages applied to the phase detector will differ in frequency and have a varying phase relationship. This results in a beat frequency being produced in the output of the phase detector, the beat equaling the difference in frequency of the two applied voltages. This

beat-frequency voltage is applied to the modulator producing frequency modulation of the master oscillator, which in turn causes the instantaneous frequency of the master oscillator to be deviated at a rate equal to the beat fre-

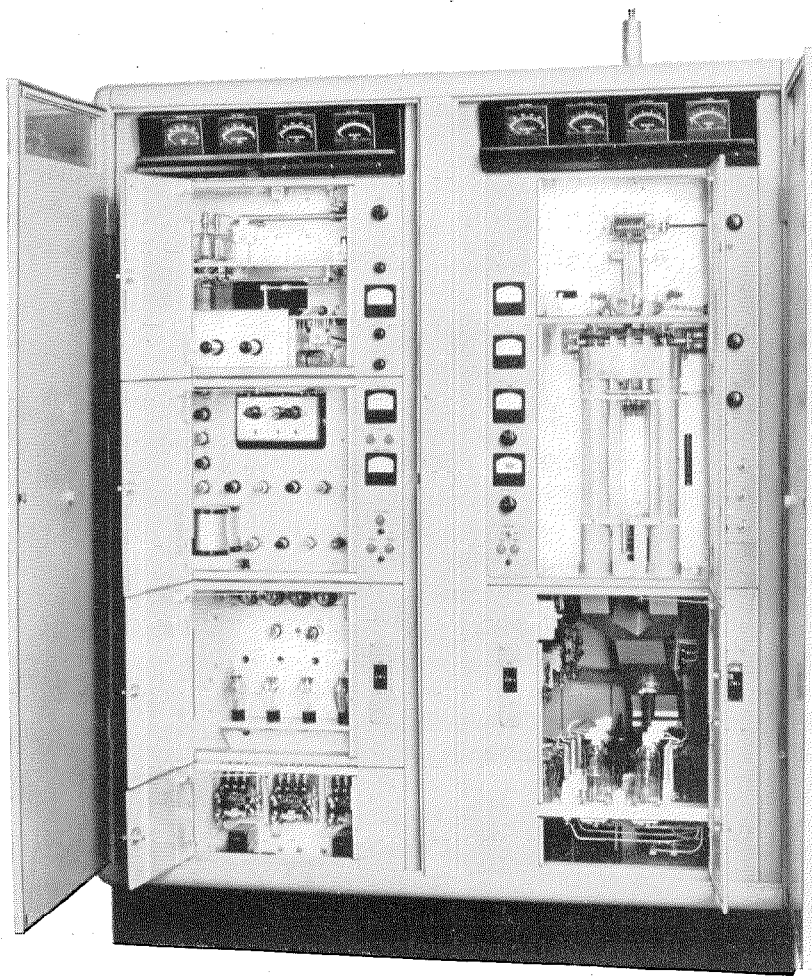

3-kilowatt frequency-modulated transmitter, front view, access doors open.

quency, and to an extent proportional to the amplitude of the beat. As a result of this action, the frequency of the master oscillator at some instant will pass through its correct frequency. As soon as this occurs, the master oscillator locks into synchronism with the crystal oscillator and the beat frequency disappears. Thereafter, the system operates in the synchronized condition. This lock-in action occurs so rapidly that, when the transmitter is turned on, the master oscillator reaches a synchronized condition

before the final stages are operative. Thus, the frequency modulation produced by the beat frequency cannot be transmitted.

The frequency of the master oscillator being divided by 256, the beat frequency produced in the phase detector under nonsynchronous conditions, is also effectively reduced by the same ratio. Thus the frequency of the master oscillator can drift as much as 2560 cycles before the beat-note frequency becomes greater than 10 cycles and is suppressed by the 10-cycle low-pass filter. This corresponds to an output-frequency drift greater than 61 kilocycles. Temperature compensation of the tuned circuits in the master oscillator prevents its frequency from drifting outside the region of control.

The number of tuning controls has been kept to a minimum. In the frequency-dividing network, only two of the multivibrator stages are adjustable, the balance of the multivibrator stages requiring no adjustment for operation over the complete range from 88 to 108 megacycles. The number of tuning controls is further reduced by employing a crystal-oscillator circuit of the untuned type. When setting up the modulator for operation, it is merely necessary to insert a crystal of the correct frequency, adjust the two multivibrator stages, and tune three radio-frequency circuits. These circuits are the master-oscillator tank circuit, the modulator plate load circuit, and the buffer-amplifier tank circuit.

A zero-center meter connected to the output of the phase detector indicates the amplitude and polarity of the correcting voltage being applied to the modulator. This meter serves as a carrier-to-crystal phase-comparison meter and tells the operator at a glance whether or not the master-oscillator tank circuit is correctly tuned.

Standard receiving-type vacuum tubes are employed throughout the modulator and center-frequency-stabilization system. To insure extremely stable and noise-free operation, the filaments of all tubes are operated from direct current, and plate voltages are obtained from a highly regulated power supply.

#### **4. 1- and 3-Kilowatt Transmitters**

The 1- and 3-kilowatt transmitters are very similar, the only difference being in their power-

supply circuits. The 1-kilowatt transmitter operates from a 230-volt, single-phase supply, while the 3-kilowatt transmitter obtains power from a 230-volt three-phase supply. Also, the high-voltage rectifier employed in the 3-kilowatt transmitter is of larger capacity than that in the 1-kilowatt transmitter and supplies a higher potential to the plate of the final power-amplifier stage. All radio-frequency circuits of the two transmitters are identical, even to the extent of employing the same vacuum tubes.

The accompanying photographs clearly show the unit type of construction employed in all the transmitters. The 1-kilowatt and 3-kilowatt transmitters each consist of two separate units, one being the modulator-exciter unit and the other the power-amplifier unit. The two units are bolted together and, by the addition of side panels, a top, doors, and decorative trim, give the appearance of being housed in a single cabinet.

The operating front of the transmitter proper is enclosed by full-length doors, windows in these doors permitting observation of the principal meters which are located along the top of the transmitter. To provide greatest visibility, the meters have fluorescent scales and pointers and are illuminated with ultraviolet light.

On the left-hand side of the 3-kilowatt unit is the modulator-exciter, and on the right is the power-amplifier unit. The modulator-exciter unit is made up of four vertically mounted chassis. From top to bottom these are: frequency-multiplier and intermediate-amplifier chassis, Frequematic modulator chassis, low-voltage power-supply chassis, and control and contactor chassis. The power-amplifier unit consists of two vertically mounted chassis. The upper is the power-amplifier chassis, and the lower is the high-voltage power-supply chassis.

Access to front-mounted components is obtained through small inner doors on the front of the individual chassis. To protect operating personnel, each door giving access to high voltage is interlocked with the high-voltage power supplies. All vacuum tubes are readily accessible from the front of the transmitter. Doors at the rear of the cabinets provide access to components mounted on the rear of the vertical chassis.

Tuning controls, meters, switches, and supervisory lights are mounted on the panels along each side of the inner doors. This arrangement



permits the transmitter to be completely readjusted from the front. Ventilation and tube-cooling requirements are met by a system of blowers, ductwork, and air filters. In the modulator-exciter unit, the air is directed through a duct that runs up the right-hand side of the unit (as viewed from the rear of the transmitter), openings in one side of the duct providing a horizontal draft across the components. In the 1- and 3-kilowatt power-amplifier units, the air is conveyed through a Y-shaped duct to the transmission-line-type plate inductor and through it to the radiators of each power-amplifier tube. A small amount of air is directed to the base of the rectifier tubes. Air is discharged through louvers at the upper rear and top portion of each assembly. To reduce vibration, the blowers are supported on shock-mounted cradles, and canvas couplings connect the blowers to the air filters and ducts.

The transmitter is normally controlled by a single master "On-Off" switch, sequencing and time-delay cycling being entirely automatic. Individual plate-, bias-, and control-voltage switches are provided, however, to facilitate maintenance and adjustment of the transmitter.

A set of supervisory lights on each unit of the transmitter indicates the condition of the circuits in that unit. These lights are arranged in the order of sequencing and cycling of the transmitter, thus permitting the location of a fault to be determined at a glance. Provision is made for the extension of all control switches and indicating lamps to a remote operating position. Audible warning of plate-current overload and of an excessive temperature condition is given by a buzzer within the equipment.

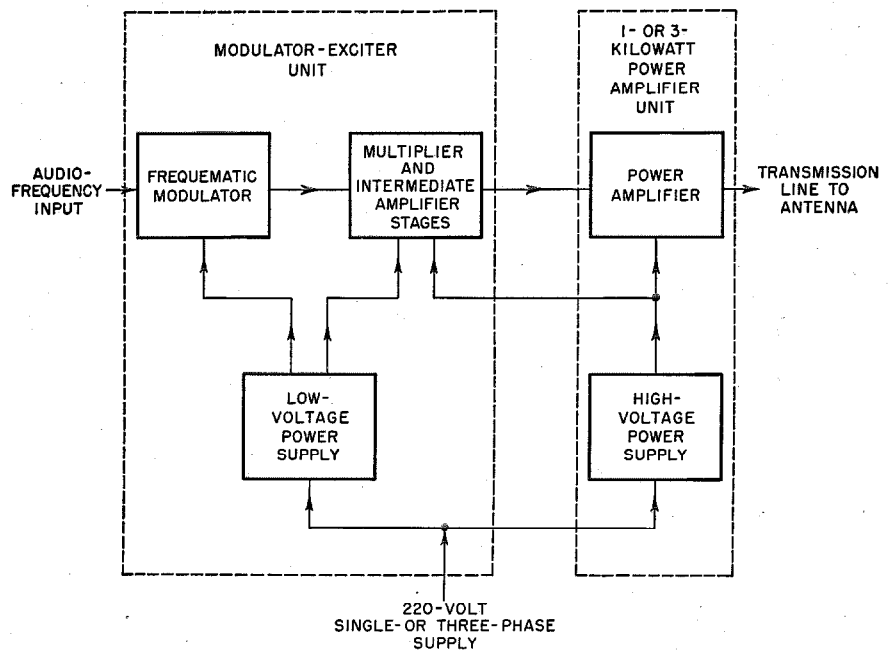

Fig. 5—Block diagram of 1- and 3-kilowatt frequency-modulated transmitters.

#### 4.1 MODULATOR

A block diagram of the 1- and 3-kilowatt transmitters is shown in Fig. 5. The audio-frequency input signal is applied directly to the Frequematic modulator. The output of the modulator consists of a frequency-modulated signal having a center frequency between 3.5 and 4.5 megacycles, the exact value depending on the required transmission frequency.

Two plug-in crystals, one operating and one spare, are mounted on the modulator chassis. Each crystal has its own oven and temperature-controlling circuit. The spare crystal may be substituted instantly for the operating one by the flick of a switch.

Filament supply for vacuum tubes in the modulator is obtained from a 12-volt selenium rectifier. Voltage for the plate and screen-grid circuits is provided by the regulated 250-volt output of the low-voltage direct-current power supply.

#### 4.2 FREQUENCY-MULTIPLYING STAGES

The frequency-multiplying section of the transmitter consists of three doubler stages and one tripler stage. The frequency of the master oscillator is thereby multiplied 24 times to pro-

duce the carrier output frequency. The modulating frequency deviation is also multiplied 24 times, thus the maximum frequency swing of the master oscillator, which is about  $\pm 3.1$  kilocycles is multiplied to  $\pm 75$  kilocycles, the figure stipulated by the Federal Communications Commission for full modulation.

The three doubler stages employ type 1614 vacuum tubes in essentially standard circuits. The tank circuits of the first and second doublers are loaded by means of resistors to lower the  $Q$  and to insure a wide pass-band for the transmission of modulation sidebands. Because of the higher frequency of its plate tank, this type of loading is not required in the third doubler.

The output of the third doubler is applied to the grid of a tripler stage which employs a type 815 dual beam power tube with the two sections

of the tube used as a push-pull class-C, radio-frequency amplifier. The plate tank circuit is at the output carrier frequency of 88 to 108 megacycles and consists of a variable capacitor and a transmission-line-type inductor, a movable shorting bar providing means of adjusting the effective length of the inductor.

Plate and screen voltage for the multiplying stages are obtained from the low-voltage power supply. The doubler stages have 250 volts on both plate and screen, while the tripler stage has 250 volts on its screen and 400 volts on its plate.

#### 4.3 BUFFER STAGE

The output of the tripler stage is capacitively coupled to the grids of a buffer stage, which also employs a type 815 dual beam power tube used as a push-pull class-C radio-frequency amplifier. The plate tank circuit is arranged in essentially the same manner as the tripler stage and employs a variable capacitor with a transmission-line-type inductor. Sufficient capacitance for neutralization is obtained by small studs mounted alongside the tube, adjacent to the plate leads, and cross-connected to the opposite grids. Plate and screen voltages are 400 and 250 volts, respectively, being obtained from the low-voltage power supply.

#### 4.4 THE 250-WATT AMPLIFIER STAGE

The 250-watt amplifier stage utilizes two Eimac type 4-250A tetrodes as a push-pull class-C radio-frequency amplifier. The plate and grid circuits of this stage are tuned by variable capacitors and transmission-line-type inductors, each inductor being equipped with a sliding shorting-bar for tuning. The grid inductor is

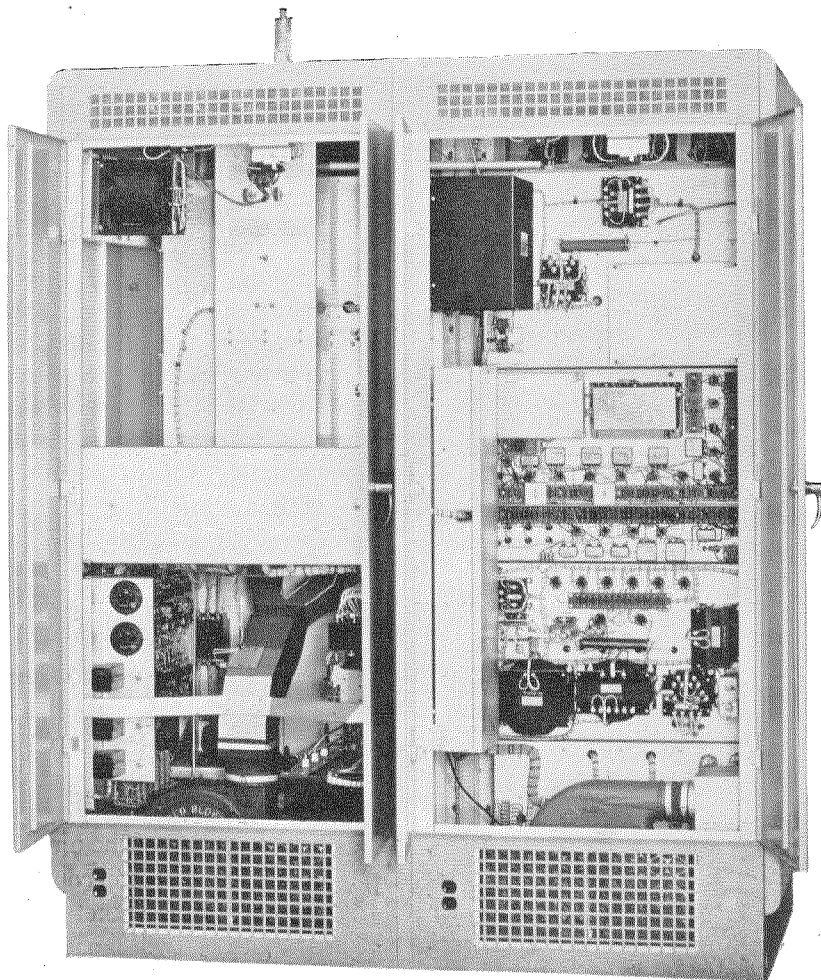

3-kilowatt frequency-modulated transmitter, rear view, doors open.

inductively coupled to the plate inductor of the buffer amplifier stage. An adjustable loop permits variable inductive coupling to the plate lines for transferring output power to the following stage.

"Neutralization" of this stage is accomplished by a balanced split-stator capacitor having one set of stator plates connected to the screen grid of each of the two tubes and the rotor connected to ground. By adjusting this capacitor, the inductance between the screens and ground is tuned to series resonance, thus minimizing the screen-to-ground impedance and increasing the effectiveness of the screen as a shield between grid and plate.

Plate voltage for this stage is obtained from the high-voltage power supply located in the associated 1- or 3-kilowatt power-amplifier unit; 400 volts for the screen grids is furnished by the low-voltage power supply.

#### 4.5 LOW-VOLTAGE POWER SUPPLY

The 250-volt and 400-volt direct-current requirements of the low-power stages are met by a single-phase full-wave rectifier employing four

type 866-A mercury-vapor rectifier tubes. The 400-volt supply is obtained from the output of the rectifier through a two-section filter. A 250-volt direct-current potential is obtained by taking the output of the rectifier through an electronic voltage-regulator circuit. This circuit employs six type 6L6G beam power tubes connected in parallel as series regulating tubes. The grids of these tubes are controlled by two stages of direct-current amplification. The output of the voltage-regulator circuit provides an extremely clean direct potential, the variations caused by power-supply ripple and line transients being reduced to as low as 1 to 2 millivolts.

#### 4.6 THE 1- AND 3-KILOWATT POWER AMPLIFIERS

As explained above, the 1- and 3-kilowatt transmitters employ identical power-amplifier stages. These stages employ two Federal type 7C26 vacuum tubes in a push-pull neutralized circuit. The tubes are rated at a maximum plate dissipation of 1 kilowatt each for frequencies up to 150 megacycles.

The output of the 250-watt amplifier is taken through a balanced transmission line to a variable coupling loop located in the power-amplifier stage. This loop transfers power to a transmission-line-type inductor, which, together with a variable capacitor, forms the grid tank circuit of the power amplifier.

The plate tank circuit also consists of a transmission-line-type inductor and a variable capacitor. A dual capacitor, which is part of the plate tank assembly, permits cross-neutralization of the amplifier. A variable loop couples

the amplifier to the output matching network. This network, which consists of two capacitors and a transmission-line-type inductor, has two functions. It transforms the single-ended 51-ohm

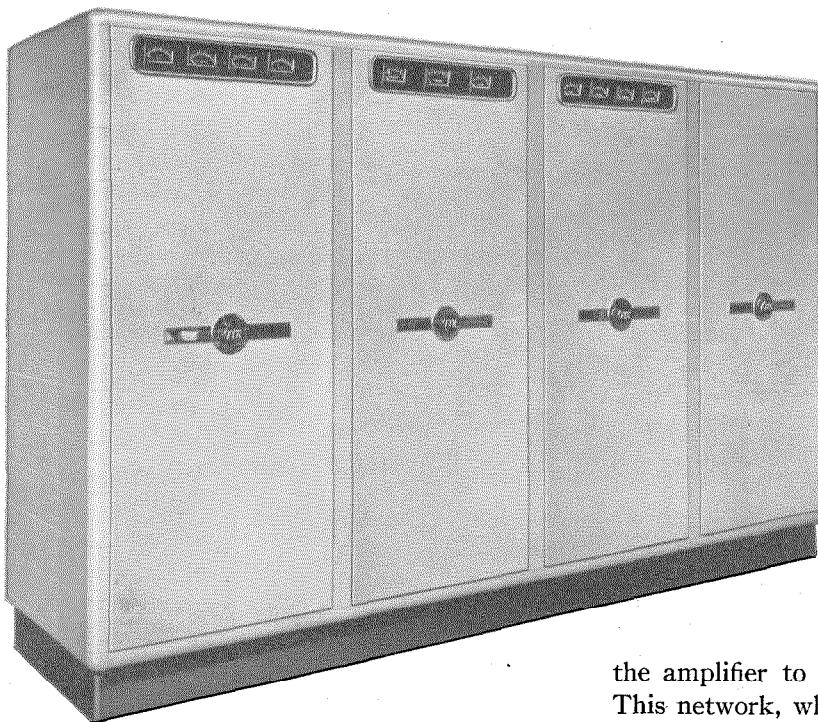

10-kilowatt frequency-modulated transmitter, front view, doors closed.

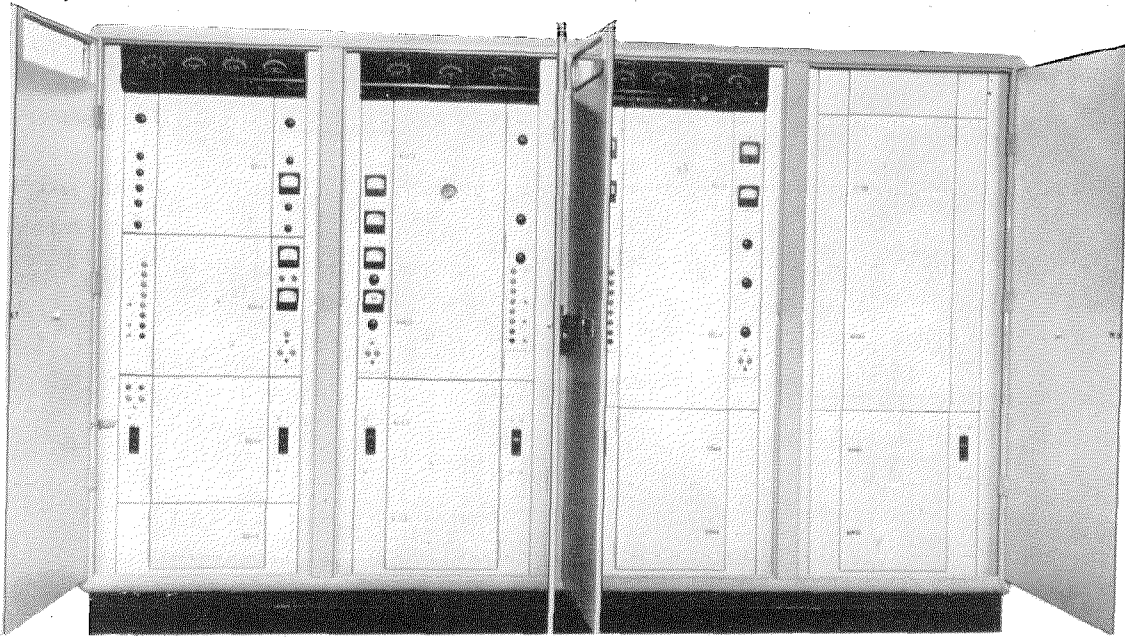

10-kilowatt frequency-modulated transmitter, front view, doors open.

impedance of the transmission line, including such variations as may appear with standing-wave ratios as high as 1.75:1, to a balanced impedance into which the coupling loop efficiently transfers the power output; and it adjusts the phase angle of the impedance presented to the transmitter output in such a manner that the plate tuning of the power amplifier is essentially independent of the degree to which the load is coupled to the transmitter. Two coupling loops are provided within the network, one to operate a thermocouple-type radio-frequency ammeter, and the other for a program monitor.

#### 4.7 HIGH-VOLTAGE POWER SUPPLY

The high-voltage power supply for the 1-kilowatt transmitter employs four type 866-A mercury-vapor rectifier tubes operating in two parallel branches as a full-wave rectifier. The primary power for the rectifier is obtained from a 230-volt single-phase source, and the rectifier develops an output of 2000 volts at approximately 1.0 ampere.

In the case of the 3-kilowatt transmitter, the high-voltage power supply employs six type 8008 mercury-vapor tubes operating in a full-wave three-phase circuit. The primary source of power is a 230-volt three-phase supply, and

the rectifier delivers 3000 volts at approximately 2 amperes.

A bias supply developing 150 volts at 300 milliamperes is also located on the high-voltage supply chassis. This supply provides fixed grid bias for the final amplifier stage. It employs two type 5R4GY tubes in a full-wave rectifier circuit.

#### 5. 10-Kilowatt Transmitter

The 10-kilowatt transmitter consists of the two units of the 3-kilowatt transmitter to which are added a 10-kilowatt power-amplifier and a 4-kilovolt power-supply. From the accompanying photographs, it can be seen that the general construction of the 10-kilowatt amplifier and its associated power-supply follows the same general lines as that of the 1- and 3-kilowatt transmitters.

Tuning controls, meters, switches, and supervisory lights for the 10-kilowatt amplifier are located on the operating front of the unit. As is the case of the lower-power transmitters, sequencing and cycling of the control circuits are entirely automatic, and operation is controlled by a single master "On-Off" switch. In addition, a special automatic overload reset mechanism is provided for the 4000-volt supply. This mechanism automatically resets the high-voltage-supply overload circuit a fraction of a second after

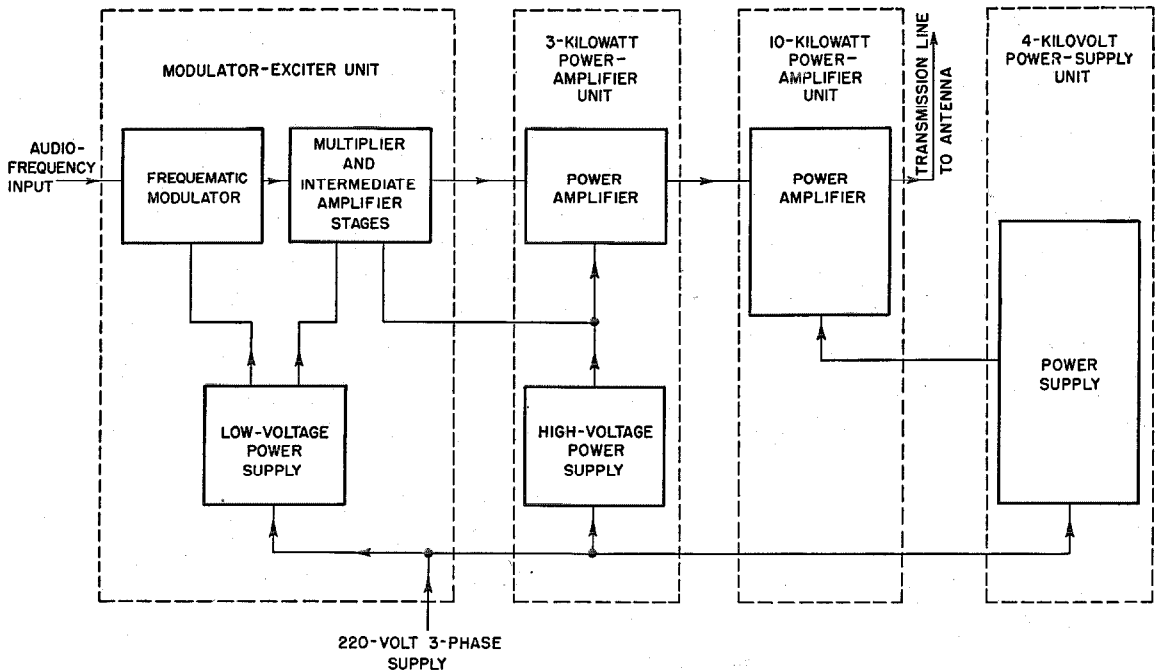

Fig. 6—Block diagram of 10-kilowatt frequency-modulated transmitter.

it has been tripped. The momentary opening of the high-voltage circuit is usually sufficient to break any temporary flashover, and normal operation can be resumed after a barely noticeable interruption. If the overload is persistent, the overload circuit will again be tripped and reset, this process being repeated three times. After that, if the overload is still present, the power-supply circuit remains open and an alarm buzzer is sounded.

A block diagram of this transmitter is shown in Fig. 6. The 3-kilowatt transmitter drives the 10-kilowatt amplifier. Under these conditions, the output matching network in the 3-kilowatt amplifier is not required, and the output coupling loop of the 3-kilowatt stage is connected through a balanced transmission line to the 10-kilowatt amplifier.

The 10-kilowatt power amplifier employs two Federal type 7C27 tubes in a push-pull grounded-grid circuit. Considerably greater driving power is required with the grounded-grid circuit than with a conventional grounded-filament circuit. However, the major portion of this power is added to that in the output circuit, thus increasing the power output of the amplifier.

The output of the 3-kilowatt amplifier is fed

through a coupling loop to the tuned filament circuit of the 10-kilowatt amplifier, which consists of a transmission-line-type inductor and a variable capacitor. The inductor is constructed of hollow tubing, and the filament leads pass through the center of this inductor.

The plate tank circuit is essentially the same as for the 3-kilowatt amplifier. However, the components are increased slightly in size to accommodate the larger tubes and the higher power dissipation.

The output of the amplifier is taken from a coupling loop and fed through a matching network and coaxial line to the antenna. The matching network is identical to that employed in the 3-kilowatt transmitter.

A low-voltage bias supply is located below the amplifier chassis. It employs two type 5R4GY tubes and supplies 200 volts of negative bias to the grids of the amplifier tubes.

Plate voltage for the amplifier is obtained from the 4-kilovolt rectifier located in the high-voltage power-supply unit. This rectifier employs six type 8008 mercury-vapor tubes in a three-phase full-wave circuit. The output current capabilities of this rectifier have been materially in-

creased by employing a circuit in which the plate voltage is applied in quadrature to the rectifier filament voltage. Use of this circuit has made it possible to employ relatively low-cost rectifier tubes resulting in an appreciable saving. The power-supply unit also houses the relays and contactors which form a part of the control and protective circuits.

A blower located on the floor of the amplifier unit supplies air for cooling components in both the amplifier and the power-supply units. The

air is drawn in through a filter located at the rear of the unit and flows through a Y-shaped duct to the plate tank of the amplifier. The air then flows through the tank inductor assembly to the plate cooling radiators of the amplifier tubes. Two smaller ducts branch off from the base of the Y to direct air into the power-supply unit. One of these ducts supplies air to the lower part of the unit for cooling the transformers, while the other carries air to the bases of the type 8008 rectifier tubes.

# Theory and Design of the Reflectometer

By B. PARZEN and A. YALOW

*Federal Telecommunication Laboratories, Inc., New York, New York*

**R**EFLECTION coefficient and standing-wave ratio are related quantities, each being a measure of impedance mismatch in a transmission system. A high reflection coefficient, caused either by mismatches or discontinuities in the line, will result in low power-transmission efficiency; an amount of power proportional to the degree of mismatch will be reflected back toward the generator and thus produce standing waves.

Simple, accurate devices are available for testing open-wire lines operating at low frequencies. The "reflectometer" has been designed for measurement of standing waves, reflection coefficient, and power transfer on coaxial lines operated at 1000 megacycles per second and below.

• • •

The reflectometer is inserted into a coaxial line at a desired location for measurement of reflection coefficient, standing-wave ratio, and power transfer in the line. The instrument consists of a short section of coaxial line containing a small loop coplanar with the inner conductor. The loop is connected through a resistor to the outer conductor, and this resistor is capacitively coupled to the inner conductor. The voltage appearing across the series arrangement of loop and resistor is measured when the voltage across the resistor and the voltage induced in the loop are aiding, and again when they are in opposition to each other. These two readings are obtained by rotating the loop through 180 degrees. As will be shown below, the readings may be used to determine the amount of mismatch and the power carried by the line. Operation is substantially independent of load impedance and meter impedance at any frequency within the useful range of the instrument. In the present models, voltage is measured by a diode voltmeter. A reflectometer with a fixed loop assembly is useful for continuous monitoring of line power. It can also be used to measure standing-wave ratio by

reversing the line connections, which is equivalent to reversing the loop. The design shown operates satisfactorily in the region of 1000 megacycles. A reflectometer unit with a rotating loop assembly has been designed for use in the 600-megacycle region.

## 1. Basic Theory

If a resistance and capacitance connected in series are placed between the inner and outer conductors of a coaxial line, as drawn in Fig. 1, the voltage  $e_1$  across  $R$  will be proportional to  $E$  the voltage between the conductors.

If a loop is placed between the inner and outer conductors, as in Fig. 2, the voltage  $e_2$  induced in the loop is proportional to the radio-frequency current  $I$  in the inner conductor.

In practice,  $e_1$  and  $e_2$  are simultaneously obtained by using the arrangement in Fig. 3. The necessary capacitive coupling between the resistor and inner conductor is provided by the proximity of the bottom of the resistor (and the connected loop wire) to the conductor.

Since all dimensions are chosen to be much smaller than  $\lambda$ , the distributed parameters can be approximately replaced by lumped impedances as shown in Fig. 4, where

$C$  = coupling capacitance,  
 $M$  = mutual inductance between the loop and the reflectometer line,  
 $E$  = voltage between conductors, and  
 $I$  = current flowing in the line.

The voltage across  $R$  will then be given by

$$\frac{RE}{R - jX_c} = \frac{RE(R + jX_c)}{R^2 + X_c^2},$$

where  $X_c = 1/\omega C$ , and  $\omega = 2\pi f$ . Let  $R \ll X_c$ . The voltage across  $R$  will be given by

$$e_1 \approx \frac{RE}{X_c} = j\omega CRE.$$

The voltage induced in the mutual inductance  $M$  is

$$e_2 = j\omega MI.$$

The total electromotive force induced is therefore

$$e = j\omega(CRE + MI). \quad (1)$$

In this equation,  $M$  may have positive or negative values.

The current and the voltage in the line may each be considered to consist of a wave traveling forward, and a reflected wave:

$$\left. \begin{aligned} E &= E_f + E_r, \\ I &= I_f + I_r, \end{aligned} \right\} (2)$$

where the subscript  $f$  denotes the forward wave, and  $r$  denotes the reflected wave. It can be shown that

$$\left. \begin{aligned} E_f &= I_f Z_0, \\ -E_r &= I_r Z_0, \end{aligned} \right\} (3)$$

where  $Z_0$  is the characteristic impedance of the reflectometer line. It is further known that the reflection coefficient  $\Delta$  is given by

$$\Delta = E_r/E_f = -I_r/I_f. \quad (4)$$

Substituting (2), (4), and (3) into (1), we have

$$\begin{aligned} e &= j\omega[RC(E_f + E_r) + M(I_f + I_r)], \\ &= j\omega[RC(E_f + E_f\Delta) + M(I_f - I_f\Delta)], \\ &= j\omega\left[RC(E_f + E_f\Delta) + M\left(\frac{E_f}{Z_0} - \frac{E_f\Delta}{Z_0}\right)\right], \\ &= j\omega E_f \left[RC(1 + \Delta) + \frac{M}{Z_0}(1 - \Delta)\right]. \end{aligned}$$

Let  $R$ ,  $C$ ,  $M$  and  $Z_0$  be chosen so that

$$RC = M/Z_0 = A, \quad (5)$$

where  $A$  is a given constant. Let  $e_p$  be the electromotive force when  $M$  is positive, and  $e_n$  the electromotive force when  $M$  is negative. The reversal of the mutual inductance is accomplished by turning the loop through 180 degrees, so as to reverse the direction of flux linkage in it. Then,

$$\left. \begin{aligned} e_p &= j\omega E_f [A(1 + \Delta) + A(1 - \Delta)] \\ &= 2j\omega E_f A, \end{aligned} \right\} (6)$$

and

$$\left. \begin{aligned} e_n &= j\omega E_f A(1 + \Delta - 1 + \Delta) \\ &= 2j\omega E_f A\Delta. \end{aligned} \right\} (7)$$

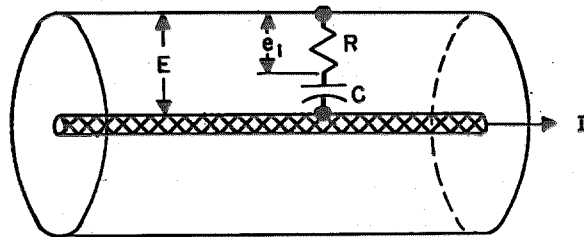

Fig. 1—Voltage relationships for a series resistance-capacitance combination placed between the conductors of a coaxial line;  $e_1$  is proportional to  $E$ .

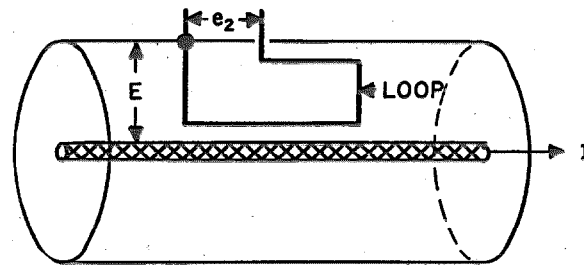

Fig. 2—A loop coupled to the inner conductor of a coaxial line will give a voltage output proportional to the current flowing in the line.

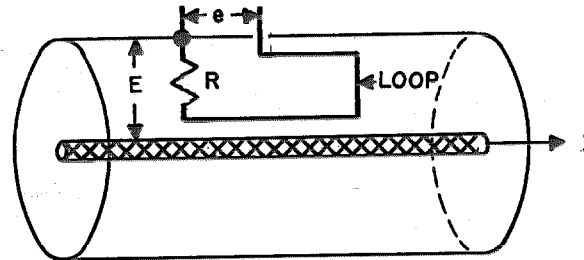

Fig. 3—Schematic representation of the reflectometer, showing loop and resistance. Capacitance is provided by the proximity of the arrangement to the inner conductor.

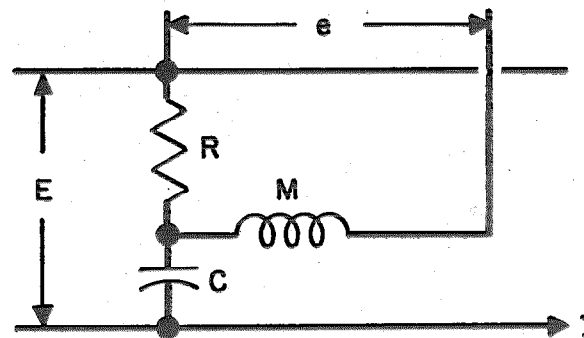

Fig. 4—Equivalent circuit of reflectometer.



Dividing (7) by (6), we have

$$\Delta = e_n/e_p$$

$$|\Delta| = \left| \frac{e_n}{e_p} \right| = \frac{|e_n|}{|e_p|}. \quad (8)$$

If the line has no attenuation and characteristic impedance  $Z_0$  then the standing-wave ratio  $q$  is given by

$$q = \frac{1 + |\Delta|}{1 - |\Delta|} = \frac{1 + |e_n/e_p|}{1 - |e_n/e_p|},$$

$$q = \frac{|e_p| + |e_n|}{|e_p| - |e_n|}. \quad (9)$$

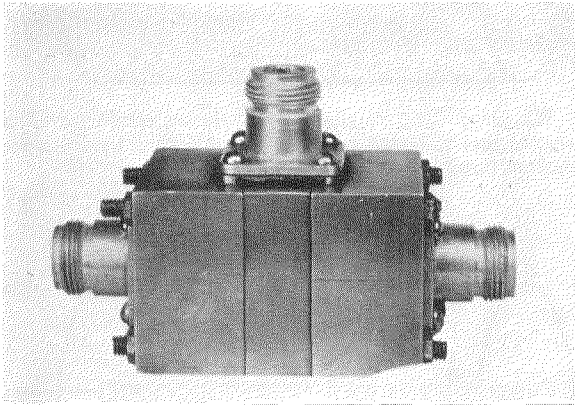

Reflectometer with fixed loop assembly for 1000-mega-cycle range. Power flow is directly through the pickup, with probe output connector at the top. Length of block is  $2\frac{1}{4}$  inches.

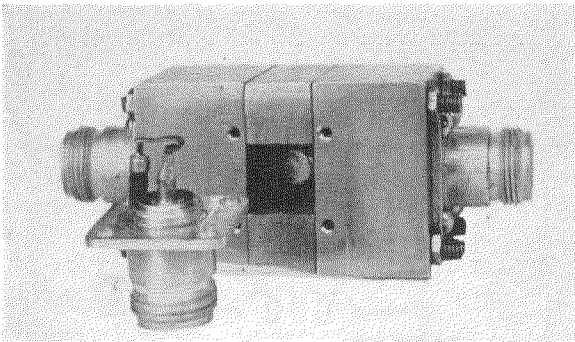

Disassembled view of fixed-loop reflectometer. Note capacitance disk attached to inner conductor of line section, and loop and resistor attached to the dismantled output probe connector.

The reflectometer may be used to measure power  $P$  as may be demonstrated in the following manner:

$$P = E \cdot I, \text{ where } E \cdot I = EI \cos \theta.$$

From (2),

$$\begin{aligned} P &= E \cdot I = (E_f + E_r) \cdot (I_f + I_r), \\ &= E_f \cdot I_f + E_r \cdot I_f + E_r \cdot I_r + E_f \cdot I_r. \end{aligned}$$

But from (4),  $E_r \cdot I_f = -E_f \cdot I_r$ , so that

$$P = E_f \cdot I_f + E_r \cdot I_r. \quad (10)$$

Substituting from (3) and (4),

$$\begin{aligned} P &= \frac{E_f \cdot E_f}{Z_0} - \frac{E_r \cdot E_r}{Z_0} = \frac{|E_f|^2}{Z_0} - \frac{|E_r|^2}{Z_0} \\ &= \frac{|E_f|^2}{Z_0} (1 - |\Delta|^2). \end{aligned}$$

By (8),  $|\Delta| = |e_n/e_p|$ . Then,

$$\begin{aligned} P &= \frac{|E_f|^2}{Z_0} \left( 1 - \left| \frac{e_n}{e_p} \right|^2 \right), \\ &= \frac{|E_f|^2}{Z_0 |e_p|^2} (|e_p|^2 - |e_n|^2). \end{aligned} \quad (11)$$

From (6),  $\left| \frac{E_f}{e_p} \right| = \frac{1}{2\omega A}$ , therefore

$$P = \frac{|e_p|^2 - |e_n|^2}{4\omega^2 A^2 Z_0} = \frac{c(|e_p|^2 - |e_n|^2)}{\omega^2}, \quad (12)$$

where  $c = 4A^2 Z_0 = 4M^2/Z_0$ , and depends only on the circuit constants of the reflectometer.

The value of  $c$  may be obtained by calculation when the circuit constants are known.  $R$  and  $Z_0$  can be accurately determined, and  $M$  is rather simply calculable from the geometry of the reflectometer. The value of the capacitance may be adjusted to agree with the design condition  $C = A/R = M/Z_0 R$ , by using the reflectometer to measure the standing-wave ratio in a line, and matching the observed value to that given by slotted-line measurements. Having determined the appropriate circuit constants, (12) shows that at a known frequency, and for any load impedance, one may use the reflectometer to give an absolute value of power without the necessity of calibrating against a known power, which is usually difficult to perform.

2. Effect of Meter Impedance

The foregoing discussion has implied the use of a meter having infinite impedance for measurement of the induced voltages. Since this will obviously not be true in practice, the effect of the meter impedance  $Z_m$  must be investigated. It is desired that the form of the expressions for reflection coefficient and power do not change when the measured voltages are substituted for the induced electromotive forces.

To determine the effect of the meter resistance, Thevenin's theorem may be used. According to this theorem, the pickup will act as a generator producing the equivalent of the open-circuited electromotive force as determined above, and having an internal impedance equal to the impedance observed when looking back from the load (meter circuit) to the pickup.

With reference to Fig. 5,

- $X_L$  = inductive reactance of the loop,
- $X_c$  = capacitive reactance between the loop and the inner conductor,
- $Z_t$  = total impedance between the inner and the outer conductor of the line, and
- $Z_r$  = reflected impedance in the loop due to mutual induction between the loop and the line.

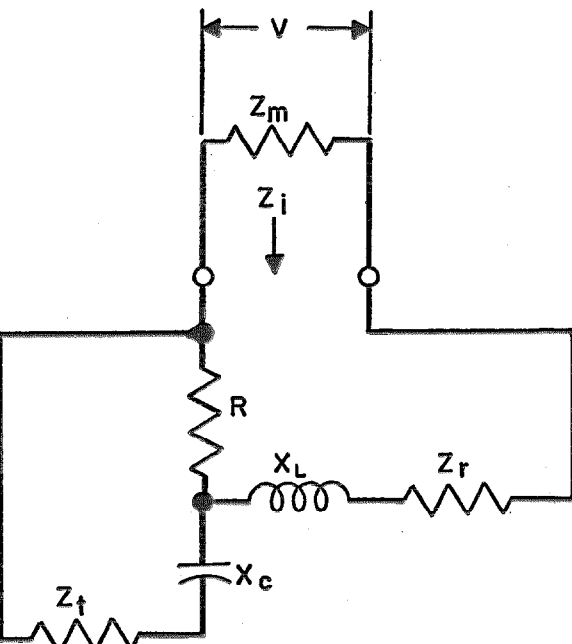
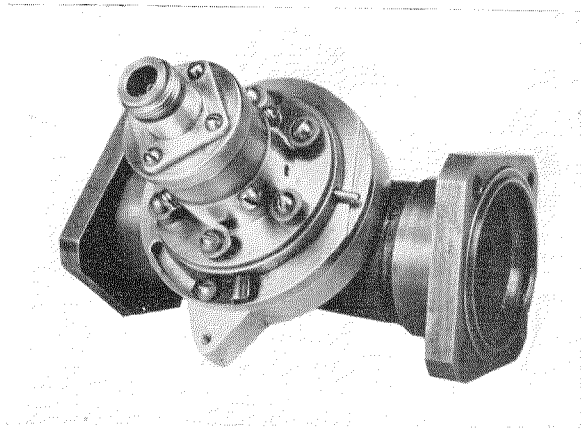
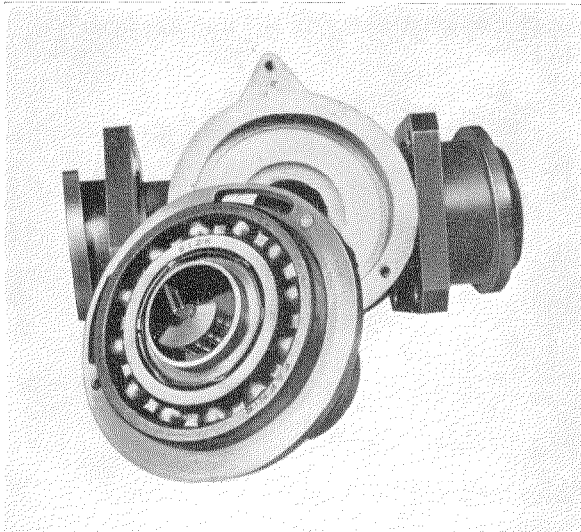

Fig. 5—Reflectometer circuit indicating effect of meter impedance.



Rotating-loop reflectometer for the 600-megacycle range. The probe output connector and rotating mount are attached to the side of a section of standard 1 5/8-inch coaxial line.



Disassembled view of rotating-loop reflectometer. The probe mount rotates on ball bearings. The loop is visible in the center of the mount. The resistors are partly hidden from view by the capacitance plate attached to the loop.

The reflected impedance  $Z_r$  is given by

$$Z_r = \omega^2 M^2 / Z_t, \tag{13}$$

and the internal impedance of the pickup  $Z_i$  as viewed from the meter, is therefore given by

$$Z_i = \|R, Z_t - jX_c\| + j\omega L + \frac{\omega^2 M^2}{Z_t}. \tag{14}$$

The notation  $\|Z_1, Z_2, \dots, Z_n\|$  will be used to designate the impedance of  $Z_1, Z_2, \dots, Z_n$  in

parallel. Denote by  $v_p$  the voltage observed when  $M$  is positive and by  $v_n$  the observed voltage when  $M$  is negative. Then

$$v_p = e_p Z_m / (Z_m + Z_i), \quad (15)$$

and

$$v_n = e_n Z_m / (Z_m + Z_i). \quad (16)$$

Equation (14) shows that  $Z_i$  is independent of the sign of  $M$ , and hence is the same for each position of the loop. Dividing (16) by (15) and substituting in (8), we obtain

$$\Delta = \frac{e_n}{e_p} = \frac{v_n}{v_p}, \quad \text{and} \quad |\Delta| = \left| \frac{v_n}{v_p} \right| = \left| \frac{v_n}{v_p} \right|, \quad (17)$$

which corresponds to (8). This result is independent of frequency, of the meter impedance, and of its response-frequency characteristics.

The power traversing the line has been shown to be

$$P = \frac{|E_f|^2}{Z_0} \left( 1 - \left| \frac{e_n}{e_p} \right|^2 \right).$$

From (17),

$$P = \frac{|E_f|^2}{Z_0} \left( 1 - \left| \frac{v_n}{v_p} \right|^2 \right). \quad (18)$$

Using (6) and (5) it is seen that

$$\begin{aligned} \frac{|E_f|^2}{Z_0} &= \frac{1}{Z_0} \left| \frac{e_p^2}{2j\omega A} \right| = \frac{1}{Z_0} \left| \frac{e_p Z_0}{2j\omega M} \right|^2 \\ &= Z_0 |e_p|^2 / 4\omega^2 M^2. \end{aligned} \quad (19)$$

Also from (14) and (15),

$$|e_p|^2 = |v_p|^2 \left| \frac{Z_m + \|R, Z_i - jX_c\| + j\omega L + \omega^2 M^2 / Z_i}{Z_m} \right|^2.$$

On substituting into (18), it is seen that the power will be proportional to the product of  $|v_p|^2$  and constants which are independent of the sign of  $M$ .

It is necessary to examine the dependence of the reading on the load impedance, because it affects  $Z_i$ , and hence  $v$ . From our previous assumption that  $X_c \gg R$ , and a further condition that  $R$  will be of the same order of magnitude as  $Z_i$ ,  $\|R, Z_i - jX_c\| \simeq R$ . Furthermore, to avoid large mismatching,  $Z_i$  will be of the same order of magnitude as  $Z_0$ . It will be shown below that  $\omega^2 M^2 / Z_0$  is negligible in comparison with  $R$ , and

that  $\omega L \ll R$ . With these approximations, (14) reduces to

$$Z_i \simeq R,$$

and

$$\frac{e_p}{v_p} = \frac{Z_m + R}{Z_m} = k,$$

where  $k$  is a constant for a given pickup and meter.

From (18) and (19), we then have

$$\begin{aligned} P &= \frac{Z_0 k^2 |v_p|^2}{4\omega^2 M^2} \left( 1 - \left| \frac{v_n}{v_p} \right|^2 \right) \\ &= c' \frac{|v_p|^2 - |v_n|^2}{\omega^2}, \end{aligned} \quad (21)$$

where  $c' = \frac{Z_0 (Z_m + R)^2}{4M^2 Z_m^2}$ , and is also a constant.

Equation (21) is in the same form as (12), which holds for the case of infinite meter impedance. For a finite meter impedance, therefore, an absolute determination of the power can also be made from a knowledge of the circuit constants in the reflectometer.

### 3. Frequency Limits of Reflectometer

The most stringent frequency limitation on the operation of the reflectometer is that the wavelength be very much larger than the dimensions of the pickup. This corresponds roughly to a frequency limit of 1000 megacycles. Other factors which affect the operation of the reflectometer as a wattmeter are shown below to be relatively small, and to be independent of frequency when suitably designed.

For the meter to measure power independently of the load impedance, it is necessary that

$$\left| \frac{\omega^2 M^2}{Z_i} \right| \simeq \frac{\omega^2 M^2}{Z_0} \ll |Z_m + R + j\omega L|.$$

To make this true it is sufficient that  $|\omega^2 M^2 / Z_0| \ll |R|$ . By choosing typical values for the circuit constants, the validity of this assumption can be tested: Let

$$\begin{aligned} Z_0 &= 50 \text{ ohms,} \\ E &= 100 \text{ volts} = E_f, \\ e_p &= 10 \text{ volts, and} \\ R &= 50 \text{ ohms.} \end{aligned}$$

A constant value has been chosen for  $e_p$ , since in practice the circuit constants of reflectometers

operating in widely differing ranges will be adjusted to provide optimum accuracy and the same input voltage for a full-scale meter reading in each range.

From (5) and (6),

$$A = \frac{M}{Z_0} = RC = \frac{e}{2E_f\omega} = \frac{10 \text{ volts}}{2(100 \text{ volts})\omega}$$

$$= \frac{0.05}{\omega} \text{ seconds.}$$

$$M = AZ = 2.5/\omega \text{ henries.}$$

$$\frac{\omega^2 M^2}{Z_0} = \frac{\omega^2 (2.5/\omega)^2}{50} = 0.125 \text{ ohm.}$$

This is negligible compared to  $R$  ( $= 50$  ohms).

The value of the  $j\omega L$  term in (20) may also be calculated

$$j\omega L = 2j\omega M = 2j\omega \frac{(2.5)}{\omega} = 5.0j \text{ ohms.}$$

These results confirm that at all frequencies  $|Z_i| \approx R$  to a high degree of approximation (about 1 percent error for the assumption made).

A second factor which must be considered is the validity of the assumption that

$$|R| \ll |jX_c|,$$

or

$$R \ll 1/\omega C.$$

From the previous calculations,  $C = A/R = \frac{0.05/\omega}{50} = 0.001/\omega$ . Therefore,  $X_c = 1/\omega C = 1000$  ohms, which is much larger than 50 ohms: The validity of the assumption is thus established.

It is possible, therefore, to operate the reflectometer at all frequencies for which the dimensions of the reflectometer loop are not an appreciable fraction of a wavelength. Negligible error will be introduced by other frequency effects.

#### 4. Applications of Reflectometer

When the reflectometer is used to measure the reflection coefficient and the standing-wave ratio, the value obtained for these quantities depends only on the ratio of two measured voltages. As was shown above, the results are therefore valid irrespective of variations in load impedance, meter impedance, response, and frequency, provided that the wavelength is greater than about 50 times the effective length of the pickup, i.e., for frequencies less than about 1000 megacycles with the pickups now used. A simple method of measuring  $\Delta$  would be to use a meter with variable sensitivity, and adjust it so that  $v_p$  gives a full-scale deflection. The fraction of full-scale deflection observed when the pickup is rotated through 180 degrees will equal the reflection coefficient. If two identical pickups were used, placed so that  $M$  has opposite signs, a ratiometer reading would give  $\Delta$  directly.

The requirements for use of the reflectometer as a radio-frequency wattmeter are more stringent, since the absolute value of  $E$  must be determined. A limit will again be imposed by the size of the pickup. Another requirement for a wide-band wattmeter is the necessity that the meter have a flat frequency response. The reflectometer may be designed so that it operates as a true wattmeter over any desired frequency range, but operation of a given reflectometer at a frequency very much higher than the one for which it was designed will lead to some error.

A further modification would be the use of thermocouples, which have a response proportional to  $v^2$ . If two thermocouples in series opposition are used, each connected to one of a pair of pickups which differ only in the sign of  $M$  and which are placed in the same section of one line, the resultant reading at a fixed frequency will be directly proportional to the radio-frequency power. Fig. 6 shows such a design. Since very-high-frequency thermocouples are not available, the maximum usable frequency would be reduced to a few hundred megacycles. The maximum frequency is greatly increased by

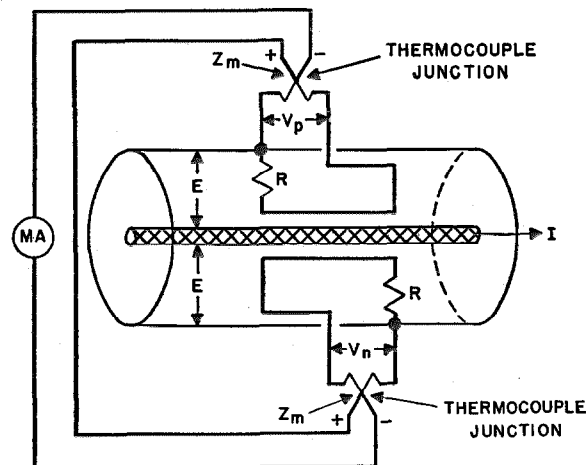

Fig. 6—Directional-pickup principle used in conjunction with thermocouples for measurement of radio-frequency power.

replacing the thermocouple with crystals operating in the square-law region.

Some simplification of design is achieved if a common resistor  $R$  is used in the above case, as shown in Fig. 7. The equivalent circuit is given

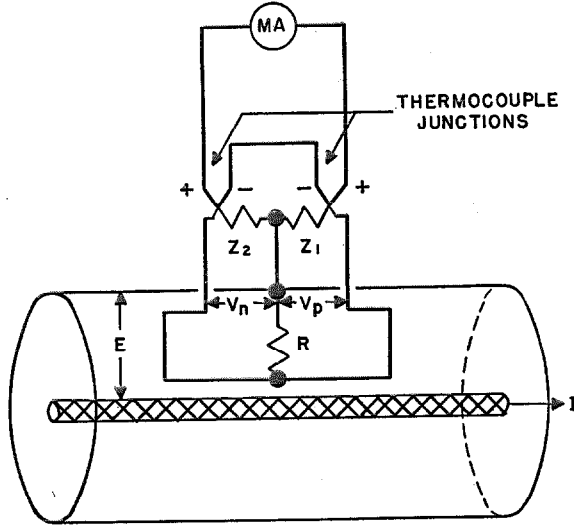

Fig. 7—Simplification of circuit shown in Fig. 6 by use of a common resistor.

in Fig. 8, where it is assumed that  $R \ll X_c$ , and  $\|R, Z - jX_c\| = R$ . Here  $e_1$  and  $e_2$  are the electromotive forces induced, and  $Z_1$  and  $Z_2$  are the meter-circuit resistances for each of the two loops, respectively.

From the principle of superposition,

$$v_p = \frac{e_1 Z_1}{Z_1 + \|R, Z_2, X_c\|} + \frac{E \|R, Z_1, Z_2\|}{X_c} + \frac{e_2 \|R, Z_1\|}{Z_2 + \|R, Z_1, X_c\|}$$

Since

$$R \ll X_c, \quad \|R, Z_2, X_c\| \simeq \|R, Z_2\|,$$

and

$$\|R, Z_1, X_c\| \simeq \|R, Z_1\|,$$

then

$$v_p = \frac{e_1 Z_1}{Z_1 + \|R, Z_2\|} + \frac{E \|R, Z_1, Z_2\|}{X_c} - \frac{e_2 \|R, Z_1\|}{Z_2 + \|R, Z_1\|}$$

Similarly,

$$v_n = \frac{-e_1 \|R, Z_2\|}{Z_1 + \|R, Z_2\|} + \frac{E \|R, Z_1, Z_2\|}{X_c} - \frac{e_2 Z_2}{Z_2 + \|R, Z_1\|}$$

If  $Z_1 = Z_2 = Z$ , and  $M_1 = M_2 = M$ , so that  $e_1 = e_2 = e$ ,

then

$$v_p = \frac{eZ}{Z + \|R, Z\|} + \frac{E \|R, Z/2\|}{X_c} + \frac{e \|R, Z\|}{Z + \|R, Z\|} = \frac{E \|R, Z/2\|}{X_c} + e = j\omega (\|R, Z/2\| CE + MI),$$

and

$$v_n = j\omega (\|R, Z/2\| CE - MI).$$

By comparison of these basic equations with those of the simple case (1), it can be seen that a similar set of equations for  $\Delta$  and  $P$  will be obtained if the following design condition is used:

$$A = \frac{M}{Z_0} = C \|R, Z/2\| = \frac{RZC}{Z + 2R}.$$

In that case

$$|\Delta| = \left| \frac{v_n}{v_p} \right|,$$

and

$$P = \frac{Z_0}{4M^2\omega^2} (|v_p|^2 - |v_n|^2).$$

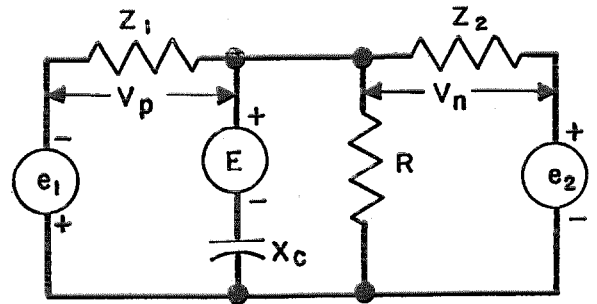

Fig. 8—Equivalent circuit of arrangement shown in Fig. 7.

### 5. Conclusions

The reflectometer is more compact than the present design of instruments which it replaces. It provides a measure of  $\Delta$  and standing-wave ratio using a measuring line which extends only over a small fraction of a wavelength, in contrast to slotted-line measurements which require at least quarter-wavelength lines. Furthermore, in contrast to present forms of radio-frequency wattmeters employed at high radio frequencies, it does not depend on resonant circuits, and hence is much less sensitive to frequency variation.

# Cathode-Design Procedure for Electron-Beam Tubes

By ROBERT HELM,

*Litton Engineering Laboratories, San Carlos, California*

KARL SPANGENBERG, and LESTER M. FIELD

*Stanford University, Stanford University, California*

*Editor's Note: The results of a research project carried on at Stanford University during 1941 and 1942 under the sponsorship of the International Telephone and Telegraph Corporation were published in part in a book entitled The Production and Control of Electron Beams by Karl Spangenberg, Lester M. Field, and Robert Helm. This limited edition was designated as "Secret" during the war, but is now declassified. This paper is based on parts of the book, which will not be reprinted in its entirety.*

DESIGN problems of single-potential cathode structures to produce convergent beams of specified size and current and of uniform current density have been investigated, and design procedures developed. All such structures consist of an electrode at cathode potential surrounding the cathode, and an accelerating electrode with an aperture through which the major portion of the beam passes. A typical structure is shown in Fig. 1. It is, of course, desirable to pass as high a percentage as possible of beam current through the aperture.

In general, the problem of calculating electron paths under conditions of space-charge-limited current flow between electrodes of arbitrary shape is difficult, if not impossible. There are well-known laws, however, governing space-charge-limited current flow for certain specific cases, such as current flow between parallel planes, concentric cylinders, and concentric spheres.<sup>1,2,3</sup> For all of these cases, the position of any electron can be stated in terms of only one coordinate.

J. R. Pierce proposed that to produce a uniformly convergent beam it was merely necessary to consider the beam to be a cone cut from inward radial current flow between concentric spheres, and then to shape the cathode electrode and the accelerating electrode to give the same electric field at the edge of the beam as did the

rest of the spherical flow that had been cut away.<sup>3</sup> Since the beam is a cone cut from space-charge-limited current flow between concentric spheres, both the current-voltage relations and the

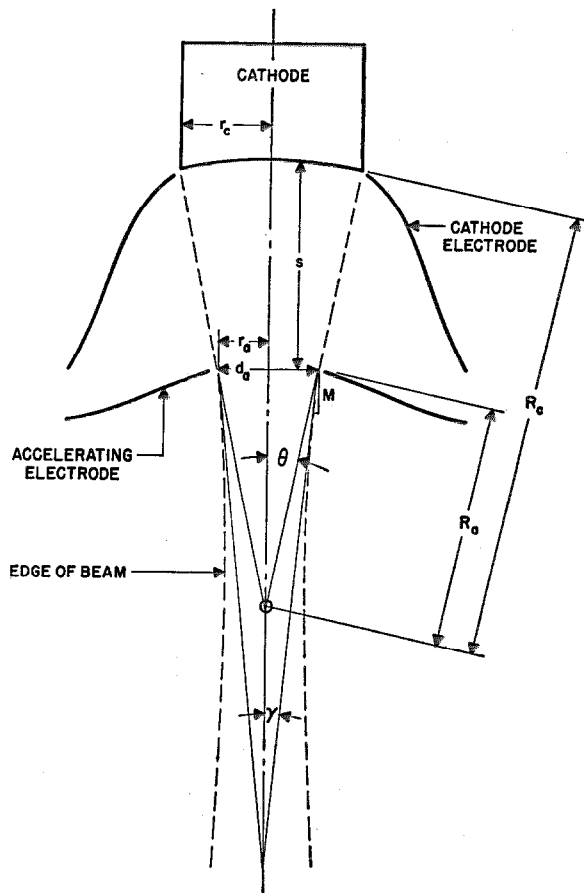

Fig. 1—Cross-section of typical cathode structure, showing dimensions involved in determination of beam shape. The electrode shapes are not functions of absolute size, but rather of ratios between dimensions.

<sup>1</sup> C. D. Child, "Discharge from Hot CaO," *Physical Review*, Series 2, v. 32, pp. 492-551; 1911.

<sup>2</sup> I. Langmuir and K. B. Blodgett, "Currents Limited by Space Charge Between Concentric Spheres," *Physical Review*, Series 2, v. 24, pp. 49-59; 1924.

<sup>3</sup> J. R. Pierce, "Rectilinear Electron Flow in Beams," *Journal of Applied Physics*, v. II, pp. 548-554; August, 1940.

variation of potential with radius, which determines the electrode shapes, are known.

This design procedure allows us to calculate all the operating characteristics of the cathode structure. The current-voltage relationship, the angle of convergence of the beam (both in the cathode-accelerating electrode space and also in the space behind the accelerating electrode), the cathode-current density, and the size and current density of the beam as it leaves the accelerating electrode are all known quantities.

The relations between current, voltage, and the geometry of the structure have been reduced to the chart of Fig. 2. The dimensional quantities involved are shown in Fig. 1, which is a cross section of a typical cathode structure. The characteristics of these structures are, as would be expected, functions only of ratios of dimensions, and are independent of the actual size of the structure. For this reason any convenient system of dimensions may be used, and the absolute size of the structure may be made such that the full emission density will be drawn from the type of emitting surface selected. For the chart of

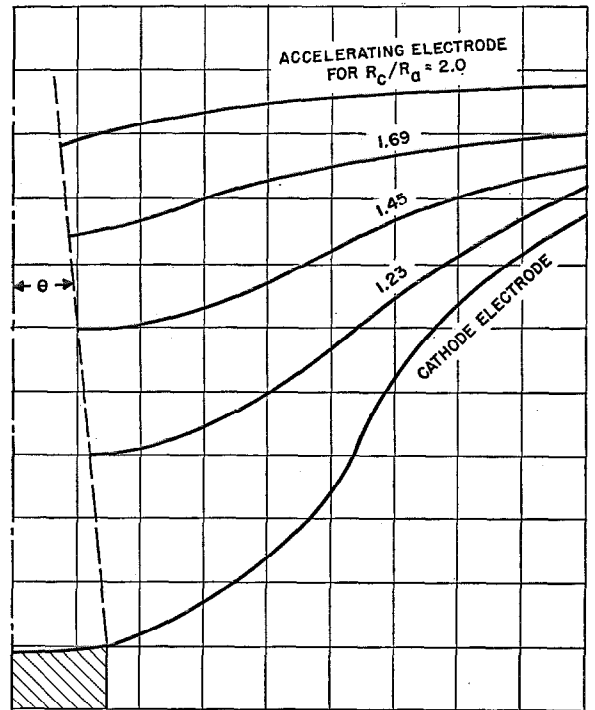

Fig. 3—Shape and placement of accelerating electrode for indicated values of  $R_c/R_a$ , where  $\theta = 5$  degrees.

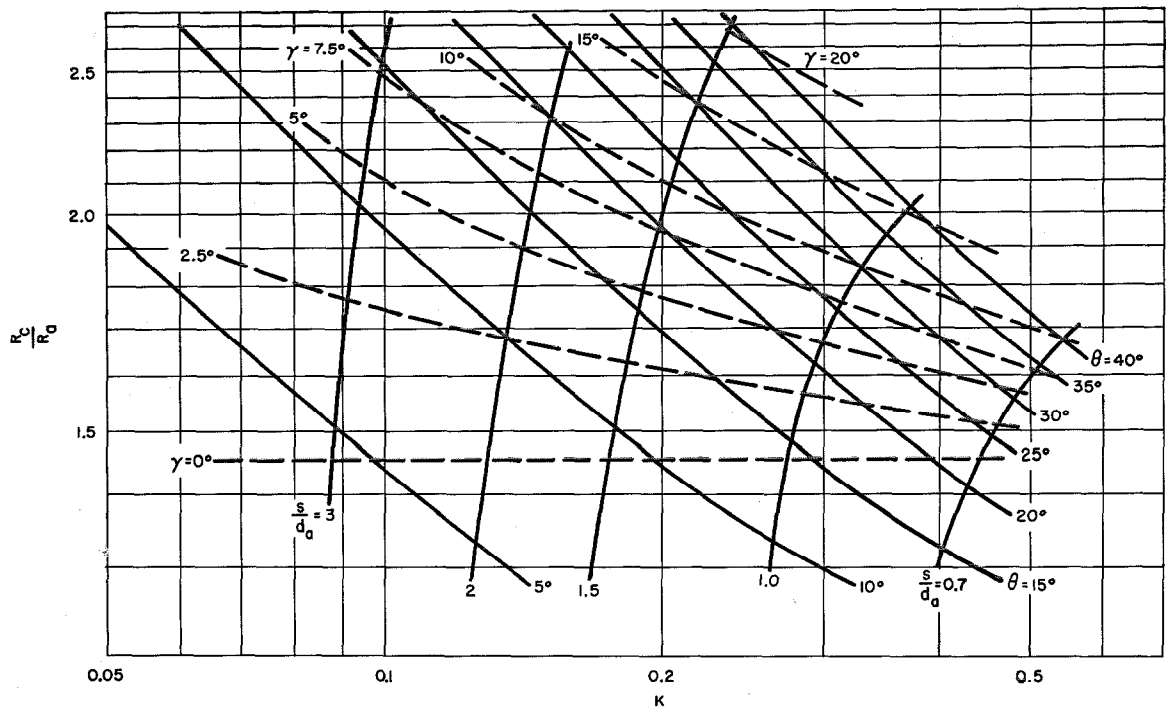

Fig. 2—Universal design chart, showing relationship of the four variables,  $K$ ,  $R_c/R_a$ ,  $\theta$ , and  $\gamma$ .

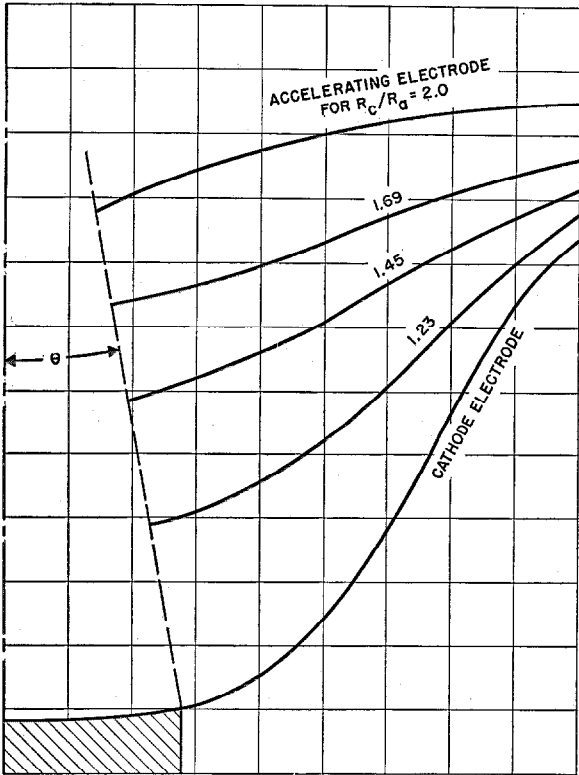

Fig. 4—Shape and placement of accelerating electrode for indicated values of  $R_c/R_a$ , where  $\theta=10$  degrees.

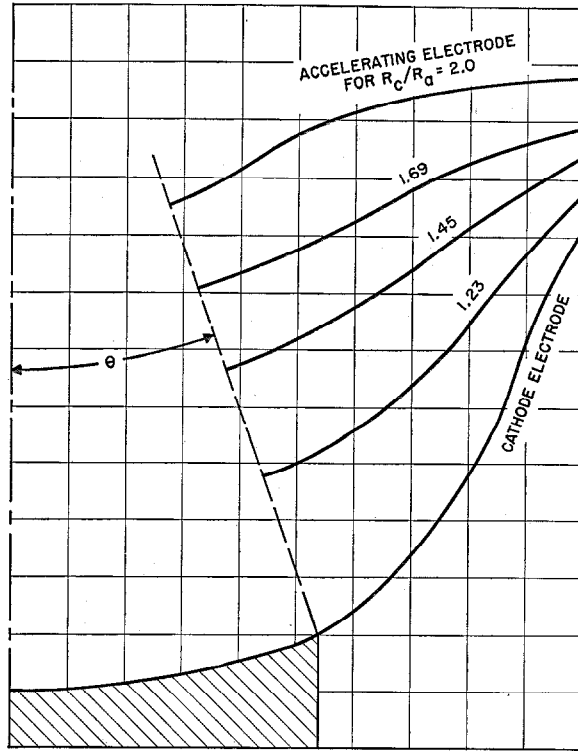

Fig. 5—Shape and placement of accelerating electrode for indicated values of  $R_c/R_a$ , where  $\theta=20$  degrees.

Fig. 2 (with reference to the dimensions illustrated in Fig. 1):

- $V$  = Beam voltage, kilovolts.
- $I$  = Beam current, amperes.
- $R_c$  = Cathode radius, spherical coordinates.
- $R_a$  = Aperture radius, spherical coordinates.
- $r_c$  = Cathode radius, cylindrical coordinates.
- $r_a$  = Aperture radius, cylindrical coordinates.
- $d_a$  = Aperture diameter, cylindrical coordinates.
- $s$  = Cathode-to-aperture spacing on the axis.
- $\theta$  = Semiangle of the beam between cathode and aperture.
- $\gamma$  = Semiangle of the beam leaving the aperture.

Fig. 2 is a universal chart showing the relationship between the four variables  $K$  ( $= I^{1/2}/V^{3/2}$ ),  $R_c/R_a$ ,  $\theta$ , and  $\gamma$ . Each point on the chart corresponds to a particular design of cathode structure. If any two variables are prescribed, ordinarily  $K$  and  $\gamma$ , then a point of the chart is determined and the corresponding values of the other two variables may be obtained. The electrode shapes for any cathode structure can be determined by methods described later in this paper. The electrode shapes for a wide range of cathode structures are given in Figs. 3 to 6.

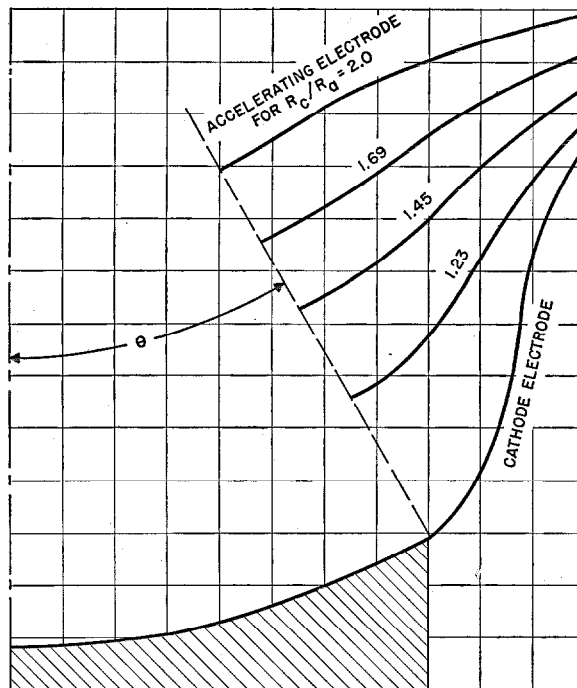

Fig. 6—Shape and placement of accelerating electrode for indicated values of  $R_c/R_a$ , where  $\theta=30$  degrees.



The relation between the four variables (Fig. 2) was determined as follows:

$$K = \frac{I^{\frac{1}{2}}}{V^{\frac{1}{2}}} = \frac{0.963 \sin(\theta/2)}{\alpha} \tag{1}$$

where  $\alpha$  is the spherical space-charge-limited current flow factor:

$$\alpha = \log \frac{R_a}{R_c} - 0.3 \left( \log \frac{R_a}{R_c} \right)^2 + 0.075 \left( \log \frac{R_a}{R_c} \right)^3 + \dots \tag{2}$$

Values of  $\alpha^2$  as a function of  $R_a/R_c$  are given in Table I. The factor  $\sin(\theta/2)$  takes into account the fact that the beam is a cone of semiangle  $\theta$  cut from the current flow between concentric spheres. From this relation, the solid curvilinear coordinates of  $\theta$  were plotted as functions of  $K$  and the ratio  $R_c/R_a$ .

For the case of an aperture without a grid, consideration must be given to the effect of the distortion of the electric field caused by the aperture. The aperture acts as a divergent electron lens of focal length approximately  $4V/E$ , where  $V$  is the voltage between cathode and accelerating electrode, and  $E$  is the electric field for the space-charge-limited current flow on the cathode side of the aperture. It is assumed that the beam passes into field-free space beyond the aperture, and that the position of the lens is at the intersection of the axis with the spherical anode radius<sup>4</sup>  $R_a$ . The distortion of the spherical equipotentials by the aperture causing the lens action is shown in Fig. 7. The above assumptions yield the strongest possible lens action at the aperture. For an actual structure, the lens action will be somewhat weaker, and the beam on leaving the aperture will be slightly more convergent than the curves for  $\gamma$  (which were plotted from these considerations) indicate. The amount of lens action is independent of applied voltage (provided the cathode has sufficient emission for the current to follow the Child's law relationship) so that the shape of the beam is theoretically independent of cathode-to-accelerating-electrode voltage.

Once the values of  $R_c/R_a$  and  $\theta$  have been determined, there remains the problem of determining the proper shape for the cathode and ac-

<sup>4</sup>From the geometry of Fig. 1 and the thin-lens formula,  $\frac{\sin \theta}{\sin \gamma} = \frac{1}{1 - \frac{R_a}{f}}$ , where  $f = 4V/E$ .

celerating electrodes. Remembering that the electron beam is a cone cut from the inward radial current flow between concentric spheres, the electrodes must produce at the edge of the beam the same electric field as the rest of the spherical flow that has been cut away. To obtain the desired beam shape, the electric field just inside the beam (which conforms to the spherical space-charge-limited current flow relationships) must be matched by the electric field just outside the beam, which is the field produced by the properly shaped cathode and accelerating electrodes in charge-free space. The problem is that of shaping the electrodes properly to produce a field at the edge of the beam that has zero component perpendicular to the beam, and has a variation of potential with radius proportional to the factor  $\alpha^{4/3}$ .

TABLE I  
 $\alpha^2$  AS A FUNCTION OF RADIUS

$R_a/R_c$	$(+\alpha)^2$	$R_a/R_c$	$(+\alpha)^2$
1.00	0.0000	6.5	13.35
1.05	0.0024	7.0	15.35
1.10	0.0096	7.5	17.44
1.15	0.0213	8.0	19.62
1.20	0.0372	8.5	21.89
1.25	0.0571	9.0	24.25
1.30	0.0809	9.5	26.68
1.35	0.1084	10	29.19
1.40	0.1396	12	39.98
1.45	0.1740	14	51.86
1.5	0.2118	16	64.74
1.6	0.2968	18	78.56
1.7	0.394	20	93.24
1.8	0.502	30	178.2
1.9	0.621	40	279.6
2.0	0.750	50	395.3
2.1	0.888	60	523.6
2.2	1.036	70	663.3
2.3	1.193	80	813.7
2.4	1.358	90	974.1
2.5	1.531	100	1 144
2.6	1.712	120	1 509
2.7	1.901	140	1 907
2.8	2.098	160	2 333
2.9	2.302	180	2 790
3.0	2.512	200	3 270
3.2	2.954	250	4 582
3.4	3.421	300	6 031
3.6	3.913	350	7 610
3.8	4.429	400	9 303
4.0	4.968	500	13 015
4.2	5.528	600	—
4.4	6.109	800	—
4.6	6.712	1 000	—
4.8	7.334	1 500	—
5.0	7.976	2 000	—
5.2	8.636	5 000	—
5.4	9.315	10 000	—
5.6	10.01	30 000	—
5.8	10.73	100 000	—
6.0	11.46	—	—

Taken from reference 2, p. 53.

The electrode shapes can be determined most conveniently by use of the electrolytic tank.<sup>3</sup> An insulator is placed to correspond to the edge of the beam, so that the direction of the electric

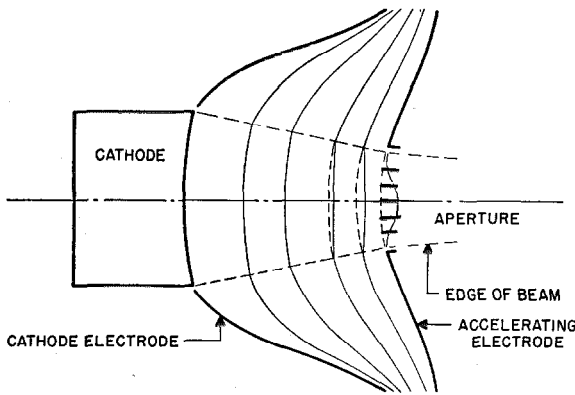

Fig. 7—Distortion of spherical equipotentials by the aperture with the resulting lens action. The dotted line indicates the correct equipotentials, the light solid line indicates the distorted equipotentials, and the small bars in the aperture indicate grid bars which may be used to maintain spherical equipotentials.

field must be parallel to the beam at its edge. Electrode shapes that will give the proper variation of potential along the insulator must then be determined. The analytical solution for a parallel beam of infinite width gives for the cathode electrode a plane at 67.5 degrees to the edge of the beam. For structures producing convergent beams, the conditions at the edge of the cathode, where curvature can be neglected, are the same as those for a parallel beam. The cathode electrode for all structures must therefore leave the cathode proper at an angle of 67.5 degrees to the edge of the beam, though this angle will hold only for a short radial distance. To simplify determining the shape of the remainder of the cathode electrode and the accelerating electrode, it was found convenient to set up vacuum-tube voltmeters along the insulator that represented the edge of the beam. The bias on these voltmeters was adjusted so that each meter would indicate half-scale with the desired potential at its probe. Copper strips representing the electrodes were then bent until all meters indicated half-scale. Multiple voltmeters were quite necessary, for without them it would have been very difficult to bend the strips to give the correct voltage at one point along the insulator without

making the voltage at another point farther in error. Since the structures have cylindrical symmetry, the tank was tilted at angle  $\theta$  to give a thin wedge of electrolyte tapering to zero thickness on the axis. A circuit diagram for the tank is shown in Fig. 8.

A series of electrode shapes for various angles of beam convergence  $\theta$  are shown in Figs. 3 to 6. For each value of  $\theta$  there is a family of accelerating-electrode shapes corresponding to particular values of the ratio  $R_c/R_a$ . While for any given geometry there is theoretically only one correct shape for both electrodes, there are actually a large number of shapes departing slightly from the correct shape that will produce very nearly the correct field at the edge of the beam. With the use of the electrolytic tank, "edge effects" for short electrodes are automatically taken into account, and the electrode shapes determined are slightly distorted to compensate for them. It is also very

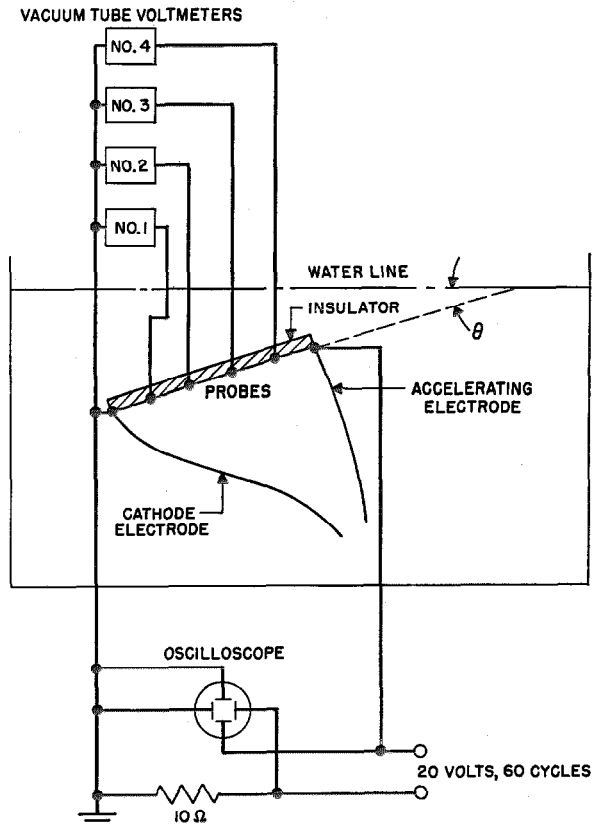

Fig. 8—Schematic diagram and vertical cross-section of electrolytic-tank circuit set up for determination of proper electrode shapes.

easy to determine the shortest electrodes that will produce the correct field at the edge of the beam. One electrode may depart slightly from the correct shape, and a corresponding shape found for the other electrode that will give the correct field.

Fig. 9 shows an experimental structure used to test the theory. The angle of convergence  $\gamma$  of the beam on leaving the aperture was not measured directly. Instead, the diameter of the beam at two measuring screens was observed. See Table II. A small axial voltage gradient was maintained along the entire length of the beam to remove any positive ions, since the calculation of beam diameter at the screens assumed full high-vacuum beam spread<sup>5</sup>.

<sup>5</sup>B. J. Thompson and L. B. Headrick, "Space-Charge Limitations on the Focus of Electron Beams," *Proceedings of the I.R.E.*, v. 28, pp. 318-324; July, 1940.

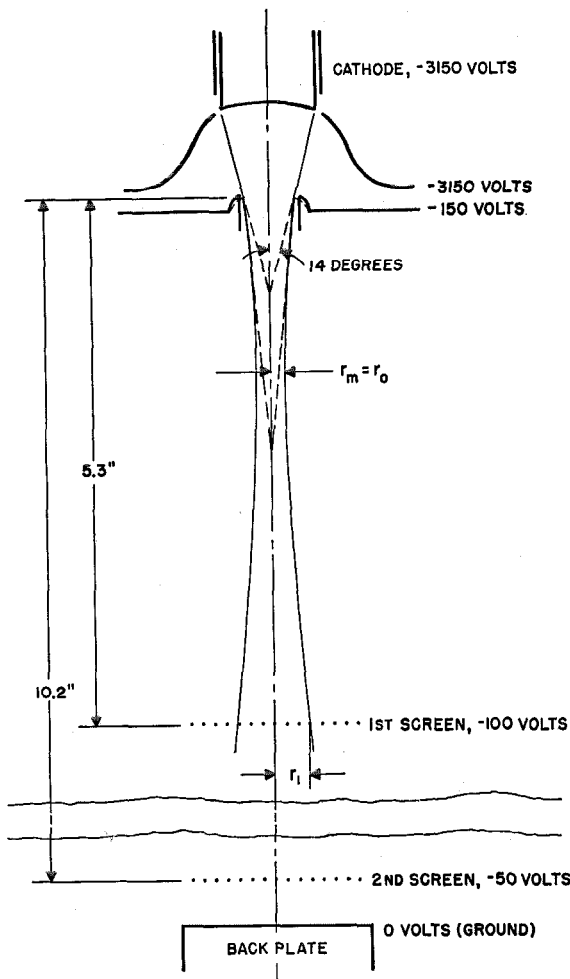

Fig. 9—Experimental structure used to test theory.

With the trend toward increasing the perveance of vacuum tubes, it is interesting to note the limitations on the maximum perveance that can be obtained from these structures. High-perveance structures lie at the extreme right of Fig. 2. In moving to the right along lines of

TABLE II  
CALCULATED AND EXPERIMENTAL DETERMINATION  
OF BEAM CONVERGENCE

	Voltage	Current in Amperes	Percent Current Through Aperture	Beam Diameter in Inches	
				1st Screen	2nd Screen
Calculated	1000	0.017	100	0.88	1.76
Experimental	1000	0.017	98.1	0.8	1.8
Calculated	2000	0.048	100	0.88	1.76
Experimental	2000	0.049	98.5	0.8	1.8
Calculated	3000	0.088	100	0.88	1.76
Experimental	3000	0.082	98.5	0.8	1.8

The following conditions apply:  $K=0.13$ ,  $R_c/R_a=2.06$ ,  $\theta=14.3$  degrees,  $\gamma=6.2$  degrees.

constant  $\theta$ , lower values of  $R_c/R_a$  are obtained. For a given value of  $R_c$ , the accelerating electrode must be brought nearer to the cathode to reduce the ratio  $R_c/R_a$ .

For the case of structures without grids, we must move to the right along lines of constant  $\gamma$ . This requires increasing the value of  $\theta$  as well as reducing the ratio  $R_c/R_a$ . The divergent-lens action of the aperture becomes stronger as the accelerating electrode approaches the cathode, so the beam must start at a greater semiangle  $\theta$  to have the same semiangle  $\gamma$  as it leaves the aperture. The limit is reached when the ratio of cathode-aperture spacing  $s$  to aperture diameter  $d_a$  becomes so small that the distortion of the field caused by the aperture (Fig. 7) is large at the cathode surface. When this occurs the current drawn from the center of the cathode drops below that drawn from its edges; the beam becomes nonuniform in current density, and the current becomes less than Fig. 2 indicates. A rough idea of the magnitude of this effect can be obtained from the solution for the axial electric field for the two-aperture electron lens.<sup>6</sup> The conditions in the lens only approximate

<sup>6</sup>S. Bertram, "Determination of the Axial Potential Distribution in Axially Symmetric Electrostatic Fields," *Proceedings of the I.R.E.*, v. 28, pp. 418-420; September, 1940.

those in our cathode structure, but the lens is considered because of its simple analytical solution. This solution gives a reduction in electric field at the center of the cathode of approximately 5 percent for  $s/d_a=0.70$ , and 10 percent for  $s/d_a=0.56$ . For convenience, contours of  $s/d_a$  are plotted in Fig. 2. The curves for  $\theta$  and  $\gamma$  were arbitrarily stopped at  $s/d_a=0.70$ . It should be remembered that this limitation is imposed by the current that can be drawn at a given voltage, and is not a limitation on the cathode-current density or the beam-current density. The practical limit of perveance that can be obtained from gridless structures is a subject requiring further experimental investigation.

This design procedure is an extension of the work of J. R. Pierce. By means of the charts, it is possible to obtain immediately a cathode structure for any current and voltage and at any angle of convergence over a wide range of these variables. The experimental work was not extensive enough to insure that the extremely high transmission found in the sample structures tested would be obtained in all cases, but it is believed that beam transmissions of at least 85 percent should result from the application of these design charts. The maximum perveance that can be obtained from these structures is another subject requiring further experimental investigation.

# Control of Electron-Beam Dispersion at High Vacuum by Ions

By LESTER M. FIELD, KARL SPANGENBERG,

*Stanford University, Stanford University, California*

and ROBERT HELM

*Litton Engineering Laboratories, San Carlos, California*

*Editor's Note: The results of a research project carried on at Stanford University during 1941 and 1942 under the sponsorship of the International Telephone and Telegraph Corporation were published in part in a book entitled The Production and Control of Electron Beams by Karl Spangenberg, Lester M. Field, and Robert Helm. This limited edition was designated as "Secret" during the war, but is now declassified. This paper is based on parts of the book, which will not be reprinted in its entirety.*

THE POSSIBILITY that a commonly accepted theory of electron-beam action in a field-free space failed to account for certain dispersion effects led to the construction of apparatus to establish and to measure any discrepancy which might exist. The apparatus showed that such a discrepancy did actually exist and permitted quantitative measurements of the effect.

Briefly, the effect found was a dispersion of a high-density electron beam when passing through a field-free drift space at a gas pressure at which no dispersion was to be expected. It had previously been believed that such a beam would produce positive ions from the gas in the tube even at extremely high vacuum and, because of the absence of any external electric field in a drift tube, such ions would remain in the beam and effectively neutralize the negative space charge of the beam. The slow electrons produced in the ionization process would be removed from the beam and sent to the tube walls by the electric field produced by beam space charge before neutralization. This field would also cause the positive ions to move toward the beam axis. Consequently, such a beam would be expected to undergo no dispersion after reaching equilibrium, at least until a vacuum of the order of  $10^{-10}$  millimeter of mercury was reached, at which pressure an insufficient number of gas molecules would exist for neutralization to occur. Unfortunately for such predictions, which were relied on in some commercial tube designs, the beam was found to begin its dispersion at a pressure of  $10^{-6}$  millimeter, or at a pressure 10 000 times higher than expected.

Fig. 1 shows the manner in which the amount of dispersion undergone by a beam was found to vary for different velocities of the electrons. Low-velocity (or low-voltage) beams spread ap-

preciably at a much higher vacuum than did high-voltage beams, and also increased their spread at a lower rate as the pressure dropped, although they ultimately reached much greater total dispersion. An optimum voltage was found to exist for which beam dispersion began at the poorest vacuum. Higher- and lower-voltage beams began their dispersion at a better vacuum.

A search for an explanation led to an approximate theory of ion removal which has had considerable success in predicting all the effects observed. It has also led to the invention of means for preventing such effects. The theory quantitatively predicts the amount of beam dispersion and the pressures at which such dispersion begins to be appreciable; it uses only standard physical constants. It also predicts the optimum voltage at which the effects begin and seems to check closely all of the observed phenomena.

Recombination, wall charges, increased gas temperature, and ion velocities achieved by collision during ionization, have been ruled out as possible explanations by consideration of their magnitudes and effects.

## 1. Ion-Removal Process

The proposed theory is based on the idea of an ion sink, or in other words, an external field which reaches a small distance into the field-free space and continuously removes ions from this portion of the beam. Such a field is known to exist at the aperture through which the electron beam first enters the field-free space, or drift tube; this field is an extension of the strong electron-accelerating field in the near vicinity. The important question is to ascertain how far down the beam this ion removal is effective. Since removal of positive ions at one section of the beam (by an external field, for example) causes the

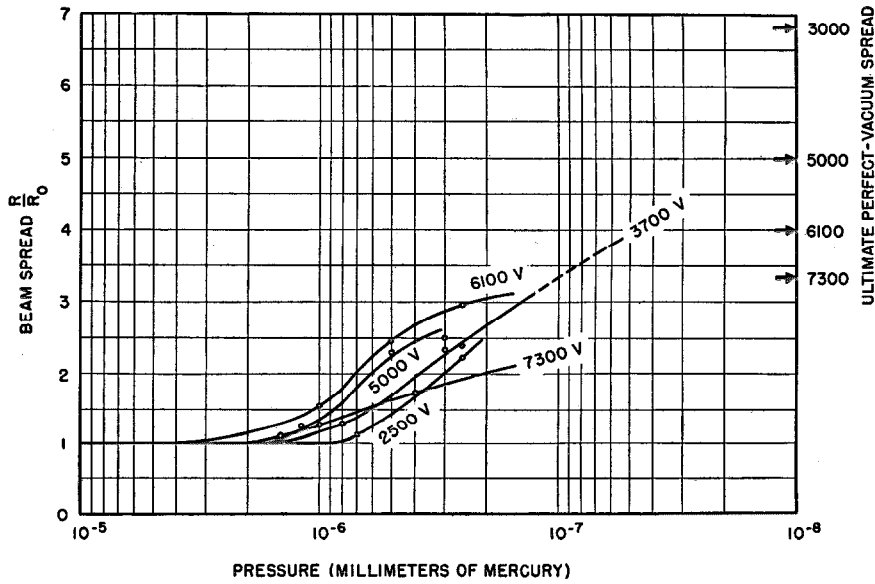

Fig. 1—Results of beam-spread measurements. Beam current=50 milliamperes. Drift-tube length=36 centimeters. Beam-current density=0.1 ampere per square centimeter.

center of the beam at this section to become more negative in potential, ions from nearby sections tend to flow toward this point. This provides a mechanism whereby ions from points still farther down the beam start flowing toward the sink. Thus ion removal from much greater distances than the actual field penetration is possible. It remains now to formulate mathematically the process involved, to determine whether the effect is negligible or important, and to find in what manner it depends on the field at the aperture, pressure (which influences the rate of production of ions), beam voltage, and beam current.

Consider now Fig. 2, in which is depicted a drift tube, or field-free space (the effect propagating back to the sink occurs in field-free space away from the aperture). The electrons enter at the left with velocity  $v$  and traverse the space at essentially this velocity until they hit the back plate at  $X=d$ . Throughout the volume traversed, they produce ions at a constant rate of  $n$  per centimeter. Then the number of ions per second produced in a length of beam  $dX$  will be  $ndX$ .

Under the equilibrium conditions, these ions and all other ions produced in the beam must flow to the left under the influence of potentials produced by space charge only, and they must be re-

moved from the beam at the ion sink at the same rate as that at which they are being produced. Then, some equilibrium number of ions may be considered to exist at each part of the beam, depending on the number and velocity of ions passing that point. However, the ions passing any given point have a range of velocities determined by the potential they have fallen through which, of course, depends on the distance between the starting point and the point in question. Further, the potential at each point depends on the above result, and consequently an integral relation for the total effect may be written.

Consider conditions at the plane  $X_0$ , through which all ions produced to the right of this plane are flowing (Fig. 2). As a first approximation, consider the ions to be flowing principally on the axis, since the form of potential variation across the beam produces an inward radial force on the ions except where the electron space charge is completely neutralized, and consequently all ions in the unneutralized regions tend to move toward or oscillate closely about the axis. The ions will be moving through the plane  $X_0$  with velocities dependent on  $(V_X - V_{X_0})^{1/2}$ , where  $V_X$  is the potential at the center of the beam at plane  $X$ , where the ions are produced, and  $V_{X_0}$  is the potential at the center of the beam at plane  $X_0$ . At  $X_0$  the current of ions, or number of ions per second, from the section  $dX$  will be  $ndX$ , as described before. These particular ions have a

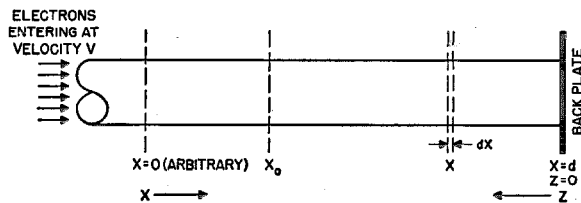

Fig. 2—Electron beam in field-free space.

velocity  $k(V_X - V_{X_0})^{\frac{1}{2}}$ , so the density at  $X_0$  of ions from section  $dX$  at  $X$  only will be

$$d\rho_{X_0} = \frac{n dX}{k(V_X - V_{X_0})^{\frac{1}{2}}}, \text{ ions per centimeter.} \quad (1)$$

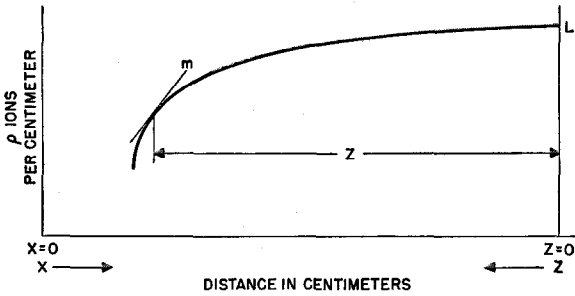

Fig. 3—Universal ion-density curve.

The total ion density at  $X_0$  will be given by

$$\rho_{X_0} = \int_{X_0}^d \frac{n dX}{k(V_X - V_{X_0})^{\frac{1}{2}}}, \text{ ions per centimeter.} \quad (2)$$

Now an application of Gauss's law shows that in an electron beam of constant density  $\rho -$ , on which is superimposed an ion beam of varying density  $\rho +$ , the potential difference between points on the center of the beam at, for example, positions  $X$  and  $X_0$  is exactly equal to the difference in positive-ion charge density at the two points. Or

$$V_X - V_{X_0} = \rho_X - \rho_{X_0}, \quad (3)$$

where  $V$  is in electrostatic volts and  $\rho$  is in electrostatic units per centimeter.

It should be noted that here and elsewhere throughout this paper charge densities are given per linear dimension, and all effects are independent of the area of the beam involved except where otherwise noted.

Now, if in the integral formulation of the problem,  $\rho_X - \rho_{X_0}$  is substituted for  $V_X - V_{X_0}$ , the equation is an integral equation from which the manner in which  $\rho$  varies with  $X$  can be found. It is now

$$\rho_{X_0} = c \int_{X_0}^d \frac{dX}{(\rho_X - \rho_{X_0})^{\frac{1}{2}}}, \quad (4)$$

where

$$c = n/K. \quad (5)$$

We seek a solution for  $\rho$  as a function of  $X$ ,  $\rho(X)$ , which will satisfy this integral for various values of the constants.

The solution of this integral equation (see 6.1) is as follows:

$$3\pi c(d - X) = 2(L + 2\rho)(L - \rho)^{\frac{1}{2}}, \quad (6)$$

where  $L$  is the value of  $\rho$  at  $X = d$ , and  $c$  is a constant depending on the rate of production of ions, their mass, and their charge.

It is more convenient to use  $Z = d - X$  as the coordinate for distance along the beam, where  $Z$  is now the distance back from the point of maximum ion density. This is usually at the back plate or collector, although it may be at any point along the beam at which ions reach a limiting density and beyond which they are removed by another process (for example, normal radial flow to the drift-tube walls under equilibrium conditions in an electron beam). Then,

$$3\pi cZ = 2(L + 2\rho)(L - \rho)^{\frac{1}{2}}. \quad (7)$$

This equation defines a form of variation, which can be represented by a curve, and which must be followed by ion density under all conditions for which this process occurs. The relative scales of this universal curve depend, however, on the value of the constant  $c$  (a function of pressure, current, and voltage), and the value of  $L$ . Fig. 3 shows the form of this universal curve. Another set of relations, more useful for calculation, gives the same result in terms of  $c$  and

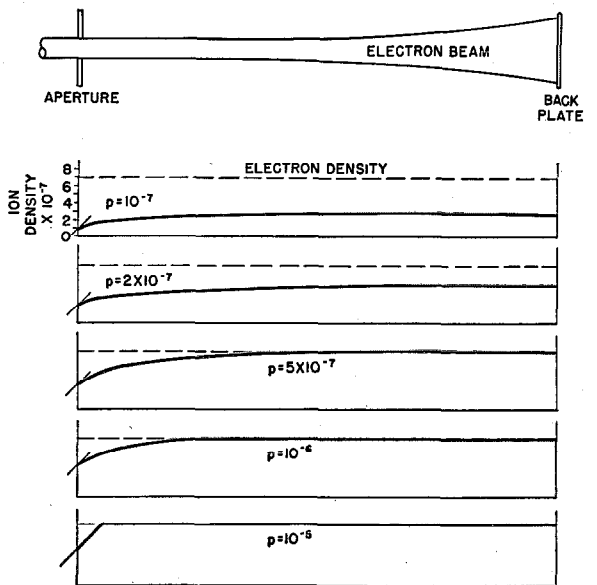
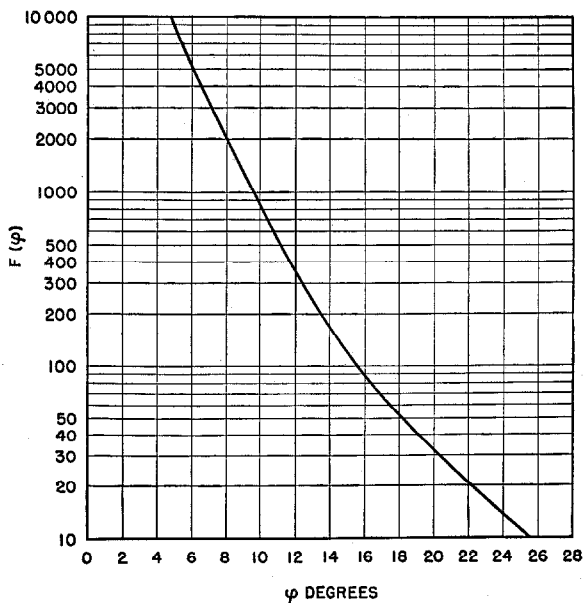
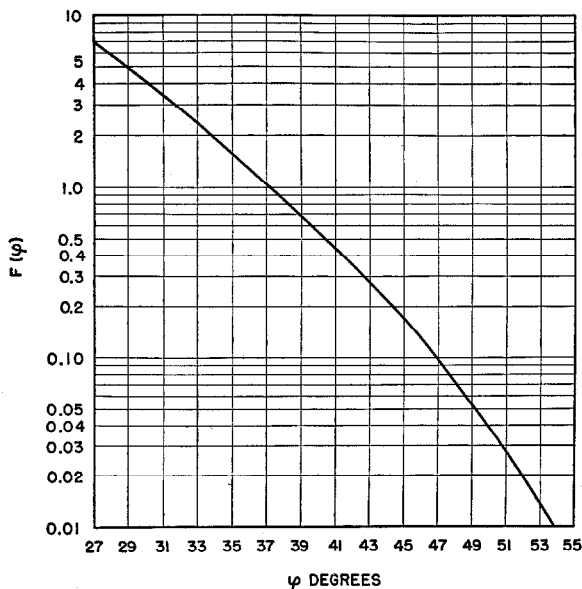

Fig. 4—Variation of ion density with pressure  $p$  in millimeters of mercury. The dashed lines plot the electron density.

 Fig. 5—Plot of the function  $F(\varphi)$ .

 Fig. 6—Plot of the function  $F(\varphi)$ .

gradient  $m$  at a specified point along the beam (at the aperture).

It should be noted that the gradient becomes infinite at a point on the curve. This merely means that an infinite gradient could extend the process from the point in question forward in the manner shown. Since a finite gradient exists at the aperture where the process starts, the actual ion density varies, according to the curve, from the point of tangency of the line with slope  $m$  ( $m$  = gradient at aperture) up to a maximum value  $L$ . Infinite gradient is now no longer necessary because to the left of the point of tangency a new process, i.e., an external field, is removing the ions.

If, starting with some definite value of gradient, the ion-density curve rises so fast that it reaches a value equal to that of the electron density of the beam before reaching the back plate, the ion density will be postulated to rise no higher, but rather remain constant and equal to the electron density for the remaining distance to the back plate. The excess number of ions formed in this region will be removed from the beam radially to the drift-tube walls, for their presence in excess of the electron density produces a field which acts radially outward on positive ions. The manner in which the universal ion curve of Fig. 3 adjusts itself to varying pressure at a constant aperture gradient (de-

termined by external factors) is shown in Fig. 4 for a typical beam (an approximate representation of the 6000-volt-beam condition). This curve shows the various conditions just described.

When the constants are evaluated (see 6.3), the fundamental equation becomes

$$\frac{pi}{V} Z \cdot 1.34 \cdot 10^{22} = (L + 2\rho)(L - \rho)^{\frac{1}{2}}, \quad (8)$$

where

- $p$  = pressure in millimeters of mercury,
- $i$  = current in amperes,
- $Z$  = distance in centimeters from the back plate, or positions of  $L$  to the position at which  $\rho$  is the ion density,
- $V$  = beam voltage in volts,
- $L$  = maximum linear ion density in ions per centimeter and,
- $\rho$  = linear ion density in ions per centimeter at any position  $Z$ .

The equation as given above cannot be readily solved directly for  $L$  and  $\rho$  when we know  $p$ ,  $i$ ,  $V$ , and  $Z$  (even though we know  $\rho = L$  at  $Z = 0$ ), and also know  $d\rho/dZ$  at one point.

A solution in parametric form has been worked out which gives the answers directly in terms of known constants. In terms of a parameter  $F(\varphi)$ , for which curves are given in Figs. 5 and 6, the



solution in practical units (see 6.2) is

$$\frac{p^2 i^2}{d V^2 m^3} \cdot 7.96 \cdot 10^{22} = F(\varphi). \quad (9)$$

Knowing  $F(\varphi)$ , the curves give the value  $\varphi$ , and then

$$L = 4.47 \cdot 10^{14} \left[ \frac{pid}{V \sin\left(\frac{3\varphi}{2}\right)} \right]^{\frac{2}{3}}, \quad (10)$$

where

$p$  = pressure in millimeters of mercury,

$i$  = beam current in amperes,

$d$  = distance from aperture to point of maximum ion density (where  $L$  occurs),

$V$  = voltage corresponding to beam velocity,

$m$  = gradient at the aperture in volts per centimeter,

$L$  = maximum ion density in ions per centimeter, and

$$F(\varphi) = \frac{\cos^3\left(\frac{3\varphi}{2}\right)}{\sin\left(\frac{3\varphi}{2}\right) \sin^3 \varphi}. \quad (11)$$

(Curves are given of this function.)

Thus we determine  $L$  in terms of known conditions, and therefore know the degree of neutralization of the electron beam.

## 2. Comparison of Theoretical and Measured Results

Values calculated from the theory proposed in Section 1 may now be compared with the measured values of beam spread versus pressure given in Fig. 1.

For this purpose, the values 3000, 6000, and 7300 volts, all at 0.050 ampere total current, have been selected for calculation. The results are given in this section and are compared with the observed beam-spread values.

In addition to the voltage, current, and length of beam, the gradient at the aperture must be known. This is the gradient produced by field penetration through the aperture from the main accelerating field into the previously field-free drift space.

For the aperture-cylinder configuration used, the field penetration would be approximately 0.1 percent of the maximum field present in the accelerating region; field plots show that the field penetrating down the cylinder would be approxi-

mately 1 percent of the maximum field and this is reduced by a factor of 10 in passing through the aperture.

The structure used was of such form that the main accelerating field in volts per centimeter was fairly closely  $V/16.6$  (from a field plot of the configuration used), so that the maximum accelerating fields came out as indicated in Table I.

TABLE I  
MAXIMUM ACCELERATING FIELDS

$V$ in Volts	$E$ (Maximum) in Volts per Centimeter	$m$ or $E$ Through Aperture in Volts per Centimeter
3000	180	0.180
6000	360	0.360
7300	438	0.438

The values given above are used in the calculations. The results are not particularly sensitive to a variation in field however, and so slight errors in this estimate are not serious.

The detailed calculation of theoretical beam spread for the conditions specified, where  $V = 3000$  volts, follows from these preliminary calculations:

$$\left. \begin{aligned} F(\varphi) &= 7.96 \cdot 10^{22} \frac{i^2 p^2}{d V^2 m^3} \\ &= \frac{7.96 \cdot 10^{22} \times 0.050^2 \times p^2}{36 \times 3000^2 \times 0.18^3} = 1.05 \cdot 10^{14} \times p^2. \end{aligned} \right\} (12)$$

Then

$$L = 4.47 \cdot 10^{14} \left[ \frac{pid}{V \sin\left(\frac{3\varphi}{2}\right)} \right]^{\frac{2}{3}},$$

or, if we let

$$\xi = \left[ \frac{1}{\sin\left(\frac{3\varphi}{2}\right)} \right]^{\frac{2}{3}},$$

then

$$L = 3.2 \cdot 10^{12} \times p^{\frac{2}{3}} \times \xi, \quad (13)$$

when  $d = 36$  centimeters.

For the case where  $L$  exceeds the electron density, the length of beam over which the ion density is less than the electron density is of interest. As the electron density is  $9.6 \cdot 10^7$  electrons per centimeter, the value of  $d$  (distance from the aperture) at which the ion density equals the electron density is, from (10) with  $9.6 \cdot 10^7$  for the value of  $L$ ,

$$d^{\frac{2}{3}} = \frac{3.3 \cdot 10^{-4}}{p^{\frac{2}{3}} \xi}, \quad (14)$$

from which  $d$  may be found.

It is of interest to know the value to which  $L$  rises at the end of the beam (36 centimeters from the aperture), if this value is less than the electron density. Then the beam is obviously less than fully neutralized, and the value of  $L$  helps in estimating the amount by which the beam will spread. The value of  $L$  at the end of the beam is given by (13).

If  $L$  will rise to greater than the electron density in 36 centimeters, the value of  $L$  is no longer of interest, but instead the value of  $d$  at which the ion density first reaches the electron density becomes important and is given in (14).

The two conditions occur in the examples of Fig. 4, which show the ion density variation from highest to poorest vacuum. The resulting beam spread may then be estimated with the aid of the universal-beam-spread curve of Fig. 7, which is based on ion-free or perfect-vacuum conditions. An exact solution of the beam spread when the charge density varies with length in the fashion shown in Fig. 4 would probably be very difficult, although it makes an interesting problem. For the purposes of this calculation,

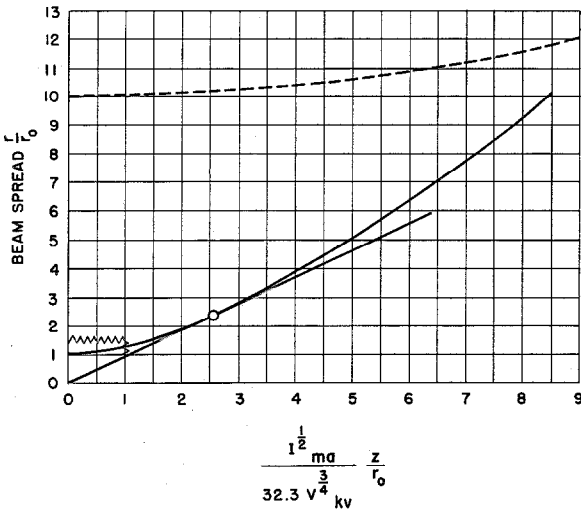

Fig. 7—Universal beam-spread curve (negative space-charge effect).

$$\frac{Z}{r_0} = \frac{V^2}{I^2} \cdot \frac{1}{2^{\frac{1}{2}}} \left(\frac{e}{m}\right)^{\frac{1}{2}} \int_1^R \frac{dR}{(l_n R)^{\frac{1}{2}}}, \text{ electrostatic units,}$$

$$R = \frac{r}{r_0}.$$

That part of the curve within the wavy line at the origin is plotted at 10 times size in the upper dashed curve. Both ordinate and abscissa scales should be divided by 10 in using this curve.

such an added complication is hardly justified, so a standard method of estimating the spread is used. This means that the precise values of spread at conditions between no spread and perfect-vacuum spread may be somewhat in error, but relative values for different pressures and for different voltages may have some meaning because the same method of estimation is used in each case.

TABLE II  
CHARACTERISTICS OF A 3000-VOLT BEAM

$\phi$ in Millimeters of Mercury	$F(\phi)$	$\phi$ degrees	$\xi$	$L$ Ions per Centimeter	$d$ in Centimeters	$R/R_0$ Beam Spread
$5 \cdot 10^{-6}$	260 000	2	7	—*	0.064	1.0
$1 \cdot 10^{-6}$	105	15.5	1.86	—*	2.35	1.1
$5 \cdot 10^{-7}$	26.0	21.0	1.54	$31 \cdot 10^{17}$ *	6.30	1.5
$1 \cdot 10^{-7}$	1.05	36.9	1.14	$7.8 \cdot 10^{17}$	50†	3.8
$1 \cdot 10^{-8}$	0.0105	53.5	1.005	$1.5 \cdot 10^{17}$	—†	6.0
0	—	—	—	—	—	6.8

\* Greater than electron density of  $9.6 \cdot 10^{17}$ .

† Longer than the beam length of 36 centimeters.

The method used was basically as follows: A beam just reaching complete neutralization at the back plate (corresponding to the middle diagram of Fig. 4) was considered to spread just *half* as much as a completely unneutralized beam, as the lack of neutralization in the initial portion of the travel would have a relatively great effect on this spread. A beam reaching the full neutralized value at a fraction of the total length of the beam is considered to spread just half as much as an unneutralized beam would spread for this length, and then to continue to spread in a straight line at the angle reached until it gets to the back plate. This implies complete neutralization in all the beam after the ion density equals the electron density. An excess number of ions over electrons presumably would not be found in the beam, as the radial field would repel them to the walls as previously described. Where the ion density fails to reach the electron density even at the back plate, the spread is taken as between half and all of the completely unneutralized spread by an amount proportional to the fractional neutralization at the back end. The results are then as given in Table II for the 3000-volt beam. The factor for use in Fig. 7 is  $Z/5.84$ .

Plots of similar calculations carried out for 6000 volts and 7300 volts, together with the results for 3000 volts, are presented in Fig. 8.

A direct comparison of these theoretical results with measured results of beam spread as shown in Fig. 1, may now be made. The following correlations may be observed to exist:

A. Experimentally, beams of all voltages at the specified current were found to start spreading at a pressure of approximately  $10^{-6}$  millimeter of mercury. The theoretical curves also have this property.

B. The values of beam spread at any particular pressure check fairly well despite the approximate method of calculating this spread (described in the analysis of the 3000-volt beam).

C. In the measured results, the higher-voltage beams (up to a critical voltage) reached their limiting spread quickly as the pressure dropped, while lower-voltage beams increased their spread gradually with decreasing pressure. Above the critical voltage (approximately 6000 volts), spread again increased gradually with falling pressure. The theoretical curves show precisely these properties.

D. Perhaps the most unexpected correlation is the verification by the theory of a second-order effect which was just barely indicated on the measured results because of the difficulty of accurate measurement of small changes in beam spread. Measurements taken showed a small variation in the pressure at which dispersion began for various beam voltages. Dispersion began soonest (at poorest vacuum) for a beam of approximately 6000 volts. Higher- or lower-voltage beams began to disperse only at a better vacuum. The theoretical curves of Fig. 5 show that the theory predicts precisely such a varia-

tion, and indicates the optimum voltage (or worst voltage if the effect is considered as one to be avoided).

To summarize, the theory gives calculated values which agree closely with the measured values of the pressure at which the dispersion occurs, the amount of dispersion, and the variation in dispersion with voltage. In addition, a test of the basic premise of the theory is described in Section 4. The test appears to verify this premise and has led to a practical application of the theory to beam tubes.

### 3. Apparatus and Experimental Procedure

The apparatus for studying the effect of voltage, current, and pressure on the spread of a parallel beam consisted in part of a cathode and an accelerating electrode, followed by a focusing cylinder to form a parallel beam. There was then a limiting aperture, followed by some apertures in thin metal sheets placed so that the position at which the sides of the beam were parallel could be determined. This was followed by a long drift tube at the end of which was placed a thin metal target. The heating of this target gave an indication of the diameter of the beam. An ionization gage for measuring the pressure

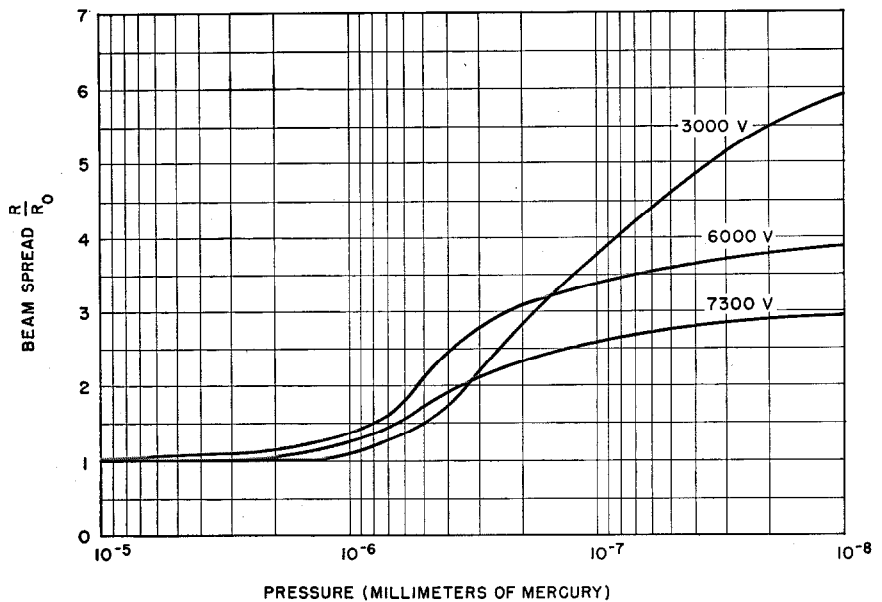

Fig. 8—Beam spread predicted from theoretical equations. Beam current = 50 milliamperes. Length = 36 centimeters. Beam-current density = 0.1 ampere per square centimeter. Compare with Fig. 1.

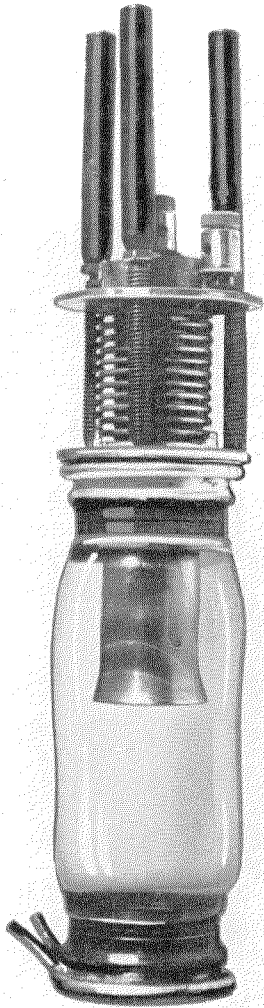

Fig. 9—Cathode structure.

was connected to the system near the middle of the drift space.

The cathode housing is shown in Fig. 9. The cathode diameter was about 1 inch, and it was moved inside of the surrounding cylinder by adjusting screws connected to a syphon bellows.

The system was continuously pumped, and was held together with metal-to-glass seals and solder-filleted joints which had to be water cooled during operation.

The accelerating electrode was a cylinder supported between glass insulating sections. The

focusing electrode was a copper cylinder connected to a heavy copper aperture as shown in Fig. 10. This picture also shows some 0.010-inch molybdenum disks with apertures which were used to test the parallel condition of the beam. This was indicated by the heating on the edges of the apertures; when the first and third apertures heated evenly and the middle aperture heated to a lesser degree, the beam was considered to be parallel near the middle aperture. This indicating method was later superseded by a system of screens of woven 0.001-inch tungsten wire which served the same function, but which was a much more sensitive indicating arrangement.

The first target used was a 0.010-inch disk of tantalum. However, the high currents and

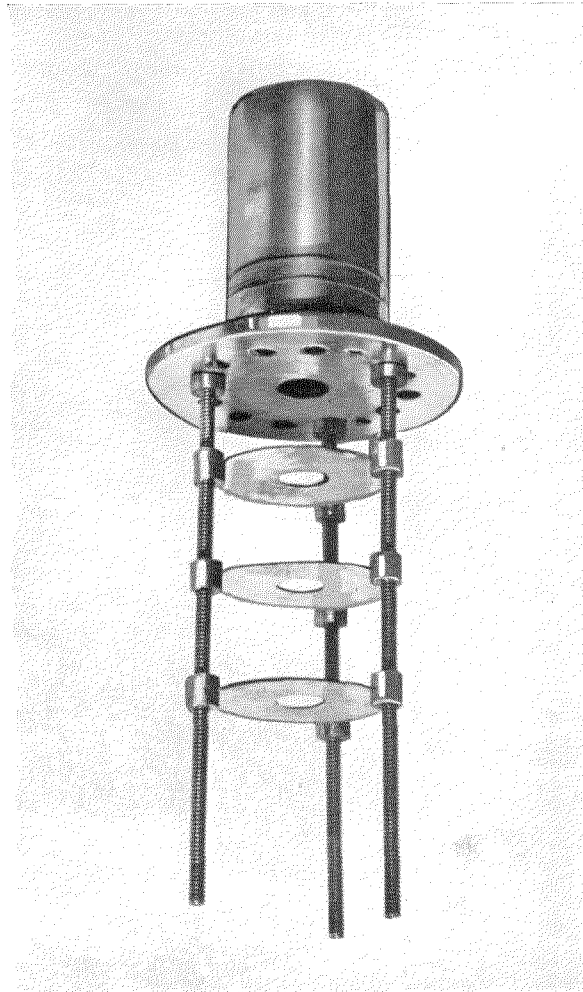

Fig. 10—Focusing electrode and molybdenum disks.

voltages used melted this target. The final arrangement consisted of a tungsten screen supported above a copper target which was cooled by circulating water (see Fig. 11).

The power-supply arrangement and connection diagram are shown in Fig. 12. The initial tungsten screens were viewed through the grill visible on the upper portion of the long copper drift tube shown in Fig. 11. This photograph shows the drift-tube assembly dismantled.

#### 4. Experimental Test of an Ion Trap

The effect of field penetration through the aperture as described in Section I may be tested quite directly, and this test has been made.

Inasmuch as the process which removes ions depends on the gradient of potential at the aperture and calculations show that very minute gradients are sufficient to carry on the process, the most certain method of stopping the process would appear to be a reversal of the gradient at

the aperture which would trap the ions in the drift space. A similar trap at the back plate would insure that ions formed in the beam would not flow out at either end and so could only leave the beam radially. Since this could happen only when the number of ions exceeds the number of electrons in the beam, the space charge of the beam would then be effectively neutralized.<sup>1</sup>

Apparatus was constructed and tested using a solid drift tube, insulated so that it could be maintained at a slight negative potential with respect to the aperture and back plate. The form of this equipment, potentials, and gradients involved are shown in Figs. 11 and 13. As a drift tube usually collects a small current of stray electrons, merely placing a resistor in an external circuit between the drift tube and the aperture can usually provide the necessary potential. Should stray-electron current prove in-

<sup>1</sup>K. Spangenberg, L. M. Field, and R. Helm, U. S. Patent Application 447 194 (1942); and L. M. Field, U. S. Patent Application 601 095 (1945).

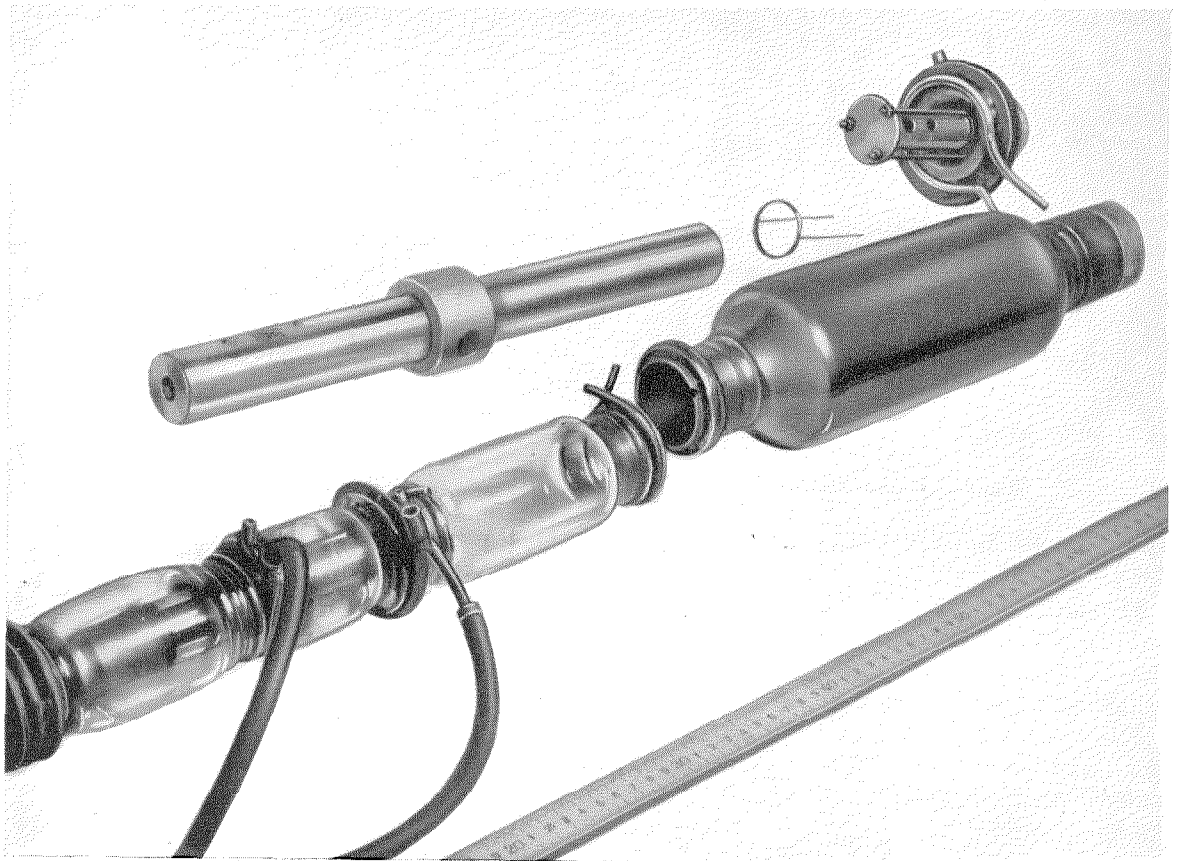

Fig. 11—Drift tube, target, and tungsten screens.

sufficient for this purpose, an auxiliary voltage supply could be used.

In a test made at a pressure of  $5 \cdot 10^{-7}$  millimeter of mercury, a beam spreading to twice its

increasing the pressure to  $5 \cdot 10^{-6}$  millimeter also served to stop the spread. Of course, increasing the pressure is impractical, for tubes are normally used as sealed-off devices; this merely demonstrated that the effect of an extremely good vacuum on ion-space-charge neutralization could be prevented by the use of an ion trap as suggested here.

It was noted in the test of ion-trap voltage just described that, for the particular beam used, 15 volts stopped practically all spreading and higher voltages produced very little increased effect. It is of interest to note that this voltage is only slightly greater than the difference in voltage between the edge and the center of the beam when it consists of unneutralized electrons only. This difference is approximately 10 volts for the beam tested.

The reason for the comparable values is evident when it is considered that on the cathode side of the aperture the ions are always removed so fast that the electron beam is essentially unneutralized. The center of the beam is then 10 volts negative with respect to the edge. Thus a negative gradient through which ions can flow will always be present until the drift-space potential is lowered by this 10 volts plus an additional voltage sufficient to reverse the gradient

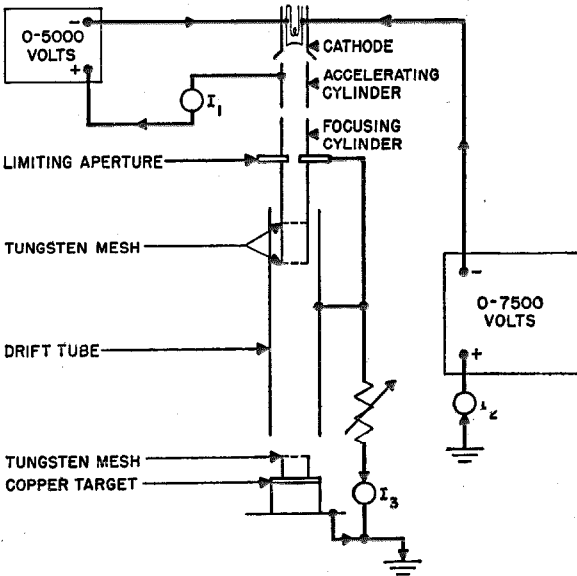

Fig. 12—Schematic diagram of apparatus.

original diameter in 36 centimeters at 7300 volts immediately stopped spreading when as little as 15 volts was applied between the drift tube and aperture in such direction as to reverse the gradient at this point. A 15-volt variation in 7300 volts would have no appreciable lens effect and this result may be considered as a verification of the importance of the aperture gradient in determining neutralization by positive ions.

Variations of beam spread with trapping voltage are given in Table III. As an auxiliary check,

TABLE III  
VARIATION OF BEAM SPREAD WITH ION-TRAP VOLTAGE

Pressure in Millimeters of Mercury	Voltages		Beam Current in Amperes	Drift Tube-to-Aperture Voltage	Spread $R/R_0$
	$V_1$	$V_2$			
$5 \cdot 10^{-7}$	1500	5800	0.130	0	2.0
$5 \cdot 10^{-7}$	1500	5800	0.130	7.5	1.2
$5 \cdot 10^{-7}$	1500	5800	0.130	15.0	1.1
$5 \cdot 10^{-7}$	1500	5800	0.130	30.0	1.0+
$1.1 \cdot 10^{-6}$	1500	5800	0.130	0	1.7
$3 \cdot 10^{-6}$	1500	5800	0.130	0	1.1
$5 \cdot 10^{-6}$	1500	5800	0.130	0	1.0+

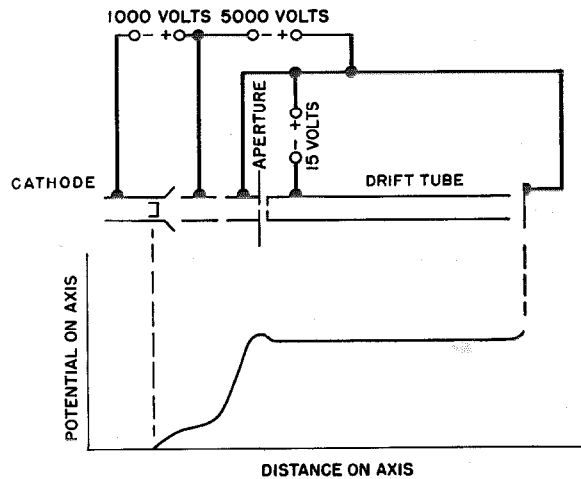

Fig. 13—Ion-trapping apparatus and potentials.

produced by field penetration. Fig. 14 illustrates the effect. Dotted lines show the potential at the center, and solid lines the potential at the edge of the beam.

Apparently the voltage difference required between the drift tube and its ends (back plate and aperture) to form an ion trap must exceed 10 volts for a 50-milliamperere 6000-volt beam. The value of trapping voltage which must be exceeded to maintain ion neutralization varies directly with the charge density, and so would increase directly as the current in the beam and vary inversely as the square root of the voltage of the beam. For beams of much higher current, the ratio of the radius of the beam to the radius of the surrounding drift tube becomes of importance.<sup>2</sup>

The use of ion traps to keep beams from spreading at high vacuum greatly extends the possible limits of operation. Electron beams up to the limiting current permissible in the presence of ions,<sup>3</sup> which is  $190 \cdot 10^{-6} V^{\frac{1}{2}}$  ampere, where  $V$  is in volts, presumably could be maintained by ion cores at even extremely good vacua (for example,  $10^{-9}$  millimeter of mercury) if sufficient volume is provided in the tube. Because an ion once in the beam cannot leave it, and as virtually no recombination takes place, it appears that most of the molecules in a given tube at very high vacuum would soon be found as ions in the beam.

When pulsing of the beam is desired, the time required for the ion core to build up is of importance. This time is independent of the amount of current in the beam, but is directly proportional to the voltage of the beam and inversely proportional to pressure as

$$T = 3.6 \cdot 10^{-15} \frac{V}{p} \text{ seconds,} \quad (15)$$

where  $T$  is the time necessary to build up an ion core to neutralize the electron beam fully, and  $V$  and  $p$  are in volts and millimeters of mercury, respectively. A typical value for a 1000-volt beam at  $p = 10^{-7}$  is 36 microseconds.

<sup>2</sup> D. P. R. Petrie, "Effect of Space Charge on the Potential and Paths of Electron Beams," *Electrical Communication*, v. 20, n. 2, pp. 100-111; 1941.

<sup>3</sup> J. R. Pierce, "Limiting Stable Current in Electron Beams in the Presence of Ions," *Journal of Applied Physics*, v. 15, n. 10, pp. 721-726; 1944.

At  $p = 10^{-6}$ , this would be reduced to 3.6 microseconds, but this is probably too high a pressure for commercial use.

Therefore, to use pulsed beams, pulses of a duration greater than the times mentioned above must be used, or some auxiliary means must be found for maintaining the ions in position between pulses. One possible method of doing this is the use of a pilot beam, of much lower voltage and somewhat lower current than the main beam, to maintain the neutral condition in the drift tube. The current necessary would decrease as the square root of the pilot-beam voltage.

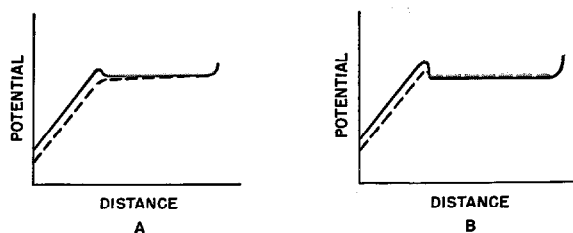

Fig. 14—Potentials at center and edge of beam during ion trapping.

It should be kept in mind that the use of the ion-trapping arrangement described here can be successful in reducing or removing space-charge repulsion effects in electron beams in field-free space only if every precaution is taken to prevent stray fields (from wall charges, insulators, nearby electrodes, or nearby conductors) from acting on the beam. Such a field causing ions to leave the beam at any point, or even tending to increase ion density in one region as compared with another, can result in the removal of virtually all ions from the beam through the affected region, with consequent failure of the ion-trapping action.

## 5. Acknowledgment

The authors wish to credit Mr. Paul Rosenbloom, formerly of the Department of Mathematics at Stanford University and now at Brown University, with the solution of equation (4) for ion flow, as presented in Section 6.1. They wish to acknowledge also his supplying of the essential method of the parametric solution given in Section 6.2.

6. Appendix

6.1 SOLUTION OF EQUATION INVOLVED IN ION FLOW

Equation (4), in Section 1, may be presented as follows:

$$f(X_0) = c \int_{x_0}^d \frac{dX}{[f(X) - f(X_0)]^{\frac{1}{2}}}. \quad (16)$$

Where  $f(X)$  is monotonically increasing to avoid an imaginary solution, we may take  $y=f(X)$  without error in the following:

Let

$$X = g(y).$$

Then

$$dX = g'(y)dy.$$

Substitute this in the above integral, and let

$$y_0 = f(X_0), L = f(d), \text{ or } d = g(L).$$

Then

$$y_0 = c \int_{y_0}^L \frac{g'(y)dy}{(y - y_0)^{\frac{1}{2}}}, \quad (17)$$

which is to be solved for  $g'(y)$ .

For the solution of this, take the formula<sup>4,5</sup>

$$\pi = \int_{y_0}^y \frac{dy_0}{[(y - y_0)(y_0 - \eta)]^{\frac{1}{2}}}.$$

Multiply through by  $g'(y)$ :

$$\pi g'(y) = \int_{\eta}^y \frac{g'(y) dy_0}{[(y - y_0)(y_0 - \eta)]^{\frac{1}{2}}}.$$

As  $g'(y)$  is constant with respect to the variable  $y_0$ , it can go under integral sign. Integrate both sides with respect to  $y$  from  $\eta$  to  $L$ ;

$$\pi [g(L) - g(\eta)] = \int_{\eta}^L dy \int_{\eta}^y \frac{g'(y) dy_0}{[(y - y_0)(y_0 - \eta)]^{\frac{1}{2}}}.$$

Change the order of integration;

$$\int_{\eta}^L dy_0 \int_{y_0}^L \frac{g'(y) dy}{[(y - y_0)(y_0 - \eta)]^{\frac{1}{2}}}.$$

For the first integration take out the term independent of  $y$ ;

$$\pi [g(L) - g(\eta)] = \int_{\eta}^L \frac{dy_0}{(y_0 - \eta)^{\frac{1}{2}}} \int_{y_0}^L \frac{g'(y) dy}{(y - y_0)^{\frac{1}{2}}}.$$

<sup>4</sup> Whittaker and Watson, "Modern Analysis," 4th Edition, Cambridge University Press, London; p. 229. Substitute  $\mu = \frac{1}{2}$ .

<sup>5</sup> Burington, "Mathematical Tables," 2nd Edition, Handbook Publishers, Inc., Sandusky, Ohio; section 158, p. 70. Take  $+\pi$ , as the integral is  $+$  everywhere.

But the second term of the product is precisely  $y_0/c$ , or the unknown function  $g$  has been taken out of the integral into an explicit form on the left.

Then,<sup>6</sup>

$$\begin{aligned} \pi [g(L) - g(\eta)] &= \frac{1}{c} \int_{\eta}^L \frac{y_0 dy_0}{(y_0 - \eta)^{\frac{1}{2}}} \\ &= \frac{1}{c} \left[ \frac{2(y_0 + 2\eta)}{3} (y_0 - \eta)^{\frac{3}{2}} \right]_{\eta}^L \end{aligned}$$

or

$$c\pi [g(L) - g(\eta)] = \frac{2(L + 2\eta)(L - \eta)^{\frac{3}{2}}}{3}.$$

As  $\eta$  is a general variable, it may be replaced by  $y$ :

$$3c\pi [g(L) - g(y)] = 2(L + 2y)(L - y)^{\frac{3}{2}}.$$

Since  $X = g(y)$ , and  $d = g(L)$ ,

$$3c\pi (d - X) = 2(L + 2y)(L - y)^{\frac{3}{2}}.$$

The solution of this equation is  $y=f(X)$ , where  $y=L$  when  $X=d$ . Only this of the three possible solutions satisfies the original integral equation. We had originally in (4),  $\rho=f(X)$ , or we may write the solution as

$$3\pi c (d - X) = 2(L + 2\rho)(L - \rho)^{\frac{3}{2}}. \quad (6)$$

6.2 MATHEMATICAL SOLUTION IN PARAMETRIC FORM

Given the solution

$$C(d - X) = (L + 2y)(L - y)^{\frac{3}{2}}, \quad (18)$$

where  $C = 3\pi c/2$ , and  $c$  is the original constant specified in the derivation in (5); and given that  $C$ ,  $d$ , and  $\left(\frac{dy}{dX}\right)_{X=0} = m$  are known, where  $m$  is the gradient at the aperture in ions per centimeter, the problem is to obtain the value of  $L$  which satisfies the equation, where  $L$  is the value of  $y$  at  $X = d$ .

Let

$$\bar{x} = C(d - X), \text{ or } \bar{x} = Cd, \quad (19)$$

if we work consistently at  $X=0$  as we do in the remainder of this work. Then,

$$\frac{d\bar{x}}{dy} = -\frac{C}{m} \text{ at } X=0. \quad (20)$$

<sup>6</sup> Reference 5; Section 61, p. 61.



Let  $M = -\frac{C}{m}$ ;

$$\begin{aligned}\bar{x}^2 &= (L+2y)^2 (L-y), \\ &= L^3(1+2v)^2 (1-v), \text{ where } v = \frac{y}{L}, \\ &= L(1+3v-4v^3).\end{aligned}\quad (21)$$

Let  $v = \cos \varphi$ ;

$$\bar{x}^2 = L^3[1 - \cos(3\varphi)] = 2L^3 \sin^2\left(\frac{3\varphi}{2}\right), \quad (22)$$

since  $-\cos(3\varphi) = (3\cos\varphi - 4\cos^3\varphi)$ .  
Now

$$L^3 = \frac{\bar{x}^2}{2 \sin^2\left(\frac{3\varphi}{2}\right)},$$

or

$$L^3 = \frac{C^2 d^2}{2 \sin^2\left(\frac{3\varphi}{2}\right)} \text{ at } X=0.$$

Then

$$L = \left(\frac{1}{2}\right)^{\frac{1}{3}} \left[ \frac{Cd}{\sin\left(\frac{3\varphi}{2}\right)} \right]^{\frac{2}{3}}, \quad (23)$$

which is the basic equation used in the numerical example in Section 2. Differentiate the first form in (22) with respect to  $y$ ;

$$2\bar{x} \frac{d\bar{x}}{dy} = 6L^3 \left[ \sin\left(\frac{3\varphi}{2}\right) \right] \left[ \cos\left(\frac{3\varphi}{2}\right) \right] \frac{d\varphi}{dy}. \quad (24)$$

But  $y = L \cos \varphi$ , so  $1 = -L \sin \varphi \frac{d\varphi}{dy}$ , or,

$$2\bar{x}M = -6L^2 \frac{\left[ \sin\left(\frac{3\varphi}{2}\right) \right] \left[ \cos\left(\frac{3\varphi}{2}\right) \right]}{\sin \varphi}.$$

Then,

$$\bar{x}^3 M^3 = -27L^6 \frac{\left[ \sin^3\left(\frac{3\varphi}{2}\right) \right] \left[ \cos^3\left(\frac{3\varphi}{2}\right) \right]}{\sin^3 \varphi}. \quad (25)$$

But from (22),

$$\bar{x}^4 = 4L^6 \sin^4\left(\frac{3\varphi}{2}\right). \quad (26)$$

Eliminating  $L^6$  between (25) and (26),

$$\frac{4M^3}{27\bar{x}} = \frac{\cos^3\left(\frac{3\varphi}{2}\right)}{\sin^3 \varphi \sin\left(\frac{3\varphi}{2}\right)}.$$

If we let

$$F(\varphi) = \frac{\cos^3\left(\frac{3\varphi}{2}\right)}{\sin^3 \varphi \sin\left(\frac{3\varphi}{2}\right)}, \quad (27)$$

we can plot  $F(\varphi)$  against  $\varphi$ . This has been done in Figs. 5 and 6.

Also,

$$F(\varphi) = -\frac{4M^3}{27\bar{x}},$$

or

$$F(\varphi) = \frac{4C^2}{27dm^3}. \quad (28)$$

This is the basic equation from which  $F(\varphi)$  is found. The value of the constant  $C$  is determined by voltage, current, and pressure in a manner shown in Section 6.3. When  $F(\varphi)$  is known, then  $\varphi$  may be found in accordance with a plot of (27). With  $\varphi$  known, the value of  $L$ , the ion density at the back plate, may be found from (23).

### 6.3 DERIVATION OF CONSTANTS

The constants of (19), (23), and (28) of Section 6.2 may be found as follows:

$$C = \frac{3\pi c}{2} = \frac{3\pi}{2} \cdot \frac{n}{K},$$

where  $n$  is the number of ions produced per second and  $K$  is the factor to multiply by the square root of the difference of the number of ions to give ion velocity in centimeters per second.

Now<sup>7</sup>

$$n = \frac{200pi}{Ve},$$

where  $p$  is in millimeters of mercury,  $i$  is in electrostatic units of current,  $V$  is in electro-

<sup>7</sup> W. H. Bennett, "Magnetically Self Focusing Streams," *Physical Review*, v. 45, n. 12, pp. 890-897; 1934.

static units of voltage, and  $e$  is in electrostatic units of charge for an electron. Or

$$n = 3.75 \cdot 10^{23} \cdot \frac{\rho i}{V},$$

where  $\rho$  is in millimeters of mercury,  $i$  is in amperes, and  $V$  is in volts.

To find  $K$ , consider

$$v = 5.97 \cdot 10^7 V^{\frac{1}{2}} \left( \frac{m_e}{m_i} \right)^{\frac{1}{2}} \text{ centimeter per second,}$$

where  $V$  is in volts, and  $m_e/m_i$  is the ratio of the mass of the electron to the mass of ions involved (assuming essentially oxygen) =  $\frac{1}{16} \times 1824$ ;

$$v = 3.49 \cdot 10^5 V^{\frac{1}{2}} \text{ centimeter per second.}$$

Or,

$$v = 6.04 \cdot 10^6 (\rho' +)^{\frac{1}{2}} \text{ centimeter per second,}$$

where  $\rho' +$  is in electrostatic units of + charge per centimeter (factor of  $\sqrt{300}$  to convert  $V$  above from volts to statvolts). Then,

$$v = 1.32 \cdot 10^2 (\rho +)^{\frac{1}{2}} \text{ centimeter per second,}$$

where  $\rho +$  is the number of + ions per centimeter (factor of  $(4.80 \cdot 10^{-10})^{\frac{1}{2}}$ , singly ionized).

Or,

$$K = 1.32 \cdot 10^2.$$

Consequently,

$$C = 1.34 \cdot 10^{22} \cdot \frac{\rho i}{V}.$$

This is the  $C$  of (18), and appears in (8).

The constant of (28) and therefore of (9) is

$$\frac{4C^2}{27 \left( \frac{1}{4.80 \cdot 10^{-10} \cdot 300} \right)^{\frac{2}{3}}},$$

where the gradient  $m$  is expressed in volts per centimeter, rather than ions per centimeter.

This is

$$7.96 \cdot 10^{22} \cdot \frac{\rho^2 i^2}{V^2}.$$

The constant of (23) and of (10) is

$$\left( \frac{C^2}{2} \right)^{\frac{1}{3}},$$

which is

$$4.47 \cdot 10^{14} \left( \frac{\rho i}{V} \right)^{\frac{2}{3}}.$$

# Telephone Statistics of the World\*

Countries	Date of Statistics	Telephones		Telephone Wire		Telegraph Wire		Conversations		Telegrams		Telephones in Large Cities		
		Thousands	Per 100 Pop.	Thousands of Miles	Per 100 Pop.	Thousands of Miles	Per 100 Pop.	Millions	Per Capita Avg.	Thousands	Per Capita Avg.	Exchange Area	Telephones Thousands	Per 100 Pop.
<b>NORTH AMERICA:</b>														
United States	Jan. 1, 1946	27867.0	21.0	110700	83.5	2260	1.7	36765	284.5	235000	1.8	New York City†	2002.3	27.8
Canada	Jan. 1, 1946	1692.2	14.4	6058	51.6	379	3.2	2980	254.7	15650	1.3	Montreal (1-1-46)	242.8	20.5
Mexico	Jan. 1, 1946	217.0	1.0	885	4.1	—	—	575	26.8	—	—	Mexico City	117.3	6.8
Cuba	Jan. 1, 1946	81.1	1.6	341	6.8	15	0.3	463	93.2	—	—	Havana	58.0	8.1
Puerto Rico	Jan. 1, 1946	25.8	1.3	76	3.7	—	—	58	28.5	—	—	—	—	—
Total	Jan. 1, 1946	30100.0	15.4	—	—	—	—	—	—	—	—	—	—	—
<b>SOUTH AMERICA:</b>														
Argentina	Jan. 1, 1946	571.0	4.0	3050	21.3	165	1.2	—	—	—	—	Buenos Aires (1-1-45)	346.7	9.7
Bolivia	Jan. 1, 1945	7.6	0.2	15	0.4	9	0.3	—	—	—	—	—	—	—
Brazil	Jan. 1, 1943	331.0	0.8	1360	3.2	114	0.3	1700	40.3	—	—	Rio de Janeiro	131.4	6.6
Chile	Jan. 1, 1946	109.5	2.0	382	7.1	—	—	369	68.8	—	—	Santiago	59.4	5.9
Colombia	Jan. 1, 1944	47.1	0.5	200	2.0	—	—	—	—	—	—	Bogota	16.5	4.1
Ecuador	Jan. 1, 1945	8.6	0.3	10	0.3	7	0.2	—	—	—	—	Quito	3.8	2.2
Paraguay	Jan. 1, 1945	4.2	0.4	11	1.0	4	0.3	—	—	—	—	—	—	—
Peru	Jan. 1, 1946	39.6	0.5	138	1.8	18	0.2	—	—	—	—	Lima (1-1-45)	26.1	4.7
Uruguay	Jan. 1, 1942	57.8	2.7	187	8.6	7	0.3	160	73.5	—	—	Montevideo	42.1	5.9
Venezuela	Jan. 1, 1942	36.1	1.0	120	3.3	8	0.2	214	58.6	—	—	Caracas	25.8	8.1
Guianas	Jan. 1, 1946	3.6	0.6	10	1.7	—	—	—	—	—	—	—	—	—
Total	Jan. 1, 1946	1290.0	1.3	—	—	—	—	—	—	—	—	—	—	—
<b>EUROPE:</b>														
Belgium	Jan. 1, 1946	379.6	4.5	—	—	—	—	289	34.3	—	—	Brussels	138.7	13.7
Bulgaria	Jan. 1, 1946	44.9	0.6	—	—	—	—	—	—	—	—	—	—	—
Denmark	Jan. 1, 1946	567.3	14.2	1630	41.0	—	—	960	241.7	—	—	Copenhagen	265.5	26.3
Eire	Jan. 1, 1946	551.1	1.9	194	6.6	20	0.7	56	19.0	2607	0.9	Dublin	31.7	6.5
Finland	Jan. 1, 1946	243.7	6.2	—	—	—	—	—	—	—	—	—	—	—
France	Jan. 1, 1946	1879.5	4.7	—	—	—	—	1358	34.2	40312	1.0	—	—	—
Great Britain	Mar. 31, 1945	3925.0	8.2	18500	38.5	—	—	—	—	—	—	—	—	—
Hungary	Jan. 1, 1944	256.9	1.7	580	3.9	—	—	340	22.8	—	—	—	—	—
Norway	Jun. 30, 1944	327.0	10.9	974	32.4	13	0.4	433	144.5	7717	2.6	Oslo (6-30-45)	95.6	22.0
Portugal	Jan. 1, 1946	97.7	1.2	210	2.6	—	—	—	—	—	—	Lisbon	42.0	5.7
Russia	Jan. 1, 1939	1272.5	0.8	2000	1.2	—	—	—	—	—	—	Moscow (1-1-36)	144.7	3.5
Spain	Jan. 1, 1946	447.2	1.6	1141	4.2	—	—	997	36.8	—	—	Madrid	95.4	7.9
Sweden	Jan. 1, 1945	1168.1	17.7	3929	59.6	8	0.1	1596	243.3	6000	0.9	Stockholm	310.5	38.4
Switzerland	Jan. 1, 1946	645.4	14.7	1950	44.3	27	0.6	543	124.0	2295	0.5	Zurich	102.6	27.4
Total	Jan. 1, 1946	16980.0	2.9	—	—	—	—	—	—	—	—	—	—	—
<b>ASIA:</b>														
British India	Jan. 1, 1946	118.6	0.03	776	0.2	413	0.1	—	—	—	—	Calcutta (3-31-45)	28.5	1.3
Total	Jan. 1, 1946	1500.0	0.1	—	—	—	—	—	—	—	—	—	—	—
<b>AFRICA:</b>														
Union of South Africa	Mar. 31, 1945	275.0	2.5	1165	10.4	19	0.2	380	34.1	9513	0.9	Johannesburg	72.1	11.0
Total	Jan. 1, 1946	430.0	0.2	—	—	—	—	—	—	—	—	—	—	—
<b>OCEANIA:</b>														
Australia	Jun. 30, 1944	799.7	10.9	3670	50.2	200	2.7	715	98.4	34721	4.8	—	—	—
Hawaii	Jan. 1, 1946	69.0	13.8	201	40.3	—	—	—	—	—	—	Honolulu	39.1	18.2
New Zealand	Mar. 31, 1946	265.8	15.6	—	—	—	—	—	—	—	—	—	—	—
Total	Jan. 1, 1946	1200.0	1.1	—	—	—	—	—	—	—	—	—	—	—
<b>TOTAL WORLD</b>	Jan. 1, 1946	51500.0	2.2	—	—	—	—	—	—	—	—	—	—	—

\* Compiled by Chief Statistician's Division, American Telephone and Telegraph Company, and issued under date of September 10, 1946. Owing to conditions resulting from the war, official data for recent dates are not available for many countries. The above statistics were the latest available from authentic sources, on August 31, 1946. Totals for the world and geographical areas are partly estimated.

Grateful acknowledgment is hereby made of the courteous cooperation in the preparation of these statistics given by officials of private and governmental telephone and telegraph organizations and by representatives of the United States Departments of State and Commerce.

† The telephone development (telephones expressed in thousands) of other representative cities in the United States was, on January 1, 1946:

Chicago, Ill.	1204.5	telephones,	or 34.5	per 100	population	Milwaukee, Wis.	215.6	telephones,	or 27.2	per 100	population
Los Angeles, Cal.	591.0	"	" 32.4	"	"	Minneapolis, Minn.	198.2	"	" 35.8	"	"
Cleveland, Ohio	375.0	"	" 31.2	"	"	Seattle, Wash.	190.3	"	" 33.2	"	"
Washington, D. C.	364.4	"	" 39.9	"	"	Denver, Col.	134.7	"	" 36.4	"	"
San Francisco, Cal.	344.0	"	" 43.3	"	"	Hartford, Conn.	90.8	"	" 33.8	"	"
Boston, Mass.	232.0	"	" 33.2	"	"	Omaha, Neb.	84.3	"	" 31.2	"	"

## C.C.I.F. Honors Two Pioneers

**A**T THE 14th Plenary Assembly of the Comité Consultatif International Téléphonique (C.C.I.F.) at Montreux, Switzerland, on October 26, 1946, Mr. S. Rynning-Tønnessen, Director-General of the Norwegian Telegraph Administration, proposed the election as Honorary Members of Dr. A. Muri, former Director-General of the Swiss Posts, Telegraphs, and Telephones, and Sir Frank Gill, Chairman of the Board of Standard Telephones and Cables Ltd.

Mr. Rynning-Tønnessen said that some of the founders of the C.C.I.F. were still active, and in behalf of their colleagues and friends he wished to express respect, appreciation, and thanks to two of these pioneers, Sir Frank Gill and Dr. Muri.

Dr. Muri had attended most of the meetings, and has been greatly honored for his eminent skill and for his broadminded and tactful handling of C.C.I.F. questions and personalities. Sir Frank Gill has been honored in the many countries where he has interested himself in the

peoples and their problems. He has been in a leading position in telephony for about 50 years, and has been concerned with all the problems of international telephony. It was largely due to his efforts that the Comité Consultatif International Téléphonique was formed, and he is still as enthusiastic as he was 25 years ago. The younger generation, consequently, wished to show these two gentlemen, in some way, how much they appreciated them. He therefore proposed that the 14th Plenary Assembly elect them as Honorary Members.

The proposal having been received with acclamation, Dr. F. Hess, Director-General of the Swiss Posts, Telegraphs, and Telephones, and President of the 14th Plenary Assembly, said that the warm applause of the delegates showed the unanimity of their desire to elect Sir Frank Gill and Dr. Muri as Honorary Members of the Comité Consultatif International Téléphonique. He cordially congratulated them both in the name of the Assembly.

---

## Recent Telecommunication Developments

**B**ELL TELEPHONE MANUFACTURING COMPANY MAKES FIRST SERVICE AWARDS SINCE 1938—The annual service awards dinners, at which Bell Telephone Manufacturing Company, Antwerp, recognizes those employees who have served the company for 25 years or longer, were interrupted after 1938 by the war. On September 7, 1946, the tradition was resumed to honor 437 employees at a dinner in the famous Antwerp Bourse, or stock exchange, in which only outstanding State functions are held.

His Excellency C. Huysmans, Prime Minister of Belgium; His Excellency E. Rongvaux, Minister of Communications; Mr. Malderez, Secretary General of the Communications Ministry; Mr. K. Peeters, Head of the Cabinet of the Ministry of Labor and Social Security; Mr. J. Caers, Director General of the Labor Ministry, and Mr. W. Eekeleers, Deputy Burgomaster of Antwerp, represented the Government.

The Belgium Government decorates persons who have served industry continuously for 25 years or more, and awards were conferred on those who have completed such service since 1938: 25 Golden Palms and 35 Golden Medals of the Order of the Crown for 45 and 40 years, respectively, of service; 7 Golden Medals of the Order of Leopold II, 35 years; and Industrial Decorations numbering 103 to Workmen for 35 years, 205 for 25 years; and 62 to Clerks for 30 years.

Managing Director Leo Van Dyck, wearer of the Order of the Crown, and his staff of department heads awarded breloques to 349 employees who completed their 25th years during the war. These Bell Telephone Company awards, worn as watch charms by men and on necklaces by women, are a badge of industrial distinction.



**R.** *M.S. QUEEN ELIZABETH* SETS TRAFFIC RECORD—In October, 1946, on her maiden voyage as a luxury liner from Southampton to New York and return, *R.M.S. Queen Elizabeth* handled a total of 131 600 words of passenger and press radiotelegraph traffic to stations on both sides of the Atlantic, often to East and West simultaneously. Both manual and automatic transmission using speeds up to 100 words per minute were employed.

An all-time record for the highest volume of private radiotelegraph traffic exchanged by any one ship with Great Britain was established on the outward voyage, lasting less than five days, when 66 306 words were passed through British Post Office shore wireless stations. This exceeded the previous record of 48 004 words held by *R.M.S. Queen Mary*.

At the same time, 607 radiotelephone calls were put through to and from telephone subscribers in various countries, including South Africa and Australia. Also, 32 separate programs

were transmitted to broadcasting systems throughout the world.

In addition to the above figures there was, of course, the large number of words transmitted and received in normal navigational messages and as "copy" for the daily newspapers published on board.

International Marine Radio Company (London) installed and operates the radio equipment on the *Queen Elizabeth* which for six years before her introduction to peacetime travelers was constantly engaged in transporting war personnel and supplies.

• • •

**V**ACUUM CAPACITORS—Fixed capacitors for use in high-frequency transmitters of high power are now available from Federal Telephone and Radio Corporation. The electrodes consist of two coaxial copper cylinders mounted on ring seals similar to those used in some high-power vacuum tubes. A glass envelope and ends complete the enclosure which is evacuated.

Capacitors are made in 50- and 100-micro-microfarad sizes within tolerances of  $\pm 5$  percent. For special purposes, larger capacitances and closer tolerances can be provided. Both are rated at a maximum peak value of 55 kilovolts and a root-mean-square current of 120 amperes.

With increasing frequency, the maximum permissible current usually limits the voltage that may be applied to a capacitor, resulting in the following ratings for these designs.

Peak Rating in Kilovolts	Frequency in Megacycles	
	50 $\mu\text{mf}$	100 $\mu\text{mf}$
20	50	33
40	25	16
55	18	12

Physically, the units are interchangeable, each being 15 inches tall and 6 inches in maximum diameter.

## Contributors to This Issue



V. BELEVITCH

VITOLD BELEVITCH was born at Helsingfors, Finland, on March 2, 1921. He studied until July, 1936, at the Notre-Dame de la Paix College at Namur. He then followed an engineering course at the University of Louvain and graduated in 1942 with an engineering degree.

Employed by the Bell Telephone Manufacturing Company at Antwerp in October, 1942, in the transmission department, he undertook various studies relating in particular to special transmission problems. In October, 1945, he received a doctor's degree in applied science from the University of Louvain.

. . .

E. M. DELORAINÉ was born in Paris, France, on May 16, 1898. He received the B.S. degree, the Certificat de Mathématiques in 1918, and of Ingé-

nieur diplômé de L'école de Physique et Chimie, a branch of Paris University, in 1920.

In 1917 he joined the French Army Signal Corps, and later engaged in research work at the Eiffel Tower. He became associated with the London engineering staff of the International Western Electric Company in 1921 and began technical work in connection with broadcasting at the experimental station 2WP. Until 1925 he was responsible for part of the developments in Great Britain in connection with the first transatlantic telephone circuit. He was made European technical director of International Standard Electric Corporation in 1933. From 1931 to 1937, Mr. Delorainé made important contributions in the development of ultra-high frequencies. He was also active in the advancement of high-power broadcasting, and established the Prague station with 120 kilowatts carrier, followed by the Budapest station. Mr. Delorainé was also successful in directing experiments in connection with automatic radio compasses for aircraft.

Mr. Delorainé came to the United States in 1941 to take charge of the organization of the laboratories unit for the Federal Telephone and Radio Corporation. In 1945, he was appointed president of International Telecommunication Laboratories, Inc. and in 1946 technical director of the International Telephone and Telegraph Corporation.

Mr. Delorainé was made a Chevalier of the Legion of Honor in 1938 for exceptional services to the Posts and Telegraphs Department of France, and he was elected vice-president of the French Institute of Radio Engineers in 1939. He has been a member of the International Consultative Committee of Long Distance Telephony since 1927, and is also a member of the French Astronomical Society. Mr. Delorainé is a fellow of the Institute of Radio Engineers and was its vice-president for 1946.



E. M. DELORAINÉ



JAMES S. ENGEL

JAMES S. ENGEL was born in Brooklyn, New York, on November 18, 1920. He received the B.Sc. degree in electrical engineering in 1942 from Massachusetts Institute of Technology. Since 1942, he has been engaged in engineering work on aerial navigation equipment for Federal Telephone and Radio Corporation.

Mr. Engel holds associate memberships in the Institute of Radio Engineers and the American Institute of Electrical Engineers.

. . .

LEONARD EVERETT was born on October 5, 1908 in Shanghai, China. He received from Stanford University an A.B. degree in engineering in 1931 and the E.E. degree in 1933.

From 1934 to 1940, he was employed as a sales engineer by the China Elec-



LEONARD EVERETT

. . .

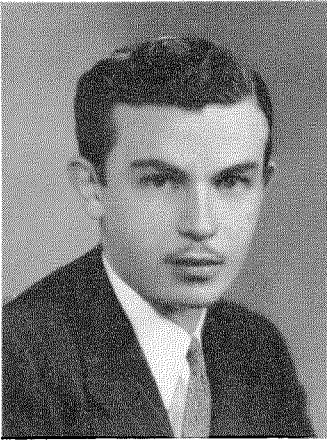

LESTER M. FIELD

tric Company, Ltd. in Hong Kong and Shanghai. The following year was spent as a radio engineer for the Intercontinent Corporation in Rangoon, Burma.

In March, 1942, he returned to the U.S.A. and joined the engineering staff of Federal Telephone and Radio Corporation.

Mr. Everett is a senior member of the Institute of Radio Engineers.

• • •

LESTER M. FIELD was born on February 9, 1918, at Chicago, Illinois. He received the B.S. degree from Purdue University in 1939, and the Ph.D. degree from Stanford University in 1944.

He was acting instructor in 1941, and acting assistant professor from 1942 to 1944 in electrical engineering at Stan-

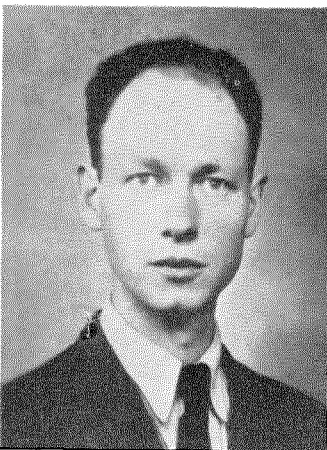

A. FROMAGEOT

ford University. In 1944, he joined Bell Telephone Laboratories as a member of the magnetron development group and later the electron dynamics group of the physical research department. In September, 1946, Dr. Field returned to Stanford University as acting associate professor of electrical engineering.

He is a member of the American Physical Society, Tau Beta Pi, and an associate member of Sigma Xi.

• • •

ANTOINE FROMAGEOT was born on October 27, 1910, in Paris, France. He studied at the Ecole Polytechnique until 1932. In 1934, he received the degree of electrical engineer at the Ecole Supérieure d'Electricité (Paris), and spent the next year at the Cavendish Laboratory of Cambridge University.

Mr. Fromageot joined the Société Anonyme Lignes Télégraphiques et Téléphoniques in 1936; he was later placed in charge of development work related to coaxial and 12-channel carrier cables. In 1943, he was transferred to the Laboratoire Central de Télécommunications, where he is now directing development work on carrier telephony.

• • •

ROBERT HELM was born in Topeka, Kansas, on March 23, 1919. Stanford University conferred on him the A.B. degree in electrical engineering in 1940, and the E.E. degree in 1942.

After serving for a part of 1942 on the staff of Litton Engineering Laboratories, he became an engineer in the vacuum-tube division of Federal Telephone and Radio Corporation. In 1944, he rejoined Litton Engineering Laboratories as a research engineer on vacuum tubes.

Mr. Helm is a member of Sigma Xi, Phi Beta Kappa, Tau Beta Phi, and Kappa Sigma.

• • •

F. J. MANN was born in Hoboken, New Jersey, on April 27, 1906. He received the B.S. degree from Middlebury College in 1933. Postgraduate studies were in communications and



F. J. MANN

journalism, the latter at Columbia University School of Journalism.

From 1925 to 1927, he was on the staff of *Radio Broadcast* magazine. In 1928, he was appointed radio editor of *Science and Invention*. He served as a marine radio operator before completing college and after his post-graduate work he became a radio operator at broadcast station WCAX in Burlington, Vermont. From 1934 to 1940, he was engaged in newspaper work and freelance writing. Mr. Mann then became assistant to the director of technical publications of Bendix Radio.

Joining the *Electrical Communication* staff as a writer in 1942, he is now managing editor of the publication and assistant editor of the handbook, *Reference Data for Radio Engineers*.



A. A. NEW

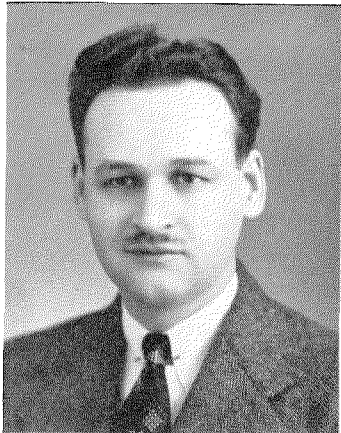

BENJAMIN PARZEN

BENJAMIN PARZEN was born on April 5, 1913 in Poland. He received the B.S. degree in engineering from the College of the City of New York in 1936.

During 1936 and 1937, he was a radio inspector for the Federal Communications Commission. From 1938 to 1944, he served as a civilian engineer for the United States Navy. He joined Federal Telecommunication Laboratories in 1944 and is now a senior engineer.

Mr. Parzen is a member of the American Institute of Electrical Engineers and is licensed as a professional engineer by New York State.

• • •

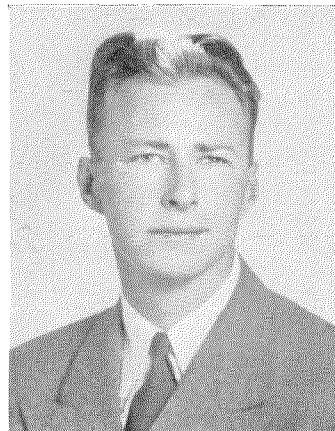

KARL R. SPANGENBERG

HARADEN PRATT was born in San Francisco, California, on July 18, 1891. He received a B.S. degree from the University of California in 1914.

Starting his radio career as an amateur in 1906, Mr. Pratt became a commercial operator and installer for United Wireless Telegraph Company and Marconi Wireless Telegraph Company before completing his college training. After receiving his degree, he was engaged as an engineer by the Marconi Company.

From 1915 to 1920, he served as expert radio aide, U.S. Navy. From 1920 to 1923, he was an engineer for Federal Telegraph Company. He served Western Air Express on communication problems from 1925 to 1927 and during the following year was with the National Bureau of Standards.

In 1928, Mr. Pratt became chief engineer of Mackay Radio and Telegraph



HARADEN PRATT

Company. He is now vice president, chief engineer, and a director of that company; vice president and chief engineer of American Cable and Radio Corporation, of All America Cables and Radio, Incorporated, and of Commercial Cable Company; vice president and a director of Federal Telephone and Radio Corporation and of Federal Telecommunication Laboratories; and a director of International Telecommunication Laboratories.

The Institute of Radio Engineers presented its Medal of Honor to Mr. Pratt in 1944. He served as its president in 1938, as treasurer in 1941 and 1942, and as secretary from 1943 to date.

He is a fellow of the Institute of Radio Engineers and of the American Institute of Electrical Engineers.

Since 1927, he has attended a number of the major international conferences on radio.

• • •

KARL R. SPANGENBERG was born at Cleveland, Ohio, on April 9, 1910. He received the B.S. degree in electrical engineering in 1932, and the M.S. degree in electrical engineering in 1933, both from Case School of Applied Science; and the Ph.D. degree from Ohio State University in 1937.

Since 1937, Dr. Spangenberg has been a member of the faculty of the electrical engineering department of Stanford University, where he now holds the rank of professor of electrical

• • •

Mr. Mann is a member of the honorary journalism fraternity, Pi Delta Epsilon, and of the Institute of Radio Engineers.

• • •

A. A. NEW received from Leeds University the B.Sc. degree in chemistry in 1922, B.Sc. Hons. in colour chemistry in 1923, and the M.Sc. degree in 1924.

He joined Standard Telephones and Cables in 1924 to do research on dyeing of yarn used for electrical purposes and later studied insulating oils. He was senior assistant chemist in the chemical laboratory at Woolwich in 1930 when he was transferred to research on fibrous dielectrics and placed in charge of optical work in the combined chemical, physical, and metallurgical laboratory, later known as the materials laboratory, of which he was appointed head in 1937. In 1946, he was transferred to Standard Telecommunication Laboratories in the same capacity.

Mr. New is a fellow of the Royal Institute of Chemistry and of the Chemical Society, an associate of the Institute of Physics, and holds memberships in the Society of the Chemical Industry, Textile Institute, Society of Dyers and Colourists, Ceramic Society, and British Rheologists Club.





ARTHUR VAN DYCK

engineering. During the war he was granted a leave of absence from Stanford University to serve as consultant to the Signal Corps and to work at the Radio Research Laboratory.

He is a member of the Institute of Radio Engineers, Tau Beta Pi, and Sigma Xi.

• • •

ARTHUR VAN DYCK received from Yale University in 1911 a Ph.B. degree in electrical engineering.

He served on the engineering staffs of the National Electric Signalling Company, Westinghouse Electric and Manufacturing Company, and the Carnegie Institute of Technology. During World War I, he was expert radio aide for the United States Navy.

Since 1919, he has been with the Marconi Company and its successor, Radio Corporation of America, where he is assistant to the executive vice president in charge of the laboratories division. From 1943 to 1946, he served as Commander, U.S.N.R.

Mr. Van Dyck was awarded the Legion of Merit and the Naval Reserve Medal. He is a fellow and past president of the Institute of Radio Engineers, a fellow of the Radio Club of America, and a member of the Veteran Wireless Operators Association.

• • •

E. P. G. WRIGHT joined the equipment engineering branch of the Western Electric Company in London in 1920, and in 1926 took charge of project engineering when the company became associated with the I.T.&T. System. In 1928, Mr. Wright was transferred to the I.T.&T. laboratories to work on switching problems. He was placed in charge of switching-system design for Standard Telephones and Cables in 1932 until the war when he was assigned to special duties on radio production and test-equipment design.

Mr. Wright served as a member of the British Telephone Technical Development Committee from its inception until 1939. He is a member of the



E. P. G. WRIGHT

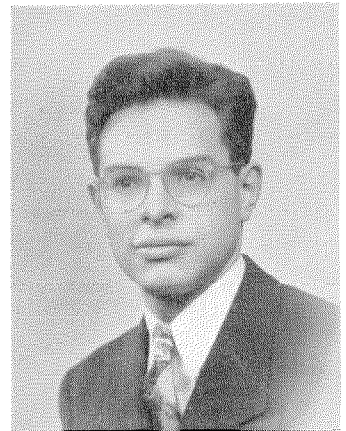

A. AARON YALOW

Institution of Electrical Engineers and was awarded the Fahie Premium for papers on the bypath system and voice-frequency signalling and dialling.

• • •

A. AARON YALOW was born in Syracuse, New York, on September 18, 1919. He received an A.B. degree, magna cum laude, from Syracuse University in 1939. The University of Illinois granted him an M.S. degree in 1942 and a Ph.D. in physics in 1945.

He served as a graduate assistant in physics at the University of Syracuse from 1939 to 1941, and at the University of Illinois during the following academic year. He then held a fellowship in physics until 1945.

Mr. Yalow joined the engineering staff of Federal Telecommunication Laboratories in 1945 and in 1946 became a physicist in the department of medical physics of Montefiore Hospital in New York City.

He is a member of the American Physical Society, Sigma Xi, Phi Beta Kappa, Sigma Pi Sigma, and Pi Mu Epsilon.

# INTERNATIONAL TELEPHONE AND TELEGRAPH CORPORATION

## Associate Manufacturing and Sales Companies

### UNITED STATES OF AMERICA

INTERNATIONAL STANDARD ELECTRIC CORPORATION, New York, New York

FEDERAL TELEPHONE AND RADIO CORPORATION, Newark, New Jersey

### GREAT BRITAIN AND DOMINIONS

STANDARD TELEPHONES AND CABLES, LIMITED, London, England

Branch Offices: Birmingham, Leeds, Manchester, England; Glasgow, Scotland; Dublin, Ireland; Cairo, Egypt; Calcutta, India; Johannesburg, South Africa.

CRED AND COMPANY, LIMITED, Croydon, England

INTERNATIONAL MARINE RADIO COMPANY LIMITED, Liverpool, England

KOLSTER-BRANDS LIMITED, Sidcup, England

STANDARD TELEPHONES AND CABLES PTY. LIMITED, Sydney, Australia

Branch Offices: Melbourne, Australia; Wellington, New Zealand.

SILOVAC ELECTRICAL PRODUCTS PTY. LIMITED, Sydney, Australia

NEW ZEALAND ELECTRIC TOTALISATORS LIMITED, Wellington, New Zealand

FEDERAL ELECTRIC MANUFACTURING COMPANY, LTD., Montreal, Canada

### SOUTH AMERICA

COMPAÑIA STANDARD ELECTRIC ARGENTINA, SOCIEDAD ANÓNIMA, INDUSTRIAL Y COMERCIAL, Buenos Aires, Argentina

STANDARD ELECTRICA, S.A., Rio de Janeiro, Brazil

COMPAÑIA STANDARD ELECTRIC, S.A.C., Santiago, Chile

### EUROPE AND FAR EAST

VEREINIGTE TELEFON- UND TELEGRAFEN-WERKE AKTIENGESELLSCHAFT, Vienna, Austria

BELL TELEPHONE MANUFACTURING COMPANY, Aalst, Belgium

CHINA ELECTRIC COMPANY, LIMITED, Shanghai, China

STANDARD ELECTRIC DOMS A SPOLECNOST, Prague, Czechoslovakia

STANDARD ELECTRIC AKTIESELSKAB, Copenhagen, Denmark

COMPAGNIE GÉNÉRALE DE CONSTRUCTIONS TÉLÉPHONIQUES, Paris, France

LE MATÉRIEL TÉLÉPHONIQUE, Paris, France

LES TÉLÉIMPRIMEURS, Paris, France

LIGNES TÉLÉGRAPHIQUES ET TÉLÉPHONIQUES, Paris, France

FERDINAND SCHUCHHARDT BERLINER FERNSPRECH- UND TELEGRAPHENWERK AKTIENGESELLSCHAFT, Berlin, Germany

LORENZ, C., A.G. AND SUBSIDIARIES, Berlin, Germany

MIX & GENEST AKTIENGESELLSCHAFT AND SUBSIDIARIES, Berlin, Germany

SÜDDEUTSCHE APPARATEFABRIK GESELLSCHAFT M.B.H., Nuremberg, Germany

TELEPHONFABRIK BERLINER A.G. AND SUBSIDIARIES, Berlin, Germany

NEDERLANDSCHE STANDARD ELECTRIC MAATSCHAPPIJ N.V., Hague, Holland

DIAL TELEFONKEBESKEDELMI RÉSZVÉNY TÁRSASÁG, Budapest, Hungary

STANDARD VILLAMOSÁGI RÉSZVÉNY TÁRSASÁG, Budapest, Hungary

TELEFONGYÁR R.T., Budapest, Hungary

FABBRICA APPARECHIATURE PER COMUNICAZIONI ELETTRICHE, Milan, Italy

STANDARD ELECTRICA ITALIANA, Milan, Italy

SOCIETA ITALIANA RETI TELEFONICHE INTERURBANE, Milan, Italy

NIPPON ELECTRIC COMPANY, LIMITED, Tokyo, Japan

SUMITOMO ELECTRIC INDUSTRIES, LIMITED, Osaka, Japan

STANDARD TELEFON- OG KABELFABRIK A/S, Oslo, Norway

STANDARD ELECTRIC COMPANY W. POLSCE SP. Z.O.O., Warsaw, Poland

STANDARD ELECTRICA, Lisbon, Portugal

STANDARD FABRICA DE TELEFOANE SI RADIO S.A., Bucharest, Rumania

COMPAÑIA RADIO AEREA MARITIMA ESPAÑOLA, Madrid, Spain

STANDARD ELÉCTRICA, S.A., Madrid, Spain

AKTIEBOLAGET STANDARD RADIOFABRIK, Stockholm, Sweden

STANDARD TELEPHONE ET RADIO S.A., Zurich, Switzerland

JUGOSLAVENSKO STANDARD ELECTRIC COMPANY AKCIONARNO DRUSTVO, Belgrade, Yugoslavia

TELEOPTIK A.D., Belgrade, Yugoslavia

## Telephone Operating Systems

COMPAÑIA TELEFÓNICA ARGENTINA, Buenos Aires, Argentina

COMPAÑIA TELEGRÁFICO-TELEFÓNICA COMERCIAL, Buenos Aires, Argentina

COMPAÑIA TELEGRÁFICO-TELEFÓNICA DEL PLATA, Buenos Aires, Argentina

COMPANHIA TELEFONICA PARANAENSE S.A., Curitiba, Brazil

COMPANHIA TELEFONICA RIO GRANDENSE, Porto Alegre, Brazil

COMPAÑIA DE TELÉFONOS DE CHILE, Santiago, Chile

COMPAÑIA TELEFÓNICA DE MAGALLANES S.A., Punta Arenas, Chile

CUBAN TELEPHONE COMPANY, Havana, Cuba

MEXICAN TELEPHONE AND TELEGRAPH COMPANY, Mexico City, Mexico

COMPAÑIA PERUANA DE TELÉFONOS LIMITADA, Lima, Peru

PORTO RICO TELEPHONE COMPANY, San Juan, Puerto Rico

SHANGHAI TELEPHONE COMPANY, FEDERAL, INC., U.S.A., Shanghai, China

## Radiotelephone and Radiotelegraph Operating Companies

COMPAÑIA INTERNACIONAL DE RADIO, Buenos Aires, Argentina

COMPAÑIA INTERNACIONAL DE RADIO BOLIVIANA, La Paz, Bolivia

COMPANHIA RADIO INTERNACIONAL DO BRASIL, Rio de Janeiro, Brazil

COMPAÑIA INTERNACIONAL DE RADIO, S.A., Santiago, Chile

RADIO CORPORATION OF CUBA, Havana, Cuba

RADIO CORPORATION OF PORTO RICO, San Juan, Puerto Rico†

† Radiotelephone and Radio Broadcasting services.

## Cable and Radio Telegraph Operating Companies

(Controlled by American Cable & Radio Corporation)

THE COMMERCIAL CABLE COMPANY, New York, New York<sup>1</sup>

MACKEY RADIO AND TELEGRAPH COMPANY, New York, New York<sup>2</sup>

ALL AMERICA CABLES AND RADIO, INC., New York, New York<sup>3</sup>

THE CUBAN ALL AMERICA CABLES, INCORPORATED, Havana, Cuba<sup>1</sup>

SOCIEDAD ANÓNIMA RADIO ARGENTINA, Buenos Aires, Argentina<sup>4</sup>

<sup>1</sup> Cable service. <sup>2</sup> International and Marine Radiotelegraph services. <sup>3</sup> Cable and Radiotelegraph services. <sup>4</sup> Radiotelegraph service.

## Laboratories

INTERNATIONAL TELECOMMUNICATION LABORATORIES, INC., New York, New York

FEDERAL TELECOMMUNICATION LABORATORIES, INC., New York, New York

STANDARD TELECOMMUNICATION LABORATORIES LTD., London, England

LABORATOIRE CENTRAL DE TÉLÉCOMMUNICATIONS, Paris, France