



# ELECTRICAL COMMUNICATION

*Technical Journal of the*  
INTERNATIONAL TELEPHONE AND TELEGRAPH CORPORATION  
*and Associate Companies*

TUBES FOR HIGH-POWER SHORT-WAVE BROADCAST STATIONS—  
THEIR CHARACTERISTICS AND USE

IN MEMORIAM—COLONEL WILLIAM F. REPP

AIRCRAFT ELECTRIC POWER SUPPLY SYSTEM

PHYSICS AND THE STATIC CHARACTERISTICS OF HARD VACUUM TUBES

AUDIO AND MEASURING FACILITIES FOR THE CBS  
INTERNATIONAL BROADCAST STATIONS

THE POLYMERIZATION OF STYRENE AND SOME CONCEPTS OF THE  
ELECTRICAL PROPERTIES OF PLASTICS

THE MEASURED CHARACTERISTICS OF SOME ELECTROSTATIC  
ELECTRON LENSES

REFERENCE DATA FOR RADIO ENGINEERS

RECENT TELECOMMUNICATIONS DEVELOPMENTS

1943

VOL. 21

No. 3



# ELECTRICAL COMMUNICATION

Technical Journal of the  
INTERNATIONAL TELEPHONE AND TELEGRAPH CORPORATION  
and Associate Companies

H. T. KOHLHAAS, Editor

EDITORIAL BOARD

H. Busignies    H. H. Buttner    G. Deakin    E. M. Deloraine    Sir Frank Gill    W. Hatton  
E. S. McLarn    Frank C. Page    H. M. Pease    E. D. Phinney    Haraden Pratt

Published Quarterly by the

*International Standard Electric Corporation*

67 BROAD STREET, NEW YORK, N.Y., U.S.A.

H. M. Pease, President

C. D. Hilles, Jr., Secretary

Subscription, \$3.00 per year; single copies, 75 cents

Volume 21

1943

Number 3

## CONTENTS

|   | PAGE |
|---|------|
| TUBES FOR HIGH-POWER SHORT-WAVE BROADCAST STATIONS—<br>THEIR CHARACTERISTICS AND USE .....        | 143  |
| <i>By G. Chevigny</i>   |      |
| IN MEMORIAM—COLONEL WILLIAM F. REPP .....   | 157  |
| AIRCRAFT ELECTRIC POWER SUPPLY SYSTEM .....   | 159  |
| <i>By John E. Yarmack</i>   |      |
| PHYSICS AND THE STATIC CHARACTERISTICS OF HARD VACUUM<br>TUBES .....                              | 167  |
| <i>By J. H. Fremlin</i>   |      |
| AUDIO AND MEASURING FACILITIES FOR THE CBS INTERNATIONAL<br>BROADCAST STATIONS .....              | 174  |
| <i>By Howard A. Chinn</i>   |      |
| THE POLYMERIZATION OF STYRENE AND SOME CONCEPTS OF THE<br>ELECTRICAL PROPERTIES OF PLASTICS ..... | 180  |
| <i>By A. J. Warner</i>  |      |
| THE MEASURED CHARACTERISTICS OF SOME ELECTROSTATIC ELEC-<br>TRON LENSES .....                     | 194  |
| <i>By Karl Spangenberg and Lester M. Field</i>  |      |
| REFERENCE DATA FOR RADIO ENGINEERS .....  | 205  |
| <i>By H. H. Buttner</i>   |      |
| RECENT TELECOMMUNICATIONS DEVELOPMENTS .....  | 207  |

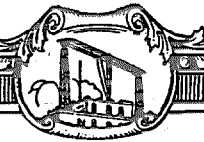



NEW VACUUM TUBE PLANT OF THE FEDERAL TELEPHONE AND RADIO CORPORATION AT NUTLEY-CLIFTON, NEW JERSEY. DUE TO HEAVY WAR DEMANDS, F. T. & R. IS NOW MANUFACTURING ITS PRODUCTS IN THIRTY-THREE SEPARATE LOCATIONS IN THE NEWARK, NEW JERSEY AREA.

# Tubes for High-Power Short-Wave Broadcast Stations—Their Characteristics and Use\*

By G. CHEVIGNY

*Federal Telephone and Radio Laboratories, New York, N. Y.*

*This paper outlines the vacuum-tube requirements necessary because of the increasing power of short-wave broadcast transmitters.*

*Different ways of meeting the requirements are discussed: use of a large number of tubes in parallel; of demountable structures; or of sealed tubes.*

*The development of a sealed tube capable of 200 kilowatts carrier output for two tubes in parallel is described. The main features of the different parts of the tube are indicated together with its characteristics. A description is also given of some of the tools and machines specially developed for the manufacture of these tubes.*

*A broadcast center in which the tubes are used is briefly described. The salient points of the transmitting circuit and equipment are shown. A short description of high-power grid-controlled rectifiers is also given.*

## Introduction

FOR years before the present War, there was a very rapid increase in the power of broadcast transmitters in Europe, brought about mainly by the importance attached to propaganda by radio. Despite limitations on power recommended by successive international meetings, the governments of European countries always tried to increase the emission of their broadcast transmitters as much as technically possible. As soon as progress in the manufacture of transmitting tubes and equipment made it possible to obtain a higher output, new stations were ordered or old stations were modernized so that the only limit to the power output of a station was, in fact, that imposed by the technical possibilities of the moment.

This race toward higher powers, which took place at first on medium waves, was followed by a similar race on short waves. For instance, transmitters of 100 kilowatts carrier or more started regular operation on medium waves in 1931 and on short waves in 1939. The high output power of stations was often supplemented by efficient radiating systems, some of which were over 1000 feet high for medium-wave broadcasting, or which used large numbers of highly directive antennas for short-wave broadcasting.

As the demand toward still larger powers was quite apparent, development of a new type of high-power, short-wave vacuum tube was started in 1937 at the Paris Laboratory of the International Telephone and Telegraph Corporation.

Two years later, in 1939, design of this tube had been completed and it was available when, in the same year, French authorities decided to build a broadcast center with a large number of short-wave channels each capable of a carrier of 150 to 200 kilowatts.

## General Considerations

Before starting the design of the new tube, several different methods of meeting the requirements were considered.

1. Use of a large number of high-power tubes connected in parallel.
2. Development of new demountable structures of suitable power.
3. Development of a sealed tube of sufficient power output so that two tubes would be adequate in the last stage.

A solution using four tubes in parallel had already been adopted for certain high-power transmitters; however, because of the many drawbacks, parallel operation was not considered entirely satisfactory for the following reasons:

1. Operation of the transmitter is made more difficult.
2. Critical adjustment of the circuits is necessary, particularly when two transmitters must be worked in parallel.
3. Causes of stoppage of the station are considerably increased, making the station much less reliable.

Demountable structures were rejected, although, from the standpoint of power output,

\* Paper presented at the New York Section I.R.E., March 3, 1943; reprinted from *Proc. I.R.E.*, July 1943.

they would have been adequate. They involve the following inherent objections:

1. Require more careful handling than sealed-off tubes.
2. Require highly trained maintenance personnel.
3. Auxiliary pumping and conditioning equipment is essential.
4. Provision of spares is complicated.
5. Cost per hour per kilowatt is greater.

While far from sturdy, sealed-off transmitting tubes, even in the largest sizes, are now being made sufficiently strong to be shipped, stored, and installed safely with only reasonable care. To date, such is not the case with demountable tubes.

Maintenance of demountable tubes is not simple. The same knowledge, skill, and care are required for the replacement of burned-out electrodes as is necessary in their original manufacture. Personnel with normal experience in maintenance of electrical equipment would require additional training in vacuum-tube technique; for example, scrupulous chemical cleanliness is essential to the successful operation of high-vacuum, high-voltage devices.

Demountable tubes while in operation require a complete associated pumping system that does not differ materially from the equipment used in the manufacture of sealed-off tubes. Such equipment usually comprises two diffusion pumps and a mechanical pump, the latter being arranged to run only when the degree of vacuum on the last stage of the diffusion pumps reaches a predetermined minimum value. Rotating machinery, controls, and considerable space for piping and connections, all requiring continuous supervision, are involved.

The problem of providing spares is also complicated by the use of demountable tubes. A complete spare tube and vacuum system must be kept in operation and ready for instant service. This equipment, because of its size and complexity, usually must be a permanent installation making it necessary to arrange the transmitter circuit to be switched to the spare. Obviously, such an arrangement complicates the transmitter design, especially at higher frequencies. In addition, other equipment must be maintained to pump and condition tubes that have

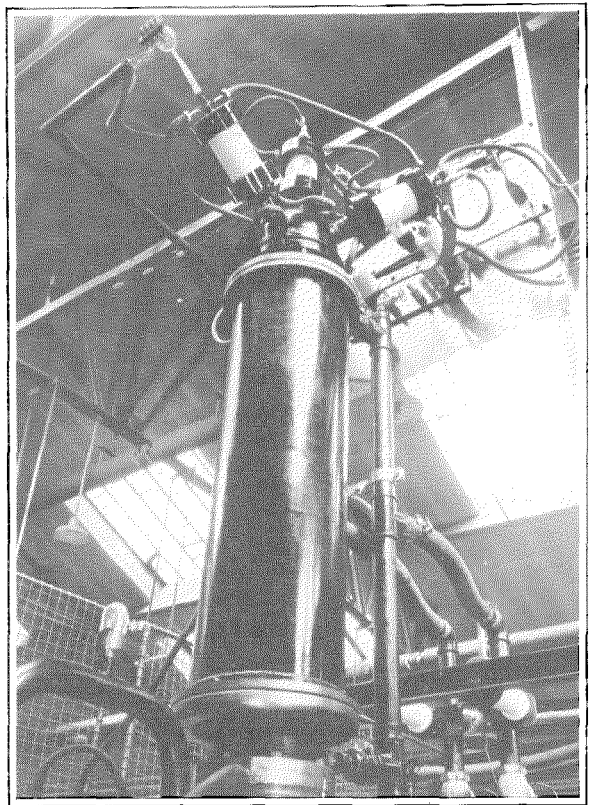

Fig. 1—Demountable Structure.

been repaired. When parts, such as a filament or grid, are replaced in a demountable structure, several hours of conditioning are required before the tube is fit for service. Such an amount of spare time would not ordinarily be available from the main high-voltage supply; hence an additional power source would be required.

Opinions differ considerably regarding the relative cost of operation of demountable tubes and sealed-off tubes. In the case of the tubes under consideration, comparative calculations were made, taking into account the cost of the demountable tube, its associated equipment, and the maintenance cost. These calculations showed that, with a sealed-off tube life of 10,000 hours (about two years' operation), the cost per hour of the sealed-off tube is lower.

The demountable structures seem to be interesting only when the power output required is so high that it is impossible to make reliable sealed tubes at an economical price.

As it appeared quite feasible to proceed with the construction of sealed tubes, two of which

would provide a carrier output of 200 kilowatts on short waves, this solution was adopted.

### *Design of the Tube*

Different possibilities of design of sealed tubes were examined. As is well known, there are two main types of structures of water-cooled tubes: one with the anode at one end and the grid and filament at the other, called the single-ended tube; the other with the anode in the middle with filament and grid brought out respectively through each end of this anode, called the double-ended tube. Much discussion has taken place concerning the relative advantages and disadvantages of these two types of structure. From the viewpoint of production neither has any real advantage over the other. In the present case,

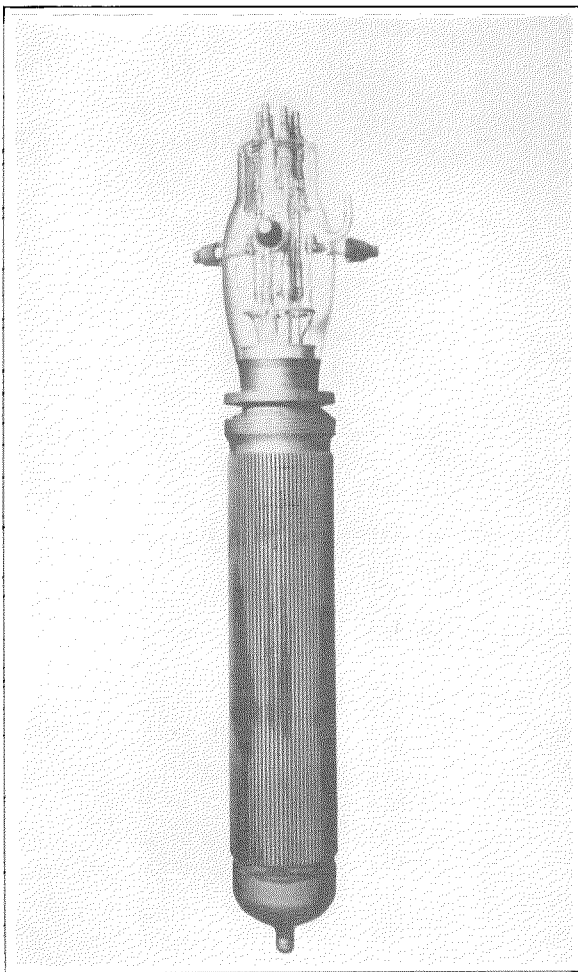

*Fig. 2—3067A Vacuum Tube.*

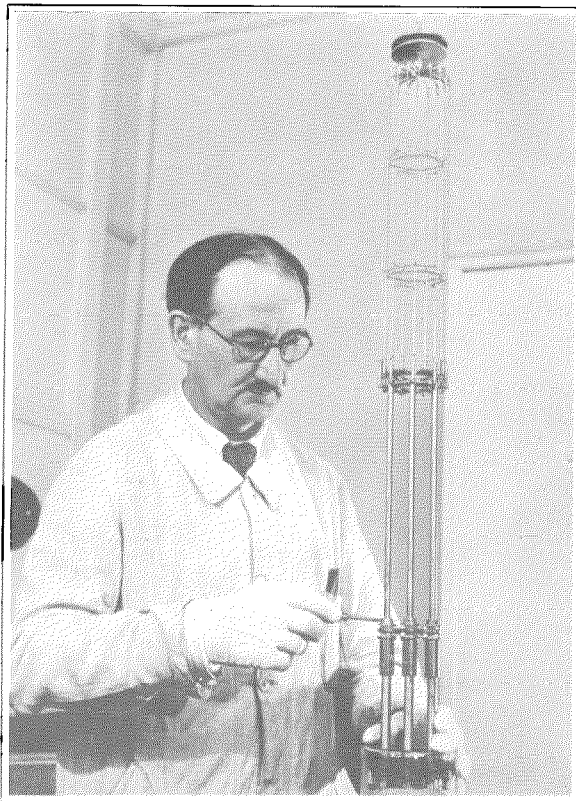
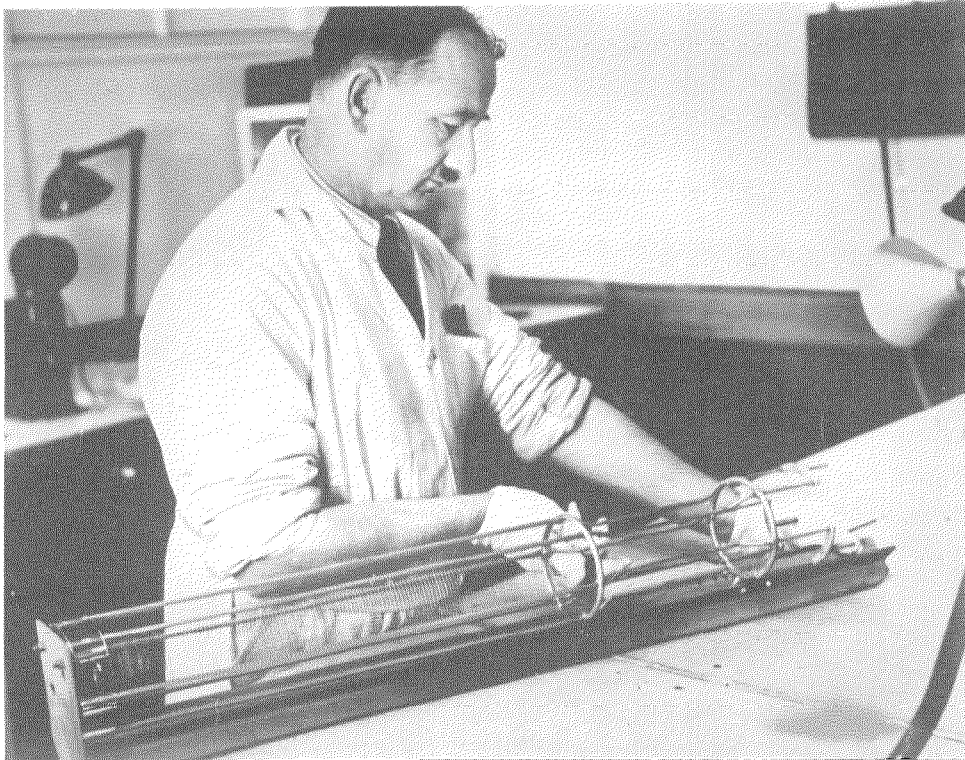

*Fig. 3—Filament Assembly.*

the singled-ended structure was favored since it is easier to connect in the type of circuit planned for the transmitters. At high frequencies, the tube is an integral part of the circuit and it is highly advantageous that tube and circuit be well adapted to each other.

For operation on the highest practical frequency, the tube over-all length was kept to the minimum and the diameter was made as large as possible. Thus the mechanical strength of the electrodes also was increased.

Before proceeding with the assembly of the sealed tubes, the filament and grid structures were both tested in a demountable unit which had been developed with a view to producing a demountable tube of power sufficient to give 500 kilowatts carrier output for two tubes in parallel. Several types of structures were tried and some life tests were started with a dissipation higher than that normally required to ensure stability of the parts. It was only when these electrodes were considered satisfactory that the first sealed tubes were assembled and tested. Only minor



*Fig. 4—Grid Assembly*

modifications of certain parts of the structure were then necessary, since the completed filament and grid units functioned as satisfactorily as in the demountable structure. Fig. 1 shows a view of the demountable structure in which the electrodes of the tubes were tested.

Fig. 2 is a view of the tube without its water jacket. The filament leads are at the top. On the side of the bulb, the grid is fastened through three leads formed by three copper caps. The copper anode is located at the bottom. Over-all length of the tube is about four feet.

### **Filament**

Most of the design work was centered on the construction of the filament structure. It would have been possible, for instance, either to use structures comprising several V's, or parallel

strands with springs applied at one end, or a self-supporting, parallel-strand structure without springs.

Because of the necessity for supporting and guiding the springs, their use entails a complicated and bulky mechanical structure. Such structures, which must operate adjacent to filaments working at a high temperature, are difficult to design and are very often a source of trouble; they also necessitate the use of numerous insulators which are generally fragile and difficult to outgas.

The extra volume occupied by filament springs causes an appreciable increase in interelectrode capacitance which, in the case of a tube working on short wavelengths, is obviously undesirable. If, in addition, certain parts are subjected to high-frequency fields, operation becomes rather

unreliable. It was consequently decided to adopt a self-supporting structure with a minimum number of insulators and no springs to pull on the filament.

The filament structure utilized is shown in Fig. 3. It comprises 18-filament strands connected in parallel. This filament was designed for direct-current or single-phase alternating-current excitation but, with minor modifications, can be adapted to 3-phase alternating current.

The strands are so connected that the current in two adjacent strands always flows in opposite directions. This is very important, since the action of the electromagnetic force is great due to the high current passing through the filament. With this arrangement the electromagnetic forces tend to bow out the filament, all the forces being radial and directed towards the outside. In order to prevent this distortion, strands having the same potential were fastened together at regular intervals. With the length of filament used, a fastening at two points suffices.

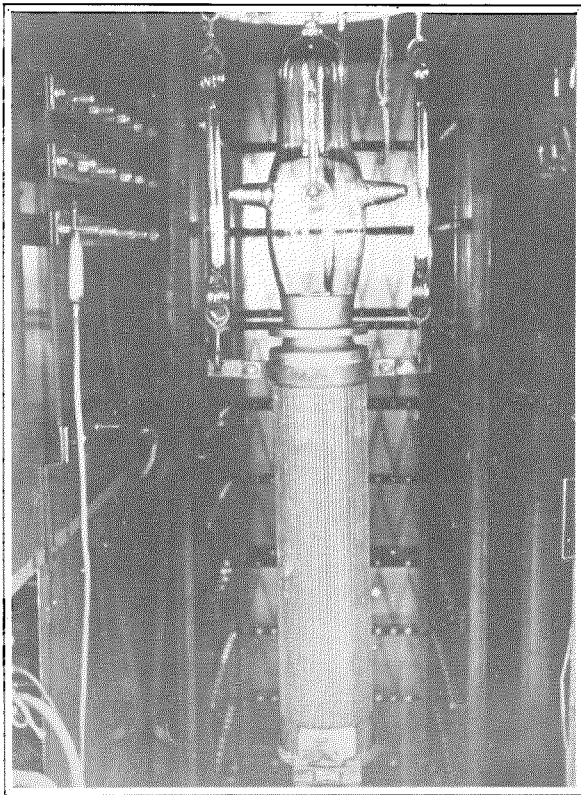

*Fig. 5—Baking of Anode Structure.*

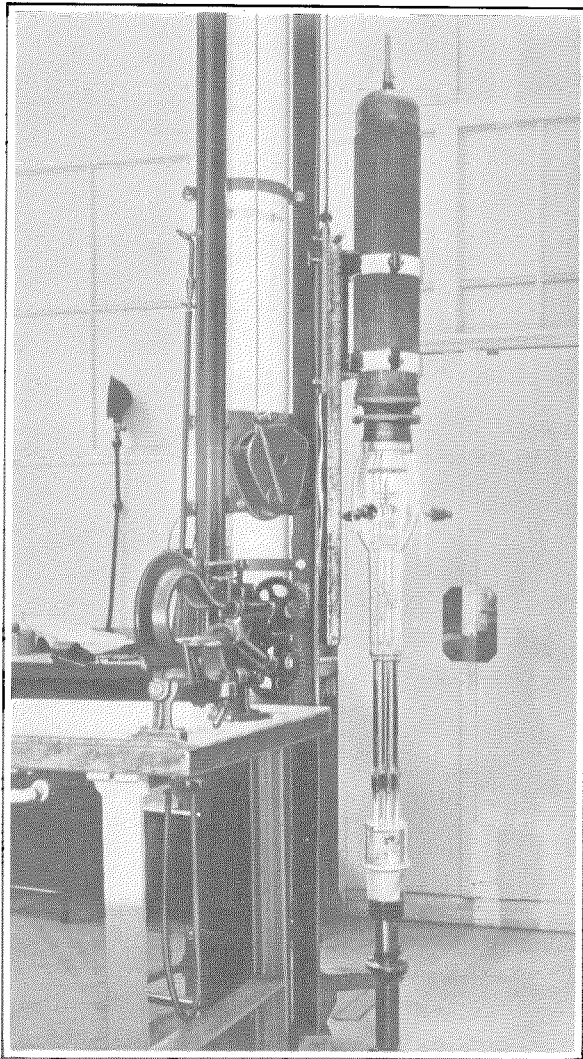

*Fig. 6—Filament Anode Assembly.*

In such structures, it is essential that the different strands expand equally when heated. Uniform expansion can be obtained only by exercising the greatest care in selecting filament strands of practically identical diameter. The highly polished tungsten filaments are, therefore, manufactured to the very narrow limits of  $\pm 0.5\%$  of the diameter. The strands are all weighed when they are received and their diameters are measured on two perpendicular directions at several points. Each strand is then placed in one of six groups. When selecting the 18 strands for a particular tube, all are taken from a single group but, even then, the strands are matched as closely as possible, the grouping



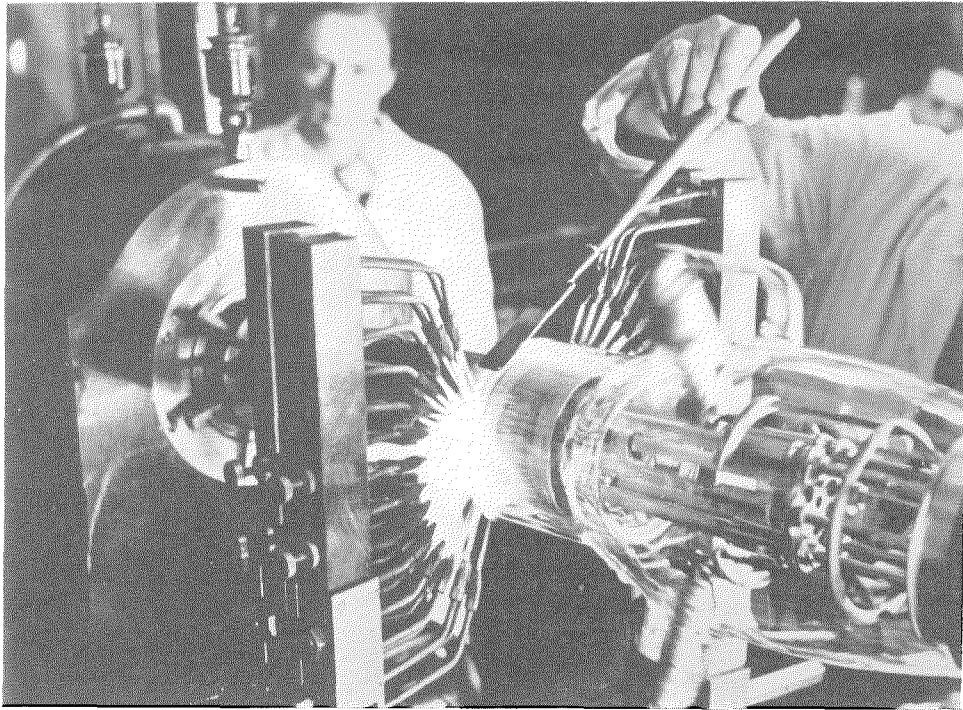

*Fig. 7—Sealing of the Tube*

being made merely to facilitate this final matching process.

The strands are then shaped and heated in hydrogen in order to set them. One end of each strand is arc-welded on short filament leads. Next, all the strands are placed on the stem, and the other ends of all the strands are arc-welded on the filament leads mounted on the stem. A suitable fixture is used to keep the strands in place and to guide them during the welding. After that, the ends of the leads on all strands are welded together as well as to a central connector, the atomic hydrogen process being employed. With this method of assembly, the filament strands remain quite straight and parallel.

Using leads at the common end of the strands, instead of welding the filaments themselves onto the central connector, allows for an appreciable decrease of filament power and increases the rigidity of the filament structure. After the fila-

ment structure has been so completed, it is flashed in hydrogen by passing a suitable current through the filament strands in order to set it permanently.

The filament supports comprise two molybdenum plates on one side of which the molybdenum leads of the filament strands are welded and on the other side of which large-diameter molybdenum rods are also welded. These are inserted into copper tubes in which they are fastened by means of screws. The ends of these copper tubes are themselves brazed inside of copper caps which are sealed on a moulded flare. The bottom end of the filament structure is provided with two shields and a guide rod which enters an insulator fastened at the end of the grid. It is to be noted that the bearing between this rod and the quartz insulator is not made directly but through another quartz insulator mounted at the end of the rod.

### *Grid and Anode*

Fig. 4 shows the grid structure. The grid is wound inside a cage consisting of six tungsten rods fastened on a support which is itself fastened on the three leads passing through the bulb. At the bottom of these rods, a support is provided for the quartz insulator which is used as a guide for the end of the filament structure. The grid winding is fastened on the leads by means of a tungsten spiral.

The anode, which is made of copper and comprises several parts, can be seen in Fig. 5. The central part is provided with grooves in order to increase the anode dissipation. A cup is brazed on the bottom end. It is provided with a hole used during the assembly of the tube to assure the centering of the filament structure.

On the top of the central part, a collar with a feather edge is brazed, on which, in turn, a glass bulb is sealed. This part is adapted for water cooling to keep the copper seal at a sufficiently low temperature.

Three radial arms for mounting the grid are sealed on the bulb. Then, the bulb is sealed on the anode and the whole structure is evacuated and left in stock for a sufficient number of weeks to make sure that the copper parts and the seals are airtight.

### *Assembly*

To proceed with the assembly of the tube, the grid is mounted inside the anode and, next, the filament structure is sealed in place.

Originally, the tube was sealed on a horizontal lathe; the operation, though feasible, was difficult due to the necessity of accurately centering the filament structure. Fig. 6 shows a tube being aligned in the centering device.

At first, the filament was mounted in the anode in a vertical position and both structures were fastened on a common support. The whole assembly was then transferred to a lathe where the anode was fixed in one head while the filament support was fastened on the other head. Fig. 7 shows this sealing operation.

In order to make the assembly of such tubes much easier and remove any danger of warping of the filament, a vertical lathe of a special design

was developed. At the time, two possibilities were considered: rotating the flames with the tube fixed, or the flames fixed with the tube rotating.

Design of a vertical lathe in which only the flames rotate involves certain delicate problems, but does not require accuracy so great as that of the other type. It is simpler in design and less expensive; however, the sealing operation requires, in addition to the rotating fires, a rotating graphite paddle to shape the glass, operation of this paddle being obtained by vertical motion of a disk on which a part of the paddle bears. Such an operation on a seal of large diameter is not so easy as the usual hand paddling of the seal when in rotation. In this latter case, the glass can be worked in a better manner. It was this main consideration which led to the design of a lathe utilizing fixed fires while the tube rotates.

Fig. 8 shows the vertical lathe. The anode is fixed at the bottom of the lathe, passing through

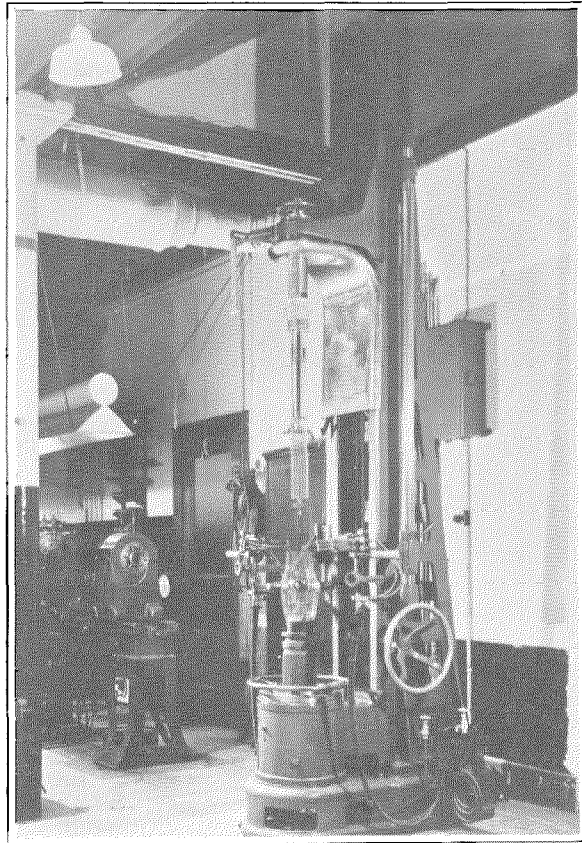

*Fig. 8—Vertical Scaling Lathe.*

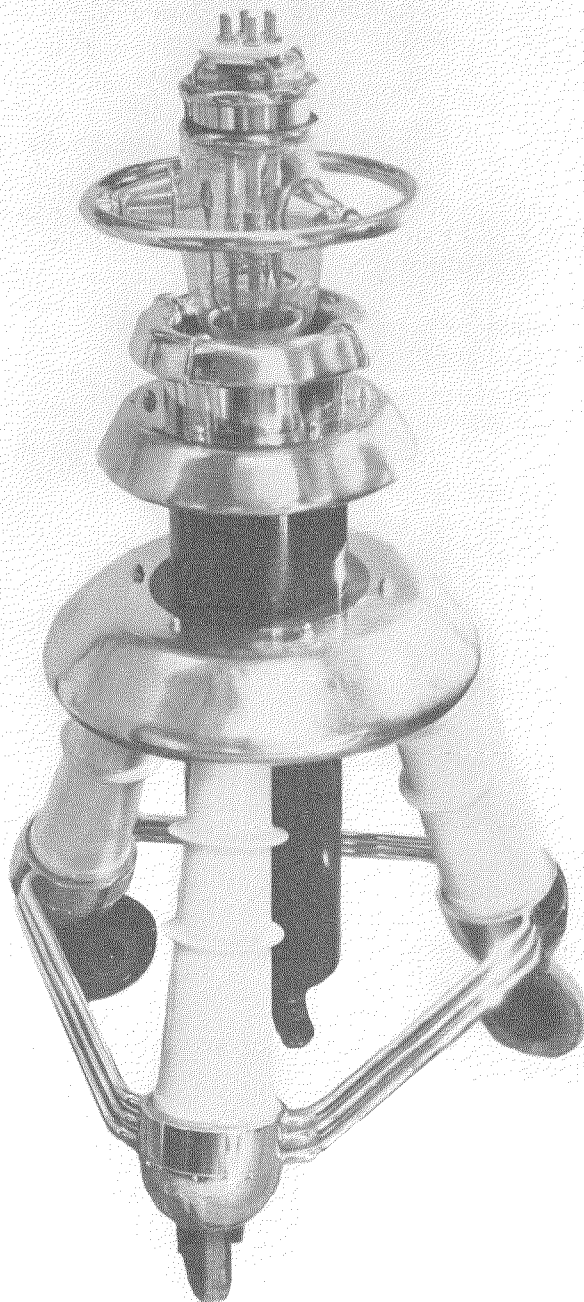

*Fig. 9—3067A Vacuum Tube with Water Jacket and Truck.*

large ball bearings on which a suitable chuck is mounted. Fastening the anode on this chuck is accomplished by means of a large wheel. The filament is mounted on a support which passes through the top head which is vertically movable by means of a large wheel. Both this and the bottom head are machined with very great accuracy so that the parts have an eccentricity less than 0.02 millimeter and the shafts are aligned within 0.02 millimeter. The flames can be moved easily, and their position can be adjusted.

**Exhaust**

After the tube is sealed, it is immediately put under rough vacuum. The tube is then exhausted. The exhaust station comprises a large movable platform which can be brought around the tube during the baking and moved back afterwards to leave the space around the tube free for the different connections during the other operations of the exhaust.

The exhaust process comprises the usual steps of baking, bombardment of electrodes and high-voltage conditioning under high voltage with the filament cold. The total length of the exhaust of a

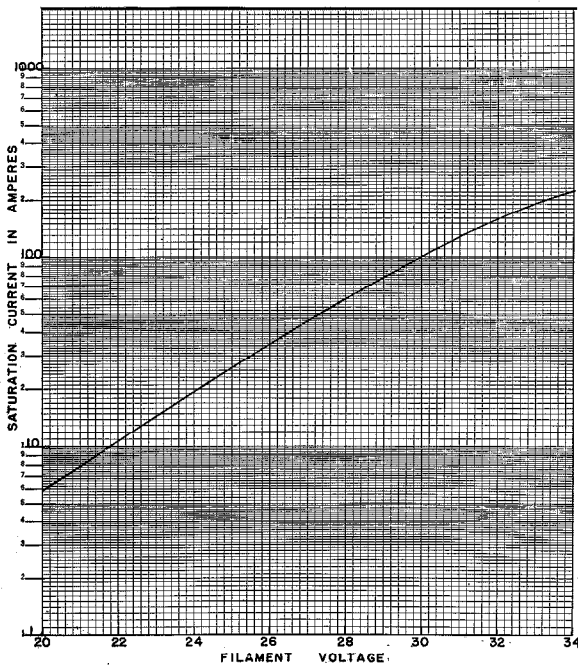

Fig. 10—Tube Type 3067A—Emission Characteristics

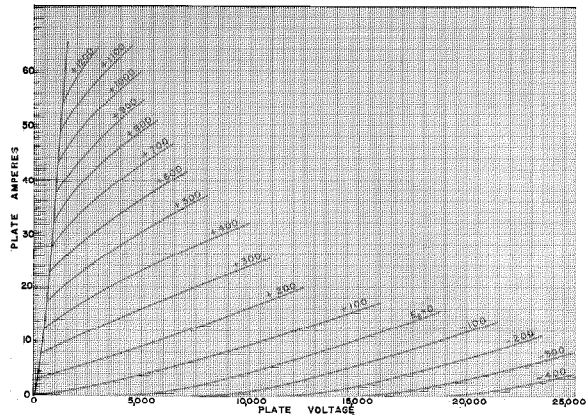

Fig. 11—Tube Type 3067A—Plate Characteristics.

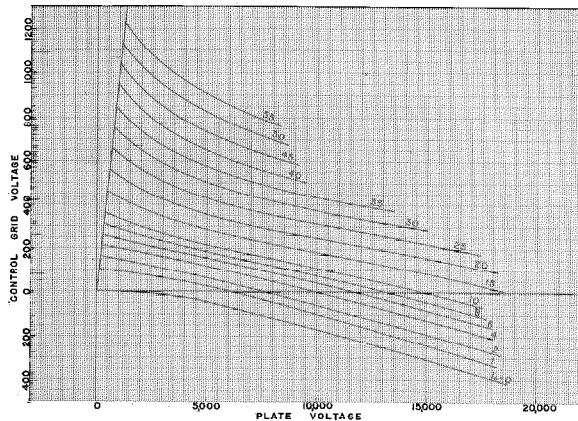

Fig. 12—Tube Type 3067A—Plate Characteristics—Constant Current Curves.

tube varies from one tube to another but, on an average, takes approximately 35 hours.

Before testing the tube, an X-ray picture is taken to make sure of the shape of the electrodes and of their relative centering.

Tests include the usual vacuum measurement and the determination of the static characteristics. The tube is formed, at first on direct current with high voltage up to the peak anode dissipation, and tested as a self-oscillator at 25,000 volts with 400 kilowatts output.

**Cooling**

Cooling of the tube is accomplished through a water jacket. With a flow of 60 gallons of water per minute, the anode is tested for a dissipation of 340 kilowatts, which corresponds to about 1.3 kilowatts per square inch of the anode, much

more than needed under the normal operating conditions of the tube. Fig. 9 shows the tube mounted in the water jacket. The grid and filament seals need no special cooling.

### Mounting

When used on medium wavelengths, the tube can be mounted on a small truck which makes it possible to replace the tube readily. At higher frequencies, the truck is too large and the tube is fastened on a suitable support. In both cases, corona shields are placed in the vicinity of the anode and grid seals, and a ring is used for the grid connections.

### Characteristics

Fig. 10 gives the filament characteristics of the tube, Type 3067A. For 100 amperes emission, the filament voltage required is 30 volts, corresponding to a power of above 19 kilowatts. The emission then is less than 5.5 milliamperes per watt which is a relatively low figure resulting in a filament life of more than 10,000 hours. While use of a filament working at such a low temperature increases the filament power, the cost per hour is, however, decreased by the considerable increase in tube life.

Static characteristics are shown on Figs. 11, 12, and 13. Table I summarizes the main characteristics of the tube.

TABLE I  
TECHNICAL DATA

|  |                           |        |               |
|--|---------------------------|--------|---------------|
| <i>Characteristics</i>   |                           |        |               |
| Filament voltage   | 30 volts                  |        |               |
| Filament current   | 635 amperes               |        |               |
| Total emission current   | 100 amperes               |        |               |
| Amplification factor   | 44                        |        |               |
| Impedance  | 720 watts                 |        |               |
| Mutual conductance   | 50,000 micromhos          |        |               |
| Grid-anode capacitance   | 110 micromicrofarads      |        |               |
| Grid-filament capacitance  | 90 micromicrofarads       |        |               |
| <i>Water Circulation</i>   |                           |        |               |
| Normal water flow  | 60 gallons per minute     |        |               |
| Pressure drop for normal flow  | 15 pounds per square inch |        |               |
| Maximum water pressure   | 50 pounds per square inch |        |               |
| <i>Dimensions and Weight</i>   |                           |        |               |
| Over-all length  | 47.5 inches               |        |               |
| Maximum diameter   | 20 inches                 |        |               |
| Net weight   | 104 pounds                |        |               |
| <i>Limiting Conditions for Safe Operation</i>  |                           |        |               |
| Normal direct plate voltage  | 17,500 volts              |        |               |
| Maximum plate dissipation  | 160 kilowatts             |        |               |
| Maximum grid dissipation   | 3 kilowatts               |        |               |
| <i>Typical Operating Conditions on a Plate-Modulated Amplifier 100 Per cent Modulation</i> |                           |        |               |
| Working plate voltage  | 12,000                    | 11,500 | 11,000 volts  |
| Normal plate current   | 11                        | 11     | 11 amperes    |
| Carrier output per tube  | 100                       | 90     | 80 kilowatts  |
| Frequency  | 12                        | 18     | 22 megacycles |

The station in which these tubes were used comprised a group of two transmitter units, each

unit composed of three final amplifiers and two modulators. A single unit was, therefore, capable of radiating two separate programs simultaneously on different frequencies so that, with both units, four separate programs could go on the air from the station at one time. The extra final amplifier in each transmitter unit permitted wavelengths and antennas to be switched without interrupting programs since these amplifiers could be readjusted with the power off. When power was applied, one of the modulators could be switched instantly to the third final amplifier. Whichever amplifier had been left free could then also be readjusted after its power had been turned off. The process of switching frequencies was, consequently, continuous and uninterrupted. Ten directive antennas were provided at the station; twelve pretuned frequencies permitted operation in the radio-diffusion range of 6, 7, 9, 11, 15, 17, and 21 megacycles. All the commutations, that is, choice of frequency, choice of circuit, and choice of antenna, were automatic and controlled from the station con-

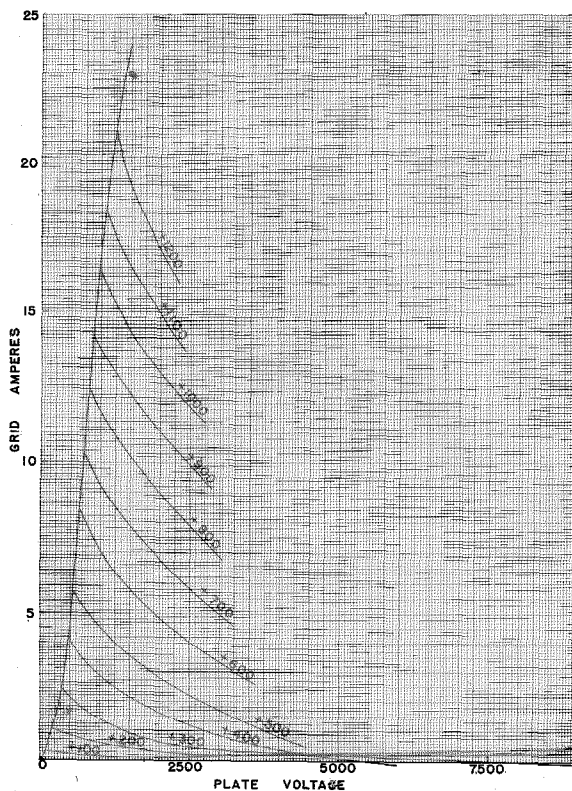

Fig. 13—Tube Type 3067A—Grid Characteristics.

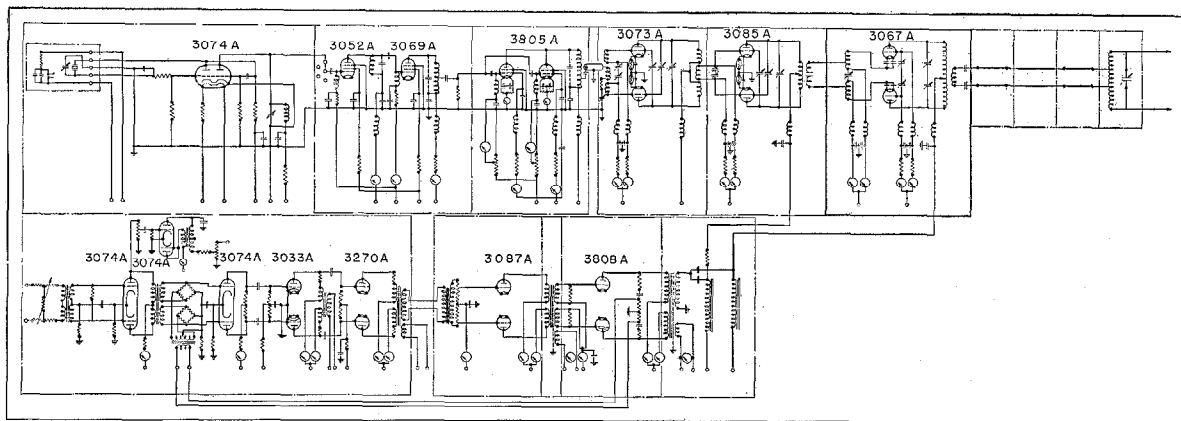

Fig. 14—Schematic Diagram of Transmitter.

trol desk. Three similar stations were under construction to provide in all twelve simultaneous programs.

### Output Stage

The low-power stages of the station were conventional and need not be described. The last stages, however, possessed some unusual features.

Two of the 3067A tubes were used in the final stage and were connected in a so-called inverted amplifier circuit. The high-frequency drive was applied on the filaments of the tubes, the grid being kept to a voltage very close to that of the ground. In each tube, the grid thus acted as a shield between the input circuit, which was the filament-grid circuit, and the output circuit, which was the grid-anode circuit. Among the advantages of this kind of a circuit, the following can be indicated:

1. It is possible to reduce the value of the neutralizing condensers considerably or even, in certain cases, to eliminate them entirely. This is due to the fact that the coupling of the input and output circuits through the tube is caused solely by the capacitance between filament and plate, which is much smaller than that between filament and grid. A decrease in the circulating current consequently results in appreciably lowering the losses in the last stage. Elimination of the neutralizing condensers is particularly advantageous when the transmitter must operate on a relatively wide band of frequencies.

2. The inverted amplifier can operate in a rather wide band of frequencies without having to modify the tuning.

3. A large negative feedback is applied on the input circuit due to the fact that the plate current passes through the filament circuit. The latter circuit, being tuned, the alternating component of the plate current produces on the filament circuit a voltage in phase opposition to the driving voltage. Hence stability of the last stage is increased since parasitic oscillations are suppressed. Harmonic distortion introduced by the last stage also is reduced.

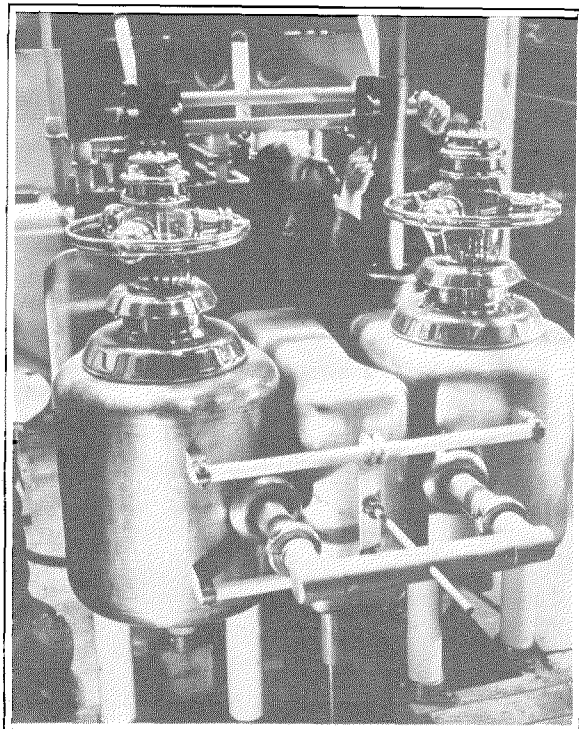
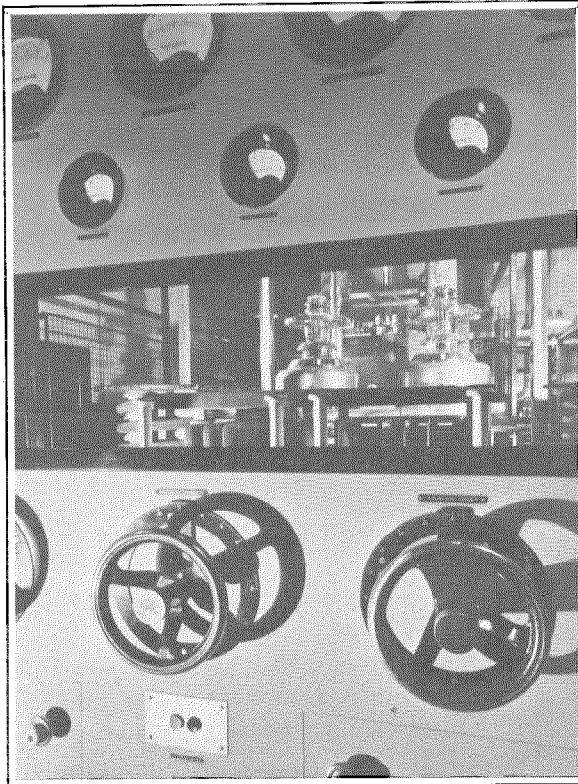

Fig. 15—Final Amplifier.



*Fig. 16—Front Panel—Final Amplifier.*

4. The inverted amplifier, as compared with the usual type amplifier, makes it possible to obtain a higher output inasmuch as an appreciable part of the high-frequency energy supplied to the antenna comes from the penultimate stage.

Plate modulation was adopted. Its advantages can be summarized as follows:

1. The modification of the high-frequency circuit necessary to change over from one frequency to another does not alter the modulation characteristics as both circuits are entirely independent.

2. With the exception of the last two stages, the high-frequency circuits are not modulated, allowing the use of shielded-grid tubes for these circuits. A very high gain per stage can be thus obtained without requiring accurate adjustment of the operating conditions. It is possible to overdrive the different stages in a manner such that the power which is obtained is practically independent of the driving conditions or of the bias of the tubes. This appreciably decreases

noise due to the intermediate stages of the high-frequency circuits.

3. The last stage of the transmitter always works at its maximum efficiency.

4. The power which is absorbed by the last stage of the modulation amplifier is very small for the carrier, and the efficiency of the amplifier is up to 60% for the maximum percentage of modulation of the transmitter.

Another particularly interesting feature of the transmitters was the use of a very large negative feedback which improves the characteristics of the transmitters. The advantages resulting from high negative feedback are:

1. Total gain of the audio amplifier is kept practically constant throughout the frequency band.

2. Variation in tube characteristics and some of the changes in the voltage supplies are compensated for.

3. Harmonic distortion and noise introduced by the different amplifiers are considerably reduced.

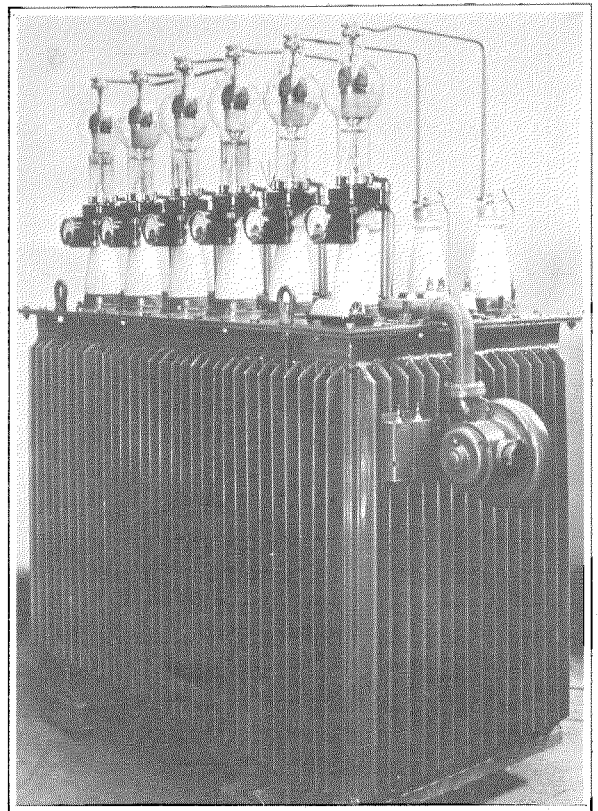

*Fig. 17—Low Power Rectifier Unit.*

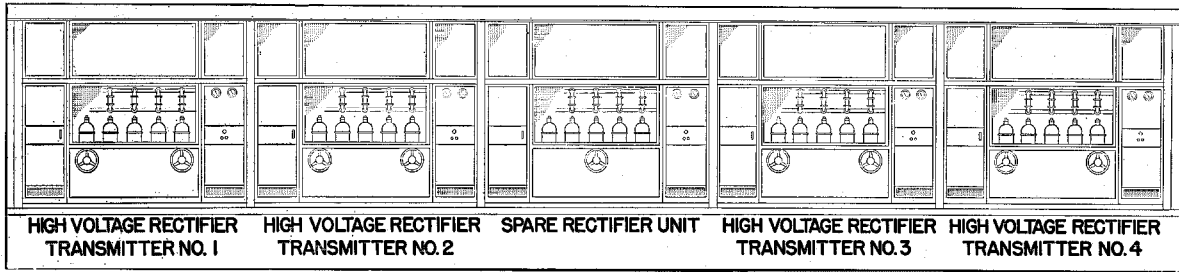

Fig. 18—High Power Rectifier Units—Front View.

Fig. 14 shows the schematic of the different stages of the transmitter. Fig. 15 indicates the location of the tubes inside the last stage of the transmitter. Fig. 16 illustrates the front view of the panel.

**Power Supply**

The power taken from the mains by the high-power rectifiers as a function of the level of modulation for 150 kilowatts carrier and 13,000 volts applied to the anodes of the tubes for four programs simultaneously was as follows for the three last high-frequency stages and the last two modulating stages:

| Per Cent Modulation | Kilowatts |
|---------------------|-----------|
| 0                   | 1360      |
| 3.3                 | 1700      |
| 80                  | 2260      |
| 100                 | 2490      |

To feed the different low- and high-power stages with high voltage, hot-cathode mercury-vapor rectifiers were used. Fig. 17 shows the type of units used for low power. They were small compact units built up exactly like oil-cooled transformers. They comprised a tank inside of which were mounted the filament transformers, the high-tension transformers and the choke for the smoothing circuit. The different tubes and insulators through which the connections to the tubes were made were mounted on top of the tank. According to the power and voltage of the rectifier, forced ventilation was provided on the base of each tube. The design of these units is such that they may be located inside a vault suitable for high voltage in the same manner as high-tension transformers are placed.

In the case of the high-power stages, five high-power rectifier units were used for an output of

13,000 volts and 37 amperes. Taps were provided for 12,000 volts at 40 amperes and 11,000 volts at 40 amperes. Fig. 18 shows a front view of the units. The rectifier tubes were of the grid-controlled type. Each unit comprised six tubes connected in the three-phase, full-wave, six-tube series circuit. Each tube was mounted on top of its filament transformer through the intermediary of a high-voltage insulator. They were all placed alongside of each other and each tube was surrounded by a shield at the base of which hot air at a constant temperature of 40 degrees centigrade was blown.

The voltage of the rectifier could be varied from zero to peak voltage by applying properly phased pulses on the grids of the rectifier tubes. This excitation of the grid was accomplished by equipment which did not include rotating parts or moving relays; a special transformer was used comprising a magnetic circuit made partly of permalloy. One transformer was associated with each tube; its size was very small so that it

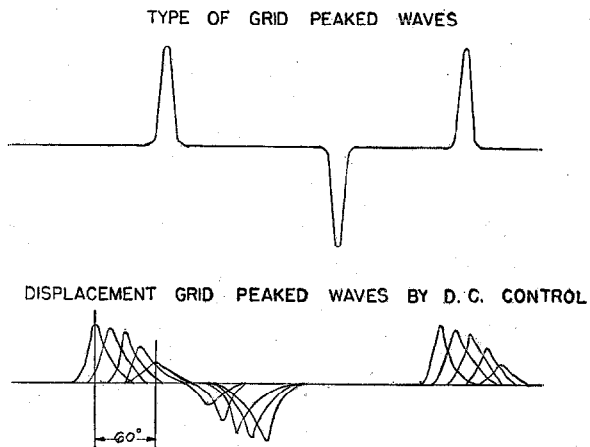

Fig. 19—Wave Shape of the Peak Wave Used for Firing Grids and Displacement of the Peaked Waves by D-C Control.



could be included in the same tank as the filament transformer itself. It was supplied with alternating current from the same supply as that to be rectified. A direct current passed through one of the windings and was used as a control. Whenever the alternating current through the winding changed polarity, the flux of the core was reversed, and a peaked wave was produced in a third winding.

If the value of the direct current in this control winding was increased, the peaked waves were displaced with respect to the alternating-current cycles. The effect is illustrated in Fig. 19 which is an oscillogram of the output voltage of the transformer. In this case, the peaked wave was displaced by 60 degrees for a 200-ampere-turn change in the control winding. If the current were reversed, the displacement of the peaked wave would have been in the opposite direction so that the total displacement would be 120 degrees. A further increase in the value of direct current had the effect of completely saturating the core system with the result that peaked waves were no longer produced and the grid-control rectifier tubes were no longer excited. The displacement of the position of the pulse

determined the corresponding variation of the time at which each rectifier tube in the circuit started; and, in the case of a three-phase, full-wave, six-tube series circuit, it was sufficient to move this sharp pulse by 90 degrees to adjust the voltage from zero to peak voltage of the rectifier. In practice, variation of voltage by means of the control of the grid was used only during certain tests of the transmitter, when starting the transmitter, and to compensate for variation of the mains. This compensation could be practically automatic as the amplitude of the direct current applied on the peak-wave transformers could be made a function of the rectified voltage, and an accurate compensation could be obtained. One very important characteristic of grid-control rectifiers is that the grid can be used to stop a rectifier in less than 20 milliseconds in case of a short circuit caused, for instance, by a flash arc inside the high-power vacuum tubes. Voltage can then be restored in a fraction of a second after the short circuit has been stopped; and, in this length of time, the voltage is applied at its minimum value and brought up to the maximum value of the rectifier without noticeable interruption of the program.

## In Memoriam

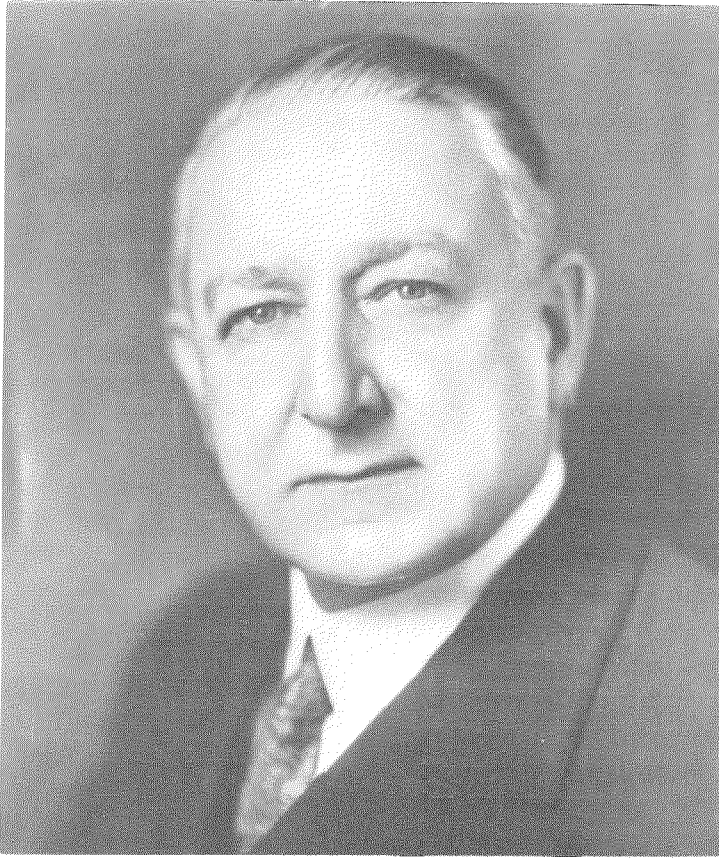

COLONEL WILLIAM F. REPP

Vice President and Director of the International Telephone and Telegraph Corporation and President of the International Telephone and Telegraph Corporation Sud America, died May 25, 1943, in New York, after a brief illness. He was born on April 14, 1877 in Philadelphia.

Colonel Repp was associated with the telephone industry continuously since 1901 except for the period of the first World War when he served in the 406th Telegraph Battalion, United States Signal Corps. He began his telephone career as a switchboard installer for the New York Telephone Company and, for twelve years

prior to his entrance into the military service, he held various important supervisory posts in the Plant Department of the Bell Telephone Company of Pennsylvania. From 1919 to 1923 he served first as Chief Engineer of the Cuban Telephone Company and later of the International Telephone and Telegraph Corporation. In 1923, he was transferred to Mexico where he took charge of the acquisition and reorganization of the Mexican Telephone and Telegraph Company. In 1928, he was transferred to Buenos Aires in supervisory control of the varied interests of the International Telephone and Tele-

graph Corporation throughout South America.

In this latter position, in which he held the office of President of the I. T. & T.'s management subsidiary, International Telephone and Telegraph Corporation (Sud America), Colonel Repp contributed decisively to the development of telephone communications in Argentina and other South American countries and to the establishment of telephone communications between those countries and the United States and the rest of the world.

Entering the army in the month in which this country declared war, in April 1917 he sailed on the S.S. Baltic with the group of officers who accompanied General Pershing to France. He rose from a lieutenant to a lieutenant colonel and was awarded the Distinguished Service Medal for important technical contributions to the signal service. His citation reads:

"For exceptionally meritorious and distinguished services. With his valuable assistance the Signal Corps was enabled originally to plan for the immense network of United States Army telegraph and telephone lines now existing in France. To him is attributable the ex-

ceptionally high standard of efficiency attained by the telephone and telegraph service. As Chief Signal Officer, Advance Section Services of Supply, his services have been marked by a character of exceptional excellence."

Colonel Repp was decorated by Great Britain with the Order of St. Michael and St. George, and by France with the Legion of Honor. In 1938, he received recognition from the Chilean Government by being made Gran Oficial del Orden de Merito.

He was educated at private schools and the University of Pennsylvania. He was a member of the Bankers Club and Downtown Athletic Club (New York), New York Chamber of Commerce, Havana Club (Havana), and the Jockey and American Clubs (Buenos Aires).

Colonel Repp is survived by a son, Lieutenant William F. Repp, who is serving overseas with the United States Army Signal Corps, and two brothers, F. J. Repp and Edward Repp, both of Philadelphia.

Interment was at Arlington National Cemetery.

# Aircraft Electric Power Supply System\*

By JOHN E. YARMACK, Member, A.I.E.E.

*Federal Telephone and Radio Corporation, East Newark, New Jersey*

*An ever increasing demand for electric power in aircraft has been felt for some time. The necessity of using an electric storage battery started the practice of associating it with a d-c generator, first of low current and voltage capacity, later of 50-ampere, 12-volt rating, and for the past few years of 200-ampere, 24-volt output. In the largest four-engine aircraft, even four generators of maximum capacity do not furnish ample electric plant energy. Experiments have shown that generation of a-c power and application of light-weight transformers, together with conversion to direct current by means of Selenium Rectifiers, is an entirely reliable and practical way of attaining large, trouble free electric plant capacity in aircraft. This paper reviews the progress made with light-weight power transformers and rectifiers in a-c, d-c aircraft systems. It also gives at least a partial answer to questions raised by Lieutenant Colonel Holliday<sup>1</sup> when he discussed problems of applications of electric power in aircraft two years ago.*

## General

THE development of a-c, d-c power systems for aircraft application started with a view of achieving two main objectives: (1) augmenting the source of electric energy obtainable from conventional d-c generators; and (2) alleviating the difficulties of commutating machinery and voltage limitation under conditions of high-altitude operation. Moreover, with alternating current as a primary source of electric energy, some of the a-c powered equipment in aircraft can readily be used with or without transformers while d-c operated devices may be powered through rectifiers with or without transformers.

Early experiments were directed toward the development of a substitute for the largest of the conventional 24-volt d-c systems, i.e., a 200-ampere generator with output set at 28.5 volts for battery charging.<sup>2</sup> This would require a 3-phase, 160-ampere, 28-volt, 5000-10000 r.p.m. alternator and a 200-ampere, 30-volt rectifier. The combination was to equal or, if at all possible, to better the weight, bulk and efficiency of the d-c generator.

The paramount requirements of the aircraft power rectifier narrow down to the following: (1) high efficiency; (2) minimum weight; and (3) satisfactory service. An efficiency of 84 per cent appeared to be feasible and acceptable. A unit of 6-kw rating, with suitable enclosure and connecting terminals, would receive favorable consideration if its weight were in the neighborhood

of 15 pounds. Larger sized units would be multiples of this unit. Satisfactory service may be expected provided the performance of the rectifier is: (1) fairly uniform under extreme temperature, humidity and altitude conditions; (2) unaffected by vibration; and (3) capable of maintaining good operating characteristics for at least 500 hours with a reasonably small amount of air blast cooling. Several Selenium Rectifiers were designed, built and tested under low and high temperatures, rarefied air and excessive vibration conditions. Their performance was in every respect satisfactory and, therefore, promising.

The transformer, on the other hand, from the very start presented one important problem: the attainment of the lightest possible weight. Air blast cooling was definitely assumed as essential. Fortunately, the latest kind of material and unique design produced very gratifying results.

The requirement, design and performance factors of the alternator constitute an ample subject for discussion. It is sufficient to state here that even the early alternator, powering a 200-ampere, 30-volt rectifier, weighed 26 pounds and was 90 per cent efficient.

In order to evaluate fully the soundness of aircraft power generations<sup>3</sup> of much higher magnitude than by the conventional 200-ampere d-c machine, plans were drawn to build an aircraft electric system capable of delivering a d-c output of 800 amperes, 30 volts, under varying temperature and humidity conditions and with a reasonably small amount of air blast cooling. Such a system, Fig. 1, comprising alternator, transformer and rectifier, was built and tested.

\* Paper presented at the National Technical Meeting of the A.I.E.E., Cleveland, Ohio, June 25, 1943.

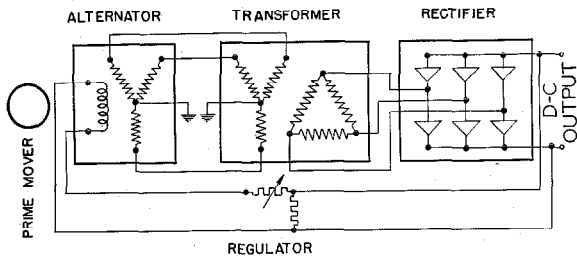

Fig. 1—Block Diagram of Aircraft Electric Plant of 800-ampere, 30-volt d-c rating.

**Rectifier**

Even during early experiments with a 200-ampere rectifier, it became evident that, if Selenium Rectifiers were to play a role in 24-volt aircraft systems, the design and technique of the manufacture of selenium plates would require modification at least to the extent of using a single selenium plate in series. Thus a plate of at least 28-volt root-mean-square rating and of the lightest possible weight was needed.

This selenium plate, as finally developed, weighs  $1\frac{1}{4}$  ounces bare and  $1\frac{3}{4}$  ounces when equipped with the necessary hardware including fuse (Fig. 2). In the three-phase bridge circuit, selected as most suitable for aircraft power conversion, the plate handles 12.5 amperes of the entire current output at 30 volts d-c with 350 cubic feet of air per minute. It is fitting here once more to reiterate the function of this type of rectifying element. The phenomenon of electric current rectification takes place wholly in the barrier layer which, in this particular plate, has been strengthened in the reverse direction but with the minimum adverse change in the forward direction. The static characteristic of a metal rectifier is determined by applying, first, d-c voltage in the forward direction (from zero to one, two or three volts) and recording the d-c current per unit area (milliamperes per square centimeter); and second, by applying d-c voltage from zero to maximum plate voltage in the reverse direction and measuring the current leakage in milliamperes per unit area.

There is a total of six arms in the rectifier of the three-phase bridge circuit, but only two arms function during each one-sixth of a cycle. The remaining four arms are blocking (Fig. 2-A). Since the total d-c output is greater than 12.5 amperes, several plates are placed in parallel. The

rectifier of 200-ampere, 30-volt rating, has a total connection of 6-1-16, the figure "16" designating the number of parallel plates in each arm of the bridge circuit. Physically all 96 plates are assembled into three stacks, interconnected with a suitable bus structure and housed in a light-weight case designed and built in accordance with usual aircraft practice (Figs. 3 and 4).

The upper section of Fig. 2-B illustrates the function of the selenium plate in the passing or forward direction. The plate voltage drop varies with the current density or the total output of the rectifier and constitutes forward losses. In a rectifier of 200 amperes output, its value is in

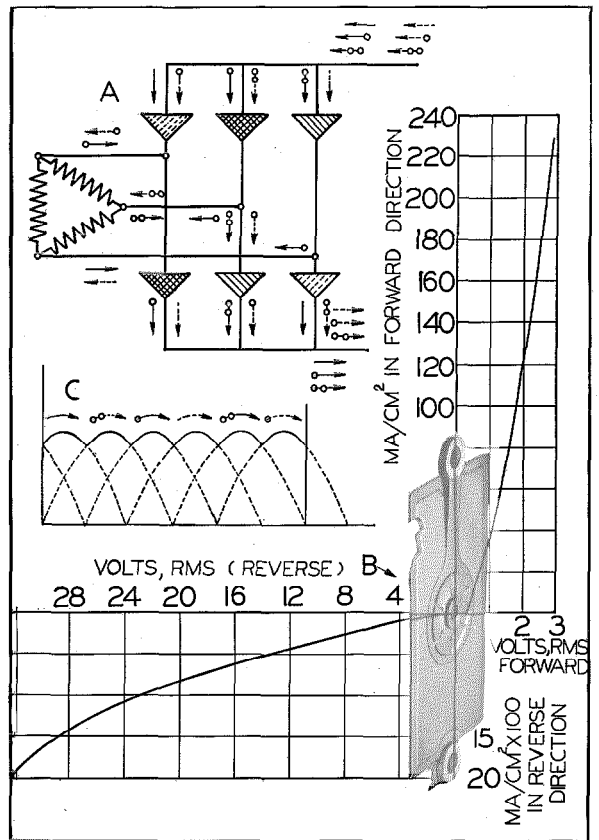
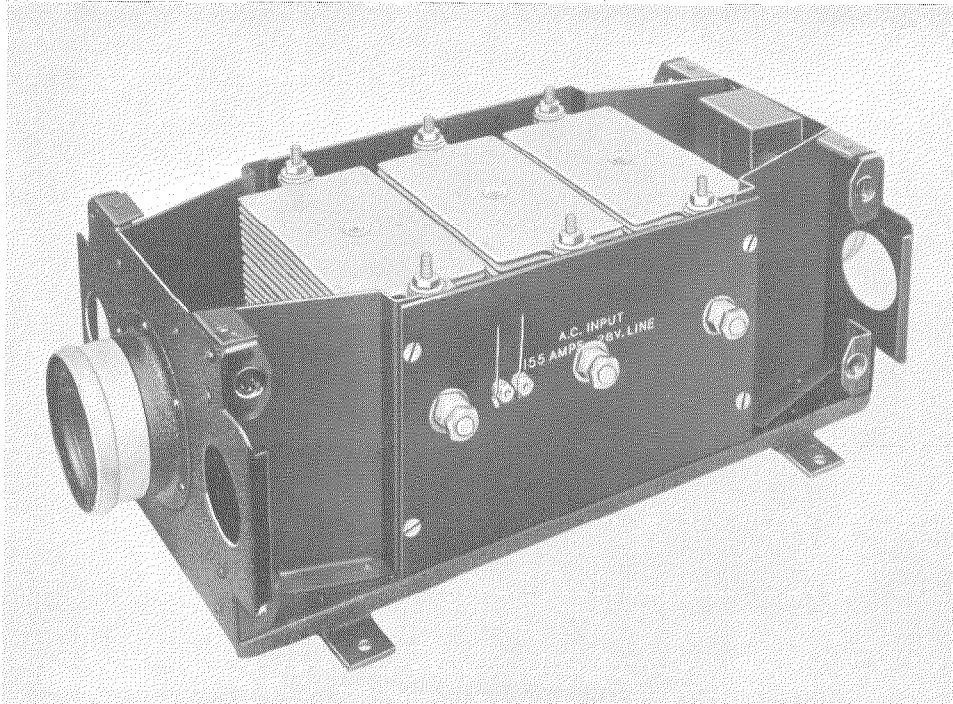

Fig. 2—High-Voltage Selenium Rectifier Plate.

- A. Diagram of three-phase Bridge Circuit and Distribution of Current in its six arms.
- B. Operating Characteristic, Forward and Reverse Voltages in root-mean-square values and the Currents in Arithmetical Values, as they function in three-phase Bridge Circuit. Cut shows four layers of Rectifying Element, Back Electrode, Selenium Layer, Barrier Layer and Front Electrode.
- C. The Net Result of Performance of the six arms of the Bridge Circuit during each cycle.



*Fig. 3—Aircraft Rectifier, 3-phase input, 200-ampere, 30-volt d-c capacity. Top and Side Covers Removed. Weight 15 pounds. Rectifying Elements occupy less than 0.25 cubic foot and weigh 11 pounds.*

the neighborhood of 2.3 to 2.7 volts. This drop, however, changes with the length of service of the rectifier. Its increase during 500 hours of continuous operation may result in a net five per cent drop in the d-c output with the same a-c input to the rectifier. For some time, it was thought that an idle condition of the rectifier would substantially increase this voltage drop. To date, however, observations have shown that this is not the case, although some momentary deviation in selenium plate characteristics may be expected after long idleness.

With the two arms of the bridge circuit passing current in forward direction, the remaining four arms are blocking. An ideal rectifier would block reverse current completely. Actually, however, there is a certain amount of current leakage. Its value depends on the operating temperature to

some extent, but mainly on the length of service of the rectifier itself. The lower curve of Fig. 2-B illustrates a typical leakage current characteristic at an ambient temperature from 10° C. to 40° C. At both ends of this temperature range, the leakage current increases. Under all temperature conditions, however, the current leakage decreases with the life of the rectifier. The curve represents a typical reverse voltage-current density relation observed with two plates opposing each other. In the actual three-phase rectifier circuit, the reverse current is somewhat higher than that shown in Fig. 2-B since the effect of all plates is integrated over the entire cycle. Computations and subsequent tests showed that the total current leakage of a 200-ampere rectifier is approximately 2.4 amperes at the start of service and is in the neighborhood of 1.6

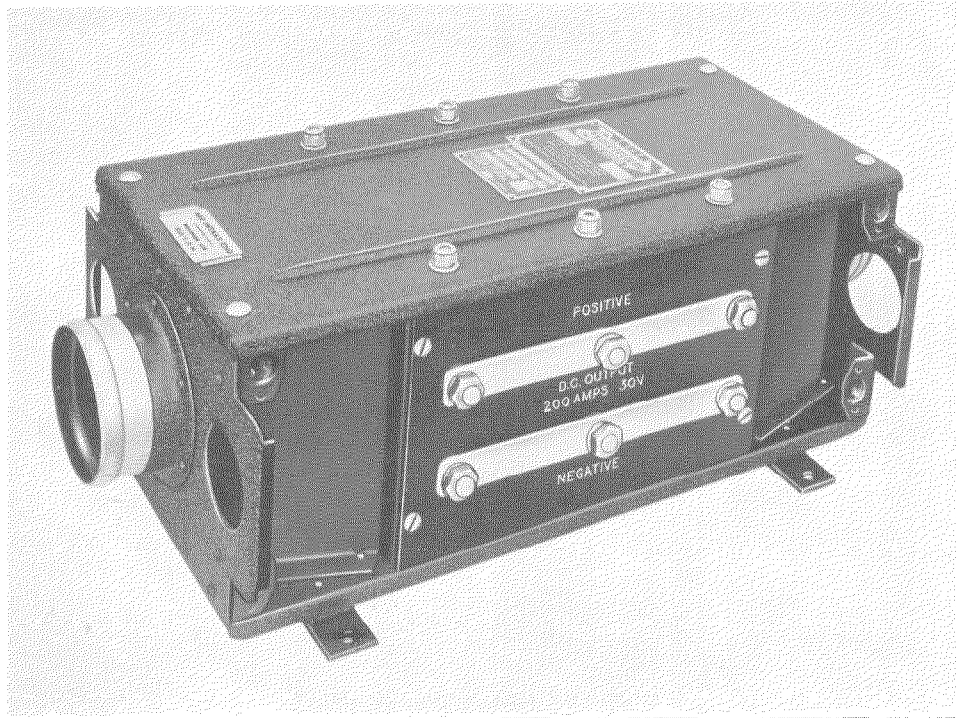

Fig. 4—Aircraft Rectifier, same as Fig. 3, Side Covers Open, Ready for Installation of Conduits and Cables.

amperes after 500 hours of continuous operation.

The necessary a-c input voltage to give the required direct current output voltage is computed by means of already-established formulas.<sup>4, 5, 6</sup>

$$V_{ac} = 0.74 \times 30 + 2 \times 1 \times 2.7 = 27.6 \text{ volts.}$$

The performance of this rectifier is illustrated in Fig. 5.

### Transformer

In the design of the transformer, full advantage was taken of improved materials and latest methods. Following general aircraft practice of obtaining minimum weight and highest efficiency, high-permeability and low-loss silicon steel was selected for the core structure.<sup>7, 8</sup> The transformer obviously must operate under conditions of high magnetic induction, and this type of steel, insulated with silicate glass and processed

under a rigidly controlled technique of heat treatment and crystal orientation, gives maximum flux, some 40 per cent more than the best

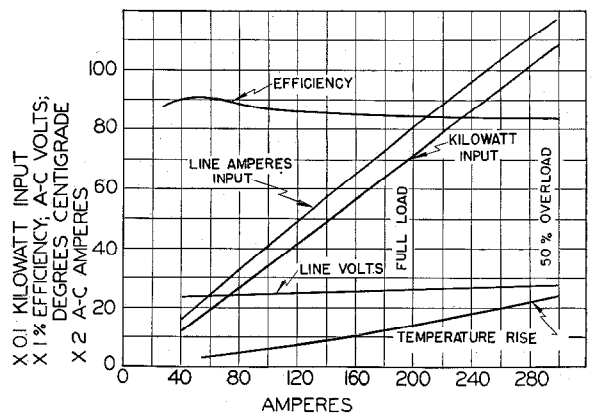

Fig. 5—Operating Characteristics of Rectifier Unit shown in Figs. 3 and 4. Rated at 200 amperes, 30 volts at Ambient Temperatures from minus 70° C. to plus 50° C. Unit is capable of withstanding 50 percent Current Overload Continuously for ten hours.

transformer steel, with a remarkably small external magnetizing force. Further, this material not only permits lower total losses, including copper losses, but also better balance, greater short time overload capacity, lower impedance and better voltage regulation. The latter measured 12 per cent, and with the flux density of 16,150 lines per square centimeter and resulting core losses of 320 watts at 350 cycles per second, the efficiency of the 33.7-kva transformer was 95 per cent at full load. As the frequency increases, the core losses decrease. Even with the frequency 25 per cent higher, when the flux density was in the neighborhood of 12,800 lines per square centimeter, the core losses decreased almost 40 per cent. At these high frequencies, the machined butt joints also added to the high performance of the transformer.

Both windings were designed with a view of keeping copper losses to the minimum. This has been accomplished through the use of rectangular wire for the primary windings and very thin and

wide flat copper strips for the secondary windings. Thus, the radiating area of the copper was increased markedly and, since there is a certain amount of skin effect in the conductor under conditions of high frequency and high current, this feature helped greatly in minimizing copper losses. With a current density of 6600 amperes per square inch in the primary winding and some eight per cent less in the secondary, the copper losses at 75°C. were only 620 watts and 610 watts for primary and secondary windings, respectively.

All other material employed in this transformer also was selected for achieving optimum performance. The winding, for instance, is separated from the core by means of heat-resistant, glass cloth-base laminated plastic. The ventilating ducts in the winding are formed by means of rods made from the glass cloth-base plastic. The frame itself contains four corner supports welded from high strength aluminum alloy. The supports are clamped to the core with steel tape in a manner such that vibration

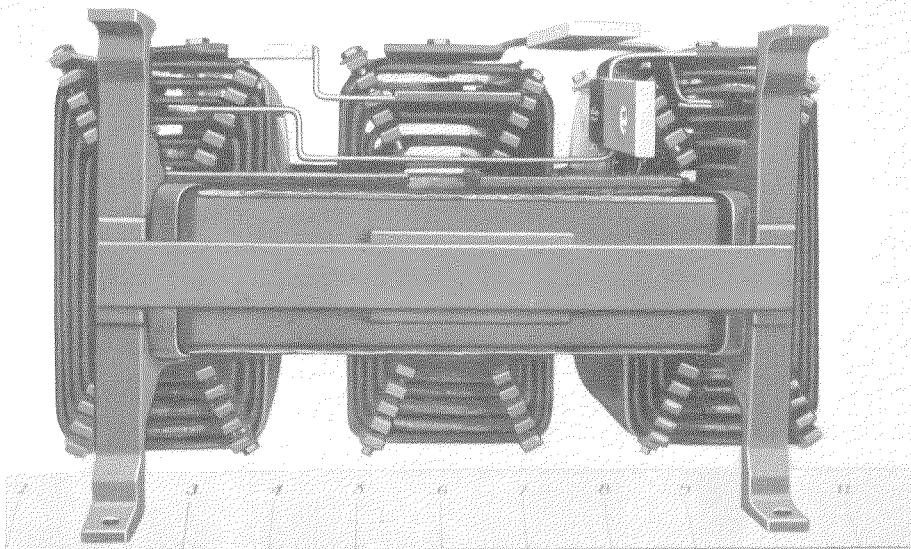

*Fig. 6—Aircraft Transformer, Air-Cooled, 33.7-kva, 400-cycle, 3-phase, 250-volt primary, 28-volt secondary. Weight 30 pounds. Front View.*



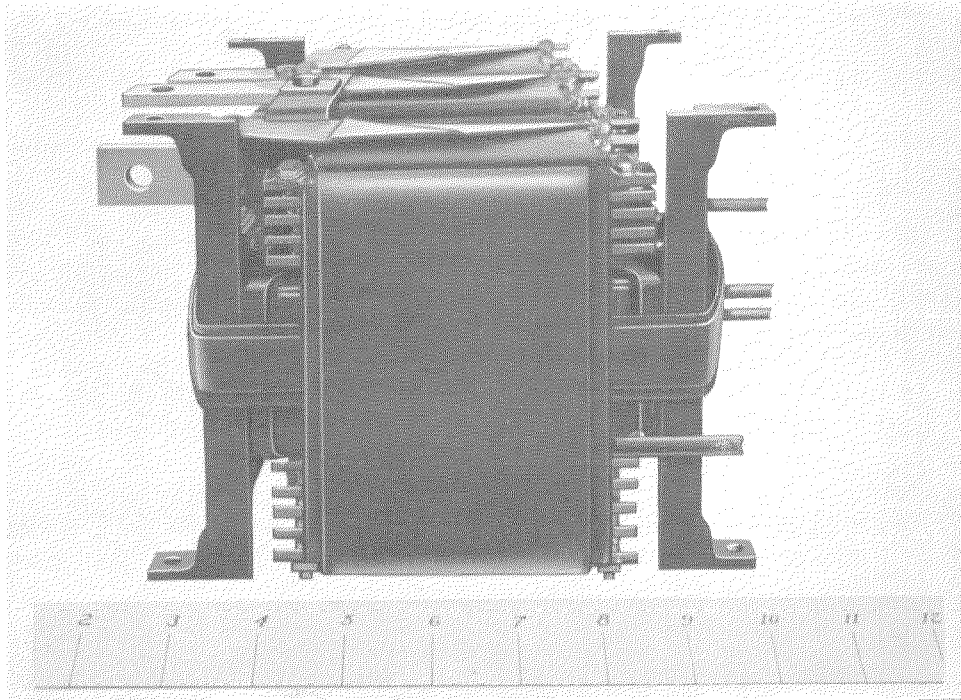

Fig. 7—33.7-kva, 3-phase Air-Cooled Transformer, same as Fig. 6. Side View.

stresses are taken by the supports rather than by the entire transformer structure. This type of frame construction contributed greatly in achieving lightness of weight (Figs. 6 and 7).

The secondary winding, carrying approximately 375 amperes, is spirally wound and its a-c resistance is much lower than the conventional type of winding. The copper loss of 650 watts in the winding at 1000 cycles per second frequency and 150° F. operating temperature would be some six times greater if it comprised a square wire of identical cross-sectional area and a single layer. Furthermore, the copperfoil winding facilitates cooling, since the thin and wide strip has a surface area of almost six square inches per inch of conductor length, whereas, the square wire conductor has a surface of one square inch per each inch of conductor length.

#### **Alternator**

During the past year, several alternators were designed, built and tested. Two voltage ratings

(250 and 28 volt line) were tried. The alternator used in the arrangement of Fig. 1 was of 35-kva, 250-volt rating. Two more alternators became available: one of 16-kva capacity operating with the rectifier delivering 400-ampere, 30-volt output; another of still lower kva rating, Fig. 8.

This aircraft alternator (Fig. 8) is rated at 11 kva, 3 phase, 30 volts, 211 amperes, 440 cycles and is capable of delivering 10.45 kw at 95 per cent power factor and at the minimum speed of 4400 revolutions per minute. It was designed for a field current which could be handled by the 28-volt, 200-ampere voltage regulator normally available; therefore, it does not represent the lightest possible design attainable by a heavier field current (12 amperes) and a special regulator. Its approximate weight is 33 pounds.

The stator is delta connected with two parallel circuits per phase. There are 72 semi-enclosed slots with two slots per pole per phase and full pitch winding. Rectangular wire is used in the stator winding to obtain maximum ratio of

copper to slot area. Paper insulation is used since the alternator temperature rise is kept within Class A insulation limits. The 12-pole rotor is skewed. Metallic slot wedges are used for the rotational speeds encountered. The field coil ends are strapped to metallic reinforcing rings.

Forced draft cooling is employed. A six-inch total pressure differential is required with a two-inch blast pipe. The internal air passages are arranged for reverse flow of cooling air so that more efficient use is made of the circulating air.

### 800-Ampere, 30-Volt Electric System

The first unit (Fig. 1), with rectifier operating characteristics as indicated in Fig. 9, and a total

output of 24.6 kw (0.6 kw of which was used by the field circuit of the alternator), was tested under ordinary laboratory conditions and gave an overall efficiency of 72 per cent. The efficiencies of the transformer and rectifier are affected by the amount of cooling air and, therefore, by the operating temperature of the respective units, Figs. 10 and 11. The amount of cooling air was varied from 750 cubic feet per minute to 1300 cubic feet per minute. Over this range of volume of cooling air, the combined efficiency of the transformer-rectifier unit remained practically constant, since the efficiency of the transformer decreases and that of the rectifier increases with temperature rise. It follows then that the minimum volume of air

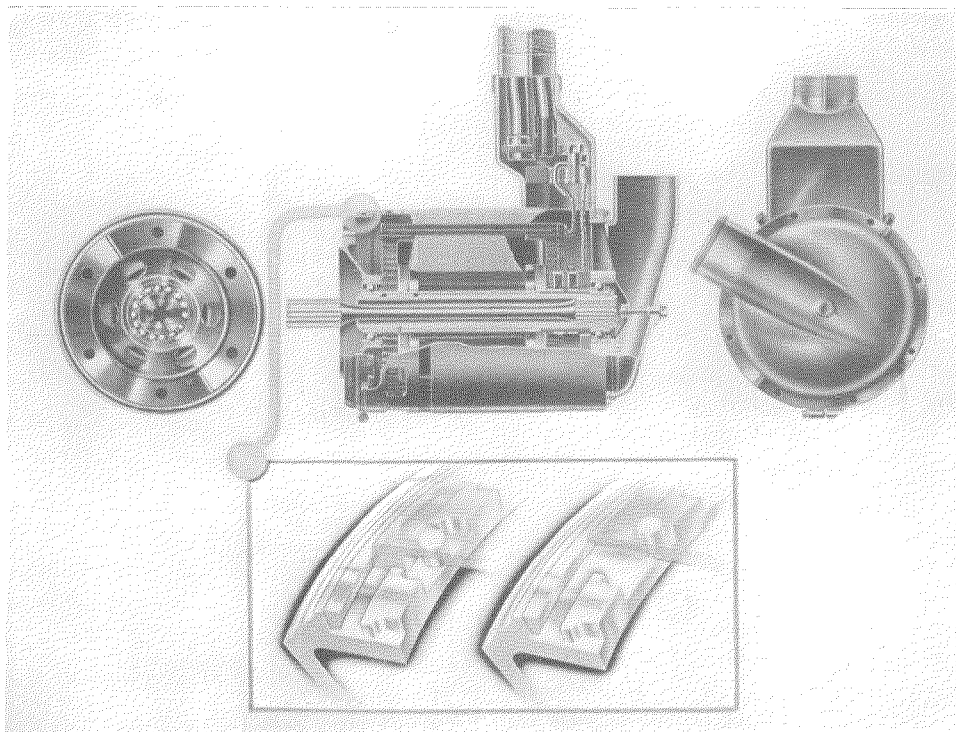

*Courtesy of Chrysler Corporation.*

*Fig. 8—11-kva, 3-phase Air-Cooled Alternator, Weight 33 pounds.*

*Top, from left to right: 1. Engine pad view of the alternator. 2. Section through alternator. 3. Cooling cap and terminal block.*

*Bottom, enlarged details of Bayonet Type Mounting Flange: On left, alternator initially placed on flange; on right, alternator in locked position.*

can be chosen to maintain both components within their safe temperature limits.

**High-Altitude Operation**

High-altitude operation imposes unusual conditions of rarefied air and extremely low temperature. The 200-ampere rectifier unit without transformer was tested in a stratosphere chamber under 45,000 feet altitude and minus 43° C. temperature conditions.

The results can readily be analyzed in the light of the characteristics shown in Figs. 10 and 11. Referring to Fig. 10, it can be seen that rectifier efficiency decreases steadily as the temperature goes down. At the same time, however, efficiency increases with the reduction of the cooling air as a result of the higher internal temperature of the rectifier. The net result is that both effects tend to balance each other and thus the efficiency of the rectifier is maintained at a point governed by the percentage of loading.

**Conclusion and Acknowledgment**

It is gratifying to note the importance and the large volume of work being carried on by able engineers and manufacturers connected with or serving the aviation industry. Their efforts doubtless will make available several flexible electric systems from which to choose one meeting specific requirements.<sup>9</sup> In this connection, the writer wishes to express his thanks to the officers of the Army Air Forces, engineers of the Chrysler Corporation and to colleagues in his own organiza-

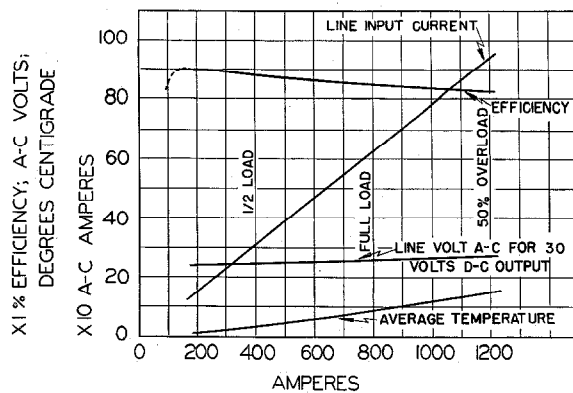

Fig. 9—Performance Characteristics of 800-ampere, 30-volt Rectifier used in Fig. 1 System.

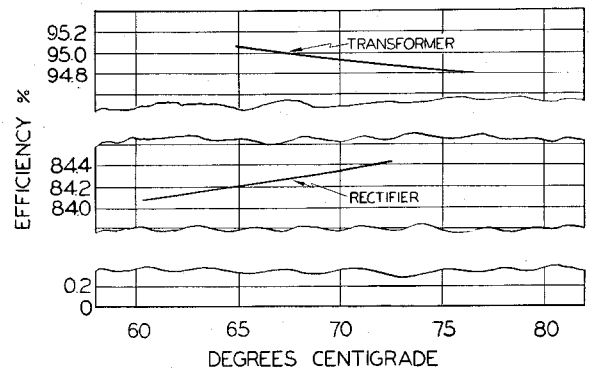

Fig. 10—Characteristics Illustrating the Effect of Temperature upon Efficiencies of Transformer and Rectifier.

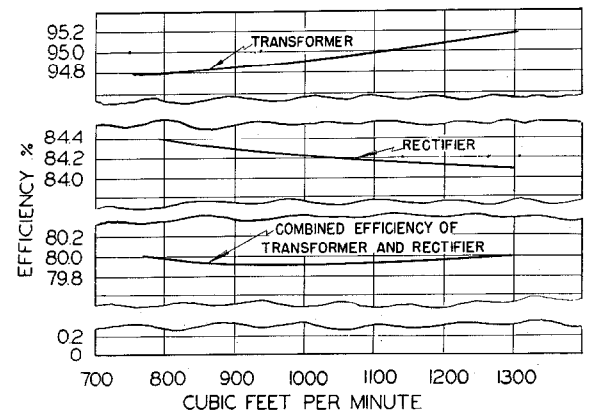

Fig. 11—Transformer and Rectifier Efficiency Characteristics as Affected by the Amount of Cooling Air.

tion for their cooperation in carrying on these experiments.

**Bibliography**

1. "Applications of Electric Power in Aircraft," by T. B. Holliday, *Electrical Engineering*, May, 1941.
2. "Optimum Voltage for Airplanes," by V. H. Grant and M. F. Peters, *Electrical Engineering*, October, 1939.
3. "Aircraft Electricity as the Airline Operator Sees It," by P. C. Sandretto, *S. A. E. Journal*, Vol. 48, No. 4, April, 1941.
4. "Selenium Rectifiers and Their Design," by J. E. Yarmack, *A. I. E. E. Transactions*, Vol. 61, July, 1942.
5. "The Characteristics and Applications of the Selenium Rectifier," by E. A. Richards, *Journal of the I. E. E.*, Vol. 88, Part III, No. 4, December, 1941.
6. "Selenium Rectifiers for Closely Regulated Voltages," by J. E. Yarmack, *Electronics*, September, 1941; *Electrical Communication*, Vol. 20, No. 2, 1941.
7. "Hipersil, a New Magnetic Steel and Its Use in Transformers," by J. K. Hodnette and C. C. Horstman, *Westinghouse Engineer*, August, 1941.
8. "Better Magnetic Core Steel Aids Transformer Engineer," by C. C. Horstman, *Product Engineering*, January, 1943.
9. "Principles of Aeronautical Radio Engineering," Chapter XI, by P. C. Sandretto, McGraw-Hill Publication, 1942.

# Physics and the Static Characteristics of Hard Vacuum Valves\*

By J. H. FREMLIN, M.A., Ph.D., A. Inst. P.

*Standard Telephones and Cables, Ltd., London, England*

THE characteristics of hard valves have been considered in detail by many hundreds of people for a large part of their working lives. It is likely, therefore, that mention of many points that seem to some to be of outstanding interest will be omitted.

Discussion will be confined mainly to the most essential valve properties and little will be said, for example, about secondary emission, or anything at all about such things as contact potentials, cathode coating characteristics, grid emission or, especially, noise.

The physical laws involved in hard valve design are mostly known to adequate accuracy. The problems lie largely in the application of well known laws to complicated systems. This is not always easy. In order to get results of practical value it is often necessary to make drastic approximations. By this is not meant merely that we have to consider theoretically structures that are much simpler than those in which we are really interested. We have also to employ physical concepts which are known to be incorrect, in the not invariably misplaced hope that the errors so introduced will be negligible. And the success of the physicist in valve design depends less on his knowledge of the details of natural law than on his knowledge of when any such laws may be neglected with impunity.

Thus, most elementary theory of thermionic valves can proceed quite adequately on the assumption that current as well as potential distribution is continuous through space. Knowledge of the particulate nature of electricity, which was gained before 1900, is not used and is, except by those who have the courage to work on the vexed question of noise, often effectively banished from the mind. It is hoped to give here some indication of the limits within which such simple conceptions are useful. These limits are surprisingly wide and it seems very striking that we even now only occasionally need to advance

from the continuous fluid theory of electricity to the particulate theory and that the further advance to the higher forms of continuous function provided by wave mechanics seems unlikely to be called on extensively for a while yet.

From a practical viewpoint the characteristics of a valve may be regarded as the relations determining the currents to the various electrodes of the valve as a function of the voltages supplied to these electrodes.

Consider first the simplest type of valve, the diode. It has been shown by Langmuir that the current in space charge limited conditions will always be proportional to the three halves power of the voltage, whatever the shape of the electrodes. This has been shown to be true still more generally by Wheatcroft, using the method of dimensions, for all cases in which the velocity of a current element at any point is proportional to the square root of the potential at that point. This criterion will cover certain forms of gas discharge as well as hard valves. The range of validity of this argument is not, however, quite clear. I cannot see how the required limitation to space-charge limited conditions comes in.

The constants of proportionality for plane and cylindrical diodes have, as is well known, been calculated by Child and Langmuir. The physical laws involved are solely those described in the fundamental definitions of charge and potential, as expressed in Poisson's equation  $\nabla^2 V = -4\pi\rho$  together with the Newtonian laws of mechanics. The way in which the proof is written out usually obscures the fact that a particulate theory is unnecessary so long as the ratio of charge to mass of electricity is correctly included.

Some difficulty is sometimes found with the assumption of zero emission velocity on the grounds that in this case there will be no emission at all with zero or negative field at the cathode and saturated emission with the smallest positive field. This difficulty is, however, merely the familiar one of determining by inspection the value of 0/0. In fact, the emission with zero field and zero emission velocity is indeterminate in

\* Paper presented before the Institute of Physics, April 6, 1943.

the absence of further information; it is quite incorrect to say that emission is obviously zero. Its value depends upon the space charge considerations given by Child and Langmuir, for if the current fell below the calculated value a positive field would exist and full emission would occur till space charge between anode and cathode just neutralised the field, while if the current were too great a negative field would occur and the current would cease entirely until this field had vanished. The indeterminacy is, therefore, resolved by the fact that any current differing by a finite amount from that calculated is quite certainly not in equilibrium.

For an infinite parallel plane diode with anode cathode distance  $d$  we have the current density  $i_a$  given by

$$i_a = \frac{2.34 \times 10^{-3} V_a^{3/2}}{d^2} \text{ mA./sq. cm.}$$

for zero emission energy. A similar formula for the current per unit length in an infinite cylindrical diode is also obtained. For reasonably large voltages these formulae hold satisfactorily up to the largest current densities which the cathode can give without saturation. For small voltages, even if allowance is properly made for contact potentials, the current is found in experimental tubes to be persistently larger than predicted by the Child-Langmuir formula, and current actually continues to flow when the anode is at a slightly negative voltage. We can, however, say that experiments on diodes have shown that over a wide range it is not usually necessary to take account of the particulate nature of electrons and can therefore proceed with some confidence to neglect it in our first consideration of more complicated valves. While neglecting it we must not, however, forget it.

Consider now the triode. Even with the drastic simplification suggested it is not possible to solve Poisson's equation for the boundary conditions existing in an ordinary triode. It is difficult even to write down what the boundary conditions are until we have left out the grid supports and insulators and considered an infinite parallel plane or cylindrical system to eliminate all edges and ends. With the austerity triode thus produced, we can write down the conditions but we still cannot solve the equations. Resort is usually

made, therefore, to a subterfuge. The system usually employed is to determine, by intuition or otherwise, the dimensions and electrode potentials of a diode, "equivalent" to the triode with which we are concerned, in terms of the geometry and electrode potentials of the triode. The meaning and means of determining "equivalence" merit some discussion. It is clear that, to the approximation previously decided upon, the current emitted in each valve must be such as just to reduce to zero the normal electric field at the cathode surface. It is often stated, therefore, without more ado, that the equivalent diode is simply a diode which in the absence of space charge has the same electric field at the cathode surface. Now the electric field at any point on the cathode of a triode can normally be found, and is found, to be a linear function of the grid and anode voltages  $V_g$  and  $V_a$ , respectively. If the cathode is far enough from the grid for the electric field at its surface to be uniform, it may be written  $(V_g + DV_a)/(l_g + Dl_a)$  where  $D$  is a function of the grid geometry and position which we shall call the "penetration factor";  $l_g$  is the distance between grid and cathode and  $l_a$  the distance between anode and cathode. Any diode with cathode-anode distance  $K(l_g + Dl_a)$  and anode voltage  $K(V_g + DV_a)$  would give this cathode field. We can, of course, define equivalence in any way we like, but if, as is normally the case, we wish to use the diode to forecast the current density in the triode, we must not assume that all such diodes will require the same current to neutralize their admittedly identical cathode fields. This is clearly not the case; if we look for a moment at Child's equation

$$i = \frac{2.34 \times 10^{-3} V^{3/2}}{d^2}$$

we see that it can be written as

$$i = \frac{2.34 \times 10^{-3} E^{3/2}}{\sqrt{d}} \text{ mA./sq. cm.,}$$

where  $E$  is the normal cathode field in volts/cm., and this clearly depends upon  $d$  as well as upon  $E$ . We have, therefore, to find some further criterion to tell us which of the infinite series of possible diodes to use. There is no a priori reason for assuming that the same distance may be chosen for all currents but there is experimental evidence that current is proportional to

$(V_g + DV_a)^{3/2}$  in a plane triode, so we shall add one more to our list of assumptions by supposing that the diode distance  $l_d$  is independent of the voltage. We can then find what the distance is quite readily by considering the potential distribution in the triode when the grid is positive at such a potential as to be itself uncharged, when, of course, the potential is  $\alpha l^{4/3}$ . Hence

$$l_d = l_g \left\{ \frac{1 + D \left( \frac{l_a}{l_g} \right)^{4/3}}{1 + D \left( \frac{l_a}{l_g} \right)} \right\}^3$$

and from this we find the total emission current density

$$i = \frac{2.34 \times 10^{-3} (V_g + DV_a)^{3/2}}{l_g^2 \left\{ 1 + D \left( \frac{l_a}{l_g} \right)^{4/3} \right\}^{3/2}} \text{ mA./sq. cm.}$$

Now there is no theoretical justification for the supposition that there actually exists an equivalent diode of invariable dimensions. In fact, it has been pointed out by Rodda and by Dow that such a diode is certainly non-existent. The analysis which I have given assumes that  $D$  remains constant, which is untrue if space charge exists between grid and anode, and Rodda gives a formula allowing for the variation of equivalent diode dimensions with voltage that for large current densities and large grid-anode spaces gives appreciably different results from the formula which I have given above. I think, however, that the non-uniformity of current distribution in the grid plane, neglected in both formulae, may well be as important as the differences between them. In many cases, as Dow has pointed out, it is quite accurate enough to take the equivalent diode distance simply as  $l_g + Dl_a$ . As in the case of the diode, this formula breaks down for very small emission current densities; it has also an extra and independent condition in which breakdown occurs, i.e., when  $V_g$  is positive and  $V_a$  is small or negative. This is quite apart from the effects of secondary emission.

Determination of the penetration factor  $D$  in the absence of space charge is necessary before any of the triode formulae can be used. Apart from mathematical methods, not intended to be discussed here, it is possible to do this in many cases by the use of mechanical models, particu-

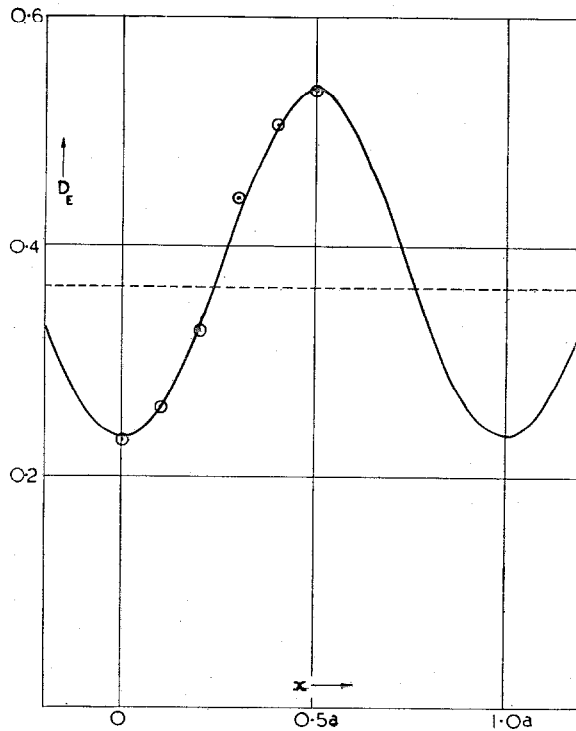

Fig. 1— $D_E$  is the electrostatically calculated value of the penetration factor at a point on the cathode surface. The curve shows its variation according to theory with the distance  $x$  measured from a point immediately below a grid wire. The points  $\odot$  were obtained experimentally on the rubber sheet model. The dotted line shows the value of  $D$  obtained from the Schottky-Miller formula.

$$d = 0.0322a, \quad l_g = 0.40a, \quad l_a = 1.40a.$$

larly by the use of a stretched membrane in a state of uniform tension as proposed by Dr. Moon\*—hereafter referred to as a rubber sheet—or by an electrolytic trough. As I have worked myself with the former and as I shall want to mention it in other connections, its main properties will be briefly described.

If the sheet is stretched tightly in a horizontal plane and if points on it are then slightly displaced vertically by suitably applied pressure, any points on the free parts of the sheet will conform to the equation

$$\frac{\partial^2 h}{\partial x^2} + \frac{\partial^2 h}{\partial y^2} = 0,$$

where  $h$  is the vertical displacement of the point from the horizontal plane containing the co-

\* A rubber sheet was used for qualitative demonstration of current flow in a triode considerably earlier by Morecroft, but it does not appear that the possibility of quantitative determination of potential or current distribution was then realized.

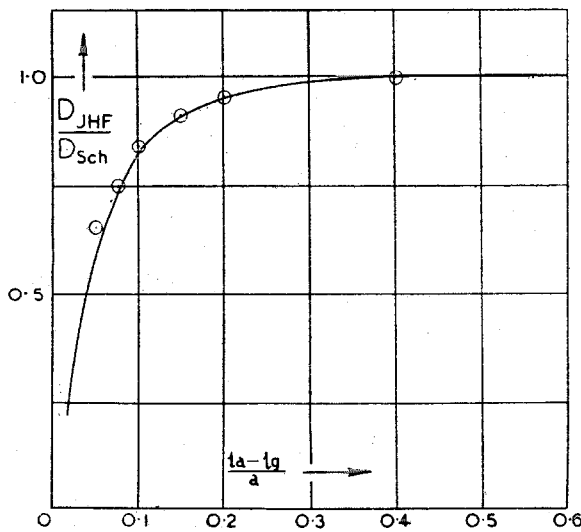

Fig. 2—Variation of penetration factor  $D_E$ , calculated by electrostatic image theory, from the value given by the Schottky-Müller formula ( $D_{SCH}$ ), as the grid anode distance becomes small. Points  $\odot$  obtained from the rubber sheet model.

ordinate axes of  $x$  and  $y$ . This equation is of the same form as Laplace's equation for a potential distribution independent of the  $z$  axis, the displacement  $h$  taking the place of the potential. We can then determine the form of the potential distribution for any system of electrodes whose geometry varies only in two dimensions by applying models of such electrodes to the stretched sheet, their displacements being proportional to the potentials intended to be carried by the electrodes. The slope of the rubber sheet at any point, for example at the edge of the "cathode" model, will then be proportional to the electric field at the corresponding point in the real valve. We can therefore measure  $D$  quite easily by measuring the height through which it is necessary to move the grid model to compensate exactly the effect, on this slope at the cathode, of moving the anode model through one unit of height. A small mirror attached to the sheet and reflecting a spot of light on to a fixed scale gives a convenient and sensitive method for detecting small changes of cathode field.

This method has been used to check a calculation of the change of  $D$  along the cathode when the distance between cathode and grid is small compared to the grid pitch (see Fig. 1), to check a calculation of the effect on  $D$  of having the grid-anode distance small compared to the grid pitch (see Fig. 2), and to compare the formulae

given by various authorities for the penetration factor in triodes with very thick grid wires. Incidentally, the best of these would appear to be that given by Ollendorff; it also lends itself conveniently to the construction of a nomogram for its application.

The rubber sheet method has also been applied to the measurement of inter-electrode capacities and again is capable of dealing with cases which are entirely intractable mathematically. To show that the space-charge-free result of rubber sheet experiments may be of practical value, Fig. 3 gives the electrostatically calculated value of  $1/D$  midway between grid wires, for small grid-cathode distances, together with the results from a real triode, in which the electrodes were mechanically adjustable.

Enough probably has been said to support my claim that  $D$  can be determined; for cases which cannot be treated on the rubber sheet, the electrolytic trough may be used. We are not yet, however, quite out of the wood. The field at the

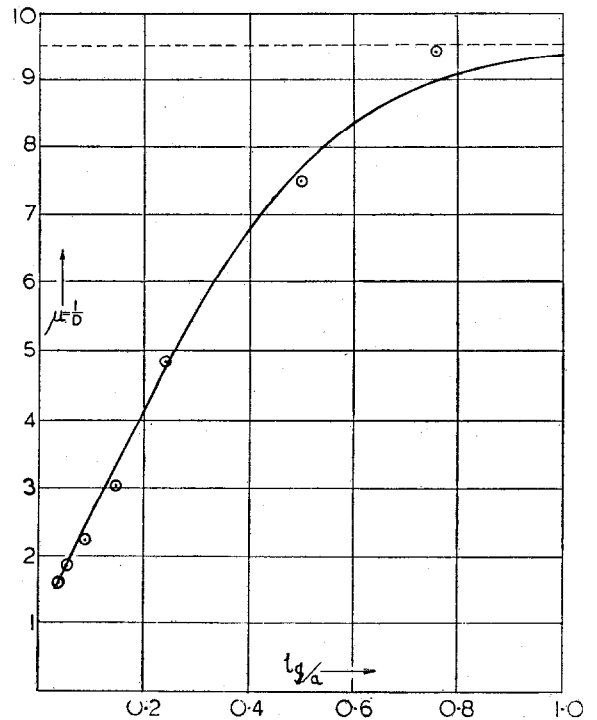

Fig. 3—Variation of penetration factor  $D$  and the corresponding amplification factor  $\mu$  with cathode grid distance when this is small compared to the grid pitch. The curve is calculated from electrostatic image theory and the points  $\odot$  are the values found near cut-off in an experimental valve.

$$d = 0.005 \text{ cm.}, \quad l_a - l_g = 0.539 \text{ cm.}, \quad a = 0.155 \text{ cm.}$$

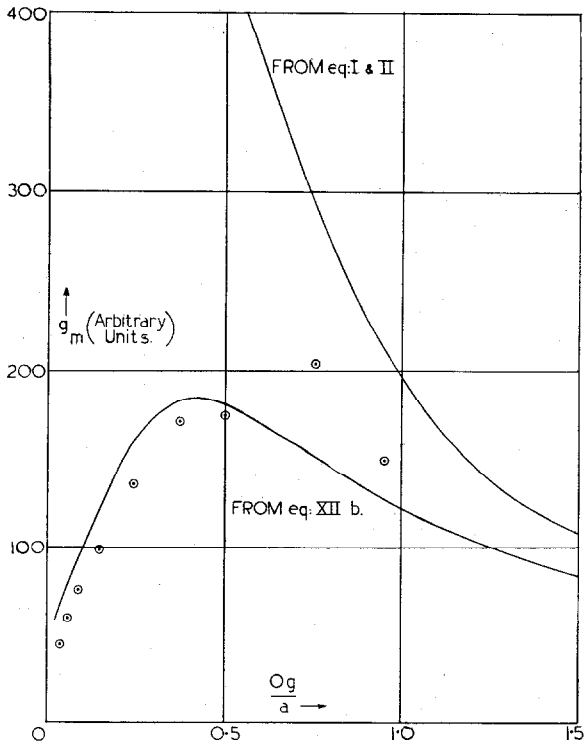

Fig. 4.—Variation of mutual conductance  $g_m$  per unit area with cathode grid distance.

cathode may not be uniform, either because the grid is too close or because the cathode is in filamentary form, so that every point of the cathode would appear to require its own private equivalent diode. When the grid is too close we can for small current densities use the calculable cut-off value of penetration factor. This is shown in Fig. 4 in which the lower full curve represents the calculated value of mutual conductance derived from the current equation given above and gives reasonable agreement with experiment for the small current densities used. The upper curve shows the value of mutual conductance obtained from the older formula for current based on an arbitrary equivalent diode distance. For larger currents the mean amplification factor increases rapidly and the current may increase far more rapidly than would be suggested by the three halves power law.

When the cathode is filamentary we can most conveniently assume it to be flat with an "effective area" dependent more upon the distribution of filament limbs than upon their own surface area. I know of no satisfactory general method

for determining this "effective area" except by direct experiment.

Now the difficulties mentioned so far are not physically very important. They are difficulties due mainly to complexity of detail rather than to inadequacy of the physical laws assumed to hold. If I shot a bucket of assorted ball bearings down a flight of steps, my inability to determine their exact tracks by calculation would not be materially affected by my using Einstein's laws of motion rather than Newton's.

The simplification of assuming the space current in a valve to behave like a uniform fluid is quite close enough to the truth within limits. These limits will now be considered a little more closely. I think that we shall be able to see that many of them will be pushed back a very considerable distance by taking into account our physical knowledge of the particulate nature of electrons.

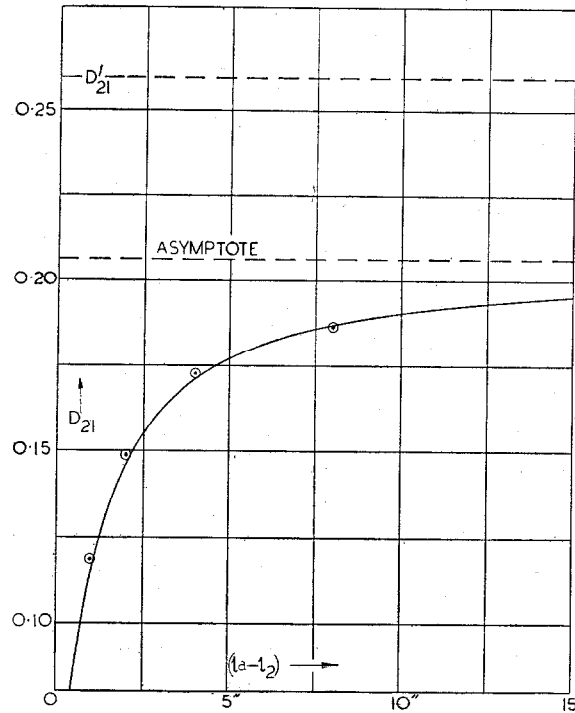

Fig. 5.—Variation of inner penetration factor  $D_{21}$  with anode position in a tetrode.

$$a_1 = a_2 = a, \quad \frac{l_1}{a} = 1.25, \quad \frac{l_2 - l_1}{a} = 1.0, \quad \frac{d}{a} = 0.063.$$

The dotted line represents the value of  $D'_{21}$ , the value calculated for a triode, with its plate in the same position as the screen grid of the tetrode. Points  $\odot$  from the rubber sheet model.



It has been known for many years that when the voltage on the anode of a diode is reduced to small values, the three halves power law is not obeyed and that current continues to flow, falling off exponentially with anode voltage, even when the anode is negative with respect to the cathode. This may readily be explained on a particulate theory, on the assumption that electrons are emitted with random energies distributed according to the normal Maxwellian laws where the number having energy greater than any given value  $eV$  falls off as  $e^{-eV/kT}$ . We can get an immediate check on this by looking at the magnitudes involved; thus experimentally, the energies of the electron would have to be of the order of tenths of a volt to explain the observed effects. If we take the energy as corresponding to 1/10 volt, or 1/3000 ESU, the energy of the electron will be  $e/3000$ . This must, if the hypothesis be true, be of the order  $kT$  where  $k = 1.4 \times 10^{-16}$  and  $T$  is, say,  $1000^\circ$  Abs. Hence  $e$  must be of the order  $1.4 \times 3 \times 10^6 \times 10^{-16}$  or  $4 \times 10^{-10}$  ESU, which is, of course, in adequate accord with our knowledge of the electronic charge. Thus we are able to use the improved physical theory to give a quantitative explanation of an effect which could not even be qualitatively explained by the more elementary laws previously supposed. For exact calculation of current in a diode we turn again to Langmuir.

This point is of importance in triodes as well as in diodes. The simple theory suggests that we could make a triode of infinite slope if we could only make grids of fine enough pitch and put them close enough to the cathode. Consideration of the ununiform nature of the current soon shows, however, that the engineer may not be required to make grids of  $1 \mu$  wire  $5 \mu$  from the cathode, which will no doubt prove a great disappointment to him. There will in fact be a limiting slope which will not improve as the spacings are reduced but will depend upon cathode temperature alone. For normal present-day cathodes this limit is in the region of 10 ma/v per mA. It might appear, therefore, as if triode design in the future will have to be done by the chemist rather than by the valve engineer though the usefulness of even attainable slopes may be limited by the high corresponding capacity.

Consider next the limitation upon the above mentioned triode formulae when the anode be-

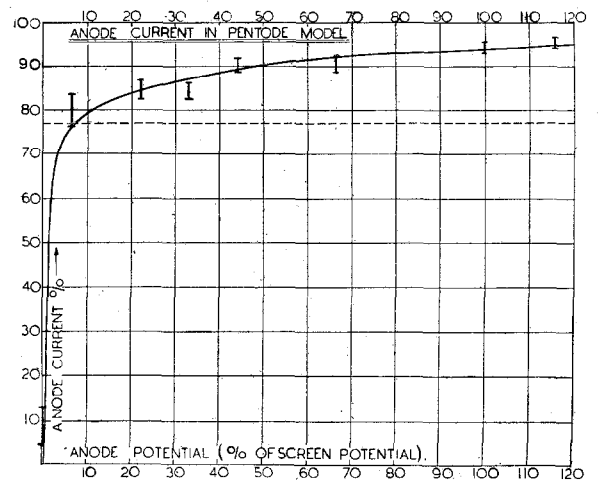

Fig. 6—Variation of anode current, as a percentage of total current, in a pentode model on the rubber sheet (with lined up control and screen grid). The points  $I$  were found by observation of the distribution of steel balls between anode and screen; the height of each represents the probable statistical error. The dotted line represents the proportion which would have reached the anode if there were no focusing effect by the control grid and if no reflection occurred at the suppressor grid.

comes negative. The total emission current will then be collected by the grid but in nearly all cases will be several times less than that obtained from the formula. This is not easily explicable on the continuous fluid picture of current but is readily explained on the particulate theory by supposing that most of the electrons miss the grid wires on their first transit and are reflected back by the anode into the grid cathode space; they may oscillate from one side of the grid to the other a large number of times before collection and thus increase the space charge in the cathode grid space a number of times. This behaviour may be examined very easily by the use of the rubber sheet already mentioned; if the upward vertical displacements are taken as corresponding to negative potentials it can easily be shown that the track of a small steel ball on the sheet will correspond to that of an electron in the valve, though friction makes long paths inaccurate and space charge cannot be simply allowed for.

The cases in which the electron theory is required for dealing with the static characteristics of triodes and diodes are relatively few and to most valve workers of small, though perhaps of increasing, importance.

But when we go on to consider briefly multi-electrode valves the position is markedly

changed. The most important characteristics of a pentode, for example, are seriously different from those which would be forecast from the first approximate theory. We can, of course, use the same methods as earlier to calculate the inner and overall amplification factors, and it may be noted in passing that the "inner  $\mu$ " of a tetrode or pentode is often appreciably different from that calculated for a triode with plate in a position corresponding to the screen in the multi-electrode valve, and is given with very fair accuracy by the formulae based on electrostatics (see Fig. 5). In a tetrode, the total emission current may also be given by a formula similar to that given for triodes. If we attempt to determine the current distribution between screen and anode, however, we find ourselves often very far from the truth, owing to the "focusing" action of the control grid. The use of the electron theory, with the help of the rubber sheet, enables us to design lined up tetrodes in which the current distribution may be of any type desired.

In a pentode, the situation is much worse for those who like their currents smooth. Not only is the current distribution between screen and anode only estimable after repeated recourse to the rubber sheet, but the total emission itself is appreciably reduced by the space charge due to electrons reflected by the suppressor. Even more disturbing, the overall amplification factor, which for simpler valves has always been close enough to the electrostatically calculated value, fails us. This is in part due to the increase of space charge as a result of the reflected electrons just mentioned, but it is in much greater part due simply to the change in current distribution between the screen and the anode. The potential distribution between screen and suppressor is considerably affected by the anode potential and, as the anode potential increases, the number of electrons reflected back to the screen decreases with a consequent increase of anode current which is quite independent of any change in total emission. Here again, then, we have a phenomenon which cannot be explained even qualitatively without

an understanding of the particulate nature of electricity. As evidence for the explanation just given, Fig. 6 shows the anode current characteristic of a pentode, obtained by counting the numbers of steel balls reaching the anode of a rubber sheet model. The amplification factor calculated by purely electrostatic means was about 3,300. The effective amplification factor determined from the rubber sheet results depends on the current, but at zero control grid bias it would be 97, or 33 times lower than would be the case if reflection did not occur. It consequently seems clear why the impedance of pentodes is often lower than that of beam tetrodes and much lower than would at first sight be expected. It seems too that the design of suppressor grids merits more attention than has usually been given to them in the past.

A further example of this phenomenon occurs in the pentagrid converter, where the electrons reflected in the outer parts of the valve may seriously upset the proper working of the inner. The reflection from the suppressor can, incidentally, be turned to good account; in the transitron oscillator a negative resistance independent of frequency has been obtained by its use.

Now I have attempted to indicate some of the limits of the very simple theory normally used in consideration of valve characteristics. It is to me always surprising that one can get results so close to reality over such a wide range as one does, when it is realised that in a quite reasonable electron stream of, say, 10 ma/sq. cm. at 250 volts, the average distance between individual electrons is about .001", the diameter of a thin grid wire. I have tried to show some of the improvements resulting from the application of the next approximation to reality, and I am looking forward with some interest, not unmixed with apprehension, to the time when this has been sufficiently well worked out to justify the consideration of some of the really very well established non-particulate properties of the electrons themselves.

# Audio and Measuring Facilities for the CBS International Broadcast Stations\*

By HOWARD A. CHINN

*Engineer-in-Charge, Audio-Frequency Division, General Engineering Department, Columbia Broadcasting System, Inc.*

## Introduction

THE main studios for the CBS International shortwave transmitters are housed in the CBS Building in New York City, approximately 37 miles airline from the transmitter location on Long Island, New York. Program material for the transmitters is normally transmitted over three wire-line circuits. In addition, a u-h-f studio-transmitter-link channel, employing an FM transmitter operating in the vicinity of 300 megacycles, is maintained for emergency purposes.

Audio facilities are provided at the transmitter to terminate these circuits properly, to amplify the incoming program material to the level required by the transmitter, and to permit visual and aural monitoring of the program as well as to record all broadcasts continuously.

Complete measuring equipment is also provided in order to conform with the requirements of the Federal Communications Commission and, in addition, to permit the determination of all pertinent operating characteristics.

## Program Audio Facilities

The audio system consists of two regular channels and one auxiliary or emergency channel. One of the main channels is shown in the upper part of the block schematic circuit arrangement of Fig. 1 and, as designated, is located in rack 5, the fifth one from the left in Fig. 2. The second regular channel (identical to the first) is shown in the center portion of Fig. 1 and, as indicated, is located in rack 4.

Each of these channels contains a three-position mixer, whereby program material from any one or more of three sources may be blended together as desired. The three sources, shown at the left in Fig. 1, consist of the regular incoming

program line, a  $33\frac{1}{3}/78$  rpm turntable accommodating both vertical and lateral recordings, and an announcement microphone. These latter facilities make it possible to originate transcribed programs from the transmitter building in the event that in an extreme emergency all program channels to the main studios should fail.

The incoming-line channel is provided with the usual line coil and a mixer control for the adjustment of the program level to the desired value. In addition, a "pre-emphasis" equalizer ( $E_2$ ) is provided in the circuit. This equalizer permits the high-frequency end of the audio spectrum to be increased in level with respect to the low frequencies. (Since it is an equalizer, the low frequencies are actually attenuated with respect to the high frequencies.) The amount of "pre-emphasis" is continuously adjustable from zero to a maximum as indicated in Fig. 3.

The turntable and microphone channels are each equipped with pre-amplifiers ( $A_m$ ), while all three channels have mixer controls ( $VC_1$ ) and on-off keys ( $K_1$ ). The three circuits are combined into a single circuit by means of a minimum-loss mixer-matching network which maintains proper impedance relations at all junctions in both directions.

The output of the mixer-matching network is coupled by means of an impedance-matching transformer ( $C_5$ ) to an automatic gain-controlled program amplifier ( $A_c$ ) whose function, in addition to supplying the required amplification, is to limit automatically any excessive program peaks that would otherwise cause overmodulation of the transmitter.

Following the program amplifier, there is an adjustable band-pass filter which may be employed to limit the width of the frequency spectrum of the program material, if desired. Under certain circumstances this practice may permit a higher average degree of modulation without appreciable sacrifice in quality. For example, in the case of voice transmission the removal of the extreme high frequencies will not affect the intelligibility to any great extent, while removal

\* Manuscript received August 11, 1942. The author currently also is Technical Coordinator, Radio Research Laboratory (OSRD), Harvard University. The New 50-Kilowatt CBS International Broadcasters were described by H. Romander in *Electrical Communication*, Vol. 21, No. 2, 1943.

of the low frequencies results in a considerable decrease in the energy content of the program material.

The band widths of this filter are selected by means of a switch which has positions covering the bands from 60 to 6,000 and from 150 to

4,000 cycles. These band widths were determined by the desire to limit the band width of modulating frequencies while still maintaining a pleasing balance between the high- and the low-frequency limits of the transmission.

Following the band-pass filter there is a line-

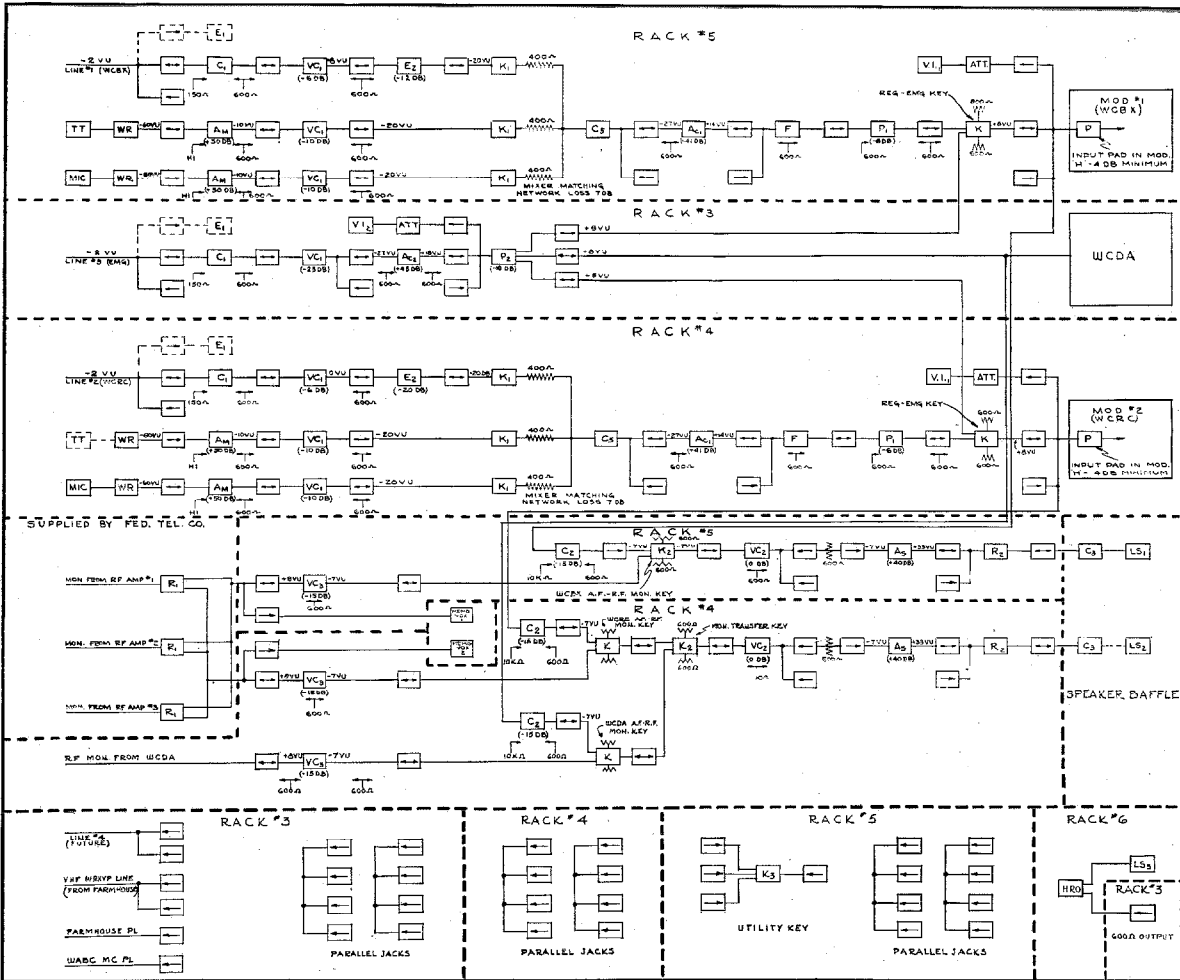

| Code            | Description                    | Code            | Description                       |
|-----------------|--------------------------------|-----------------|-----------------------------------|
| Ac <sub>1</sub> | Channel Amplifier              | K <sub>3</sub>  | Utility Key                       |
| Ac <sub>2</sub> | Channel Amplifier              | LS <sub>1</sub> | WCBX Monitor LS                   |
| As              | Loudspeaker Amplifier          | LS <sub>2</sub> | WCRG Monitor LS                   |
| Am              | Microphone Pre-amplifier       | LS <sub>3</sub> | HRO Receiver LS                   |
| ATT             | V. I. Attenuator               | M               | Microphone                        |
| C <sub>1</sub>  | Line Coil 150:600 Ohms         | P <sub>1</sub>  | Line "H" Pad 600:600 Ohms, 6DB    |
| C <sub>2</sub>  | Bridging Coil 10K: 600 Ohms    | P <sub>2</sub>  | Two-way "H" Pad 600:600 Ohms, 6DB |
| C <sub>3</sub>  | LS Matching Coil 600:8 Ohms    | R <sub>1</sub>  | RF Monitor Relays                 |
| C <sub>4</sub>  | Isolation Coil 600:600 Ohms    | R <sub>2</sub>  | Mon. LS Relays                    |
| C <sub>5</sub>  | Mixer Output Coil 333:600 Ohms | TT              | Turntable                         |
| E <sub>1</sub>  | Line Equalizer (Future)        | VC <sub>1</sub> | Mixer "T" ATT. 600:600 Ohms       |
| E <sub>2</sub>  | Pre-Emphasis Equalizer         | VC <sub>2</sub> | Mon. "T" ATT. 600:600 Ohms        |
| F               | Spec. Band Pass Filter         | VC <sub>3</sub> | RF Mon. "T" ATT. 600:600 Ohms     |
| HRO             | Receiver                       | VI <sub>1</sub> | Volume Indicator                  |
| K <sub>1</sub>  | Mixer Key                      | VI <sub>2</sub> | Volume Indicator                  |
| K <sub>2</sub>  | RF-AF Mon. Key                 | WR              | Wall Receptacle                   |

Fig. 1—Block Schematic Diagram of Audio Facilities for CBS-International Broadcast Stations.

isolation pad and then a "regular-emergency" program channel switch. When operated to the former position, the output of the channel just described is transmitted to the modulator. When operated to the latter position, the output of an emergency program channel is connected to the modulator.

The emergency channel is indicated in Fig. 1 in the area designated "rack 3." As shown, it is normally connected to a spare line (#3) and its output is made available simultaneously to the three shortwave transmitters. This is accomplished by the use of a three-way output pad ( $P_2$ ).

### Audio Monitoring Facilities

The visual monitoring facilities consist of standard volume indicators<sup>1</sup> ( $VI_1$  on regular

<sup>1</sup>"A New Standard Volume Indicator and Reference Level," by Chinn, Gannett, Morris, *Proc. of I.R.E.*, Vol. 28, No. 1, Jan. 1940; *B.S.T.J.*, Vol. XIX, No. 1, Jan. 1940.

channels and  $VI_2$  on emergency channel) and associated attenuators.

Aural monitoring equipment consists of the conventional monitor amplifiers and high-fidelity loudspeakers. It is located on racks 4 and 5 and is shown in the lower (but not lowest) portion of Fig. 1.

Each of the two aural monitoring channels contains an "a.f.-r.f." key which permits instantaneous comparison between the modulating audio frequencies and the demodulated radio-frequency output of the transmitter. This provides an aural check on the performance of the transmitters.

Approximate transmission levels at various parts of the circuit are indicated in terms of  $vu^1$  by the figures shown just above the lines connecting the various blocks in Fig. 1, while the transmission gain in decibels for the various circuit elements are shown just under the element involved. In addition, the circuit im-

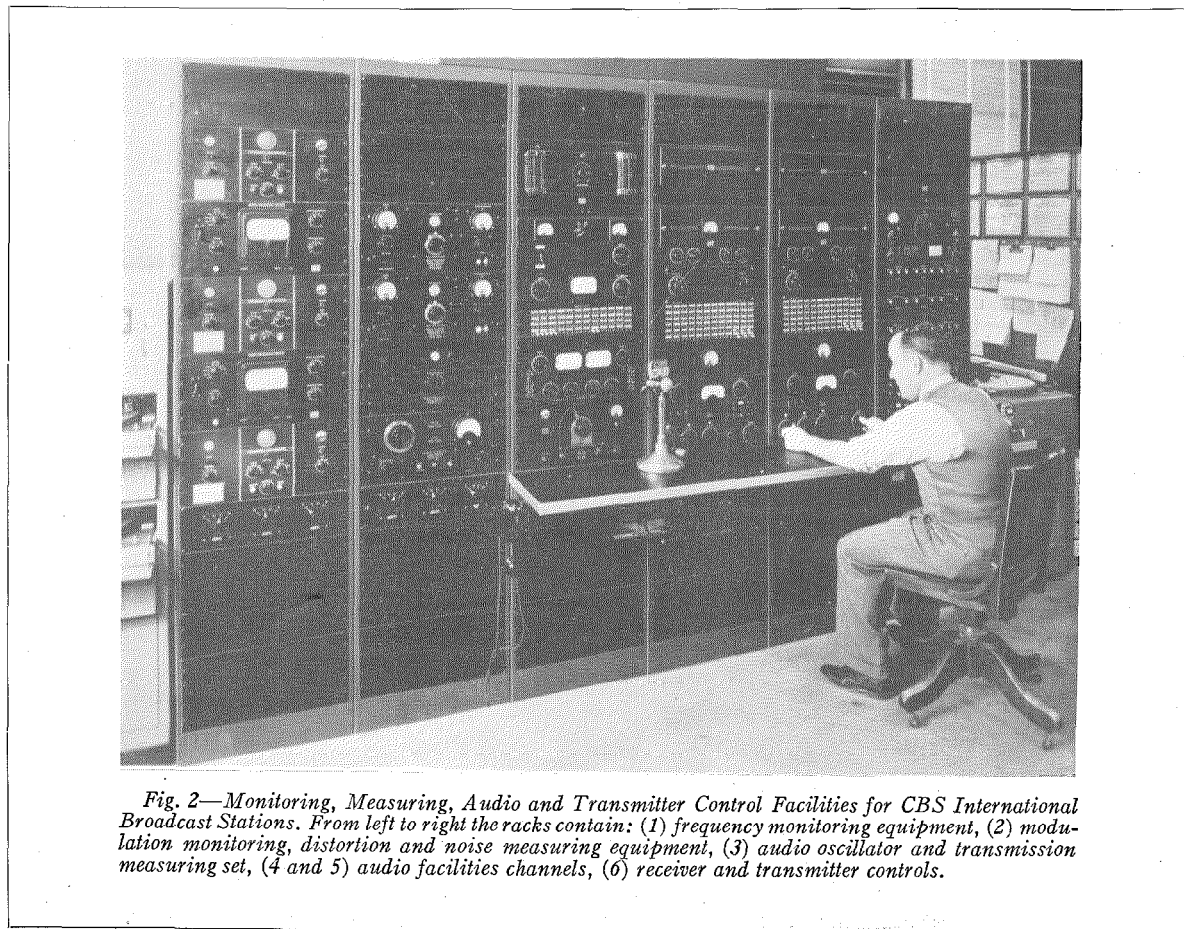

Fig. 2—Monitoring, Measuring, Audio and Transmitter Control Facilities for CBS International Broadcast Stations. From left to right the racks contain: (1) frequency monitoring equipment, (2) modulation monitoring, distortion and noise measuring equipment, (3) audio oscillator and transmission measuring set, (4 and 5) audio facilities channels, (6) receiver and transmitter controls.

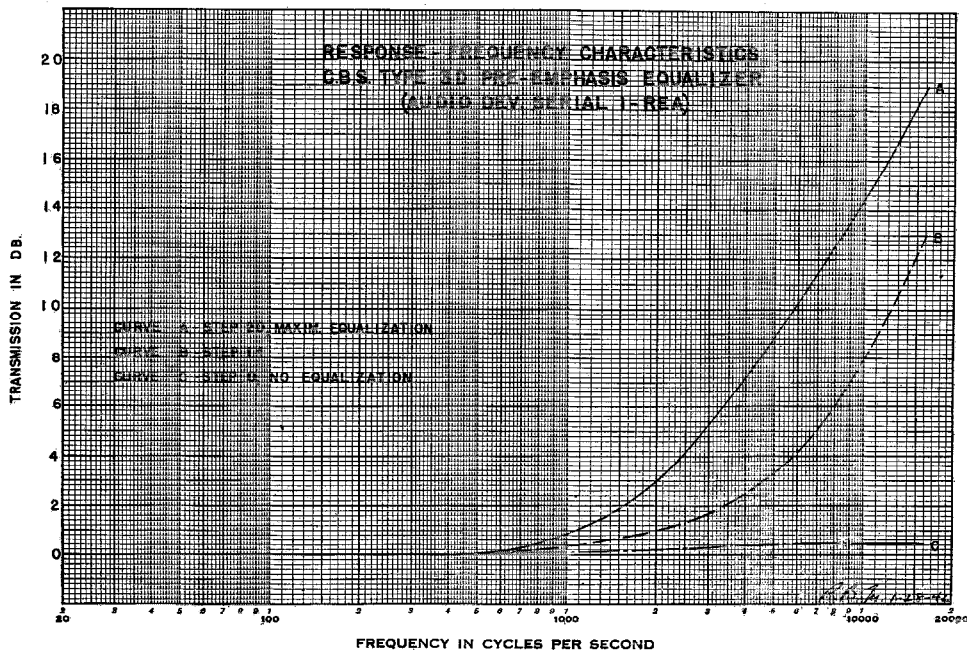

Fig. 3—Frequency Response Characteristics of the Pre-Emphasis Equalizer at CBS International Broadcast Transmitters.

pedances are shown at various points throughout the figure. It is believed that the addition of these data on a block schematic diagram of this kind adds immeasurably to its usefulness and greatly simplifies the design procedure.<sup>2</sup>

### Utility Facilities

As shown in the lower part of Fig. 1, a number of utility audio facilities are provided for convenience in operating, testing, and coping with possible emergencies. These miscellaneous items include private line (PL) telephone connections to the ultra-high-frequency receiver site ("Farmhouse") and to the studio building ("WABC MC") in New York City.

The output of the studio-transmitter-link receiver is available on jacks and may be patched to any audio channel in place of a regular incoming program line, if required. The receiver itself is actually about one mile away from the main

shortwave transmitter building. The antennas for the u-h-f receiver are located 175 feet above the ground on a steel mast.

Although not a part of the plant being described, it should be noted, for completeness, that the u-h-f transmitter involved is located on the 62nd floor of a New York building. The transmitting antenna height is approximately 700 feet above the ground. As mentioned heretofore, the airline distance between the transmitter and receiver is about 37 miles.

Auxiliary equipment includes a commercial-type allwave receiver. This provides still another emergency program link between the studios and the transmitter since it could, in an extreme case of program-circuit failure, be tuned to the CBS key station, WABC, and thus provide program material for the modulation of the shortwave transmitters.

Sets of parallel-connected jacks and a double-pole, triple-throw key switch are also provided for general utility applications.

<sup>2</sup> "Broadcast Studio Audio-Frequency Systems Design," by H. A. Chinn, *Proc. I.R.E.*, Vol. 27, No. 2, Feb. 1939.

The liberal use of circuit-closing jacks throughout the assembly provides means for overcoming practically any kind of equipment failure since, by means of patch cords, the defective unit can be replaced immediately by a spare unit or removed from the circuit completely. This arrangement, coupled with the use of several regular and emergency program circuits, insures the minimum of program interruption because of circuit or equipment failure.

### **Recording Facilities**

In order to comply with the regulations of the Federal Communications Commission pertaining to International Broadcasting Stations, facilities are provided for the continuous recording of all outgoing program material. Since three transmitters are involved an equal number of complete recording sets are provided.

The audio inputs to these equipments are obtained from r-f monitors (demodulated r.f.) and *not* from the audio input channels. This arrangement insures an exact record of the program that has been broadcast and indicates the extent of any interruptions that may result from any equipment failure whatsoever.

The recording equipment employs plastic discs 16 inches in diameter and of sufficient thickness to permit the use of both sides for recording. The records are driven at a constant linear-groove-velocity, thus insuring a uniform quality of recording regardless of the recorded groove diameter. The pitch of the recording grooves and the linear-groove-speed is such that slightly more than a full hour can be accommodated by each record side.

Each recording set consists of two turntables together with the required audio amplifiers and control circuits. These control circuits are arranged so that a few minutes before the end of a record is reached on one machine the second unit is automatically placed into operation.

The first machine is automatically turned off at the end of the hour and a signal indicates that it is ready for reloading. Since the second machine will remain in operation for an hour, the first machine can be attended to at any convenient time during this hour. The process of removing the recorded record, turning it over,

or replacing it with a new one, involves only a matter of seconds.

The recorded groove is embossed, rather than engraved, thus dispensing with the need for accommodating a chip or thread of the record material. This is a very important consideration in connection with any recording equipment that is to run continuously, unattended.

It has been found that records of one-hour duration are preferable to a film recording that could provide an entire day's recording on a single reel of film. The records are more readily handled by inexperienced personnel and there is no danger of a length of film being seriously tangled as could be the case if reels were not properly managed. Of greater importance, however, is the ease with which a given program can be obtained from the file for reference purposes. Furthermore, when available in program units of one-hour duration, many programs of a given day's broadcasting can be simultaneously reviewed or transcribed to paper. Finally, any given one-hour recording can be made available for either these or other purposes immediately upon its completion.

### **Measuring Facilities**

Apparatus has been provided for the measurement of all operating characteristics that are of interest in both the radio and the audio sections of the transmitters. For the most part this equipment has been concentrated in the three right-hand equipment cabinets shown in Fig. 2.

The audio-frequency equipment consists of a variable-frequency audio oscillator covering the range from 20 to 17,000 cycles per second. The output level of the oscillator is constant over this range within 0.5 db. The harmonic distortion at the normal operating level of zero vu (1 milliwatt) is less than 0.3% rms for frequencies below 100 cycles per second, and less than 0.2% rms for frequencies above this point. The instrument is located at desk level in rack 3 (Fig. 2).

A transmission measuring set located just above the audio oscillator provides for measuring the output of the oscillator (with a standard volume indicator), and for attenuating this output by any desired amount over a range of 100 db in 1 db steps. It also provides means for

obtaining any one of seven source impedances ranging from 30 to 600 ohms, as desired.

Another section of the transmission set contains a resistive load for terminating audio equipment that is under test. A choice of nine load impedances ranging from 8 to 600 ohms is available. A second standard volume indicator provides means for measuring the level in the load resistance.

An instrument capable of measuring noise and the amount of harmonic distortion is also incorporated in the equipment assembly. This apparatus, which is located at desk level in rack 2 (Fig. 2), is capable of measuring noise levels as low as  $-70$  vu and can accommodate either a-f or modulated r-f input voltages. Harmonic distortion (rms) can be measured by this instrument over a range from 0.1 to 30% for fundamental frequencies of 50, 100, 1000, 5000 and 7500 cps.

Two modulation monitors are located near the top of rack 2 (Fig. 2). These provide visual monitoring, continuously, of the percentage modulation of any two of the transmitters, as desired.

Three frequency monitors, together with two audio-frequency deviation meters are located in rack 1. The monitors contain a total of 12 crystals covering all the frequencies assigned to WCBX, WCRC and WCDA. In some instances

there is more than one crystal for a given frequency in order to insure means for monitoring any two frequencies that are likely to be used simultaneously.

Suitable transmission line switches facilitate the connection of any frequency monitor, modulation monitor or distortion meter to any of the transmitter r-f units. For the three complete transmitters, four r-f units have been provided to permit pre-schedule frequency adjustment and tuning of the unit about to go on the air.

#### *Addendum*

The design details and procurement of these audio and measuring facilities were undertaken by R. B. Monroe of the CBS General Engineering Department, while the assembly and wiring was under the direct supervision of J. H. Swensen of the WABC Technical Operations Group. The equipment was placed in service during the summer of 1941 and has satisfactorily met the various requirements for which it was designed. While originally planned only for use with two transmitters, WCBX and WCRC, it was found possible to readily adopt the installation to accommodate a third channel, WCDA. This interim, but quite satisfactory, procedure was followed in order to avoid the need for diverting critical materials.



# The Polymerization of Styrene and Some Concepts of the Electrical Properties of Plastics \*

By A. J. WARNER, B.Sc. (Lond.)

*Director of Research and Development, Intelin Division, Federal Telephone and Radio Corporation, Newark, New Jersey*

WHILST polystyrene is probably the oldest known synthetic resin, having been discovered by E. Simon<sup>1</sup> as far back as 1839, its wide-spread use in industry is of relatively short duration. It was not until the middle 1930's that any considerable attention was given to this plastic, since it was only at this time that successful methods of synthesizing the hydrocarbon cheaply and in quantity were achieved.

The very serious situation arising from the cutting-off of sources of crude rubber, due to the Japanese conquest of Malaya, etc., has necessitated the development of synthetic rubber-like materials. The most favored material is Buna S, known in this country as GR-S, a copolymer of styrene and butadiene. The rubber programme calls for a large amount of this copolymer, and it is estimated that before long styrene will be one of the largest manufactures of any synthetic organic chemical in the world.

The extremely rapid expansion in the manufacture and utilization of styrene will shortly make available large amounts of the material for use in a diverse number of applications, and as more and more knowledge is gained in controlling the polymerization and a better understanding of the desirable properties of this plastic is achieved, further extensions of its applicability to industrial use will be made. This expansion, moreover, has necessitated and will continue to demand, a large amount of investigation into the methods of preparation and polymerization of the monomer with a consequent rapid increase in our theoretical understanding of the processes involved.

When the literature is studied, it is found that a considerable volume of data has been published on this hydrocarbon, especially on those aspects dealing with its conversion from a low-boiling,

highly refractive, limpid liquid monomer to a hard, glassy plastic polymer, but much of this data is invalidated by the impurity of the material employed, or a failure to observe the necessary scrupulous attention to detail required for accurate results. As a consequence, much confusion exists in the literature, and it will be necessary to amass carefully prepared data, thoroughly cross-checked, to enable us to obtain the necessary insight into the polymerization process necessary for a complete control of the reaction.

Much of the work discussed, and some of which has been published,<sup>2</sup> in particular that dealing with inhibitors, retarders and accelerators, is the result of research carried out in the laboratories of the Standard Telephones and Cables, Ltd., London, England, a manufacturing associate of the International Telephone and Telegraph Corporation.

In this paper, it is proposed to deal very briefly with the polymerization processes, paying particular attention to the effect of added substances, and, since one of the important properties of polystyrene is its outstanding electrical characteristics, to give a short summary of the dielectric properties of materials, particularly in the radio frequency range.

## ***Polymerization of Pure Styrene by Heat***

Before proceeding with a discussion of the polymerization processes, let us look at a typical example of the results obtained by polymerizing pure styrene at an elevated temperature.

Fig. 1 gives the percentage polymerization against time of a carefully purified sample of monomeric styrene polymerized at 61° Centigrade. It will be seen that the curve falls very broadly into three distinct portions: (1) an initial period during which the polymerization starts slowly and then increases in velocity, (2) a period in which the velocity reaches a maximum and

\* Paper presented at the Midland Section of the American Chemical Society, Dow Chemical Company Auditorium, Midland, Michigan, March, 1943.

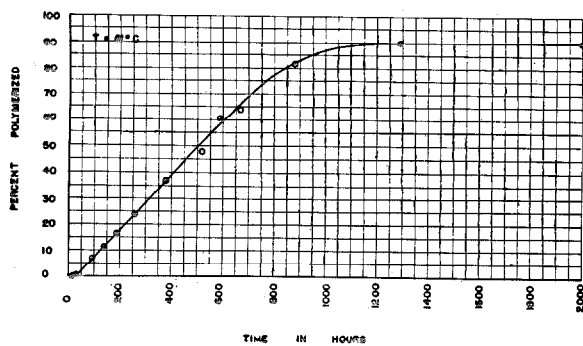

Fig. 1—Polymerization of Pure Styrene at 61° C.

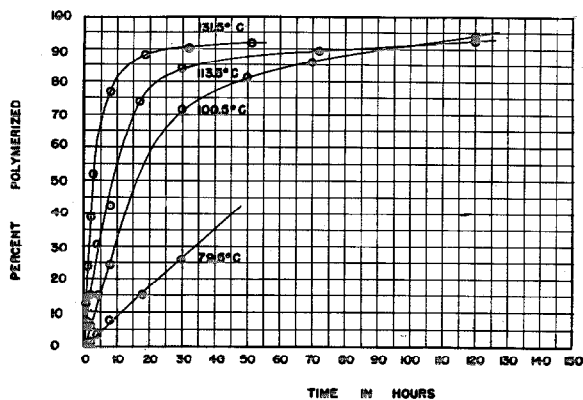

Fig. 2 Effect of Temperature on Polymerization Rate of Styrene.

remains constant, (3) a period in which the rate falls off and approaches asymptotically a final polymerization degree of somewhere near 100%.

The circles on the curve are the actual experimental figures obtained, and are the result of several individual determinations. It will be seen that a smooth curve can be drawn through the experimental data obtained.

Fig. 2 gives similar curves obtained by Schulz and Husemann<sup>3</sup> for different temperatures, showing the increase in reaction rate with increasing temperature of polymerization.

### Molecular Weight Dependence on Temperature of Polymerization

Fig. 3 shows the effect on the average molecular weight of the temperature at which the polymerization takes place. The higher the temperature, the lower the molecular weight. It must be remembered, however, that the molecular weights used in this graph were determined

viscosimetrically, and we have strong reason to believe that the values obtained in this way are not accurate.

It is now generally conceded that the polymerization of styrene is a chain process, and that three main stages are involved:

- 1—chain initiation
- 2—chain propagation
- 3—chain termination

### Chain Initiation

Stobbe and Posnjak,<sup>4</sup> in 1909, were probably the first to recognize the chain nature of the reaction. They came to the conclusion, after very careful investigation, that "nuclei of polymerization are formed in styrene, and that these accelerate the polymerization in a remarkable way."

It is probable that chain initiation consists of an activation of the ethylenic double bond in the styrene molecule, giving rise to an energy-rich, "hot" or excited molecule:

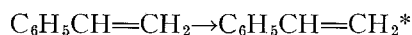

Either the double bond is made especially ca-

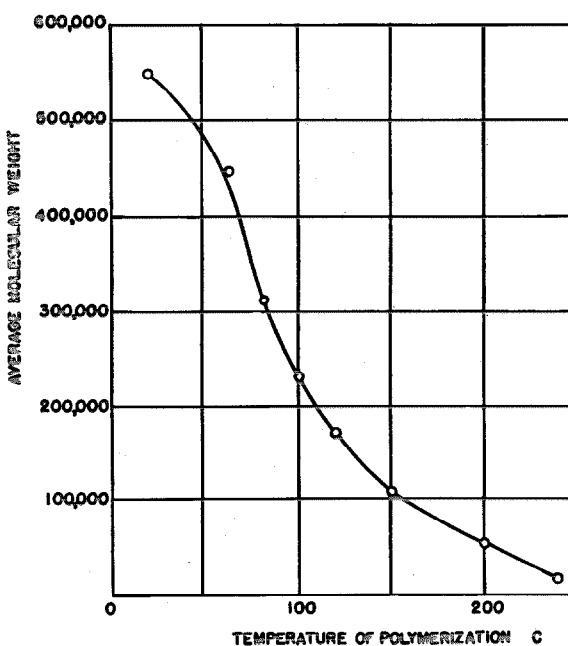
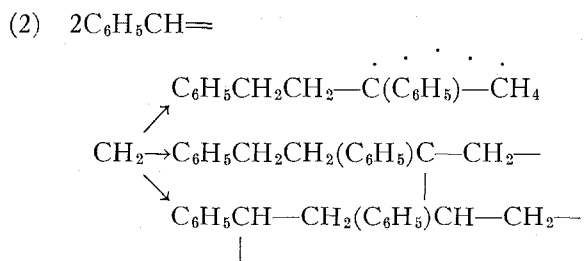
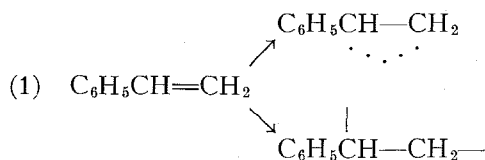

Fig. 3—Molecular Weight Dependence on Temperature for the Polymerization of Styrene.

pable of addition by this activated state, or one of the bonds is completely broken, rendering both carbon atoms capable of undergoing further reaction. The latter type of postulate, the so-called free-radical mechanism, is the more commonly accepted of the two activation processes.

Both types of activation could be brought about either by the vibrational energy in a single molecule, in which case we would have a monomolecular reaction, or by reaction between two molecules giving a bimolecular reaction. We can express these as follows:



It is evident that the second step of the growth from monomolecular nuclei is identical with the first step from the bimolecular ones.

The energy necessary for activation, some 26,000 calories, can be acquired in a variety of ways. It has been known for a long time that light was a source of energy for this process, and Lemoine made many experiments utilizing different portions of the spectrum to determine which part was most effective. He found the blue and ultraviolet rays most effective for polymerization.

It was Taylor and Vernon <sup>5</sup> in 1931, however, who got the first value for a quantum yield in the activation process. Using ultraviolet light, they found that the quantum yield was nine moles per quantum at 90° Centigrade in pure styrene, and also that hydroquinone inhibited the reaction. These results led Taylor and Vernon to assume the chain reaction mechanism for the polymerization of styrene.

Excitation of the double bonds can also be achieved by heat and catalysts. A certain amount of disagreement exists as to whether or not there

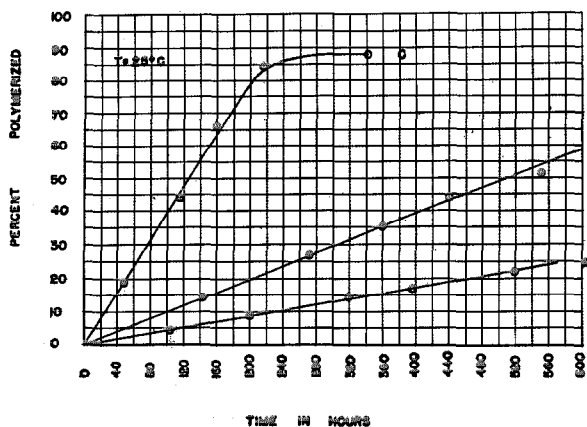

Fig. 4—Polymerization of Styrene with Accelerators at 25° C.

is such a thing as a true thermo-polymerization of styrene, since many authorities maintain that the polymerization occurring under the influence of heat is initiated only by impurities in the starting material. One of the tasks before polymerization chemists will be to determine this point exactly.

In the presence of certain materials, notably peroxides, persalts, ozonides, etc., the polymerization rate is markedly affected. It has been known for a number of years that oxygen was a catalyst for the polymerization of styrene and that, in the absence of oxygen, styrene polymerized much more slowly than in its presence.

Substances like benzoyl peroxide have been known and used industrially for a number of years to speed up the polymerization process. It is generally believed that a catalyst acts by forming a free-radical and thus initiating chains. It is well known that free radicals can catalyse the reaction, as has been shown by Schulz <sup>6</sup> using tetra phenyl succinonitrile.

Since the materials affecting the polymerization are destroyed during the process, it is perhaps not correct to use the term "catalyst" for such materials; but since the literature abounds with experimental results obtained with such so-called "catalysts," we will continue to employ the term.

Staudinger and Lautenschlager, <sup>7</sup> in 1931, assumed that these so-called "catalysts" generated oxygen, forming a peroxide of the unsaturated material which was then capable of undergoing a polymerization and, furthermore, stated that

oxygen was a more active catalyst for the polymerization of styrene at 80° Centigrade than, say, benzoyl peroxide.

Houtz and Adkins<sup>8</sup> in this country, however, working with ozonides and in particular with diisobutylene ozonide, disputed these interpretations and showed that at 25° Centigrade diisobutylene ozonide was a much more potent accelerator of the polymerization than was benzoyl peroxide, and that the decomposition of the ozonide gave rise to no oxygen. They concluded "presumably the catalysts form a molecular complex with the styrene, which is more labile toward polymerization than is styrene alone."

Since there are several points of interest in this controversy, we have investigated these particular reactions a little more fully. Fig. 4 shows polymerization curves obtained at 25° Centigrade for benzoyl peroxide and diisobutylene ozonide.

Curve "A" is that for approximately .54% benzoyl peroxide, whilst Curve "B" is that for .65% diisobutylene ozonide. It will be seen, therefore, that Houtz and Adkins assertion that diisobutylene ozonide is a better catalyst for the polymerization at 25° Centigrade, than benzoyl peroxide, is justified. Curve "C" is obtained with 4.98% of diisobutylene ozonide and it will be seen that the material is substantially polymerized at 25° Centigrade in 230 hours.

A curve for the polymerization of pure styrene at this temperature would not be capable of plotting on this particular graph owing to the slowness of the reaction. Another interesting point to note is that the curves start directly

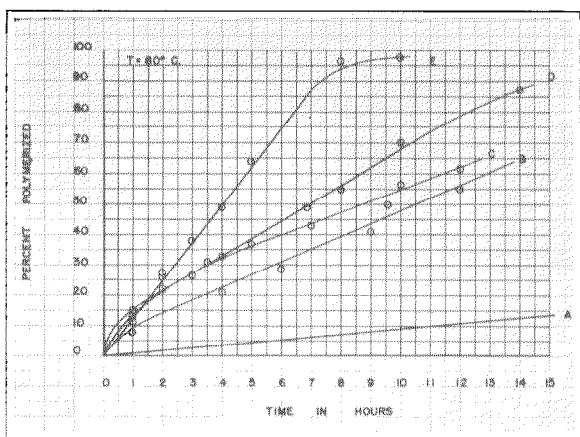

Fig. 5—Polymerization of Styrene with Accelerators at 80° C.

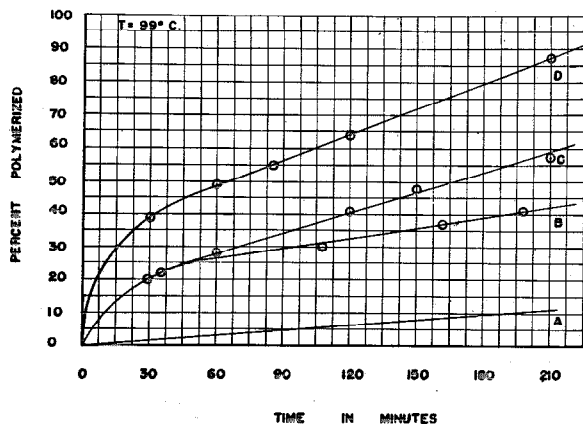

Fig. 6—Polymerization of Styrene with Accelerators at 99° C.

from the point of origin and show no trace of an induction period.

Fig. 5 gives the rate of polymerization of styrene with various accelerators at 80° Centigrade. In this case, two new ozonides have been included, namely, amylene ozonide and diamylene ozonide.

Curve "A" represents the polymerization of pure styrene at this temperature. Curve "B" represents that obtained using .5% amylene ozonide; curve "C," .65% diisobutylene ozonide; curve "D," .46% diamylene ozonide; and curve "E," .54% benzoyl peroxide.

There are several very interesting features to be observed in these curves. The curves for pure styrene and for benzoyl peroxide show a straight-line nature passing through the origin, whilst the curves for the ozonides show a very sharp rise in the polymerization rate at the commencement, followed by a dropping-off to a constant lower rate of polymerization. As the molecular weight of the hydrocarbon portion of the ozonide increases, the effect on the polymerization rate becomes greater.

Fig. 6 gives the curves obtained with various accelerators at 99° Centigrade. Curve "A" is that obtained for pure styrene; curve "B," for .45% diamylene ozonide; curve "C," for .65% diisobutylene ozonide; and curve "D," for .55% benzoyl peroxide.

It should be noticed that all the curves for accelerated samples show an initial rapid increase in the rate of polymerization followed by a falling-off to a steady lower rate.

From the three sets of curves shown in Figs. 4, 5, and 6, it will be seen that the relative effi-

ciency of an accelerator can only be judged when the temperature conditions are stated. Thus, diisobutylene ozonide is a better accelerator than benzoyl peroxide at 25° Centigrade, whilst at temperatures above 80° Centigrade benzoyl peroxide is the better catalyst.

In this case, therefore, both pairs of contributors, Houtz and Adkins, and Staudinger and Lautenschlager, were right and both were wrong, depending solely on the point of the temperature scale considered. The change in slope of the curve at higher temperatures is probably due to the thermal destruction of the accelerator, the decomposition giving rise to substances that act as chain breakers.

This thermo destruction has been noted in particular (McClure, Robertson, and Cuthbertson)<sup>9</sup> with benzoyl peroxide in benzene solution, and it has been shown that decomposition is particularly rapid at temperatures above 80° Centigrade. At low temperatures there is a slow decomposition to benzoyl radicals, and it is probably these benzoyl radicals that initiate the chain.

As of interest, Fig. 7 shows the effect of storing diisobutylene ozonide at 0° Centigrade.

It is well known that the ozonides of the lower alkenes are unstable at elevated temperatures, and it was, therefore, desired to know how feasible it was to store such a material before it would lose its value as a catalyst. The black solid circles show the results obtained on polymerizing styrene with catalyst at 80° Centigrade after keeping the diisobutylene ozonide for 19 days at 0° Centigrade, whilst the white circles

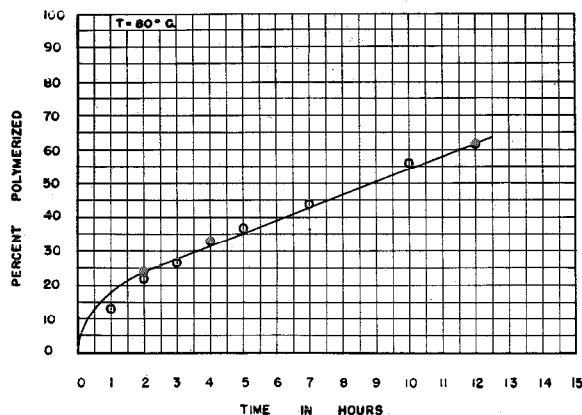

Fig. 7—Effect of Storing Di-isobutylene Ozonide on the Subsequent Polymerization Rate of Styrene.

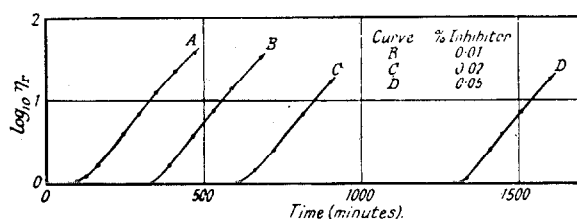

Fig. 8—Polymerization of Styrene in the Presence of Benzoquinone at 90° C.

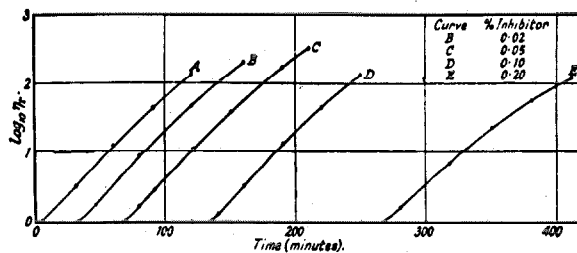

Fig. 9—Polymerization of Styrene in the Presence of Benzoquinone at 120° C.

were obtained with the same concentration of catalyst freshly prepared for the experiment. It will thus be seen that it is possible to prepare ozonides and store them for quite long periods under suitable conditions without decomposition.

Thus far only materials affecting the polymerization rate in a positive direction have been considered. It is now interesting to consider the so-called inhibitors and retarders.

It is a well-known experimental fact that the addition of hydroquinone or other phenolic bodies to monomeric styrene enables this material to be kept much longer without polymerization than in their absence. We shall consider at this stage as inhibitors only those substances which affect the initiation of chains, leaving to a little later the discussion of retarders, whose effect we believe to be the breaking of the chains once they have started.

A considerable amount of work on retarders was carried out by S. G. Foord of S. T. & C. Labs., who was able as a result of his investigations to calculate the actual amount of stabilization that could be achieved at any particular temperature with the quantity of added material.

He was furthermore able to get a qualitative idea of the effectiveness of various groupings on the stabilization. Quinoid compounds in general are very strong inhibitors without any material retarding action in small concentrations. Exceptions to this rule are anthraquinone, which

has been found to be ineffective, and acenaphthene quinone which has only a weak inhibiting action. Phenolic hydroxy groups are comparatively weak stabilizers, phenol itself being ineffective and cresol only a feeble stabilizer; the effectiveness increases with the number of hydroxy groups, but depends on their position in the molecule. It is probable that a substance like hydroquinone acts by reacting with oxygen present to give quinone, which then acts as the inhibitor.

Amino groups are inhibitors and are most effective when attached to a benzene nucleus, particularly in the presence of another active group.

Beta naphthylamine is a more effective inhibitor than alpha naphthylamine. Those nitroso compounds examined, for example  $\alpha$ -nitroso-dimethyl aniline and  $\alpha$ -nitroso- $\beta$ -naphthol, show a very strong inhibiting action. The case of benzoquinone has received the most attention.

Fig. 8 shows the effect of different concentrations of benzoquinone on the polymerization of styrene at 90° Centigrade. It will be seen that the slope of the curves, once polymerization has started, is the same in the presence of benzoquinone as in its absence, but that the time for the commencement of the polymerization depends on the concentration of the inhibitor.

Fig. 9 shows similar curves at 120° Centigrade. In this case, it will be seen that large quantities of benzoquinone show a slight retarding effect on the subsequent polymerization rate.

Fig. 10 gives the results for phenanthraquinone at 120° and here again a slight retarding action is observed with increasing concentration of the phenanthraquinone.

As a result of this work, the curves shown in Fig. 11 were obtained for the length of the induction period at 120° Centigrade against the

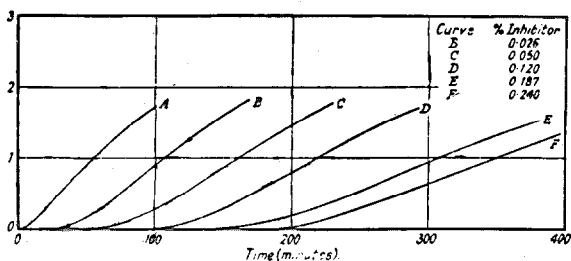

Fig. 10—Polymerization of Styrene in the Presence of Phenanthraquinone at 120° C.

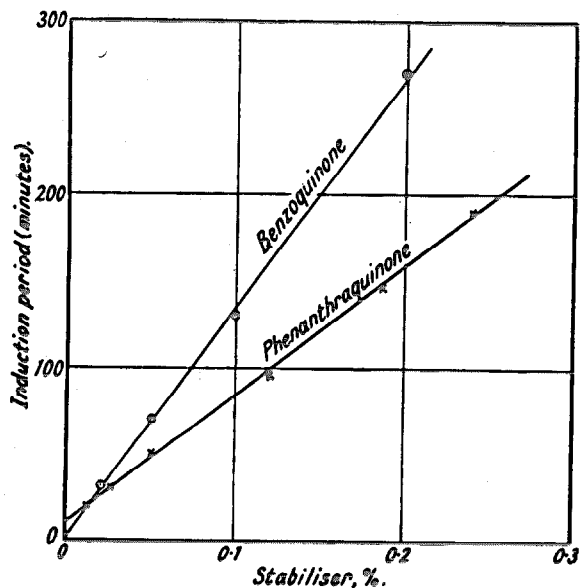

Fig. 11—Effect of Concentration of Stabilizer on the Induction Period for the Polymerization of Styrene.

concentration of the stabilizer for cases of benzoquinone and phenanthraquinone.

From these curves, calculations can be made for the length of time at 120° Centigrade it will be necessary to heat the styrene containing a known amount of stabilizer before polymerization starts. Thus, if the monomer contains 0.1% of benzoquinone, it will have to be heated for 2 hours and 10 minutes before polymerization starts.

It will be seen that benzoquinone is a more effective inhibitor than is phenanthraquinone. An interesting experimentally observed point is that the yellow color of the solution of quinone in styrene gradually lessens as the heating is continued, and the commencement of the polymerization occurs almost at the disappearance of the yellow color.

### Chain Propagation

Chain propagation consists of a great many reactions occurring in rapid succession. An activated molecule can collide with an unactivated molecule, giving rise to an addition product still possessing the same form as existed in the primary step.

The heat of activation of chain propagation is relatively small, and is estimated at about 8,000 calories per mole. This energy is provided by the

reaction between the activated molecules and the inactive molecules.

### Chain Termination

The chain grows until stopped either by chain termination or chain transfer. In the case of chain transfer an actively growing unit may collide with an unactivated monomer molecule, a transfer of energy taking place to give rise to a fresh activated monomer, which can continue to grow in the normal manner, and an unactivated polymer residue.

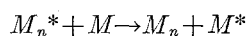

A further method of chain breaking can occur by the collision of two activated polymer units. In this case, we get no formation of activated material and, therefore, the chain process is effectively stopped.

It has been suggested that by the reaction of a growing polymer chain with a normal or activated mono- or polystyrene molecule, a cyclobutane ring might be formed, or we might get intramolecular saturation of the double bond. In the first case we have:

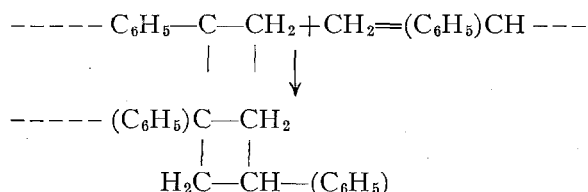

whereby addition can be either *cis* or *trans*. In the second case we might get a hydrindene ring formation. However, the reaction

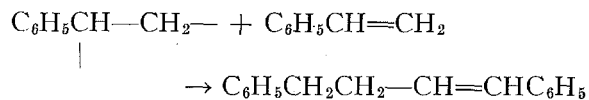

might block the double bond and make further growth impossible. Owing to the experimental difficulties in the way of determining double bonds in a long chain polymer of this type, it is not possible yet to decide which reaction is correct. It might be mentioned, however, that the Raman Spectra show no frequencies corresponding to a double bond. Gallay,<sup>10</sup> however, on the basis of dielectric constant measurements, came to the conclusion that a double bond exists at the end of the molecule, since he found that the dielectric constant increased with frequency.

The breaking of chains by the introduction of foreign materials has been known for a considerable time. We have chosen to call such substances retarders to distinguish them from substances like benzoquinone whose action depends on the deactivating of the initially activated monomer unit. Retarders, therefore, slow down the reaction and give rise to products having a lower molecular weight than would be obtained under the same conditions in their absence. Among such substances must be noted certain phenolic hydroxy compounds such as pyrogallol and *para*-tertiarybutyl catechol. Particularly effective are the nitro groups on aromatic compounds, their effect increasing with the number of nitro groups present.

Thus, picric acid is particularly effective as a breaker of polymerization chains. The whole subject is complicated, however, by the fact that some substances can act both as inhibitors and retarders, and, in this case, it is possible that the reaction products of the inhibitor with the activated monomer unit subsequently act as breakers of the polymerization chain.

A further interesting postulate of great importance is the question of possible branching of the reaction chains. It has been known for a considerable time that the Staudinger viscosity relation, worked out as a means of investigating high polymers, did not give values for the molecular weight of polystyrene comparable with those obtained by either the osmotic or ultra centrifuge methods. Schulz, in particular, has postulated that this may be due to the fact that the chains, instead of being straight as assumed by Staudinger, were in reality branched. Staudinger has accepted the idea of branching rather than abandoning his own concepts of the viscosity molecular weight relationship. One of the assumptions for the method of branching is:

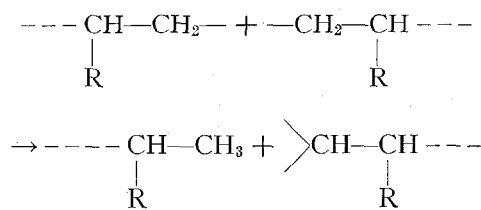

The chain may then continue on either limb of the branch.

Schulz<sup>11</sup> has assumed a quinoid structure for the activated monomer, or growing chain,

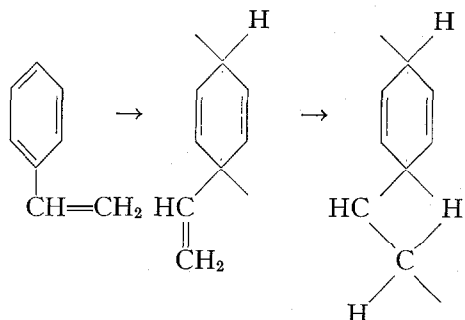

which, however, has not found much favor principally because of the absence of any color formed during the reaction that might be expected with such a structure.

Flory<sup>12</sup> has yet another mechanism, which involves the wandering of a hydrogen atom from one growing chain to another growing chain.

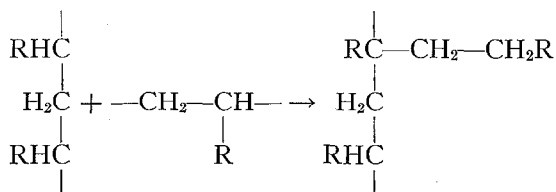

So far, only polymerization in the monomer has been considered. In the presence of diluents, the results are rather complicated, depending on the nature of the diluent used. Thus, the presence of ethyl benzene serves to slow down the polymerization and to give polymers of lower molecular weight. In carbon tetrachloride, or chloroform, however, the subsequent polymer is found to contain chlorine, indicating that the chlorinated material enters into the growing chain.

Apart from the chain mechanism, leading to high molecular weight materials, it is also possible to get a step-by-step addition reaction giving rise to dimers, trimers, and other lower polymers. Examples of materials causing this reaction are sulphuric acid, acetic acid and activated earths such as flordin.

A great deal more work is necessary in the whole field of polymerization to get a clearer insight into the probable processes. The foregoing account of the polymerization process can only be considered a very rough and by no means exhaustive treatment of the subject matter.

Summarizing very briefly, however, we can

say that the polymerization of styrene is a chain mechanism involving the activation of the double bond by some means or other, followed by a growing of these activated units into the polymer chains by collision with unactivated monomer units. A final chain breaking reaction stops the chains and yields polymer.

It has been seen that various substances affect these processes by stepping up the formation of active centers, breaking the activated centers when formed or by breaking the polymerization chains, once started.

We have not considered the effect of other influences, principally because they have not been studied too comprehensively at the present time. These include pressure, high frequency, radioactive substances, etc.

### Experimental Technique

A study of polymerization calls for the development of a special technique if reproducible results are to be obtained. In our experiments we have used styrene prepared by either of two methods, namely, the commercially prepared material from ethyl benzene, and that prepared by the dehydration of  $\beta$ -phenylethyl alcohol,  $\text{C}_6\text{H}_5\text{CH}_2\text{CH}_2\text{OH}$ . The last method of preparation is very convenient as a laboratory method since the alcohol can be purified to a high degree before dehydration, whilst in the dehydration process only water and styrene, together with some unchanged alcohol, are obtained, making final purification of the monomer relatively easy. The purity of the styrene, unfortunately, cannot be very easily determined by the usual methods such as analysis, refractive index, density or electrical properties, since quantities of impurity in the order of 0.001% may markedly affect the polymerization without affecting the physical properties enumerated above. Vacuum fractionation of a purified material, however, when carried out with extreme care, yields reproducible results.

The polymerization is carried out in very thin-walled glass tubes of approximately  $\frac{1}{4}$ " diameter. The tubes are cleaned by the use of hot chromic-nitric acid mixture, followed by thorough washing with distilled water. To remove any traces of adsorbed acid, the tubes are left in an aqueous solution of sulphur dioxide for



several days after which they are again rinsed in distilled water and allowed to stand until required for use. For use, the tubes are dried by washing with redistilled acetone followed by vacuum drying. The tubes hold approximately one to two milli-litres of liquid and, under these conditions, isothermal conditions during the polymerization can be maintained.

The heating is done in the polymerization vessel shown in Fig. 12. Constant temperature is

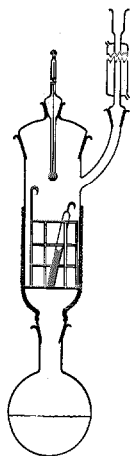

Fig. 12—Apparatus for Polymerization Studies.

attained by boiling a liquid in the flask, the tubes containing the polymerizing material always being in the vapour of the liquid at its boiling point. The liquids used are, chloroform (61° C.), benzene (80° C.), and sec. butyl alcohol (99.5° C.). For 25° Centigrade, a constant temperature water bath is employed.

After the requisite time of polymerization, the tubes are removed from the thermostat and rapidly cooled by plunging into ice water. The percentage of polymer present is determined by dissolving a known weight of the sample in propylene oxide, precipitating the polystyrene by the addition of pure methyl alcohol, filtering through a sintered glass crucible and drying to constant weight in a vacuum oven at 60° Centigrade. This method of precipitation has been found much superior to the conventional toluene-methyl alcohol precipitation.

### ***Some Observations on the Dielectric Properties of Dielectrics***

Owing to the remarkable increase in the study of dielectric phenomena necessitated by the re-

cent advances in the applications of electronics to industrial operations, and consequent increase in the development of dielectric theory, it is only possible here to touch briefly on some of the more important phases of the development and to discuss them with particular reference to the dielectric constant and the loss factor, two of the most important electrical properties of plastics.

We should first of all ask ourselves, "What is a dielectric?" and "How does it differ from a non-dielectric, or conductor?" It is obvious that some fundamental difference exists between materials like copper and polystyrene; for, apart from their obvious physical difference, their behavior in an electric field is completely different, one being a conductor of electricity whilst the other is not.

A dielectric from a wave-mechanical standpoint may be considered as a material which is so constructed that, at the absolute zero of temperature, the lower bands of allowed energy level are completely full, whilst the higher unoccupied bands are separated from them by a large zone of forbidden energy levels. Conduction in the lower, fully occupied bands is thus impossible because there are no unoccupied energy levels to take care of the energy from the electrons of the applied field, whilst the zone of forbidden energy levels is so wide that it is improbable that an electron from a lower level can acquire enough energy to make the transition to the unoccupied upper band where it could take part in conduction.

More simply, the electrons and other charged particles of a dielectric are only free to be displaced when put in an electric field, but return to their original equilibrium positions when the field is removed.

The dielectric constant, usually symbolized by  $\epsilon'$ , is defined as the ratio of the capacity of a condenser with the dielectric material placed between two plates to the capacity of the same arrangement of plates in a vacuum.

The loss factor, symbolized by  $\epsilon''$ , is equal to the product of the dielectric constant times the cosine of the phase angle between voltage impressed upon, and the alternating current flowing in, the insulation placed between suitable metallic electrodes.

The ratio of  $\epsilon''$  to  $\epsilon'$  is frequently called the dissipation factor, whilst the angle  $\delta$  is defined

by  $\tan \delta = \epsilon''/\epsilon'$  and is called the loss angle. The quantity  $\sin \delta = \cos \theta$  is the power factor, but for small values of  $\epsilon''/\epsilon'$  the power factor, loss angle and dissipation value are for all practical purposes equal.

It will be recalled that Maxwell postulated that the square of the refractive index of a substance measured by visible light was equal to the dielectric constant, but Debye was the first to give some explanation of the fact that the dielectric constants of some substances were higher than those calculated from Maxwell's rule.

We shall use the term "dielectric polarization" to refer to the polarized condition created either by a constant or an alternating current on a dielectric, reserving the term "polarizability" as its quantitative measure.

Polarizability is defined as the electric moment per unit volume induced by an applied field of unit effective intensity. The total polarizability of a material is the sum of the electronic, atomic, dipole, and interfacial polarizabilities, each of which plays an important part in the dielectric properties of the materials and which still require a considerable amount of investigation to determine their exact foundations.

**Electronic Polarizations**

The electronic polarizations are due to the displacement of charges within atoms and can be

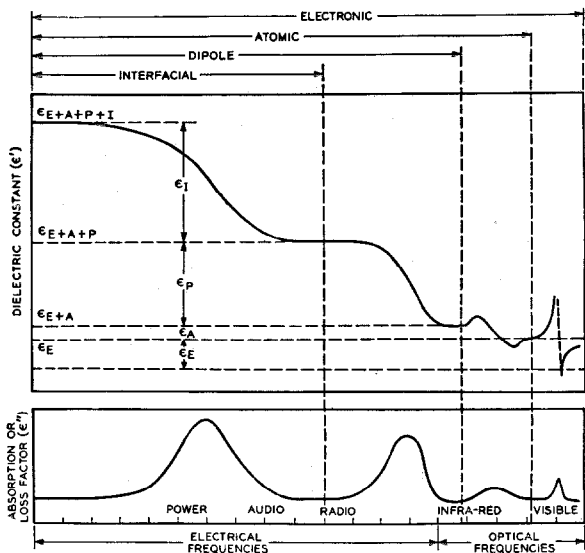

Fig. 13—Effect of Frequency on the Dielectric Constant, and the Loss Factor.

assumed to be proportional to the number of bound electrons in unit volume, and inversely proportional to the forces binding them to the nuclei of the atoms. They can form completely in times generally less than  $10^{-10}$  seconds, and therefore usually contribute a fixed amount to the dielectric constant in the electrical frequency band. But in the optical spectrum they sometimes change rapidly with frequency, giving rise to the well-known absorption bands.

In some materials, for example benzene, the only polarizable elements are electrons, the dielectric constant being the same for all frequencies.

The magnitude of this polarization can be determined very simply by a determination of the refractive index, and the use of two expressions:

$$\epsilon = n^2$$

and

$$\frac{\epsilon - 1}{\epsilon + 2} \cdot \frac{M}{d} = P,$$

where  $M$  is the molecular weight and  $d$  is the density.

**Atomic Polarizations**

Also to be considered as occurring instantaneously are the atomic polarizations, due to the displacement of ions in an ionic crystal lattice or of atoms in a molecular lattice or molecule. For dielectric materials, however, the atomic polarization is usually negligible.

**Dipole Polarization**

The most important type of polarization affecting the electrical properties of plastics and dielectrics in general is that due to the presence of dipoles. Debye has shown that the molecules of all substances, except those where the electric charges are symmetrically located, tend to align themselves in the direction of the applied field. This dipole polarization is superimposed on the electronic and atomic polarizations already discussed. The complete expression deduced by Debye to hold for such polar materials is

$$\frac{\epsilon - 1}{\epsilon + 2} \cdot \frac{M}{d} = \frac{4\pi N\alpha}{3} + \frac{4\pi N}{3} \cdot \frac{\mu^2}{3kT} \cdot \frac{1}{1 + i\omega\tau}$$

where  $\mu$  is the so-called permanent moment of the molecule,  $k$  is Boltzman's constant,  $\tau$  is the

relaxation time and  $\omega$  is  $2\pi$  times the frequency at which the dielectric constant is measured. Debye assumed  $\tau$  as proportional to the internal friction of the material giving the relationship

$$\tau = \frac{\xi}{2kT} = \frac{8\pi\eta\alpha^3}{2kT},$$

where  $\xi$  is the internal friction coefficient,  
 $\eta$  is the coefficient of viscosity,  
 $\alpha$  is the radius of the molecule,  
 and  $T$  is the absolute temperature.

This explanation is obviously only applicable to gases or very dilute solutions of spherical molecules.

### Interfacial Polarizations

So far we have discussed only those polarizations to be expected in a homogeneous material. In heterogeneous materials, however, where the components have different dielectric constants and conductivities, a fourth type of polarization may occur, namely, interfacial polarization.

Since a large number of commercial dielectrics are heterogeneous, it is well to consider the possibility of interfacial polarization. In the case of the dielectric constant of cellulose at low frequencies, for example, there is an interfacial polarization portion due to the presence of water and the dissolved salt. Interfacial polarization is most important at very low frequencies; it may, nevertheless, extend into the higher frequency bands in certain cases.

From the foregoing considerations, it will be obvious that the dielectric constant of a material is not a fixed value, but depends on the frequency and the temperature at which it is measured. With each change in the dielectric constant, we get a period of so-called "anomalous dispersion" where the loss factor becomes a maximum at the point where the rate of change of dielectric constant is greatest.

This will be seen clearly from a consideration of Fig. 13 which gives a diagrammatic representation of the change of dielectric constant and loss factor with frequency. The mid-point of the decreasing dielectric constant curve is often referred to as the relaxation frequency.

Fig. 14 contains some interesting curves for the variation of dielectric behaviour of a chlorinated diphenyl with temperature and frequency.

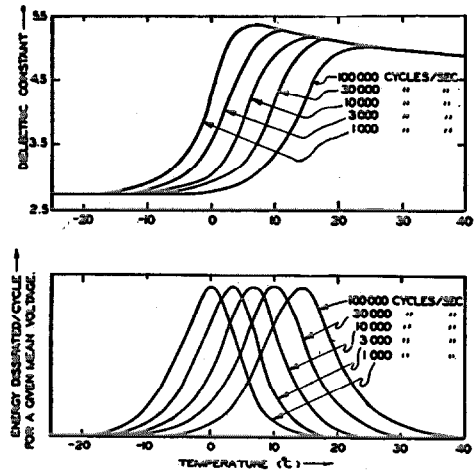

Fig. 14—Temperature Dependence of Dielectric Relaxation Rates for a Chlorinated Diphenyl. (From A. H. White and S. O. Morgan, *J. Frank. Inst.* 216, 635 (1933).)

It shows that the frequency above which the dipolar orientation contribution to the dielectric constant becomes negligible changes very rapidly with the temperature. It also illustrates that in the region of greatest irreversibility, the energy dissipation during each process of polarizing the dielectric is a maximum.

### Circular Arc Method of Expressing Dielectric Phenomena

A very interesting way of expressing dielectric phenomena is given in a recent paper by the Cole brothers,<sup>13</sup> who use the expression:

$$\epsilon^* - \epsilon_\infty = \frac{\epsilon_0 - \epsilon_\infty}{1 + (i\omega\tau_0)^{1-\alpha}}$$

where  $\epsilon^*$  is the complex dielectric constant (equal to  $\epsilon' - i\epsilon''$ ),  $\epsilon_0$  and  $\epsilon_\infty$  are the static and infinite frequency dielectric constants,  $\omega$  is  $2\pi$  times the frequency, and  $\tau_0$  is the generalized relaxation time.

The parameter  $\alpha$  can assume values between 0 and 1. This expression requires that the locus of the dielectric constant in the complex plane be a circular arc with end points on the axis of the real dielectric constant and the center below the axis.

Some typical results obtained by this method are given in Figs. 15 and 16.

It will be seen that in general the experimental points do lie on such a circular arc. In the case

of slate, however, it will be observed that there is an anomalous portion in the 500 kilocycle region, probably due to interfacial polarizations.

**Eyring Rate Theory and Dielectric Phenomena**

More recently, Kauzmann<sup>14</sup> has pointed out that the Coles' expression has no evident validity in theory, although giving reasonable agreement with experimentally observed results. Kauzmann tackles the problem from the Eyring rate theory, postulating that the dipoles jump from one position to another, and arrives at a possible explanation of the physical nature of the energy losses of dielectrics. He uses the following equations for the dielectric constant and loss factor in terms of the frequency:

$$\epsilon' = \frac{\epsilon_0 - \epsilon_\infty}{1 - x^2} + \epsilon_\infty \quad \text{and} \quad \epsilon'' = \frac{\epsilon_0 - \epsilon_\infty}{1 - x^2} x,$$

where 
$$x = \frac{2\pi\nu}{k_0 \left( \frac{\epsilon_\infty + 2}{\epsilon_0 + 2} \right)}$$

$k_0$  is the transition probability of the dipoles jumping from one position to another, or the relaxation rate.

For convenience we can write  $dP/dE = -k_0(P - N_0\alpha E)$ ; i.e., the rate of change of polarization in a field  $E$  is given by minus the relaxation rate times the polarization plus the product of the relaxation rate, the number of

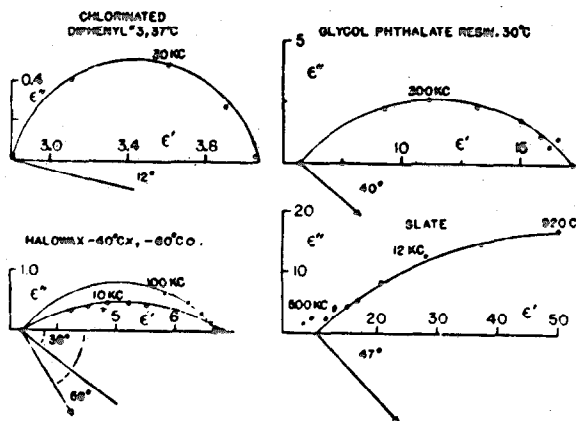

Fig. 16—Complex Dielectric Constants of Solids.

dipoles per unit of volume, the electronic polarization, and the field strength. Suppose  $E$  to be a high frequency field with  $\nu$  much greater than  $k_0$  so that polarization at no time has a chance to build up appreciably. Then  $P$  is approximately equal to 0 and  $dP/dE$  is  $\cong$  to  $k_0 N_0 \alpha E$  and the average power loss is

$$\frac{k_0 N_0 \alpha}{\nu} \langle E^2 \rangle_{av} \text{ per cycle.}$$

This case is similar to a conductor having a specific conductivity of  $k_0 N_0 \alpha$  reciprocal ohms. Physically it arises from the fact that if a dipole be regarded as a positive and a negative ion separated by a fixed distance, we can not detect the fact that the ions are bound to one another unless we use fields which oscillate so slowly that the ions can move a distance greater than that separating them during a single oscillation.

At low frequencies with  $\nu$  much less than  $k_0$ , the physical nature of the loss is less obvious. Here the polarization  $P$  lags slightly behind the field  $E$ . If  $P$  is broken up into two parts, one part in phase with the field, and the other out of phase by  $\pi/2$ , it is readily found that the in-phase part of  $P$  is given by

$$N_0 \alpha E \left( \frac{1 - 4\pi^2 \nu^2}{k_0^2} \right),$$

from which the energy lost as heat per cycle is

$$\frac{4\pi^2 N_0 \alpha \nu}{k_0} \langle E^2 \rangle_{av}.$$

Consequently, if we plot the energy loss per cycle against the frequency, there results a direct

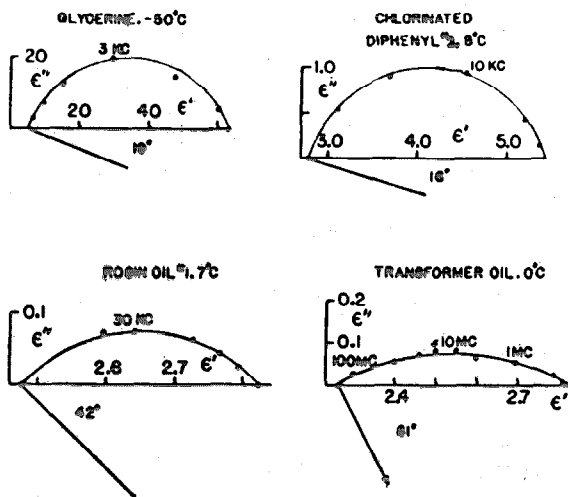

Fig. 15—Complex Dielectric Constants of Liquids.

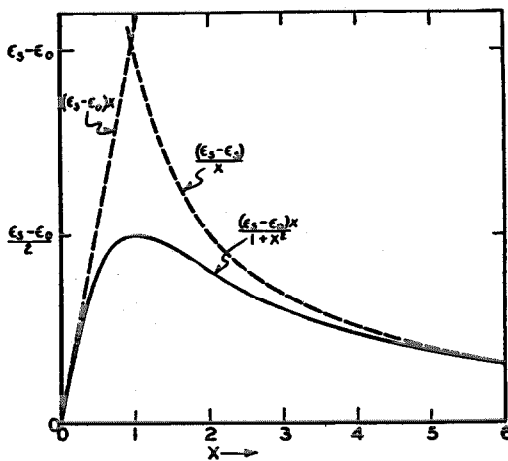

Fig. 17—Linear and Inverse Dependence of the Loss Factor on the Frequency.

proportionality at low frequencies and a hyperbolic relationship at high frequencies with an intermediate maximum. We thus get the curve shown in Fig. 17, and the physical reason for the familiar symmetrical  $\epsilon'$  versus  $\nu$  plot of Fig. 18.

The actual conversion of electrical energy into heat in a dielectric may be attributed to the viscous resistance offered by the medium to dipole rotation.

The above considerations apply very well for dielectrics having dipole moments which are relatively large and, therefore, dielectric constants greater than 2.5 to 3.

**Dielectric Behaviour of Extremely Low Loss Material**

There is a very important group of materials, however, of which polystyrene is one, for which it is not at the present moment easy to find a quantitative explanation for their electrical behaviour. In these dielectrics, the energy losses per cycle are relatively independent of the frequency over wide ranges of frequency. This might perhaps be explained on the theory that, instead of a single relaxation rate, there exists a uniform logarithmic distribution of relaxation rates.

Kauzmann is inclined to discount this explanation. He rather believes that these losses arise from dimensional changes of the dielectric due to electrostriction with constant rubbing over electrode surfaces with which the dielectric is in contact while subject to an oscillating field.

Since in the case of polystyrene we are dealing with a material whose inherent electrical characteristics are excellent, the presence of even minute amounts of polar materials may affect the dielectric constant and power loss.

The necessary technique for measuring quantities of so small a magnitude as are exhibited with polystyrene is relatively new and the accuracy still a little uncertain. It will be necessary to do much more work before the correct answer will be available.

**Importance of Dielectric Loss in Transmission Line Theory**

It may well be asked, what is a practical illustration of the importance of having low dielectric constant and power loss in insulating materials. Consider for example the case of coaxial cable used for the transmission or reception of high frequency.

It is well known that if a source of high frequency power is impressed on one end of a transmission line, the power that comes out of the

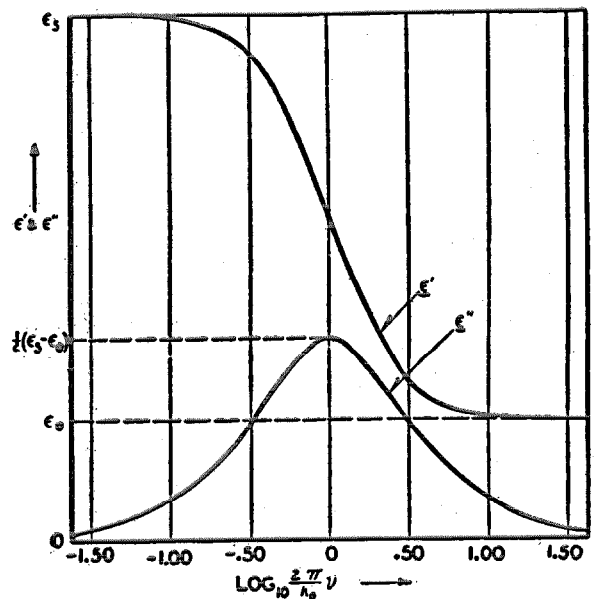

Fig. 18—Frequency Dependence of the Dielectric Constant and Loss Factor.

other end is less, due to the losses in the line. The loss is usually expressed in units known as decibels.\* This loss is composed of that due to

\* Abbreviated db and used to express the difference in power level existing at two points in a network. The number of db =  $10 \log_{10} (P_1/P_2)$ .

the losses in the copper and that due to the losses in the dielectric. For purposes of this discussion, the copper losses need not be considered. The losses due to the dielectric are given by the expression:

$$A_d = 2.78 \times p \times \sqrt{K} \times F \text{ db/100'}$$

where  $p = \text{power factor} = \frac{\epsilon''}{\epsilon'}$ ,

$K = \text{dielectric constant}$ ,

and  $F = \text{frequency in megacycles}$ .

Suppose we have a good dielectric like polystyrene, where  $K = 2.5$  (approx.) and  $p$  is 0.0003. Then at 1 megacycle the losses will be

$$\begin{aligned} A_d &= 2.78 \times 0.0003 \times \sqrt{2.5} \times 1 \text{ db/100'} \\ &= 0.0013 \text{ db/100 ft.} \end{aligned}$$

At 10 megacycles the loss will be 10 times as great, and at 100 megacycles 100 times as great, since neither the power factor nor the dielectric constant of polystyrene change appreciable in this frequency range.

It will thus be seen that increases in the power

factor will have a very marked influence on the losses as the frequency increases.

Should a dielectric be used with a period of anomalous dispersion occurring in the frequency range employed, the losses would vary irregularly over that frequency range—a result even worse than a steady high power loss. It is for this reason that materials like vinylite, koroseal, ethyl cellulose, etc., cannot be used for insulation work at high frequencies.

### Bibliography

1. E. Simon: *Ann.*, **31**, 267 (1839).
2. S. G. Foord: *J.C.S.*, 48 (1940); U.S.P. 2,318,211, 2,318,212, 2,225,471, 2,226,714.  
A. J. Warner & A. A. New: U.S.P. 2,272,996, 2,289,743.
3. Schulz & Husemann: *Z. Phys. Chem.*, **B34**, 187 (1936).
4. Stobbe & Posnjak: *Ann.*, **371**, 259 (1909).
5. Taylor & Vernon: *J.A.C.S.*, **53**, 2527 (1931).
6. Schulz & Wittig: *Naturwissenschaften*, **27**, 387 (1939).
7. Staudinger & Lautenschlager: *Ann.*, **488**, 1 (1931).
8. Houtz & Adkins: *J.A.C.S.*, **53**, 1058 (1931); **55**, 1609 (1933).
9. McClure, Robertson & Cuthbertson: *Can. Jour. Res.*, **20B**, 113 (1942).
10. Gallay: *Kolloid Z.*, **57**, 1 (1931).
11. Schulz & Husemann: *Angew. Chem.*, **50**, 767 (1937); *Z. Phys. Chem.*, **B39**, 266 (1938).
12. Flory: *J.A.C.S.*, **58**, 1871 (1937).
13. Cole: *J. Chem. Physics*, **9**, 341 (1941); **10**, 98 (1942).
14. Kauzmann: *Rev. of Modern Physics*, **14**, 12 (1942).

# The Measured Characteristics of Some Electrostatic Electron Lenses

By KARL SPANGENBERG

*Associate Professor,*

and

LESTER M. FIELD

*Acting Assistant Professor, Electrical Engineering Department, Stanford University*

*Editor's Note: This paper is based on investigations carried on at Stanford University under the sponsorship of the International Telephone and Telegraph Corporation.*

IN a previous paper, an experimental method and some computational methods of determining the characteristics of electron lenses<sup>1</sup> were described. A new means of presenting the operating characteristics of electron lenses was also proposed, the presentation taking the form of a family of curves giving the associated object and image distances and also the lateral magnification for any voltage ratio of the electrodes.

The purpose of this paper is to describe and discuss the characteristics of a number of lenses which were tested. Characteristic curves of nine

<sup>1</sup> Karl Spangenberg and Lester M. Field, "Some Simplified Methods of Determining the Optical Characteristics of Electron Lenses," *Elec. Comm.*, Vol. 20, No. 4, pp. 305-313, 1942.

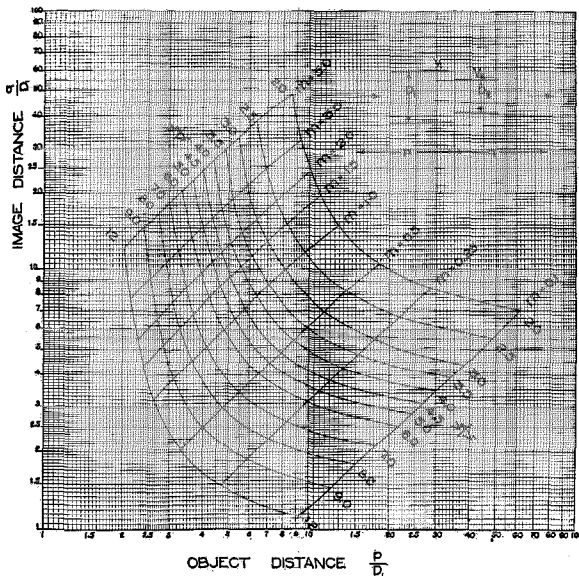

Fig. 1—Two Cylinder Lens  $D_2/D_1 = \frac{2}{3}$ .

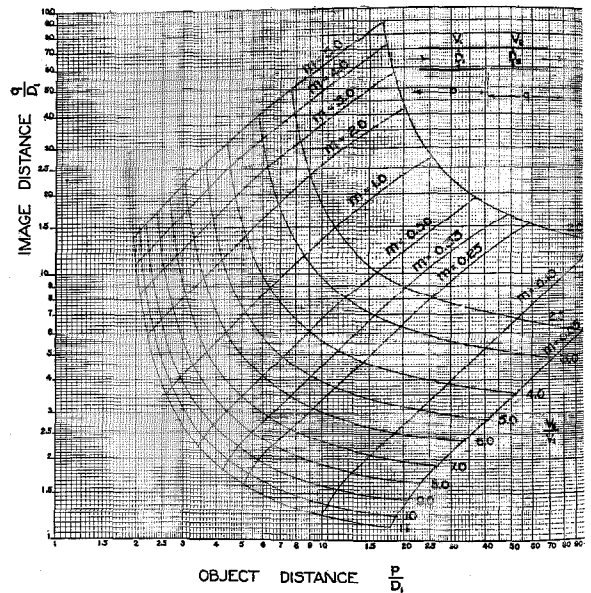

Fig. 2—Two Cylinder Lens  $D_2/D_1 = 1$ , Spacing  $0.1D_1$ .

different lenses of three basic lens types are presented. The forms tested were cylinder lenses of various spacings and diameter-ratios, aperture lenses (parallel plates with circular apertures on the beam axis) of various spacings, and, for comparison, a lens formed by a cylinder and an aperture in a plate. By interpolating between the sets of curves given, approximate predictions of the properties of lenses of slightly different spacings or diameter-ratios may be made. Principal emphasis in this paper is placed upon the interpretation of the Object-Image—Distance Curves.

The data herein presented were obtained by the experimental method reported in the pre-

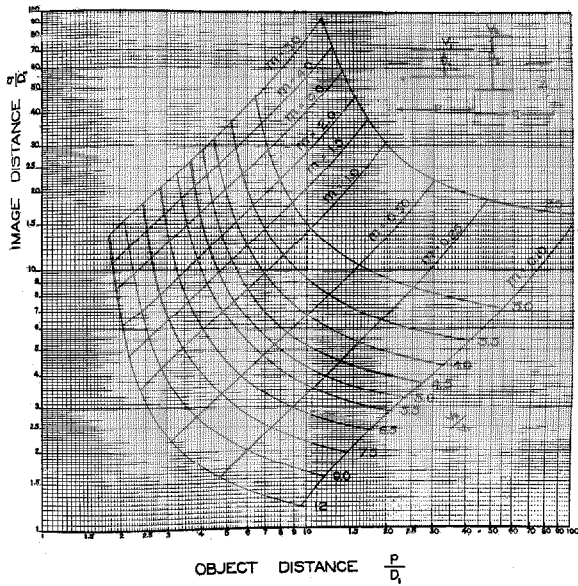

Fig. 3—Two Cylinder Lens  $D_2/D_1=1.5$ .

vious paper. This method makes use of a conventional electron gun with parallel wire grids which, for measurement purposes, are placed before and after the lens to be tested. All of the lens characteristics are deducible from measurements made on shadows cast by these measuring grids upon a fluorescent screen placed in the electron beam at a suitable distance from the gun.

### Presentation of Characteristics of Electron Lenses

The measured characteristics of the electron lenses tested are presented in the form of Object-Image—Distance Curves or what may be designated as the “p-q” Curves. These curves show the relation between object distance and image distance ( $p$  and  $q$ , respectively, in Fig. 13) for any ratio of the voltages applied to the electrodes. The “p-q” Curves also show the lateral magnification,  $m = y'/y$ , associated with any combination of object and image distances. In effect these curves are a graphical presentation of the complete solution of the lens formulas. They are design curves which give immediately and directly the relation between all quantities necessary for lens design.

The “p-q” Curves further show the interrelation between all of the operating character-

istics. The quantities involved are object distance, image distance, lateral magnification, and voltage ratio. The object distance ( $p$ ) is the distance from some reference plane in the lens structure (indicated in each of the curves presented) to the point from which the rays emanate. The image distance ( $q$ ) is the distance from the same reference plane in the lens structure to the point at which the rays focus. The lateral magnification is the ratio between the height of any corresponding portions of image and object,  $y'/y$  in Fig. 13. The voltage ratio is the ratio of potentials on the two components of the electrode structure calculated on the basis of zero potential at the point at which the electron velocity is approximately zero, usually at the cathode. It is only the ratio of potentials and not the absolute magnitude that is of importance since electron paths are independent of the scale of the potential for the same starting conditions.

For completeness, the lens characteristics are also presented in the form of the conventional focal distance curves (Figs. 14 to 22, inclusive). These curves show the variation with voltage ratio of the two focal lengths and of the two focal points. All imaging properties of the lens may be deduced from these parameters.

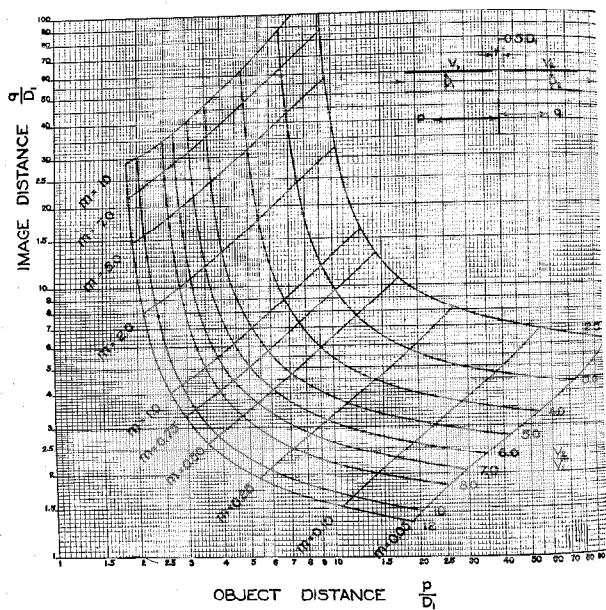

Fig. 4—Two Cylinder Lens  $D_2/D_1=1$ , Spacing  $0.5D_1$ .



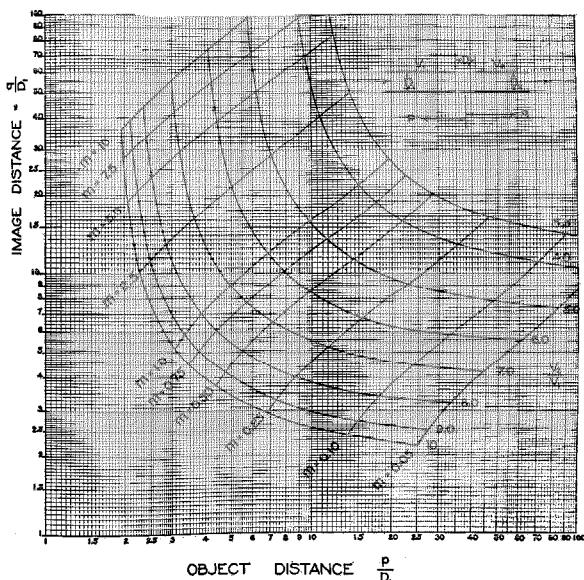

Fig. 5—Two Cylinder Lens  $D_2/D_1=1$ , Spacing  $1.0D_1$ .

**Object-Image—Distance Curves**

In Figs. 1 to 9 are presented the “p-q” Curves of various lenses as listed below:

- Fig. 1 Two Cylinder Lens  $D_2/D_1$  2/3
- Fig. 2 Two Cylinder Lens  $D_2/D_1$  1, Spacing  $.1D_1$
- Fig. 3 Two Cylinder Lens  $D_2/D_1$  1.5
- Fig. 4 Two Cylinder Lens  $D_2/D_1$  1, Spacing  $.5D_1$
- Fig. 5 Two Cylinder Lens  $D_2/D_1$  1, Spacing  $1.0D_1$
- Fig. 6 Aperture Lens  $A/D$  5
- Fig. 7 Aperture Lens  $A/D$  3
- Fig. 8 Aperture Lens  $A/D$  1
- Fig. 9 Aperture-Cylinder Lens

The results presented in Figs. 1 to 9 have been checked wherever possible by comparison with all readily available previously published data on lens characteristics. Good agreement was found in most cases. These comparisons were usually made between curves of the usual type plotted on the basis of focal length. Comparison was confined to a small range of voltage ratios since so few of the published curves were for lenses operated at extreme voltage ratios.

An estimate of the relative accuracy of the results published here is, in order of magnitude, within 10% for all curves of lenses with small spacing, and within 20% for curves of lenses with large spacing.

Three general relations, which are exactly as expected from lens theory, are immediately ob-

servable from the curves of results presented. As the object distance is increased at a given voltage ratio, the corresponding image distance decreases, as does also the magnification. For a given object distance, the image distance and magnification decrease as the voltage ratio is increased. In any lens there is a minimum object distance which can form a real image at any given voltage ratio. This minimum object distance is determined by the vertical asymptote to the contour of constant voltage ratio (corresponding to the object at the focal point on the object side).

**Magnification Properties of Lenses**

The following magnification properties of lenses were observed:

1. Contours of constant magnification in the “p-q” Curves as represented here are approximately straight lines with a slope of one.
2. An approximate universal magnification formula which fits all lenses tested is

$$m = kq/p,$$

where  $p$  and  $q$  are object and image distance, respectively. Values of the constant for the lenses tested are:

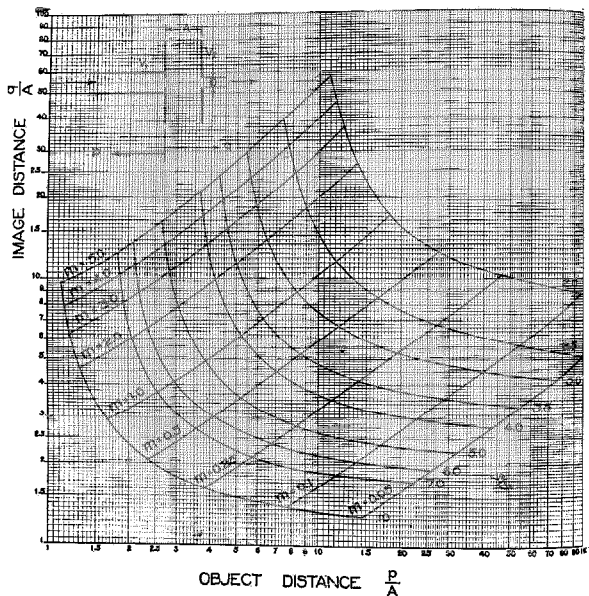

Fig. 6—Aperture Lens  $A/D=5$ .

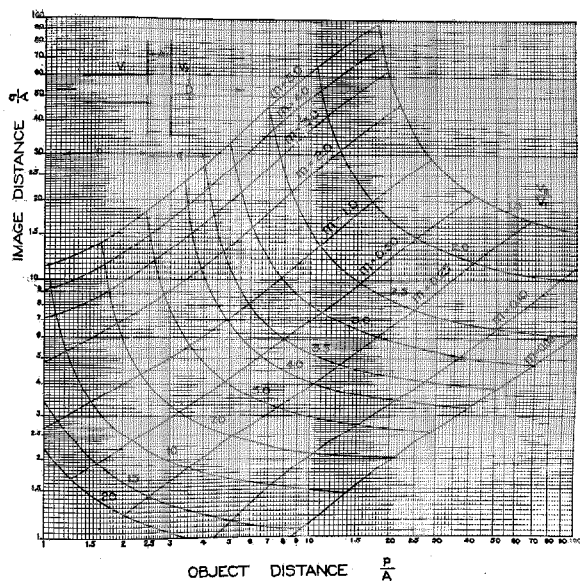

Fig. 7—Aperture Lens  $A/D=3$ .

|                   |                  |           |           |
|-------------------|------------------|-----------|-----------|
| Cylinder Lens     | $D_2/D_1 = .667$ |           | $k = .82$ |
| Cylinder Lens     | $D_2/D_1 = 1$    | $S = 0.1$ | $k = .78$ |
| Cylinder Lens     | $D_2/D_1 = 1.5$  |           | $k = .76$ |
| Cylinder Lens     | $D_2/D_1 = 1$    | $S = 0.5$ | $k = .80$ |
| Cylinder Lens     | $D_2/D_1 = 1$    | $S = 1$   | $k = .60$ |
| Aperture Lens     | $A/D = 5$        |           | $k = .95$ |
| Aperture Lens     | $A/D = 3$        |           | $k = .80$ |
| Aperture Lens     | $A/D = 1$        |           | $k = .78$ |
| Aperture-Cylinder |                  |           | $k = .82$ |

It is evident that with only two exceptions the value of the constant is within a few percent of .80. The universal magnification formula (for lateral magnification),  $m = kq/p$ , is not entirely evident from theoretical considerations and so far has not been amenable to exact demonstration. If the lenses were thin lenses with equal initial and final potentials, the property would be expected exactly. The magnification would then be  $m = q/p$ . This results since, in a thin lens, a ray can be drawn from a point on the object through the center of the lens to a corresponding point on the image, and the above property follows from simple geometrical considerations.

In the thick lens, however, the corresponding ray does not go through the geometrical center of the lens but must be drawn with consideration to two points known as the nodal points. These by definition are two points, on the axis, determined by a ray which enters the lens at some angle with the axis and leaves the lens making the same angle with the axis. Such a ray

can always be found; the intersections of the extended initial and final straight line portions with the axis give the nodal points.<sup>2</sup>

In the lenses tested some sample calculations have shown that the nodal points are very close together and lie beyond the center of the lens on the high voltage side; also, that their positions change with voltage ratio in such a way that the magnification for any ratio of object to image distance remains at approximately 0.8 of the value of image distance divided by object distance. The position of the nodal points on the high voltage side of the lens center accounts for the magnification always being less than the ratio of image to object distance. For instance, for the two diameter cylinder lens with a ratio of diameter of 2/3, the image distance is twenty percent greater than the object distance when the magnification is 1 (one), and it is also twenty percent greater than one-tenth of the object distance for a magnification of one-tenth. It should be remarked, however, that this property is not always so well fulfilled.

**Lens Comparisons**

In Figs. 10, 11, and 12 are shown comparison curves of three basic lens types. These compari-

<sup>2</sup>This is in accordance with observations on the same subject by O. Klemperer, "Electron Optics," Cambridge University Press, 1939, p. 30.

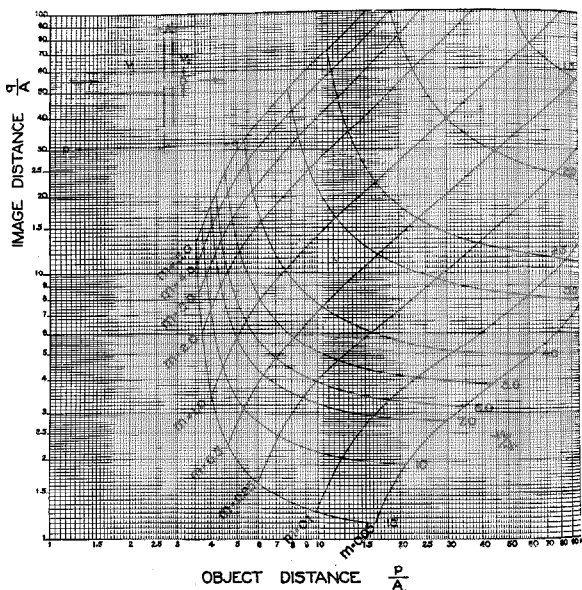

Fig. 8—Aperture Lens  $A/D=1$ .

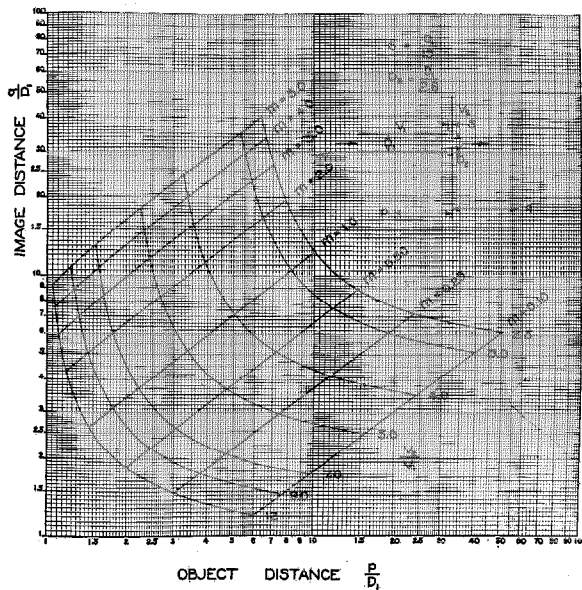

Fig. 9—Aperture Cylinder Lens.

son curves are obtained by superimposing portions of the "p-q" Curves of the individual lenses.

The curve sheet of Fig. 10 comparing the two-diameter cylinder lenses demonstrates that, in the normally used range of voltage ratios (in the vicinity of  $V_2/V_1 = 3$ ), the lenses will focus an object located at a given distance from the lenses at greater and greater image distances as the lens diameter ratio,  $D_2/D_1$ , is raised from .666 to 1 and finally to 1.5. For example, with an object distance of 10 small cylinder diameters, at a voltage ratio  $V_2/V_1 = 3$ , the lens with  $D_2/D_1 = .666$  will focus at an image distance of 8 small cylinder diameters, the lens with  $D_2/D_1 = 1$  will focus at 9.7 diameters, and the lens with  $D_2/D_1 = 1.5$  will focus at 15 diameters. In addition, the larger  $D_2/D_1$  is made, the higher the voltage ratio necessary for focusing a given object at a given distance. Further, the larger the ratio of  $D_2/D_1$  used, the smaller the image will be for a given object size (distances remaining constant). This arises from the change in the value of  $m$ , the magnification, for different diameter ratios.

|                               |           |
|-------------------------------|-----------|
| $D_2/D_1 = .666$              | $k = .82$ |
| $D_2/D_1 = 1$ (small spacing) | $k = .78$ |
| $D_2/D_1 = 1.5$               | $k = .76$ |

The curve sheet of Fig. 11 comparing the equal-diameter cylinder lenses with various values of spacing between cylinders demon-

strates variations similar to those mentioned above. At a constant voltage ratio in the normally used range, the lenses will focus an object located at a given distance from the lens at greater and greater image distances as the spacing between lenses is increased. The effect is very small (and in a small region, reversed) up to spacings of one-half diameter, but becomes very evident at spacings as large as one diameter. The average magnifications are:

|                 |           |
|-----------------|-----------|
| Spacing = 0.1 D | $k = .78$ |
| Spacing = 0.5 D | $k = .80$ |
| Spacing = 1.0 D | $k = .60$ |

The curve sheet of Fig. 12 comparing aperture lenses on the basis of equal aperture diameters with varying spacing again demonstrates the general trends shown above. As the ratio of spacing to diameter is increased at a constant object distance and constant voltage ratio, the lens focusses further away—the image distance increases. The effect is very pronounced; for example, with a voltage ratio  $V_2/V_1 = 3$  and an object distance of 30 aperture diameters, the lenses with a spacing to diameter ratio of 1, 3 and 5 focussed at 9.2, 24 and 90 aperture diameters, respectively. The corresponding magnifications resulting are:

|               |           |
|---------------|-----------|
| Spacing = 1 D | $k = .95$ |
| Spacing = 3 D | $k = .80$ |
| Spacing = 5 D | $k = .78$ |

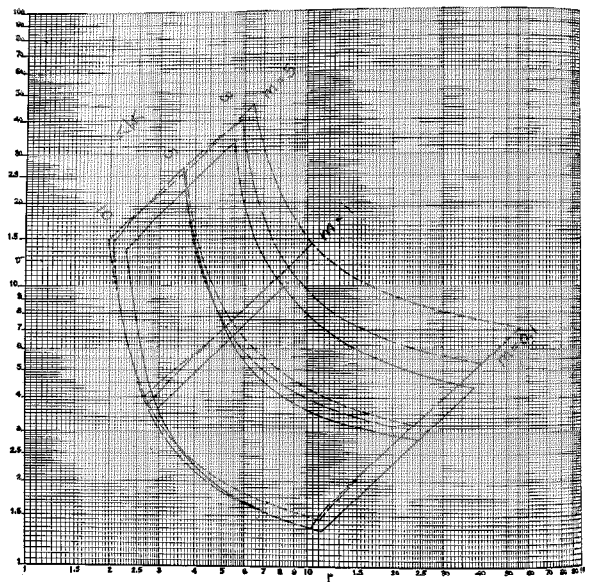

Fig. 10—Comparison of Two Diameter Lenses.

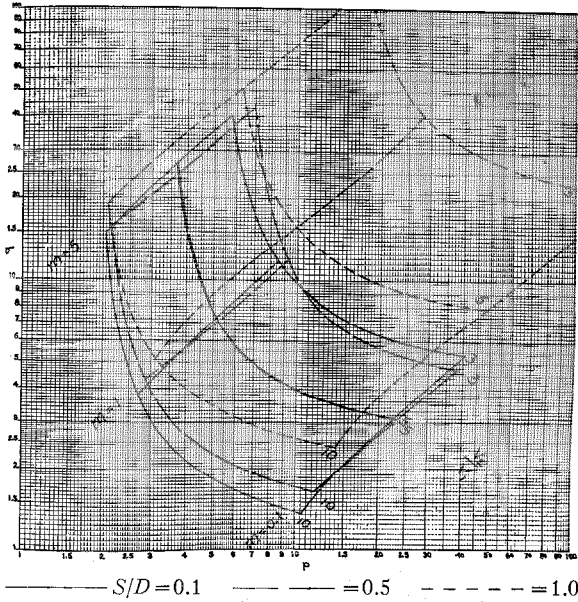

Fig. 11—Comparison of Equal Diameter Lenses.

**Focal Lengths of Lenses**

In Fig. 13 is shown the terminology used in the conventional focal distance curves of Figs. 14 to 22, which show the way in which the four principal focal quantities of the lens vary with voltage ratio. These lenses tested here are like the thick lenses of physical optics and as such require four parameters to describe completely their characteristics. Actually each electrode structure represents an infinite set of lenses since the lens action is different for each voltage ratio. Hence it is necessary to present the four parameters in curve form showing variation with voltage ratio. The four parameters usually plotted are two focal lengths, one for each direction through the lens, and the distance from a reference plane in the lens to the points at which rays entering and leaving parallel to the axis cross the axis on the other side of the lens. These four quantities serve to locate the "principal planes" of the lens, i.e., the planes determined by the intersection of the projected straight line portions of the rays entering and leaving parallel to the axis; these rays in turn are known as the "principal rays."

The focal quantities mentioned above do not appear directly in the "p-q" Curves of Figs. 1 to 9. They are merely parameters involved in the calculation of the operating conditions and need not appear in the results.

The curves of Figs. 14 to 22 confirm some properties of the focal characteristics anticipated from lens theory. Focal lengths are observed to be uniformly decreasing functions of voltage ratio. The principal planes are with but one exception found to be crossed, that is, the first principal plane lies between the second principal plane and the lens center on the low voltage side of the lens. The exception is the double aperture lens with electrode spacing small compared to aperture diameter. The focal length in the direction of increasing potential is always greater than the focal length in the other direction. The position of the principal planes does not change much with voltage ratio. Numerical tests on the measured focal distances check Newton's formula

$$(p - F)(q - F') = ff'$$

or, the product of the distances from the focal points to the object and image, respectively, is equal to the product of the focal lengths. It may also be verified that the square root of the voltage ratio equals the ratio of the corresponding focal lengths

$$f'/f = (V_2/V_1)^{1/2}$$

This is a consequence of an analogue of Lagrange's law for optics which states that the product of the square root of the voltage ratio,

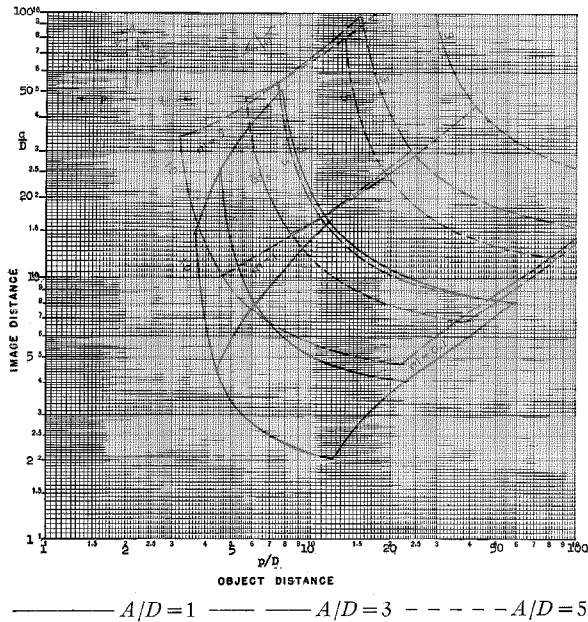

Fig. 12—Comparison of Aperture Lenses.

the lateral magnification, and the angular magnification is equal to unity, i.e.,

$$\sqrt{\frac{V_2 y' \alpha'}{V_1 y \alpha}} = 1$$

where the notation corresponds to Fig. 13.

**Conclusion**

Operating characteristics of nine lenses of three basic lens types are presented in the form of object-image—distance curves which give directly the associated object and image distances and the corresponding lateral magnification for any voltage ratio. Accuracy of results is good and a wide range of voltage ratios and dimensions is covered.

The focal length curves of the lenses tested verify the expected basic properties of lenses.

The contours of constant magnification in the “p-q” Curves are approximately straight lines with a slope of one. An approximate formula for lateral magnification that holds closely for all lenses tested is  $m = 0.8 p/q$ .

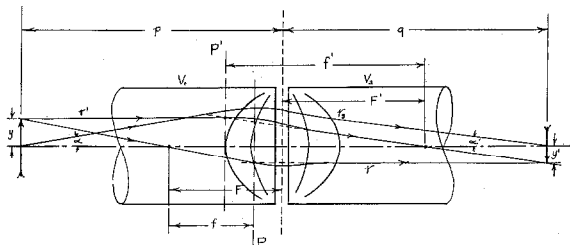

Fig. 13—Lens Terminology.

- p* Object Distance
- q* Image Distance
- r* First Principal Ray
- r'* Second Principal Ray
- r<sub>g</sub>* General Ray
- $V_2/V_1 > 1$
- f* First Focal Length
- f'* Second Focal Length
- F* Location of First Focal Point
- F'* Location of Second Focal Point
- P* First Principal Plane
- P'* Second Principal Plane

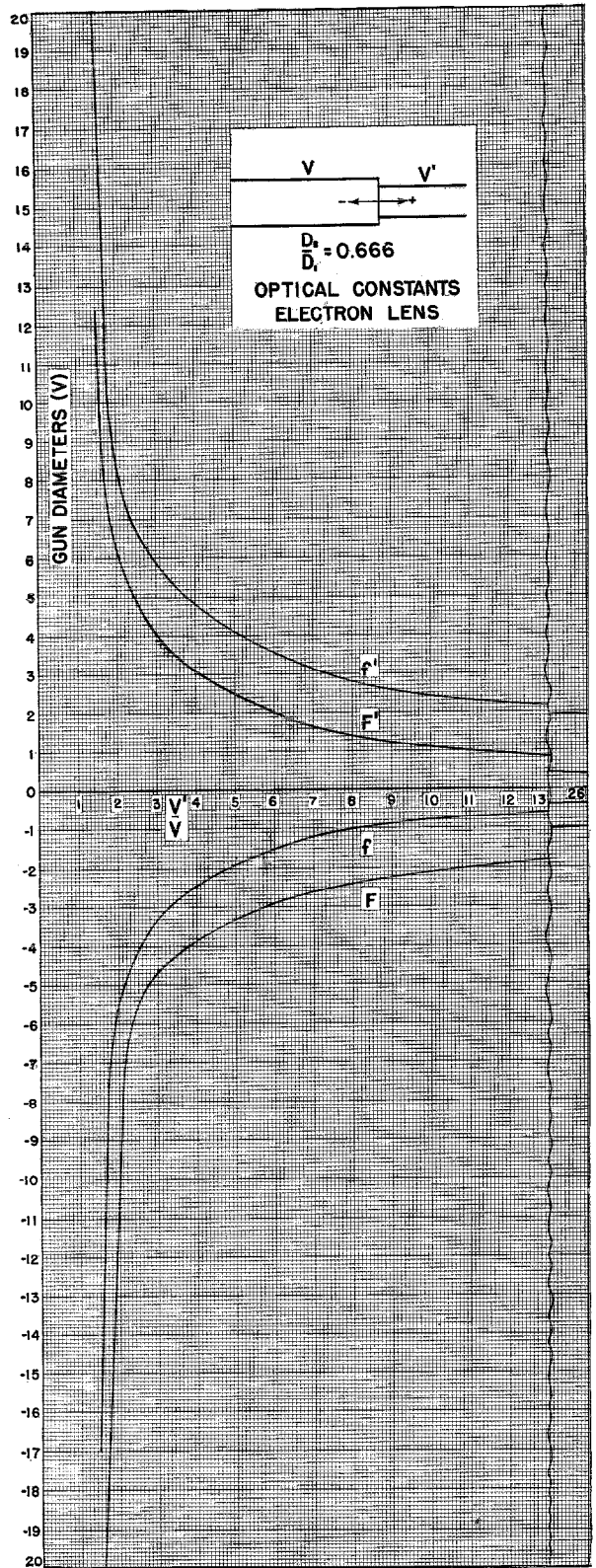

Fig. 14—Two Cylinder Lens  $D_2/D_1 = 2/3$ .

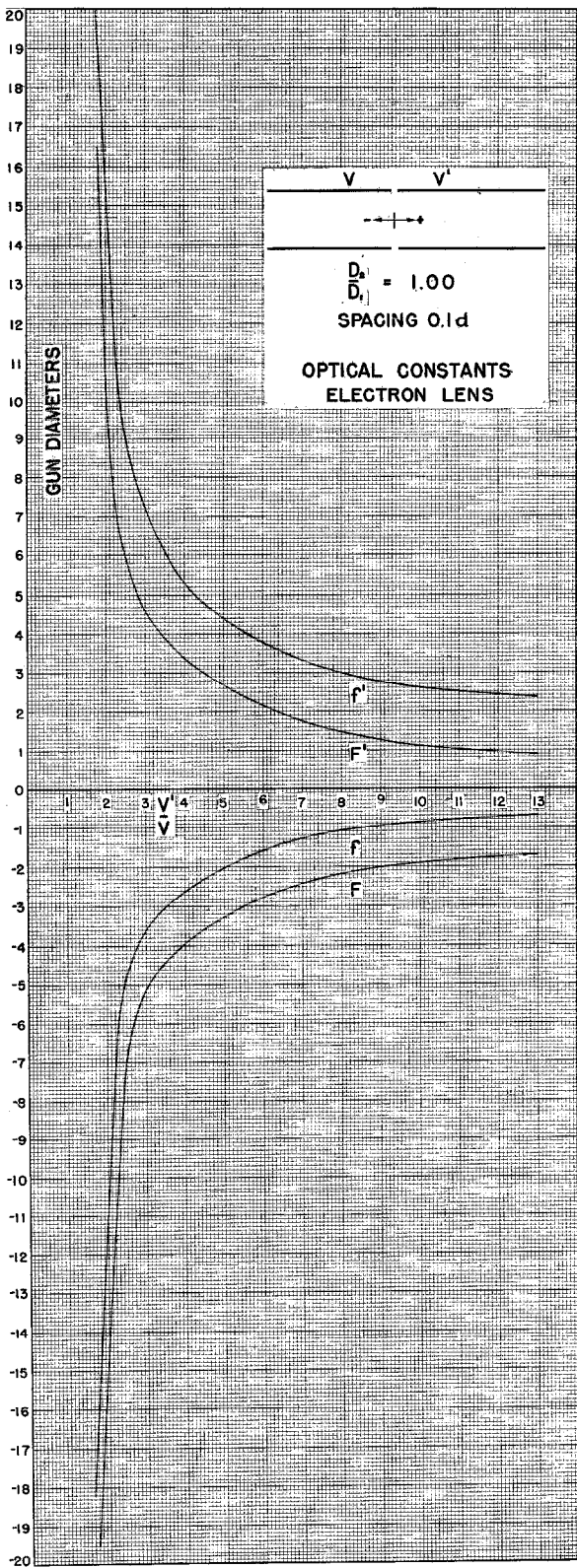

Fig. 15—Two Cylinder Lens  $D_2/D_1 = 1$ , Spacing  $0.1D_1$ .

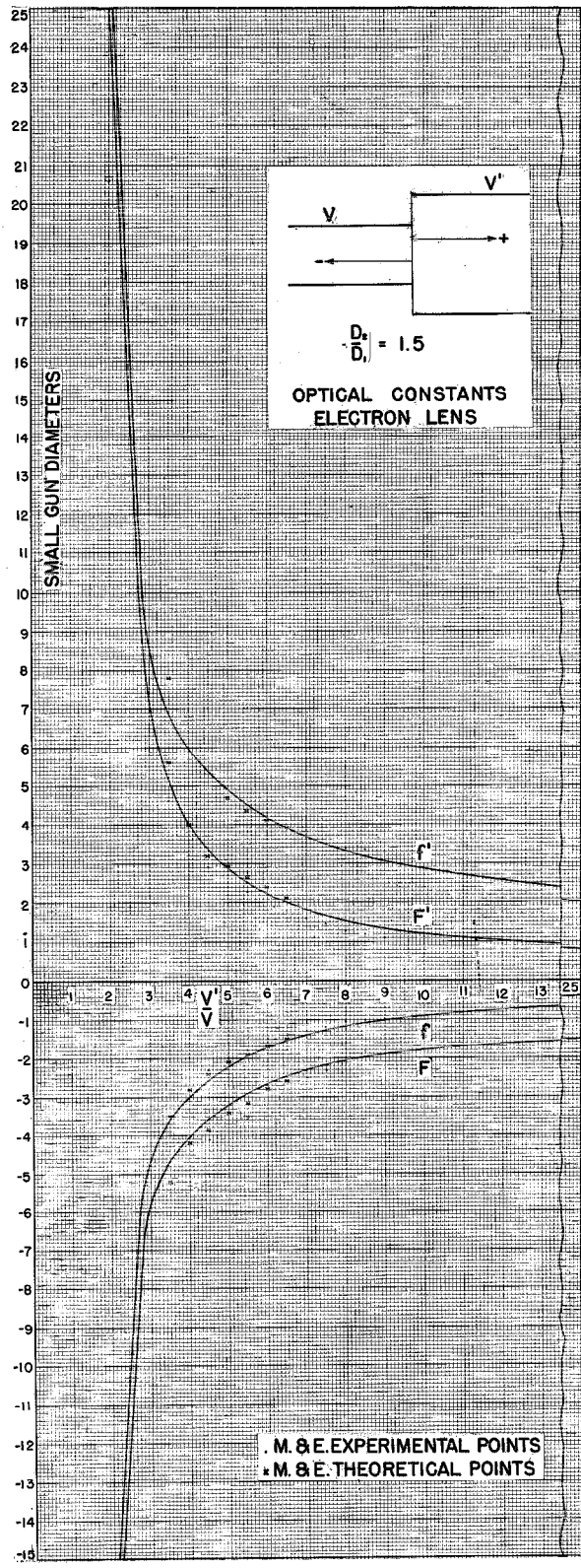

Fig. 16—Two Cylinder Lens  $D_2/D_1 = 1.5$ .

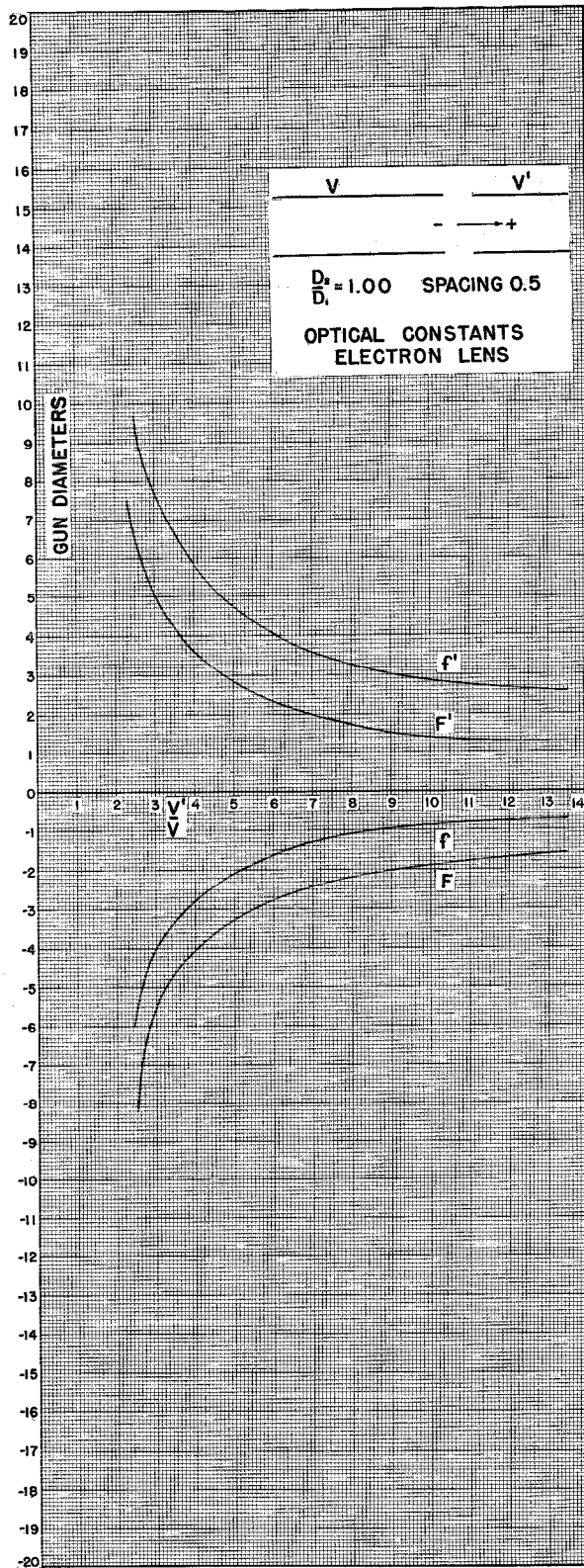

Fig. 17—Two Cylinder Lens  $D_2/D_1 = 1$ , Spacing  $0.5D_1$ .

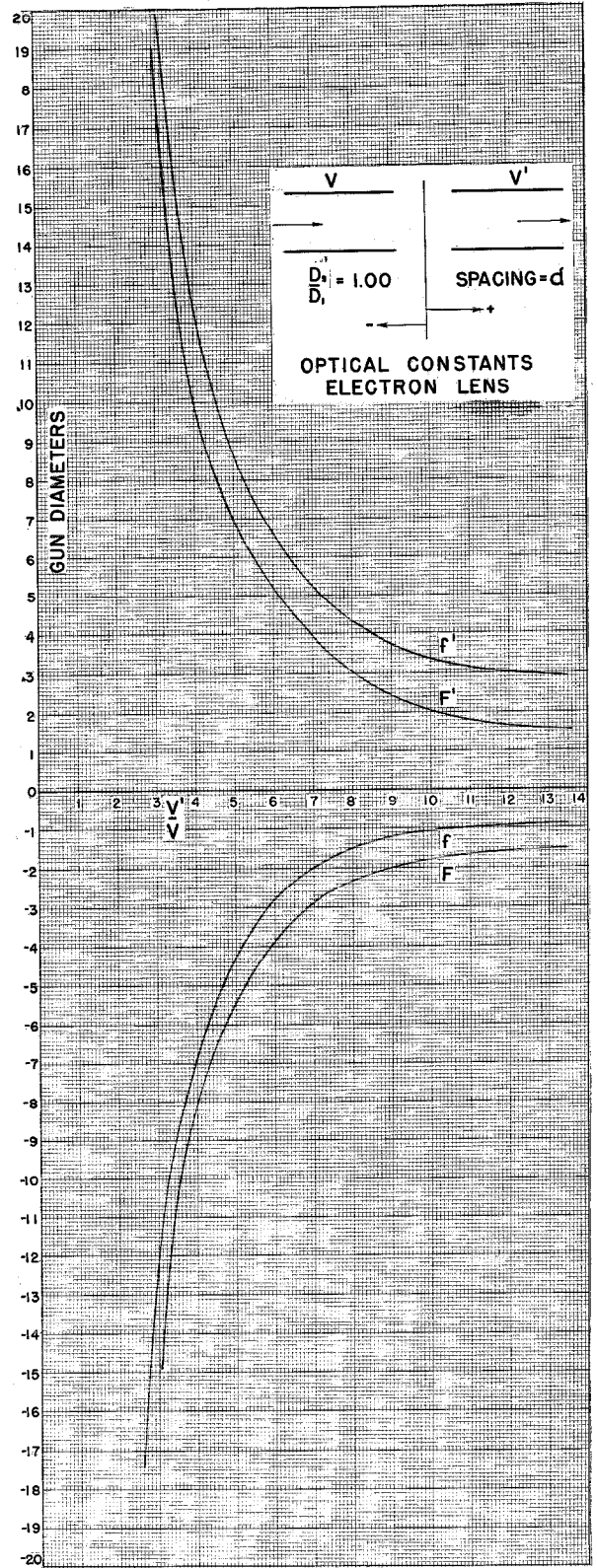

Fig. 18—Two Cylinder Lens  $D_2/D_1 = 1$ , Spacing  $1.0D_1$ .

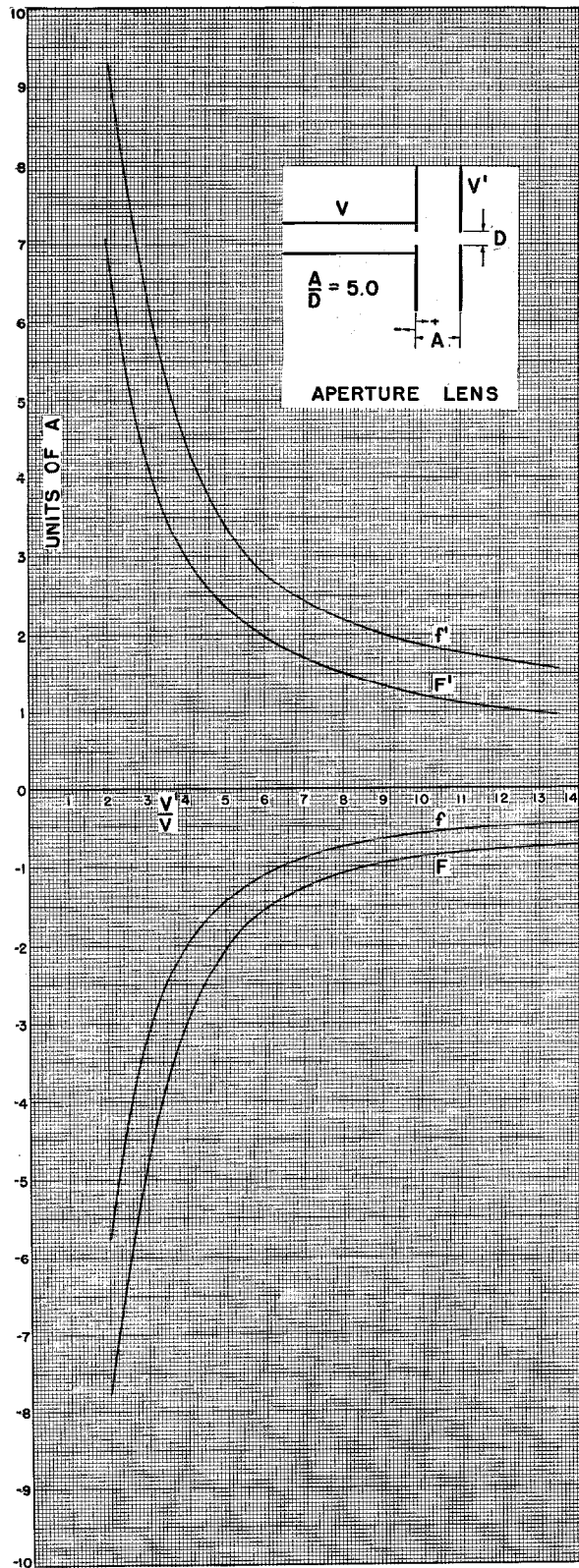

Fig. 19—Aperture Lens  $A/D = 5$ .

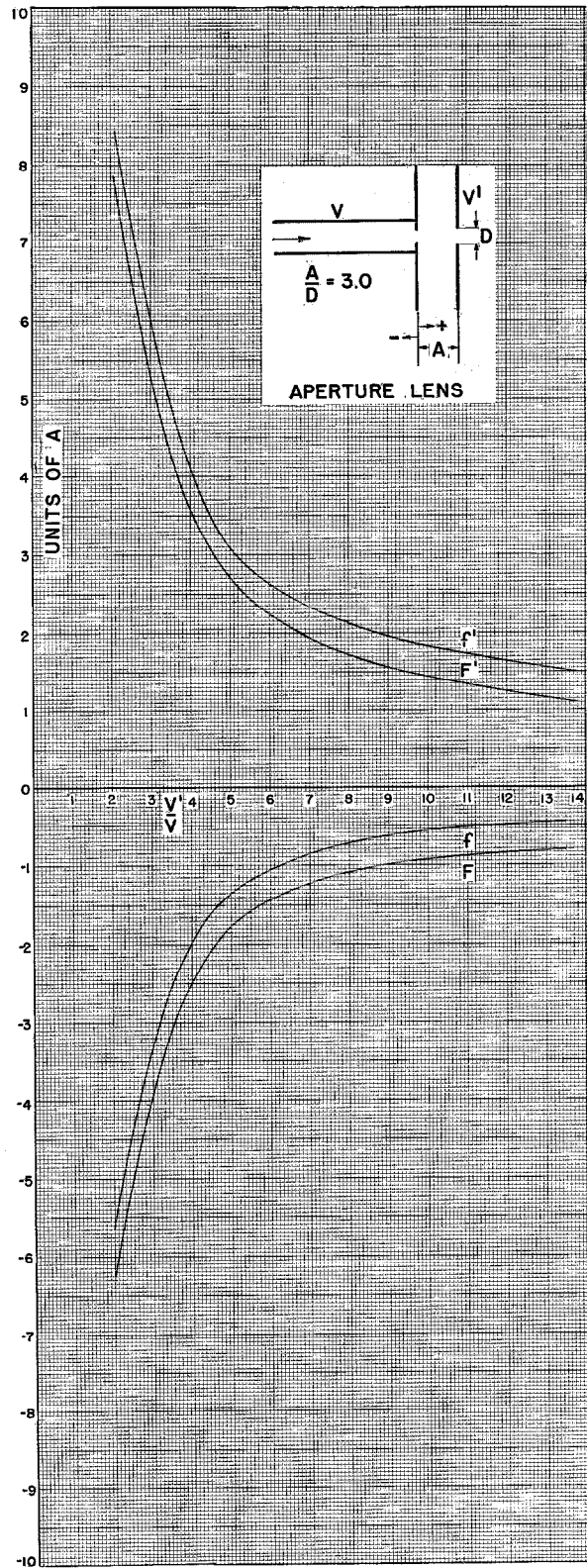

Fig. 20—Aperture Lens  $A/D = 3$ .



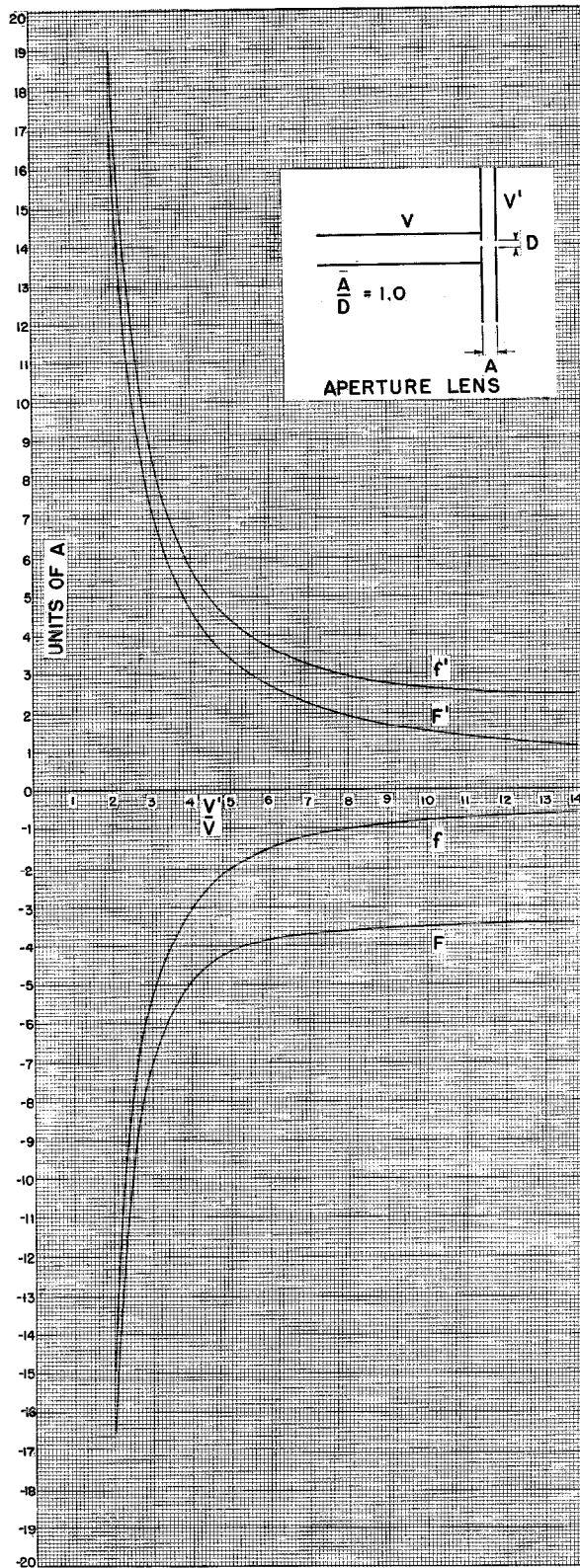

Fig. 21—Aperture Lens  $A/D = 1$ .

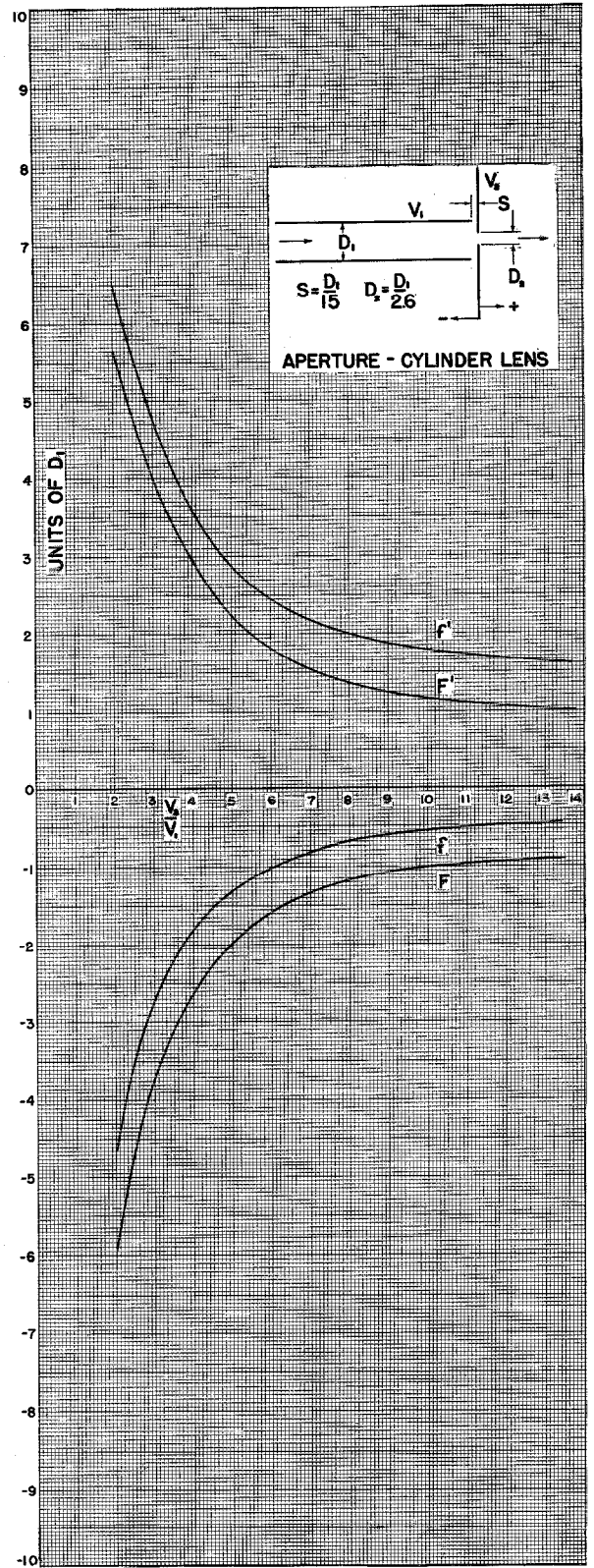

Fig. 22—Aperture Cylinder Lens.

# Reference Data for Radio Engineers

By H. H. BUTTNER, Vice President

Federal Telephone and Radio Corporation, New York, N. Y.

THE Federal Telephone and Radio Corporation has published a compact radio handbook entitled "Reference Data for Radio Engineers."

This book is presented as an aid to radio research, development, production and operation. In the selection of material, the aim was to provide for the requirements of engineers as well as practical technicians, both in the laboratory and in the field. Hence, more fundamental information is included than is usually found in a radio handbook of comparable size (200 pages; 5 $\frac{3}{4}$ " by 8 $\frac{3}{4}$ ").

To indicate the fields covered, the following is reproduced from the "Contents" pages:

| <b>General Engineering Tables</b>                               | Page<br>No. |
|---|-------------|
| Conversion Table . . . . .                                      | 11          |
| Fractions of an Inch with Metric Equivalents . . . . .          | 12          |
| Copper Wire Table . . . . .                                     | 13          |
| Copperweld Wire: Mechanical and Electrical Properties . . . . . | 14          |
| Standard Stranded Copper Conductors . . . . .                   | 15          |
| Screw Head Styles and Method of Length Measurement . . . . .    | 15          |
| Standard Machine Screw Data Chart for Hole Sizes . . . . .      | 16          |
| <br>  |             |
| <b>Engineering and Material Data</b>                            |             |
| Insulating Materials . . . . .                                  | 17          |
| Plastics: Trade Names . . . . .                                 | 18          |
| Physical Constants of Various Metals . . . . .                  | 19          |
| Fusing Currents of Wire . . . . .                               | 21          |
| Melting Points of Solder . . . . .                              | 21          |
| Temperature Chart of Heated Metals . . . . .                    | 22          |
| Spark Gap Voltages . . . . .                                    | 23          |
| Thermocouples and Their Characteristics . . . . .               | 24          |
| Characteristics of Typical Thermocouples . . . . .              | 25          |
| Head of Water and Approximate Discharge Rate . . . . .          | 26          |
| Wind Velocities and Pressures . . . . .                         | 27          |
| Weather Data . . . . .  | 27          |
| Temperature Extremes . . . . .                                  | 27          |
| Precipitation Extremes . . . . .                                | 27          |
| World Temperatures . . . . .                                    | 28          |
| World Precipitation . . . . .                                   | 29          |
| Principal Power Supplies in Foreign Countries . . . . .         | 30          |
| Audible Spectrum . . . . .                                      | 33          |
| Ether Spectrum . . . . .  | 34          |
| Radio Frequency Classifications . . . . .                       | 34          |
| <br>  |             |
| <b>Audio and Radio Design—General</b>                           |             |
| Condenser Color Code . . . . .                                  | 35          |
| Resistor Color Code . . . . .                                   | 36          |
| Standard Color Coding for Resistors . . . . .                   | 37          |
| Inductance Charts for Single Layer Solenoids . . . . .          | 39          |
| Copper Wire Coil Data . . . . .                                 | 42          |

|  | Page<br>No. |
|--|-------------|
| Reactance Charts . . . . .                   | 43          |
| Time Constants for Series Circuits . . . . . | 47          |
| Impedance Formulas . . . . .                 | 50          |
| Network Theorems . . . . .                   | 54          |
| Electrical Circuit Formulas . . . . .        | 55          |
| Attenuators . . . . .                        | 65          |
| Filter Networks . . . . .                    | 70          |

## Rectifiers

|   |    |
|---|----|
| Special Connections and Circuit Data for Typical Rectifiers . . . . . | 72 |
| Selenium Rectifiers . . . . .   | 75 |

## Vacuum Tubes and Amplifiers

|  |     |
|--|-----|
| Vacuum Tube Design . . . . .                           | 79  |
| Nomenclature . . . . .                                 | 79  |
| Coefficients . . . . .                                 | 80  |
| Terminology . . . . .                                  | 80  |
| Formulas . . . . .                                     | 81  |
| Electrode Dissipation Data . . . . .                   | 82  |
| Filament Characteristics . . . . .                     | 83  |
| Ultra-High Frequency Tubes . . . . .                   | 84  |
| Vacuum Tube Amplifier Design . . . . .                 | 88  |
| Classification . . . . .                               | 88  |
| General Design . . . . .                               | 88  |
| Graphical Methods . . . . .                            | 92  |
| Resistance Coupled Audio Amplifier Design . . . . .    | 101 |
| Negative Feedback . . . . .                            | 102 |
| Distortion . . . . .                                   | 103 |
| Army and Navy Preferred List of Vacuum Tubes . . . . . | 103 |
| Cathode Ray Tubes, Approximate Formulas . . . . .      | 104 |

## Telephone Transmission

|   |     |
|---|-----|
| Power Ratio, Voltage Ratio, Decibel Table . . . . . | 106 |
| Transmission Line Data and Constants . . . . .      | 107 |

## Radio Frequency Transmission Lines

|  |     |
|--|-----|
| Transmission Line Data . . . . .                                     | 113 |
| Surge Impedance of Uniform Lines . . . . .                           | 114 |
| Transmission Line Types and Their Characteristic Impedance . . . . . | 116 |
| Impedance Matching with Shorted Stub . . . . .                       | 117 |
| Impedance Matching with Open Stub . . . . .                          | 117 |
| Wave Guides and Resonators . . . . .                                 | 118 |

## Radio Propagation and Antennas

|  |     |
|--|-----|
| Field Strength of Radiation from an Antenna . . . . .                          | 127 |
| Field Strength from an Elementary Dipole . . . . .                             | 127 |
| Ultra-Short Wave Propagation . . . . .   | 131 |
| Line of Sight Transmission Distance . . . . .                                  | 132 |
| Reflection Coefficient of Plane Radio Waves from Surface of the Sea . . . . .  | 132 |
| Distance Ranges of Radio Waves . . . . .                                       | 133 |
| Radio Transmission and the Ionosphere . . . . .                                | 139 |
| Time Interval between Transmission and Reception of Reflected Signal . . . . . | 142 |
| Linear Radiators . . . . .   | 143 |
| Maxima and Minima of Radiation—Single-Wire Radiator . . . . .                  | 144 |

|  | Page<br>No. |  | Page<br>No. |
|--|-------------|--|-------------|
| Antenna Arrays . . . . .   | 144         | Complex Hyperbolic and Other Functions . . . . .   | 176         |
| Radiation Pattern of Several Common Types of<br>Antennas . . . . .       | 147         | Great Circle Calculations . . . . .  | 179         |
| Radiation Pattern of Multi-Element Linear<br>Broadside Array . . . . .   | 148         | <b>Mathematical Tables</b>   |             |
| Radiation Pattern of Multi-Element Binomial<br>Broadside Array . . . . . | 149         | Logarithms of Numbers and Proportional Parts . . . . .   | 181         |
| Frequency Tolerances . . . . .   | 150         | Natural Trigonometric Functions for Decimal Fractions<br>of a Degree . . . . .   | 183         |
| <b>Noise and Noise Measurement</b>                                       |             | Logarithms of Trigonometric Functions for Decimal<br>Fractions of a Degree . . . . .   | 187         |
| Wire Telephony . . . . .   | 153         | Exponentials ( $e^n$ and $e^{-n}$ ) . . . . .  | 191         |
| Radio . . . . .  | 156         | Natural or Napierian Logarithms . . . . .  | 192         |
| <b>Non-Sinusoidal Waveforms</b>  |             | Hyperbolic Sines . . . . .   | 194         |
| Relaxation Oscillators . . . . .   | 157         | Hyperbolic Cosines . . . . .   | 195         |
| Electronic Differentiation Methods . . . . .                             | 159         | Hyperbolic Tangents . . . . .  | 196         |
| Fourier Analysis of Recurrent Waveforms . . . . .                        | 160         | Bessel Functions . . . . .   | 197         |
| Analyses of Commonly Encountered Waveforms . . . . .                     | 165         |  |             |
| <b>Dimensional Expressions</b>   |             | Material for this book was compiled by engi-<br>neers of the I. T. & T. System—the International<br>Telephone and Telegraph Corporation, Inter-<br>national Standard Electric Corporation, Mackay<br>Radio & Telegraph Co., and the Federal Tele-<br>phone and Radio Corporation and its Labora-<br>tories, located in New York City and Newark,<br>New Jersey. A similar book of the same title,<br>published by Standard Telephones and Cables,<br>Ltd., London, was warmly received in Great<br>Britain. The F. T. & R. book includes additional<br>material specifically selected for its usefulness in<br>connection with this country's contribution to<br>the war effort. |             |
| . . . . .  | 171         | The First Edition of the book has been dis-<br>tributed. The second printing of this First Edi-<br>tion is now available at \$1.00 per copy. Inquiries<br>should be addressed to Publication Department,<br>Federal Telephone and Radio Corporation, 67<br>Broad Street, New York 4, New York.   |             |
| <b>Greek Alphabet</b>  |             |  |             |
| . . . . .  | 171         |  |             |
| <b>Mathematical Formulas and General Informa-<br/>tion</b>               |             |  |             |
| Miscellaneous Data . . . . .   | 172         |  |             |
| Mensuration Formulas . . . . .   | 172         |  |             |
| Formulas for Complex Quantities . . . . .                                | 173         |  |             |
| Algebraic and Trigonometric Formulas . . . . .                           | 173         |  |             |
| Approximations for Small Angles . . . . .                                | 175         |  |             |
| Quadratic Equation . . . . .   | 175         |  |             |
| Arithmetical Progression . . . . .                                       | 175         |  |             |
| Geometrical Progression . . . . .  | 175         |  |             |
| Combinations and Permutations . . . . .                                  | 175         |  |             |
| Binomial Theorem . . . . .   | 175         |  |             |
| Maclaurin's Theorem . . . . .  | 175         |  |             |
| Trigonometric Solution of Triangles . . . . .                            | 176         |  |             |

## Recent Telecommunications Developments

**SIMPLIFIED SUBSCRIBERS' TELEPHONE SETS.**— The United States Signal Corps has specified that in the future all common battery cradle type telephone sets intended for the tropics shall be the equivalent of telephone set IT-6775, as made by the Federal Telephone and Radio Manufacturing Corporation, both with respect to moistureproofing and performance. This set was described in *Electrical Communication*, Volume 21, No. 1, 1942.

Because of the set's dependability it is particularly well suited for use on the far-flung fronts of today's global war. Repairs can be made merely by loosening several screws and substituting a new unit for the one that has been removed. There are no wires to disconnect and reconnect, and when the set's cover is removed, the switch mechanism is not disturbed.

This set was developed with the idea of reducing the cost of repairs and maintenance. Its induction coil, condenser and ringer are equipped with slotted terminals which slip under the screw heads of its connecting block and switch assembly. When the screws are tightened the connections are completed inasmuch as there are no loose cables to break or to cause low insulation resistance. Cables and wires ordinarily used in the connecting block have been replaced by heavy cross connecting bus bars to which screw terminals are connected at the factory.

The switch hook is a self-contained unit completely enclosed to exclude dust, and the springs are operated by means of a phosphor bronze roller on the plunger, preventing sticking and assuring positive action. Other features of the set are that its induction coil and condenser are enclosed in individual bakelite containers filled with insulating compound and that the ringer is provided with completely moisture-proof coils.

• • •

**MACKAY RADIO AND TELEGRAPH SERVICES.**— A new radio telegraph station at Algiers, North Africa, was opened by Mackay Radio and

Telegraph Company on July 23, 1943. It was installed and equipped by Mackay Radio and is manned by the Company's own personnel. Designed to expedite the handling of traffic between Algiers and the U. S. A., it is now being operated 24 hours daily and provides a circuit additional to that operated through the facilities of the French Posts Telegraph & Telephone Administration, Algiers, and Mackay Radio's station in New York.

These two circuits afford adequate facilities for the handling of a large volume of traffic between North Africa and the United States, including the increasing volume of traffic resulting from civil and press requirements as well as the growing utilization of the Company's facilities for the transmission of expeditionary force messages. The latter, known as EFM messages, is a special low rate communication service costing but \$.60 U. S. currency, plus 10% tax, and is available to members of the armed forces abroad and friends and relatives at home.

Other circuits recently opened by Mackay Radio are:

New York—Accra, Gold Coast (May 28, 1943)  
New York—Kabul, Afghanistan (June 27, 1943)  
New York—Tananarive, Madagascar (July 30, 1943)

The above circuits provide the first direct telegraph service between these countries and the U. S. A. Additional international radio telegraph circuits, opened by the Mackay Radio and Telegraph Company since the United States entered the war in December, 1941, totals 22.

• • •

**UNITED STATES—BRAZIL RADIOPHOTO SERVICE.**  
—Radiophoto service between the United States and Brazil was inaugurated on September 7th. At Rio de Janeiro the service is operated by Companhia Radio Internacional do Brasil; in New York, by the Mackay Radio and Telegraph Company.

**T**HE BUENOS AIRES SECTION OF THE INSTITUTE OF RADIO ENGINEERS.—Guillermo J. Andrews, Manager of the Radio Department of Compañia Standard Electric Argentina, an associate of the International Telephone and Telegraph Corporation, was elected Chairman of the Buenos Aires Section of the Institute of Radio Engineers for the 1943-1944 period. Mr. Andrews, at 32, is the youngest member of the Buenos Aires I.R.E. Section to be accorded this honor. He was Secretary of the Section during the 1940-1941 period.

The Buenos Aires Section of I.R.E. was founded in 1938 with thirty members. It has the distinction of being the only recognized section of the I.R.E. outside of the United States of America and of Canada. With a membership

today of approximately 100, it is one of the largest and most active sections. One of its important undertakings is the translation into Spanish, and publication in Argentina, of all I.R.E. standards.

The Buenos Aires Section was organized by Mr. A. M. Stevens, Technical Director of Compañia Internacional de Radio (Argentina), another I. T. & T. associate company. Mr. Stevens is a Fellow of the I.R.E. and served as the first Chairman of the Buenos Aires Section for the period of 1939-1940. Other chairmen have been Adolfo T. Cosentino, Director of Radio Communication of the Argentina Post Office and a Fellow of the I.R.E., Pierre J. Noizeux, Technical Director of Transradio Internacional., and Juan P. Arnaud, Professor at the University of La Plata.

# INTERNATIONAL TELEPHONE AND TELEGRAPH CORPORATION

## Associate Companies in the Western Hemisphere

### UNITED STATES OF AMERICA

INTERNATIONAL STANDARD ELECTRIC CORPORATION: *Manufacturer and Supplier of Communication and Other Electrical Equipment Through Licensee Companies Throughout the World; Exporter of Communication and Other Electrical Equipment*.....New York, N. Y.

FEDERAL TELEPHONE AND RADIO CORPORATION: *Manufacturer of Communication and Other Electrical Equipment*.....Newark, N. J.

COMMERCIAL CABLE COMPANY: *Trans-Atlantic Telegraph Service*.....New York, N. Y.

COMMERCIAL PACIFIC CABLE COMPANY: *Trans-Pacific Telegraph Service*.....New York, N. Y.

MACKAY RADIO AND TELEGRAPH COMPANY: *International and Ship-Shore Radio Telegraph Services; Supplies, Operates and Maintains Marine Communication and Navigational Equipment*..... New York, N. Y.

ALL AMERICA CABLES AND RADIO, INC.

*All America Cables and Radio, Inc. maintains 67 Company-owned telegraph offices in 23 countries and islands throughout Central and South America and the West Indies*.....New York, N. Y.

THE CUBAN ALL AMERICA CABLES, INC.: *United States-Cuba Telegraph Service*.....New York, N. Y.

### ARGENTINA

\*COMPAÑIA STANDARD ELECTRIC ARGENTINA: *Manufacturer of Communication and Other Electrical Equipment* ..... Buenos Aires

COMPAÑIA INTERNACIONAL DE RADIO (ARGENTINA): *Radio Telephone and Telegraph Services*. Buenos Aires

SOCIEDAD ANÓNIMA RADIO ARGENTINA: *Radio Telegraph Service* ..... Buenos Aires

COMPAÑIA TELEFÓNICA ARGENTINA: *Telephone Operating System*..... Buenos Aires

COMPAÑIA TELEGRAFICO-TELEFÓNICA COMERCIAL: *Telephone Operating System*..... Buenos Aires

UNITED RIVER PLATE TELEPHONE COMPANY, LIMITED: *Telephone Operating System*..... Buenos Aires

### BOLIVIA

COMPAÑIA INTERNACIONAL DE RADIO BOLIVIANA: *Radio Telephone and Telegraph Services*.....La Paz

### BRAZIL

\*STANDARD ELECTRIC, S. A.: *Manufacturer of Communication and Other Electrical Equipment*

Rio de Janeiro

COMPANHIA RADIO INTERNACIONAL DO BRASIL: *Radio Telephone and Telegraph Services*.....Rio de Janeiro

*Additional Stations: São Salvador (Bahia), Belem, Curitiba, Fortaleza, Natal, Porto Alegre, Recife.*

COMPANHIA TELEFONICA PARANAENSE, S. A.: *Telephone Operating System* ..... Curitiba

COMPANHIA TELEFONICA RIO GRANDENSE: *Telephone Operating System* ..... Porto Alegre

### CHILE

\*COMPAÑIA STANDARD ELECTRIC, S.A.C.: *Manufacturer of Communication and Other Electrical Equipment*

Santiago

COMPAÑIA DE TELÉFONOS DE CHILE: *Telephone Operating System* ..... Santiago

COMPAÑIA INTERNACIONAL DE RADIO, S. A. (CHILE): *Radio Telephone and Telegraph Services*..... Santiago

### CUBA

CUBAN TELEPHONE COMPANY: *Telephone Operating System* ..... Havana

RADIO CORPORATION OF CUBA: *Radio Telegraph Service* Havana

### MEXICO

MEXICAN TELEPHONE AND TELEGRAPH COMPANY: *Telephone Operating System*.....Mexico City

### PERU

COMPAÑIA PERUANA DE TELÉFONOS LIMITADA: *Telephone Operating System*.....Lima

### PUERTO RICO

PORTO RICO TELEPHONE COMPANY: *Telephone Operating System*.....San Juan

RADIO CORPORATION OF PORTO RICO: *Radio Telephone Service and Radio Broadcasting*.....San Juan

---

## Associate Companies in the British Empire

\*STANDARD TELEPHONES AND CABLES, LIMITED: *Manufacturer of Communication and Other Electrical Equipment* ..... London, England

*Branch Offices: Birmingham, Leeds, England; Glasgow, Scotland; Cairo, Egypt; Calcutta, India; Pretoria, South Africa.*

\*CREED AND COMPANY, LIMITED: *Manufacturer of Teleprinters and Other Communication Equipment*

Croydon, England

INTERNATIONAL MARINE RADIO COMPANY, LIMITED: *Supplies, Operates and Maintains Marine Communication and Navigational Equipment*.. Liverpool, England

\*KOLSTER-BRANDES LIMITED: *Manufacturer of Radio Equipment* ..... Sidcup, England

\*STANDARD TELEPHONES AND CABLES PTY. LIMITED: *Manufacturer of Communication and Other Electrical Equipment* ..... Sydney, Australia

*Branch Offices: Melbourne, Australia; Wellington, N. Z.*

\*Licensee Manufacturing and Sales Company of the International Standard Electric Corporation, New York, N. Y.