

FILE COPY

Not to be removed from  
the offices of Electrical  
Communication.

SALES DEPT.  
REGISTER FILE  
BOX NO. 144

# ELECTRICAL COMMUNICATION

OCTOBER

No. 2

1936

VOL. 15

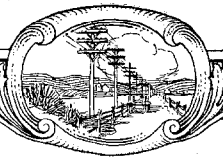

# ELECTRICAL COMMUNICATION

A Journal of Progress in the  
Telephone, Telegraph and Radio Art

H. T. KOHLHAAS, Editor

## EDITORIAL BOARD

E. A. Brofos   P. K. Condict   G. Deakin   E. M. Deloraine   P. E. Erikson   James E. Fullam  
J. J. Gilbert   F. Gill   Frank C. Page   H. M. Pease   Kenneth E. Stockton

Published Quarterly by the

*International Standard Electric Corporation*

Head Offices

67 BROAD STREET, NEW YORK, N. Y., U. S. [A.

European General Offices

CONNAUGHT HOUSE, ALDWYCH, LONDON, W. C. 2, ENGLAND

P. K. Condict, President

S. G. Ordway, Secretary

Joseph A. Redegeld, Treasurer

Subscription, \$3.00 per year; single copies 75 cents

---

Volume XV

OCTOBER, 1936

Number 2

---

## CONTENTS

	PAGE
A FIELD TRIAL OF 50 CYCLE SIGNALING ON TOLL LINES . . . . . <i>By William Hatton</i>	107
GENERALISED CHARACTERISTICS OF LINEAR NETWORKS . . . . . <i>By E. K. Sandeman</i>	115
THE COMMUNITY AERIAL SYSTEM OF BROADCAST DISTRIBUTION <i>By C. W. Earp and S. Hill</i>	129
AUTOMATIC METHOD OF FACTORY TESTING OF CIRCUIT UNITS .. <i>By E. P. G. Wright</i>	136
HOT CATHODE MERCURY VAPOUR HIGH TENSION SUPPLY EQUIP- MENT FOR BROADCASTING STATIONS . . . . . <i>By G. Rabuteau</i>	141
THE AUTOMATIC RADIO COMPASS AND ITS APPLICATIONS TO AERIAL NAVIGATION . . . . . <i>By H. Busignies</i>	157
RECENT TELECOMMUNICATION DEVELOPMENTS OF INTEREST . . . .	173

SALES DEPT.  
INDEX FILE  
1114





PLANT OF  
COMPAGNIE DES TÉLÉPHONES THOMSON-HOUSTON  
PARIS, FRANCE

# A Field Trial of 50 Cycle Signaling on Toll Lines

By WILLIAM HATTON,

*Chief Engineer, Switching Systems, Bell Telephone Manufacturing Company, Antwerp, Belgium*

## General

THE introduction of full automatic equipment for rural and suburban exchanges and the rapid progress of subscriber-to-subscriber dialing over toll lines during recent years has necessitated a departure from the familiar methods of direct current signaling in use on the shorter junctions between urban exchanges.

Signaling with direct current can only be applied economically to lines not exceeding a certain resistance, the maximum value being determined by the operating current of the signaling relays. This maximum is generally about 1,400 ohms. Further, direct current methods of signaling are unsuitable for lines which are phantom or equipped with repeaters.

It is interesting to note in passing that direct current signaling circuits are usually simple, the current remaining connected to line as long as required to maintain a given signal. This is not possible with alternating currents of frequencies within audible range without interfering with conversation. The signals are therefore transmitted as short impulses and each impulse indicates a change of condition. Speech currents must not cause the operation of the signaling system.

50 cycle alternating current has been in use for a number of years for signaling and dialing on toll lines, but the results obtained have not been entirely satisfactory and suffered from two major defects: firstly, the sending voltage required was too high, thereby causing interference with neighbouring circuits; and, secondly, the impulses were distorted.

A new type of 50 cycle signaling system has been developed by the Laboratories of the Bell Telephone Manufacturing Company, Antwerp. It operates with low sending voltage and current, thus preventing excessive distortion of the im-

pulses while retaining a circuit of simple form and low transmission loss.

Early this year, a complete demonstration of the rotary automatic toll system was made in Berne for the officials of the Swiss P. T. T. The demonstration equipment was later installed in the towns of Faido, Lugano, and Zurich in order to test the 50 cycle alternating current signaling under service conditions. The test was continued without interruption for two months.

Thanks are due to the officials of the Swiss P. T. T. for making it possible to conduct this field trial and for their generous cooperation throughout. The new type 50 cycle signaling system, described in this article, has been accepted as standard for Switzerland.

## The Field Trial

An 800 km. two-wire cable circuit was established between Faido and Zurich, as shown in Fig. 1. At Lugano and Zurich, equipment was installed to represent tandem toll switching points (see Tandem Units A and B—Fig. 1) with standard two-wire repeaters automatically connected and with regulation of the gain also automatic. Four additional repeaters were connected permanently in the line, thus making a total of six standard two-wire repeaters in circuit.

In addition to successfully demonstrating the numerous important facilities of the Rotary Automatic Toll System described in *Electrical Communication*, January, 1934, the field trial under most stringent conditions showed the impressive regularity with which the new 50 cycle system operated. The trial was made by sending commercial calls from Faido to Zurich, the toll operator at Faido dialing over the 800 km. circuit into the Zurich city and rural networks.

During the first ten days of the trial, 2,700 commercial calls were made with a total of thirteen faults, representing 0.48%. This per-

centage of faults is not greater than that found in the average local network. The trial circuit included:

- (a) An outgoing toll exchange: Faido,
- (b) A tandem toll exchange: Lugano,
- (c) A second tandem toll exchange: Zurich,
- (d) A terminating toll exchange: Zurich,
- (e) A local automatic exchange,
- (f) Six standard two-wire repeaters.

Fig. 2 shows one of the three demonstration units.

The concluding paragraph of the Official Report of the Swiss Administration, dated May 11, 1936, is of great interest and reads as follows:

The field trial has demonstrated that it is possible to establish connections with the Canton of Tessin, employing tandem toll switching and standard two-wire repeaters adjusted to give an overall loss of 1 neper. From all points of view, the trial represented an extreme case, the total

length of the circuit being approximately 800 km., composed of physical and phantom sections.

The transmission of impulses with the new receiving unit did not present the slightest difficulty. The correction of impulses (when necessary) could be made very easily and without the addition of numerous relays.

The model demonstrated that the automatic introduction of switched repeaters is possible, not only on paper but is practical, and that exploitation is possible without adding to the number of faults normally admitted for a telephone exchange.

Three different applications of the signaling system were demonstrated, as follows:

- (1) To a toll line terminating in the Zurich network,
- (2) To a toll line at a tandem point with switched repeater (Lugano and Zurich),
- (3) To a permanent repeater (loop circuits between Zurich and Niederurnen and at Faido).

The impulse receiving unit is the same in all three applications.

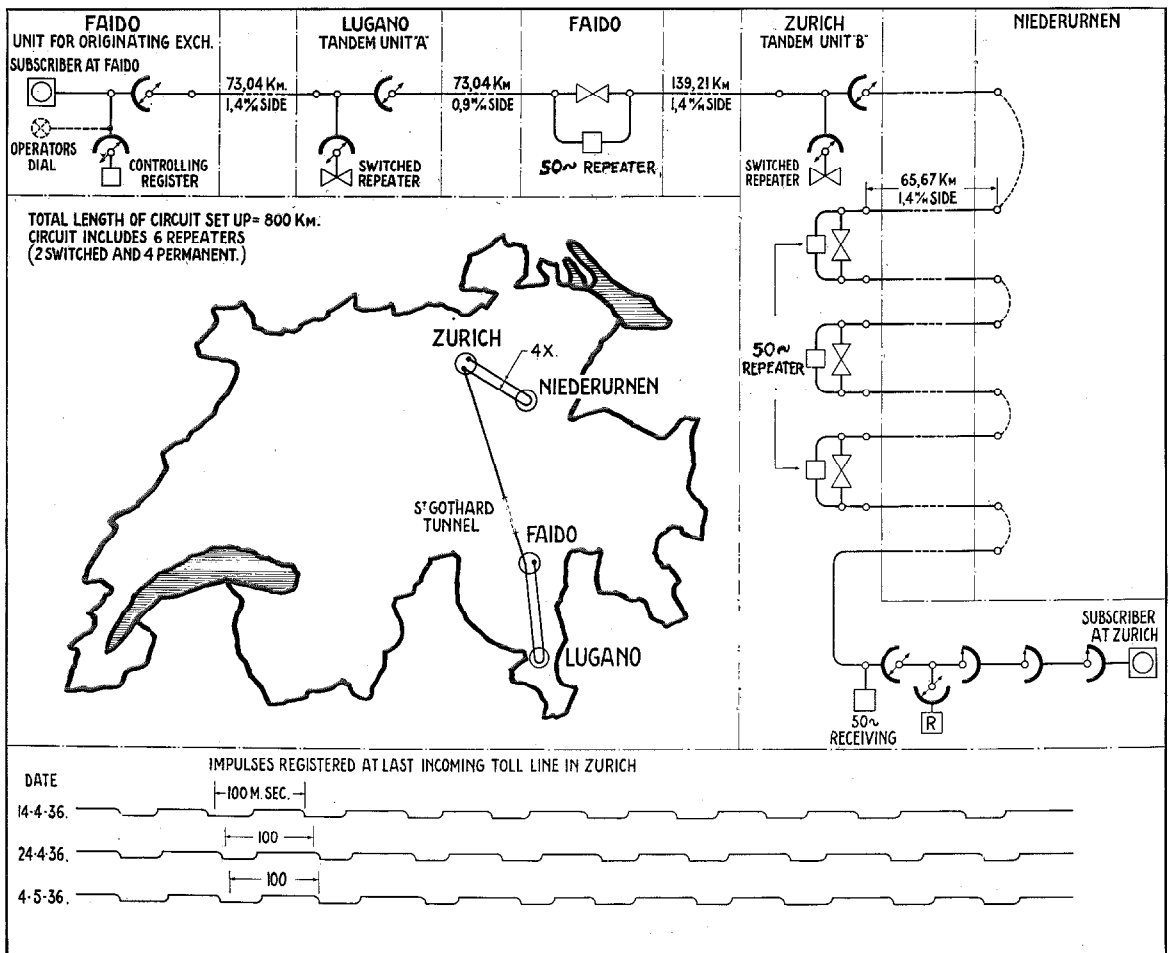

Fig. 1—Trial Circuit Set Up in Switzerland.

**Application to Terminating Line (See Fig. 3)**

- (1) A transformer  $T$  shown connected to the toll line over the back contact of relay  $Er$ .
- (2) A condenser  $C1$  connected in series with the primary winding of  $T$ .
- (3) A rectifier  $Rc$  connected to the secondary of  $T$ .
- (4) An impulse receiving relay  $Rr$  which is polarised. The left-hand winding of  $Rr$  is connected through test jack  $TJ$  to the rectifier  $Rc$ , and the right-hand winding at one end to battery in series with condenser  $C2$  and resistance  $R2$ . The other end of the winding is connected to the front contact of  $Rr$ .
- (5) An impulsing relay  $Mr$ , which really forms part of the local equipment. One end of the winding of  $Mr$  is connected to the front contact of  $Rr$  in parallel with resistance  $R3$ .

When a 50 cycle current impulse is received, it passes over the back contacts of relay  $Sr$ , the condenser  $C1$  and the primary winding of transformer  $T$ . A current is induced in the secondary of  $T$  which is rectified by  $Rc$  and operates  $Rr$  over its left-hand winding.  $Rr$  by its front contact operates  $Mr$  which causes the local automatic equipment to respond to the received impulse.

**Elimination of Chattering and Distortion**

Formerly, one of the most pronounced objections to the use of 50 cycle alternating current was the fact that the receiving relay had a tendency to follow the sinusoidal variations of the 50 cycle current, which caused chattering of the front contact and distortion of the impulse. This phenomenon was very marked in the early circuits employing alternating current relays and, moreover, since it occurred irregularly it was very difficult to correct by any form of impulse corrector.

It must be kept in mind that even the rectified current which flows through the left-hand winding of  $Rr$  has "upper" and "lower" peaks and, should the relay operate at an "upper" peak, there is a tendency to release again when the current drops to the "lower" peak.

To prevent such chattering, the impulsing relay  $Rr$  has been provided with a second winding

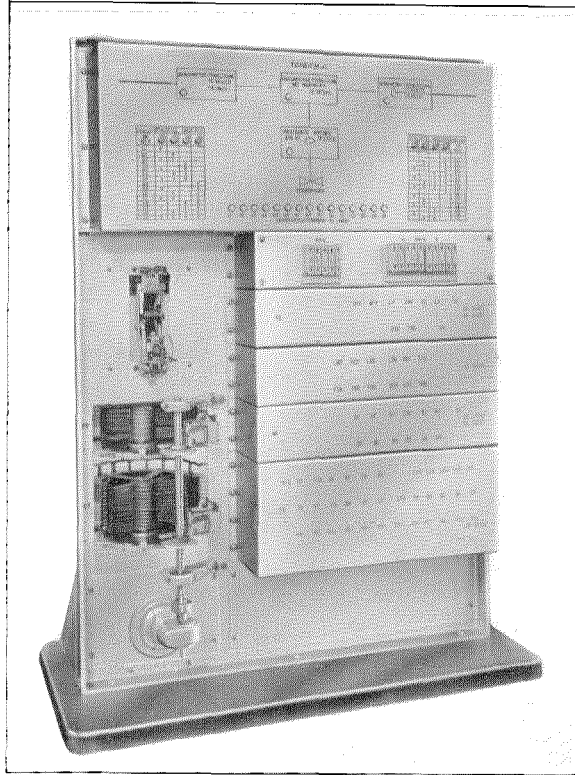

Fig. 2—One of Three Demonstration Models.

connected in series with condenser  $C2$  and resistance  $R2$  to battery. When  $Rr$  makes its front contact for the first time, condenser  $C2$  commences to charge and current flows through the second winding of the relay which helps the magnetic flux to develop and renders the front contact pressure less dependent on the variation of current in the left-hand winding.

When  $Rr$  opens its front contact,  $C2$  discharges and a reverse magnetic flux is built up, which assists the deenergisation. It is of interest to note here that in earlier circuits employing rectifiers and impulse relays with single windings, special precautions were required to eliminate the shunt effect of the rectifier and the tendency of the relay to be slow releasing, a most undesirable condition for good impulsing.

The discharge of  $C2$  not only helps the deenergisation of  $Rr$  but, should the interval between two successive impulses be very short, it delays the reoperation of  $Rr$ . In this manner, the impulses transmitted from the front contact of  $Rr$  to the local circuit relay  $Mr$  are corrected

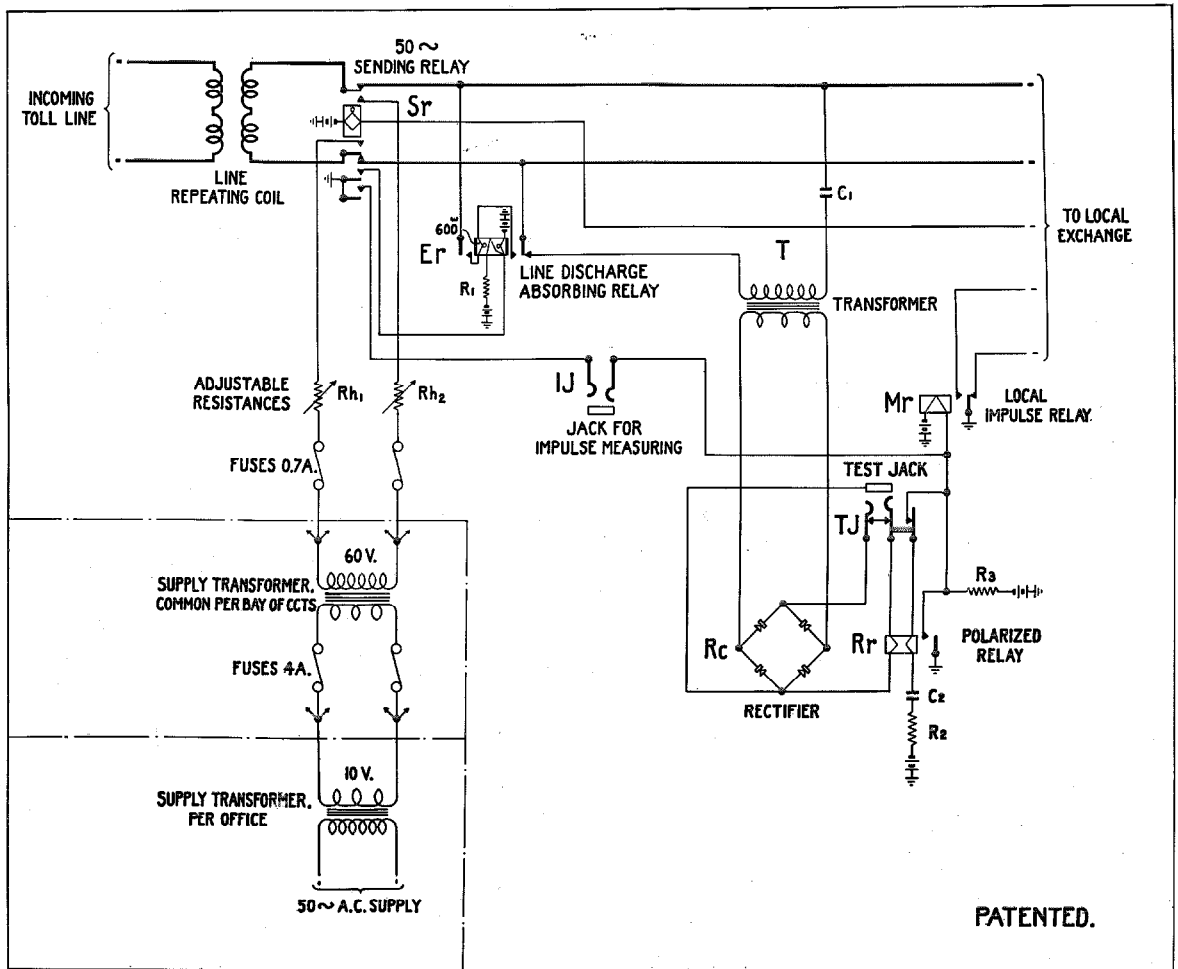

Fig. 3—Terminating Toll Line.

and the successive openings and closures properly spaced.

If it is found desirable to change the ratio of the impulse given by the front contact of  $Mr$ , it can be done by varying the shunt resistance  $R3$ .

The combination of polarised relay with two windings, condenser  $C2$  and resistance  $R2$ , is the most important contribution towards the elimination of irregularities so noticeable in other 50 cycle circuits. Oscillograms show that  $Rr$  transmits a steady and uniform impulse. Fig. 4 is taken from an oscillogram showing the front contact closure of  $Rr$ .

The chief characteristics of this new receiving unit can be summarised as follows:

(1) Elimination of chatter of front contact of impulsing relay due to the sinusoidal

variation of the 50 cycle alternating current;

- (2) Elimination of "kick" or rebound of armature of impulsing relay;
- (3) Correction of impulse for both closure and opening;
- (4) Means to vary impulse ratio to suit local conditions;
- (5) The use of a transformer permits the impedance of the receiving circuit to be as low as is necessary for good impulsing without increasing the transmission loss;
- (6) Robust and simple equipment, requiring little maintenance.

#### Operating Requirements

When connected, as shown in Fig. 3, the receiving unit will impulse correctly over a circuit

of 70 km. of 0.9 mm. (H-177) loaded cable with the voltage at the sending end adjusted to 32 volts and a current of 0.017 ampere. Under these conditions, the voltage measured across the terminals of the primary of  $T$  is 11 volts and the current in the left-hand winding of  $Rr$  is 0.014 ampere.

### Transmission Loss

An important feature of the circuit is the fact that the receiving unit, although bridged across the line, causes practically no transmission loss. The impedance presented to voice currents is of the order of 35,000 ohms.

This is due to the fact that it is possible to tune the receiving unit to 50 cycle current by means of the condenser  $C1$  and to the action of the rectifier  $Rc$ .

It is a well known characteristic of selenium rectifiers that the resistance is to a certain extent a function of the current. At speech currents of average level, the resistance of  $Rc$  is high and the secondary winding of the transformer  $T$  is practically open.

The high impedance presented to voice currents makes it unnecessary to modify the balancing network of the line. This is important when the receiving unit is used at tandem points where it may be necessary to connect a repeater.

### Interference

In practice it was found that, even with the low sending voltage of 32 volts, clicks were still audible on adjacent circuits. After a series of measurements in the field, the cause of this

interference was traced to longitudinal currents due to the unbalance in the leads supplying the 50 cycle current. It was found that the clicks could be practically eliminated by introducing an individual or semi-common transformer in the supply circuit. Using the individual transformer, field tests showed that the interference measured on adjacent circuits was negligible.

### Damping of Cable Discharge

The 50 cycle current is connected to line over the front contacts of relay  $Sr$  which, at the same time, disconnects the receiving unit. The voltage is adjusted to the correct value by means of the series resistances  $Rh1$  and  $Rh2$ . When  $Sr$  deenergises, the capacity discharge of the line is prevented from reaching the receiving unit by means of relay  $Er$ . When  $Sr$  operates, it completes a circuit for  $Er$  which disconnects the primary winding of transformer  $T$  from the line and connects in place a 600 ohm non-inductive resistance.  $Er$  is slow releasing and remains operated during the transmission of dial impulses, whereas  $Sr$  operates and releases once for each impulse.

Each time  $Sr$  deenergises, the line discharges through the 600 ohm non-inductive resistance connected over the front contacts of  $Er$ .

### Application to a Tandem Toll Line (See Fig. 5)

When connected across a toll line, arranged for tandem working, the receiving unit proper is exactly the same as that shown in Fig. 3. In this application the unit has a number of addi-

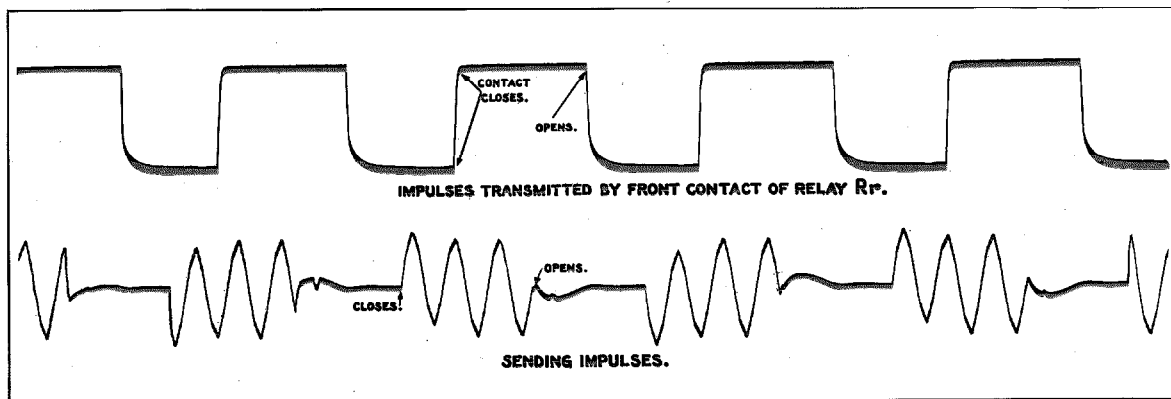

Fig. 4—Oscillogram of Front Contact of Relay  $Rr$ .



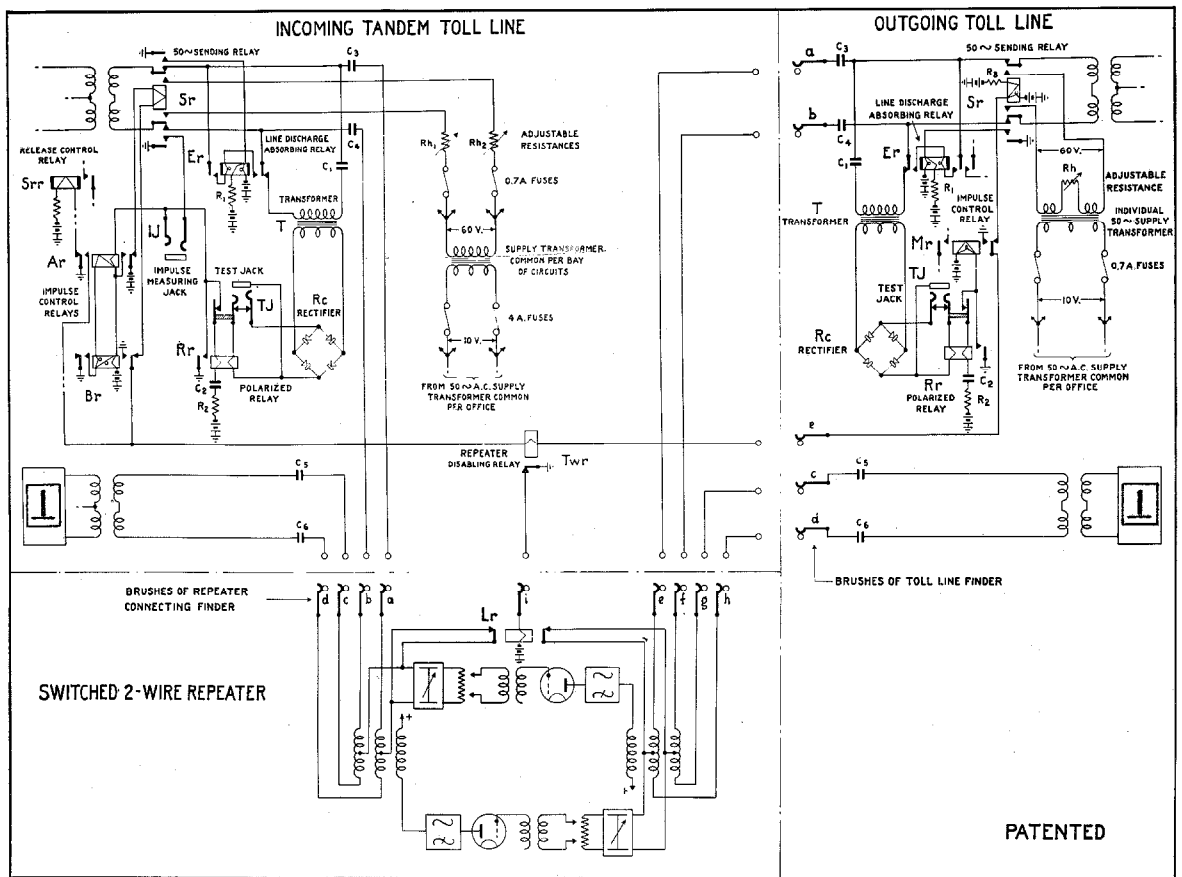

Fig. 5—Tandem Toll Line.

tional functions, among which are the control of a local selection in order to choose the required direction, the disabling of a switched repeater during impulsing, and the repetition of the impulses to the following toll line.

The circuit includes two additional relays, *Ar* and *Br*, which are operated from *Rr* and which carry the contacts necessary to perform the above-mentioned functions. These relays also help to maintain the impulse at a minimum length and prevent any distortion which may be present due to the influence of the additional relay *Twr*.

The left-hand side of the diagram shows the incoming end of a toll line arranged for tandem working, and the right-hand side a regular outgoing toll line. The lower portion of the diagram shows the elements of a standard two-wire repeater arranged for automatic switching and automatic gain control.

When a 50 cycle impulse arrives at the incoming line, relays *Rr*, *Ar*, and *Br* operate. *Br* completes a circuit for *Sr* which connects 50 cycle current to the outgoing toll line. *Twr* operates in series with *Sr* and closes a circuit for *Lr* in the switched repeater circuit, thereby disabling the repeater during the transmission of impulses. *Twr* also operates when an impulse is sent in the reverse direction, namely, from the outgoing line to the incoming line. In this case, *Rr* of the outgoing line operates *Mr* which, in turn, closes a circuit for *Sr* of the incoming line.

The complete equipment of an incoming toll line arranged for tandem working and switched repeater is shown in Fig. 7.

**Application to a Line Repeater (See Fig. 6)**

Fig. 6 shows the elements of a standard two-wire repeater and, in the centre of the diagram,

two 50 cycle units, associated with the east and west sides of the repeater.

In this application, the transformers  $T_1$  and  $T_2$  are connected across the centre points of the east and west hybrid coils, respectively. The rectifiers  $Rc_1$  and  $Rc_2$ , together with the polarised relays  $Rr_1$  and  $Rr_2$ , are connected in exactly the same manner as described for the previous applications. The function of the 50 cycle units,

in this case, is to relay the received impulse from one side of the repeater to the other; and it will be seen that  $Rr_1$ , associated with the west line, operates relay  $Sr_2$  which sends out 50 cycle alternating current to the east line. In the reverse direction,  $Rr_2$  operates  $Sr_1$  which sends out 50 cycle to the west line.

Tracing the circuit in detail, it will be seen that, when a 50 cycle current impulse arrives

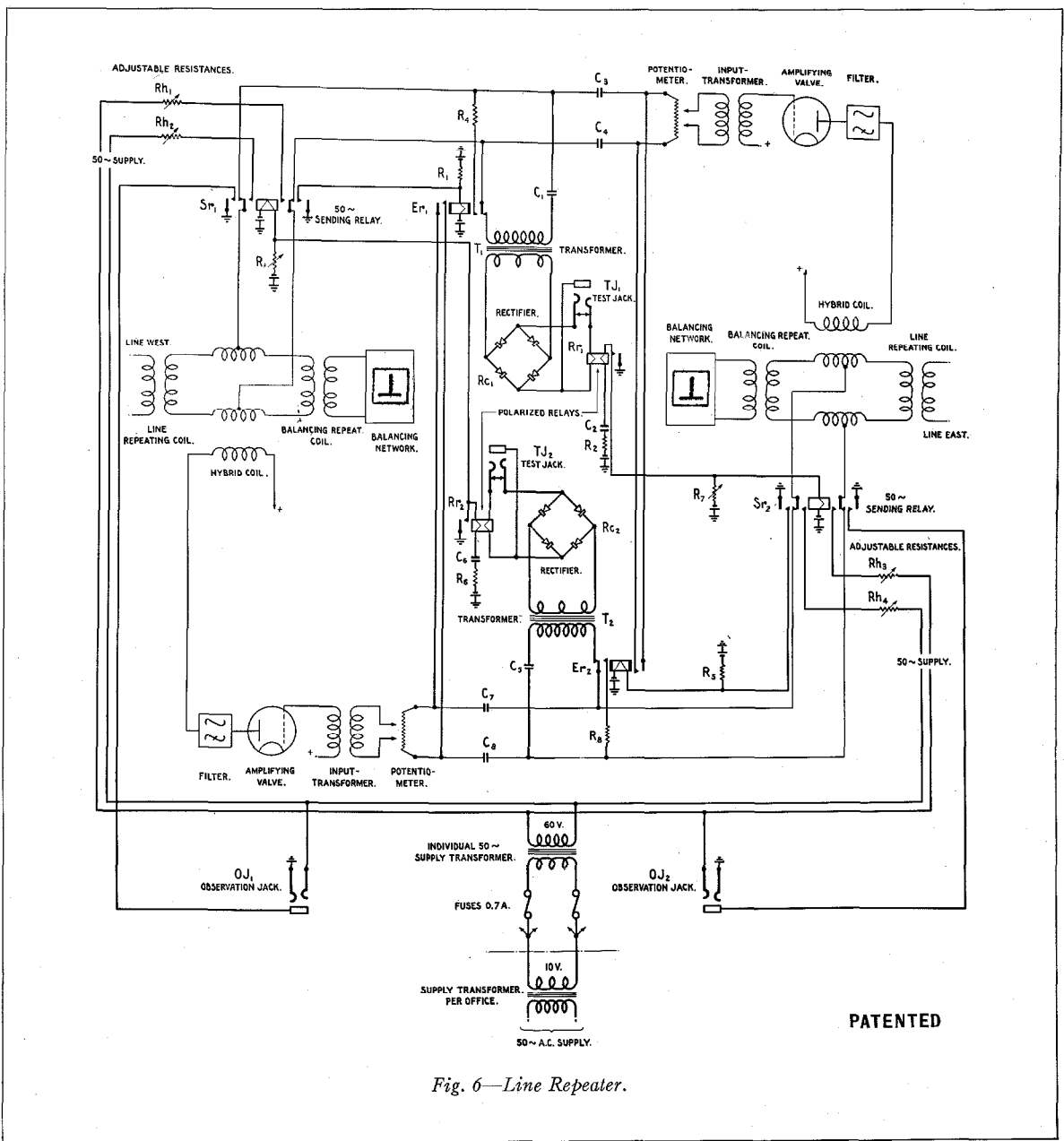
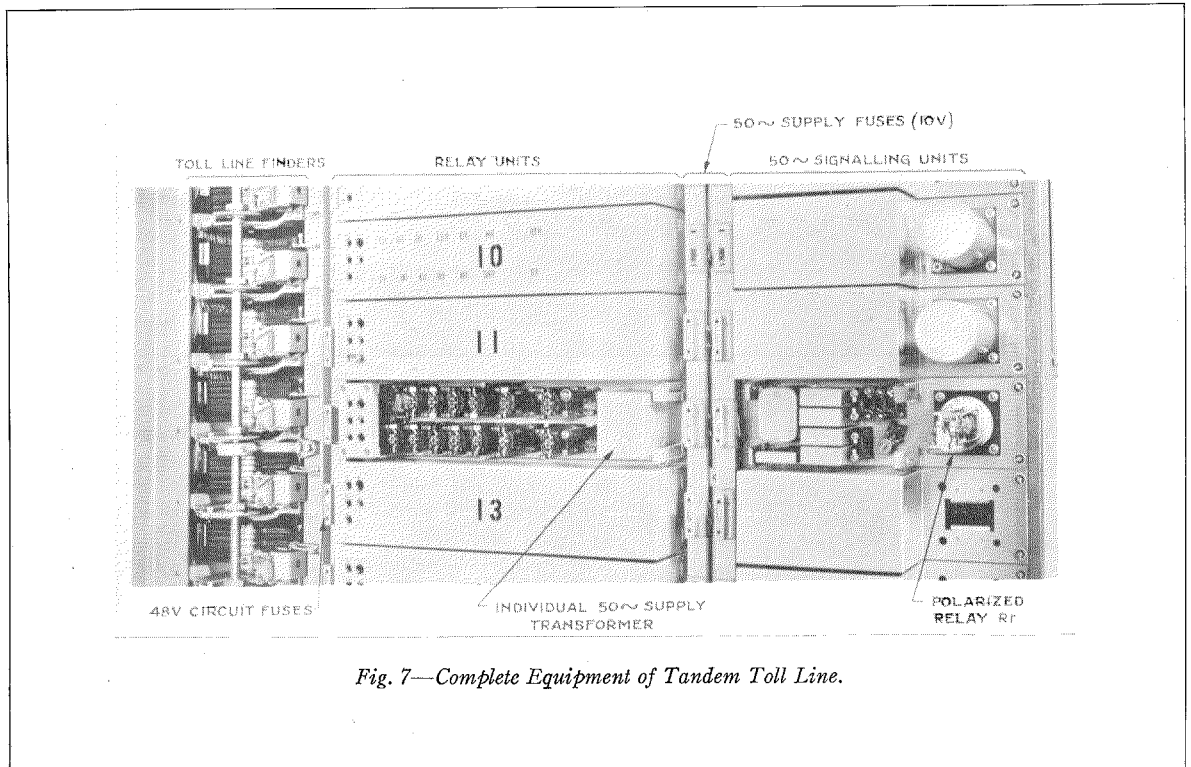

Fig. 6—Line Repeater.



*Fig. 7—Complete Equipment of Tandem Toll Line.*

from the west line, it passes over the back contacts of relay  $Sr1$ , the condenser  $C1$  and the primary of transformer  $T1$ . A current is induced in the secondary of the transformer, which is rectified by  $Rc1$  and passes through the left-hand winding of relay  $Rr1$ . From the front contact of  $Rr1$ , a circuit is closed for  $Sr2$  which operates and connects 50 cycle current to the east line.

A second circuit in parallel with the primary winding of transformer  $T1$  includes the two condensers  $C3$  and  $C4$  and the potentiometer of the repeater. The two condensers are chosen to render the impedance of this parallel circuit high to 50 cycle alternating current with the object of preventing the amplifying valve of the repeater from being influenced by the signaling current. Should this occur, it might be possible for the repeater to transmit to the east line 50 cycle current or harmonics which would not be

in phase with the current sent from the front contact of  $Sr2$  and which would, therefore, adversely influence the receiving unit at the next point along the line. To definitely prevent such interference, the potentiometer is short-circuited by a front contact of  $Er2$  which is operated from  $Sr2$ . Further,  $Er2$  is slow releasing and has the function of connecting a resistance to absorb the line discharges which occur when  $Sr2$  makes its back contact.

When connected in this manner to a standard two-wire repeater, it will be seen that part of the received current is absorbed by the balancing network and, to compensate for this, the sending voltage at the distant end must be raised.

When sending over 80 km. of 0.9 mm. (H-177) loaded cable, the sending voltage required is 49 volts and the current is 0.017 ampere.

# Generalised Characteristics of Linear Networks

By E. K. SANDEMAN

**L**INEAR electrical networks consisting of inductances, capacitances, and resistances are employed among other purposes to supply characteristics which vary with the frequency of the applied electrical oscillations.

When the characteristics of interest are impedance, attenuation, and phase shift, it is evident that by changing the absolute values of the elements of inductance, capacitance, and resistance, a given form of characteristic, expressed as a function of frequency, may be obtained within practical limits in any required range of absolute frequency. Further, a network designed, for instance, to afford a variation of attenuation with frequency, may be arranged to give the same attenuation curve as a function of frequency, when operating between any values of impedance lying within a practical range of impedances determined by the limitations of design of the component elements and of the associated circuits. Evidently the performance of any specific embodiment of such a network is specifiable uniquely by a specific curve of attenuation against frequency, this curve being valid only for given absolute values of terminating impedance. An infinite number of infinite series of curves are therefore required to specify the performance of the whole group of embodiments of a single form of attenuating network.

As will be seen by reference to any work on filter theory it is well known that, when the relations between the elements are fixed by means of a simple process of disembodiment, the performance of the whole group of networks of a given form can be determined by a single curve for each characteristic required.

Although the present purpose is mainly to present a series of such characteristics, the use of these characteristics will be made clearer by a preliminary discussion of their method of derivation for the benefit of those to whom the method is not familiar.

## Two-Terminal Networks

Such networks are usually employed to afford an impedance in which the resistive and reactive

components vary with frequency in some prescribed way.

Fig. 1 shows six two-element networks for which generalised characteristics have been derived. Consider the network type 1 of Fig. 1:

Its impedance at any angular frequency  $\omega$  is given by

$$Z = \frac{RLj\omega}{R + Lj\omega} = \frac{RLj\omega(R - Lj\omega)}{R^2 + L^2\omega^2};$$

$$\therefore Z = \frac{RL^2\omega^2}{R^2 + L^2\omega^2} + j \frac{R^2L\omega}{R^2 + L^2\omega^2}. \quad (1)$$

Define  $f_0$  as the frequency at which the reactance of  $L$  in ohms equals the numerical value of  $R$  in ohms and make  $\omega_0 = 2\pi f_0$ ; then

$$L\omega_0 = R \quad \text{and} \quad L = \frac{R}{\omega_0}. \quad (2)$$

Substituting (2) in (1),

$$Z = \frac{R \cdot R^2 \frac{\omega^2}{\omega_0^2}}{R^2 + R^2 \frac{\omega^2}{\omega_0^2}} + j \frac{R^2 R \frac{\omega}{\omega_0}}{R^2 + R^2 \frac{\omega^2}{\omega_0^2}}$$

$$= R \left[ \frac{\frac{\omega^2}{\omega_0^2}}{1 + \frac{\omega^2}{\omega_0^2}} + j \frac{\frac{\omega}{\omega_0}}{1 + \frac{\omega^2}{\omega_0^2}} \right], \quad (3)$$

$$= R[Y + jX], \text{ say.}$$

Evidently the quantity within the brackets is characteristic of the impedance of all possible networks of this type. If the real and the imaginary parts of the quantity inside the brackets are plotted as a function of  $\omega/\omega_0$ , the resultant curves afford a rapid means of determining the impedance characteristics of any specific embodiment of the network by assigning values to  $R$  and  $L$  and so to

$$\omega_0 = \frac{R}{L} \quad \text{and} \quad f_0 = \frac{R}{2\pi L}.$$

Fig. 2 shows a plot of the functions  $Y$  and  $X$  dependent on  $\omega/\omega_0$ .

$$Y = \frac{\frac{\omega^2}{\omega_0^2}}{1 + \frac{\omega^2}{\omega_0^2}} \quad \text{and} \quad X = \frac{\frac{\omega}{\omega_0}}{1 + \frac{\omega^2}{\omega_0^2}}.$$

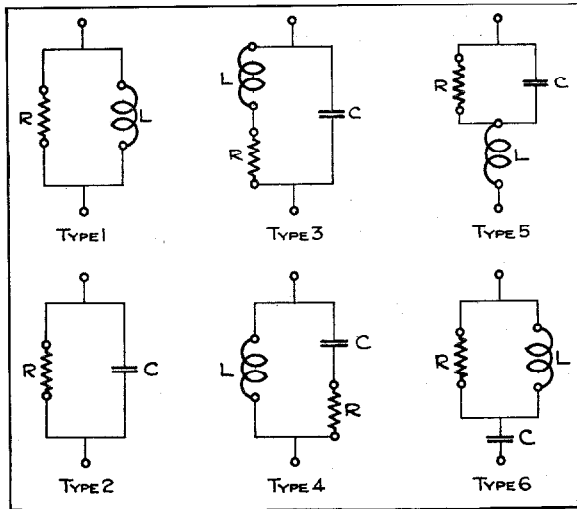

Fig. 1—Classification of Six Most Simple Networks Containing a Single Resistance.

It will be noted that

$$\frac{\omega}{\omega_0} = \frac{2\pi f}{2\pi f_0} = \frac{f}{f_0}$$

Example.

Determine from Fig. 2 the impedance characteristic of a network of type 1 in which  $L = 1$  Henry and  $R = 1000$  ohms.

$$f_0 = \frac{R}{2\pi L} = \frac{1000}{2\pi} = 159.$$

Hence, when  $f = 159$ ,  $\frac{f}{f_0} = \frac{\omega}{\omega_0} = 1$ ;

when  $f = 318$ ,  $\frac{f}{f_0} = \frac{\omega}{\omega_0} = 2$ ;

when  $f = 79.5$ ,  $\frac{f}{f_0} = \frac{\omega}{\omega_0} = 0.5$ , etc.

The absolute frequency scale can therefore be determined by writing 159 against  $\omega/\omega_0 = 1$  on Fig. 2, 318 against  $\omega/\omega_0 = 2$ , 79.5 against  $\omega/\omega_0 = 0.5$ , etc.

In practice, of course, this cumbersome method is never adopted. Plotting is carried out to a logarithmic frequency scale as in Fig. 2, so that it is only necessary to have a scale of absolute frequency plotted on the same kind of paper in a manner such that equal ratios on both scales (i.e., the scale of absolute frequency and the scale of  $\omega/\omega_0$  in Fig. 2) are represented by equal intervals. In this case, by sliding the two scales so that the frequency 159 comes opposite  $\omega/\omega_0 = 1$ , the

curves of Fig. 2 have direct application to the scale of absolute frequency.

The values of resistance and reactance are then given by 1000  $Y$  and 1000  $X$ . The values of reactance and resistance are shown for three values of  $f$  in the table below.

$f$	$Y$	Network Resistance Ohms	$X$	Network Reactance Ohms
79.5	0.2	200	0.4	400
159	0.5	500	0.5	500
318	0.8	800	0.4	400

In the case of networks containing more than two elements, it is necessary to introduce extra parameters determining the relations between the elements, the number of parameters being always one less than the number of elements in the network.

Fig. 1, type 3 shows a very common form of three-element two-terminal network.

Put

$$L\omega_0 = \frac{1}{C\omega_0} \tag{4}$$

and

$$\frac{L\omega_0}{R} = Q; \tag{5}$$

$$\begin{aligned} Z &= \frac{1}{Cj\omega + \frac{1}{R + Lj\omega}} = \frac{R + Lj\omega}{1 + Cj\omega(R + Lj\omega)} \\ &= \frac{R + Lj\omega}{1 - LC\omega^2 + RCj\omega} = \frac{(R + Lj\omega)(1 - LC\omega^2 - RCj\omega)}{(1 - LC\omega^2)^2 + R^2C^2\omega^2} \\ &= \frac{R}{(1 - LC\omega^2)^2 + R^2C^2\omega^2} \\ &\quad + j \frac{L\omega(1 - LC\omega^2) - R^2C\omega}{(1 - LC\omega^2)^2 + R^2C^2\omega^2} \tag{6} \end{aligned}$$

The process of generalisation of this expression may be carried out in a number of ways by insertion of the parameters  $\omega_0$  and  $Q$ . It is evidently possible to eliminate any two of the element values, and to obtain resulting expressions which, when multiplied by the value of the remaining element, give the resultant resistance and reactance components of the impedance. Since, however, the purpose of a network of this kind is usually to obtain a high impedance at the resonant frequency, it is convenient to think of the condenser as a means of multiplying the reactance of the inductance by a calculable factor. For this reason the impedance is determined

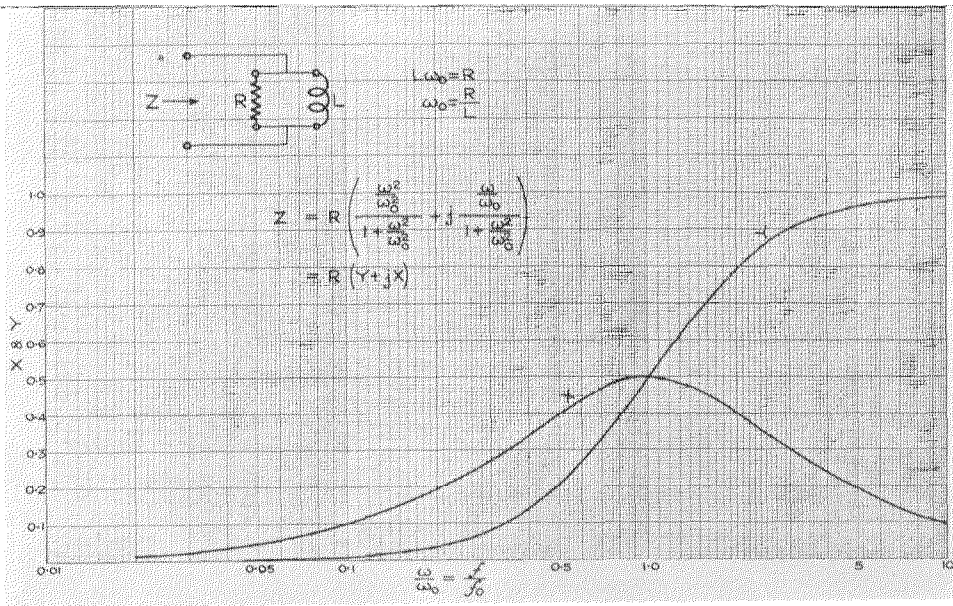

Fig. 2—Generalised Resistance and Reactance Curves for Network Shown.

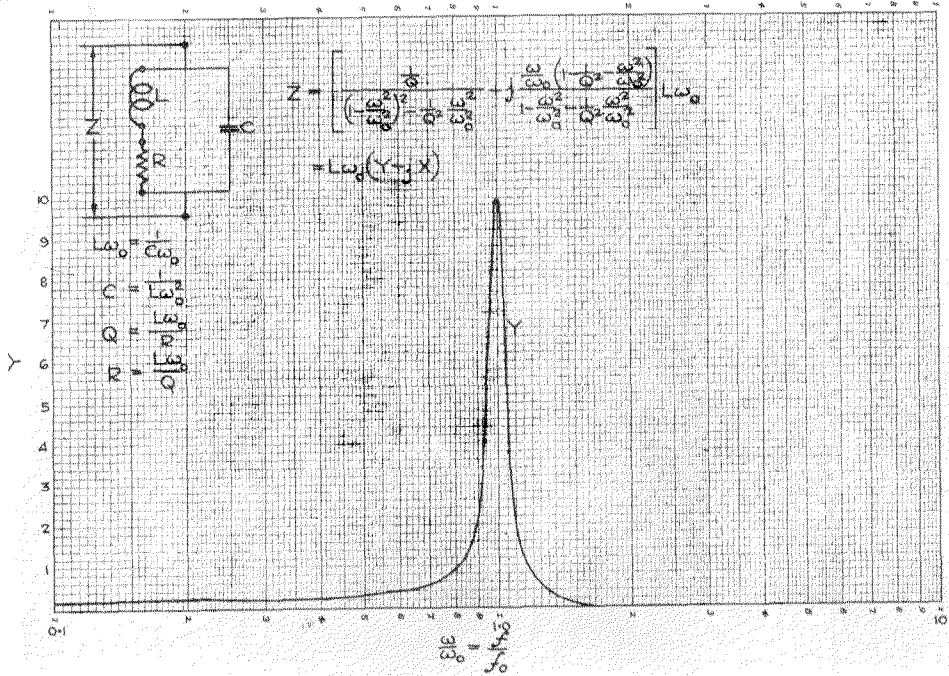

Fig. 3—Generalised Resistance Curve for Network Shown with  $Q=10$ .

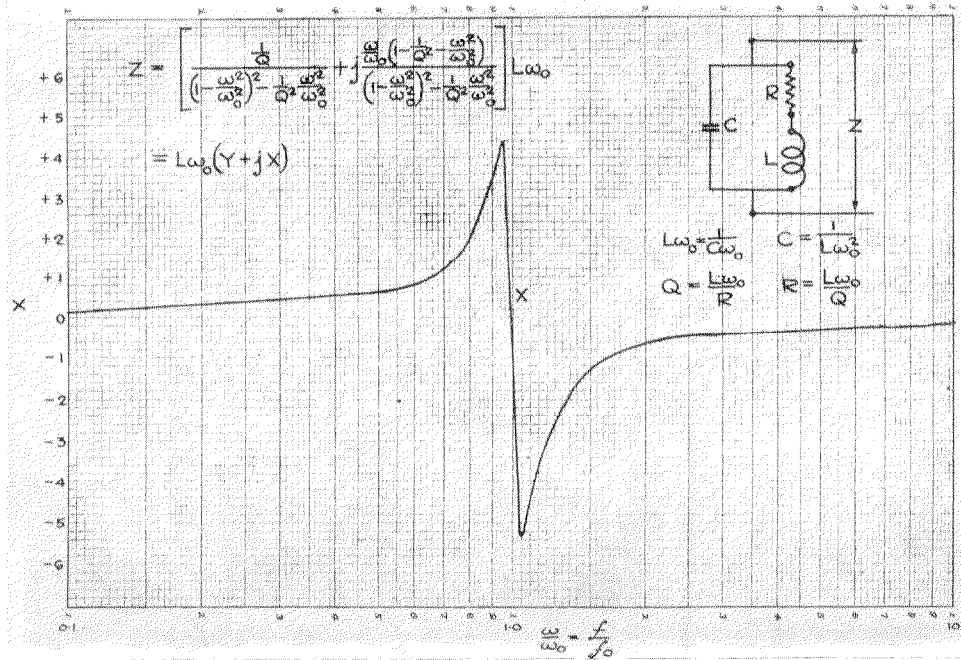

Fig. 4—Generalised Reactance Curve for Network Shown with  $Q=10$ .

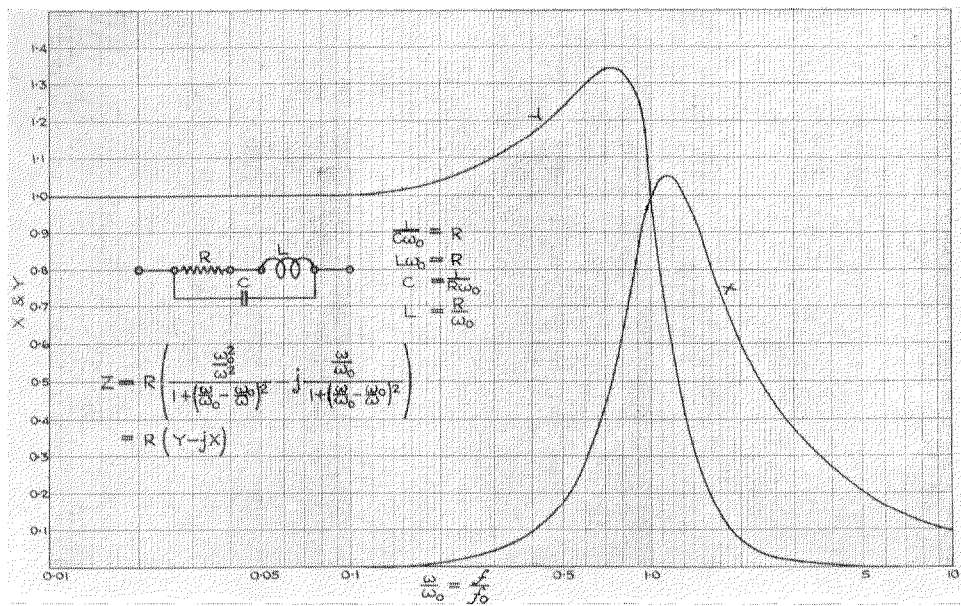

Fig. 5—Generalised Resistance and Reactance Curves for Network Shown.

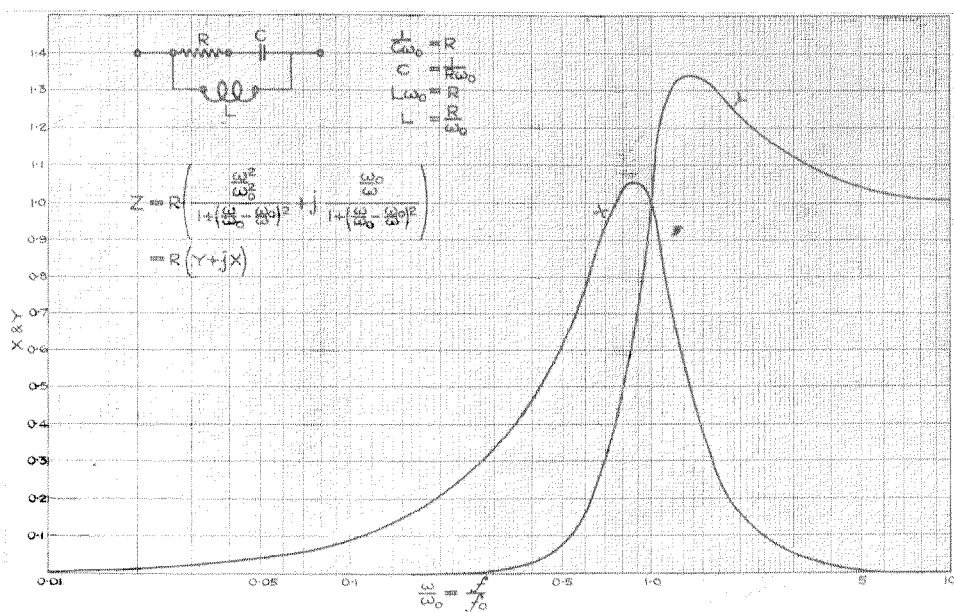

Fig. 6—Generalised Resistance and Reactance Curves for Network Shown.

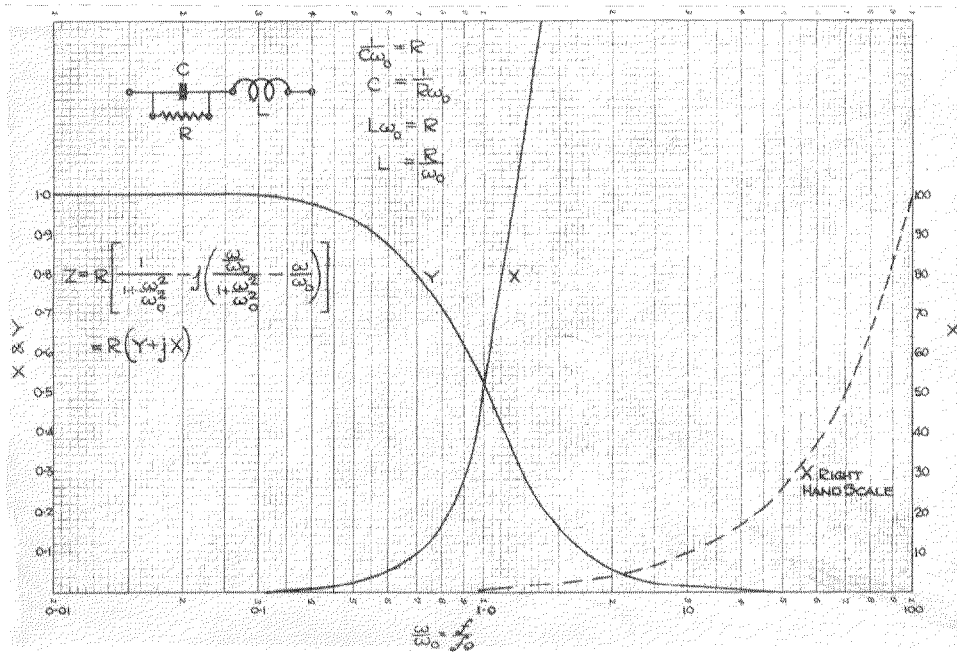

Fig. 7—Generalised Resistance and Reactance Curves for Network Shown.



as a function of  $L\omega_0$ , the reactance of  $L$  at resonance.

From (4) and (5) therefore are obtained

$$C = \frac{1}{L\omega_0^2} \quad (7)$$

and

$$R = \frac{L\omega_0}{Q} \quad (8)$$

Substituting (7) and (8) in (6),

$$\begin{aligned} Z &= \frac{\frac{L\omega_0}{Q}}{\left(1 - \frac{\omega^2}{\omega_0^2}\right)^2 + \frac{1}{Q^2} \frac{\omega^2}{\omega_0^2}} + j \frac{L\omega_0 \frac{\omega}{\omega_0} \left(1 - \frac{\omega^2}{\omega_0^2} - \frac{1}{Q^2}\right)}{\left(1 - \frac{\omega^2}{\omega_0^2}\right)^2 + \frac{1}{Q^2} \frac{\omega^2}{\omega_0^2}} \\ &= L\omega_0 \left[ \frac{\frac{1}{Q}}{\left(1 - \frac{\omega^2}{\omega_0^2}\right)^2 + \frac{1}{Q^2} \frac{\omega^2}{\omega_0^2}} + j \frac{\frac{\omega}{\omega_0} \left(1 - \frac{1}{Q^2} - \frac{\omega^2}{\omega_0^2}\right)}{\left(1 - \frac{\omega^2}{\omega_0^2}\right)^2 + \frac{1}{Q^2} \frac{\omega^2}{\omega_0^2}} \right] \quad (9) \end{aligned}$$

It may be noted in passing that when  $\omega/\omega_0 = 1$ , the real part of the impedance  $= QL\omega_0$  and the imaginary part  $= -L\omega_0$ .

Evidently equation (9) represents a family of curves, the particular curve chosen being determined by the value of  $Q$ . Fig. 3 shows the curve for the resistance term inside the bracket and Fig. 4 the curve for the reactance term when  $Q = 10$ .

To determine the absolute resistance and reactance curves, it is only necessary to fix  $L$  and  $C$  and so determine  $\omega_0$ , or to fix  $L$  and  $\omega_0$  and so determine  $C$ .

Fig. 5 shows generalised curves for a type 3 network derived in terms of  $R$  instead of  $L\omega_0$  for the case where  $Q = 1$ , i.e.,  $L\omega_0 = 1/C\omega_0 = R$ .

Fig. 6 shows curves for a type 4 network (which is similar to type 3 with the resistance transferred from the inductance arm to the capacitance arm) for the case where  $L\omega_0 = 1/C\omega_0 = R$ .

Comparing Figs. 5 and 6, it will be seen that one can be converted into the other by inverting one set of curves about the point  $\omega/\omega_0 = 1$ . This is equivalent to substituting  $\omega_0/\omega$  for  $\omega/\omega_0$  on the frequency ratio scale. It should be noted that in Fig. 5 the reactance is always negative, and in Fig. 6 the reactance is always positive.

The generalised characteristics of networks (5) and (6) are shown respectively in Figs. 7 and 8 and, as might be expected, are mutual inverses about the point  $\omega/\omega_0 = 1$ .

There exists still another useful method of approach to the type 3 network, and that is when the capacitance represents an unwanted shunt capacitance, such as the grid cathode capacitance of a valve. The resistance is an existing circuit element in parallel with this capacitance, such as the anode resistance of the previous valve, and the inductance is added to effect partial neutralisation of the capacitance. The net effect of adding the inductance is to increase the impedance effective across the condenser terminals over a limited range of frequency.

Assume a value of neutralising inductance  $L$  is chosen such that  $R = nL\omega_0 = n/C\omega_0$  where  $\omega_0 = 1/\sqrt{LC}$ :

From equation (6) the reactive component of the resulting impedance

$$X = \frac{L\omega(1 - LC\omega^2) - R^2C\omega}{(1 - LC\omega^2)^2 + R^2C^2\omega^2}$$

$$\text{Inserting } L = \frac{R}{n\omega_0} \text{ and } C = \frac{n}{R\omega_0},$$

$$\begin{aligned} X &= \frac{\frac{R}{n} \frac{\omega}{\omega_0} \left(1 - \frac{R}{n} \frac{n}{R} \frac{\omega^2}{\omega_0^2}\right) - R^2 \frac{n}{R} \frac{\omega}{\omega_0}}{\left(1 - \frac{\omega^2}{\omega_0^2}\right)^2 + R^2 \frac{n^2}{R^2 \omega_0^2} \omega^2} \\ &= R \left[ \frac{\frac{\omega_0}{\omega} \left(\frac{1}{n} - n\right) - \frac{1}{n} \frac{\omega}{\omega_0}}{\left(\frac{\omega_0 - \omega}{\omega_0}\right)^2 + n^2} \right] \quad (10) \end{aligned}$$

Evidently, if the quantity  $\frac{1}{n} - n$  is finite, the reactance assumes finite positive values at low frequencies. For certain purposes this may be regarded as undesirable and it is customary to make  $n = 1$ , in which case

$$X = R \left[ \frac{-\frac{\omega}{\omega_0}}{1 + \left(\frac{\omega - \omega_0}{\omega_0}\right)^2} \right] \quad (11)$$

and

$$L = \frac{R}{\omega_0} = R\sqrt{LC} = R^2C \quad (12)$$

The resistance and reactance characteristics of the resultant network are then given by Fig. 5.

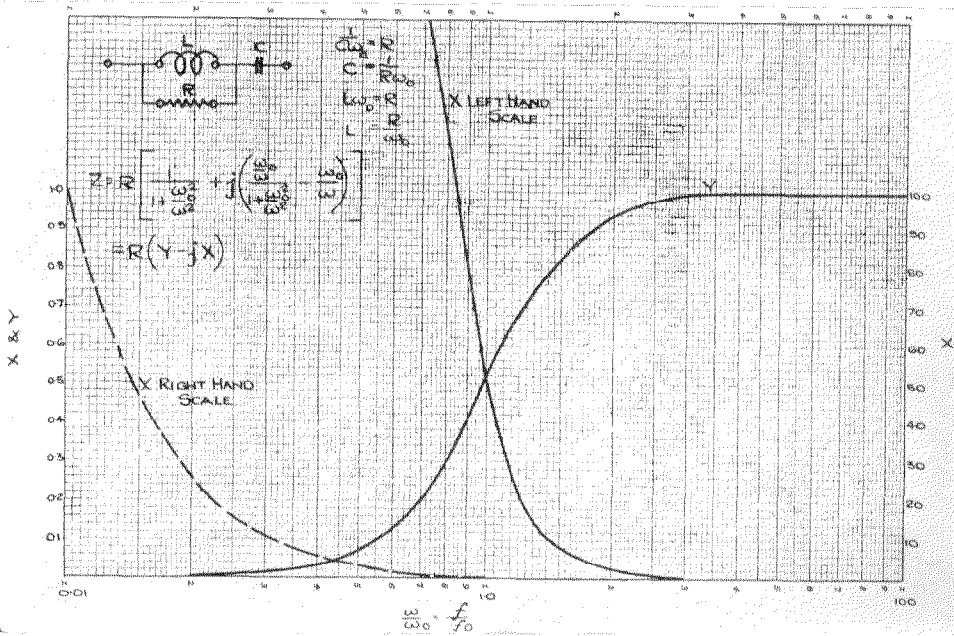

Fig. 8—Generalised Resistance and Reactance Curves for Network Shown.

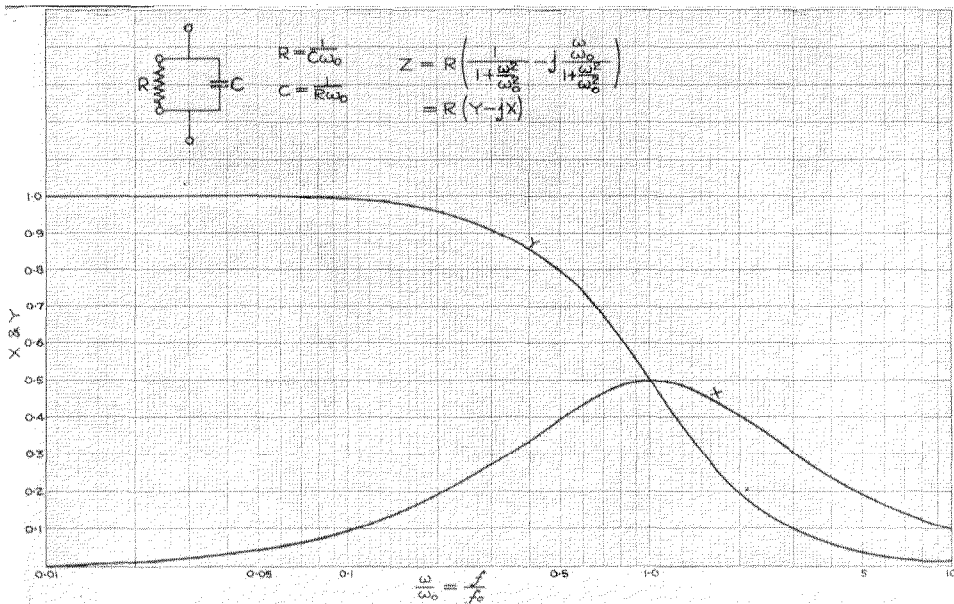

Fig. 9—Generalised Resistance and Reactance Curves for Network Shown.

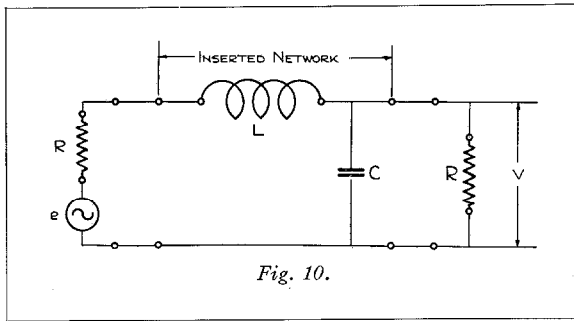

Fig. 10.

Fig. 9 shows the resistance and reactance characteristics of a type 2 network, representing the condition before the addition of the neutralising inductance. Some idea of the improvement realised by the addition of the neutralising inductance can be obtained by comparison of Figs. 5 and 9. For the purpose of comparison, these figures can be directly superposed with the  $\omega/\omega_0=1$  points and the zeros of the  $X$  and  $Y$  scale coinciding. It will then be seen that the value of  $Y+jX$  is appreciably larger over an interval of nearly two octaves when the inductance is added; the fall in impedance is delayed to a much higher frequency.

**Four-Terminal Networks**

The characteristics here considered are the usual transmission characteristics which determine the effect of the network in modifying electrical oscillations traversing it. Three characteristics will be defined.

(1) *The insertion loss proper* determines the change in the received energy and voltage consequent on the insertion of the network between two pieces of apparatus, a generator of alternating electromotive forces in a given range of frequency and a receiver. The generator and the receiver each have a definite impedance which, for many purposes, can be usefully considered to be a pure resistance, and often the impedances of generator and receiver are equal. When the generator is connected directly to the receiver, it delivers to the receiver energy and voltage of determined magnitude and phase. When the network is inserted, the received energy and voltage are changed in magnitude and phase. The amount of this change determines the insertion loss proper.

Evidently the insertion loss proper has two characteristics—a power ratio and a phase angle

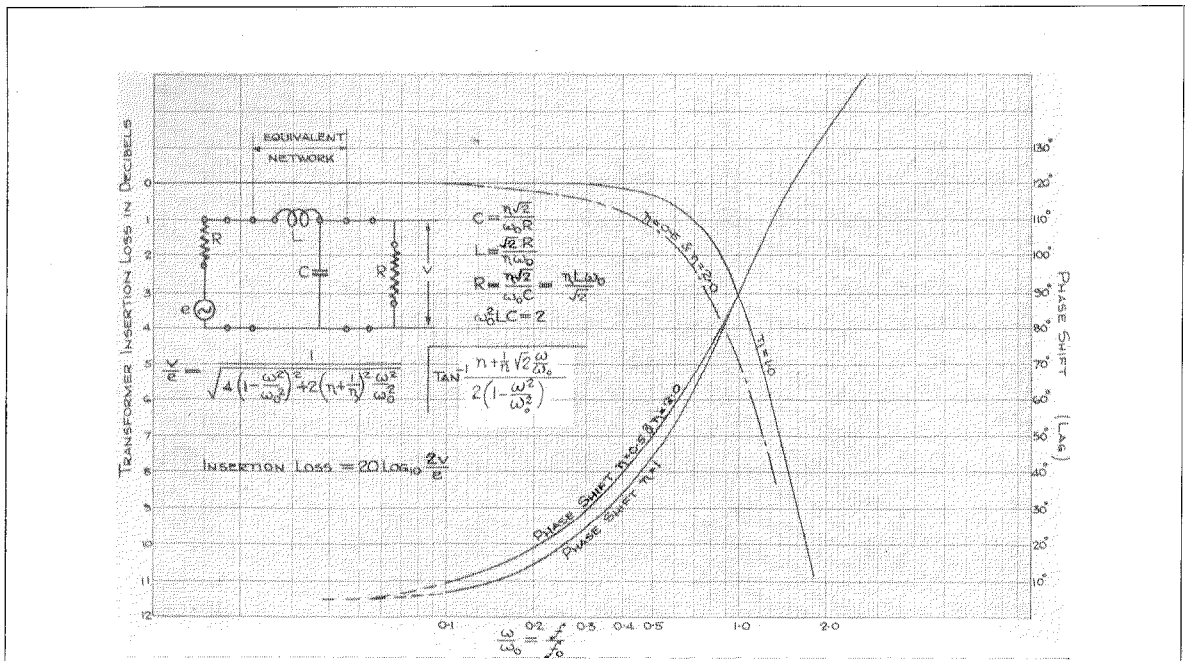

Fig. 11—High Frequency Insertion Loss and Phase Shift of Audio Frequency Transformers.

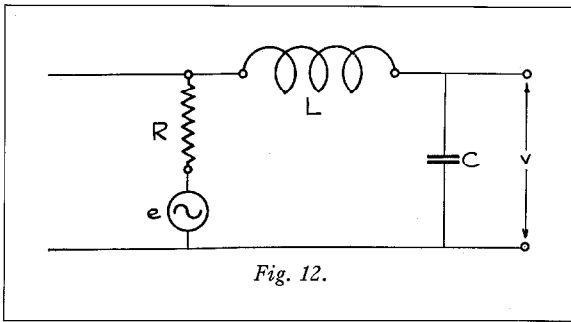

Fig. 12.

If the generator impedance = the receiver impedance = a pure resistance, and if  $V_1$  and  $V_2$  are the received voltages corresponding respectively to  $P_1$  and  $P_2$ , then

$$L = 20 \log_{10} \left| \frac{V_1}{V_2} \right| \text{ decibels.}$$

The vertical bars each side of the fraction  $\frac{V_1}{V_2}$  indicate that the magnitude of the voltage vectors is to be taken.

(2) The voltage transfer constant is the vector ratio between the vectors, respectively, describing the input voltage applied to the network and the voltage observed across the output terminal

of the network, defined by  $\frac{\text{output voltage}}{\text{input voltage}}$ . It is most conveniently determined by two curves plotted against frequency, one of the magnitude of the voltage transfer constant, and the other of the angle of the voltage transfer constant.

(3) The voltage transfer loss is probably a new term and is expressed as the number of decibels which correspond to  $A$ , the magnitude of the voltage transfer constant.

at each frequency. For simplicity, the term *insertion loss* will be used to refer to the power ratio and the term *insertion phase shift*, or simply phase shift, to refer to the angle.

The power ratio obviously may be expressed as the numerical ratio of  $P_1$ , the received power when the network is out of circuit, and  $P_2$ , the received power when the network is in circuit. More usually it is expressed in decibels or nepers. In the present case, decibels are used and the insertion loss is given by

$$L = 10 \log_{10} \frac{P_1}{P_2} \text{ decibels.}$$

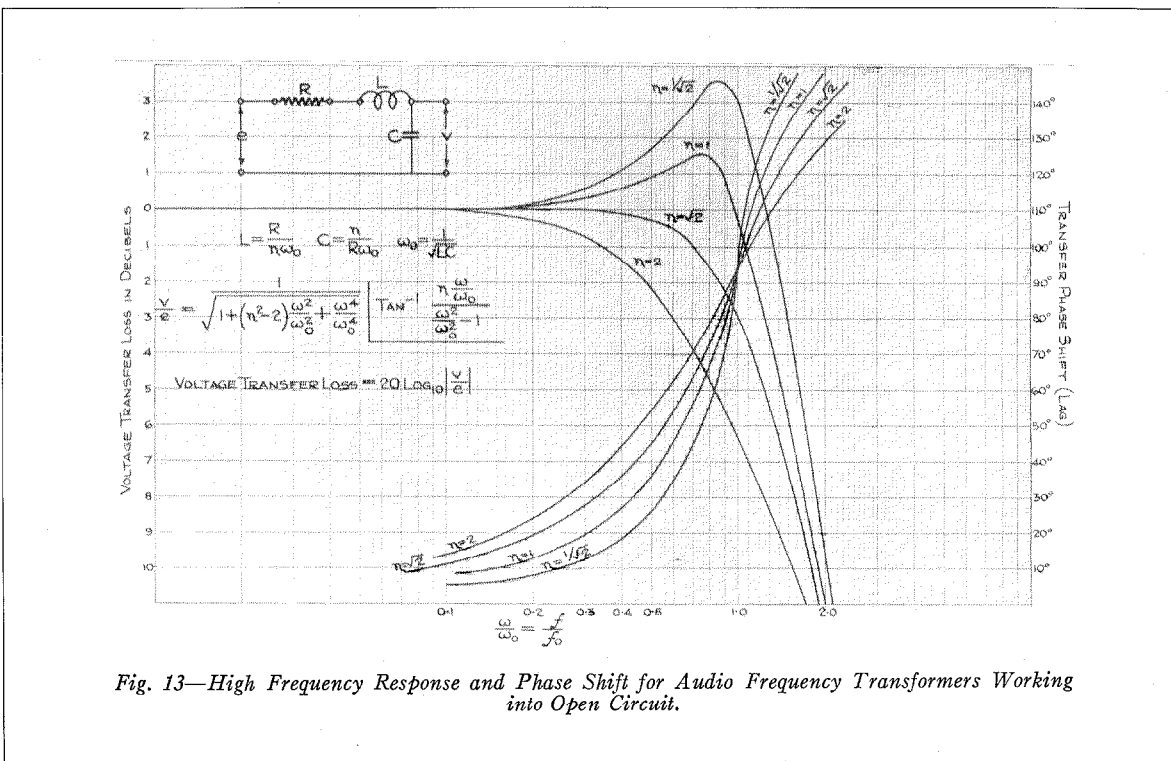

Fig. 13—High Frequency Response and Phase Shift for Audio Frequency Transformers Working into Open Circuit.

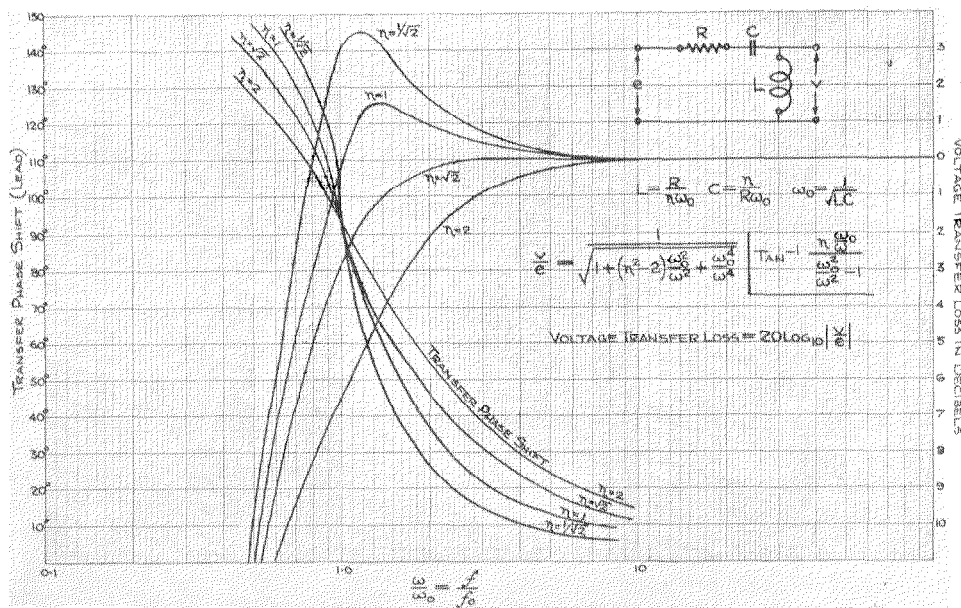

Fig. 14—Transfer Loss and Phase Shift for Network Shown.

The voltage transfer loss

$$L_T = 20 \log_{10} A.$$

The use of this term appears to be logical and is justified by its convenience. In this case the phase shift may be defined as the transfer phase shift, but no ambiguity results if the term phase shift is used alone.

It is difficult to lay down rigid rules which determine when each type of characteristic should be used to describe the performance of a network. When the network operates between finite impedances there is no choice: the insertion loss proper must be used, described by the insertion loss and the insertion phase shift as defined above. When the network can be regarded as operating between a generator of zero impedance and open circuit (infinite receiving impedance) the convention adopted is largely a matter of personal preference. Since the received power is zero, it is rather difficult to modify suitably the definition of the insertion loss to describe the

network characteristics under this condition, and the use of the voltage transfer constant or the voltage transfer loss is preferable. The voltage transfer constant is evidently used if voltage ratios are easier to handle; and the voltage transfer loss, if losses in decibels are required. This case arises in considering coupling circuits between valves when the anode impedance of the first valve and the grid-filament capacity of the second valve are treated as part of the network and the grid-filament conductance of the second valve is low enough to be considered zero.

*Example of Network Treated by Use of Insertion Loss*

Fig. 10 shows the equivalent circuit for the high frequency resonance of a communication transformer working between image impedances. The method of deriving this circuit has been described in *Electrical Communication*.<sup>1</sup> The

<sup>1</sup> "Transformers as Band Pass Filters," by E. K. Sandeman, *Electrical Communication*, April, 1929.

voltage

$$V = \frac{\frac{R}{1+j\omega CR}}{R+j\omega L + \frac{R}{1+j\omega CR}} e$$

$$= \frac{e}{\sqrt{(2-\omega^2 CL)^2 + \left(\omega CR + \frac{\omega L}{R}\right)^2}}$$

$$\left/ \text{Tan}^{-1} \frac{\omega CR^2 + \omega L}{\omega^2 RLC - 2R} \right. \quad (13)$$

Put  $\omega_0^2 = \frac{2}{LC}$  and  $\frac{\omega_0 CR}{\sqrt{2}} = \frac{\sqrt{2}R}{\omega_0 L} = n$ ;

then

$$C = \frac{n\sqrt{2}}{\omega_0 R} \quad \text{and} \quad L = \frac{R\sqrt{2}}{n\omega_0} \quad (14)$$

Substituting (14) in (13),

$$\frac{V}{e} = \frac{1}{\sqrt{4\left(1 - \frac{\omega^2}{\omega_0^2}\right)^2 + 2\left(n + \frac{1}{n}\right)^2 \frac{\omega^2}{\omega_0^2}}}$$

$$\left/ \text{Tan}^{-1} \frac{\left(n + \frac{1}{n}\right)\sqrt{2}\frac{\omega}{\omega_0}}{2\left(1 - \frac{\omega^2}{\omega_0^2}\right)} \right. \quad (15)$$

$$= A\sqrt{\phi}.$$

The negative value of the angle makes the sense indeterminate from the analysis, but it is evident that the angle always represents a lag.

Since, in the absence of the network,  $V = \frac{1}{2}e$ , the insertion loss proper is expressed by the ratio  $2A\sqrt{\phi}$  and the insertion loss is expressed in decibels by

$$L = 20 \log_{10} 2A.$$

The insertion loss and the insertion phase shift of the network of Fig. 10 are shown in Fig. 11 for  $n=0.5, 1.0$ , and  $2$ . It is evident that an ideal design of transformer results if  $n$  is made equal to unity.

#### Example of Network Treated by Use of a Voltage Transfer Loss

Fig. 12 shows the equivalent circuit for the high frequency resonance of a communication transformer working into open circuit. The

method of deriving this circuit will be clear by reference to the above mentioned article.

The voltage transfer constant

$$\frac{V}{e} = \frac{1}{\sqrt{1 + (n^2 - 2)\frac{\omega^2}{\omega_0^2} + \frac{\omega^4}{\omega_0^4}}} \left/ \text{Tan}^{-1} \frac{n\frac{\omega}{\omega_0}}{1 - \frac{\omega^2}{\omega_0^2}} \right.$$

$$= A\sqrt{\phi},$$

where

$$n = RC\omega_0 = \frac{R}{L\omega_0},$$

$$\omega_0 = \frac{1}{\sqrt{LC}}, \quad C = \frac{n}{\omega_0 R} \quad \text{and} \quad L = \frac{R}{n\omega_0}.$$

The voltage transfer loss is given by  $L_T$

$$= 20 \log_{10} \left| \frac{V}{e} \right| = 20 \log_{10} A.$$

The voltage transfer loss and the phase shift of the network of Fig. 12 are shown in Fig. 13 for values of  $n = \frac{1}{\sqrt{2}}, 1, \sqrt{2}$ , and  $2$ .

Figs. 14-18 show the characteristics of five other networks, in forms appropriate to the work to which they were originally applicable. They also show the method of deriving the parameters and the generalised formulae for the insertion loss, voltage transfer constant, voltage transfer loss, whichever is relevant, and for the phase shift. For purposes of practical application each figure is complete in itself, containing all the necessary data to enable the absolute frequency scale for any particular embodiment to be aligned with the generalised scale of  $\frac{\omega}{\omega_0} = \frac{f}{f_0}$ . There are, however, a few points which appear worthy of comment.

An important point to notice is the principle of inversion by which the characteristics of one network can be derived from another by inversion about the axis  $\frac{\omega}{\omega_0} = 1$ . The formula for the second network is derived by substituting  $\frac{\omega_0}{\omega}$  for  $\frac{\omega}{\omega_0}$  in the formula for the first network, and by changing the sign of the reactance or phase shift.

The necessary and sufficient conditions which make such an inversion possible are: firstly, that the second network is derived from the first by changing every inductance into a capacity and

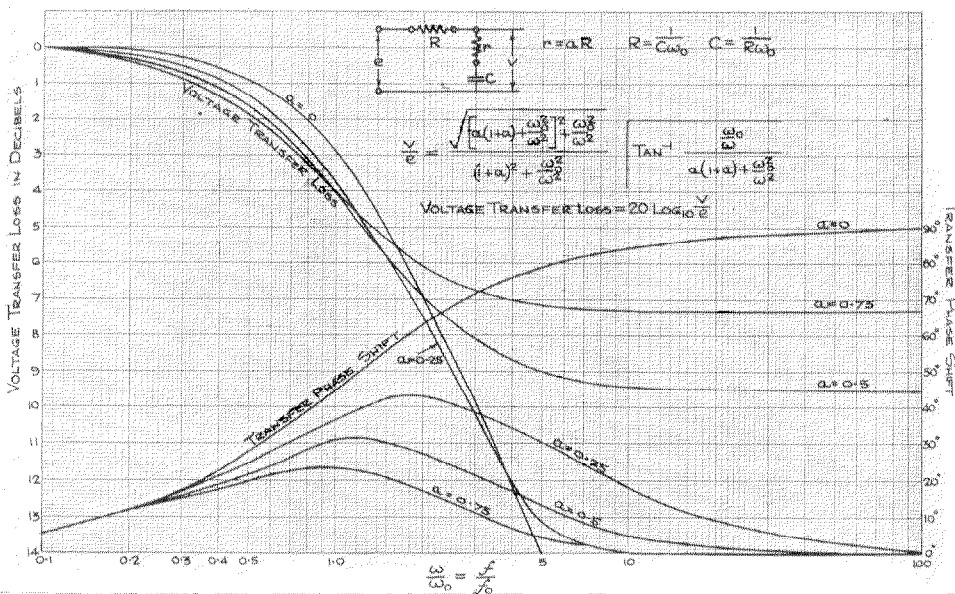

Fig. 15—Transfer Loss and Phase Shift for Network Shown.

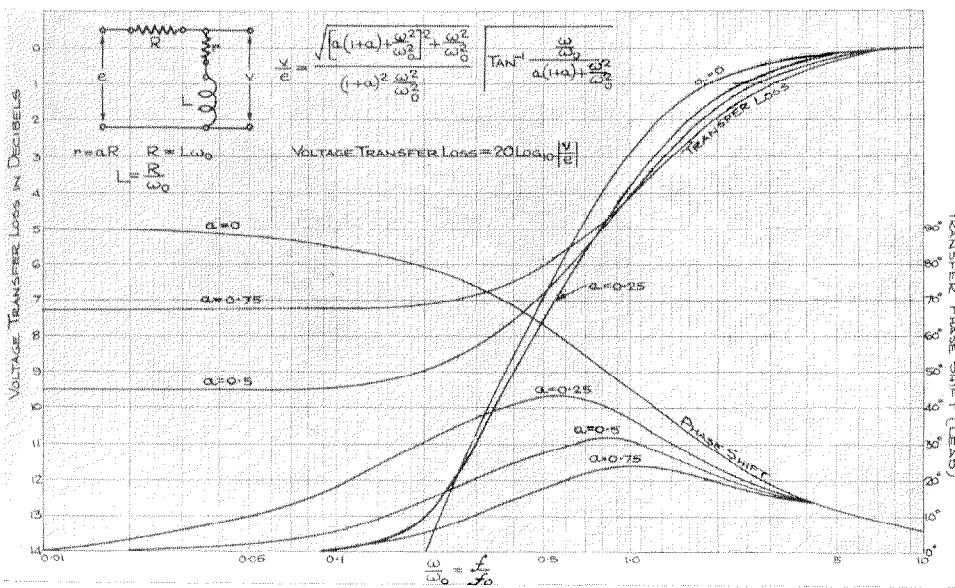

Fig. 16—Transfer Loss and Phase Shift for Network Shown.

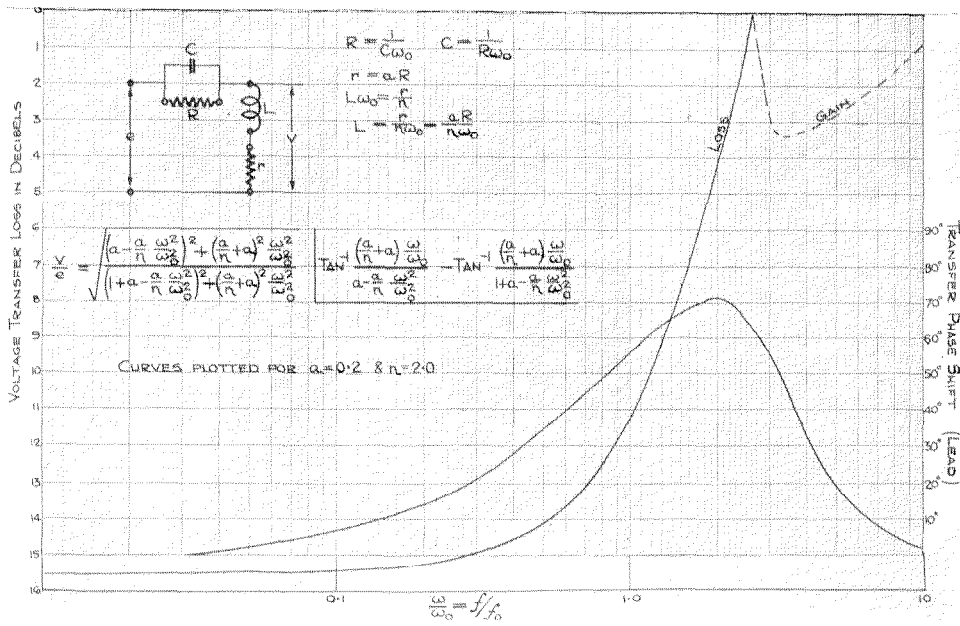

Fig. 17—Transfer Loss and Phase Shift for Network Shown.

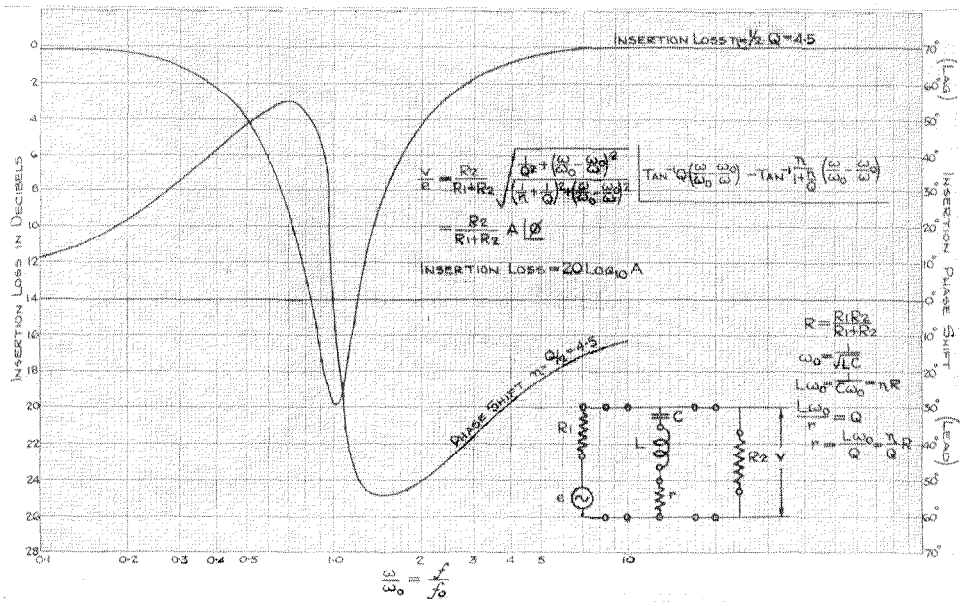

Fig. 18—High Frequency Insertion Loss and Phase Shift for Audio Frequency Transformers.



vice versa; secondly, that the controlling parameters relating  $\omega_0$  and the various elements of the network shall be the same. If, for instance, a controlling parameter in the first network is given by  $L\omega_0 = aR$ , the corresponding parameter in the second network is given by  $\frac{1}{C\omega_0} = a'R$ , where  $C$  replaces  $L$ , and  $a'$  must equal  $a$  for the condition of inversion to hold. As the labour of deriving the formulae and evaluating them is very considerable in the more complicated cases, the value of this principle will be easily appreciated. Examples of such inversion are: Figs. 5 and 6; Figs. 2 and 9; Figs. 13 and 14; and Figs. 15 and 16. In each instance calculation was made for one case only and the formula and characteristics for the inverted network derived by applying the principle of inversion. Care must be observed in applying this principle to see that appropriate changes are made in the signs of the reactance and phase shifts.

It will be noted that in certain cases, in order to save space, positive and negative reactances have been plotted in the same direction and distinguished by  $+$  and  $-$  signs. For the same reason, in Fig. 17, the part of the response curve

representing a gain has been inverted about the axis of zero loss.

In certain cases, for instance, where valves can be used as separating elements, it is possible to combine the curves of several networks by adding or subtracting ordinates directly. Thus, the preliminary investigation can be made entirely in terms of the generalised curves, sliding them over one another until a composite curve of the required form is obtained. The values of the circuit elements of the component networks follow as soon as the position of the composite curve (and therefore of the component curves) in the frequency gamut is fixed. It is found in practice that the possession of a series of generalised curves such as the above enables studies, which would otherwise be quite impracticable, to be made comparatively without effort.

The collection of curves given is necessarily limited since the time involved in constructing them is appreciable. The author hopes to publish a more extensive list at some future date and would be grateful to hear from colleges or private individuals who would be interested in collaborating.

# The Community Aerial System of Broadcast Distribution

By C. W. EARP AND S. HILL

*Kolster-Brandes, Limited, Sidcup, England*

## **The Problem**

**R**ADIO reception in a modern flat-colony presents two special problems: (1) providing the users with efficient non-interfering aerials which must, of course, not be unsightly; and (2) reducing the static interference which is always considerable because of the many electrical services provided.

The solution of these problems demands a co-operative effort which the tenants naturally tend to relegate to the proprietors of their establishment. For this reason, radio is coming to be regarded as a fundamental service, which a tenant expects along with water, electricity, or the telephone, and there is a rising demand among builders and architects for a complete system whereby a flexible, noise-free radio service may be "laid on" to each apartment. The Community Aerial System was developed for such a service.

In studying the community aerial system, we may conveniently divide it into two parts: the provision of an efficient aerial system, generally on the roof of the building, with a radio frequency transmission line to bring signals to the main distributing point; and a system of aperiodic amplification and distribution to convey the signals to the consumer.

The division is historically convenient since the first part of the problem was solved first by means of the "Rejectostat System," while the second part is a more modern development. Inasmuch as the rejectostat system is already widely known, the main purpose of this article is to expound the second part of the problem.

## **The Rejectostat System**

In this system, which has application to individual as well as to community installations, an aerial is erected outside the noise cloud, which is generally associated with the building itself—partly because the interfering sources are usually indoors, and partly because house wiring radiates a disturbing field. A low impedance shielded transmission line with suitable impedance changing transformers at each end, carries the signals

to the receiver which is, itself, preferably shielded with special care. Such installations have been highly successful in reducing local noise and have certain obvious auxiliary advantages; for example, since the aerial may be remote, it can generally be made better than one whose position is fixed near to a particular set, and the resulting improvement usually more than compensates for transmission losses. Better protection against lightning discharges can also be achieved and the choice of location of the receiver is wider.

## **The Amplifier**

One good aerial, well removed from the local noise cloud, can nearly always be erected on the roof of a block of flats, and collects enough energy to supply several radio receivers. To supply energy to all the residents, however, it is necessary to amplify the signal currents from the aerial aperiodically, and deliver them to a low impedance line.

Figs. 1-A and 1-B show a ten-valve amplifier manufactured by Kolster-Brandes, Ltd., suitable for supplying about one hundred receivers. The schematic is shown in Fig. 2. There are two Brimar R.3 rectifiers (two are provided for greater reliability) and ten Brimar 9D2 pentodes forming a single stage. A filter is included to suppress audio frequencies and very long wave telegraph signals which, because of the impracticability of maintaining the sheath at earth potential throughout its length, are often picked up on the aerial transmission line and may modulate the wanted signals at telegraph frequencies. Wave traps are also sometimes included to reduce the signals from powerful local stations.

## **Principle of Operation**

The chief technical problem of securing efficient vacuum tube amplification of a wide band of frequencies from a low impedance source is the design of a good step-up transformer from the line to the high grid impedance of the valves, and a similar step-down transformer from anode to line impedance.

The high input step-up is necessary not only for efficiency but also to minimise the effect of valve anode noise. It is shown in the Appendix that valves of normal design must work from impedances of not less than 100,000 ohms. It was found impracticable to design sufficiently good transformers to cover the whole range, and the arrangement of Fig. 3 was accordingly adopted. As the technique of transformer design is improving, it is possible that other methods of amplification will become practicable, and are indeed now being explored. However, it will be seen that the method here described has several special advantages for community aerial work.

The line impedance of 100 ohms is matched at frequencies  $f_1, f_2, f_3$ , etc., by series tuned circuits of 100 ohms impedance composed of  $L_1C_1, L_2C_2, L_3C_3$ , respectively. Frequencies  $f_1, f_2 \dots f_n$  are chosen at regular intervals, which are just small enough to ensure good absorption of energy from the line at all frequencies within the band it is desired to pass. It will be seen that the circuit  $L_nC_n$  will absorb practically no energy from the line except at the desired frequency, for its impedance rises rapidly on either side of resonance.

The various outputs  $OP_1, OP_2$ , etc., now have very high impedances at resonance, of the order of 500,000 ohms, being closed by a parallel tuned circuit  $L_1C_1, L_2C_2$ , etc.

Instead of the orthodox transformer, we have therefore a single low-impedance input on one side, and a number of pairs of output terminals. Signal energy entering at the "primary" terminals is selected in a number of frequency bands and stepped up in voltage and impedance to various output terminals. These outputs  $OP_1, OP_2$ , etc., are ideally suitable for the connection of valve grids.

A similar device is used for the transformation of signal energy from numerous high-impedance sources (the anodes of the amplifiers) to a 100 ohm output line. In this case, of course, the valve anode impedances are strapped across the various circuits, and modified circuit constants are necessary for exact matching.

In practice it is found desirable to "stagger" grid and plate resonances so that variation of gain over the band may be minimised. The resultant characteristic is shown in Fig. 4.

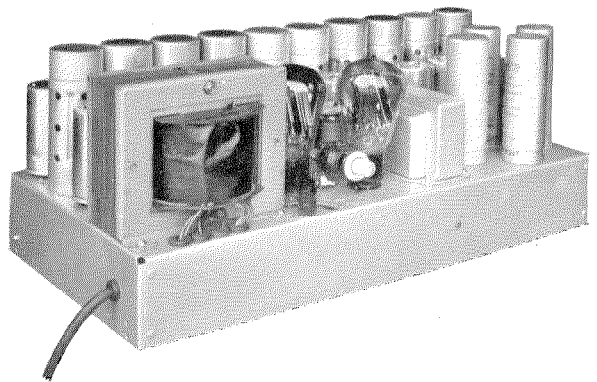

Fig. 1-A—10 Valve Kolster-Brandes Amplifier Chassis.

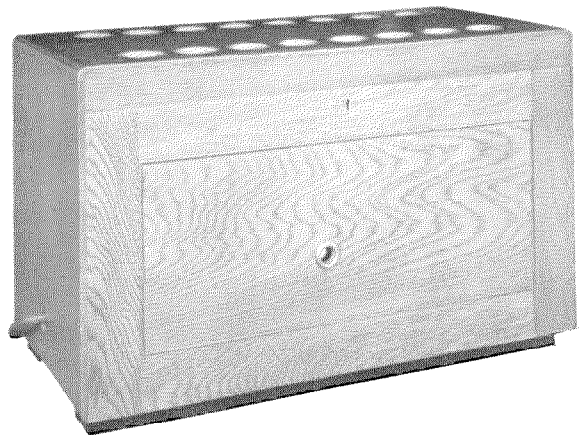

Fig. 1-B—10 Valve Kolster-Brandes Amplifier.

### **Design for Frequency Coverage Using the Minimum Number of Valves**

If a signal  $V_g$  is applied to the grid of a valve of mutual conductance  $\frac{\mu}{Z_a} = g \text{ mA/volt}$ , and if a tuned circuit of three parallel elements,  $L, C, R$  be inserted in its anode circuit, the frequency band width for which the output voltage falls by a factor  $p$  is easily shown to be

$$f_1 - f_2 = \frac{(R + Z_a)\sqrt{p^2 - 1}}{2\pi RCZ_a}$$

and the stage gain is similarly written

$$\frac{\mu R}{R + Z_a}$$

The product of band width and stage gain then reduces to

$$\frac{g\sqrt{p^2 - 1}}{2000\pi C}$$

Here  $C$  must include the inherent valve capacity  $C_p$  and cannot fall below this value. The expression  $\frac{g}{2000\pi C}$  may be defined as the amplifier performance factor. It depends only on the excellence of the valve used and the capacity in the tuned circuit, reaching a maximum of

$$\frac{g}{2000\pi C_p} \quad \text{when } C = C_p.$$

This analysis suggests that the best performance would be secured by making each coil resonate with the valve capacity. For convenience of adjustment, trimmers are provided, but they are made as small as possible. The formulae further indicate that the best possible "amplification coverage" for a single-stage amplifier is approached.

The single-stage amplifier is particularly desirable in this case, since each valve is able to supply useful output power to the line, and no single valve must handle a large peak voltage.

It is interesting to note incidentally that, since the development of this amplifier, the technique of transformer design has advanced considerably and, also, the principle of "negative feedback" has been used extensively to improve the power-handling capabilities of a single valve without distortion. It is probable that, by eliminating

overload problems, a more efficient amplifier will be obtained by using fewer valves in cascade formation.

### Advantages of the Amplifier Described

The following advantages may be briefly enumerated:

(1) *Amplification Coverage.* The performance factor of each valve is very near its theoretical maximum, and good coverage is therefore obtained with valves operated in parallel formation.

(2) *Efficiency.* Every valve is used to deliver power to the line, and each valve may be fully loaded. The output is correctly matched to the line at all frequencies.

(3) *Reliability.* The failure of any one valve does not put the whole system out of action, but only causes a reduction in output over a small frequency band.

(4) *Cross Modulation.* Cross modulation is no more evident than in an ordinary commercial receiver. If noticeable, it may usually be removed by means of the wave traps provided, or by ensuring that the offending local lies in the trough between two peaks.

(5) *Absence of Phantom Signals.* Such signals, due to difference and summation frequencies, are not produced.

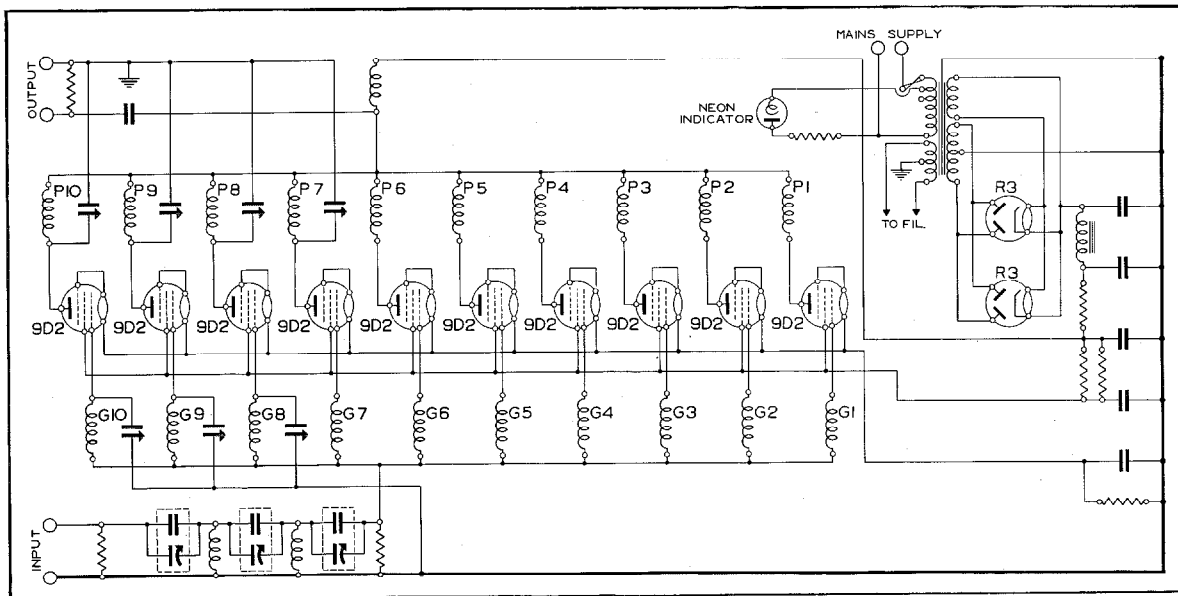

Fig. 2—Circuit Schematic of 10 Valve Kolster-Brandes Amplifier.

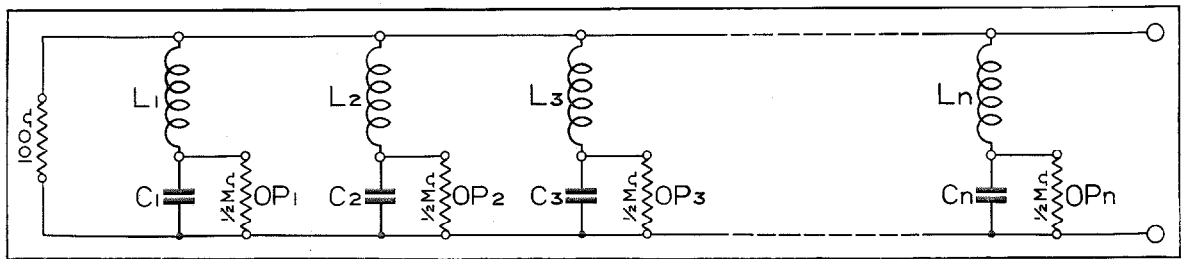

Fig. 3—Schematic Showing the Principle of the Rejectostat Amplifier.

(6) *Overloading.* Slight overloading of the valves is not troublesome since the tuned circuits in the anodes filter away distortion products.

(7) *Absence of Circuit Noise.* The efficient signal step-up from line to grids ensures a good signal/noise ratio. As the signal step-up from aerial to grid is considerably better than in the average commercial broadcast receiver, a better performance, in general, can be expected.

(8) *Absence of Amplifier Schrott Noise.* The use of H.F. pentodes of high slope and low anode current reduces Schrott noise to a minimum. The high grid impedances ensure that anode noise of the valve is small compared with circuit noise.

(9) *Flexibility.* Since the whole spectrum is naturally divided into frequency bands (one for each grid circuit and one for each anode circuit), adjustments can readily be made to improve any individual band, which may be found too weak, at the expense of other bands which may be too strong.

(10) *Negligible Phase Distortion.* Phase distortion can be made negligible over the whole frequency range. It is interesting to note that the human ear functions on the same principle of contiguous resonance bands.

(11) *Additional Grid Bias.* If necessary, a diode detector could be associated with each anode circuit and arranged to give an additional bias to the grid circuits whenever a signal exceeded a predetermined level. This elaboration has not yet been applied in practice.

(12) *Low Cost.* As the apparatus is made entirely of standard broadcast receiver components, it can be manufactured economically. Standard valves are also used, so that no special stock of spares need be kept.

(13) *Simplicity and Ease of Maintenance.* The amplifier contains no delicately balanced circuits and requires no accurate adjustments needing

skilled attention. Given a stable trimmer design, there is nothing to get out of adjustment after installation. The amplifier may be left operating continuously, with a time switch to prevent tenants using the system at inconvenient times, i.e., in the middle of the night. Since the anode voltages used are those of an ordinary receiver, no special protection devices are needed. A monthly inspection is all the attention the amplifier requires.

(14) *Use as R.F. Repeater.* In some cases, an unusually long transmission line is necessary. For example, one radio rediffusion company proposes to erect a good aerial system several miles removed from a rediffusion centre. It is probable that repeater stations would be necessary on such a line.

“Rejectostat” amplifiers can be arranged in series to give any desired overall frequency-gain characteristic, inasmuch as frequency characteristics can be adjusted according to line loss.

Amplifiers provided with selective automatic gain control, as described in (11) above, would automatically adjust the signal levels at all points on the line.

(15) *Adaptation to Short Waves.* The amplifier may quickly be modified for the reception of short wave signals. This type of amplifier would be particularly adaptable since the various small frequency bands used for short wave broadcast transmission could be dealt with by a single valve.

(16) *Television Amplifier.* It has been shown earlier that the maximum amplifying capabilities of one particular valve are definitely limited by electrode capacity, at whatever frequency it may operate. The construction of wide-band television amplifiers has given considerable difficulty due to this fact. This type of amplifier, however, can be designed to cover any band without reducing

valve stage-gain to a point where Schrott noise becomes limiting.

### The Problem of Distribution

The transmission of signals from the amplifier to the consumer may be studied by means of the classical telephone equation which, in its differential form, may be written

$$\frac{dv}{dx} = -ZI; \quad \frac{dI}{dx} = -YV;$$

or, in its integrated form,

$$V = V_0 \cosh P - I_0 Z_k \sinh P,$$

$$I = I_0 \cosh P - \frac{V_0}{Z_k} \sinh P.$$

The only difference between radio frequency and telephone frequency transmission, lies in the different relative importance of the numerical factors. Practical cables may have constants of the following order at 1,000 kc:

$R = 400$  ohms/mile,  
 $L\omega = 6000$  ohms/mile,  
 $G = 0.04$  mhos/mile,  
 $C\omega = 0.6$  mhos/mile,  
 $Z_k = 100$  ohms.  
 Velocity of propagation 100,000 miles/sec.  
 Attenuation 35 db/mile.

In these circumstances, i.e., when the power factors are low, the attenuation is governed mainly by the resistance and leakance,  $R$  and  $G$ , while  $L$  and  $C$  mainly determine the characteristic impedance  $Z_k$ .

The input impedance of a short feeder branched from the main transmission line is capacitive. When, therefore, receivers are connected across the line, two loading effects are introduced, viz., (a) a capacitive loading due to the feeder, and (b) a resistive loading due to the pads which must be inserted before each receiver to prevent accidental line shorts, and reduce inter-receiver reaction. If these loads are not sufficient to affect the above conditions of low power factor, they may be treated separately, the capacities affecting the line impedances, and the resistances the attenuation. The resistive loads are most simply treated as if the spacing were infinite, this assumption being included in the statement that they do not greatly affect the characteristic impedance. If there be  $n$  such loads, each of leakage  $g$  mhos across a 100 ohm line, the bridging loss is  $20 n \log_{10} (1 + 50g)$  db.

The capacity loads are rather more difficult to treat. The simplest method is to split the line into a series of equivalent  $\pi$  pads whose shunt elements are each  $Z_k \coth \frac{Px}{2}$  and whose series elements are  $Z_k \sinh Px$ , where  $x$  is the average

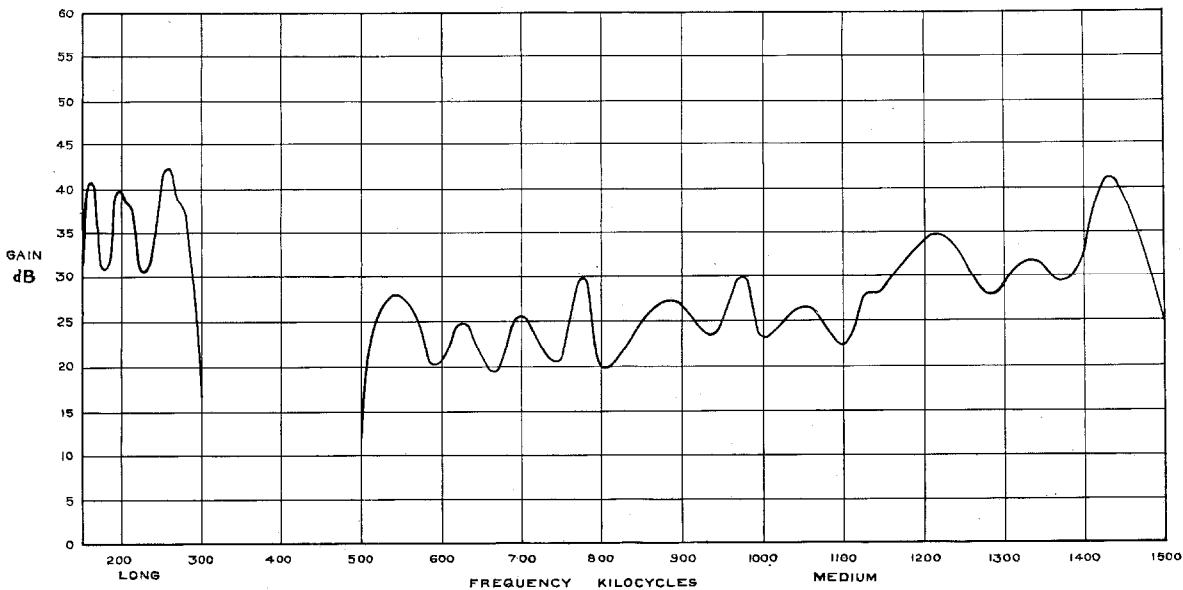

Fig. 4—Amplifier Characteristics.

length between loading points. When the attenuation is small, the approximate forms  $-jZ_k \cot \theta$  and  $jZ_k \sin 2\theta$  may be used, where  $\theta$  is the length  $x$  expressed as a fraction of the wavelength along the cable. Since the velocity of propagation is of the order of one-half the velocity of light, the wavelength along the cable is one-half the free-space wavelength. To each of the shunt elements of the equivalent pads so calculated, may be added the appropriate capacity loading, and the new  $\pi$  pads so formed may be treated as recurrent structures using the theory developed for wavefilters. Thus if  $Z_1$  and  $Z_2$  be the total series and shunt impedance per full section, the iterative impedance, which is also the new characteristic line impedance, becomes

$$\sqrt{1 + \frac{Z_1 Z_2}{4Z_2^2}}$$

The treatment is limited to small loads, but it is essential for correct operation that the loads be kept small, or serious standing waves will occur. In practice, therefore, no taps are permitted longer than one-sixteenth of a wavelength, and the characteristic impedance must not be changed more than 25% by feeder lines. It is therefore usually desirable to avoid taps by looping in each receiver.

Receiver pads usually consist of two resistances (one in each leg) built out between the line and the receiver. The minimum value of these resistances has been found in practice to be 500 ohms and is generally rather higher.

There are usually four sources of loss in the transmission system:

(a) The transformer loss. If more than one line be fed from one amplifier, or if the characteristic impedance is much below 100 ohms, a step-down transformer must be included between the amplifier and the lines. The voltage loss of this transformer is immediately calculable from its step-down ratio.

(b) The pad loss. By inserting various resistances between a 100 ohm source and the receiver, curves of pad loss may be prepared for various types of receiver.

(c) Line loss. The shielded, single core, rubber covered cable usually used has a loss varying from 7 db per mile at 150 kc to 40 db per mile

at 1,500 kc. The characteristic impedance is roughly 100 ohms over this range. The increasing loss with increasing frequency makes it desirable so to tune the amplifier that it has a rising frequency characteristic.

(d) Bridging loss. This has already been considered. It is occasionally worth while to taper this loss so as to increase the signal at the end receivers at the expense of those near the beginning. Generally, however, it is preferable to divide the line into two sections fed from the same or separate amplifiers.

In designing a distribution scheme, the losses detailed above must be calculated for various possible dispositions of cables and amplifiers, and the most economical scheme selected. No universal rule can be laid down, and the designer has to be guided by past experience of other installations. Two amplifiers are at present available, viz., an eight valve and a ten valve amplifier. In an average installation, the eight valve amplifier will operate 50 and the ten valve amplifier 100 receivers. If necessary, two amplifiers may be connected in cascade, provided precautions are taken against overloading the second one, or the transmission line may be split into several short lengths, each connected to a different amplifier.

In designing the distribution system, it is necessary to assume an average receiver. Where a tenant possesses a receiver of unsuitable impedance, a matching transformer may have to be inserted before allowing him to connect the set to the line. Similar transformers are often necessary to maintain a balance to ground, which is essential in very noisy locations to minimize noise.

#### APPENDIX

##### *Valve Noise and Circuit Noise Considerations*

$V_s$  = "Schrott" noise, or anode noise developed across the anode load impedance

$V_j$  = "Johnson" or circuit noise developed in the grid circuit

$I_a$  = Anode current

$e$  = Charge on an electron

$\mu$  = amplification factor of the valve

$R_2$  = Impedance of load in anode circuit

$\rho$  = Internal impedance of valve

$df$  = Element of frequency band

$R_1$  = Grid circuit impedance

$T$  = Absolute temperature of grid circuit

$k$  = Boltzman's constant

$V_{ip}$  = Noise voltage in the anode circuit, due to "Johnson" noise on the grid

Assuming the two following formulae:\*

$$(V_s)^2 = 2I_a e \frac{(\rho R_2)^2}{(\rho + R_2)^2} df,$$

and

$$(V_i)^2 = 4R_1 k T df,$$

we have

$$(V_{ip})^2 = 4R_1 k T df \frac{(\mu R_2)^2}{(\rho + R_2)^2},$$

$$\frac{(V_{ip})^2}{(V_s)^2} = \frac{2kTR_1\mu^2}{I_a e \rho^2}.$$

\* "The Spontaneous Background Noise in Amplifiers due to Thermal Agitation and Schrott Effects," by E. B. Moullin, M.A., and H. D. M. Ellis, B.A., *I. E. E. Proceedings*, April, 1934.

If  $k = 1.37 \times 10^{-23}$  joule per degree centigrade (Boltzman's constant),

$T = 290^\circ$  abs.,

$e = 1.5 \times 10^{-19}$  coulomb (charge on an electron),

$$\frac{(V_{ip})^2}{(V_s)^2} = 0.053 \cdot \frac{R_1}{I_a} \cdot \frac{\mu^2}{\rho^2}.$$

Suppose that anode noise and grid noise are equally important; then

$$R_1 = \frac{I_a \rho^2}{\mu^2 \times 0.053}.$$

For a broadcast H.F. pentode,

$$\mu = 2000, \quad \rho = 1,000,000,$$

$$I_a = 10 \text{ mA}$$

and  $R_1$  is approximately 50,000 ohms. If grid impedances smaller than 50,000 ohms are used, the anode noise will predominate.

A quiet amplifier using broadcast type of valves must have grid impedances substantially greater than 50,000 ohms, let us say, at least 100,000 ohms.



# Automatic Method of Factory Testing of Circuit Units

By E. P. G. WRIGHT

*Standard Telephones and Cables, Ltd., London, England*

**SUMMARY:** *This article describes the automatic testing of so-called plug or jack-in circuits. In place of following the usual practice of describing new testing methods in connection with a particular communication system, consideration is given to a generalized testing scheme which is readily applicable to many different types of circuits.*

**I**N an art changing as rapidly as communications, the manufacturer not only finds it necessary continuously to adapt his testing procedure to new developments, but also to older types of equipment required for extensions or other purposes.

In the past, the possibility of being called on

to test a wide range of equipment necessitated maintaining various ranges of test boxes and valuable testing gear which was utilized only at infrequent intervals. Furthermore, in order to keep pace with inspection requirements, testing paraphernalia required overhauling and modification in advance of the production of a particular

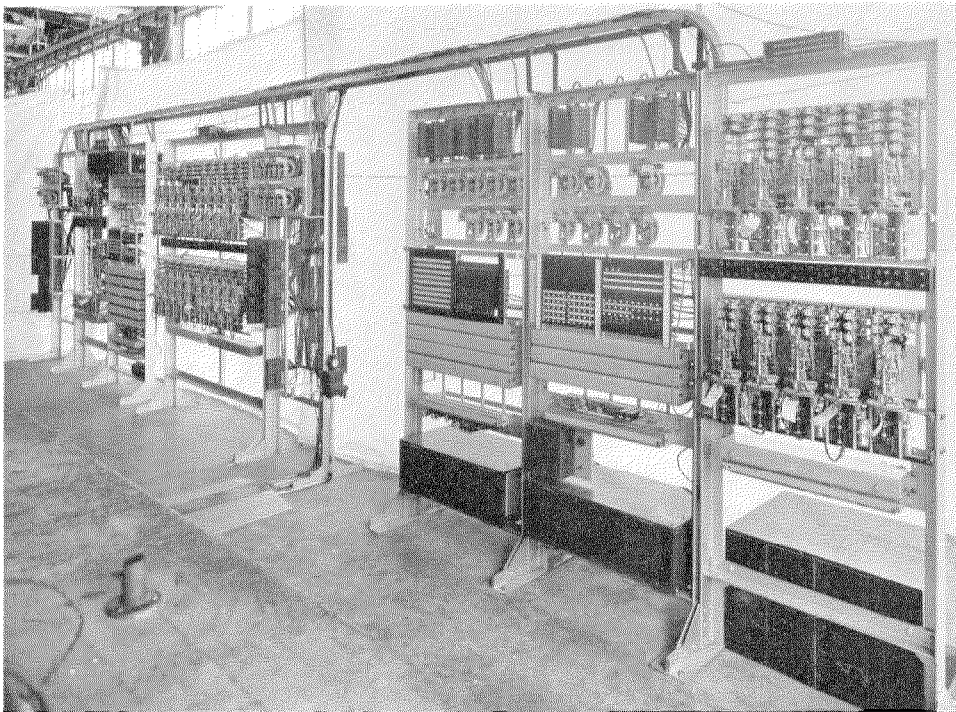

*Fig. 1—General View of Automatic Testing Equipment. The Bays reading Right to Left are: Inspection Rack for Final and Group Selectors with Bayonet Type Mounting; Group Selector Test Rack; Final Selector Test Rack; Access and Cross Connecting Frame; Final and Group Selector Inspection Rack with Channel Type Mounting; Line Finder and Code Selector Test Rack; Line Finder and Code Selector Inspection Rack; Access and Cross Connecting Rack.*

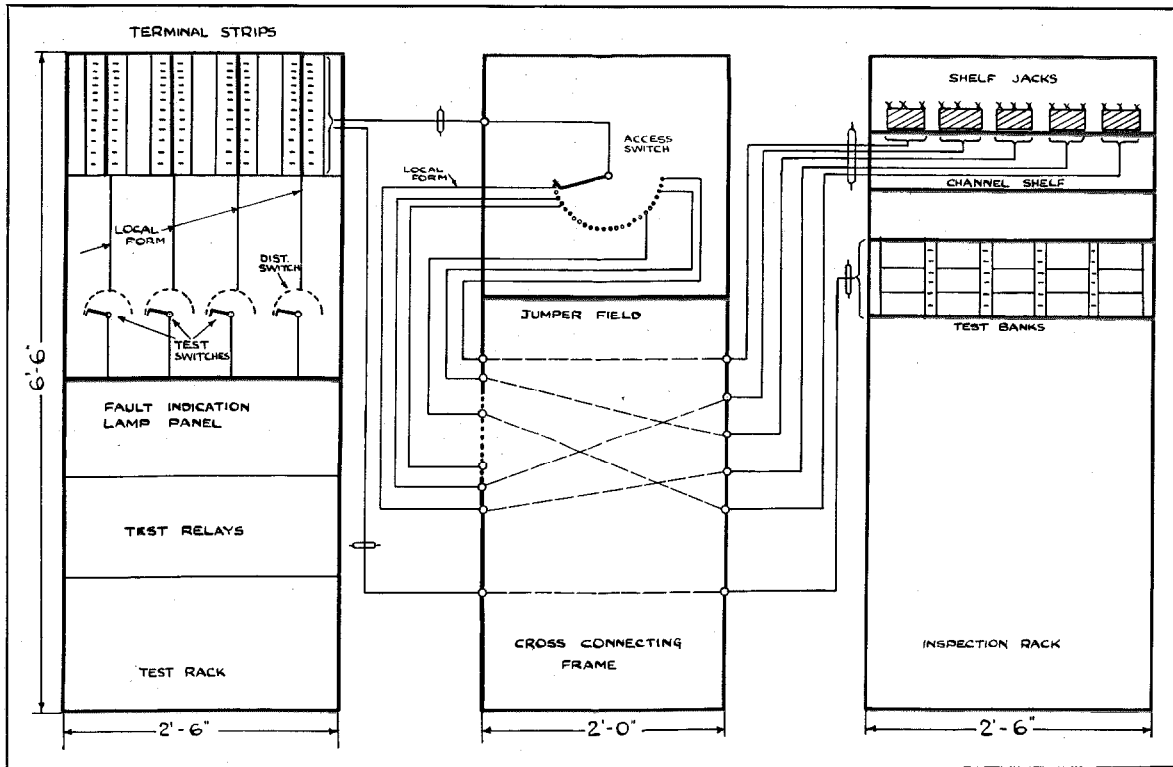

Fig. 2—Typical Automatic Test Rack Wiring showing Jumper Arrangements.

type of equipment. This ordered procedure could be followed in some cases; but, more often, the tailing out of previous designs held the test sets in use up to, or even beyond, the period when inspection of the new equipment was required. To handle this situation, it was therefore necessary to provide a large number of test sets which, in turn, involved additional planning work in maintaining up-to-date records and the danger of keeping on hand an unnecessary number of test sets in readiness for possible future demand.

To overcome these objections and to provide a generalized solution, an automatic testing equipment, shown in Fig. 1, has been devised. It includes a number of inspection positions which may be utilized for many different circuit conditions by changing cross connections on a permanent frame. The testing portion proper contains the testing elements necessary for handling all circuits of similar type, and jumpers are connected to access switches in such a way that only the appropriate tests are applied.

It will be evident that such an arrangement provides facilities for thoroughly and speedily

testing any obsolete circuit, merely by running the necessary jumpers. This operation can be controlled by the Inspection Department when the load appears.

Fig. 2 shows the general layout of a typical testing suite of bays. The method of cross connecting will be readily appreciated.

The four fundamental considerations involved in the planning of this equipment were the following:

(1) Sufficient speed of functioning of the common testing circuits to handle the peak load output. This requirement necessitated complete automatic testing without manual assistance.

With the automatic testing equipment it is only necessary, after fitting the panel to be tested in the inspection rack, to operate the start test key and a second key which is individual to the inspection position. If the common test portion is already functioning, then only the second key is operated. A lamp is provided with each position in order that an indication may be given when the panel is tested correctly. The association between the common testing portion

and the circuit to be tested is automatic, as is also the control of the correct tests to be applied. With certain fault conditions, it may be necessary to dial into the circuit repeatedly; therefore, to avoid interference with the common testing portion, certain outlets are wired only for manual testing.

(2) Provision of facilities for changing an inspection position for use with a new circuit. Such facilities must be isolated to avoid interference or changes in conditions on other test positions. In addition, the possibility of the whole or part of the common testing circuits being accidentally rendered faulty must be eliminated.

(3) Facilities for adding further test positions for new circuits without disturbing the existing positions. In the equipment constructed, the wiring to the test relays was therefore not formed up but was run loose through jumper rings.

(4) Ready access to the front and rear of the panels under test for rapid checking of suspected causes of trouble. The design of the shelf is such as to provide maximum access to the wiring side.

Fig. 3 illustrates a schedule of tests carried out with the final selector test equipment. It should be understood that more than one position on the inspection rack may be allocated to any one circuit. Although columns 6 and 8 appear iden-

FINAL SELECTOR TESTING SCHEDULE													
Test No.	Test	TYPE OF CIRCUIT											
		200	200	200	200	200	100	100	100	100	200	200	200
		Lines: 2/10	2/10	over 20	Regular	Regular	2/10	2/10	2/10	Regular	11/20	over 20	11/20
Metering: Booster		4th Wire	4th Wire	4th Wire	4th Wire	Booster	4th Wire	None	4th Wire	None	4th Wire	Booster	Booster
1	"P" Lead Clear	/	/	/	/	/	/	/	/	/	/	/	/
2	Seize	/	/	/	/	/	/	/	/	/	/	/	/
3	"A" Relay Balance	/	/	/	/	/	/	/	/	/	/	/	/
5	Sending 10's Digit 9	/	/	Digit 0	/	/	/	/	/	/	/	Digit 0	/
6	Sending Pause	/	/	Spare	/	/	/	/	/	/	/	Spare	/
7	Sending Units Digit 9	/	/	"	/	/	/	/	/	/	/	"	/
9	Ringing Non Trip	/	/	/	/	/	/	/	/	/	/	/	/
12	Ringing Trip	/	/	/	/	/	/	/	/	/	/	/	/
13	Wiper Test	/	/	/	/	/	/	/	/	/	/	/	/
14	Booster Metering	/	Spare	Spare	Spare	/	Spare	Spare	Spare	Spare	Spare	/	/
15	Supy. "D" Release	/	/	/	/	/	/	/	/	/	/	/	/
16	Last Party Release	Spare	Spare	Spare	Spare	Spare	Spare	/	Spare	/	Spare	Spare	Spare
17	Release	/	/	/	/	/	/	/	/	/	/	/	/
18	-As for Tests 1, 2, 5, 6, 7	/	/	/	/	/	/	/	/	/	/	/	/
23	Sub Busy	Spare	Spare	Overflow	-----	-----	-----	-----	-----	-----	-----	-----	Overflow Busy
24	Busy Flash	/	/	/	/	/	/	Tone	/	Tone	/	/	/
25	Busy Hold	/	/	/	/	/	/	Hold	/	Hold	/	/	/
28	Release	/	/	/	/	/	/	/	/	/	/	/	/
29	Batt:O/o Seize (Even 100's)	/	/	/	/	/	/	Odd 100's	Odd 100's	Odd 100's	Odd 100's	/	/
30	"P" Lead Clear	/	/	/	/	/	/	Odd 100's	Odd 100's	Odd 100's	Odd 100's	/	/
31	Seize (Even 100's)	/	/	/	/	/	/	Odd 100's	Odd 100's	Odd 100's	Odd 100's	/	/
32	Digit Discrimination	-----	-----	Digit 5	-----	-----	-----	-----	-----	-----	-----	Digit 5	Spare
33	-As for Tests 5-7	/	/	/	/	/	/	/	/	/	/	/	/
37	P.B.X.1st Line Free	/	/	/	-----	-----	-----	/	/	Line Free	/	/	/
40	Ringing Trip	/	/	/	/	/	/	/	/	/	/	/	/
41	Wiper Test	/	/	/	/	/	/	/	/	/	/	/	/
42	HB Op; Cut thro' Even 100	-----	-----	-----	-----	-----	-----	-----	-----	-----	-----	-----	-----
43	Release	/	/	/	/	/	/	/	/	/	/	/	/
44	-As for Tests 30, 31, 33-35	/	/	/	/	/	/	/	/	/	/	/	/
49	P.B.X.1st Line Busy	/	/	/	/	/	/	/	/	/	/	/	/
	End " Free	/	/	/	-----	-----	-----	/	/	Spare	/	/	/
52	Release	/	/	/	/	/	/	/	/	/	/	/	/
53	-As for Tests 44-48	/	/	/	-----	-----	-----	/	/	/	/	/	/
58	P.B.X. Night Line Busy	/	/	/	-----	-----	-----	Tone	/	Spare	/	Spare	/
59	Busy Flash & Hold	/	/	/	-----	-----	-----	Hold	/	"	/	"	/
60	Release	/	/	/	/	/	/	/	/	/	/	/	/
61	-As for Tests 53-57	/	/	/	/	/	/	/	/	/	/	/	/
66	P.B.X. Last Line Free	/	/	/	-----	-----	-----	/	/	Spare	/	Spare	/
68	Release	/	/	/	-----	-----	-----	/	/	"	/	"	/
69		/	/	/	/	/	/	/	/	/	/	/	/
73	As for Tests 61-65	/	/	/	-----	-----	-----	/	/	"	/	"	/
76	P.B.X.Busy. Busy Flash	/	/	/	-----	-----	-----	Tone	/	"	/	"	/
77	Busy Hold	/	/	/	-----	-----	-----	Hold	/	"	/	"	/
79	Release	/	/	/	-----	-----	-----	/	/	"	/	"	/
80	"B" Relay Timing 46V	/	/	/	/	/	/	/	/	/	/	/	/
81	Pause	/	/	/	/	/	/	/	/	/	/	/	/
82	Batty: Change over to 54V	/	/	/	/	/	/	/	/	/	/	/	/
83	"B" Relay Timing 54V	/	/	/	/	/	/	/	/	/	/	/	/
84	Pause	/	/	/	/	/	/	/	/	/	/	/	/
85	Finish End of Tests	/	/	/	/	/	/	/	/	/	/	/	/

Fig. 3—Schedule of Tests.

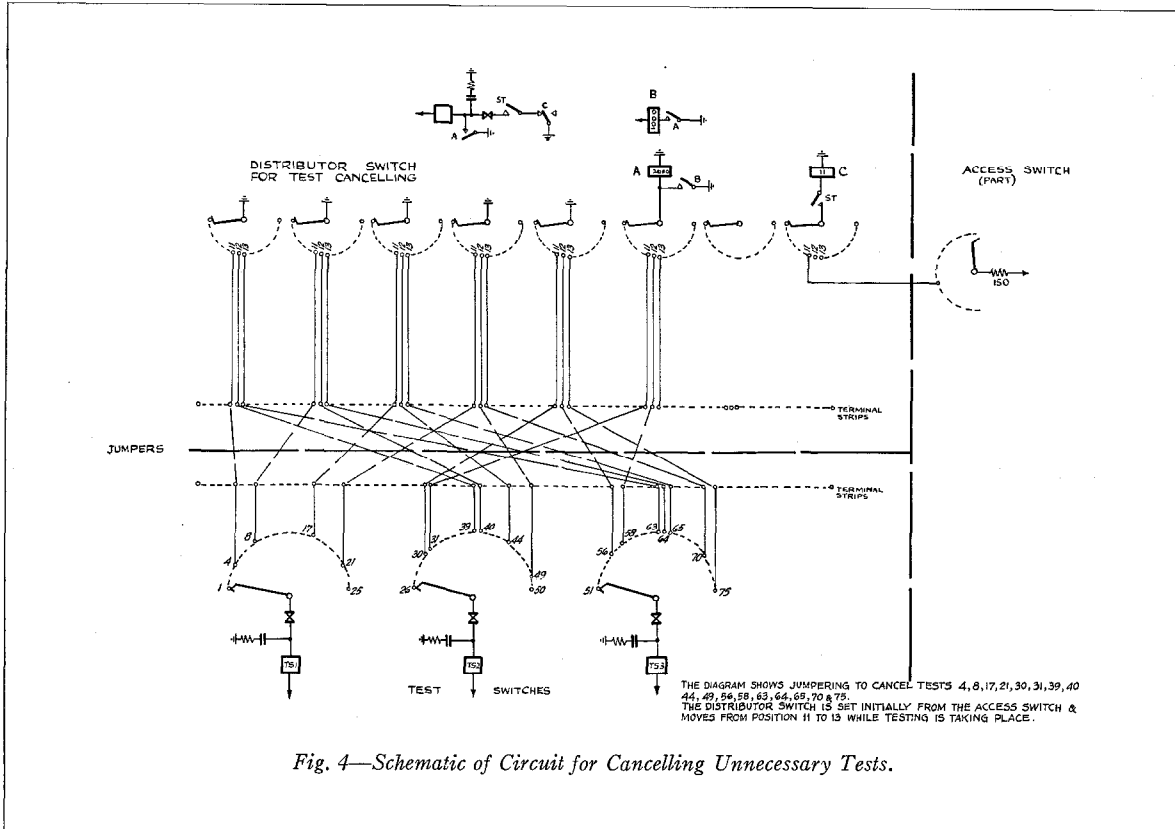

Fig. 4—Schematic of Circuit for Cancelling Unnecessary Tests.

tical, the circuits must be placed only in their correct positions on account of differences in jack wiring and jack mounting.

Fig. 4 shows the arrangements for cancelling tests which need not be applied. The distributor switch is positioned from the access switch which determines the type of circuit to be tested. The wipers of the distributor switch connect a potential to positions of the test switches which advance through such cancelled positions in the same way as if the test had been correctly carried out. The sixth wiper to cancel a test causes relay operations resulting in advancing the distribution one step. In consequence, a particular setting of the access switch may be represented by several positions on the distributor switch. On the other hand, several positions on the access switch may be tied together if the same tests are to be cancelled.

For various reasons the product of the factory is improved by automatic testing. The automatic test is fundamentally more thorough. Wherever a fault is encountered and corrected, the whole

cycle of tests must be rerun. Owing to the fact that common apparatus is employed, greater precision can be used in applying limiting conditions for impulsing and similar critical conditions. Voltage variations are introduced during the testing cycle so that timing tests for release lags and stepping speed may be carried out on extreme limits. Actually the tests applied are slightly more stringent than those used for functionally testing on site before acceptance.

Fig. 5 shows a typical weekly output chart from which it can be seen that an average of seven attempts are made on each circuit before acceptance. Approximately 20% are passed at the first attempt, so that the number of attempts on those found faulty is in the neighborhood of ten.

In Fig. 6 is given the approximate floor space requirements of the automatic testing equipment.

The advantages of this method of automatic testing may be summarized as follows:

- (1) More rigorous testing under full automatic control, including among others:

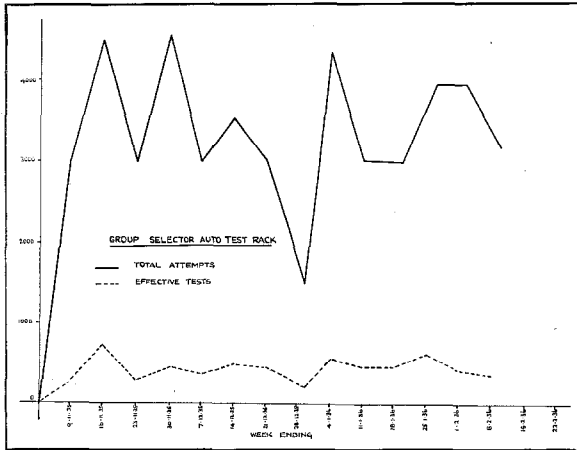

Fig. 5—Typical Weekly Output Chart.

- (a) Precision impulsing over limiting conditions.
- (b) Timing tests of relays to meet acceptance tests under practical conditions over the voltage range.
- (c) Hunting speed of group selectors.
- (d) Testing of selectors over voltage range of 46 to 54 volts with automatic voltage changeover.

(2) Rapidity.

For group selectors, it is estimated that the average testing time is 1½ to 2 minutes.

For final selectors, the average time is 2½ to 3 minutes.

For finders, the average time is 1½ to 2 minutes.

- (3) Lamp display indicating fault on selector or panel.
- (4) Automatic discrimination of tests to be applied to each type of selector via the access switches.
- (5) Switch banks fixed to racks necessitating no adjustment of banks to selectors.
- (6) Each jack position adapted to testing various types of selector by changing jumpers of the cross connecting frame.
- (7) Automatic selection of next selector to be tested when one has been tested, a lamp display indicating selectors which have been passed.
- (8) Ease of testing new selectors by the addition of test elements to the test circuit without interfering with testing which may be in progress.
- (9) Manual operation cut down to a minimum, the only operation necessary being the adjustment of wipers to the banks.
- (10) Provision for a check test before the selector is automatically tested. This may be desirable for checking such items as wiring to the selector test jacks, etc., or for clearing faults while the test circuit is in operation.
- (11) Ready access to the selector wiring at the rear without jacking out the selector.
- (12) An overall saving in:
  - (a) Testing staff.
  - (b) Floor space devoted to testing.
  - (c) Cost per circuit tested.

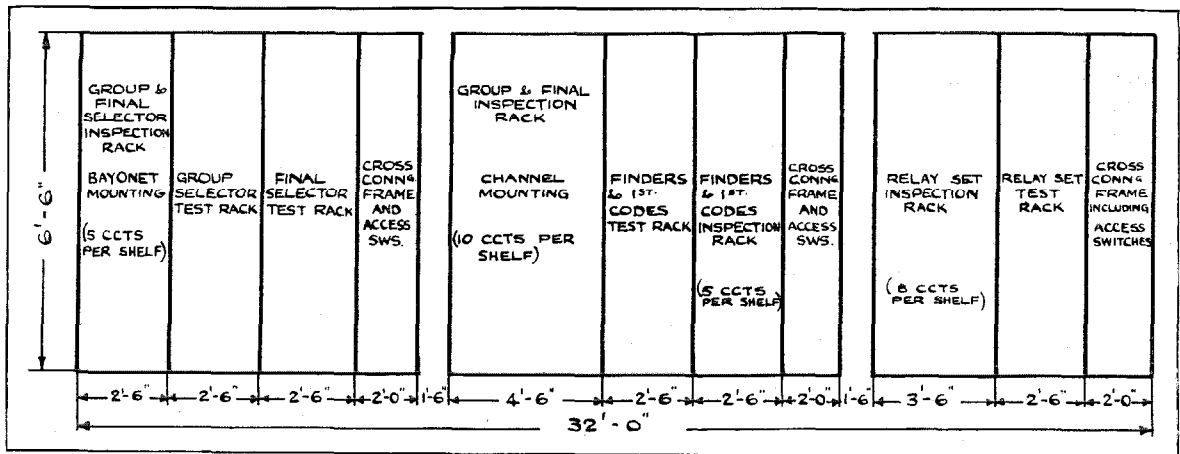

Fig. 6—Typical Layout of Automatic Testing Equipment.

# Hot Cathode Mercury Vapour High Tension Supply Equipment for Broadcasting Stations

By G. RABUTEAU

*Les Laboratoires, Le Matériel Téléphonique, Paris, France*

**SUMMARY:** *The respective characteristics and performances of the various types of high voltage d-c. supplies for high power radio transmitters are briefly reviewed and compared with those of the hot cathode mercury vapour rectifiers.*

*Characteristics of a series of hot cathode mercury vapour valves designed by the L.M.T. Laboratories are given. The influence of the characteristics of the rectifier circuit on the valve performances is also considered.*

*Grid controlled hot cathode mercury vapour rectifiers are also reviewed and a description is given of a simple system for firing the valves.*

## Introduction

**I**N the decade just past, the advance in the technique of broadcasting has been very rapid and probably reflects a more intensive progress than any other section of electrical engineering. In the early days of broadcasting, the general level of power in the antenna of the more important stations was of the order of 500 watts, whereas to-day, stations of 100 kW. and above, are in operation; an advance in power of more than 200 times.

This advance, while rapid, has not been forced in any way, the various problems involved having been solved in the natural course of development. Perhaps the problem causing most delay in progress has been that of the thermionic valve, the ever increasing demand for higher antenna power always leading the already intensive development of higher power tubes.

The technique of high frequency amplification in broadcasting requires that the thermionic valves of the amplifier should have a power handling capacity of about four times the power supplied to the associated output circuit, in order to handle the peaks of modulation. When it is considered that for the largest stations a high tension supply is required of some hundreds of kilowatts the question of annual power cost becomes important and the problem of improving the efficiency of the power equipment requires greater attention.

It is interesting to recall that in the early types of broadcasters, which used thermionic valves of low anode voltage, it was possible to employ d-c.

generators for the supply to the anodes, and naturally this practice tended to continue with the increase in anode voltage required by the progress of tube design. It became evident, however, that increased voltage introduced difficulties of insulation and commutation. Moreover, the high value of short circuit current brought in the added complication of special protection against short circuits. It has been said that the development and design of thermionic valves for high power lagged and, in order to increase power in the antenna, it became the practice to add more tubes in parallel, which was responsible for emphasising a phenomenon now generally known as "Rocky Point Effect." These effects were evidenced by a transient discharge, the intensity, other factors being equal, depending on the power capacity of the anode supply. With a d-c. generator, the short circuit current is limited only by armature reaction and the losses in the circuit, so that a Rocky Point Effect might easily have far reaching effects on the components associated with the tube, as well as on the tube itself, due to the excessive plate current. For these reasons, the d-c. generator without a limiting device was considered far from ideal. A temporary solution of the problem was found in the valve rectifier, which gives an inherent limitation of output due to saturation of the filament emission. The extreme reliability of the valve rectifier was such that it became extensively and almost universally used in broadcasting equipments. While the degree of reliability was high, it must be admitted that the efficiency was low, being of the order of 70% to 80% depending on the output and the

circuit employed. This was not of great importance when considering transmitters of medium power, but with the demand for high power an increase of efficiency became imperative. The reason for the inherent low efficiency of the thermionic valve rectifier lies in the high voltage drop in the tube and, to a lesser degree, the filament power. These losses are dissipated in the form of heat which is carried away either by cooling water or by radiation, depending on the type of rectifier valve. The mercury vapour rectifier, which had been extensively employed for low tension services, was known to have a low voltage drop, and the problem arose as to the possibility of adapting that type of rectifier to high tension service with the object of increasing the efficiency of the high tension supply.

The earliest type of mercury rectifier to be adapted to radio transmitters consisted of an evacuated glass vessel at the bottom of which was a pool of mercury forming the cathode, the anodes being arranged in the glass walls of the tube. The rectifying action was caused by a discontinuous discharge between anodes and cathode, the anodes being at a high alternative potential. Auxiliary means were provided for starting the discharge or arc. When functioning correctly, the valve is filled with a blue glow, this being a typical characteristic of mercury vapour rectifiers.

The "Standard" 120 kW. equipment at Praha is equipped with a 500 kW. arc pool rectifier designed for 20,000 volts d-c. This particular rectifier employed eight valves in series, each valve having three anodes. The eight valves were enclosed in four oil-filled tanks and facilities were available for changing a tank in which a valve had failed. The remainder of the equipment consisted of high tension transformers and an auto-transformer with an electrically-operated tapping switch by means of which the voltage could be varied on or off load. The rectifier was later fitted with arc pool valves having a grid electrode, the object being to reduce arc-backs, or reversed arc, and hence to improve the life of the valves. The addition of the grid electrode did, in fact, effect a great improvement and the rectifier is now giving satisfactory service with reasonable long valve life. In considering the advantages and disadvantages of the arc pool rectifier, it may be

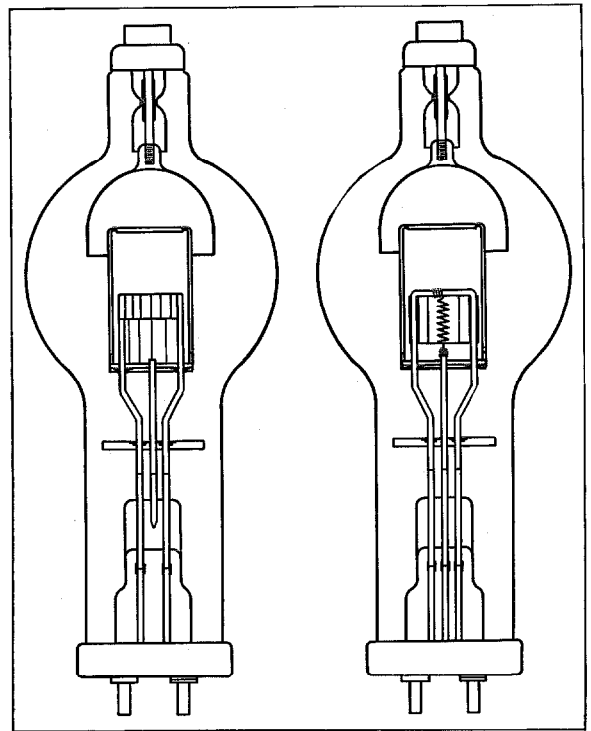

*Fig. 1—Cross Section of Two Typical Hot Cathode Mercury Vapour Tubes. The Tube on the Left-Side is Directly Heated; the Other is Arranged for Indirect Heating.*

said that from the point of view of efficiency, simplicity, and reliability, it is good. The disadvantages are that the floor space required per kilowatt is large, and that the breakdown of a valve interrupts the service. The auxiliary gear required by the rectifier is relatively little and is not likely to cause breakdown of the main plant.

The loss of 5 minutes service time consequent upon valve failure—a period which is quite average—must be regarded as a serious disadvantage and can only be avoided by the use of a complete spare or, alternatively, a spare half-rectifier, in which case the capital cost of the installation becomes impressive.

Another type of rectifier extensively used in low tension commercial undertakings is the mercury arc type in which the electrodes are contained in a metal tank which is kept continuously evacuated by means of associated pumping equipment.

This type of rectifier has now been developed for service working pressures up to 20,000 volts d-c. and a power of about 500 kW. The "Stand-

ard" equipment of the 120 kW. station at Budapest utilises a rectifier of this type and, as spare equipment, a "Standard" hot cathode rectifier is installed. In comparing the metal tank type of rectifier with other types, the economic factor becomes of extreme importance, since its capital cost is considerably greater than that of the renewable valve type as exemplified by the arc pool and hot cathode rectifiers. The capital cost is so high that in most cases a duplicate rectifier installation is prohibitive and recourse is necessary to a cheaper form of spare rectifier. One of the disadvantages of the tank type of rectifier, apart from the high initial cost, is that the auxiliary equipment for control purposes is complicated and a fault is likely to cause a lengthy interruption of service. This interruption is apt to be aggravated by the fact that the complexity of the circuit makes it difficult for ordinary station operators easily to diagnose a fault and to remedy it. The main body of the rectifier is not likely to give trouble, as the vacuum seals are soundly designed. The electrodes themselves are very durable but require renewal at intervals of about a year or more depending on the service conditions, an operation which would probably require a considerable time for completion and remaking of the vacuum. A factor which cannot be neglected, in view of the varying standards of

competence in the maintenance personnel of radio stations, is that the rectifier is equipped with pumps and gauges, and although such gear is robust it is nevertheless intricate and of high precision.

A later development in rectifier design is the use of hot cathode mercury vapour valves. A series of such valves will be described, together with rectifier equipments using them, in the following pages.

### *Description of a Series of Hot Cathode Mercury Vapour Rectifiers and of Their Operating Characteristics*

A hot cathode mercury vapour valve consists essentially of an anode and a cathode sealed into a glass bulb from which the air has been evacuated and into which a certain amount of mercury is introduced to neutralise the space charge between the cathode and the anode.

The cathode is generally composed of a nickel ribbon in valves having direct heating, and of nickel cylinders in valves having indirect heating. Special nickel alloys containing Cobalt, Titane or Aluminium have been employed as cathode material. So-called protruded "nickel ribbon" and meshes of nickel wire also are used instead of plain nickel ribbon, to increase the adherence of the coating material which consists of a mixture of special alkaline earth oxides, this coating being obtained by dipping or spraying on the cathode a suspension of alkaline earth carbonates in an appropriate varnish. The emission current of such cathodes after they have been activated during the pumping procedure varies from 100 milliamperes to several amperes per watt of heating power, depending on the size of the cathode and the disposition of the screens provided around the cathode structure.

Fig. 1 represents conventionally a cross section of two typical hot cathode mercury vapour rectifier valves, one of the indirectly heated type and the other with a directly heated cathode. In both types the active part of the cathode is almost completely surrounded by screens, except towards the anode.

In large cathodes with proper screening, practically all the heat dissipated is radiated through the top aperture of the screens. The heating power required to bring the cathode to its operat-

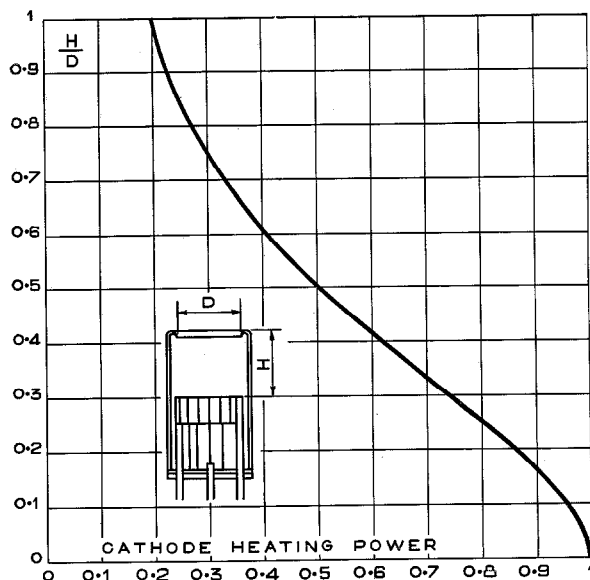

Fig. 2—Variation of the Heating Power Required to Bring a Cathode to Operating Temperature as a Function of the Height of the Screens.



ing temperature between  $800^{\circ}\text{C.}$  and  $900^{\circ}\text{C.}$  is approximately 20 watts per square centimetre of the screen opening for small types, and decreases to 5 watts per square centimetre for large types, nearly equal to the radiated power, which may be calculated, assuming that the top of the active part of the cathode radiates as a black body following the Lambert cosine radiation law.

The curve of Fig. 2 gives approximately the theoretical gain which may be obtained by decreasing the solid angle through which the active part of the cathode radiates, this being achieved by decreasing the distance between the top aperture of the screens and the active part of the cathode for a given diameter of this top aperture of the screens.

The anode is generally made of graphite to decrease its emissivity and is sealed into the glass bulb at the end opposite to the cathode.

In nearly all modern valves the anode encloses completely the top part of the cathode screens, such shape giving many advantages, one of which is that it prevents the formation on the inner walls of the bulb of a black deposit, which generally sets up arc-backs after a certain time of operation. This shape also localises the mercury glow inside the anode and cathode screens and decreases the space occupied in the valve by the ionised mercury vapour—an important point which largely affects the maximum rating at which the valve can safely be operated.

The dimensions of the glass bulb, anode, cathode, and those of adequate heat reflecting screens placed on the cathode support make the bulb temperature higher at the anode end of the glass vessel than at the cathode end. This causes the mercury in the tube to condense at the colder end near the cathode cap.

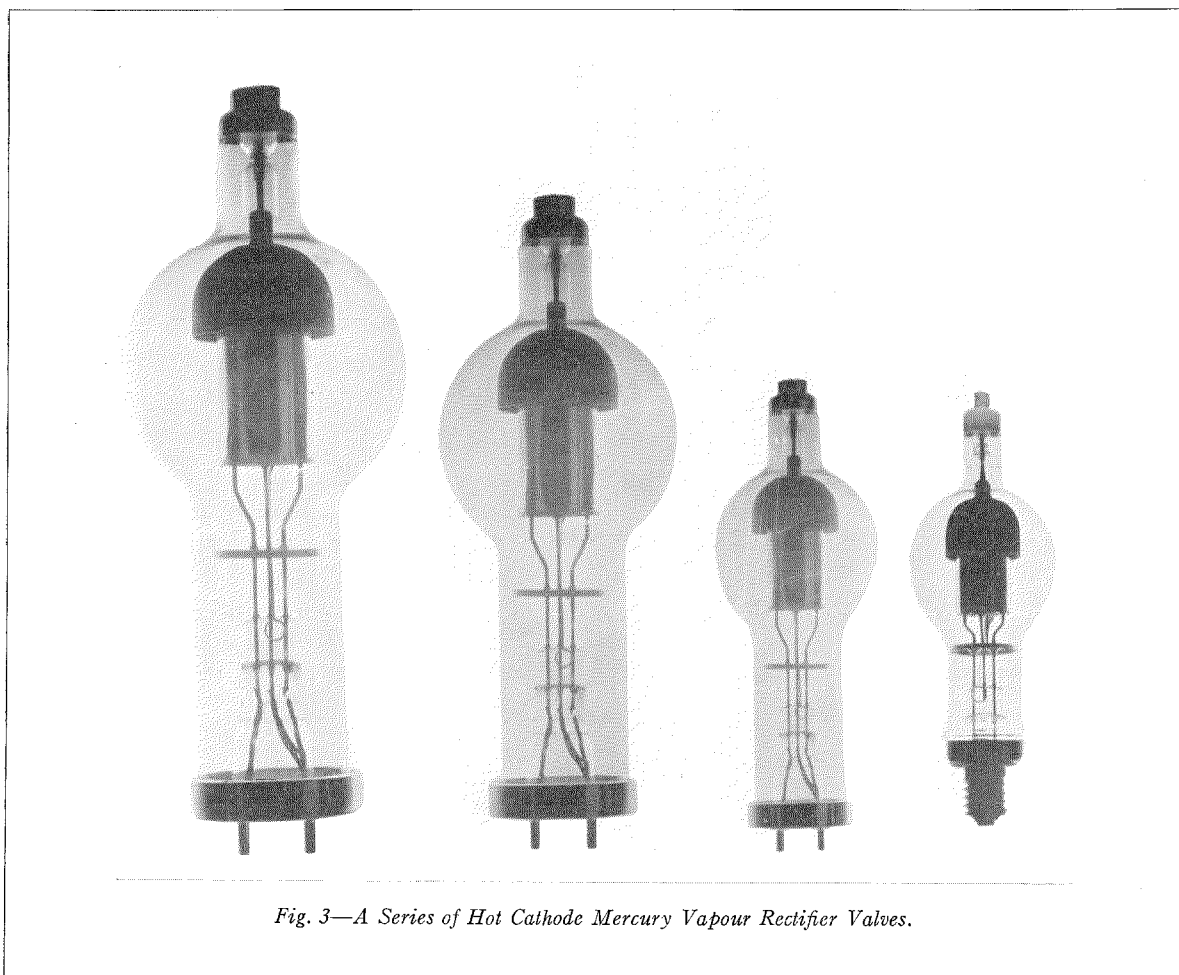

*Fig. 3—A Series of Hot Cathode Mercury Vapour Rectifier Valves.*

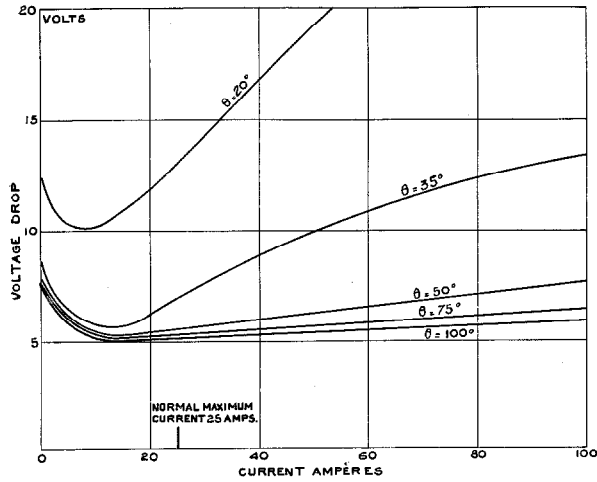

Fig. 4—Variation of the Volt Drop in a Hot Cathode Mercury Vapour Valve Versus the Load Current for Different Mercury Temperatures.

Fig. 3 shows a series of hot cathode mercury vapour rectifier valves having the features briefly discussed in the preceding paragraphs. The characteristics of these valves are given in the table below:

	Type L.8160	Type L.8161	Type L.8162	Type L.8165
Filament voltage.....	5 volts	5 volts	5 volts	5 volts
Filament current, about....	10 amps.	20 amps.	40 amps.	100 amps.
Peak anode current.....	2 amps.	5 amps.	20 amps.	50 amps.
Peak inverse voltage.....	12,500 V.	20,000 V.	20,000 V.	16,000 V.

These tubes permit the realisation of rectifier equipments suitable for the high tension supply of radio transmitters having output powers ranging from a few hundred watts up to some hundreds of kilowatts, which is the maximum so far considered. Views of rectifier equipments using these valves and having outputs between 3 kW. and 500 kW. and voltages up to 30,000 volts are shown hereinafter.

The characteristics of hot cathode mercury vapour rectifiers are rated or defined by the majority of manufacturers and also in the above table, by the maximum instantaneous and the maximum inverse voltage which they can support. This definition is not, in the present state of the art, absolutely complete: different authorities have indicated that the maximum current and inverse voltage supported by a given type of tube depend enormously on the circuit in which the tube is used. The inverse current, i.e., the current passing across the tube during the period when

the anode is negative, is a factor in determining the probability of a short circuit in hot cathode mercury vapour valves, and its influence on this performance is allied with the principle of the valve itself—the employment of an ionised medium for carrying the rectified current.

In a hot cathode mercury vapour valve, the ignition or striking voltage is that voltage which sets up ionisation by collision of the mercury vapour with electrons coming from the cathode. This tension, which lies between 12 and 20 volts, varies with the mercury vapour pressure and the emissivity of the cathode.

The voltage drop in a rectifier valve is the average value of the voltage which gives to the electrons drawn from the cathode the energy sufficient to reach the anode, i.e., the average value of the voltage which gives to electrons sufficient energy to bring molecules of mercury to the ionisation condition.

The fact that the voltage drop is less than the ignition voltage, shows that the mercury vapour does not return instantaneously to its deionised or neutral condition but passes through a certain number of intermediate levels. At any instant in a valve, the quantity of mercury vapour which is in a condition different from the neutral state depends not only on the value of the current at that instant but also on the value of the current at the time immediately preceding the moment under consideration.

During the working part of the rectifying cycle the voltage drop in hot cathode mercury vapour

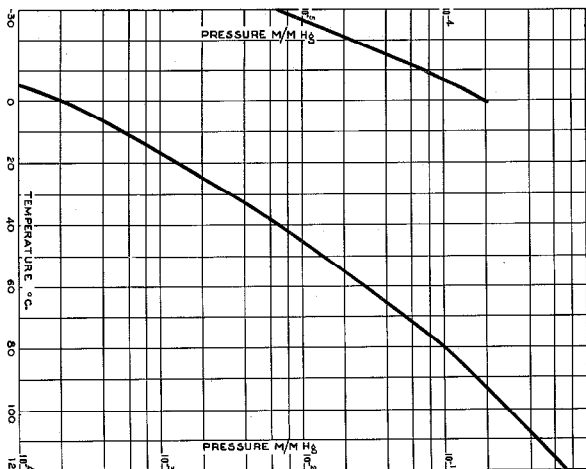

Fig. 5—Pressure Versus Temperature of Saturated Mercury Vapour.

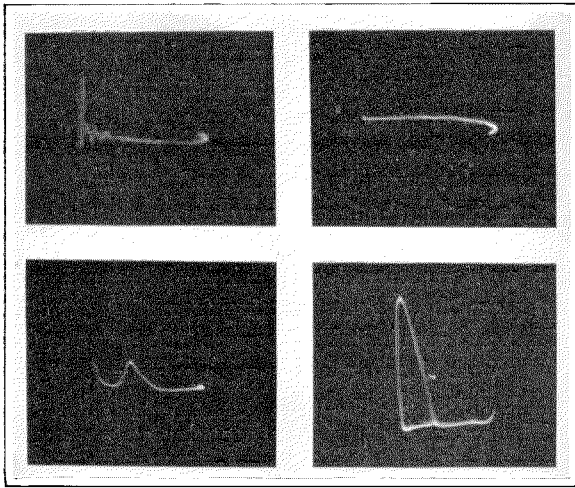

Fig. 6—Oscillographic Records of Inverse Current in a Hot Cathode Mercury Vapour Rectifier for Different Operating Conditions.

rectifier valves is generally between 15 and 5 volts. Fig. 4 shows the variation of the voltage drop of a given valve for various loads and mercury temperature conditions, and Fig. 5, the variation of the pressure of saturated mercury vapour versus the temperature of the condensed mercury. A voltage drop of more than 25 volts brings about the rapid deactivation of the cathode due to bombardment by positive ions of mercury.

The voltage drop in a hot cathode mercury vapour valve is affected not only by the pressure of the mercury vapour but also, for a definite load, by the volume of mercury vapour which becomes ionised when the rectifier carries current.

In valves having the construction shown in Fig. 1 in which ionisation takes place practically only inside the anode and cathode screens and not in the whole interior of the bulb, reducing the volume of ionised mercury vapour, or decreasing the section of the top aperture of the cathode screens, increases abnormally the voltage drop of the valve when the rectified current exceeds a definite limit, whilst the cathode emission may be considerably larger than is really needed. It may be said that for obtaining long life with sufficiently wide operating mercury vapour limits, the volume of the ionised mercury vapour should be at least 10 cubic centimetres per ampere of rectified current, and the density of the rectified current through the top aperture of the cathode screens should not exceed 0.5 to 1 ampere per

square centimetre, depending on the rating of the valve considered.

At the moment of the apparent extinction of the valve, i.e., the moment at which the characteristics of the rectifier cause the rectified current in the valve to pass through zero, two opposing phenomena occur:

- (1) The mercury vapour tends to return to its neutral state;
- (2) The inverse voltage applied between anode and cathode tends to re-ionise the mercury vapour.

It may be said very approximately that, if the first effect is preponderant, the tube will support the inverse voltage; but, if the second tendency is greater, the valve will not support the inverse voltage.

This explanation supposes that the arc-back is not caused accidentally as, for example, by the formation of a cathodic spot on the anode due to the presence of mercury spots in the anode region, or electronic emission of the anode due to the presence of barium or other impurities on its surface. Fig. 6 illustrates oscillographic records of inverse currents measured for different operating conditions on one of the rectifiers herein described.

Depending on the shape and amplitude of the rectified current and inverse voltage waves, the instantaneous and average values of the inverse current may vary tremendously. The initial value of the inverse current just at the moment

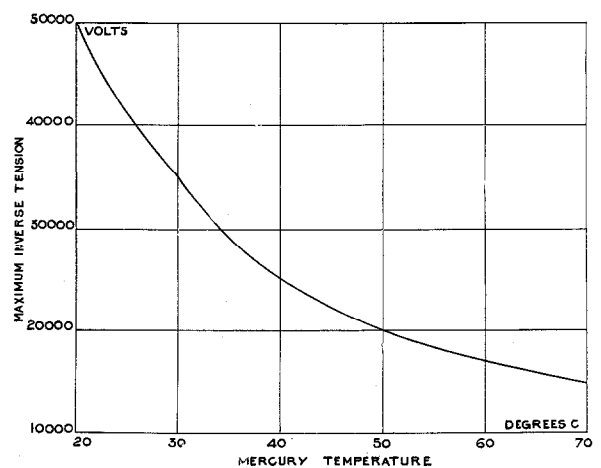

Fig. 7—Variation of the Maximum Inverse Voltage Supported by One of the Tubes Shown in Fig. 3 Versus the Temperature of the Condensed Mercury.

the inverse voltage starts to increase across the valve is usually considerably larger than the value of the inverse current during the remaining portion of the idle part of the cycle; generally, after a few milliseconds the inverse current drops to a very low value, whilst the inverse voltage applied across the valve continues to increase and passes through its maximum. In certain cases with very high inverse voltage and high mercury vapour pressure, the inverse current increases again and the curve shows a second maximum corresponding to the maximum of the inverse voltage wave.

Depending on the valve characteristics and operating conditions, the average value of the inverse current varies from  $10^{-4}$  to  $10^{-6}$  of the average value of the direct current whilst the peak value of the inverse current sometimes reaches  $10^{-2}$  of the peak value of the direct current.

Following the hypothesis set forth above: To increase the inverse voltage which can be supported by the valves, it is necessary to increase the speed at which the mercury vapour returns to its normal state and to decrease the influence of the inverse voltage on the speed of recombination. This may be accomplished by

- (1) Modifying the characteristics of the rectifier tube;
- (2) Modifying the wave shape of the rectified current, inverse current, and inverse voltage.

For example, following (1) above, in a given tube the speed of recombination may be varied by changing the pressure of the mercury vapour, by increasing the surface of the electrodes, by decreasing the volume of ionised vapour, or by providing auxiliary electrodes biased at suitable potentials. Such means are very efficient but if

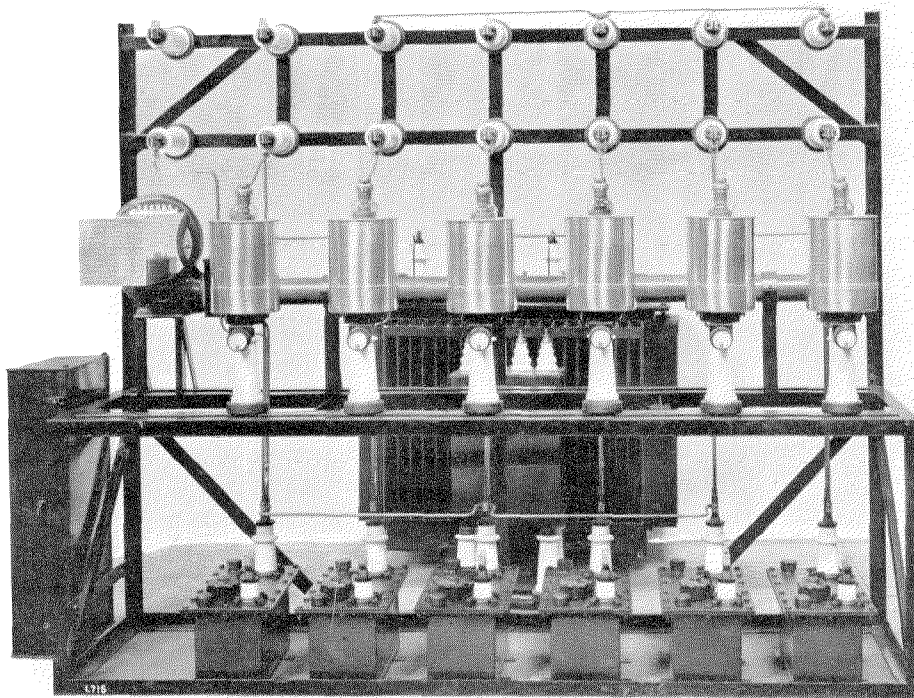

*Fig. 8—The Frame of a Six Tube Rectifier Unit Equipped with a Constant Temperature Air Blowing Device.*

not adequately adapted to the valve rating may considerably shorten the valve life; for, during the active and idle parts of the rectifying cycle, they may increase the bombardment of the active part of the cathode and cause its rapid deactivation.

The variation of the mercury vapour pressure caused by change in the temperature of the condensed mercury is one of the most important factors in the operation of hot cathode mercury vapour rectifiers. Too high a mercury vapour pressure is favourable to the operation of the

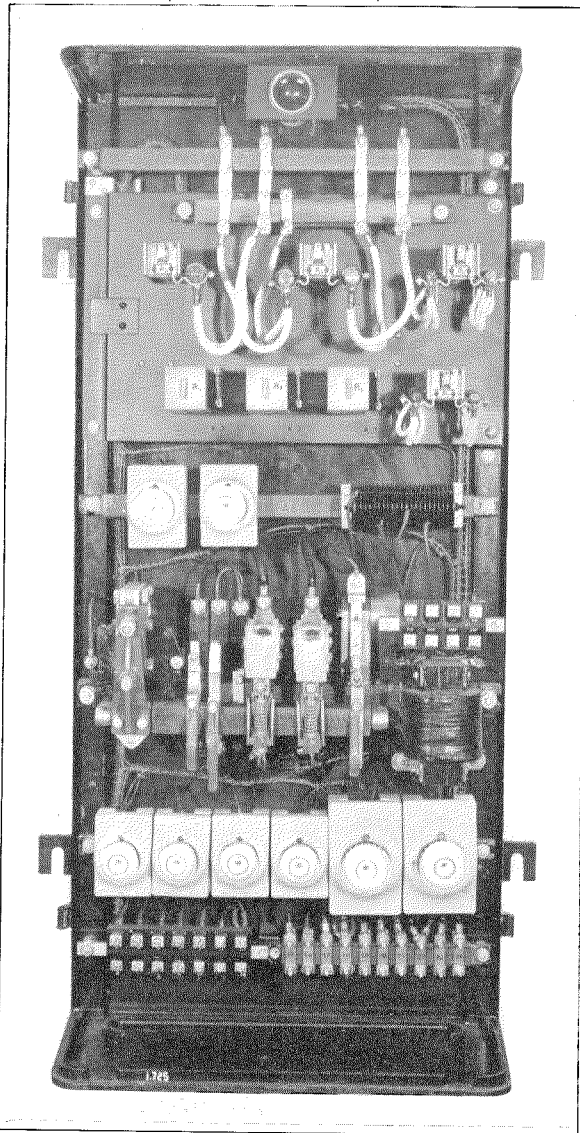

Fig. 9—Contactor Rack Used for the Control of the Constant Temperature Air Blowing Device Shown in Fig. 8.

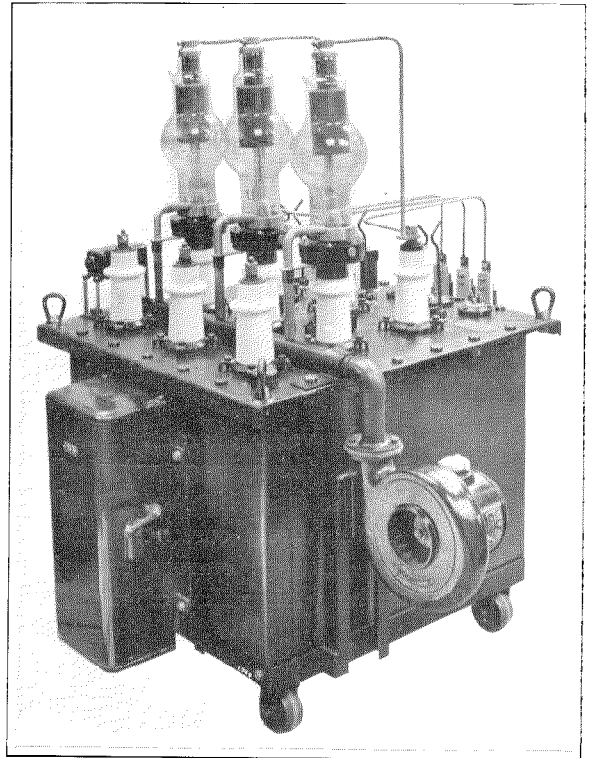

Fig. 10—10 KW. Rectifier Unit with Forced Air Cooling at Ambient Temperature.

cathode and, for a given rectified current, increases its life and decreases the voltage drop in the valve; but an increase of the mercury vapour pressure decreases the maximum inverse voltage supported by the valve and causes the valve to arc back. Fig. 7 gives an idea of the variation of the inverse voltage versus the temperature of the condensed mercury for one of the valves shown in Fig. 3. Contrariwise, an excessive decrease of the mercury vapour pressure increases the voltage drop above the critical value, causing abnormal bombardment of the cathode which results in its rapid deactivation. Furthermore, excessively low mercury vapour pressure is generally the reason for severe over-voltages which are sometimes encountered with mercury vapour rectifiers.

With nearly all hot cathode mercury vapour valves in general use, the temperature of the condensed mercury is about 10 to 15° C. above the ambient temperature, provided that free air cooling by natural convection is possible around the valve. The minimum and maximum operating mercury temperatures generally given to

satisfy the conditions mentioned above are  $20^{\circ}\text{C}$ . and  $60^{\circ}\text{C}$ ., respectively, depending on the current and inverse voltage ratings adopted, thus fixing the limits of ambient temperature between  $10^{\circ}\text{C}$ . and  $50^{\circ}\text{C}$ .

In order to maintain the operating temperature of large rectifier valves at the optimum value, a system of air circulation at constant temperature may be employed. The system is such that the temperature of the air blown on the coldest part of the rectifier bulb is kept within close limits; for example,  $\pm 2^{\circ}\text{C}$ . of the optimum temperature which is generally between  $30^{\circ}\text{C}$ . and  $40^{\circ}\text{C}$ . An air circulation system of these characteristics extends considerably the range of ambient temperature giving satisfactory operation of the rectifier, as it is obviously possible to maintain the optimum temperature on the valve for any ambient temperature below the maximum, which of course depends on the design of the rectifier valve used and on the load conditions.

A constant temperature air circulation system is particularly efficacious in cases of low ambient temperature as a few minutes of operation under

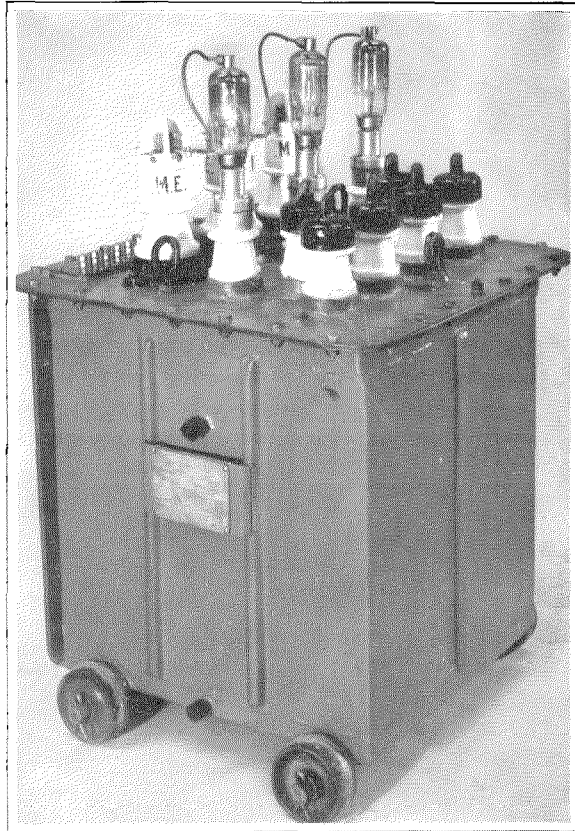

Fig. 12—3 KW. Rectifier Unit.

too low mercury vapour pressure would suffice to damage irremediably the emission of the cathode of hot cathode mercury vapour valves. Fig. 8 shows the assembly of a six tube rectifier unit equipped with a constant temperature air blowing device. It will be seen that the valves are supported by insulators fixed to the frame, the filament transformers being mounted below the valves. By means of a fan mounted on the left side of the frame the draught is forced to pass through heating resistances and is directed on to the valves through suitable piping and nozzles. Shields are placed around the valves in order to avoid irregular convection of the surrounding air in case of low ambient temperature.

The relays used for controlling the power dissipated in the heating resistances so as to maintain constant the temperature of the air blown are assembled on a rack shown in Fig. 9, which also contains the relays for delaying the application of the voltage to the anodes of the valves until the cathodes have reached their operating temperature at the starting up of the rectifier.

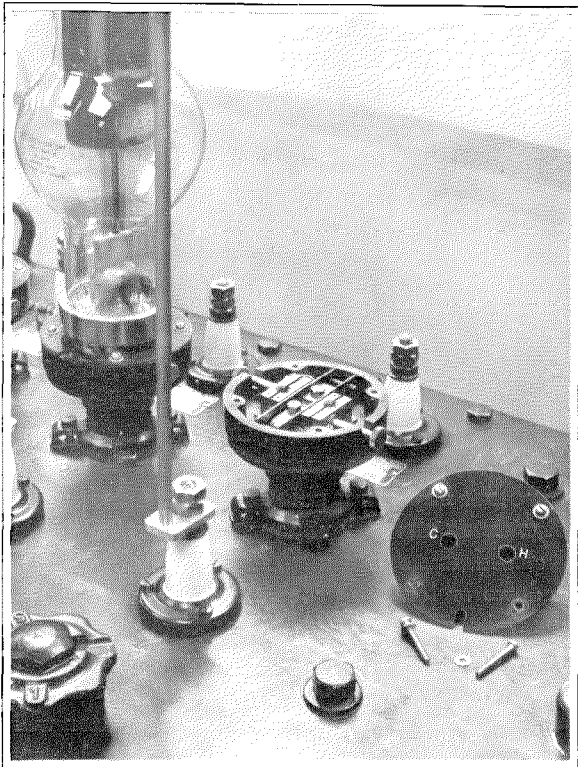
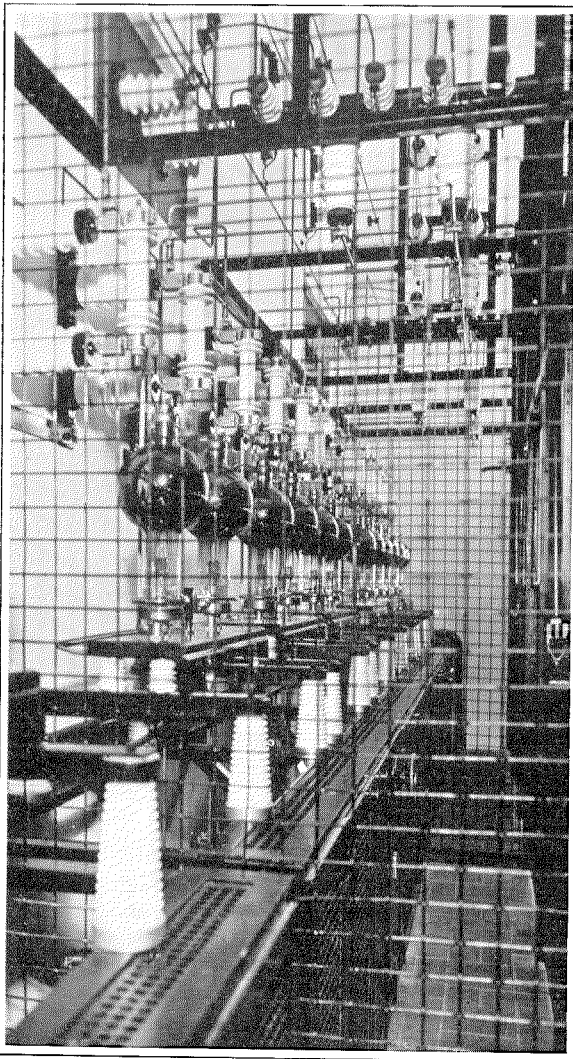

Fig. 11.—Special Socket for Mounting Hot Cathode Mercury Vapour Valves on Transformer Bushing.

Such cooling systems, which are essential for high power rectifiers or for special ambient temperature conditions, are of course not always needed. The rectifier shown in Fig. 10 is a complete and self-contained 10 kW. unit which, after being connected to suitable a-c. supply, is able to deliver smooth d-c. current. It comprises mainly an oil filled tank containing the filament heating transformers of the valves, the high tension transformer and the d-c. smoothing choke coils. The valves are mounted directly on the cover of the tank by means of suitable sockets sealed on the porcelain high tension bushings.

A contactor rack is mounted on the front side



*Fig. 13—250 KW. 20,000 Volt Rectifier Supplying the Plate Voltage to the Power Valves of the Kalundborg 60 KW. Broadcaster.*

of the unit and comprises the contactors, over-load relays, and time delay relay necessary for the operation of the rectifier. On the side of the unit is fixed a fan which, by means of appropriate piping and nozzles, blows air on the tubes at the ambient temperature. The fan is started automatically when the ambient temperature exceeds a fixed value, generally about 25° C., by means of a thermostatic relay seen on the left of the illustration behind one of the porcelain terminals.

Fig. 11 shows the details of the special socket used for mounting the valve direct on the bushing of the unit.

This type of construction in a self contained unit, as exemplified above, has proved to be highly economical and reliable for rectifiers from 3 to about 50 kW., and furthermore makes it possible to install rectifiers in cubicles as is done for high tension transformers.

Fig. 12 represents a 3 kW. rectifier unit of the same design but, in this case, no provision has been made for forced air cooling, air cooling by natural convection being considered sufficient for the output requirements and range of ambient temperature considered. Fig. 13 shows a 20,000 volt rectifier installed at Kalundborg, Denmark, for supplying the voltage to the anodes of the power valves of a 60 kW. broadcaster.

The air cooling conditions required by hot cathode mercury vapour valves are often overlooked, especially when they are mounted in closed cabinets or units. In such cases special care should be taken to insure that the real temperature of the condensed mercury is within the specified limits. The air temperature inside such units, after some hours of operation, may be considerably above room temperature and, in addition, the cooling of the valves by natural convection is obviously less when they are closely surrounded by other components of the equipment.

Another important point to be observed, when hot cathode mercury vapour valves are mounted in closed units is that the disposition of the windows or louvers provided for air circulation should be such that the incoming fresh air is blown or drawn in at the bottom of the unit rather than in front of the anode region of the bulb of the rectifier valves, since the latter will cause the mercury to condense in undesirable regions and consequently promote arc-back conditions.

Apart from the factors which directly affect the valves, such as the mercury vapour pressure, the cathode emission, voltage drop, etc., there are other factors which can affect their operation. For instance, by changing the characteristics of the rectifier circuit in which a given valve is used, it is possible to change enormously the manner in which the valve will support the inverse voltage; in other words, a given valve may operate perfectly in a certain rectifier equipment whilst, for the same output in another less suitable circuit arrangement, the same valve may arc back almost continuously.

As stated previously, in hot cathode mercury vapour valves, the residual ionisation during the idle part of the rectifying cycle is one of the important factors which affect the maximum inverse voltage they can support. At any instant of the working part of the rectifying cycle, the quantity of mercury vapour ionised in a valve depends on the instantaneous value of the direct current and, when the current decreases, the

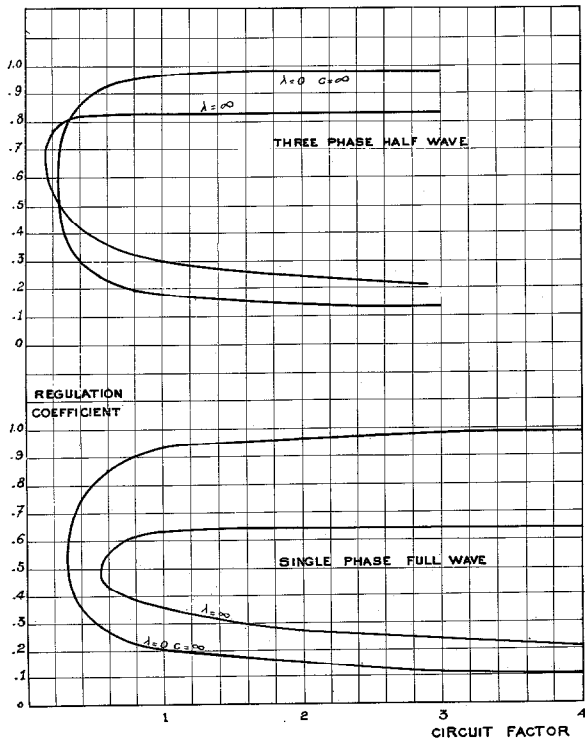

Fig. 14—Representing the Variation of the Fatigue of the Rectifier Valves in 3-Phase Half Wave and Single-Phase Full Wave Arrangements Versus the Regulation Coefficient of These Circuits for the Two Following Extreme Conditions: Filter Beginning with an Infinite Reactor or Beginning with an Infinite Condenser.

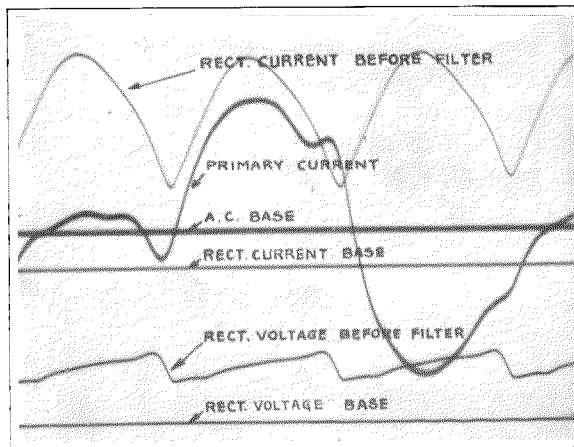

Fig. 15 A

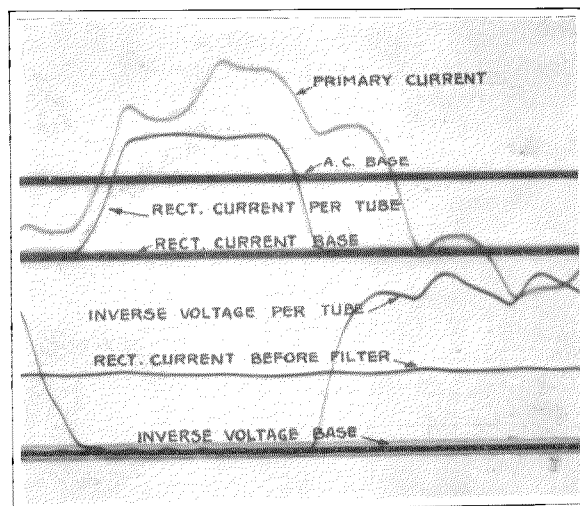

Fig. 15 B

Figs. 15 A and B—Primary Current, Rectified Current Per Valve, and Inverse Voltage Waves of a 10,000 Volt 12 Ampere, and a 5,000 Volt .5 Ampere Rectifier Under Load.

quantity of ionised vapour decreases also, but with a delay; and it is evident that, if the direct current stops abruptly, the deionisation time is longer than if the current decreases progressively. The wave shape of the inverse voltage applied to the tube can also change the speed of deionisation of the mercury vapour. If, immediately after the extinction of the valve, the inverse voltage increases very rapidly, its influence can easily become more important than that of the recombination of the mercury vapour.

These different considerations have inspired an attempt to evaluate the fatigue of rectifier valves in different operating conditions, the object being



to define the characteristics of rectifier circuits so as to give the most favourable conditions. The fatigue of a valve under given operating conditions has been defined arbitrarily as being a complicated function of the peak rectified current, peak inverse voltage, rate of change of the direct current, and inverse voltage just before and after the moment at which the direct current ceases to flow in the valve.

To illustrate one of the effects of the circuit characteristics, Fig. 14 gives in arbitrary units the variation of the fatigue of the rectifier valves for two conventional circuits in terms of the regulation coefficient of the rectifier circuits under consideration. For each type of rectifier circuit there is a minimum coefficient of fatigue and, evidently, it should be the aim to reach this minimum, which is in fact possible. It must be stated that it does not necessarily follow that conditions of high efficiency and good power factor cause less strain in the tube.

Another important factor which may affect seriously the behaviour of rectifier valves is that the maximum inverse tension which can be supported by mercury vapour valves decreases as the frequency of the applied alternating supply increases, the effect being due to the appreciable time required by the mercury vapour to become deionised. The maximum inverse tension in the valve increases rapidly after the cessation of the normal current, the rate of increase depending on circuit design, which can be modified. If, however, a high frequency voltage be superimposed on the low frequency which is to be rectified, the excitation of the mercury vapour will persist longer in the tube after the stoppage of the normal electronic current, so that the maximum inverse tension which can be carried by the valve will be reduced. Therefore, in rectifiers used for supplying anode voltage to high frequency amplifiers, as, for example, in radio broadcasting stations, it is absolutely necessary to avoid, by suitable filter circuits and screens, the picking up or the return of radio frequency on the rectifier valves.

The complete theory of mercury vapour rectifiers has been fully treated by several authorities and it is not within the scope of this article to reproduce the extensive calculations made. It is, however, of interest to insist on the influence of circuit design on the performance of rectifier

tubes; in particular, the effect of the transformer and filter circuits, since a frequent source of error has been to design a filter circuit without regard to its effect on the operation of the rectifier. In other words, in a mercury vapour rectifier, it is not only necessary to consider the factors which make up the characteristics external to but applying to the rectifier, such as regulation, power factor, efficiency, and suitability of the filter circuit; but, in addition, the influence of the rectifier characteristics and of the filter should be examined from the point of view of the operation of the rectifier valves themselves.

An effect which may arise and which may affect profoundly the operation of rectifier valves, is the tendency of the transformer feeding the rectifier to oscillate. This tendency is present because of the rapid change in the current passing through the transformer windings when feeding a rectifier. The greatest change takes place at the moment when the current in each winding, after passing through its maximum, decreases and then ceases abruptly; the value of the current change may be of the order of 100,000 amperes per

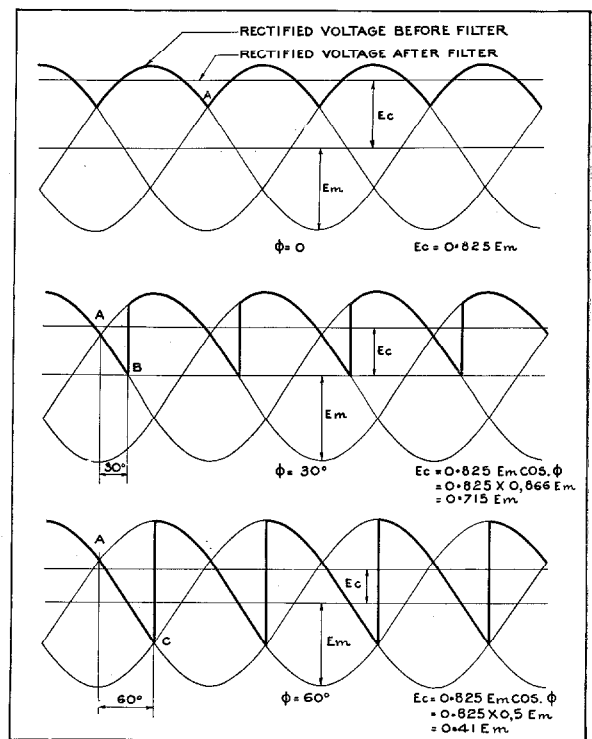

Fig. 16—Variation of the Wave Form of the Rectified Voltage of a 3-Phase Half Wave Grid Controlled Rectifier when the Firing Delay of the Grids is Increased.

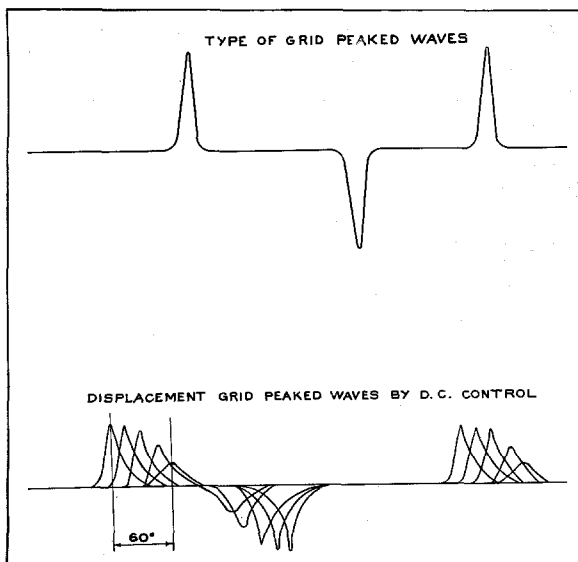

Fig. 17—Wave Shape of the Peak Wave used for Firing Grids and Displacement of the Peaked Waves by D-C. Control.

second for 500 kW. rectifiers. This abrupt cessation of current may excite oscillations in the transformer windings, always assuming that the windings are susceptible, and it may be advantageous on transformers used with mercury vapour rectifiers to adopt a system of construction used on so-called antiresonant transformers. It has been found, however, that the application of suitable damping circuits or surge absorbers is in most cases quite satisfactory in suppressing unwanted oscillations.

In order to protect the transformer winding from surges which might arise at the moment that the supply voltage is switched on to the transformer, the switching mechanism, which may be either a circuit breaker or contactor, should be operated in two or more steps. The first step switches on the power to the rectifier transformer through resistances, and the second step, which occurs shortly afterwards, short circuits these resistances. Fig. 15 shows oscillographic records of the a-c. current, rectified current, and inverse voltage of some of the rectifier units illustrated herein.

### Hot Cathode Mercury Vapour Grid Controlled Rectifiers

An important development of the hot cathode mercury vapour rectifier is the introduction of a grid electrode as a means of controlling the out-

put, but it would appear that the development of this type of rectifier is not as yet sufficiently advanced to permit regular operation for broadcasting services. However, it may be said that grid controlled hot cathode mercury vapour rectifiers will certainly be used extensively in the future, inasmuch as the added facilities they render possible, whilst not essential for rectifiers used for radio broadcasting, give greater flexibility to the equipment at reasonable cost.

The effects of a grid electrode as fitted to mercury vapour valves for high tension rectifiers are as follows:

- (1) To prevent the current from starting between anode and cathode, even when the anode is positive in respect to the cathode by a higher value than that which would have ignited the valve had there been no grid electrode. This result is accomplished by making the grid negative with respect to the cathode;
- (2) To cause immediate ignition of the valve, the anode being positive with respect to the cathode. This result is obtained by making the grid positive with respect to the cathode;
- (3) Once the valve is ignited, the ignition cannot be stopped, or the value of the rectifier voltage changed.

The above effects are well illustrated by the oscillograms reproduced in Fig. 16, which show the wave form of a rectified voltage recorded in front of the filter circuit of a three-phase rectifier assumed to be without voltage drop. The top curve shows the wave form from an ordinary rectifier without grid control, ignition taking place at *A*. The middle curve shows the effect of retarding the ignition from point *A* to point *B* by means of the grid, the angular displacement between points *A* and *B* being the angle of delay of excitation. In the lower curve the ignition is still further retarded to the point *C*. In both the last two cases the excitation of the grid was a positive peaked wave timed to occur at the right instant. Now the value of the grid electrode as a means of varying the rectified voltage is that, for a given angle  $\phi$ , the resultant output voltage will be equal to the output voltage given by the same rectifier, but without grids, multiplied by the cosine of  $\phi$ . It has been shown by the oscillograms

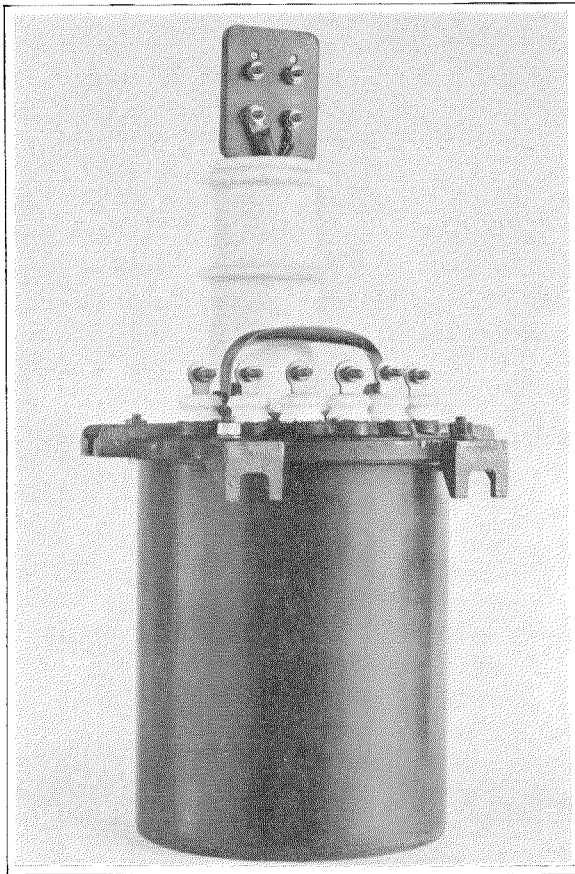

*Fig. 18—Peak Wave Transformer Used for Firing Grids of Hot Cathode Mercury Vapour Valves. The Grid Control Wiring is that Connected to the High Voltage Insulated Terminal. The Other Terminals are Low Tension A-C. Excitation and D-C. Control Windings.*

that the variation of angle  $\phi$  controls the mean value of the output rectified voltage. This variation is theoretically from zero to maximum for a variation in  $\phi$  from zero to  $90^\circ$ .

Furthermore, the effect of the grid is such that when it is connected to the cathode, or adequately biased, the valve will not ignite even when the anode is positive with respect to the cathode. As soon as ignition has occurred, the grid takes up a potential approximately that of the cathode until anode current ceases to flow as the applied voltage changes in sign. In every case, to obtain ignition of the valve, the grid must be given a positive potential for a very short interval of time.

The properties of the grid electrode afford an immediate protection for the valve itself and facilitate the operation of a system for limiting

and switching off overloads or short circuits, since it is only necessary to suppress the grid excitation in order to stop the further ignition of the valve.

Among the many systems possible for the excitation and control of grid controlled hot cathode mercury vapour valves, the system discussed below has been chosen as it does not include any rotating parts or moving relays. A peaked wave, as shown in Fig. 17, is used for the excitation of the valves.

The chief component required for the system of the production and control of this peaked wave is a transformer shown in Fig. 18. This transformer has a special magnetic system partly made of Permalloy, and is supplied with an a-c. voltage from the same supply as that to be rectified. A direct current passes through one of the windings and is used as a control. Each time that the a-c. wave through one winding changes in sign, the flux of the core is reversed and a peaked wave is produced in a third winding. If now the value of the direct current in the control winding is increased, the peaked waves are displaced with respect to the a-c. cycle. The effect is well illustrated in Fig. 17, which is a reproduction of an oscillogram of the output voltage of the transformer. In this case the peaked wave was displaced by  $60^\circ$  for a total change of 200 ampere-turns in the control winding. A further increase in the value of direct current has the effect of saturating completely the core system with the result that peaked waves are no longer produced and the grid controlled rectifier valves are no longer excited. The value of this principle of variation of output may be more closely understood by taking as an analogy a separately excited d-c. generator. In the case of the generator, the variation of the field excitation may be such as to vary the voltage output from zero to maximum. With a grid controlled rectifier using this special transformer, the voltage output may be adjusted by changing the value of ampere-turns in the d-c. winding, thus displacing the grid peaked waves. In the same way, it is equally easy to obtain compounding of a rectifier by passing a portion of the output current through the control winding. The power required for such auxiliary controls is about  $1/100$  of the power required in a d-c. generator to give the same facilities. Fig. 19

is a simplified schematic of a three-phase rectifier using grid controlled rectifier valves.

The auxiliary dry rectifier shown in Fig. 19 is supplied with a-c. power from the main supply, the output of the rectifier feeding into a potentiometer, which is in turn connected to the control winding of the transformer for producing peaked waves for the grid excitation. The object of this small rectifier and potentiometer is to give a control of the output by displacing the peaked waves and hence, as already shown above, changing the output. It is evident that the auxiliary rectifier and potentiometer might be replaced by a d-c. regulator such as is used to control rotating machinery and, in this way, constant voltage output could be obtained from the rectifier, and much more economically, inasmuch as the power capacity of the regulator need only be quite small.

Following the analogy of the d-c. generator, it will be shown that a grid control rectifier may be

compounded in a much simpler manner than is the case with a rotating machine. In the latter case, compounding is obtained by passing a portion of the output current through the field circuit in a direction and at an intensity required by the conditions. In the case of a rectifier, however, equivalent results may be obtained by using a fraction of the output power in the control winding of the peak wave transformer. The order of power required to give complete control is from 0.1% to 0.001% of the rectified power.

Probably one of the most valuable features which can easily be applied to a grid control rectifier is the facility for breaking overload conditions instantaneously. In this respect the analogy of the d-c. machine cannot be followed since the system used for a grid control rectifier is infinitely more simple and flexible. In considering the case of a machine, it is well known that auxiliary means have to be provided for tripping

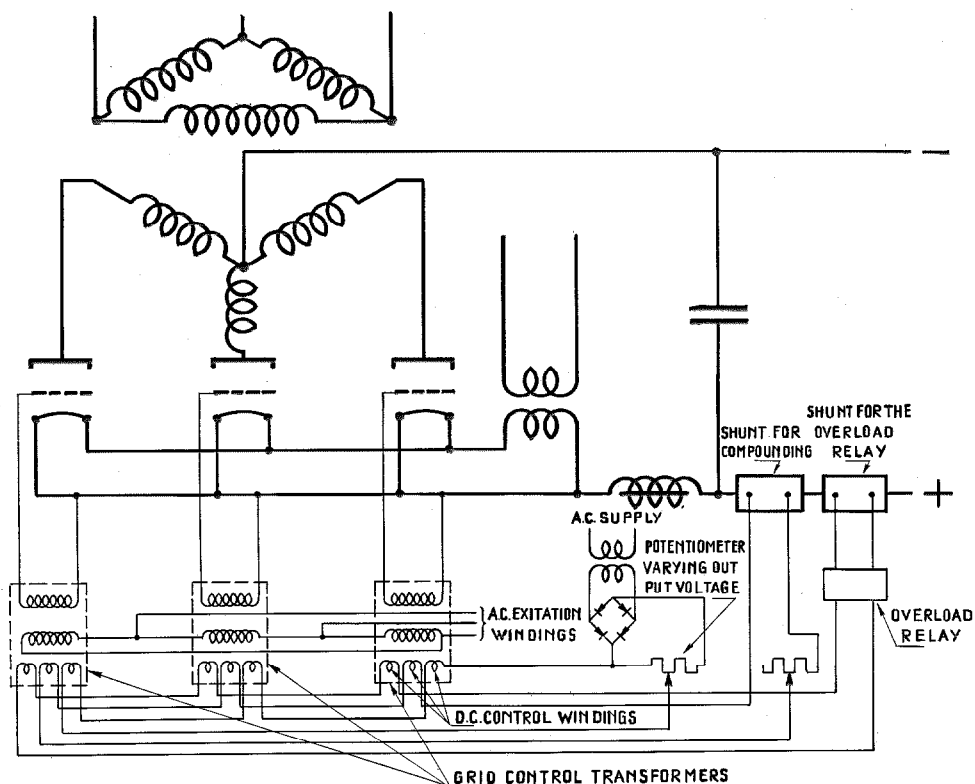

Fig. 19—Simplified Schematic of a Grid Controlled 3-Phase Half Wave Rectifier.

a short circuit or overload and such means are generally relatively slow-acting and expensive. On the other hand, the grid control rectifier requires but the suppression of the grid excitation for achieving the same object and this with a speed greatly superior to that of the associated equipment of the machine.

In the system under consideration, which is free from moving parts, the tripping device consists of a mercury vapour relay in a special circuit arrangement comprising a Wheatstone bridge, one of the arms of the bridge being connected to the load circuit. The arrival of a short circuit or overload upsets the balance of the bridge and instantly sets the valve relay into operation, this, in turn, suppresses the grid excitation of the main rectifier which immediately ceases to function.

In systems in which mechanical devices are permitted, the valve relay is replaced by a small mechanical relay having very low inertia and capable of operation at high speed. On the occurrence of a short circuit or overload, the relay operates and suppresses the grid excitation.

Such systems may be arranged to break down short circuits in less than 20 milliseconds and, since high voltage rectifiers used for radio transmitters include important smoothing circuits, the overload relay suppresses the grid excitation of the valves before the rectified current fed into the smoothing circuit has appreciably increased, whilst the transient output current of the filter is several times the normal.

### **Conclusion**

The possible varieties of rectifiers using hot cathode mercury vapour valves are extremely numerous since different combinations and numbers of valves may be used in many different types of circuits. The fundamental advantages of

a rectifier using hot cathode mercury vapour valves are simplicity and low first cost; the reliability is very good but is, of course, handicapped by the necessity for valve renewal. Unlike the arc pool type, the failure of a valve does not cause an interruption in the service, and a failed valve is, in any case, quickly replaceable. The low initial cost of the rectifier permits the addition of spare equipment without making the whole installation uneconomic.

To sum up, therefore, the general characteristics of the most popular types of rectifier dealt with above, it may be said that the efficiencies and power factors are of the same order for all three types, so that the annual power cost is about the same. The continuously evacuated tank type rectifier has a high initial cost compared with the other types under discussion; the continuity of service of the tank type is less liable to interruption but should interruptions occur, they are likely to be of much longer duration. The provision of a duplicate rectifier as a standby is comparatively prohibitive in cost and the routine maintenance required by the tank type is greater and necessitates a higher degree of competence.

The comparison of the arc pool rectifier with the hot cathode rectifier would show that the initial cost of a simple rectifier is about the same in both cases, but that provision for sufficient spare equipment to insure continuity of programme shows a balance in favour of the hot cathode type.

Of the three types it may be said that the hot cathode rectifier shows promise of the greatest development since it is of comparatively recent origin. The trend of development will be mainly towards more powerful valves operating at higher inverse voltages. These features, combined with long life, will largely remove the chief disadvantage of valve renewals.

# The Automatic Radio Compass and Its Applications to Aerial Navigation

By H. BUSIGNIES

*Les Laboratoires Le Matériel Téléphonique, Paris, France*

**SUMMARY:** *This article discusses the general principles of radio compasses; it describes the R.C. 5 Radio Compass and applications to aerial navigation. Comparison is made with other methods of navigation by radio, and applications of the radio compass in France and other countries are indicated.*

TEN years ago initial efforts were made to develop a radio compass system, then called "Hertzian compass," in which the angles indicating the position of a radio transmitter appeared automatically on a graduated scale, similar to the scale of an ordinary magnetic compass. Two years later, more complete studies were undertaken and rough models and testing apparatus were constructed. A first working model was then made and the essential principles established.

The apparatus described in this article is, therefore, the outcome of an old idea that had been developed over a period of several years. This idea had previously found practical application and was taken over to suit the needs of aircraft.

Thanks to the collaboration of the French Air Ministry, it was possible to make trial installations which were given exhaustive tests and which proved that the conception of the apparatus was sound. As a result, commercial production was commenced.

## **General Principles of Radio Compasses**

The essential aim of a radio compass is to indicate the direction of a radio station and, fixed on board an airplane, it indicates the direction of a station by showing the angle made by the direction of this station with the airplane's axis.

An automatic and unbroken visual indication of the direction of a radio station with respect to an airplane has numerous advantages in navigation. By eliminating manual operation, navigation is made simpler and the chances of error, due to non-automatic and thereby intermittent indication, are reduced.

Under normal conditions, natural landmarks, villages, houses, or other prominent indications are often sufficient for navigation, the necessary information being transmitted to the human eyes by light waves. The automatic radio compass with its continuous visual indication of the position of a distant and unseen radio transmitter in effect increases in a simple way this visible horizon of the pilot.

We find in nature a similar extension of the horizon. Naturalists think that carrier pigeons and migrating birds navigate by using waves of a nature and in a manner unknown to us.

The radio compass has other applications which will be indicated hereinafter.

## **Description of the R.C. 5 Radio Compass**

*Principles.* Le Matériel Téléphonique, Paris, has constructed a radio compass indicating the direction of a transmitter on a dial graduated in degrees completely around the circle. So far as is known, radio compasses built subsequently by others indicate merely the deviation of the airplane from its proper direction: if the plane be headed towards the left, the needle indicates "left"; if the plane be headed towards the right, the needle indicates "right," but no indication is given to the pilot as to how many degrees the plane has turned.

The radio compass herein described is, in fact, an automatic radio goniometer: it indicates the direction of chosen transmitters which may be situated all around the plane. More varied applications are thus possible than in the case of an instrument showing only the direction to the left or to the right of the axis of the airplane.

The apparatus is based on the following prin-

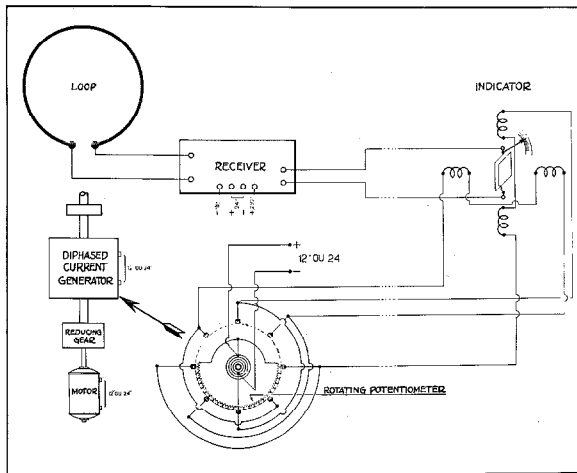

Fig. 1—Schematic Layout of Equipment.

principle: a receiving loop aerial turning regularly around a vertical axis permits maximum reception every time that the plane of the loop passes in the direction of the transmitter. If the loop turns regularly at a certain speed, a certain number of maxima and minima of receptions per second can therefore be observed in a receiver tuned on a transmitter.

A rotating speed of five revolutions per second has been chosen. Maxima and minima of receptions, therefore, take place at the rate of ten a second.

The phase of these maxima and minima, i.e., the moment at which they occur in connection with a given origin, depends on the direction of the transmitter in relation to the axis taken as origin. If the loop turns regularly, these maxima always appear when the plane of the loop points in the direction of the transmitter. If the location of the transmitter changes in relation to the radio compass, the minima and maxima phases also change. This changing of phases is utilised in the apparatus to obtain the automatic indication.

The high frequency waves received in the loop pass through amplifier, detector, and low frequency amplifier stages in the receiver. In the output stage a variable current, representing the maxima and minima of reception, with phases identical to the phases of the wave received, is thus obtained. To obtain the measurement of phase in the indicating instrument, it is necessary to adopt a determined origin. This origin is obtained by placing on the rotating axis of the

loop a diphased current generator, the phase of which is constant in relation to the revolutions of the rotating loop.

The variable current obtained at the output stage of the receiver, representing the maxima and minima of reception caused by the rotation of the loop, and the diphased currents from the generator are fed into a special, improved phasemeter. The diphased current creates a rotating field in a magnetic stator, comparable to the stator of a synchronous motor. This field rotates at a speed double the speed of the loop. The variable current from the receiver actuates an armature carrying a pointer associated with a dial. In this armature, therefore, an a-c. current is produced by the rotation of the receiving loop and, in the stator, a fixed phase rotating field by the diphased current generator. Thus the magnetic reactions of one flux on the other give a definite position to the armature, which sets itself perpendicularly to the flux when the current going through it is maximum, thereby indicating the phase looked for and, as will be evident later, the direction of the transmitter.

*General Layout.* Fig. 1 shows a schematic layout of the equipment. As indicated, the receiving loop is connected to a detector-amplifier receiver. The variable d-c. current, proportional to the signal, passes through the armature of the indicator. To simplify the diagram, the entire indicator dial has not been reproduced but merely the needle and a portion of the dial. In reality the needle is fixed and the entire scale rotates.

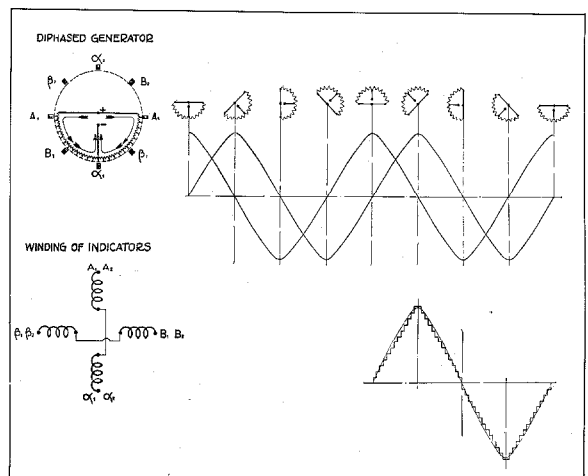

Fig. 2.

## AIRPLANE AUTOMATIC RADIO COMPASS, TYPE RC-5

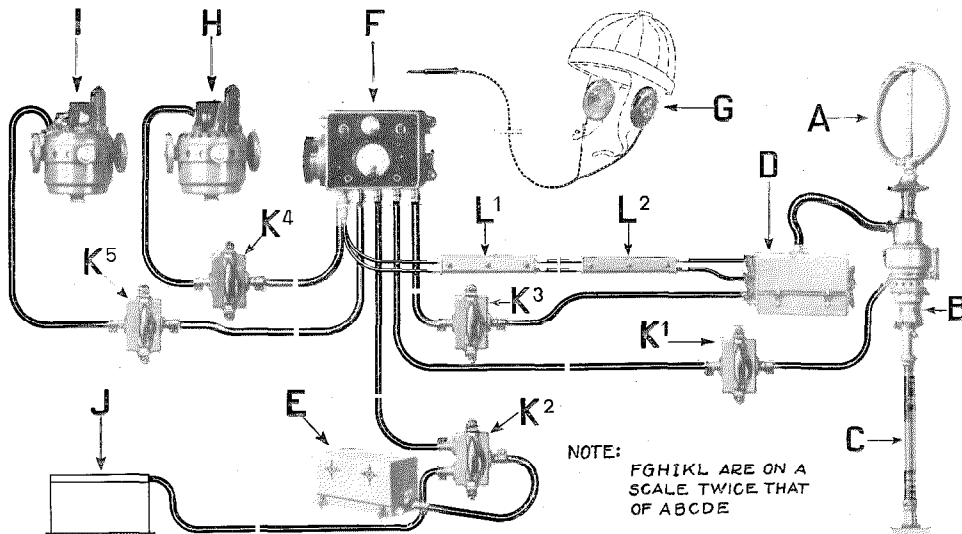

Fig. 3—Airplane Automatic Radio Compass, Type R.C. 5.

The diphased current generator, reduction gear, and the motor for driving the loop at constant speed also are shown.

The diphased current generator consists of a revolving potentiometer, fed by d-c. current, rotating regularly between fixed brushes. These brushes represent alternately opposite points of maximum positive or negative potential, and pass through all intermediate values in such a way that the result is the production on these brushes of an angular potential waveform which is rendered sinusoidal by the inductance of the stator of the indicating apparatus. Accordingly, an indication can be obtained at any distance, as only one simple electric link between the indicator and the other parts of the equipment is employed.

The potentiometer is neither continuous nor circular, but consists only of half a circumference since there are two maxima and two minima for each revolution of the receiving aerial, i.e., two periods of the variable current at the output-stage of the receiver for each one revolution of the loop. In order to synchronise the diphased currents with the variable current at the output-stage of the receiver, it is necessary that they

should have the same frequency as the variable current. It is, therefore, necessary to double the rotation speed of the rotating magnetic field by doubling the frequency of the diphased currents relatively to the rotating frequency of the loop. When the loop rotates five times per second, the frequency of the output current of the receiver is 10 periods per second. The diphased current generator rotating at five revolutions per second also produces a current of 10 periods per second, because its current is collected on a half circumference, and because the number of brushes is eight, the brushes being fitted at  $180^\circ$  and commoned in pairs. The current reversals are twice as great as would be the case with four brushes and one complete circular potentiometer.

The brushes, bearing on brass segments, are connected to a resistance. There is thus formed on the segments a potential which may be represented by the lower curve of Fig. 2. This curve is simply due to the passing of the brushes from one segment to the other. The continuous line represents the nearly-sinusoidal current obtained when applying to a large inductance a tension of the above form and, in this case, to the stator of the indicator.



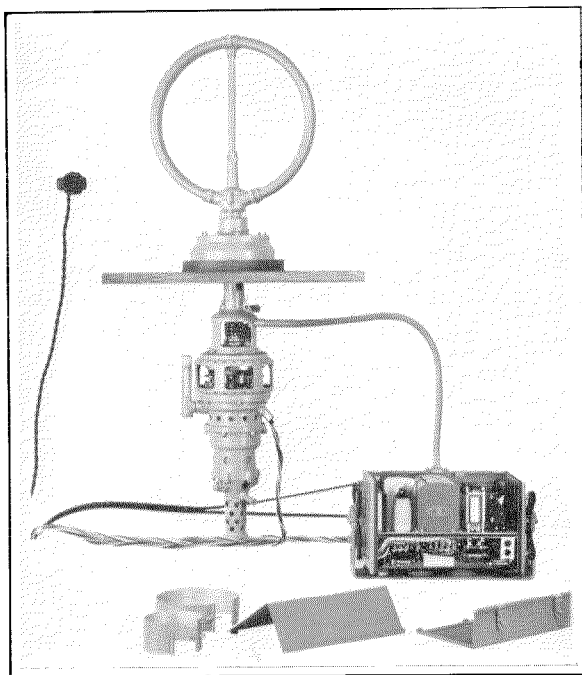

Fig. 4—Loops and Receiver with Covers Removed.

The upper part of Fig. 2 shows the diagrams of the diphased currents in the successive positions of the resistances.

In the indicators, the magnetic reaction of one flux on the other causes the armature and dial to take up a steady position and thus to indicate the direction of the transmitter in connection with a predetermined origin. This origin is simply the setting which exists between the diphased generator and the receiving loop: by modifying this setting by mechanical means, the origin can be modified as desired and the indicators can be made to show the zero angle when the airplane is heading towards the transmitter.

The indicator not only utilises the current maxima to show the direction, but it also entirely integrates the variable current due to the signal. Therefore, the sensitivity is very high and the stabilising of the indicator is proportional to  $\sin \alpha$  ( $\alpha$  being the angle through which the armature might be artificially pulled out of position).

This integration of the effects of the variable current is due to inertia of the armature. However, the inertia has been so limited that the armature vibrates at 10 periods per second on about  $\frac{1}{4}$  of a degree, which considerably lowers the initial friction of the pivots and has the added

advantage of allowing the observer immediately to detect a possible "dead" receiver or any other fault which may occur.

*Description.* Fig. 3 gives a general view of the equipment. The indicating apparatus and the control units are shown on a scale double that of the loop. "A" represents the receiving loop. Beneath it, the high frequency collector, which gathers the currents generated in the loop and, also, the high frequency transmission line leading to the receiver are mounted. "B" represents the small generator, the reducing gear, and the motor operating the receiving loop.

The receiver *D* and the rotating loop *A* are entirely remote-controlled by a small control unit, comprising simply the mechanical remote tuning of the receiver, a volume control to adjust the signal intensity, and a main "on" and "off" switch which, in a third position, starts the rotation of the loop.

Two indicators can be utilised. One is called "navigator's indicator" and the other, "pilot's indicator." In the first, the indication is read on a movable dial graduated in  $360^\circ$  and moving in connection with a fixed pointer. In the second, the indication is limited to plus or minus  $15^\circ$ .

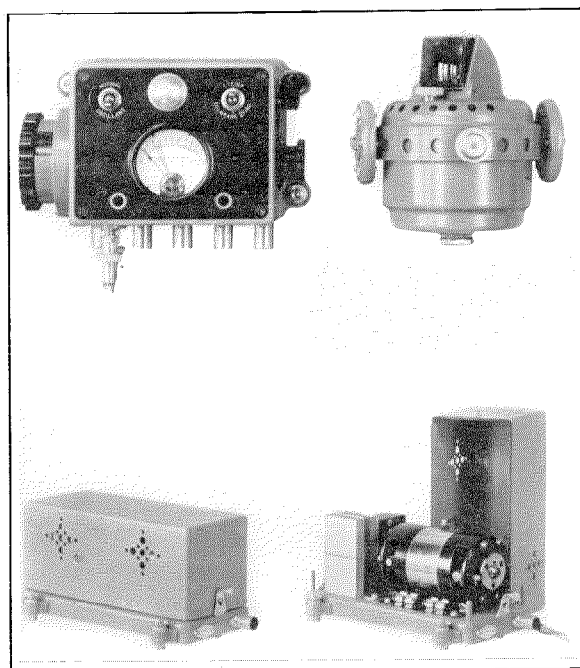

Fig. 5—Control Unit with "Navigator Type" Indicator (Upper portion of illustration); Converter (Lower portion of illustration).

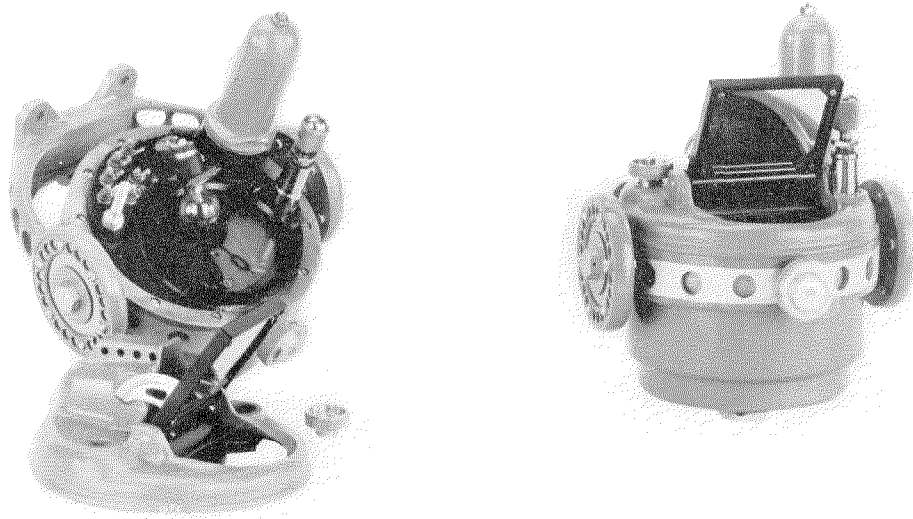

Fig. 6—"Pilot Type" Indicator.

The first is called "navigator's indicator" because it allows any of the crew of the airplane taking bearings to determine the position of the plane in relation to any given transmitter located around the plane.

The second is specially limited and designed for flying toward any given transmitter, and especially concerns the pilot. It represents an important advantage over the so-called "homing" systems, and permits correction for drift.

By means of this indicator the pilot can modify the reference axis by  $\pm 15^\circ$  in such a way that by altering his pointer the same amount of degrees as the angle of drift he can still steer with his indicator on zero and thus fly a great circle course directly to the transmitting station. This would not be possible with a so-called "homing" device. In fact, for this facility, it is necessary that the indicating apparatus itself indicate angles and that it be not limited to indicating a movement to the left or to the right.

In Fig. 3, *E* represents the converter for the anode high tension. This converter is fed by the storage battery *J*.

The units  $L_1$  and  $L_2$  permit rapid disconnection of the remote control, and the junction boxes  $K_1$ ,  $K_2$ , etc., allow very rapid replacement of any

part of the apparatus by a standard, identical part.

Fig. 4 shows in a more detailed manner the receiving loop of .3 metre diameter which, to the best of the writer's knowledge, is the smallest of its kind. Its aero-dynamic drag in a wind of 170 km. per hour is about 3 kg., and this drag only increases by 100 or 200 grammes when the loop is rotating.

The receiver is shock-proof mounted.

In Fig. 5 is shown the control unit with the remote control tuning dial on the left, and the milliammeter showing the current generated by the signal at the centre; also the navigator's type indicator, which is movable in all directions to facilitate reading of bearings. For the same reason, the position of the magnifying glass also can be changed.

The lower part of Fig. 5 shows the small rotary HT converter for the receiver. The radio compass is entirely fed by the airplane's battery, 24 or 12 volts, and will operate correctly with a current variation of  $\pm 15\%$ .

Fig. 6 shows the "pilot's indicator" permitting correction for drift. This indicator is constructed especially to make readings for the pilot as simple as possible and differs from the navigator's

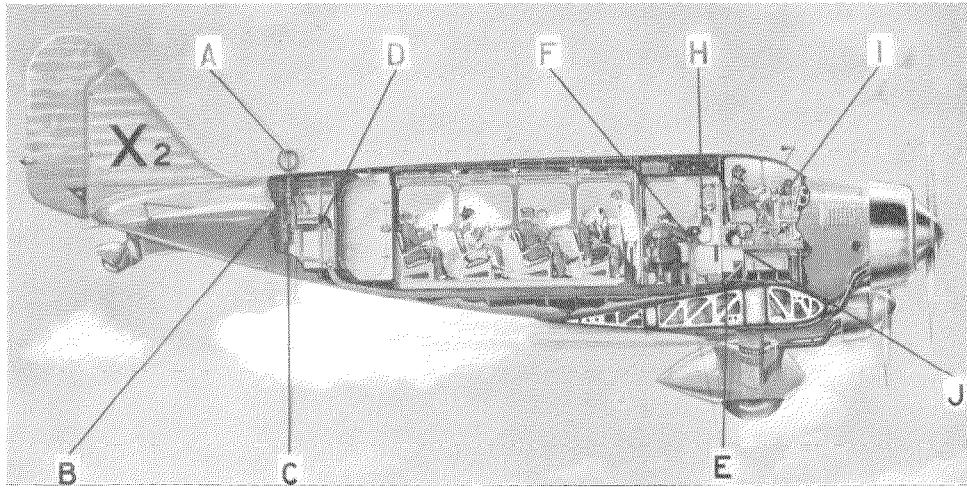

Fig. 7—Installation of R.C. 5 Radio Compass on an Airliner.

indicator with its  $360^\circ$  scale. When piloting, it is difficult to maintain an indicating graduated dial on a predetermined value and pilots prefer to keep a needle in one position without figures, even if they have to do the setting by other means. It is this principle which is used here.

The reading is made directly by means of a needle associated with green and red sectors, the dead centre indicating the plane's position when flying towards the transmitter. These sectors can be moved  $\pm 15^\circ$  by means of a control knob and allow correction for drift. The position of the needle can be read either directly, or by means of a mirror in case the apparatus is placed high enough on the dashboard.

The radio compass does not itself indicate the "sense" of direction. It will be shown later that there are several ways of eliminating this  $180^\circ$  ambiguity.

The total weight of the apparatus without the wiring is 22 kg. Depending on the size and type of the airplane, a few kilogrammes must be added for wiring.

#### **Applications to Aircraft Navigation**

Installation on board airplanes gives rise to a certain number of problems. The first is the deviation of the waves due to the metal parts of

the airplane or to the closed circuits formed by them. These deviations are constant and cause errors in bearings which may be as much as  $\pm 10^\circ$  or  $15^\circ$ . Nevertheless, by choosing the proper location for the loop it is possible to reduce these deviations to a small figure, sometimes even to zero.

Let us take as an example the case of an all metal high wing monoplane: At certain positions on wings or fuselage, the refractions of the wireless waves will be at a minimum. Therefore, it is essential to install the loop-aerial at one of these positions, provided, of course, that the position of the receiver inside the plane will permit. With the exception of the loop-aerial and receiver, the relative positions of which are governed by the fixed length of the transmission line connecting the two, all other parts of the equipment can be installed at the most suitable places.

In the case of low wing airplanes, deviations cannot always be avoided. However, as the deviation is nil at right angles to either the longitudinal or athwartship axis of the plane and rises to its maximum only at a  $45^\circ$  angle to these axes, this constant error can be corrected by reference to a very simple correction curve.

Fig. 7 gives an example of an installation, using the same reference letters for the various parts

as in Fig. 3. It shows a case where the frame and the receiver are installed in the tail of the airplane. Sometimes there is not much room to spare, even for small apparatus, in the pilot's cockpit, and this is especially true in transport airplanes where the pilots are in front and the radio operator directly behind them.

The control of the equipment is solely effected by the remote control unit, and the indication is

given at the most suitable points in front of pilot and navigator by means of their respective indicators.

*Accuracy.* The guaranteed accuracy of the apparatus is  $\pm 2^\circ$  for a distance of about 500 km. from a 300 watt transmitter. The receiver is extremely sensitive and, in most cases, this sensitivity is not fully employed. In fact, from the point of view of accuracy, it is difficult in an

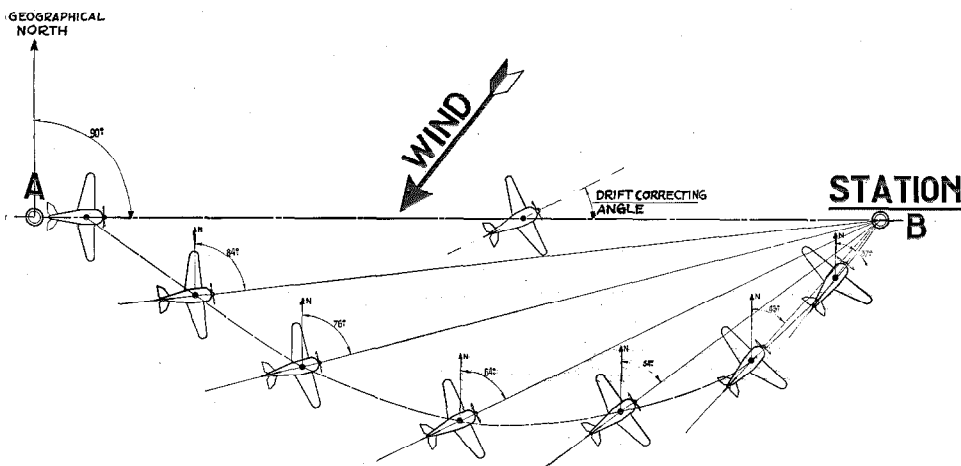

Fig. 8—Exaggerated Curve Illustrating Drift Due to Wind.

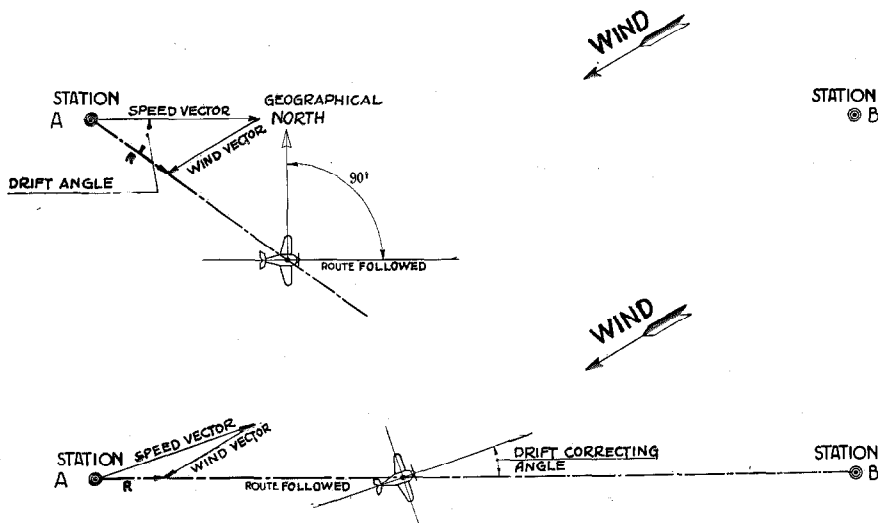

Fig. 9—Deviation Research with a Radio Compass.

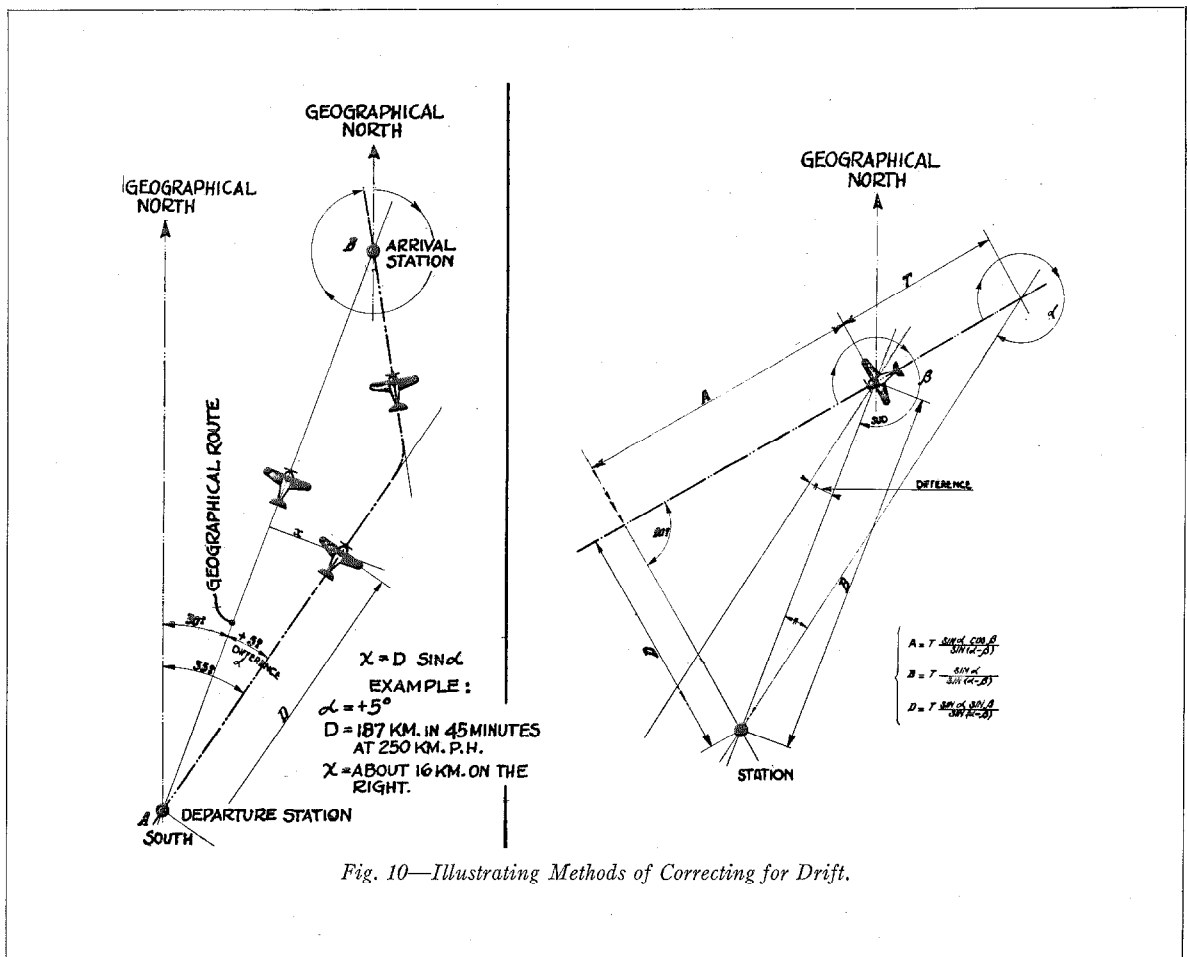

Fig. 10—Illustrating Methods of Correcting for Drift.

airplane to navigate within  $1^\circ$  to  $2^\circ$  and, therefore, this figure is fully satisfactory for aerial navigation.

Due to the well-known errors in magnetic compasses, such as the northern turning error, etc., it is difficult to keep an airplane on a steady course by means of a magnetic compass alone. The great stability of the R.C. 5 indicators, therefore, considerably facilitates the keeping of a correct course. In this connection it should be noted that the indicators allow for a plane, an inclination of about  $30^\circ$  without producing a fault greater than  $1^\circ$ .

The above reference is not meant to be a criticism of the utilisation of the magnetic compass which, so far, is an indispensable apparatus, but it is desired to show the advantages offered by navigating directly with the indications of the radio compass. Furthermore,

the utilisation of the magnetic compass can always be combined with that of the radio compass.

*Interference.* As indications are given automatically, an important point is the question of interfering transmitters. When using the equipment on broadcast transmitters, interference is not to be feared, due to allocation of wavelengths. When utilising weaker transmitters, no difficulty has ever arisen, owing to the selectivity of the receiver.

Very exhaustive experiments have been made on this point. Two stations of the same power were used, situated  $90^\circ$  one from the other, which is the worst case as regards interference: the frequency of one station was varied in order to note when it would start and when it would stop interfering with reception of the station having a fixed frequency.

A difference of 1 kc. between the frequencies of the transmitters is sufficient to give a correct indication on the fixed frequency transmitter. However, interference, if any, can both be seen and heard, and thus the operator is warned against the use of such indications.

The range of powerful broadcasting stations is, of course, much greater than that indicated for the small power stations. Through a station like Radio-Paris (60 kw.), it is possible to work the R.C. 5 radio compass as far as 2,000 km., and even more, at sea. In fact, ranges at sea are much greater for a given power than on land.

*Night Effect.* Like all radio direction finders, the apparatus can be affected by the "night effect" produced by the fact that at night the radio direction finder receives two or more waves: the direct wave following the curvature of the earth, and the indirect waves being reflected by the ionosphere. On land this error starts at about 70 to 100 km. from transmitters employing ordinary antennae; at sea, the error starts at greater distances: 200 or 300 km.

In order to reduce this error on land, numerous means of transmission can be employed. Transmitters utilising an aerial strictly vertical or an "anti-fading" antenna, considerably reduce these errors and the operating range increases by 200 km., which is sufficient in most cases where the radio compass is utilised. It is possible to navigate by utilising stations situated one after the other without having to take, when starting, the most distant station.

The question is often asked as to which stations can be utilised:

First, the numerous broadcasting stations which, situated near big cities, form a close net of Hertzian beacons for navigation over great distances.

Second, all radio beacons of any transmission system, directive or not, for air or sea navigation. The radio compass will indicate their direction, the same as in the case of an ordinary transmitter.

Airport stations can also be utilised. On receiving a call from an airplane, they can transmit for some ten seconds at regular periods to direct the airplane towards the airport.

If necessary, further non-directive transmitters can be installed on regular air routes to serve as beacons.

In this connection, it should be stated that

modern broadcasting stations utilise the so-called "anti-fading" antennae, which also avoid the night error.

The pilot and the navigator must have a small map of their flying area, giving them information on the transmitters that can be utilised, as well as their range without night error, their power, and their normal wavelengths.

### *Navigation with the Radio Compass*

The easiest method of navigating with the radio compass consists in tuning the radio compass on a given station situated at the aerodrome of destination, and then to operate in such a way that the indicators show the angle as  $0^\circ$ . In this way, the airplane always flies in the direction of the station and, if the wind is nil, it flies in this direction along a great circle. In most cases when drifting by wind, a curve is traced that pilots and navigators call the "drift-curve."

Fig. 8 illustrates such a curve. An airplane equipped with a radio compass always has its axis directed towards station B, but the wind causes deviations from the course and should be allowed for. On such a curve, it is easily seen that the angle indicated by the magnetic compass, i.e., the magnetic course followed by the airplane, constantly changes; and, therefore, the true course of the plane also constantly varies. It should be noted that this curve is exaggerated

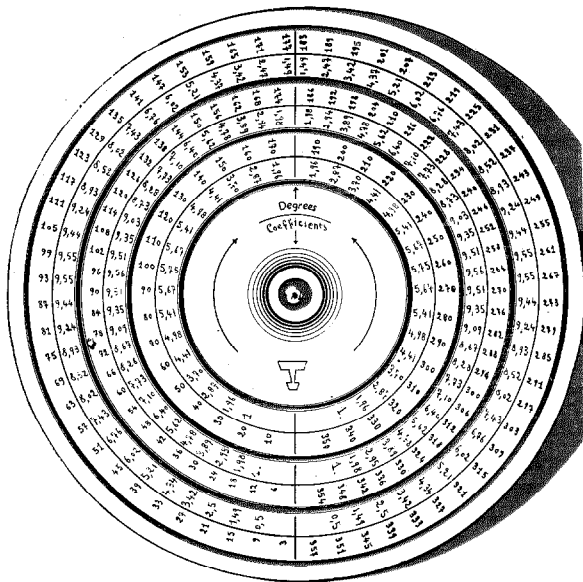

Fig. 11—Calculator.

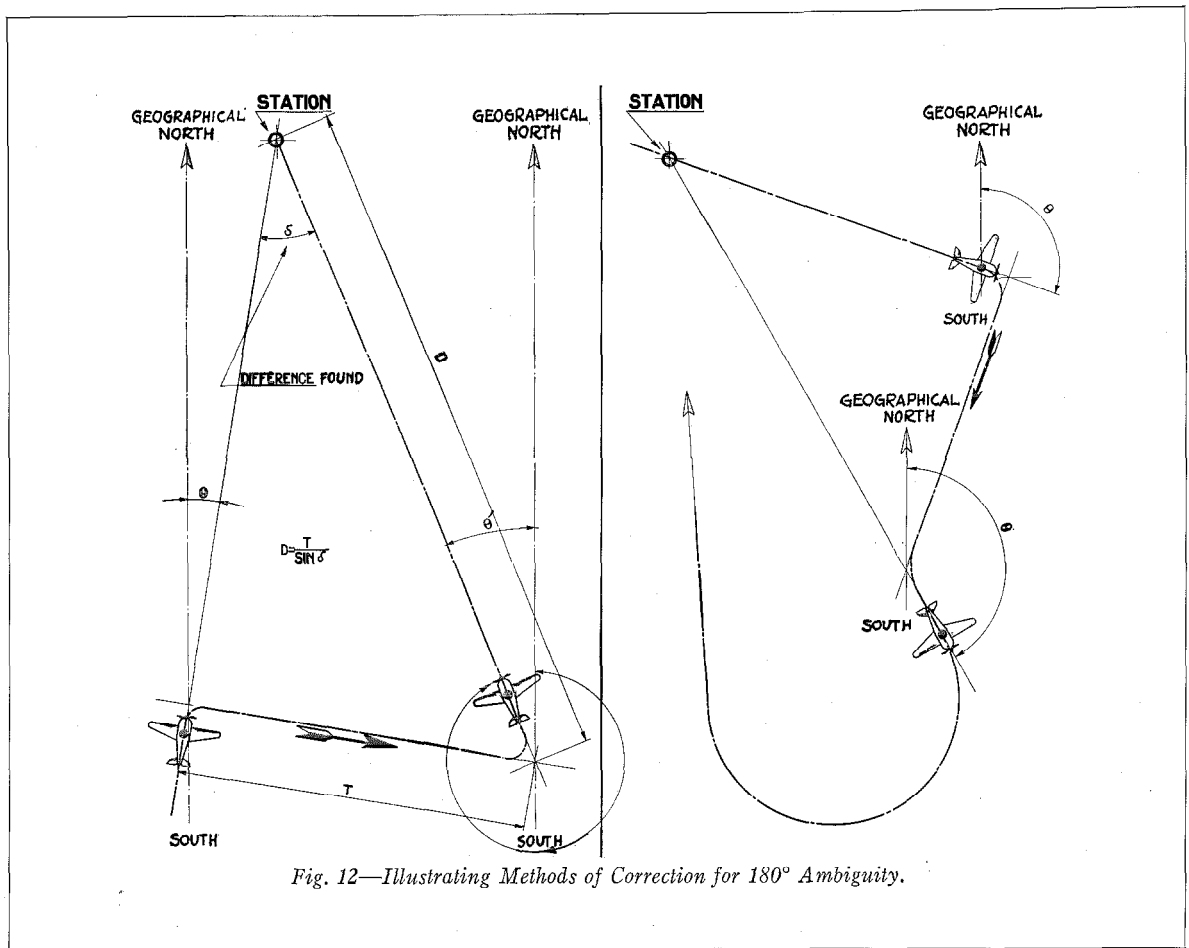

Fig. 12—Illustrating Methods of Correction for 180° Ambiguity.

for illustration purposes. The true course varies from 90° to 54° and in the end the airplane reaches the station in the wind's direction on a 37° true course. If it reaches the transmitter's aerial, it passes exactly over this antenna facing into the wind. Indication is given to the pilot by the rise of the volume of reception; and, after having passed by a 180° change in indication, the pilot is enabled to read the wind direction from his magnetic compass.

But it is possible to fly along a straight course between two points by allowing for the drift. If, after flying for a few minutes towards the station, the pilot finds that the magnetic compass angle is getting smaller, it means that the plane is drifting towards the right and that the wind is blowing from the left. Then the pilot must adjust his course with the aid of the R.C. 5 radio compass. By a method of trial and error, the correct drift angle can be found and thus the

airplane can be maintained on a great circle course towards the station. It is the course which gives a constant reading of the magnetic compass with a constant indication of the R.C. 5 radio compass (see Fig. 9). Thus, when the correct drift angle has been determined, the pilot flies with the magnetic compass and radio compass readings corrected for drift.

It should be noted that when a pilot possessing an R.C. 5 radio compass leaves a transmitter station, he can rapidly determine his drift angle, since it is only necessary for him to fly on a certain magnetic course and to measure the angle at which he sees the station on the radio compass. This angle is the angle of drift with reference to the point of departure. By this means the angle of drift is determined, but it must be remembered that the angle of correction for drift is not the same and can only be determined by applying the previously mentioned process.

The methods just outlined were described in 1927 in "*Onde Électrique*," and apparently they were new at that time.

Referring to the left portion of Fig. 10 assume that, from the point  $A$ , the pilot wishes to maintain a course  $30^\circ$  from the geographic north. He notes after a certain time that, with a  $0^\circ$  bearing of his radio compass on transmitter  $A$ , his magnetic compass indicates a difference of  $5^\circ$ ; then he no longer flies on a  $30^\circ$  course, but on a  $35^\circ$  course. This difference enables him to determine the approximate distance he is off his course. If the angular difference had been negative, the pilot would have known that he was on the left of his course. The same process can be utilised with station  $B$ , but in this case a positive difference indicates a deviation to the left, and vice versa.

The right portion of Fig. 10 represents a general case where there are no stations either at the point of departure or destination, but where there is a suitable station situated on the side. Formulae for determining the distance of the

plane from this station are indicated in the illustration.

Obviously, neither the pilot nor the navigator would have the time for applying these formulae on board an airplane. Simple course and distance calculators which can be read very quickly have been made. Given, on the one hand, the distance already traveled from  $T_1$  (the product of speed by time) in a direction known by the pilot between the two points  $T_1$  and  $T_2$ ; and, on the other hand, the difference between two bearings taken on the stations  $T_1$  and  $T_2$ , the pilot can determine the distance from  $T_2$ . Information of this character is, of course, highly useful and is readily obtainable by reference to a regular broadcasting station in cases where a transmitter is not available at the points of departure or arrival. If a low power station is available at the point of destination, it can, of course, be used during the latter part of the journey.

Fig. 11 shows the calculator in question. The coefficients apply regardless of whether the stations are on the left or right.

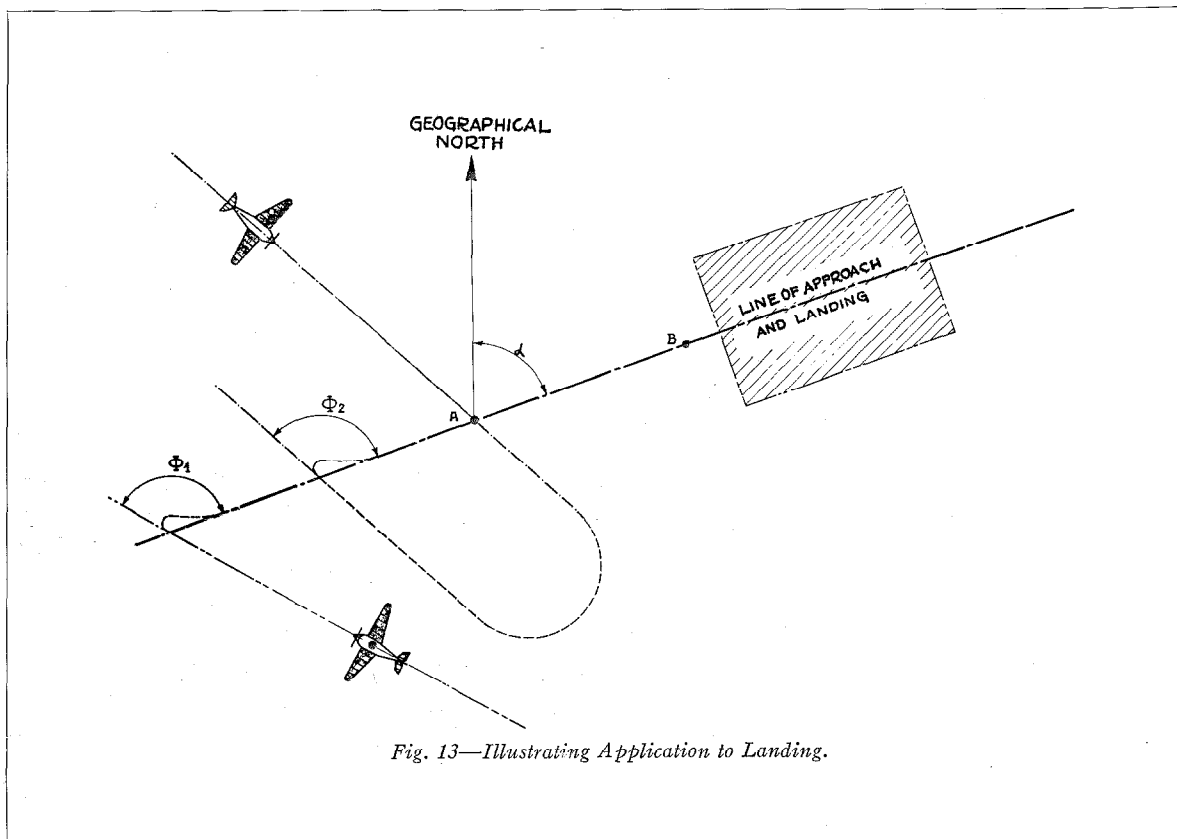

Fig. 13—Illustrating Application to Landing.



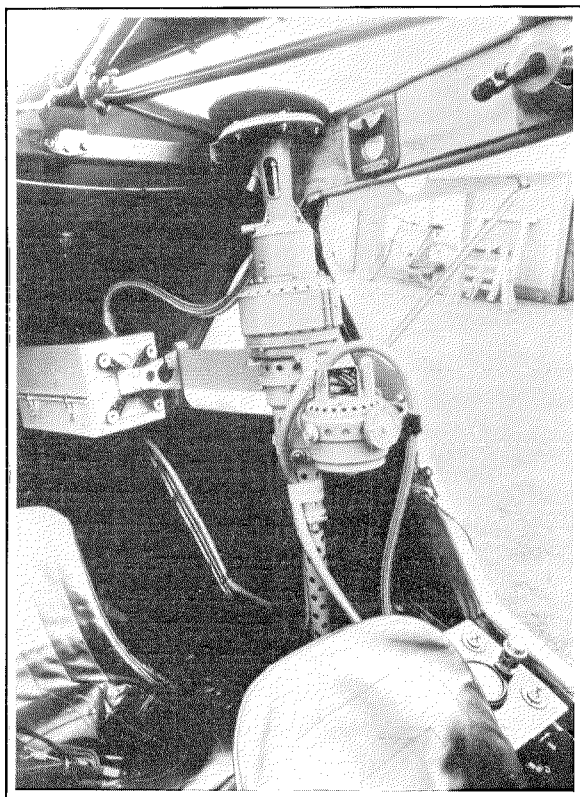

Fig 14—Experimental Installation of the R.C. 5 Radio Compass on a Small Airplane.

Suppose that the plane is going in a certain direction and that it keeps a steady course. The pilot looks at the radio compass indications and, for example, reads  $30^\circ$ , at the same time noting the exact time. After an interval of 5 minutes at an air-speed of 300 km. per hour, i.e., after flying 25 km., he reads  $36^\circ$ . On his "calculator" he finds the coefficient 4.78 for  $36^\circ$ , and a simple multiplication of this coefficient by the distance he has just flown will give him the distance at which he is from the station, i.e., about 120 km.

*180° Ambiguity.* The left-hand diagram in Fig. 10 shows the correct means of obtaining sense, i.e., of ascertaining whether the transmitter is ahead or astern. When flying a fair distance away from the transmitter the possibility of not knowing the location of the transmitter is small. However, near the transmitter, it might be difficult to locate the exact position ( $180^\circ$  fault).

There are two main methods of coping with this situation: (1) there is the intensity variation

of the received wave, which of course increases or decreases according to the direction of flight to or from the transmitter; (2) a  $90^\circ$  deviation from the course flown, and, after a few minutes, again turning the radio compass to  $0^\circ$ . A decrease of the magnetic reading indicates that he is flying towards the station, whereas an increase points to the fact that he is flying away (see Fig. 12).

The larger the difference in these magnetic courses, the nearer the airplane is to the transmitter.

### *Applications to Landing*

The fact that, with a radio compass, the airplane passes just over the station towards which it has been flying leads to the possibility of using the R.C. 5 for landing under conditions of very low visibility. This has been demonstrated by numerous tests and was accomplished by methods indicated in Fig. 13.

With the radio compass the exact location of a transmitter can be found; thus this transmitter becomes a marker beacon.

Two different examples of landing with the aid of the R.C. 5 radio compass are described hereinafter (see Fig. 13).

First, it should be noted that the airplane is fitted with a sensitive altimeter which, before the landing, must be adjusted to the actual atmospheric pressure of the aerodrome. This information is transmitted to the airplane in a normal radio message (QFE). With such an instrument the pilot knows his height within 10 metres and this should be sufficient in most cases, inasmuch as, in practice, vertical visibility does not ordinarily fall below this figure.

Second, a directional gyro is of great assistance to the pilot during the last stages of the approach.

Further, it is assumed here that *A* and *B* represent two transmitters lying in the line of approach to the aerodrome. *B* only needs to be a transmitter of very small power.

It is, of course, necessary for the pilot to know the direction of the correct line of approach (in Fig. 13 this is approximately  $70^\circ$ ).

*Example 1.* When the pilot, who has been flying towards transmitter *A* by means of the R.C. 5 radio compass, gets near *A* and the aerodrome (for instance, 10 to 20 km.), he deliberately flies off this course and continues on a

certain compass course. As shown in the diagram, this course makes an angle  $\Phi_1$  with the line of approach.  $\Phi_1$  can be readily computed from the known course bearing and the known direction of the line of approach. As the pilot proceeds along this altered course, the direction of the R.C. 5 continuously changes. When the R.C. 5 indication equals the previously computed angle  $\Phi_1$  the pilot knows that he is in the line of approach. He then only has to turn his machine till the R.C. 5 reads  $0^\circ$  to approach the aerodrome in the correct direction. He will now automatically pass over *A* and the moment he is overhead is indicated by the R.C. 5. He then starts losing height and tunes his R.C. 5 on *B*, keeping the same compass course and directional gyro indication; the R.C. 5 should still show  $0^\circ$ . In passing over *B* he should be low enough to be able to effect a landing at the aerodrome. This height depends on the distance of *B* from the flying field. The position of *B*, however, should normally be such that, for a good landing, the airplane should pass over *B* at a height of approximately 30 metres.

*Example 2.* If it is difficult to decide at what distance before *A* to discontinue the  $0^\circ$  reading of the R.C. 5 (as described above), the pilot may approach *A* continuously till he actually passes overhead. The R.C. 5 will thus give him a "fix." He is not, however, flying in the correct direction of approach. But the R.C. 5 will again prove indispensable: after passing over *A* he continues on the same course, R.C. 5 again reading  $0^\circ$  for a certain time, for instance, 3 minutes. Then the pilot makes a wide turn through approximately  $180^\circ$ , turning away from the aerodrome. He flies back on a certain compass course, and then the procedure is as in Example 1.

#### **Comparisons with Other Methods of Navigation by Radio**

First, let us compare the radio compass with other direction finders used on airplanes. The radio compass gives automatically the indications that, with a direction finder, can only be secured by a skilled operator.

The trend is more and more towards automatic operation and, inasmuch as a direction

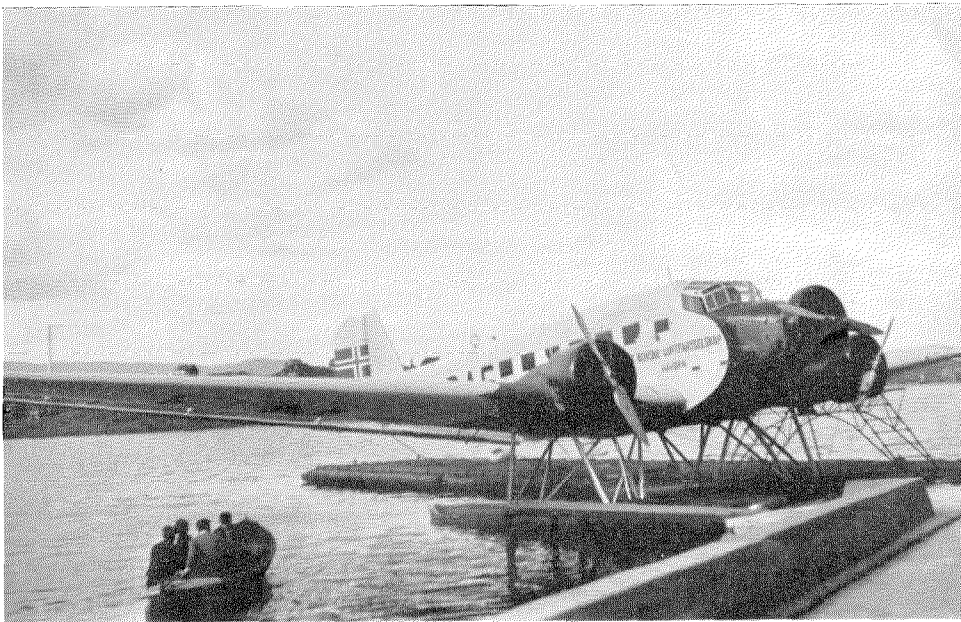

Fig. 15—Seaplane Equipped with the R.C. 5 Radio Compass.

finder does not operate automatically, the indications are that the radio compass will find increasing application in aerial navigation. In contrast with the radio compass, the direction finder makes it necessary for the radio operator to take bearings of the transmitter and pass them on to the pilot in order that the latter may make the necessary course adjustments. Further, course adjustments on the part of the pilot are not made by direct indication, but through the medium of another navigating instrument, either the magnetic compass or the directional gyro.

The correction, if made with the help of the magnetic compass, will always be  $3^{\circ}$  or  $5^{\circ}$  behind, thus making the course unsteady. When operations have to be rapid, the direction finder cannot be used and, for instance, cannot be used for landing or even for passing directly over marker beacons. Further, with an ordinary airplane direction finder, the operator must find the point of minimum reception, which is difficult to

determine on board a plane on account of the engine noise, while, with the radio compass, the noise question is quite secondary since the indication is automatic and much more practical. With a radio compass the pilot navigates directly and, inasmuch as this instrument has less inertia than a magnetic compass, the course is held more accurately and with less effort.

#### **Ground Direction Finders**

If a comparison is made with ground direction finders, it is found that, in no case, can they render the same amount of service as the R.C. 5 radio compass. This does not mean that the ground direction finder is useless; on the contrary, it appears to the author to be of great assistance in checking the position of airplanes.

A single ground direction finder cannot furnish sufficient indications to numerous approaching planes to enable them to navigate safely under unfavorable conditions. At important aero-



Fig. 16—Near View of the Loop of the R.C. 5 Radio Compass on the Seaplane Shown in Fig. 15.

dromes, where ground direction finders are ordinarily used, several planes asking for bearings (QDM) or for landing indications by means of the ZZ system, or both, during bad weather, quickly overload the ground direction finders and all demands cannot be answered. Several months ago, during a heavy fog in London, several airplanes had to return to their home aerodromes as they could not land, since the ground direction finder could not give the necessary indications to all of them. An R.C. 5 radio compass would have enabled them to navigate; and the utilisation of a landing system (as for example, a radio beacon and marker beacon system, or the R.C. 5 radio compass system following the principles above outlined) would have facilitated landing.

*Radio Beacons.* If we compare the radio compass to radio beacons on a definite route and, in general, to all systems in which directivity is given from a stationary transmitter, it is easy to see that the R.C. 5 radio compass offers more possibilities and, in addition, allows military airplanes to approach with great secrecy.

The radio beacon has the disadvantage of indicating to anybody the route leading to it, enemies as well as friends. Its advantage is that the plane is able to navigate on a well defined beam. But, with the radio compass, airplanes can also navigate easily on a beam. Simultaneous observation of a magnetic compass or of a directional gyro and of the R.C. 5 radio compass makes it easily possible to fly on a straight, great circle course towards the desired destination.

A limitation of the radio beacon is that it can indicate only one or two directions of navigation and all airplanes using it must follow the same route. An ordinary non-directional transmitter, however, constitutes a complete Hertzian beacon for radio compasses. An equivalent result could not be obtained with directional radio beacons without employing an infinite number. In actual practice there ought to be as many radio beacons as airways to be followed, the realization of which would certainly appear difficult.

The R.C. 5 radio compass, from this point of view, has many advantages for military purposes. In no case can it be accepted that a military plane experiencing navigational difficulties should have to ask indications from the ground. Such a demand might be useful information to an enemy. The military plane fitted with a radio

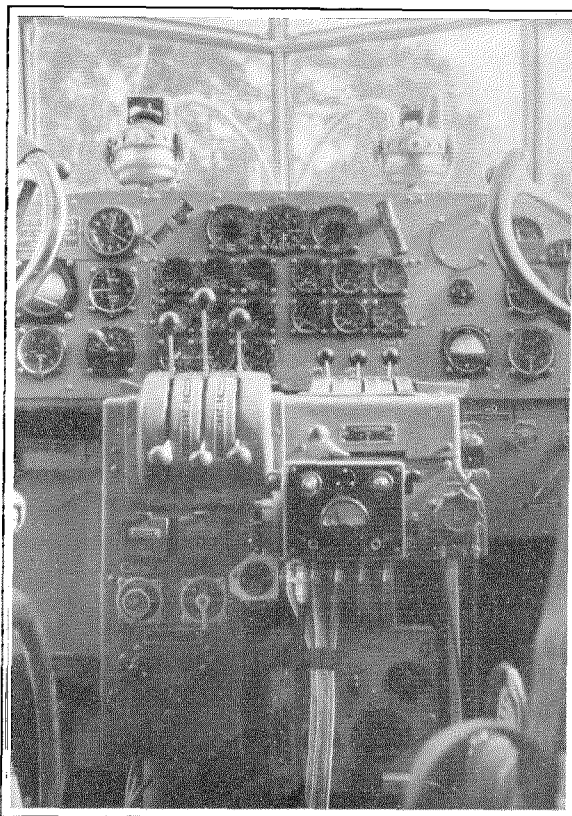

Fig. 17—Installation of Control Unit and Indicators of R.C. 5 Radio Compass in the Pilot Cabin of the Seaplane Shown in Fig. 15.

compass can navigate without any assistance. It is even impossible to find out what station it is using for its navigation. This station may very well be a broadcasting station, serving as a radio beacon. Also, the transmitter may be changed frequently.

The radio compass can be utilised on powerful stations situated at a great distance, thus permitting navigation over several hundred kilometres. When desired, the pilot can abandon this station to pick up a weaker station, which cannot be heard at a few hundred km. distance, but which will permit the pilot to traverse the 50 or 100 km. to the transmitter and from there to the airport where he must land.

#### ***Radio Compass Installations in France and Other Countries***

Experiments have been made on board a small plane (Fig. 14) and it will be seen that, despite the limited size of the cabin, the radio compass

is not in the way. The loop assembly, the receiver, the control unit, and indicator are shown.

Figs. 15 and 16 show the relative size of the loop of the R.C. 5 radio compass compared with a seaplane of a Norwegian Air Line. As in Fig. 7, the loop is at the rear end of the fuselage and the whole equipment is remote-controlled from the pilot's cockpit.

Fig. 17 shows the pilot's cockpit of the same plane, where the pilot's indicator can be seen in the left-hand top corner of the illustration and the navigator's indicator on the right. As the radio operator sits between the two pilots he can easily operate the radio compass by the control unit shown in the centre of the cockpit. The operator only has to tune the receiver, by means of the control unit knob, on the desired station and read the bearing in the navigator-indicator, while the pilot reads the other indicator.

In France, both civil and military aviation authorities have submitted the radio compass to exhaustive tests and many airplanes have already been equipped with it. These installations are in daily use and have given such good results that additional planes will be similarly equipped in the near future. Installations are also being made in Norway, Spain, Czechoslovakia, and several other countries.

In some countries use is made of so-called radio compasses and considerable publicity has been given to such equipment. Practically all of these so-called radio compasses are in reality nothing more than "homing devices," the characteristics of which have been compared herein with the automatic radio compass. These "homing devices" should not be confused with the automatic radio compass which, so far as is known, is the only one of its kind now in existence.

## Recent Telecommunication Developments of Interest

**T**ELEVISION RECTIFIER. The accompanying illustration shows the new, small, high-voltage, low-current rectifier developed by Standard Telephones and Cables, Limited, London, for use in cathode ray oscillograph and television equipment.

This valve—the VLS61—is only slightly over five inches in height and two inches in diameter. In spite of its compactness, however, the design, which employs an internal shield over the filament leads, permits operation at high voltage without danger of flashover. It will deliver 3 milliamperes at 6,000 volts in a half-wave circuit.

The VLS61 represents one of the numerous

steps required to reach the "corner" around which television is popularly supposed to be located.

• • •

**A**UDIBILITY—5 MILES. Standard Telephones and Cables, Limited, London, successfully completed its annual job of installing and operating the public address system at the Aldershot Tattoo. This installation, which is required to serve the hundred thousand spectators at this gigantic military pageant, is one of the largest temporary installations in the world.

The battery of loudspeakers, driven from a 300 watt amplifier, is easily audible at a distance of 5 miles. In addition to the main battery of loudspeakers, four portable units, comprising thirty-two smaller loudspeakers, were employed for community singing. The amplifier equipment employed forty-four Standard valves of eight different types.

All apparatus, including the 300 watt power amplifier, was in duplicate. The precautions extended to a battery-driven motor-generator power supply, in case of mains failure. One of the emergency amplifiers was brought into use when lightning struck one of the regular amplifiers. The audience was unaware of the incident and noticed no interruption, thanks to Standard Telephones and Cables' efficient operating staff and the carefully planned emergency provisions.

• • •

**T**HE PUBLIC ADDRESS UNITS shown in the illustrations represent new Le Matériel Téléphonique, Paris, developments. They include a 20 watt amplifier, a dynamic microphone pre-amplifier, and a carbon microphone adaptation box.

The 3223 amplifier will deliver 14 watts with 5% harmonics, or 20 watts with 10%. It has a fixed gain of 72 db., and a remarkably flat frequency characteristic from 40 to 20,000 cycles with a variation of only 1 db.

It is completely a-c. operated and portable. It may be used with dynamic microphones in conjunction with the preamplifier, or with carbon

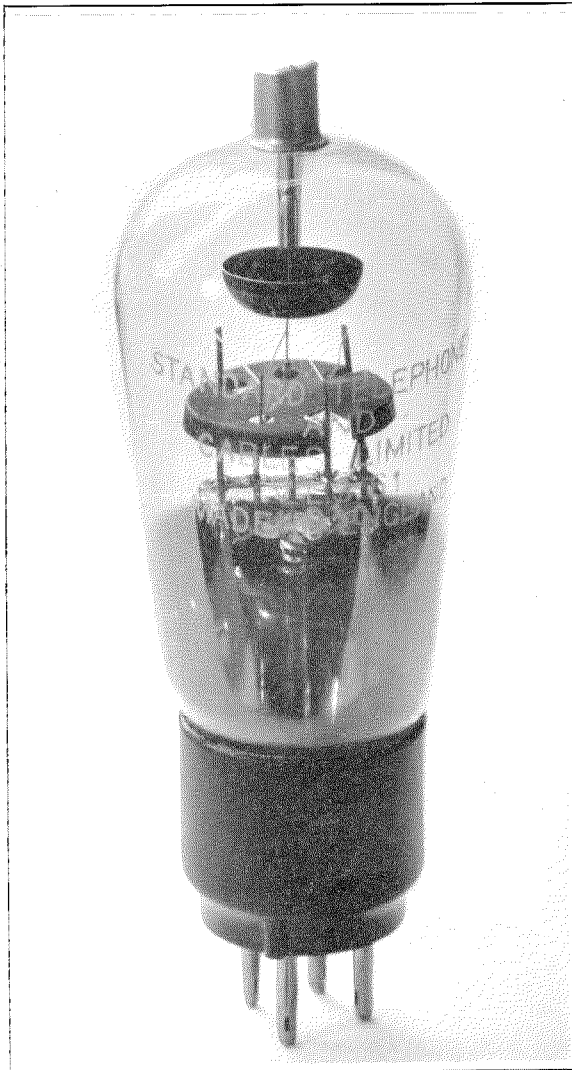

button microphones, gramophone pickup, or programme line when used with the adaptation box.

The preamplifier is designed for use with the 3223 amplifier and, in conjunction with it, supplies an overall gain of approximately 115 db. The switching arrangements permit the selection of either of two dynamic microphones, or the mixing of both in the required proportions. All power supply is obtained from the 3223 amplifier.

The adaptation box provides the inputs and the switching controls for a single or double-button carbon microphone, a gramophone pickup, and a programme line. These separate inputs may be individually selected or mixed as desired. Space is provided for carrying a small 4.5 volt microphone current battery. If desired, the units may be interconnected so that the microphone battery switch simultaneously controls the mains supply for the 3223 amplifier.

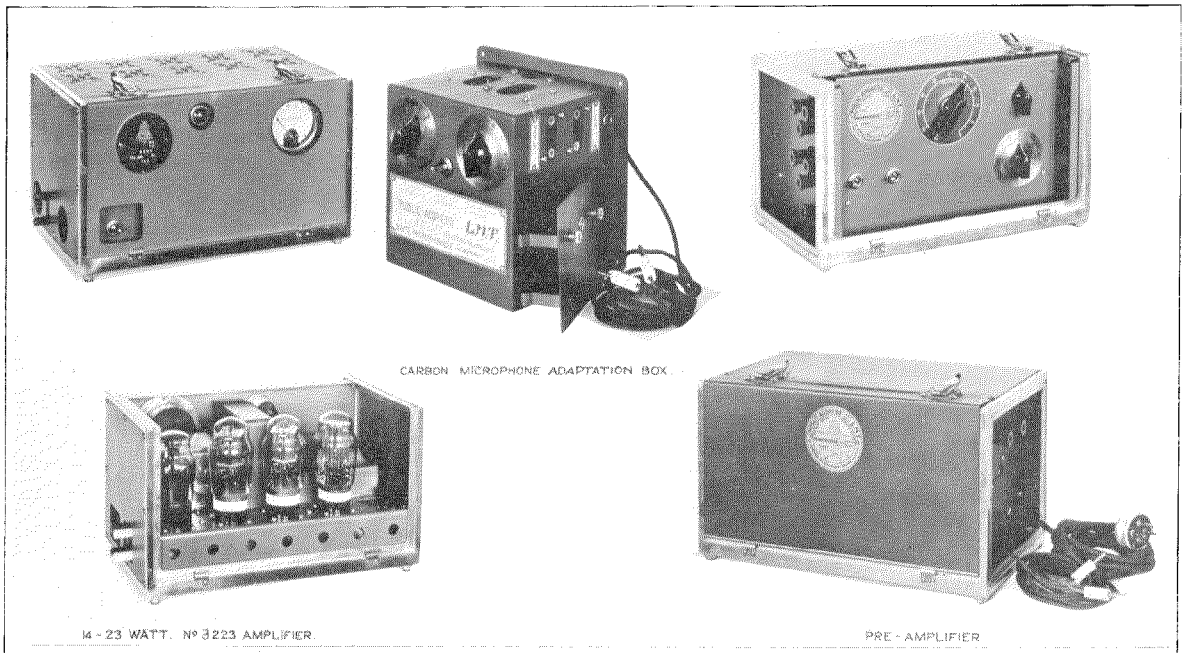

---

---

## *Licensee Companies*

BELL TELEPHONE MANUFACTURING COMPANY . . . . .	<i>Antwerp, Belgium</i>
<i>Branches: Brussels.</i>	
BELL TELEPHONE MANUFACTURING COMPANY . . . . .	<i>Berne, Switzerland</i>
BELL TELEPHONE MANUFACTURING COMPANY . . . . .	<i>The Hague, Holland</i>
CHINA ELECTRIC COMPANY, LIMITED . . . . .	<i>Shanghai, China</i>
<i>Branches: Canton, Hankow, Hongkong, Peiping, Tientsin.</i>	
COMPAÑÍA RADIO AEREA MARITIMA ESPAÑOLA . . . . .	<i>Madrid, Spain</i>
COMPAÑÍA STANDARD ELECTRIC ARGENTINA . . . . .	<i>Buenos Aires, Argentina</i>
CREED AND COMPANY, LIMITED . . . . .	<i>Croydon, England</i>
FABBRICA APPARECCHIATURE PER COMUNICAZIONE ELETTRICHE . . . . .	<i>Milan, Italy</i>
INTERNATIONAL MARINE RADIO COMPANY, LIMITED . . . . .	<i>London, England</i>
INTERNATIONAL STANDARD ELECTRIC CORPORATION, <i>Branch Office,</i>	<i>Rio de Janeiro, Brazil</i>
JUGOSLAVIAN STANDARD ELECTRIC COMPANY, LIMITED . . . . .	<i>Belgrade, Jugoslavia</i>
KOLSTER-BRANDES, LIMITED . . . . .	<i>Sidcup, England</i>
LE MATÉRIEL TÉLÉPHONIQUE . . . . .	<i>Paris, France</i>
<i>Branch: Rabat, Morocco.</i>	
NIPPON DENKI KABUSHIKI KAISHA . . . . .	<i>Tokyo, Japan</i>
<i>Branches: Osaka, Dairen, Taihoku.</i>	
SOCIÉTÉ ANONYME LES TÉLÉIMPRIMEURS . . . . .	<i>Paris, France</i>
STANDARD ELECTRIC AKTIESELSKAB . . . . .	<i>Copenhagen, Denmark</i>
STANDARD ELECTRIC COMPANY W POLSCE SKA Z O. O. . . . .	<i>Warsaw, Poland</i>
STANDARD ELECTRIC DOMS A SPOL. . . . .	<i>Praha, Czechoslovakia</i>
<i>Branch: Bratislava.</i>	
STANDARD ELECTRICA . . . . .	<i>Lisbon, Portugal</i>
STANDARD ELECTRICA ROMÂNÁ, S.A. . . . .	<i>Bucharest, Rumania</i>
STANDARD ELÉCTRICA, S.A. . . . .	<i>Madrid, Spain</i>
<i>Branches: Barcelona, Santander.</i>	
STANDARD ELEKTRIZITÄTS-GESELLSCHAFT A.G. . . . .	<i>Berlin, Germany</i>
STANDARD ELETTRICA ITALIANA . . . . .	<i>Milan, Italy</i>
<i>Branch: Rome.</i>	
STANDARD TELEFON-OG KABELFABRIK A/S . . . . .	<i>Oslo, Norway</i>
STANDARD TÉLÉPHONE ET RADIO, S.A. Zürich . . . . .	<i>Zürich, Switzerland</i>
STANDARD TELEPHONES AND CABLES, LIMITED . . . . .	<i>London, England</i>
<i>Branches: Glasgow, Leeds, Dublin, Cairo, Pretoria, Calcutta.</i>	
STANDARD TELEPHONES AND CABLES (AUSTRALASIA), LIMITED . . . . .	<i>Sydney, Australia</i>
<i>Branches: Melbourne; Wellington, New Zealand.</i>	
STANDARD VILLAMOSSÁGI RÉSZVÉNY TÁRSASÁG . . . . .	<i>Budapest, Hungary</i>
SUMITOMO ELECTRIC WIRE & CABLE WORKS, LIMITED . . . . .	<i>Osaka, Japan</i>
VEREINIGTE TELEPHON- UND TELEGRAPHENFABRIKS AKTIEN-GESELLSCHAFT, CZEIJA, NISSL & Co. . . . .	<i>Vienna, Austria</i>

---

*Sales Offices and Agencies Throughout the World*

---

---