

Ap.  
Ap.  
Ap.  
Ap.  
Ap.

# ELECTRICAL COMMUNICATION

OCTOBER

No. 2

1934

VOL. 13

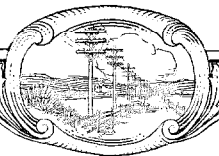

# ELECTRICAL COMMUNICATION

A Journal of Progress in the  
Telephone, Telegraph and Radio Art

H. T. KOHLHAAS, Editor

## EDITORIAL BOARD

E. A. Brofos    P. K. Condict    G. Deakin    E. M. Deloraine    P. E. Erikson    John W. Foard  
James E. Fullam    F. Gill    Frank C. Page    H. M. Pease    G. E. Pingree

Published Quarterly by the

*International Standard Electric Corporation*

Head Offices

67 BROAD STREET, NEW YORK, N. Y., U. S. A.

European General Offices

CONNAUGHT HOUSE, ALDWYCH, LONDON, W. C. 2, ENGLAND

G. E. Pingree, President

S. G. Ordway, Secretary

Joseph A. Redegeld, Treasurer

Subscription, \$3.00 per year; single copies 75 cents

Volume XIII

OCTOBER, 1934

Number 2

## CONTENTS

	PAGE
TELEPHONE STAFF TRAINING IN SHANGHAI.....	103
<i>By W. Miles, A.M.I.E.E.</i>	
RADIO BROADCAST RECEIVERS.....	115
<i>By J. S. Jammer and L. M. Clement</i>	
NOISE LIMITS IN LONG INTERNATIONAL CIRCUITS.....	125
<i>By John Collard, Ph.D.</i>	
MULTIPLE EARTHING AND ITS EFFECT ON INDUCED NOISE..	130
<i>By John Collard, Ph.D.</i>	
TRUNKING PLANS OF THE PARIS NETWORK.....	142
<i>By S. V. C. Scruby</i>	
WIDE BAND TRANSMISSION OVER COAXIAL LINES.....	159
<i>By Lloyd Espenschied, Fellow A.I.E.E., and M. E. Strieby, Member A.I.E.E.</i>	
A NEW TYPE OF TELEPHONE KIOSK IN NORWAY.....	173
<i>By M. L. Kristiansen</i>	
REDIFFUSION AND TELEPROGRAMME SYSTEMS.....	174
<i>By A. R. A. Rendall, B.Sc., A.M.I.E.E., and S. Van Mierlo</i>	
RECENT TELECOMMUNICATION DEVELOPMENTS OF INTEREST..	185

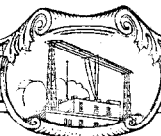



A PORTION OF SHANGHAI'S BUSINESS  
DISTRICT SHOWING THE WHANGPOO  
RIVER. THE ARROW IN THE FORE-  
GROUND INDICATES THE CENTRAL  
TELEPHONE EXCHANGE BUILDING.

# Telephone Staff Training in Shanghai

By W. MILES, A.M.I.E.E.

*Education Division, Shanghai Telephone Company*

**T**HIS paper is intended to cover, in a general way, the activities of the Shanghai Telephone Company from a staff education point of view. These activities, while not assumed to be in any way original, may be of interest to other organisations carrying out or contemplating similar work.

Shanghai is divided administratively into three portions, these being known respectively as the International Settlement, the French Concession, and Greater Shanghai. The former two portions are foreign controlled, and it is for them, together with a certain section which is known as the Extra-Settlement or Outside Roads Area, that telephone service is provided by the Shanghai Telephone Company; Greater Shanghai is served by a separate system operated by the Chinese Government Telephone Administration. The following table will serve to indicate the size and relative importance of the various parts, but it should be noted that the population figures given are only approximate:

	Area Square Miles	Population	
		Chinese	Foreign
Greater Shanghai.....	320	1,753,700	9,300
International Settlement	8.75	971,400	36,400
French Concession.....	3.94	478,700	17,700
Total.....	332.69	3,203,800	63,400

Some idea of the rapidity with which Shanghai has developed, particularly within the past thirty years, will be obtained from the fact that in 1900 there existed one magneto telephone exchange with 107 subscribers, while to-day the area served by the Shanghai Telephone Company contains about 45,000 subscribers' stations including 800 private branch exchanges, one common battery exchange and seven full automatic exchanges of the No. 7-A Rotary type, the latter housed in air-conditioned buildings. In addition, facilities are provided for inter-communication with Greater Shanghai and for toll connection, over lines

which are under the control of the Chinese Government Telephone Administration, to Hangchow, Nanking, and about sixteen other towns in adjacent provinces. Other branches of the company's activities are the maintenance of a Burglar Alarm Service, a Police Street Telephone System, and a small Teleprinter Service.

Great strides have been made in the development and improvement of the Shanghai Telephone System during the past few years. Prior to 1930 the system was operated largely on a local battery basis; since that time, however, six new buildings have been erected and equipped with automatic apparatus, with the result that 97% of the whole system is now automatic, the remaining 3% being located in the Extra Settlement or Outside Roads Area.

The vast amount of work involved in the conversion of the system which, incidentally, was carried out in less than twenty months from the time the company became associated with the International Telephone and Telegraph Corporation, need not be enlarged upon; in fact, it has been dealt with in a previous paper.<sup>1</sup>

Coincident with the planning of the conversion and the development of the system, the necessity arose for serious consideration of the question of staff training, and in 1929 an Education Division was formed to take care of this important branch of the company's activities.

The work covered by the Education Division during the past four years includes the training of existing staff in new methods and in the handling of new types of equipment, and also the engaging and training of new staff. The latter function, particularly during the conversion period when a considerable temporary increase in staff was required, has proved no easy task since, from a telephone point of view, Shanghai is somewhat isolated. It is therefore extremely difficult to obtain new personnel who have any previous knowledge of the work, or who have

<sup>1</sup> "The Reconstruction of the Shanghai Telephone System," *Electrical Communication*, July, 1932.



Figure 1—A Corner of the Reading Room and Library.

had previous mechanical or electrical training of any kind; in fact, although the standard of general education among the working class Chinese is steadily improving, it is still so low that more than ordinary care has to be exercised in choosing recruits in order to ensure obtaining the right type of man. When engaging new staff, every effort is made to obtain men having at least a fair knowledge of the English language, and each applicant is required to pass an examination which is calculated to test his general knowledge and ability. This procedure, coupled with a series of further tests and close observation during the preliminary training stages, has met with considerable success since it facilitates the early weeding out of unsuitable individuals, and results in a minimum subsequent wastage and a better type of man being obtained than would otherwise be the case.

In addition to the recruiting and training of new staff for the various grades, a scheme was inaugurated in 1929 under which a limited number of foreign and Chinese youths with a particular aptitude for mathematics and technical subjects were selected from the local schools to undergo special training as apprentices; and a further limited number of Chinese youths, who had completed an engineering course at an approved college, were chosen to undergo special

training as students. These apprentices and students, after having passed through a preliminary course of three months' training in the school and, while continuing their general and technical education by means of day and evening classes under the tuition of the Education Division staff, were given from three to five years' field training and experience with the various divisions but remained under the control of the Education Division for all ordinary purposes. This scheme also has met with remarkable success, a surprisingly small wastage having occurred. A few of these youths have already been permanently posted to various divisions, some of them in a minor supervisory capacity, and are daily proving their worth to the company and thereby justifying the scheme in a most satisfactory manner.

Other activities of the Education Division, apart from those of the Practical Training School, referred to hereinafter, have included language classes in English and Chinese; special evening class tuition, and assistance in mathematics and physics for members of the staff who were desirous of taking various examinations; the organisation and conduct of summer vacation training schemes for Chinese University graduates who are taking communications courses; and the organisation and maintenance of a li-

brary and reading room. The latter, a portion of which is shown in Fig. 1, in addition to providing a fairly comprehensive technical library, provides facilities which enable the staff to keep in touch with telephone progress and events in other parts of the world through the medium of the many technical journals and house organs which come to hand, and it also houses a fiction library which is the property of the Company Recreation Club.

In passing, it may be mentioned that the permanent staff of the Education Division now comprises one foreigner, two Chinese assistant teachers, and a small clerical staff. The two assistant teachers are youths who joined the company as apprentices four years ago, and who, after having spent some time in the field, were selected for their general ability and knowledge of English to undergo special training and instruction in the art of teaching. In addition to the permanent staff, however, it is the practice, more particularly with regard to outdoor plant training, to bring gang foreman into the school to assist in general supervision and teaching when required.

The most important branch of the divisional activities is the Practical Training School. This alone, during the past three and a half years, has handled 1,220 students in full and part time

courses ranging in duration from one week to four months, and no less than 1,100 students in evening classes which are conducted during eight months of each year. The training school is well equipped with all necessary apparatus to enable it to carry out practical training in every branch of plant work. It at present occupies a considerable portion of an indoor floor space of about 3,200 square feet which is allocated to the Education Division in one of the central office buildings, this space being divided into Practical Training rooms, lecture rooms, library and reading room, and offices. In addition, a space of about 9,000 square feet on the roof of the same building is devoted to an open air school for the training of staff in outdoor plant work. The equipment of the indoor school, portions of which are shown in Figs. 2, 3 and 4, includes a full automatic demonstration model of the rotary type; working installations of the various types of private branch exchanges and all other types of subscribers' apparatus; a wire chief's desk and other testing equipment; a number of special frames which are used for machine adjustment training and which are equipped with all the various types of automatic exchange apparatus; a small main distribution frame adapted for practice work in cabling, wiring, etc.; a model cable distribution scheme; an Epi-diascope capable of projecting

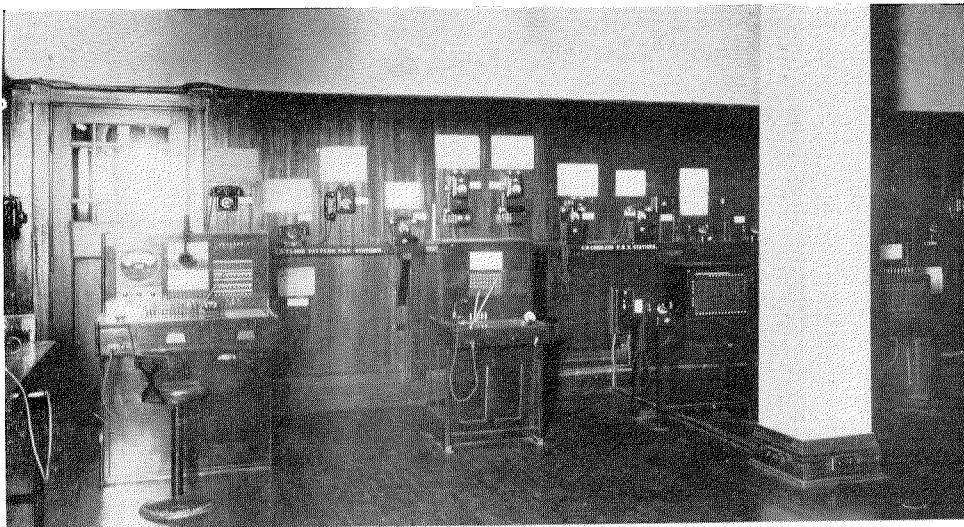
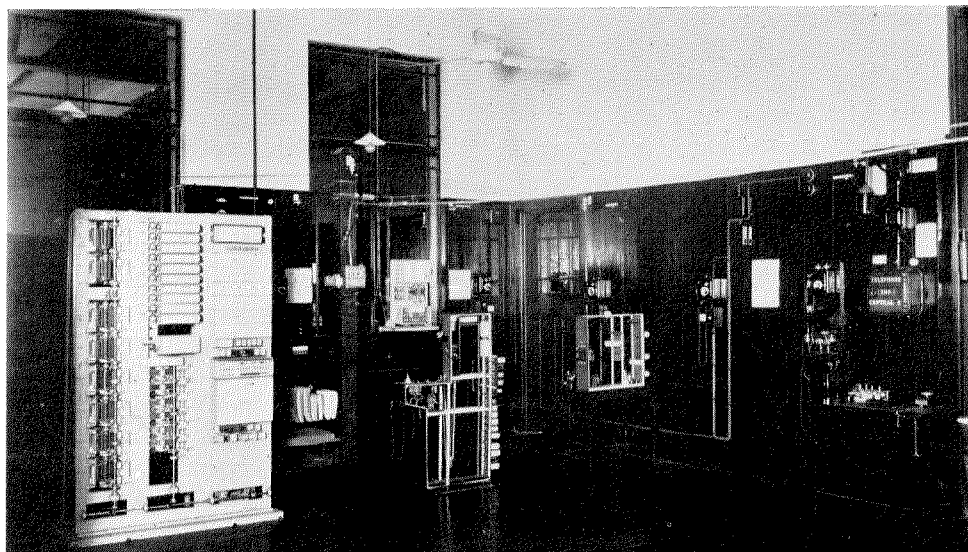

Figure 2—A Section of the Indoor School Showing Wire Chief's Desk and P.B.X.s.



*Figure 3—A Portion of the Indoor School Showing Demonstration Equipment.*

slides, rough sketches, solids or text book pictures on to a screen; a cinematograph camera and projector; a small telephone museum containing articles of historical and technical interest; and a considerable amount of miscellaneous equipment such as demonstration apparatus and devices, work benches, tools, etc.

While it is, of course, essential that much of the demonstration and practice equipment be of the latest type as used in the field, a considerable economy is effected by using as much recovered or scrap material as possible for practice purposes. This applies to almost all cable and wire, while a great deal of the preliminary training on repairs and adjustments is carried out with the aid of old telephones, relays, switches, jacks, keys, etc., thus avoiding possible damage to good equipment by inexperienced students.

During training, every opportunity is taken to elucidate the various points with the aid of actual equipment or demonstration devices, while the value of the screen for illustrative purposes cannot be exaggerated. At the time of writing, the school has a stock of more than 500 pictures and slides which are used in conjunction with the Epi-diascope during the various courses; these include pictures illustrating magnetic and electrical

phenomena, a large number of sketches and photographs of all kinds of apparatus showing the construction details and methods of carrying out replacements and adjustments, sectional and complete circuit diagrams, etc. There are available also innumerable pictures which can be projected direct from text books, and a number of solids such as relays, dial and switch mechanisms, etc., which can be placed bodily into the Epi-diascope and projected by reflection on to the screen.

The training of staff for the installation and maintenance of outdoor plant is carried out mainly in the roof school to which reference has already been made. This school, a portion of which is shown in Fig. 5, contains among other things, a number of portable shortened poles set in heavy wooden bases; a typical manhole constructed of rough wood; and a number of portable imitation walls containing doors and windows. This equipment facilitates the carrying out of courses covering underground, aerial, and block cable distribution work as nearly as possible under actual field conditions. Courses covering each of these three subjects, or combinations thereof, are conducted as required.

Practice in aerial and block cable distribution to pseudo subscribers' premises is carried out on

the roof from a 50-pair cable, one end of which terminates on the small main distribution frame in the indoor school; from this frame, the various lines can be cross-connected by jumpers to school exchange equipment and can be connected to the school test desk by means of the usual M.D.F. flexible cords. Thus, actual distribution, installation, and maintenance work, including testing and fault location, can be carried out in its entirety by the students concerned.

A certain amount of training during courses dealing with aerial and block cable work is carried out in the indoor school with the aid of the model cable distribution plant. This model provides a comprehensive view of a typical distribution scheme and includes underground, aerial, block and building cable distribution terminating on subscribers' and exchange equipment. The exchange equipment is represented by the automatic demonstration unit and the test desk; they are connected to a miniature main distribution frame comprising one of each type of M.D.F. testing circuits, one strip of 20 break jacks, a cross-connecting field and one strip of 20 protectors to which a 20-pair cable is connected to represent a main feeder cable. From

the feeder cable, branch cables are fed off to block and building cable distribution along the walls, and to aerial distribution over shortened poles which are secured to the floor and to the side benches, the pairs being multiplied and numbered in accordance with standard practice. Full size terminal boxes, insulators, brackets, etc., are used, from which the various pairs are connected to subscribers' equipment arranged around the room. Here the men are brought for lecture and demonstration purposes during each course and, in addition to receiving instruction in their own particular work, they are given an insight into the principles of exchange operation.

The model cable distribution scheme is also found extremely useful for giving students taking other courses a general idea of the principles of cable distribution; it is found to be particularly useful during the training of test clerks, in that the students are given a comprehensive view of a complete system including subscribers' apparatus, all kinds of outdoor plant and exchange equipment. Thus a testing student can observe all the work which is being carried out in conjunction with the various tests, and can therefore obtain a much better knowledge of fault location.



Figure 4—A Machine Adjustments Class at Work.



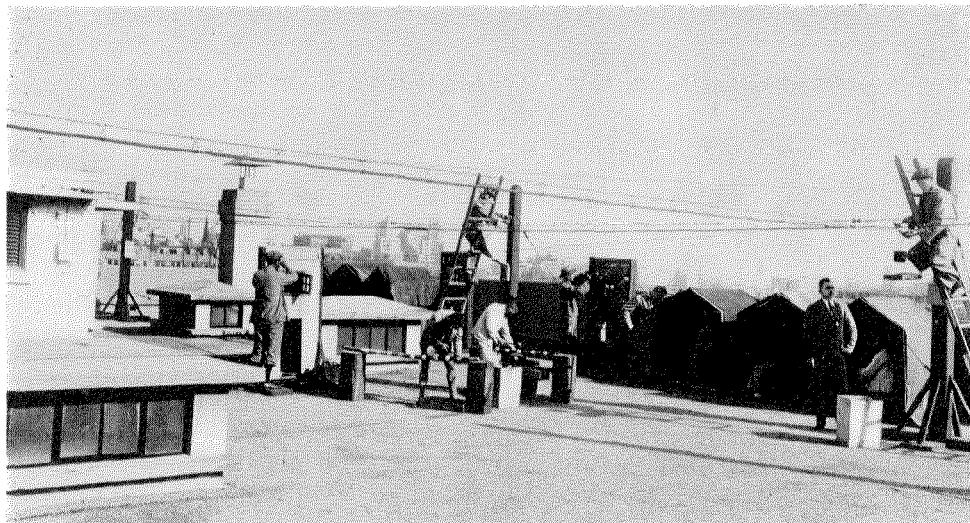

Figure 5—A Section of the Roof School.

The comparatively small amount of cable jointing training which is at present required, is carried out on the roof in the model manhole and in the tents which are shown in Fig. 5. During the automatic conversion period, however, the tremendous amount of underground cable work which was involved, necessitated the use of many more splicers and plumbers and the formation of a much larger cable jointing school than is normally required. To meet this demand, some empty rooms in one of the new exchange buildings were occupied, and rough benches fitted with cable clamps, scrap trays, and other necessary equipment were installed. About 160 men, comprising recruits and existing staff, passed through this school during a period of six months; three separate courses, dealing with helpers, splicers and plumbers, respectively, being conducted simultaneously. These courses varied in duration from one to twelve weeks according to the requirements of the men concerned. A portion of this school, showing one Japanese, one Chinese, and one Russian student at work, is shown in Fig. 6.

The training of staff to handle subscribers' equipment may be said to come under the two general headings of (a) the installation and

maintenance of the simpler kinds of subscribers' apparatus such as single instruments and wiring plans, and (b) the installation and maintenance of private branch exchanges. Such training is usually carried out in two separate courses under the above headings, although sections of these courses have been taken separately when requirements demanded speedy specialised training. The training procedure for both of these courses is similar and consists generally of preliminary tuition in the principles of the construction, the characteristics, circuit operation, and care of the apparatus the men are required to handle; this is followed by practice in cabling and wiring to meet various location conditions, and then by actual installation work on benches and on the walls of one of the school rooms which is panelled with inexpensive wood for this purpose. The cable pairs used during installation practice are taken from the model cable distribution scheme so that, on completion of an installation, the students concerned can observe and take part in the completion of the associated work on the outdoor plant and in the exchange, the latter being represented by the miniature main distribution frame, the test desk, and the automatic demonstration unit. Until recently, P.B.X. cir-

cuits and wiring were taught with the aid of large table panels on which each separate circuit was wired in skeleton, but it was found that they took up too much valuable floor space and they were discarded in favour of vertical cross-section models of the two most important types. These models show all the equipment and wiring in a very clear and simple manner and are being found very useful, although not quite so convenient as the table panels.

Training in the maintenance of subscribers' apparatus is carried out on various types of private branch exchanges and on all other kinds of subscribers' apparatus which are permanently installed in the school. The private branch exchanges are connected by trunk lines to one of the main exchanges, by tie lines to each other, and to extension instruments arranged on the walls of the room, while single instruments and wiring plans are connected via the model cable distribution scheme to the automatic demonstration unit. With the aid of the foregoing equipment, such work as testing, fault location, adjustments, and general maintenance is taught and carried out practically under field conditions, while special training in relay adjustments can be

given as required on the practice frames which are referred to later in connection with the Machine Adjustment Course.

During the training of men concerned with work on subscribers' premises, special attention is paid in a series of short lectures, to general deportment and to care of subscribers' property. During these lectures, the men are taught the importance of observing good manners; to practice care and cleanliness in their work; and to assist subscribers in the choice of location for apparatus when such assistance is required. These are important features, since the relations established by these men not only materially affect the status of the company in the eyes of the public, but are a big factor in fostering the goodwill and cooperation of subscribers.

The training of staff for the maintenance of automatic exchanges is a subject which, more than any other at present being dealt with in Shanghai, requires a great deal of preparatory work before the practical aspects of the subject can be touched upon. This is particularly so where entirely new men are concerned, and even, as has been the case in Shanghai, where existing staff must be trained to handle a new system.

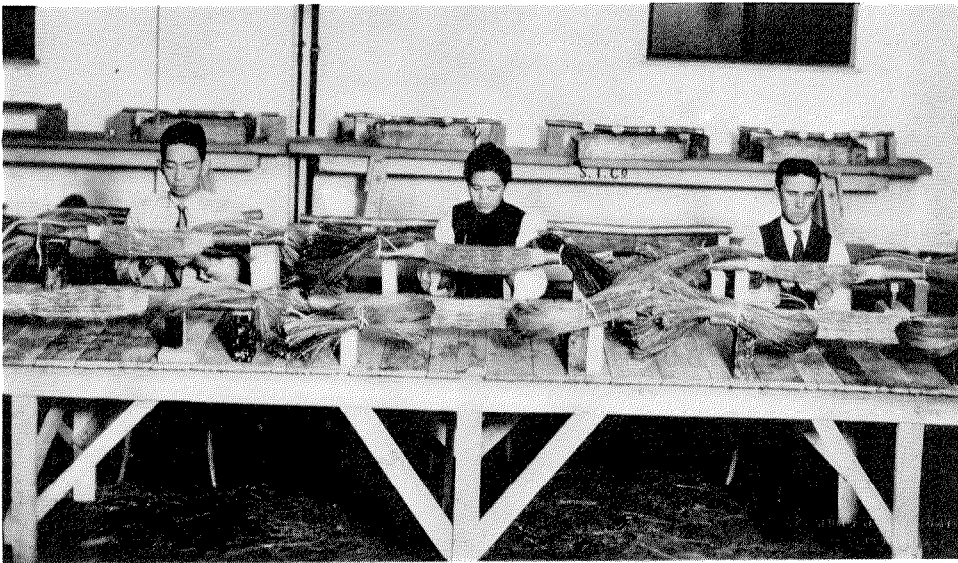

Figure 6—A Portion of the Temporary Cable Jointing School Used During the Conversion Period.

Following the considerable amount of preliminary tuition in electricity and magnetism and elementary telephony which must form the basis of almost every branch of plant training, the students are taught the principles of automatic telephony; the layout of the system; the various call routes; and the construction principles and characteristics of every piece of apparatus employed. Then comes a series of touring lectures in one of the automatic exchanges, during which the students are given an opportunity for studying the apparatus layout, cabling, and general operation. Following this, instruction is given in circuit reading, circuit operation, and the use of wiring diagrams; after which, call tracing, fault location, and general maintenance is dealt with in detail.

The automatic demonstration unit is found to be extremely useful during this training, since it provides a comprehensive view of the whole sequence of operations; it is particularly useful during the preliminary lectures, and later, during lectures and practice on fault location.

The somewhat difficult subject of circuit training is dealt with by first giving instruction in circuit conventions and general circuit knowledge. Following this, and after the function of the circuit and the layout of the diagram in hand has been clearly explained and understood, each portion of the circuit is dealt with consecutively by showing the complete circuit and simplified sketches of its various parts on the screen, and by training the students to follow the operations on practice diagrams under the guidance of the teachers. Special efforts are made to teach the students to build up their knowledge of the circuit from their understanding of the functions it has to fulfil. Further assistance is given by issuing to each student a copy of all the more important diagrams, together with detailed circuit descriptions for home study and future reference purposes. The foregoing constitutes a preliminary course which usually lasts from three to four months, after which the students are posted to an exchange, there to apply their knowledge and to gain experience. Subsequent training includes a Machine Adjustment Course which is carried out with the aid of fifteen special frames which are installed in the school. Each of these frames is equipped with one line finder, one sequence

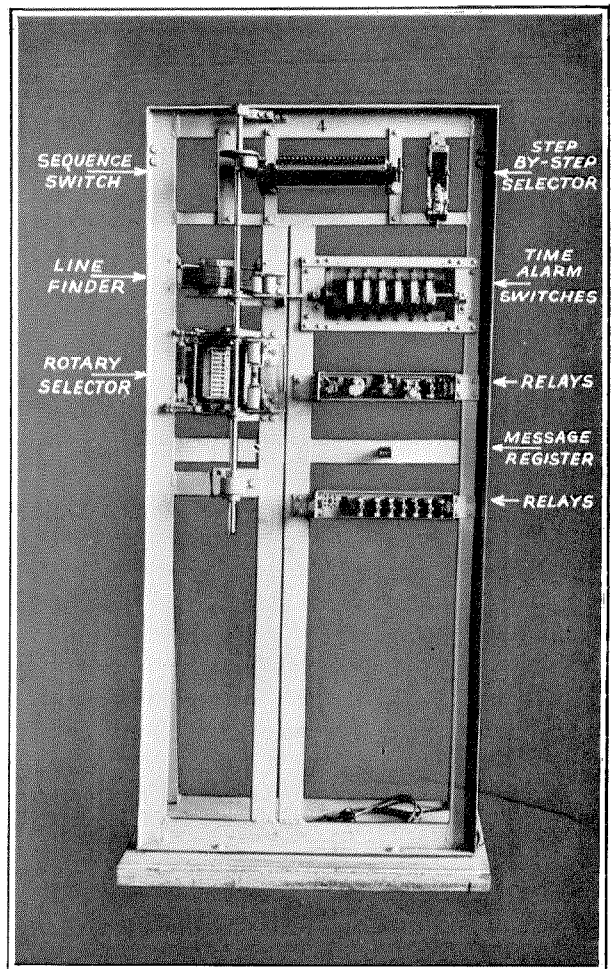

Figure 7—Apparatus Frame Used in Machine Adjustments Training.

switch, one step-by-step switch, one rotary selector, one time alarm switch, one message register, and two sets of relays, together with some typical gears and shafting, and a plug and socket arrangement for obtaining the necessary current when carrying out electrical tests. The two sets of relays referred to comprise one set of typical relays such as are used in the exchanges, and one set of old relays which are used for giving preliminary training in the use of adjusting tools. These frames, one of which is shown in Fig. 7, are constructed of angle iron and flat iron bars recovered from old apparatus racks, and they are mounted on wooden bases so that they can be moved to suit lighting or class arrangements as required. The frames are numbered to facilitate supervision, and the equipment is so arranged

that all adjustments can be carried out under practically the same conditions as obtain in an actual exchange.

A brief description of the method of conducting the Machine Adjustment Course follows. Since similar methods are adopted in all other courses, it will serve to illustrate the general training procedure.

As for most other courses, special work sheets for each separate part of the course are prepared by the school and issued to the students for use during lectures and practice, and for home study. These work sheets, which are stenciled in single space type on foolscap, are written in as clear and simple a manner as possible, and are intended to convey all essential information, much of which, under other circumstances, would have to be dictated to, and noted by, the students during lecture time. A considerable amount of valuable time is thus saved, and the students are assured of correct information for studying and for future reference purposes. The work sheets issued during the Machine Adjustment Course consist of ninety pages containing general information regarding the care of equipment, detailed instructions covering inspections, tests, adjustments and replacements, explanatory drawings and data for use when carrying out adjustments on the practice frames.

The preliminary lectures during this particular course deal with the care of tools, explanation of data terms, the uses of current flow test sets, and other general adjustment knowledge. When these points have been covered, each piece of apparatus is taken in turn as a separate part of the course, and is dealt with in the following manner:

The first step consists of a brief revision of the construction and characteristics of the apparatus in hand, and instruction in ordinary care and maintenance, including lubrication where necessary. The students are then taught the proper uses of the various tools and are allowed to spend an appreciable amount of time in practicing these uses on old apparatus under close supervision. Next, each separate test, adjustment or group of adjustments is dealt with by means of illustrated and demonstrated lectures, after which the students are required to carry out the work on their respective frames under the supervision and

guidance of the teachers and with the aid of their sheet notes and data. When all adjustments on a particular piece of apparatus have been dealt with in this manner, the apparatus is placed completely out of adjustment, and the students are required to carry out a complete check and re-adjustment, as far as possible unaided by the teaching staff. After the satisfactory completion of this work, further instruction and practice is given in dismantling, reassembling and replacement of parts, this being followed by a further complete check and readjustment.

The foregoing procedure is followed throughout the course with very satisfactory results, and the total time taken by full time classes is divided up roughly as follows:

Key, jack, and message register adjustments . . .	20 hours
Relay adjustments . . . . .	68 hours
Line finder adjustments . . . . .	40 hours
Group and final selector adjustments . . . . .	57 hours
Sequence switch adjustments . . . . .	35 hours
Step-by-step switch adjustments . . . . .	45 hours
Time alarm switch adjustments . . . . .	20 hours
Total time . . . . .	285 hours

A photograph of a Machine Adjustment Class at work is shown in Fig. 4. This picture, incidentally, also shows the Epidiascope in the centre foreground and a portion of the school museum in the glass cases on the left.

In common with the procedure followed during all other full and part time courses, a system of close observation and marking, coupled with a series of tests and examinations which are conducted periodically, serves to provide a record of progress which enables the school staff to classify the students according to their ability. This record is used in the compilation of a final report which shows details of progress and includes opinions and recommendations, and which is submitted to the Division Chiefs concerned when the men are returned to normal duty.

A follow-up card for each individual student is prepared and maintained by the school for one year following the conclusion of each course; this card contains details of the student's record of service and his progress during training, and it also provides space for four separate field reports which are supplied by the respective Division Chiefs, to whom the cards are sent at the end of each three months. A record of the student's

progress subsequent to training is thus obtained, and can be made use of in the organisation of review courses, if and when such are required.

The foregoing paragraphs outline a few of the more important types of training which are carried out by the school. A number of other subjects have been dealt with in a similar manner, such as courses covering the Police Street Telephone System, Teleprinter work, the training of test clerks, and general testing (covering the uses of Tone Test Sets, the Megger and the Wheatstone Bridge). With regard to the training of test clerks, an interesting arrangement is shown on the centre panel of the wire chief's desk in Fig. 2. This consists of twelve two-way keys and an associated test jack, which are used to teach the men to recognise and understand all the various line conditions which are met with in the field. The keys are connected in various ways to battery, ground, condensers, resistances, and other apparatus located inside the desk, so as to facilitate the connecting of the various line conditions, via the jack and a testing cord, to the testing circuit. Thus, a testing student, merely by inserting a test cord into the jack, and by operating one of the condition keys in conjunction with the various testing circuit keys, can observe and study any line condition, such as low insulation resistance, battery and ringing contacts, condensers in series and parallel, short circuits, grounds, normal conditions on subscribers' lines and trunks, etc. Adjacent to each condition key is a simple diagram showing the testing circuit conditions in light line, and the conditions of the supposed circuit under test in heavy line. This arrangement is found extremely useful, not only during the preliminary stages but throughout the testing course.

One type of training which is worthy of mention, is the organisation of short courses to cover rush job requirements. This type of training was found particularly useful during the conversion period, when large gangs of men were brought into the school for one or two days only, and were taught the most efficient and expeditious methods of carrying out cutover or conversion work, such as the fitting of duplicate apparatus in subscribers' premises, fitting of dials to C.B. instruments, etc.

As already mentioned, evening classes are con-

ducted over eight months of each year, the school being closed to evening classes only during the very hot season. These classes are entirely voluntary and are very popular, large numbers of the staff, both foreign and Chinese, taking advantage of this method of revising or improving their knowledge. In passing, it may be of interest to note that the foreign staff referred to, comprises several different grades and nationalities, and includes men specially engaged and brought out from various western countries, together with a number of locally engaged British, Americans, Russians, Japanese, Portuguese, etc. During the 1932-1933 session, ten separate classes were conducted weekly and, including a certain number of men taking more than one course, the evening class roll carried no less than 512 students. The subjects covered included several of those already mentioned, as well as various special classes dealing with such subjects as Service Order Practice, General Telephone Knowledge classes for Traffic, and Commercial Staff, etc.

Evening classes during the 1933-1934 session, comprised seven separate classes for which 330 students enrolled. The programme included a series of lectures on Economics and another on Teleprinter work, while an interesting departure was the inauguration of a special discussion course on subjects leading up to a study of Carrier Current and Wireless Telephony. This latter course, attended by 76 foreign and Chinese students, was conducted along somewhat unusual lines, in that a portion of the lecture work was carried out by the students themselves under the guidance of the teaching staff. Under this scheme, certain members of the class volunteered to make a particular study of a portion of the syllabus, one man taking the subject of vacuum tubes, another taking amplifiers, and so on, while the remainder of the class was required to make a general study of the various subjects in accordance with the syllabus. The course followed a progressive schedule, and each subject was dealt with by the student concerned in a series of short illustrated and demonstrated lectures, each lecture being followed by a discussion period. This class was exceptionally keen, and the scheme shows promise of being very successful. The work covered provides useful revision for the more advanced students, and also enables the

members of the class as a whole to improve their knowledge of communications developments.

In addition to its normal function of training plant staff, the school has proved of considerable value in the training of P.B.X. operators, and also in the training of salesmen and business office staff in the rudiments of telephone work and a knowledge of subscribers' apparatus and facilities. The value of the latter training, which consists of lectures and demonstrations in the school and one month spent on a touring course throughout the various divisions, cannot be exaggerated, since it enables the man behind the counter, or the canvasser, to conduct his business in a much more convincing and efficient manner.

The foregoing has dealt with staff training activities which are carried out entirely by the Education Division. A certain amount of training is also constantly being conducted in the field, more especially by the Traffic Department, which is continuously training supervisors and operators in new and revised routines and operating procedures.

The question of staff education is one which undoubtedly presents many difficulties wherever it occurs, but in Shanghai these difficulties are added to by conditions which are not usually encountered in western countries. Among these is the low standard of education of the average Chinese workman, particularly in a technical sense, which necessitates the considerable lengthening of the training period, and also results in a somewhat lower general standard of efficiency being obtained than in many other parts of the world.

In passing, it may be said that one of the greatest drawbacks to technical education in Shanghai has been the lack of a properly organized technical college, which could be made use of by the large numbers of youths who may be desirous of entering the various engineering trades and professions. The present indications are, however, that this deficiency will soon be made up, since there are prospects of having an up-to-date establishment in the near future in the form of the Lester School and Technical Institute.

Another great difficulty experienced in Shanghai is that of language; this is not merely a question of English and Chinese, but of many

different Chinese dialects. In China, it may be remarked, a dialect is practically a language in itself. Thus, in Shanghai, where the Shanghai dialect, of course, predominates, a native may find considerable difficulty in speaking to, or understanding, a man from the north or south of his own province, and much greater difficulty in conversing with natives of other provinces. The conditions arising in this respect may be imagined, when it is realised that large numbers of natives from all over China are found in Shanghai, and that it is no uncommon thing to find two Chinese attempting to converse in pidgin-English, or using an interpreter who is familiar with both their dialects. This aspect makes itself felt very keenly during training, since classes often comprise men from several different provinces. There is also the fact that there are no equivalents in the Chinese tongue for the various technical terms and it has been found that, prior to training, many of the men were in the habit of using Chinese terms indicating things which possessed some physical resemblance to the apparatus in question. For example, a slow speed time alarm switch was referred to in the Chinese term for "tortoise"; a black box containing a wiring plan switching key as a "small coffin"; a telephone connecting block or rosette as a "baking cake"; a dial as a "watch" or sometimes as a "plate," etc. It is therefore very necessary to teach students to interpolate the correct English term when writing or speaking of the various pieces of apparatus in their own language.

Other difficulties encountered are those bound up with the characteristics of the Chinese. For example, due to their innate passivity, it is extremely difficult for a foreign, or even a Chinese teacher lecturing to a class of Chinese, to know whether his teachings are being understood or not whereas, with a foreign class, it is generally easy for a teacher to gauge the degree of interest being taken in the subject by each individual student. Further, particularly during the early training stages, it is practically impossible to induce Chinese students to ask questions or even to answer them; this, it is thought, is due in part to the fear of "losing face."

Most of the foregoing difficulties are, however, overcome by the exercise of patience and per-

severance. Despite his handicaps, the average Chinese workman is on the whole, quite a good type. When properly trained and carefully supervised, a great many prove very satisfactory and compare favourably with workmen more fortunately placed; they possess considerable natural manipulative skill and are generally very willing and hard workers. By many, they are credited with having exceptional memories, but this opinion probably arises from the fact that the Chinese use their memories to a much greater extent than do the westerners. For example, a Chinese student taking an examination will frequently give an answer coinciding almost word for word with the work sheets from which he has been studying, while making some small slip which proves that the real meaning of the subject is not thoroughly understood. It is also quite a common occurrence to find a Chinese wireman

repeatedly carrying out a fairly complicated wiring scheme without reference to a diagram: whereas, if the same man were presented with a similar scheme with which he was not familiar, he would probably find considerable difficulty in immediately proceeding with the work. This memorising habit, which is not encouraged during training, is probably due to a great extent to the trait of passivity already mentioned, in that this tends to make memorising a more congenial method of learning than critical, analytical reasoning and assimilation.

In conclusion, while the results obtained undoubtedly justify the effort expended, it will be realised that the process of making reliable telephone men of Chinese of the working classes is no easy matter, and that the training procedure must necessarily be very slow and demonstrative.

# Radio Broadcast Receivers

By J. S. JAMMER

Assistant Vice-President, International Standard Electric Corporation

and L. M. CLEMENT

Chief Engineer, Radio Broadcast Receivers,  
International Telephone and Telegraph Laboratories, Incorporated

**I**N the October, 1933 issue of *Electrical Communication*, the authors described the broadcast radio receiver programme for last year. During the year, the companies in the International System Group manufactured and sold approximately a quarter of a million receivers. When it is realised that over eighty per cent. of this activity took place in a period of four months, one begins to appreciate the severe load thrown on the manufacturing facilities. At the peak period, the receivers were being

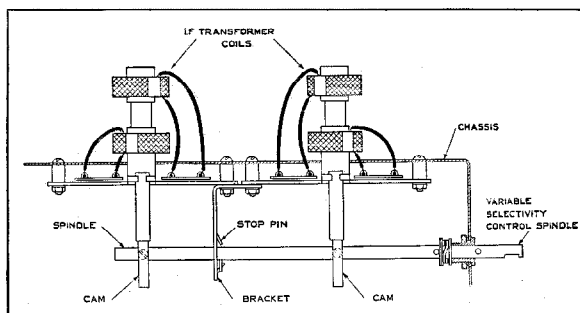

Figure 2—Sketch Showing Mechanics of Variable Selectivity

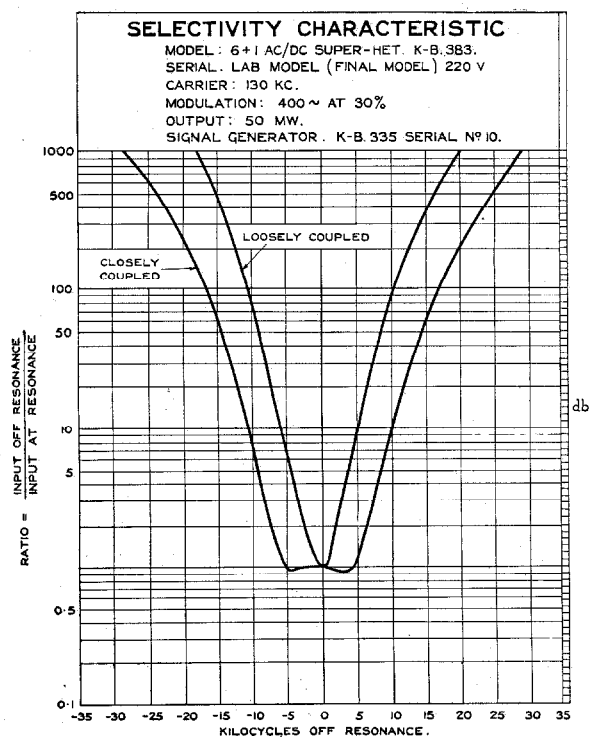

Figure 1—Selectivity Characteristic of Variable Selectivity Receivers. Curves Show Effect on Selectivity and Band Width of Operating the Selectivity Control Knob from Most Selective to Highest Fidelity Positions.

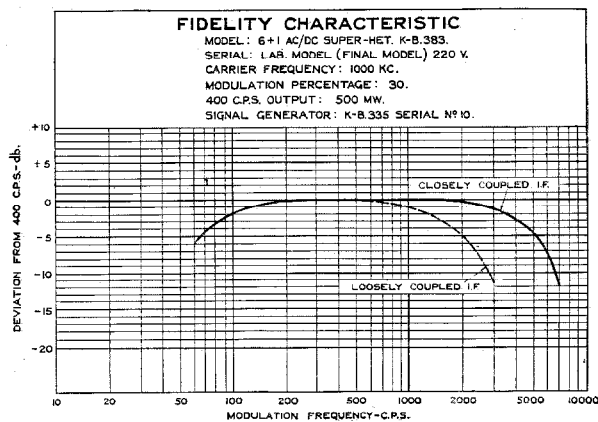

Figure 3—Curves Showing Effect on Fidelity of Varying the Selectivity Control on K.B. 383 Receiver from Maximum to Minimum.

produced at the rate of about one every twenty seconds.

Because of the very great number of high power broadcast transmitters in Europe, it has been necessary, in the past, to design receivers with a very high degree of selectivity and consequent sacrifice of fidelity. The average purchaser, although extremely anxious to secure a very selective receiver at the time he acquires the



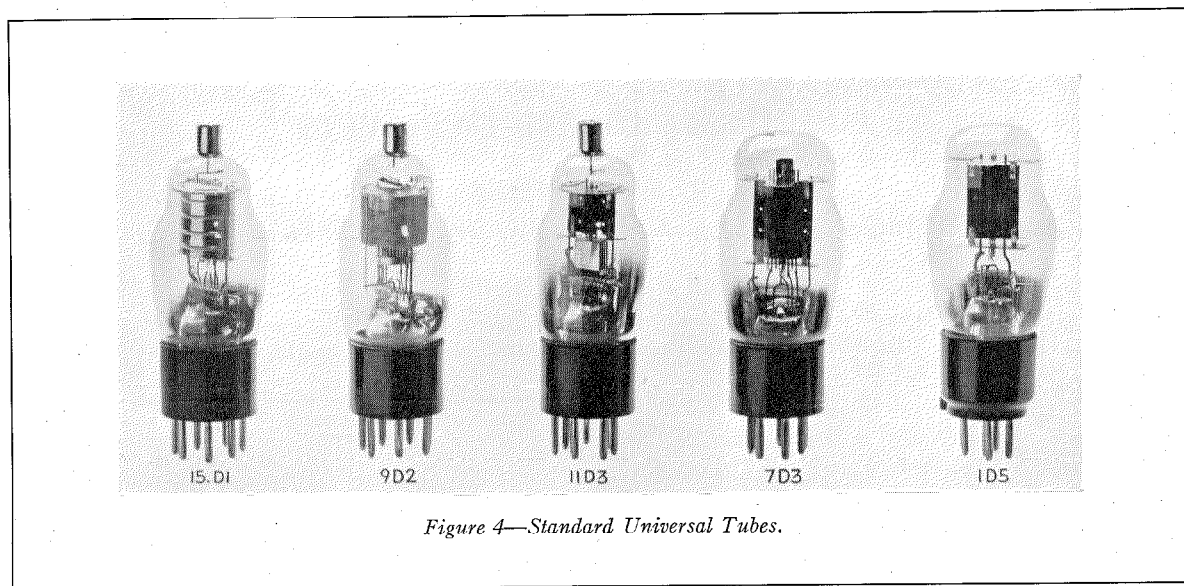

Figure 4—Standard Universal Tubes.

instrument, subsequently finds that he is not particularly interested in the reception of distant stations but is more concerned with high fidelity reception of nearby stations. Consequently, after owning the receiver for a short time, he feels that he prefers high fidelity instead of high selectivity.

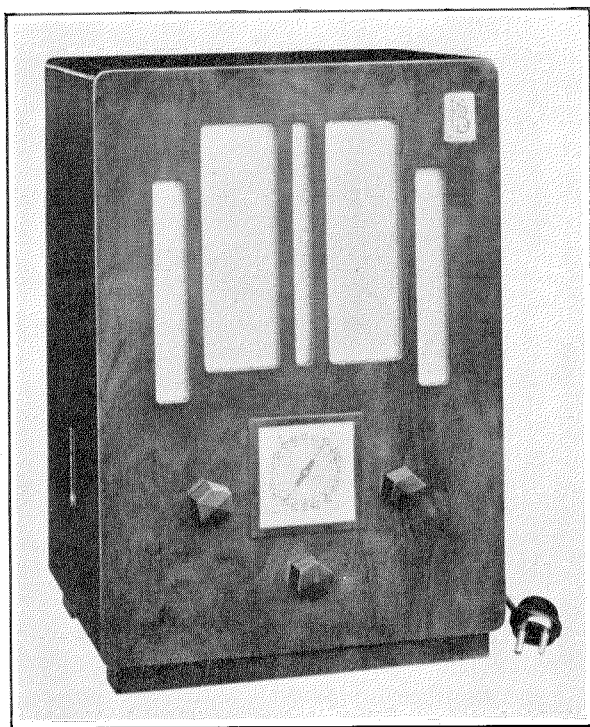

Figure 5—K.B. 362 and K.B. 397 3-Tube Battery and 3-Tube (2+1) a-c. Inexpensive Receivers.

This year, therefore, some of the receivers have been equipped with a very ingenious device which enables the owner to adjust the selectivity of the set at will to give any band width of reception he may require.

This variable selectivity is obtained by a mechanical change in the relative positions of the coils in the intermediate frequency transformers. Each of these transformers has one stationary and one movable coil. The position of the movable coils is controlled by two cams in tandem bearing on the face of the brackets and actuated from the front of the receiver. With the coils spaced at the greatest distance, the intermediate frequency transformer is just below the critical coupling, and this results in an extremely sharp selectivity characteristic, as shown in Fig. 1. When the coils are brought close together, the transformer is over-coupled and a broad band-pass characteristic results. Fig. 2 illustrates the mechanical arrangement of this feature.

With this variable selectivity feature, the overall fidelity characteristic of the receiver can be altered from a band of about 3,000 cycles, which is the normal for most receivers in Europe, to a band of about 7,000 cycles, thus enabling the set, under this latter condition, to reproduce faithfully many instruments of an orchestra, speech, and other sounds which ordinarily are not heard on the average broadcast receiver. Curves showing the effect of fidelity are given in Fig. 3.

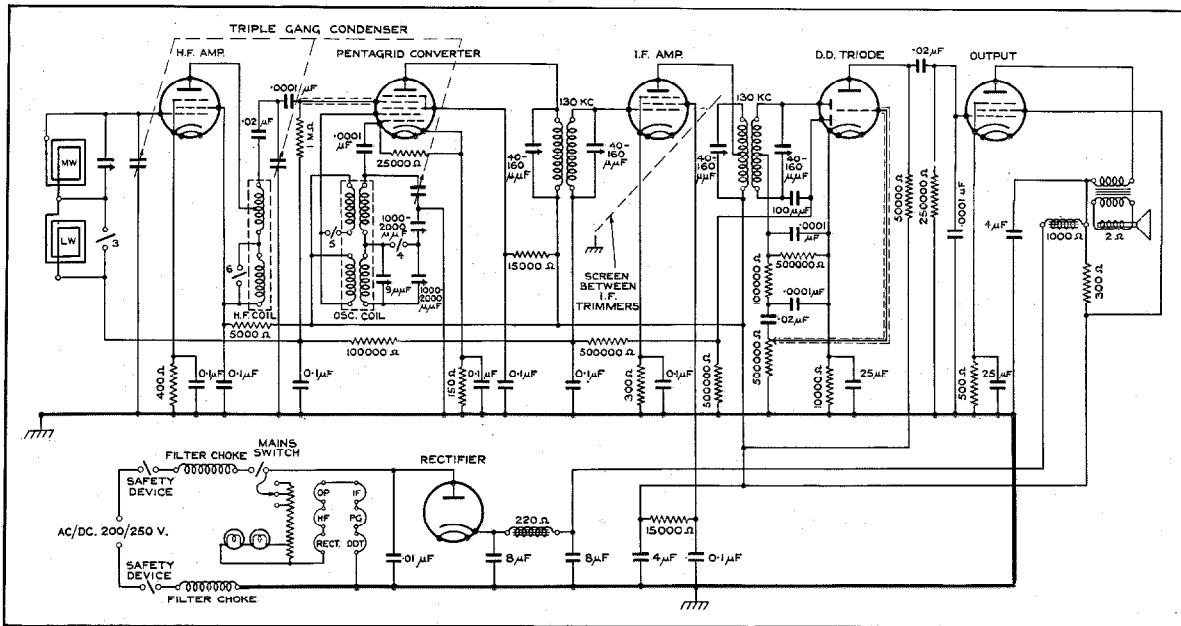

Figure 6—Schematic Diagram of K.B. 405 Transportable Receiver.

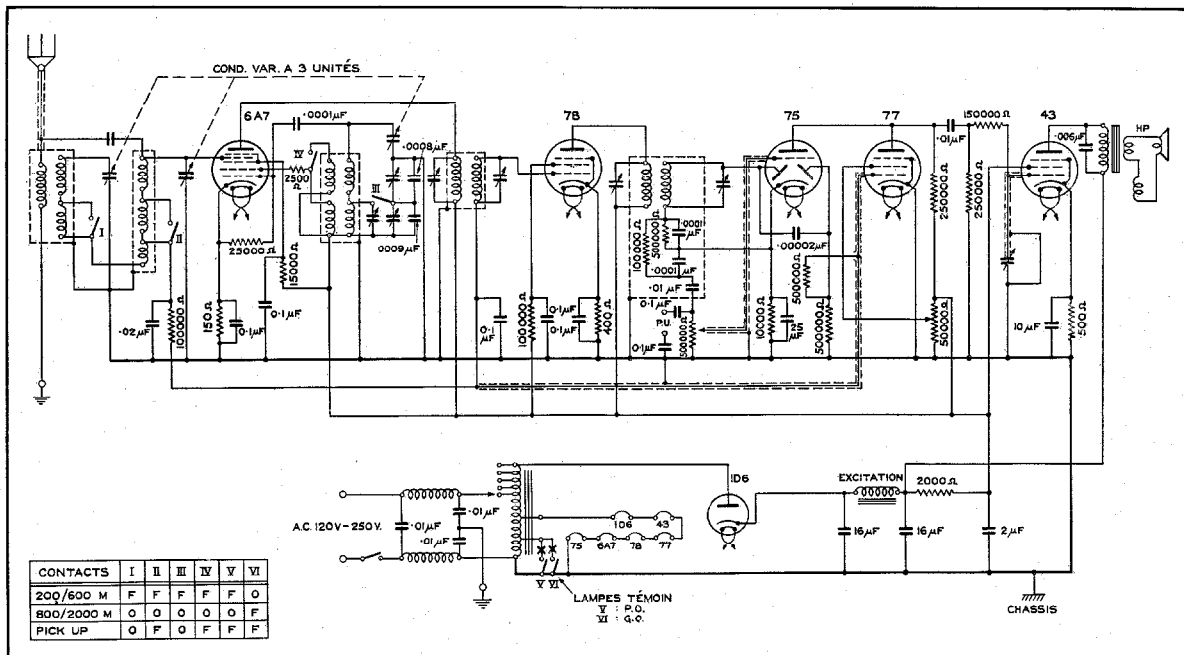

Figure 7—Schematic of Bell Tel. Mfg. Co. "Bell 6" 6-Tube (5+1) a-c. Receiver.

Most of the receivers this year include open face tuning dials, popularly called "airplane" or "clock" type. Delayed automatic volume control is used in some models to enable weak stations to be received with satisfactory volume.

The International Group of companies last year was the first to introduce silent tuning and automatic tone compensation in Europe. These features are, of course, included again this year. A great deal of attention has been paid to

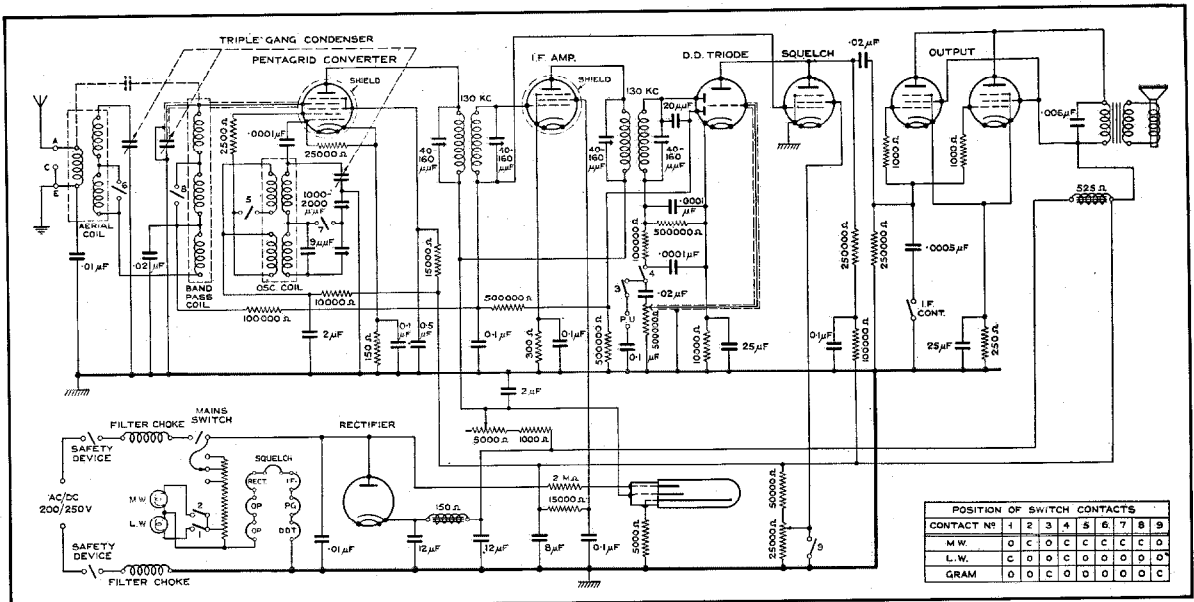

Figure 8—Schematic of K.B. 383 Variable Selectivity Radio Receiver.

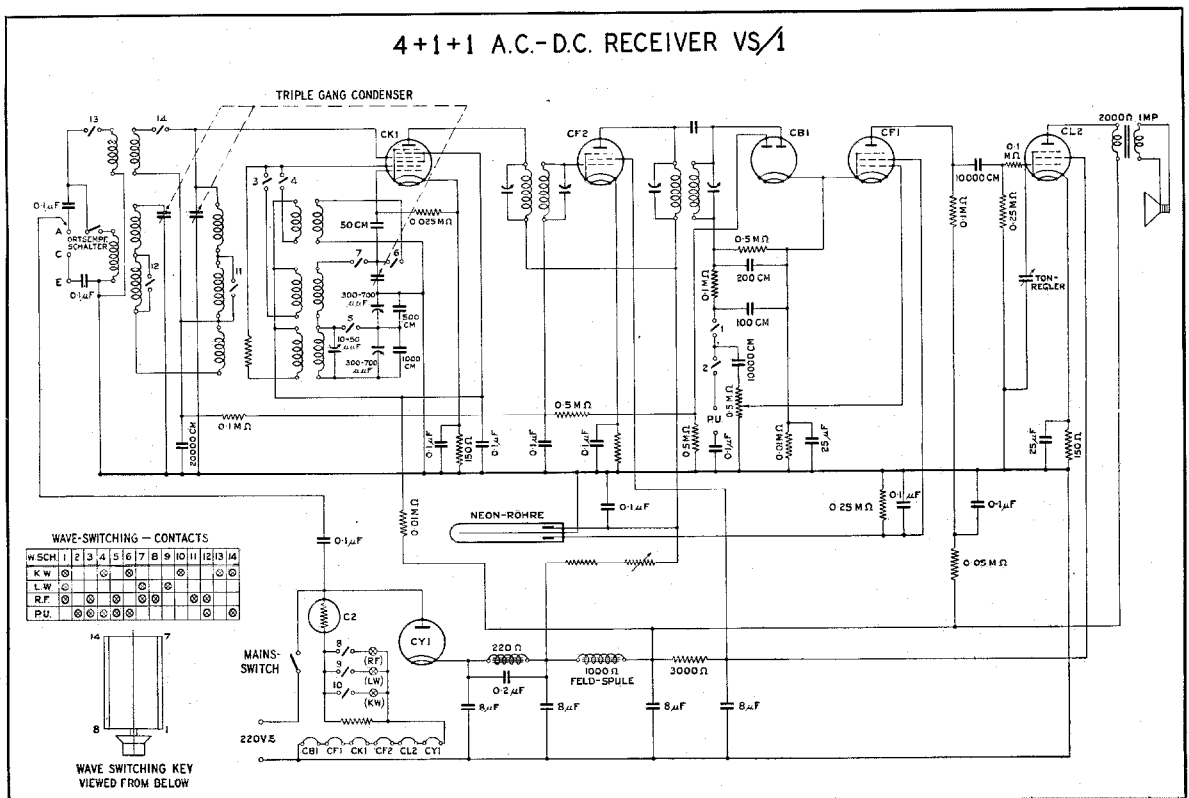

Figure 9—Schematic of Vienna a-c./d-c. Receiver.

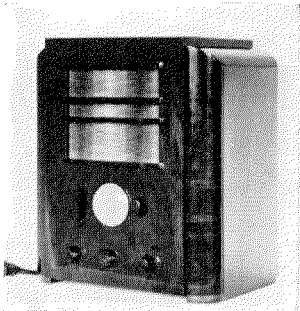

Figure 10—Standard Vienna 5-Tube (4 + 1) a-c. Receiver with Protection Scale and Neon Tuning Beacon.

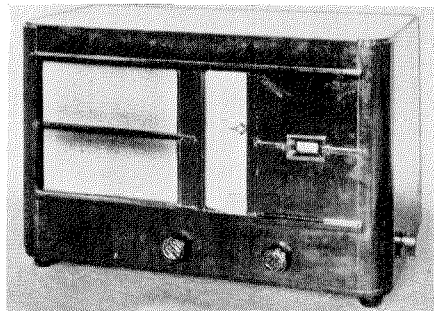

Figure 11—Standard Budapest Super 35 6-Tube (5 + 1) a-c. Receiver with Vertical Drum Full Vision Dial.

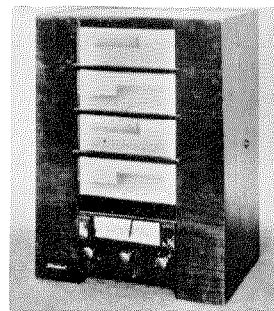

Figure 12—Standard Budapest 2x, 3-Tube (2 + 1) a-c. Receiver.

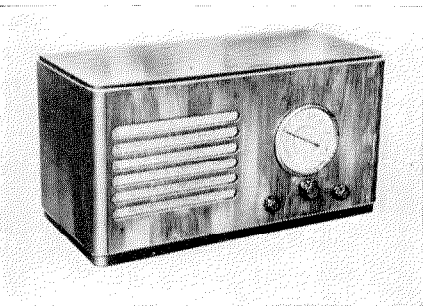

Figure 13—At Left: Le Matériel Téléphonique (L.M.T. 43) 5-Tube (4 + 1) a-c. Receiver with Airplane Type Dial.

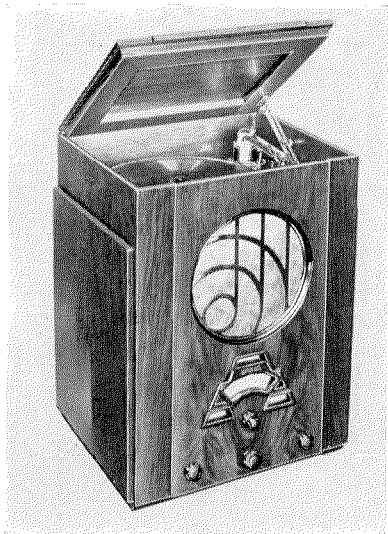

Figure 14—L.M.T. 163—7-Tube Radio Receiver and Gramophone. Shows Full Vision Dial with Neon Tuning Beacon and Station Projection Screens.

Figure 15—At Right: Bell Tel. Mfg. Co. 5 a-c and 5 a-c./d-c. Receivers; 5 Tubes with Full Vision Dial.

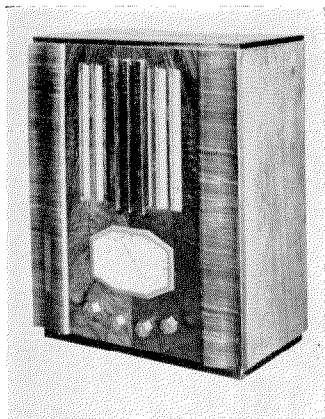
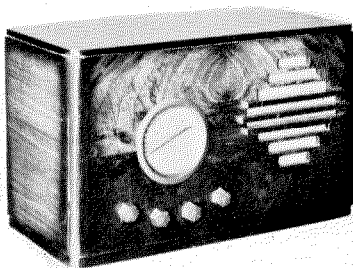

Figure 16—Bell Tel. Mfg. Co. 6 a-c. and 6 a-c./d-c. 6-Tube (5 + 1) Radio Receiver with Clock Type Dial and Station Projection Scales.

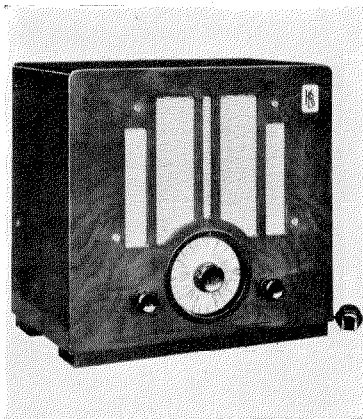

Figure 17—K.B. 381 5-Tube (4 + 1) a-c./d-c. Receiver with Full Vision Dial.

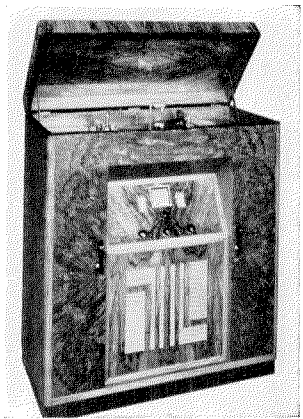

Figure 18—K.B. 366 8-Tube (7 + 1) a-c. De Luxe Radio Receiver and Automatic Record Changing Gramophone.

cabinet design and general appearance, not only to improve the mechanical construction, but to cater to the local tastes in each country.

In order to ensure reliability and facilitate the interchange of tubes without disturbing the set performance, many of the receivers are designed to use so-called low slope universal tubes. These receivers are also suitable for operation on either alternating or direct current. The System tube factory, in addition to the types made last year, is now producing five new types, as listed below and illustrated in Fig. 4, of these low slope universal tubes.

Description	Type No.
Pentagrid converter	15-D-1
R.F. Pentode	9-D-2
Double Diode Triode	11-D-3
Output Pentode	7-D-3
Rectifier	1-D-5

There is still a considerable demand for battery sets, and a complete range of receivers to meet this requirement is included in this year's programme. These range from an inexpensive 3-tube simple regenerative set to a de luxe 6-tube super-heterodyne Class "B", the latter incorporating

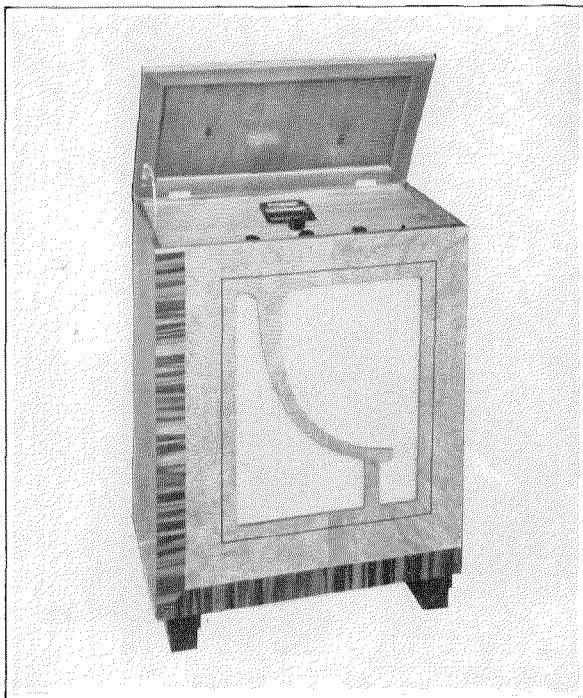

Figure 19—K. B. 383 7-Tube (6+1) a-c./d-c. Radio Receiver Incorporating Variable Selectivity, Neon Tuning Beacon, Silent Tuning, etc.

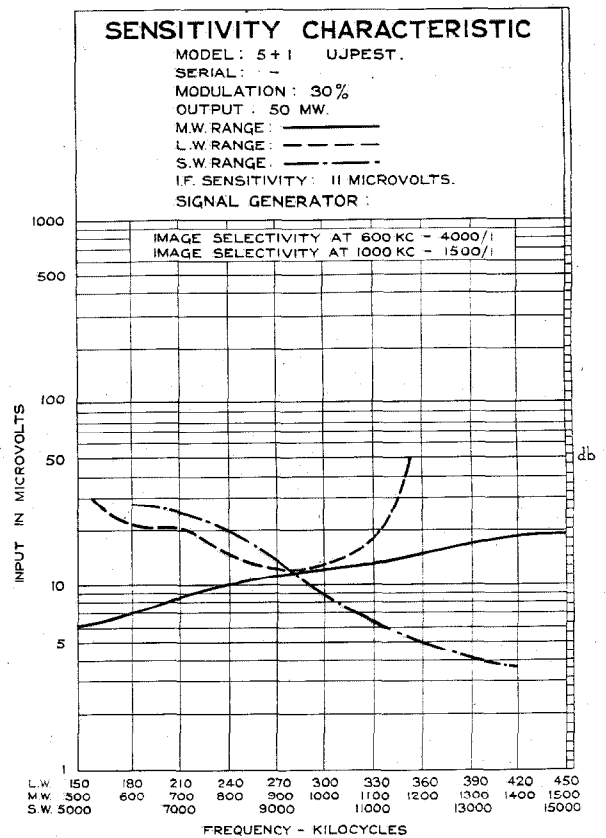

Figure 20—Sensitivity Characteristic of Standard Budapest 35 6-Tube (5+1) Radio Receiver.

all features hitherto available only in a-c. receivers. Fig. 5 shows a 3-tube battery set.

Figs. 6, 7, 8, and 9 show circuit diagrams of some of the new sets, and Figs. 10 to 19, inclusive, show completed models of various types. The sensitivity characteristics of a 6-tube receiver manufactured at Budapest are shown in Fig. 20.

In addition to this complete range of the normal form of domestic receivers, including thirty different models, remote control receivers for special users and motor car receivers have been developed. They are illustrated in Figs. 21 and 22.

Due to the increasing number of short-wave broadcasters which have been erected throughout the world, there is a growing demand in Europe for domestic broadcast receivers capable of receiving these stations. Some of the standard models include this facility, and the basic design of all the models is such that short-wave can be incorporated at little additional expense, if required.

The "Rejectostat" has proved to be a successful means of improving broadcast reception through the elimination of man-made static and, similar to last year, all of the new models are designed to work with the "Rejectostat". The public is showing an increasing interest in the use of this device.

As was the case last year, the receivers produced by the companies in the International Group are based on the same fundamental designs. They differ, however, in certain characteristics from one country to another in order to meet particular local conditions.

Special attention is being paid this year to inspection methods, so as to reduce service troubles to the absolute minimum. To ensure a

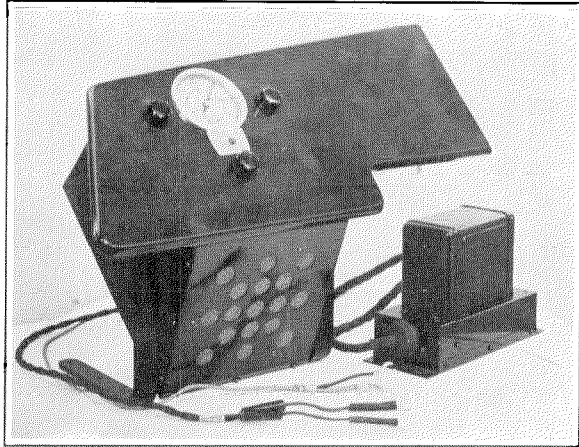

Figure 22—K.B. 387 Motor Car Receiver and Dynamotor Power Supply Unit for Dash Board Mounting.

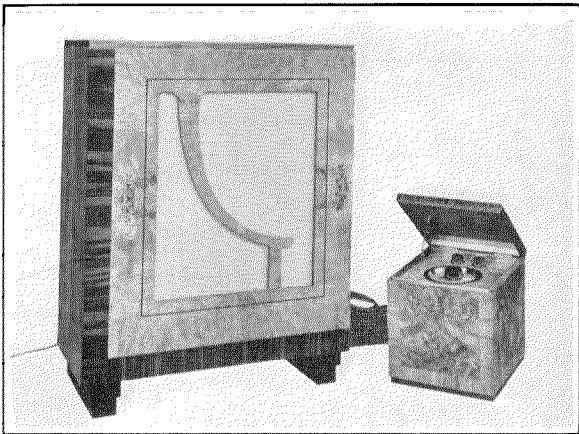

Figure 21—Kolster Brandes Remote Control Radio Receiver Showing Remote Tuning Unit and Power Amplifier Unit. This Receiver has a Built-In "Rejectostat".

high degree of reliability, the factories give all components—mechanical assembly, soldering and continuity—a one hundred per cent. inspection. Tubes are put through a severe shaking and ageing test, and every receiver, of course, is given a severe final inspection. In addition, a percentage of each type of set is put on a life test and operated for hundreds of hours, so as to reveal any defects which may have passed through the severe inspection described above. Fig. 23 shows the life testing at Paris. Every receiver is operated for a number of hours before being shipped to the customer.

The tables below list the principal receivers being manufactured and sold this year, showing for each location the types, as well as the features and characteristics of the sets.

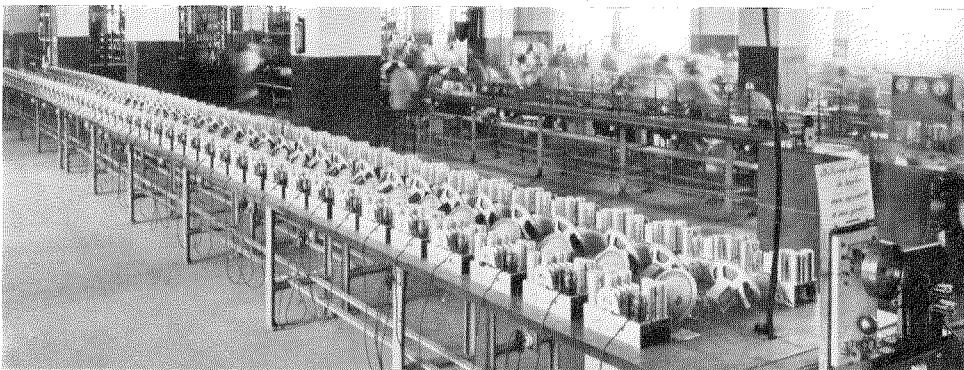

Figure 23—Life Test Rack for 100 Receivers, Boulogne Factory.

Factory	Name or No. of Tubes	Type	Wavelength Range	Cabinet Type	Features
Antwerp	Bell 5 a-c./d-c. Receiver 5 (4+1)	Superheterodyne 145 kc. intermediate frequency	200/600 800/2000	Horizontal Table type	Low Slope tubes; Airplane dial; a-c./d-c. 115-135 volts; Rejectostat; Tone Control
	Bell 5 a-c. Receiver 5 (4+1)	Superheterodyne 145 kc. intermediate frequency	200/600 800/2000	Horizontal Table type	Low Slope tubes; 2 watts output; Airplane dial; a-c. 110-240 volts; Rejectostat; Tone Control
	Bell 6 a-c./d-c. Receiver 6 (5+1)	Superheterodyne 145 kc. intermediate frequency	200/600 800/2000	Vertical Table type	Low Slope tubes; 1 watt output; Clock type dial, with illuminated station names; a-c./d-c. 115-135 volts; Rejectostat; Automatic Volume Control (AVC); Silent tuning (QAVC); Large dynamic speaker
	Bell 6 a-c. Receiver 6 (5+1)	Superheterodyne 145 kc. intermediate frequency	200/600 800/2000	Vertical Table type	Low Slope tubes; 2 watts output; Clock type dial, with illuminated station names; a-c. 110-240 volts; Rejectostat Tone Control; Automatic Volume Control (AVC); Silent tuning (QAVC); Large dynamic speaker
	Bell 7 a-c. Receiver 7 (6+1)	Superheterodyne 145 kc. intermediate frequency	19/50:200/600: 800/2000	Console type	European type a-c. tubes; 6 watts output; Clock type dial with illuminated station names; a-c. 110-240 volts; Rejectostat; Variable selectivity—variable fidelity; Automatic Volume Control (AVC); Silent tuning (QAVC); Tone compensation; Tone Control; Push pull triode (Three element tubes) output valves; Double speakers to cover range 50-7000 cycles
Budapest	Standard 2x a-c. Receiver 3 (2+1)	Regenerative T.R.F.	200/600:800/2000	Vertical Table type Cabinet	European a-c. tubes; 95-250 volt a-c. Trolitul variable condensers; Litz Coils; Wave trap; Full vision scale; Rejectostat
	Standard Super X 4 (3+1)	Superheterodyne	20/50:200/600: 800/2000	Table type Cabinet	European a-c. tubes; 95-250 volt a-c.; Full vision scale calibrated for wavelength and stations; Local distant switch; Tone Control; Rejectostat
	5(4+1)	Superheterodyne	20/50:200/600: 800/2000	Table type Cabinet	Scale arrangement same as Standard Super X; Delayed automatic volume control; Visual shadow tuning; Local distance switch; Tone Control; Rejectostat
	Super 35	Superheterodyne	20/50:200/600: 800/2000	Table type Cabinet	Delayed automatic volume control; Shadow tuning indicator; Local distance switch; Variable fidelity feature; Tone Control; Special vertical illuminated drum type scale, calibrated in metres and station names; Rejectostat
London	KOLSTER BRANDES A-C. RECEIVERS				
	KB-397 3 (2+1)	Regenerative T.R.F.	200/600:800/2000	Vertical Table type	Clock type scale, calibrated in station names; a-c. tubes; 200-240 volt a-c. Rejectostat

Factory	Name or No. of Tubes	Type	Wavelength Range	Cabinet Type	Features
London	KB 444 4 (3+1)	Superheterodyne	200/600:800/2000	Horizontal Table type	a-c. operation; 200-240 volt; Dynamic speaker; Rejectostat
	KB 666 6 (5+1)	Superheterodyne	200/600:800/2000	Horizontal Table type	a-c. operation; 200-240 volts; Automatic Volume Control (AVC); Tone Control; Tone compensation; Rejectostat
	KB 888 8 (7+1)	Superheterodyne	200/600:800/2000	Console Cabinet	a-c operation; 200-240 volts; Automatic Volume Control (AVC); Silent Tuning (QAVC); 5 watts output; 11-inch Dynamic speaker; Tone Control; Tone compensation; Rejectostat
	KB 366 8 (7+1)	Superheterodyne	200/600:800/2000	Console Cabinet	Combined automatic record changing gramophone and radio set; Same features as KB 888 and two speakers
KOLSTER BRANDES BATTERY RECEIVERS					
	KB 362 3	Simple regenerative	200/600:800/2000	Vertical Table type	Dynamic speaker; Clock type dial; Station names; Rejectostat
	KB-364 3	T.R.F.	200/600:800/2000	Table type	Dynamic speaker; Deluxe cabinet; Rejectostat
	KB-393 3	T.R.F.	200/600:800/2000	Table type	Dynamic speaker; Rejectostat
	KB-333A 3	T.R.F.	200/600:800/2000	Table type	Dynamic speaker; Rejectostat
	KB-363 4	T.R.F.	200/600:800/2000	Table type	Dynamic speaker; Class B output; 2 watts output; Rejectostat
	KB-398 6	Superheterodyne	200/600:800/2000	Table type	Variable selectivity; Dynamic speaker; Delayed automatic volume control; Tone control; 2 watts output; Rejectostat
KOLSTER BRANDES A-C./D-C. RECEIVERS					
	KB-381 5 (4+1)	Superheterodyne	200/600:800/2000	Table type	200-240 volts; Delayed automatic volume control (DAVC); Full vision scale calibrated in station names and metres; Rejectostat
	KB-383 Consolette 7 (6+1)	Superheterodyne	200/600:800/2000	Consolette	200-240 volts; Variable selectivity and fidelity; Delayed automatic volume control (DAVC); Silent tuning (QAVC); Neon tuning beacon; Calibrated in station names and metres; Rejectostat
	KB-383 Console 7 (6+1)	Superheterodyne	200/600:800/2000	Console	Same features as 383 Consolette, with two loud speakers
	KB-405 Transportable 6 (5+1)	Superheterodyne	200/600:800/2000	Transportable	Loop antenna; Delayed automatic volume control; Full vision scale, calibrated in metres and station names
	KB-387 Motor Car Rec. 5-tube	Superheterodyne	200/600:800/2000	Dashboard mounted or remote control from steering column	Car accumulator feeds motor gen. and supplies all H.T. voltages; Moving coil speaker; Delayed A.V.C.; Sensitivity 2 microvolts; Output 3 watts; Clock face dial
	KB-385 7 (6+1) Remote Control	Superheterodyne	200/600:800/2000	Consolette	Same features as 383 Consolette, with remote control facilities



Factory	Name or No. of Tubes	Type	Wavelength Range	Cabinet Type	Features
Paris	Type 63 LMT 7 (6+1)	Superheterodyne 135 kc. Intermediate frequency	200/600:800/2000	Table	a-c. Receiver; 110-240 volts; Low slope tubes; Automatic volume control (AVC); Silent tuning (QAVC); Tone compensation; Tone Control; Neon Tuning Beacon; Calibrated dial-station names projected; Filtrostat
	Type 253 LMT 6 (5+1)	Superheterodyne 135 kc. Intermediate frequency	200/600:800/2000	Table	a-c./d-c. Receiver; 100-125 volts; Low Slope Tubes; Automatic Volume Control (AVC); Silent tuning (QAVC); Open face, air-plane dial; Filtrostat
	Type 43 LMT 5 (4+1)	Superheterodyne 135 kc. Intermediate frequency	200/600:800/2000	Table	a-c. Receiver; 100-150 volts; Automatic volume control, 2 watts output; Open face airplane dial; Filtrostat
	Type 163 LMT 6+1 Radio Gramophone	Superheterodyne 135 kc. Intermediate frequency	200/600:800/2000	Table	Same as LMT 6+1 Type 63
Vienna	4 WS 5(4+1)	Superheterodyne	19/50:200/600: 800/2000	Table type	a-c. Receiver; European type a-c. tubes; Projection scale; Neon tuning indicator; Silent tuning; Automatic Volume control (AVC); Mains antenna; Rejeostat
	5 WS 6 (5+1)	Superheterodyne	19/50:200/600: 800/2000	Table type	a-c./d-c. Receiver; European type a-c./d-c. tubes; Ballast lamp; Same features as 4 WS

# Noise Limits in Long International Circuits

By JOHN COLLARD, Ph.D.

## Introduction

THE Comité Consultatif International states that the noise at the end of a telephone circuit should not exceed 2 millivolts. In accordance with the C.C.I. definition of noise voltage, this value of 2 millivolts corresponds to the actual noise e.m.f. induced in the circuit, so that the voltage at the end of the circuit, on the assumption that it is correctly terminated, is 1 millivolt.

The necessity for maintaining this limit of 2 millivolts can be seen from the curve published in the C.C.I. red book.<sup>1</sup> A similar curve is reproduced below. This curve shows values of the effective reduction in transmission quality due to different amounts of noise. The value of 2 millivolts corresponds to about 26 on the scale of this curve; and it will be seen that, while for lower values of noise voltage the noise has little effect on the quality, for values greater than this there is a very rapid increase in the reduction of quality produced by the noise.

The noise in a repeatered circuit consists partly of noise produced in the sections of line and partly of noise produced in the repeaters

<sup>1</sup> Comité Consultatif International des Communications Téléphoniques à grande distance, Assemblée Plénière de Paris, 14-21 Septembre 1931, page 575. English Edition issued by The International Standard Electric Corporation, London, 1932, page 327.

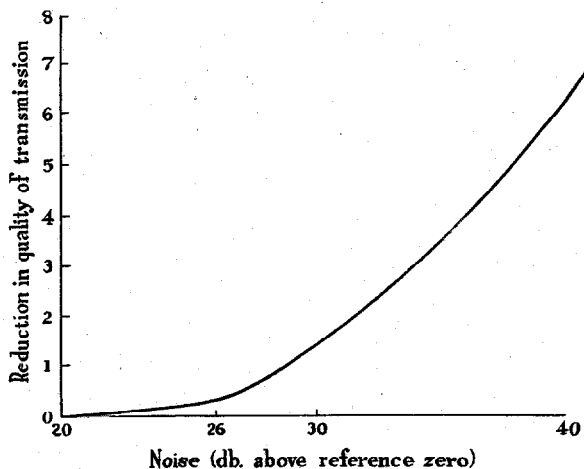

themselves, and in a circuit containing more than one repeater section the noise at the end of the circuit will obviously be due to the combined effect of the noises in the individual sections. Since a long distance circuit in the future may consist of 60 or more repeater sections, it is clear that the noise per repeater or per repeater section must be reduced to very small limits if the total noise is not to exceed 2 millivolts.

In the case of long repeatered circuits passing through several different countries, it is obvious that if the total noise is not to exceed 2 millivolts the noise contributed by each country must be something less than 2 millivolts.

It is, therefore, of interest to determine what limits of noise are permissible in individual repeaters and repeater sections and, where a circuit passes through several countries, how much noise each country may be permitted to contribute. The object of this paper is to study this question of the subdivision of noise amongst the component parts of the circuit.

## Limiting Values of Noise

Since we are concerned with the division of the total noise of 2 millivolts into a large number of parts, each individual part will be only a fraction of 1 millivolt. In order to avoid dealing continually with small decimal fractions, it is convenient to specify all noise voltages in terms of microvolts. In this paper, therefore, all values of noise will be expressed in microvolts, so that a noise of 150 will mean a noise of 150 microvolts or 0.15 millivolts. The total permissible noise thus becomes 2000.

Since European long distance international circuits consist largely of 4-wire circuits, we shall confine ourselves to this type of circuit. Let us, first of all, consider a circuit consisting of  $n$  repeater sections. There will, of course, be  $n+1$  repeaters and, for the sake of simplicity, we shall assume all sections are identical as regards the speech levels and induced noise. The value of noise introduced by a single repeater will be

called R and that introduced by a repeater section of line will be called C. It is assumed that the value R is measured directly at the output of the repeater while C is measured directly at the terminals of the repeater section of line.

The importance of the noise at any point in the circuit depends on the level of speech at that point. If, for instance, the level of speech at the given point is  $-20$  db. while the level at the end of the circuit is  $-10$  db., it is clear that the speech at the given point will be amplified by  $10$  db. by the time it reaches the end of the circuit. Since the noise follows the same path as the speech from the given point to the end of the circuit, the noise too will be amplified by  $10$  db. by the time it reaches the end of the circuit. If the speech level at the given point had been higher than at the end of the circuit, then the speech, and consequently the noise, would be attenuated by the time it reached the end of the circuit. Since the importance of the noise depends in this way on the level of speech, it is convenient to refer all values of noise to a fixed level. The C.C.I. limit refers to the end of the circuit where the level may be taken as  $-10$  db.; we shall therefore refer all values of noise to a level of  $-10$  db.

For purposes of illustration, the speech level at the end of a 4-wire repeater section of line can be assumed as  $-22$  db. The noise C which was assumed to be measured at this point will thus become  $4C$  ( $12$  db. gain) when amplified to the level of  $-10$  db. The level at the output of a 4-wire repeater may be taken as  $+4$  db., so that the noise R measured at this point will become  $0.2R$  ( $14$  db. loss) when referred to a level of  $-10$  db.

It should be noted that in the case of the terminal repeater in a 4-wire circuit the level is higher than  $-10$  db. Since the principal noise in a repeater, however, enters the circuit after the point where the gain is controlled, the noise at the output is still R. In this case, therefore, the noise at  $-10$  db. will be  $0.5R$ . If the gain of the terminal repeater is kept the same as the other repeaters and the difference in level is obtained by inserting an attenuation pad, then the noise due to the terminal repeater will, of course, be  $0.2R$ .

Since the phase relations of the different noises

are entirely random, the total effective noise will be obtained by adding the individual noises as the square root of the sum of the squares. The total noise N given by the  $n$  repeater sections and the  $n+1$  repeaters will therefore be:

$$N = \sqrt{n(4C)^2 + n(0.2R)^2 + (0.5R)^2}$$

if no pad is used in the terminal repeater, and

$$N = \sqrt{n(4C)^2 + (n+1)(0.2R)^2}$$

if a pad is used.

In order to obtain values for R and C, it is necessary to assume a value for  $n$ , the number of repeater sections. A reasonable value for a future long distance international circuit is  $80$  sections, so that we shall take  $n$  as  $80$ .

Since the case where no pad is used in the terminal repeater is slightly the more severe of the two, this case will be taken here. We therefore have, approximately,

$$N = \sqrt{(36C)^2 + (1.8R)^2}$$

Suppose we assume different values of R, the repeater noise, and see the effect on the value of C, the line noise, it being remembered that N is  $2000$ . The following table shows the value of C corresponding to different values of R.

Noise per Repeater R (microvolts)	Permissible Noise per Repeater Section of Line C (microvolts)
0	55
100	55
200	55
500	50
1000	37
1100	8

It will be seen that if the repeaters contribute no noise, the permissible noise per repeater section of line is  $55$ . Furthermore, provided R does not exceed  $200$ , the value of C is still  $55$ , showing that until the repeater noise exceeds  $200$  it is too small to add any appreciable amount to the total noise. As the value of R increases beyond  $200$ , the permissible value of C rapidly falls until for values of R above about  $1100$  practically the whole of the permissible value of  $2000$  microvolts is taken up by the repeater noise so that the amount allotted to the line must be kept extremely small.

Since the noise in repeaters, due chiefly to commutator ripples from charging generators, crosstalk from ringing current, etc., can be reduced relatively easily by suitable design of the repeater station and, since the line noise, which is due chiefly to induction from external power systems, cannot so easily be reduced, it seems reasonable to endeavour to permit as big an allowance as possible to the line noise. For this reason the limiting value of 200 for the value of R will be taken.

Tests carried out in recent years in a number of different countries have shown that it is possible to produce repeater stations in which the average noise per repeater does not exceed 200 microvolts.

If we assume, therefore, that the average value of noise introduced by a repeater shall not exceed 200 microvolts, we can then work out the value to which C, the line noise per repeater section, must be limited in order that the total overall noise shall not exceed 2000 microvolts. The amount of line noise which can be tolerated per repeater section will depend, of course, on the number of repeater sections comprising the complete circuit. In the following table values of permissible line noise per repeater section are given for different numbers of repeater sections on the assumption that the total noise should not exceed 2000 and the noise per repeater should not exceed 200 microvolts.

Number of Repeater Sections	Permissible Noise per Repeater Section
60	64
80	55
100	49
150	40
200	34

These values of noise represent the total noise which may be permitted per repeater section due to all causes. The noise is due partly to induction from external sources, such as H.T. power lines and electrified railways, and partly to induction, such as crosstalk, from other communication circuits. Noise measurements in many different telephone cables have shown that where no external induction occurs the noise due to internal induction is of the order of 25 microvolts per repeater section. In order to obtain a limit

for external induction, it is, therefore, necessary to allow for the presence of 25 microvolts due to internal induction. This has been done in the following table which gives values of permissible noise for external induction only.

Number of Repeater Sections	Permissible Noise per Repeater Section
60	59
80	50
100	42
150	31
200	23

The above values represent the noise which could be tolerated if all repeater sections of cable were equally noisy. Actually in practice a certain proportion of the repeater sections in a long distance international circuit may have no exposures to external induction. In this case the only noise present in the unexposed repeater sections will be that due to internal induction, i.e., about 25 microvolts. The noise in the unexposed sections will thus be less than the permissible limits, so that, if a number of the repeater sections are in this way less than the limit, we can permit the other sections to be correspondingly greater than the limit.

The table below gives values of the total permissible noise per exposed repeater section when only some of the repeater sections are exposed. In calculating this table it has been assumed that there is a total of 80 repeater sections and that the noise for an unexposed section is 25 microvolts.

Number of Exposed Sections	Noise per Exposed Section
1	450
2	315
5	200
10	143
20	100
40	73
80	55

### Discussion

The first fact of importance to be obtained from these tables is the extremely small values to which the line noise per repeater section must be limited if the overall C.C.I. value of 2 millivolts is to be maintained. This fact is important

because it is often considered that, if a telephone receiver is connected to a repeater section of line and no noise is heard in it, then the line can be considered satisfactory from the point of view of noise. Actually, the minimum noise that can be heard under average conditions is about 200 microvolts, so that, as the above tables show, the permissible line noise per repeater section is often considerably less. In making noise measurements on individual sections of line, it is therefore necessary to use an amplifier before it is possible to say whether the line will be satisfactory when incorporated in a long distance international circuit.

The question now arises as to what limit it is desirable to fix for the noise in the individual repeaters and repeater sections of line in a long international circuit. In the case of repeaters the desirable limit was seen to be about 200 microvolts and since this limit can be met without difficulty it seems reasonable to adopt it as the permissible limit. In the case of the line noise, however, a difficulty arises. Owing to the relatively lower speech levels at the end of a repeater section of line, the line noise must be held to very low values, and these values depend essentially on the number of repeater sections comprising the circuit. The difficulty is, therefore, that if we choose a limit of line noise per repeater section which will be satisfactory for even the longest circuits then it will be unnecessarily severe for shorter circuits, and if we choose a limit which is only satisfactory for short circuits the long distance circuits will exceed the overall limit.

It might be thought, since there are many more short telephone circuits than long distance ones, that it would be reasonable to arrange that the overall noise in the short circuits meet the desired limit and to permit the noise in longer circuits to exceed the limit of 2 millivolts. The argument against this, however, is that, although there are relatively fewer long distance circuits, the greater capital investment in these circuits and the higher cost to the subscriber for their use, makes it even more necessary than in the case of short circuits that the noise should not exceed the permissible limit.

It would be possible to overcome this difficulty by taking different limits of noise per repeater section for different lengths of overall circuit. In

setting up a given long distance circuit it would then be necessary to select, in each repeater section, a pair whose noise would meet the appropriate limit. This would clearly be inconvenient in practice especially as in the case of switching schemes, a given pair in a repeater section may sometimes be used to form a part of a short circuit and sometimes a part of a long circuit. It might be possible to divide circuits into two groups, one for merely local short distance work and the other for the longer circuits, the second group being selected in each repeater section from those pairs which had the least noise. Whether this could be done or not would depend, of course, on local conditions. If it could be done then, since we are concerned here with long distance circuits, the limits would apply only to the group containing the longer circuits; if it could not be done then the limits would, of course, apply to all circuits.

Now, as we have seen, the line noise per repeater section is only about 25 if the section is not exposed to external induction and, consequently, the noise that may be permitted in an exposed section will depend on the number of such exposed sections. At the present time in some countries there are few exposed repeater sections, while in others there are many. In all cases, however, the number of exposed sections is increasing, so that, if we are to plan for the future, it is reasonable to assume a greater number of exposed sections than at present occurs. We will, therefore, take as a basis of our calculation a circuit consisting of 100 repeater sections with 30% of them exposed. If then we take the noise per repeater as 200 and the overall noise as 2000, we obtain a limit for the line noise per repeater section of about 80 microvolts.

We therefore have the following limits of noise:

- (1) Noise due to a repeater measured at the output = 200 microvolts.
- (2) Noise due to a repeater section of line measured at end of section, when line is not exposed to external induction. = 25 microvolts.
- (3) Noise due to a repeater section of line measured at end of section, when line is exposed to external induction. = 80 microvolts.

These limits are for 4-wire circuits and assume

the C.C.I. limit of overall noise of 2 millivolts, a length of circuit of 100 repeater sections with 30% exposed sections, a level at the output of the repeater of +4 db., a level at the end of a repeater section of line of -22 db., and a level at the end of the overall circuit at which the 2 millivolt limit applies of -10 db.

If in any given case conditions exist other than those assumed, similar limits can be worked out. It is suggested, however, that the conditions assumed in working out the above limits are sufficiently representative for the limits to apply reasonably well to the general case.

Having obtained these limits for long international circuits, the question now arises as to whether it is desirable to specify these limits for individual repeater sections or whether it would not be better merely to specify a value of overall noise for the parts of the circuit in different countries. If this latter suggestion were adopted, then if  $n$  repeater sections of the long distance circuit occurred in a given country, the total noise due to the sections in that country would be:

- (a) Due to 30% exposed sections  
 $\sqrt{0.3 n \times 4 \times 80}$
- (b) Due to 70% unexposed sections  
 $\sqrt{0.7 n \times 4 \times 25}$
- (c) Due to repeaters  
 $\sqrt{n \times 0.2 \times 200}$

Adding these up as the square root of the sum of the squares, we get a total of approximately  $200\sqrt{n}$  microvolts.

Hence, if  $n$  repeater sections of a long distance international circuit lie within a given country, that country will be allowed to contribute not more than  $200\sqrt{n}$  microvolts measured at the end of its part of the circuit and corrected to the reference level of -10 db. For example, if an international circuit consists of 25 repeater sections in country A, 9 in country B, and 64 in country C, then country A will be allowed to contribute 1000 microvolts, country B 600 microvolts, and country C 1600 microvolts, giving a total of about 2000 microvolts.

The advantage of specifying the total noise for

each country rather than the noise per repeater section is that it leaves each Administration a free hand in arranging the different repeater sections in its territory. For example, if an Administration knows that many of its sections are unexposed and owing to topographical conditions it will be possible to avoid exposures in the future, then there is no reason why the noise in the exposed sections should not be allowed to exceed the average values provided that the total noise due to that country does not exceed the limit of  $200\sqrt{n}$ .

### Conclusions

The first conclusion to be drawn from the results given here is that, in order to meet the C.C.I. overall noise limit of 2 millivolts in the case of a long international circuit, it is necessary to hold the noise in individual repeaters and repeater sections to extremely small values. In fact, in the case of a repeater section of line the permissible noise is, when listened to directly on the line terminals, below the audible limit. This conclusion is important because the need for such small limits on individual repeater sections is not always fully realised.

The following limits have been suggested as representing average conditions:

- (1) Noise per repeater 200 microvolts.
- (2) Noise per unexposed repeater section of line 25 microvolts.
- (3) Noise per exposed repeater section of line 80 microvolts.

In the case of an international circuit passing through several countries, it is suggested that the total noise introduced by each country should be limited rather than setting a limit for individual repeater sections. In this case, it is suggested that the total noise voltage contributed by each country should not exceed a value of  $200\sqrt{n}$  microvolts when converted to a level of -10 db. In this expression  $n$  is the number of repeater sections and the constant 200 has been so chosen that for typical long distance international circuits the total noise will be of the order of 2 millivolts as specified by the C.C.I.

# Multiple Earthing and Its Effect on Induced Noise

By JOHN COLLARD, Ph. D.

Central Laboratories

*SUMMARY: The residual currents of a power line induce noise in any neighbouring telephone cable and the distribution of these currents, and consequently the induced noise, depends on whether or not the neutral of the power line is earthed and in how many places. This paper describes how the effect of multiple earthing on induced noise may be calculated, using the equivalent T-networks for the line and transformers, together with certain attenuation equations. A numerical example is worked out and shows that the effect of multiple earthing varies enormously with changes in such factors as the frequency, the length of the power line, the position of the exposure, and the constants of the transformers. Measurements of induced noise or analyses of residual current, such as are usually made, if carried out for a particular power line or exposure, are consequently of little value in estimating the results of multiple earthing on other power lines or exposures. Certain additional tests that are suggested would very much increase the usefulness of such measurements and would enable the results of a given case to be used for predicting, by means of the methods described in this paper, the effects of multiple earthing on induced noise in other cases.*

## 1. Introduction

A POWER transmission line may cause considerable interference with a neighbouring telephone circuit by induction from the higher harmonics. These harmonics, though small in value compared to the fundamental of the power circuit, have frequencies that come within the range normally employed for the transmission of speech. They, therefore, produce noise in the telephone circuit, and, owing to the very small currents employed in telephony, this noise may cause a material reduction in the quality of speech obtainable over the circuit. Telephone circuits in cable are not affected by electric induction and even in open wire circuits the effect of electric induction may be small compared to that of magnetic induction, except for very close separations. The present paper deals only with the residual currents of the power line although exactly similar methods could, of course, be used for the residual voltages.

The magnitude and distribution of the harmonic currents in the power circuit may vary to a considerable extent according to whether the neutral of the power system is earthed or isolated at different points. The study of multiple earthing and its effect on the higher harmonics of the power circuit is, therefore, of considerable interest from the point of view of induced noise.

The object of this paper is to study the sub-

ject from the theoretical point of view in order to determine on what factors the distribution of harmonic currents in the power circuit depend, and thence to deduce the effect on induced noise of multiple earthing of a power system. Numerical examples showing the application of the theory to representative practical problems are also given.

## 2. General Theory

If a sinusoidal current at a frequency  $f$  is applied to the primary winding of a single phase transformer, the flux produced in the core by this current will contain not only a component at the fundamental frequency  $f$  but also components at frequencies  $3f$ ,  $5f$ ,  $7f$ , etc., which form the odd harmonic series of the fundamental. This is due to the fact that the permeability of the iron varies with the flux density in the core. These harmonic components of the flux induce e.m.f.'s. of corresponding frequency in each of the windings of the transformer and, if the windings are closed through external impedances, currents at these frequencies will flow in the external circuits.

In the case of the three-phase transformer, the e.m.f.'s.  $E_1$ ,  $E_2$ ,  $E_3$  at fundamental frequency induced in the three phases are spaced at  $120^\circ$  so that

$$E_1 = E/\theta$$

$$E_2 = E/\theta + 2\pi/3$$

$$E_3 = E/\theta + 4\pi/3.$$

For the  $n$ th harmonic, the corresponding phase relations will be

$$E'_1 = E'/\theta$$

$$E'_2 = E'/\theta + 2n\pi/3$$

$$E'_3 = E'/\theta + 4n\pi/3.$$

For the triple harmonic series, i.e. 3rd, 9th, 15th, etc., we can put  $n = 3m$ , where  $m$  is any integer. Hence for these harmonics

$$E'_1 = E'/\theta$$

$$E'_2 = E'/\theta + 2m\pi = E'/\theta$$

$$E'_3 = E'/\theta + 4m\pi = E'/\theta.$$

The three e.m.f.'s. are thus all in phase.

For the remaining odd harmonics, we can put  $n = 3m \pm 1$  so that

$$E'_1 = E'/\theta$$

$$E'_2 = E'/\theta + 2m\pi \pm 2\pi/3 = E'/\theta + 2\pi/3$$

$$E'_3 = E'/\theta + 4m\pi \pm 4\pi/3 = E'/\theta \pm 4\pi/3.$$

Hence the e.m.f.'s. of these harmonics are spaced at  $120^\circ$  in the three windings of the transformer in a similar way to the fundamental e.m.f.'s.

In a perfectly symmetrical three-phase system, therefore, if the windings are connected in star with the neutral connected to earth, triple harmonic e.m.f.'s. produce currents which flow out over the three conductors of the power line in parallel, through the admittances of these conductors to earth, back through the earth and thence through the neutral connection to the transformer again. When the neutral is not earthed, these currents cannot flow. If the windings are connected in delta, the triple harmonic e.m.f.'s., being in phase in all three windings, are thus effectively short circuited and cause a circulating current to flow round the closed delta winding.

In the case of the other odd harmonic e.m.f.'s., since these are spaced at  $120^\circ$  as in the case of the fundamental, they produce currents which flow over the power line in the same way as the fundamental currents. In other words the triple harmonic series of e.m.f.'s. produce what are called "residual" currents, while the other har-

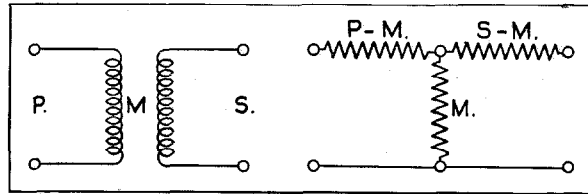

Figure 1

monics produce what are called "balanced" currents.

From the point of view of the noise induced in a neighbouring telephone circuit, the residual currents are much more serious than the balanced currents. This is because, except for very close separations, the distances of the telephone circuit from the three power line conductors are approximately equal, so that the inductive effects of the balanced currents tend to neutralise each other. In the case of the residual currents which return through the earth, the neutralisation is not nearly so complete. From the point of view of induced noise, therefore, we can neglect the effect of the balanced currents and consider only the residual currents.

In a perfectly balanced three-phase system only the triple harmonic series should occur in the residual current. Actually, however, owing to differences in the admittances to ground of the three line conductors, to differences in the three phases of the transformer or to unbalances in the load, it is usual to find harmonics other than the triple series in the residual current.

### 3. Equivalent Networks

In order to study the effect of different transformer connections on the harmonics of a power line, it is convenient to replace the line and its transformers by their equivalent T-networks. If we consider, first of all, one phase of a three-phase transformer, this can be represented by the usual transformer network shown in Fig. 1, where  $P$  is the impedance of the primary when the secondary is open circuited,  $S$  is the impedance of the secondary when the primary is open circuited, and  $M$  is the mutual impedance between the two windings. Values of  $P$ ,  $S$  and  $M$  can be chosen so that the network is equivalent to the line transformer for any given frequency, but this equivalent relation holds good only for that one frequency.



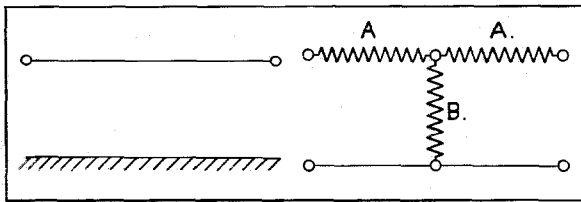

Figure 2

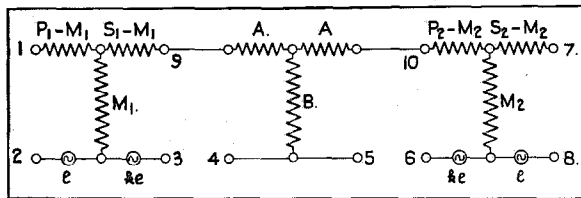

Figure 3

As we have already seen, the harmonic fluxes in the transformer core produce e.m.f.'s. in both the primary and the secondary windings of the transformer so that, to reproduce this effect, we must introduce two alternating e.m.f.'s.,  $e$  and  $ke$ , in the T-network. These e.m.f.'s. are equal to the harmonic e.m.f.'s. induced in the two windings of the transformer at the frequency for which the network has been constructed. The constant  $k$  depends of course on the ratio of the number of turns in the two windings. Since, for the residual currents, the three phases of the transformer and the three line conductors are effectively in parallel, it is convenient to construct the equivalent networks for this case.

The circuit consisting of the three line conductors in parallel with earth return can also be replaced by an equivalent T-network. This is of the form usually employed in telephone problems and is illustrated in Fig. 2 where

$$A = Z_0 \tanh Pl/2$$

$$B = Z_0 / \sinh Pl$$

$$Z_0 = \sqrt{\frac{R + j\omega L}{G + j\omega C}}$$

$$P = \sqrt{(R + j\omega L)(G + j\omega C)}$$

$R$ ,  $L$ ,  $G$  and  $C$  are the primary constants of the circuit per unit length and  $l$  is the length of the circuit.

If, therefore, we consider the system consisting of a line supplied at one end from a trans-

former and supplying a second transformer at the other end, we shall obtain the composite network shown in Fig. 3. Before going on to consider the main problem it will be as well to study some of the properties of this network.

As already pointed out, a delta winding provides a closed circuit round which the residual currents can flow so that, from the point of view of these currents, each of the phases is effectively short circuited. If the station winding of the supply transformer is delta connected, this is then equivalent, in the network, to connecting terminal 1 to 2. If the line winding is delta connected, this is equivalent to connecting terminal 3 to 9. Similarly, if the load transformer has its two windings delta connected, this is equivalent to connecting terminals 6 to 10 and 8 to 7. It will also be remembered that a star connected winding, if the neutral is not earthed, provides no path for the residual currents. This is represented in the equivalent network by leaving the appropriate terminals (1 and 2, 3 and 9, etc.) disconnected. If the line winding of the supply transformer is star connected and the neutral is earthed, a path is provided for the residual currents by way of this connection and the admittance to earth of the line. The earthing of the line winding neutral is thus equivalent to connecting terminal 3 to terminal 4 in the network. In the same way, if the line winding of the load transformer is star connected and the neutral is earthed, we can reproduce this state of affairs in the network by joining terminals 5 and 6.

It is therefore possible by making suitable connections in the equivalent networks to imitate the effect on the residual currents of using star or delta windings on the transformers or of earthing the neutrals. The behaviour of these currents for different frequencies, for different lengths of line and for different types of transformer can, therefore, be easily studied by means of the equivalent networks.

These equivalent networks can be used to study very complicated systems of lines and networks transformers but, for the sake of simplicity, the following work has been confined to the case of a single power line with a supply transformer at one end and a load transformer at the other, as represented in Fig. 3.

#### 4. Transformer Impedance and Regulation

Before being able to calculate the residual currents flowing in the line, we must determine the impedance of the load transformer and the regulation of the supply transformer for the different methods of connection and for different frequencies. It should be remembered that we are here concerned with the circuit consisting of the three phases of the transformer in parallel. Since the ultimate aim of this study is to determine the effect on the residual currents of earthing the neutrals, we need only consider here the case of transformers in which the line windings are star connected.

Take, first of all, the load transformer and refer to Fig. 3. If the station winding of this transformer is star connected, then this is equivalent to leaving terminals 7 and 8 of the network open. The impedance looking into the line windings is, therefore,  $P_2$ . This impedance consists of the inductance of the line windings shunted by the self-capacity of the windings. At low frequencies the effect of the inductance predominates but at the higher speech frequencies the effect of the capacity predominates. In the case of a shell-type three-phase transformer or where three single-phase transformers are used, the inductance is very high. In the case of a core-type, three-phase transformer, the third harmonic fluxes in the three limbs are all in the same direction, e.g., all upwards. Hence the fluxes of the different phases tend to neutralise and the resultant inductance is less than in the other two cases. Even so, however, the inductance for the core-type transformer is quite high. The actual magnitude and angle of  $P_2$  will thus vary according to the frequency, and will also vary according to the type of transformer. In practice, however,  $P_2$  will have a value in the order of  $10^4$  or  $10^5$  ohms for ordinary noise frequencies.

If the station winding of the load transformer is delta connected, this is equivalent to joining terminals 7 and 8 in the network, so that the impedance of the line windings will then be

$$\frac{P_2 S_2 - M_2^2}{S_2}$$

In an ideal transformer with no leakage and no resistance,  $P_2 S_2 = M_2^2$  so that the imped-

ance would be zero. For an actual transformer the resistance is fairly small so that the impedance is largely inductive. A rough idea of the value of this inductance can be obtained from the reactive drop in the transformer at fundamental frequency. If this drop is  $p\%$  of the phase voltage  $V_{ph}$  for the full load phase current  $I_{ph}$  then we have

$$L_{ph} = \frac{pV_{ph}}{100\omega I_{ph}}$$

The inductance  $L$  we require is approximately one-third the phase inductance, so that we may write

$$L = \frac{pV^2}{300 \omega K}$$

where  $V$  is the line voltage and  $K$  the KVA capacity of the transformer.

If  $p = 10\%$ ,  $K = 20,000$  KVA, and  $V = 132,000$  volts, we have

$$L = .09 \text{ henry.}$$

From the expression for  $L$ , it will be seen that its magnitude is directly proportional to the voltage and inversely proportional to the current.

Now let us consider the supply transformer. If the station winding is star connected, we leave terminals 1 and 2 in the network disconnected, so that on earthing the neutral, i.e., joining terminals 3 and 4, the only e.m.f. that can drive current into the line is  $k_e$ . This e.m.f. acts through the internal impedance,  $M_1 + S_1 - M_1 = S_1$ , of the transformer so that the current entering the line is

$$i_o = \frac{k_e}{S_1 + Z_L} \dots \dots \dots (1)$$

If the station winding of the supply transformer is delta connected, we join terminals 1 and 2 of the network. The e.m.f.  $e$  then has a closed circuit of impedance  $P_1 - M_1 + M_1 = P_1$  through which to act and thus produces a current in this circuit of  $\frac{e}{P_1}$ . This current flows through the mutual impedance  $M_1$  and thus applies a voltage  $\frac{eM_1}{P_1}$  to the line side. The total

open circuit e.m.f. on the line side is thus

$$e \left( k - \frac{M_1}{P_1} \right)$$

The internal impedance of the transformer looked at from the line is

$$S_1 - M_1 + \frac{M_1(P_1 - M_1)}{P_1} = \frac{P_1 S_1 - M_1^2}{P_1}$$

Hence the current entering the line is

$$i_o = \frac{e(kP_1 - M_1)}{P_1(S_1 + Z_L) - M_1^2} \dots \dots \dots (2)$$

In these expressions,  $Z_L$  is the impedance of the three line conductors in parallel with earth return and is given by the formula

$$Z_L = A + \frac{B(A + Z')}{A + B + Z'} \dots \dots \dots (3)$$

when the far end is closed through an impedance  $Z'$ .

It will be obvious that if we consider the load transformer as the source of harmonics e.m.f., exactly similar equations will be obtained for the residual currents due to this source.

It is of interest to work out the ratio of the current  $i_D$  entering the line when the supply transformer has the station winding delta connected, and the current  $i_s$  when this winding is star connected.

$$i_s = \frac{ke}{Z_s + Z_L} = \frac{ke}{Z_s} \text{ approximately,}$$

since  $Z_s > Z_L'$ .

where  $Z_s$  is the impedance of the three line windings in parallel when the station windings are star connected ( $Z_s = S_1$ ).

$$i_D = \frac{ke - \frac{M_1 e}{P_1}}{Z_D + Z_L}$$

where  $Z_D$  is the impedance of the three line windings when the station windings are delta connected

$$\left( Z_D = \frac{P_1 S_1 - M_1^2}{P_1} \right)$$

Hence,

$$\frac{i_s}{i_D} = \frac{k(Z_D + Z_L)}{Z_s \left( k - \frac{M_1}{P_1} \right)}$$

Putting  $k = \sqrt{\frac{S_1}{P_1}}$ , we get

$$\frac{i_s}{i_D} = \frac{\sqrt{P_1 S_1} (Z_D + Z_L)}{Z_s (\sqrt{P_1 S_1} - M_1)}$$

But

$$Z_D = \frac{(\sqrt{P_1 S_1} - M_1)(\sqrt{P_1 S_1} + M_1)}{P_1}$$

$$= \frac{(\sqrt{P_1 S_1} - M_1) 2\sqrt{P_1 S_1}}{P_1} \text{ (approx.)}$$

$$\therefore \sqrt{P_1 S_1} - M_1 = \frac{Z_D P_1}{2\sqrt{P_1 S_1}};$$

$$\therefore \frac{i_s}{i_D} = \frac{2(Z_D + Z_L)}{Z_D}$$

$$= 2 \left( 1 + \frac{Z_L}{Z_D} \right) \dots \dots \dots (4)$$

### 5. Line Current Distribution

The expressions given in the last section enable us to determine the current entering the line but do not tell us how the distribution varies along the line. Since this distribution is materially affected by the impedance connected to the end of the line and therefore by the earthing or isolating of the load transformer neutral, it is necessary to determine the distribution for different cases. This can be done by means of the usual propagation equations of a telephone line. The current  $i_x$  at a point distance  $x$  from the sending end of a line of length  $l$  closed at its receiving end by an impedance  $Z'$  is given by the expression

$$i_x = i_o \left[ \cosh Px - \sinh Px \frac{Z' \cosh Pl + Z_o \sinh Pl}{Z \cosh Pl + Z' \sinh Pl} \right] \dots \dots \dots (5)$$

If  $Z'$  is large compared to  $Z_o$  this expression reduces to the form

$$i_x = i_o \frac{\sinh P(l-x)}{\sinh Pl} \dots \dots \dots (6)$$

Equation (5) can, therefore, be used to calculate the current distribution when the line is closed through a small impedance, such as occurs when the load transformer has its windings connected star-delta and its neutral earthed. Equation (6) can be used when the line is effectively open at the far end, as it is when the neutral is not earthed.

In an actual power transmission line, the resistance R and the leakance G are small, so that we can with little error neglect them altogether. This very much simplifies the evaluation of these formulae since  $Z_0$ , the characteristic impedance, and P, the propagation constant, then become

$$Z_0 = \sqrt{\frac{L}{C}}$$

$$P = j\omega\sqrt{LC}$$

Equations (5) and (6) then reduce to the following:

$$i_x = i_0 \left[ \cos \beta x - j \sin \beta x \frac{Z' \cos \beta l + j Z_0 \sin \beta l}{Z_0 \cos \beta l + j Z' \sin \beta l} \right] \dots (7)$$

$$i_x = i_0 \frac{\sin \beta(l-x)}{\sin \beta l} \dots \dots \dots (8)$$

The current distribution given by these two equations is not the same and, consequently, a given change in transformer connections which produces a certain relative change of current at one point in the line will not necessarily produce the same relative change of current at some other point in the line. The effect, on the noise induced in a neighbouring telephone circuit, of making some change in the transformer connections will therefore depend to a large extent on where the parallel occurs along the power line and how far it extends. For the sake of simplicity, it has been assumed here that the separation between the power line and the telephone circuit is uniform throughout the exposure. In this case we may take as a measure of the total e.m.f. induced to earth by the residual current, the quantity  $\int i_x dx$ , where  $i_x$  is the residual current in the power line at a

distance  $x$  from the supply end,  $i_x$  being assumed constant over the small length  $dx$ . The actual noise in the metallic circuit will, of course, depend on the unbalance and constants of the telephone circuit but, for our purpose, we can take the quantity  $\int i_x dx$  as a criterion of the interfering effect of the residual current of the power line.

### 6. Numerical Example No. 1

With the aid of the formulae given in the previous sections, it is possible to determine the effect on the residual current of earthing the neutral with different transformer connections. From the mathematical expressions alone, however, it is difficult to determine the magnitude of the effects produced, and the expressions have, therefore, been evaluated for a representative case. The calculations for this case are given in Sections 6 and 7, while the discussion of the results is given in Section 8.

The case considered is that of a three-phase power line having a length of 50 miles with the following constants for the circuit consisting of the three wires in parallel with earth return.

- L = .002 hy. per mile.
- C = .02 mfd. per mile.
- R = G = 0.

The values of these constants will depend, of course, on the particular type of line considered and on the voltage and current for which it is designed, but will not vary very widely from the above values. The results obtained from this calculation can, therefore, be considered quite representative.

It is also assumed that the inductance of the three line windings in parallel is 0.1 henry and the resistance is negligible, both for the supply and the load transformers, when the station winding is connected in delta. The exact value of the impedance when the station winding is star connected is immaterial from the point of view of our problem, since all we need to know is that the impedance of the line windings of the transformer is large compared to the line impedance. This condition is fulfilled since the transformer impedance is in the order of  $10^4$  ohms and the line impedance is only 316 ohms.

These constants give the following values for the line:

$$Z_o = 316/O^\circ$$

$$P = O + j 6.23\omega 10^{-6}.$$

For 800 cycles per second the following values are obtained for the line:

$$A = O + j323$$

$$B = O - j316.$$

At 800 cycles per second the value for the transformer is:

$$P_2 - \frac{M_2^2}{S_2} = S_1 - \frac{M_1^2}{P_1} = O + j502.$$

The quantity  $\int i_x dx$  has been taken as the criterion of the interfering effect of the residual current and, since this effect will depend on where the exposure occurs along the power line, this integral has been evaluated for the three cases,

- (a) an exposure occurring over the first 10 miles of the power line,
- (b) an exposure occurring over the last 10 miles, and
- (c) an exposure occurring over the whole 50 miles

This integral has been denoted by  $T_e$  for the condition of the load transformer neutral earthed and  $T_i$  for the condition of this neutral isolated.

In this example, it is assumed that the supply transformer is the only source of harmonics. In the second numerical example, some consideration is given to the case in which the load transformer is also a source of harmonics.

In accordance with the terms of the problem, the line windings of both transformers are assumed to be star connected, so that a neutral point is available for earthing. The station windings, however, may be either star or delta connected. We thus have the following cases to consider:

Case	Supply Transformer	Load Transformer
I	star-star	star-star
II	delta-star	star-delta
III	star-star	star-delta
IV	delta-star	star-star

CASE I

Supply Transformer—Star-star  
Load Transformer—Star-star.

In this case the impedance of the load transformer, which is put across the end of the line when the neutral is earthed, is at least 10,000 ohms. Consequently the line, from the point of view of residual currents, is effectively open-circuited at the far end, even when the neutral of the load transformer is earthed. Thus formula (8) can be used for the current distribution for both conditions of the neutral. Since the internal impedance of the supply transformer is also about 10,000 ohms, it is large compared to A and B and hence the current entering the line is constant. We can conclude, therefore, that for this case neither the current entering the line nor the relative distribution of current along the line are changed by earthing or isolating the neutral of the load transformer.

CASE II

Supply Transformer—Delta-star  
Load Transformer—Star-delta.

This is a most interesting case, partly because it is the case for which the most variation occurs for different conditions of the neutral and partly because it is the case occurring in the British grid system.

For this case we use formula (2) for the currents entering the line and, since we are concerned only with relative effects, we can put the effective e.m.f.,  $e\left(k - \frac{M_1}{P_1}\right)$ , equal to unity.

For the condition of the load transformer earthed, we use formula (3) for the line impedance and formula (7) for the current distribution. We thus have

$$T_e = \int \frac{A+B+Z'}{(A+2B+Z')(A+Z')} \left[ \cos \beta x - j \sin \beta x \frac{Z' \cos \beta l + j Z_o \sin \beta l}{Z_o \cos \beta l + j Z' \sin \beta l} \right] dx \dots (9)$$

$$\text{where } Z' = S_1 - \frac{M_1^2}{P_1} = P_2 - \frac{M_2^2}{S_2}.$$

For the condition of the load transformer neutral isolated, we take A+B for the line impedance and formula (8) for the current distribution, hence

$$T_i \int \frac{1}{A+B+Z'} \left[ \frac{\sin \beta(l-x)}{\sin \beta l} \right] dx \dots (10)$$

From these two expressions, (9) and (10), values of  $T_e$  and  $T_i$  have been worked out for the first 10 miles of the line, for the last 10 miles of the line and the whole 50 miles of the line. The results are given in Table No. I.

In order to determine how the length of the power line affects the results, the 800 cycle case has been worked out for lines of 10, 25, 50 and 100 miles. The results are given in Table No. II.

This is a combination of Case I and Case II. Since the supply transformer has its station winding star connected, the current entering the line will be constant whether the load transformer neutral is earthed or not. The distribution, however, will be given by formula (7) when the load transformer neutral is earthed and by formula (8) when this neutral is isolated. Since  $i_o$  is constant for the two conditions, we can simplify the expression by making it unity. Then we have

$$T_e = \left( \cos \beta x - j \sin \beta x \frac{Z' \cos \beta l + j Z_o \sin \beta l}{Z_o \cos \beta l + j Z' \sin \beta l} \right) dx \dots (11)$$

$$T_i = \frac{\sin \beta(l-x)}{\sin \beta l} dx \dots (12)$$

CASE III

Supply Transformer—Star-star  
Load Transformer—Star-delta

TABLE NO. I

Frequency	First 10 miles			Last 10 miles			Total 50 miles		
	$T_e$	$T_i$	$T_e/T_i$	$T_e$	$T_i$	$T_e/T_i$	$T_e$	$T_i$	$T_e/T_i$
200	24	14	1.7	30	2	15.0	134	56	2.4
400	1	153	.006	15	17	0.9	33	438	.07
600	261	38	6.9	382	5	76.4	328	114	2.9
800	29	19	1.5	14	3	4.7	45	63	0.7
1000	16	14	1.1	4	3	1.3	35	49	0.7
1200	13	11	1.2	2	3	0.7	46	48	0.96
1400	10	10	1.0	1	4	0.2	37	57	0.65

TABLE NO. II

Length Miles	First 10 miles			Last 10 miles			Total Length		
	$T_e$	$T_i$	$T_e/T_i$	$T_e$	$T_i$	$T_e/T_i$	$T_e$	$T_i$	$T_e/T_i$
10	27.	12	2.2	27	12	2.2	27	12	2.2
25	0.7	39	0.02	37	10	3.7	47	62	0.8
50	29	19	1.5	14	3	4.7	45	63	0.7
100	0.5	1.4	0.4	0.3	2	0.1	4	72	0.05

TABLE NO. III

Frequency	First 10 miles			Last 10 miles			Total 50 miles		
	$T_e$	$T_i$	$T_e/T_i$	$T_e$	$T_i$	$T_e/T_i$	$T_e$	$T_i$	$T_e/T_i$
200	1.04	0.89	1.2	1.28	0.10	12.8	5.82	2.52	2.3
400	0.38	0.72	0.5	5.00	0.10	50.0	10.60	2.63	4.0
600	0.79	0.95	0.8	1.16	0.12	9.7	1.00	2.85	0.4
800	0.91	0.99	0.9	0.43	0.14	3.1	1.39	3.18	0.4
1000	0.97	1.07	0.9	0.26	0.20	1.3	2.14	3.85	0.6
1200	1.07	1.22	0.9	0.17	0.30	0.6	3.04	5.35	0.6
1400	1.26	1.69	0.8	0.10	0.70	0.1	4.73	9.85	0.5

TABLE NO. IV

Frequency	First 10 miles			Last 10 miles			Total 50 miles		
	$T_e$	$T_i$	$T_e/T_i$	$T_e$	$T_i$	$T_e/T_i$	$T_e$	$T_i$	$T_e/T_i$
200	0.79	0.89	0.9	0.79	0.10	7.9	0	2.52	0
400	0.62	0.72	0.9	0.62	0.10	6.2	0	2.63	0
600	0.83	0.95	0.9	0.83	0.12	7.0	0	2.85	0
800	0.85	0.99	0.9	0.85	0.14	6.0	0	3.18	0
1000	0.87	1.07	0.8	0.87	0.20	4.3	0	3.85	0
1200	0.92	1.22	0.7	0.92	0.30	3.1	0	5.35	0
1400	0.99	1.69	0.6	0.99	0.70	1.4	0	9.85	0

TABLE NO. V

Frequency	First 10 miles			Last 10 miles			Total 50 miles		
	$T_e$	$T_i$	$T_e/T_i$	$T_e$	$T_i$	$T_e/T_i$	$T_e$	$T_i$	$T_e/T_i$
200	6	14	0.4	6	2	3.0	0	56	0
400	14	153	0.09	14	17	0.8	0	438	0
600	121	38	3.2	121	5	24.2	0	114	0
800	15	19	0.8	15	3	5.0	0	63	0
1000	12	14	0.8	12	3	4.0	0	49	0
1200	11	11	1.0	11	3	3.7	0	48	0
1400	9	10	0.9	9	4	2.5	0	57	0

TABLE NO. VI

Frequency	First 10 miles			Last 10 miles			Total 50 miles		
	$T_e$	$T_i$	$T_e/T_i$	$T_e$	$T_i$	$T_e/T_i$	$T_e$	$T_i$	$T_e/T_i$
200	0.76	0.89	0.8	0.10	0.10	1.0	1.94	2.52	0.8
400	13.40	0.72	18.6	1.45	0.10	14.5	23.90	2.63	9.1
600	1.75	0.95	1.8	0.43	0.12	3.6	2.15	2.85	0.8
800	1.20	0.99	1.2	0.29	0.14	2.0	2.49	3.18	0.8
1000	1.17	1.07	1.1	0.21	0.20	1.0	2.99	3.85	0.8
1200	1.29	1.22	1.0	0.22	0.30	0.7	4.59	5.35	0.9
1400	1.72	1.26	1.4	0.70	0.70	1.0	8.43	9.85	0.9

TABLE NO. VII

Frequency	First 10 miles			Last 10 miles			Total 50 miles		
	$T_e$	$T_i$	$T_e/T_i$	$T_e$	$T_i$	$T_e/T_i$	$T_e$	$T_i$	$T_e/T_i$
200	0.10	0.63	0.2	0.76	0.72	1.0	1.94	1.76	1.1
400	1.45	49.6	0.03	13.40	5.40	2.5	23.90	315.0	0.8
600	0.43	0.85	0.5	1.75	0.12	14.5	2.15	2.56	0.8
800	0.29	0.59	0.5	1.20	0.10	12.0	2.49	1.91	1.3
1000	0.21	0.85	0.2	1.17	0.16	7.3	2.99	3.08	1.0
1200	0.30	0.97	0.3	1.29	0.24	5.4	4.59	4.28	1.1
1400	0.70	1.01	0.7	1.72	0.42	4.1	8.43	5.90	1.4

These two expressions have been evaluated for the three cases considered before and the results are given in Table No. III.

#### CASE IV

Supply Transformer—Delta-star  
Load Transformer—Star-star

This case gives results which are similar to Case I. Since the load transformer impedance is high even when the neutral is earthed, the current distribution is unaltered. The impedance looking into the line is also unaltered by the earthing of the load transformer neutral, so that the current entering the line is unchanged.

### 7. Numerical Example No. 2

In the previous example it was assumed that the supply transformer was the only source of harmonics. If, on the contrary, the load transformer is also a source of harmonics, then the results of earthing or isolating the neutral under the different conditions of transformer connections are no longer the same as in the previous example.

Let us assume that the two transformers are identical as regards the production of the harmonic residual e.m.f.'s. This condition has been worked out for the four cases considered in the last section and for the same line and transformer constants as before.

#### CASE I

Supply Transformer—Star-star  
Load Transformer—Star-star

When the load transformer neutral is isolated, the current in the line is exactly the same as in the previous example. When this neutral is earthed, however, the currents due to the supply transformer are unchanged but, in addition, an exactly similar set of currents is superimposed on the line from the load transformer. The resultant current at the middle of the line is thus zero, while at any other point distance  $x$  from the supply transformer, the current has a value which is the difference between  $i_x$  and  $i_{l-x}$ . The relative inductive effect of the residual current on the telephone line is no longer the same as in Example No. 1, but the value of  $T_e$  for the last 10 miles is the same as for the first 10 miles and

the value for the whole 50 miles is obviously zero.

The values of  $T_e$  and  $T_i$  for the three cases are given in Table No. IV.

#### CASE II

Supply Transformer—Delta-star  
Load Transformer—Star-delta

In this case the value of  $T_i$  is the same as for the first example. With the load transformer neutral earthed, two equal current distributions starting from opposite ends of the line are superimposed, so that the resultant distribution is the difference between the two. Values for  $T_e$  and  $T_i$  are given in Table No. V.

#### CASE III

Supply Transformer—Star-star  
Load Transformer—Star-delta

With the load transformer neutral isolated the current distribution is the same as it was for the first example. With the neutral earthed, two unequal distributions are superimposed. One of these is caused by the e.m.f. of the supply transformer  $k_e$  and the other by the e.m.f. of the load transformer,  $e \left( k - \frac{M_2}{S_2} \right)$ . Values of  $T_e$  and  $T_i$  are given in Table No. VI.

#### CASE IV

Supply Transformer—Delta-star  
Load Transformer—Star-star

Values of  $T_e$  and  $T_i$  for this case are given in Table No. VII.

### 8. Discussion of Results

In considering the results given in Tables I to VII, it should be remembered that a value of  $T_e/T_i$  less than unity indicates that earthing the neutral of the line side of the load transformer reduces the induced noise. The results obtained vary widely for different cases and values of  $T_e/T_i$  covering a range of as much as a hundred to one occur. In some cases, earthing the load transformer neutral decreases the noise, although one might have assumed that, as this provides a path to earth for the residual currents, the noise would be increased. The reason for these very large variations is, of course, that the circuit consisting of the three power conductors in



parallel with earth return is electrically short so that reflection from the end of the line has a considerable effect on the current distribution.

The effect of earthing on the induced noise will be seen to vary considerably with a change in the frequency or in the length of the line; this is to be expected, of course, since the reflection effect depends essentially on these two factors. The effect of earthing also depends to a large extent on where the exposure occurs along the power line. If two telephone circuits were exposed to a power line and the two exposures occurred at different places along the line, then it would be quite possible for some change in the earthing conditions to increase the noise in one telephone circuit and decrease it in the other.

The results show that earthing the neutral of the load transformer is, from the point of view of the residual currents, by no means equivalent to short circuiting the three power conductors to earth, since the impedance of the three line windings in parallel is quite high. If the station winding is star connected, this impedance may be of the order of 10,000 or 100,000 ohms while, even if the station winding is delta connected, the impedance at voice frequencies will be several hundreds of ohms. The effects of multiple earthing on induced noise will, therefore, depend on these transformer impedances and, since these in turn depend on the kva. capacity of the transformer, it is quite possible that some particular condition of neutral earthing which gave, say, a minimum induced noise when the station had a certain kva. capacity might produce quite a loud noise if the capacity were increased. On the other hand, an increase in the capacity of the station might reduce the noise, the result depending on just how the vector sum of the transformer and line impedances was altered by the change in capacity.

In spite of these very large variations, however, it is possible to make a few general statements about the effect of multiple earthing when the supply transformer is the only source of residual harmonics.

- (a) When the load transformer has its station winding star-connected, then earthing the line winding neutral has no effect on the induced noise, whether the supply transformer has its station winding star or delta connected.

- (b) When the supply transformer has its station winding star-connected the residual current is the same whether the load transformer neutral is earthed or isolated. Hence the noise due to exposures at the supply end of the power line will be very little affected by the condition of the load transformer neutral.
- (c) Noise due to exposures near the load end of the line will, as a general rule, be considerably more affected by earthing the load transformer neutral than noise due to exposures at the other end.

It is well known that a delta winding on a transformer tends to reduce the effect of residual harmonics produced by the transformer, due to the fact that the residual e.m.f.'s are effectively short circuited through the delta winding. It is, therefore, of interest to consider the magnitude of this reduction. Equation (4) gives for the ratio of  $i_s$ , the residual current entering the line when the supply transformer has its station winding star-connected, to  $i_D$ , the corresponding value when the winding is delta-connected. This ratio is

$$\frac{i_s}{i_D} = 2 \left( 1 + \frac{Z_L}{Z_D} \right)$$

where  $Z_L$  is the residual current line impedance and  $Z_D$  is the impedance, to residual currents, of the transformer when looked at from the line and with its station winding delta connected.

The ratio  $i_s$  to  $i_D$  is a measure of the reduction in residual harmonics produced by connecting the station winding in delta instead of star. It will be seen that when  $Z_D$  is zero, as it would be for an ideal transformer with no resistance and

no leakage flux, the ratio  $\frac{i_s}{i_D}$  is infinite, showing

that the residual currents would be completely eliminated from the line. In an actual case, however,  $Z_D$  is by no means zero and the reduction due to the use of a delta winding may be quite small. In cases where the line impedance has a negative reactance for some particular frequency, the delta winding may even increase the residual current at that frequency.

The value of  $\frac{i_s}{i_D}$  has been worked out for the

case assumed in the numerical example and the results are given below:

Frequency	$\frac{i_s}{i_D}$
200	10.0
400	0.4
600	1.4
800	2.0
1000	2.4
1200	2.8
1400	3.9

These results show a ratio less than unity for 400 cycles and indicate that the reduction in residual current, except at 200 cycles, is not very large. For a transformer with a smaller kva. capacity than that assumed here, the inductance to residual currents would be less than 0.1 henry. Hence  $Z_D$  would be larger and the reduction in residual current due to the delta winding would be even less than the values given above.

### 9. Conclusions

The results of this work show that the effect of multiple earthing on noise, even for the simple case of a single section of power line with a transformer at each end, varies so enormously according to the particular conditions that, except in one or two cases, no general statements can be made. For a given residual e.m.f., however, the effect of multiple earthing will depend principally on the following factors:

- (1) The frequency of the residual e.m.f.
- (2) The length of the power line.
- (3) The point along the power line at which the exposure occurs.
- (4) Whether the transformer windings are connected in star or delta.
- (5) Whether residual harmonics are produced by only one or more than one of the transformers.
- (6) The kva. and voltage of the transformers.

This investigation also shows that rather unexpected results may occur, since earthing the neutral may actually reduce the residual current, while using a delta instead of a star winding may increase the residual line current.

All this goes to show that tests on multiple earthing, such as the measurement of induced noise and the analysis of neutral currents, carried out on some particular line, while interesting for that particular case, are of very little use for predicting what will occur on other types of lines or even on the same type of line at some other location. It is suggested, therefore, that when such tests are made, they should be combined whenever possible with measurements at voice frequencies of the impedance to residual currents of the line and transformers. The measurements that would be required are:

- (1) The impedance of the circuit consisting of the three power conductors with earth return with the conductors insulated at the far end.
- (2) The impedance for the same circuit with the conductors at the far end connected to earth.
- (3) The impedance of the different transformers measured with the three line phases in parallel, the station winding being either star or delta according to the connection used in practice.

These measurements at a number of voice frequencies, together with an analysis of the residual current for some known condition of the neutrals, would, by the aid of the equivalent networks and formulae described in this paper, enable the effect of multiple earthing to be pre-determined, either for some changed condition of the neutrals or for some other section of the line.

# Trunking Plans of the Paris Network

By S. V. C. SCRUBY

*Technical Director, Le Matériel Téléphonique, Paris*

## I. Introduction

THE switching problem in any large telephone network is largely a matter of trunking. In a network of uniform manual, or uniform automatic equipment, the problem is relatively simple, but during the transition stage from manual to automatic, the trunking problem becomes intricate. It is the purpose of this article to present this problem and the solutions adopted for the Paris network, as well as to indicate the old manual trunking plan, and the future automatic trunking plan, as far as it can be foreseen at this time.

The introduction of the Rotary Automatic System into the Paris area has already been fully treated in previous issues of *Electrical Communication*.<sup>1,2</sup>

The French Post and Telegraph Department, after careful study and consideration of the various trunking plans adopted in other countries under similar circumstances, decided upon a plan for Paris presenting the maximum facility for the subscriber, and a minimum of complication in operating methods for the operators. This solution also met the fundamental requirement of low annual cost.

The plan chosen involved call-indicator trunking from automatic to manual, and direct trunking from manual to automatic.

In each instance, the manual or the automatic subscriber makes no distinction between calls to manual or automatic subscribers; all are treated alike. An automatic subscriber dials the full number regardless of whether the call is to another automatic subscriber or to a subscriber still served by a manual switchboard. A manual subscriber gives the required number to the answering operator, who completes the connection in the established way if it is to another manual subscriber or, if it happens to be for a

subscriber to an automatic office, by selecting an individual trunk jack to that office and depressing the called number upon a high-speed keyset: the total effort is no more or less than that of completing the call locally in a subscriber's multiple. Subscribers are not disturbed as conversion from manual to automatic proceeds office by office, there being only one change, from the subscriber's point of view—that of replacing the manual telephone by one with a dial.

From an operating point of view, the load of the "A" operator is not increased so that the number of "A" positions on the remaining manual boards is also not increased. The total "B" positions, moreover, are not increased in any remaining manual office, but are converted from manual working to call indicator working in proportion to the conversion to automatic.

In order that the temporary call indicator and direct trunking equipment may be moved from office to office, as conversion takes place or as traffic shifts, it is built in units which are easily installed or removed.

The application of this plan from the beginning of the conversion period is largely responsible for the good order and ease with which the successive cutovers in Paris have been carried out; the thirty-second automatic office recently opened to the public has brought the automatic equipment installed up to 276,000 lines.

In order to enable the references to Paris or City, Suburban, and Regional Areas to be properly understood, three plans of the Paris Area are given in Figs. 1, 2 and 3.

### *Numbering and Directory Listing*

All telephone numbers used throughout the Paris Area have seven digits. Each office has 10,000 lines numbered 0000-9999 with three digits added to represent the office prefix or code. The office prefix is taken from the first three letters of the office name, such as CAR for CARNot, and GOB for GOBelins.

The numbering within any office is exactly the same for both manual and automatic offices, i.e., 0000-9999, and consequently no subscriber's

<sup>1</sup>"La Transformation du Réseau Téléphonique de Paris en Automatique," *Electrical Communication*, Vol. 6, No. 3, January, 1928, by G. Pocholle.

<sup>2</sup>"The Rotary Automatic Telephone Introduced into Paris," *Electrical Communication*, Vol. 7, No. 2, October, 1928, by G. Deakin.

numbers had to be changed due to the introduction of the automatic.

The only difference in the directory listing is that formerly the office names were printed in one type such as: *Auteuil-9000*, and now are printed with the office code in heavy type, as *AUTEUIL-9000*.

A list of Paris City and Suburban office names and prefixes is shown in Fig. 4 which also gives an illustration of the dial, together with the letters and numerals used. Sixty-nine of the seventy-six office prefixes so far selected have been assigned. Fig. 4, in addition, illustrates a representative portion of the directory showing the office names with the office prefix in heavy type.

The translator-register provides at present for 100 office codes and ultimately for 150.

## II. Definition of the Paris Network

The Paris telephone network covers the departments of the Seine, Seine-et-Oise, and Seine-et-Marne. It is divided, from the telephonic point of view, into four zones formed by con-

centric circles having their centre at Notre Dame Cathedral.

(1) *City Area*, up to a radius of 6 km., contains 180,000 working lines, served by 47 telephone offices, all interconnected by direct trunks and located in 30 buildings.

(2) *Suburban Area*, between the circles of 6 and 12 km. radius, containing 36,000 working lines, handled up to 1929 by 57 distinct communal offices, but now grouped in 22 suburban offices. These offices are each connected by a single group of trunks to the City network.

(3) *Regional Area*, between the circles of 12 and 25 km. radius, containing 24,000 working lines, now handled by 200 small networks but at present being regrouped into 34 centers, each of which will be connected by a single group of trunks to the City network.

(4) *Short Distance Interurban Area*, between the circles of 25 and 60 km. radius, containing 15,000 working lines, handled by a large number of small networks of which a certain number constitute semiautomatic rural groups, connected by a single group of trunks to the City network.

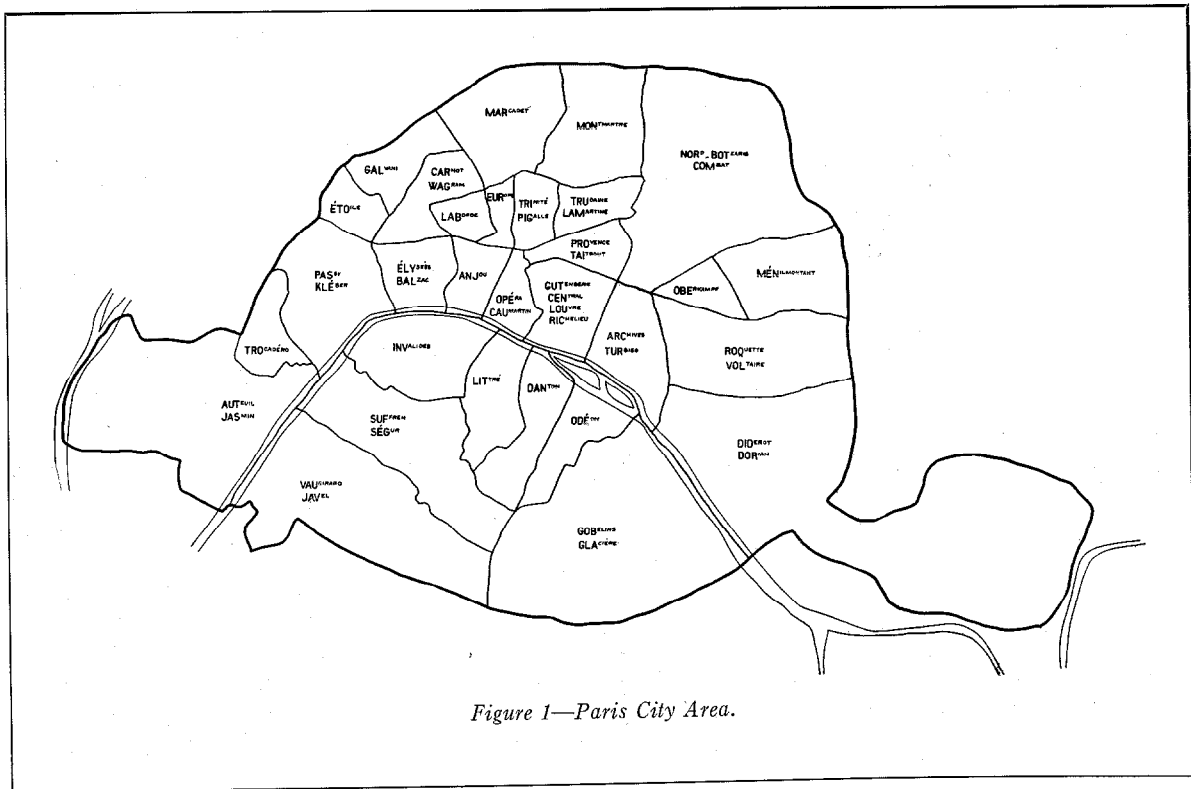
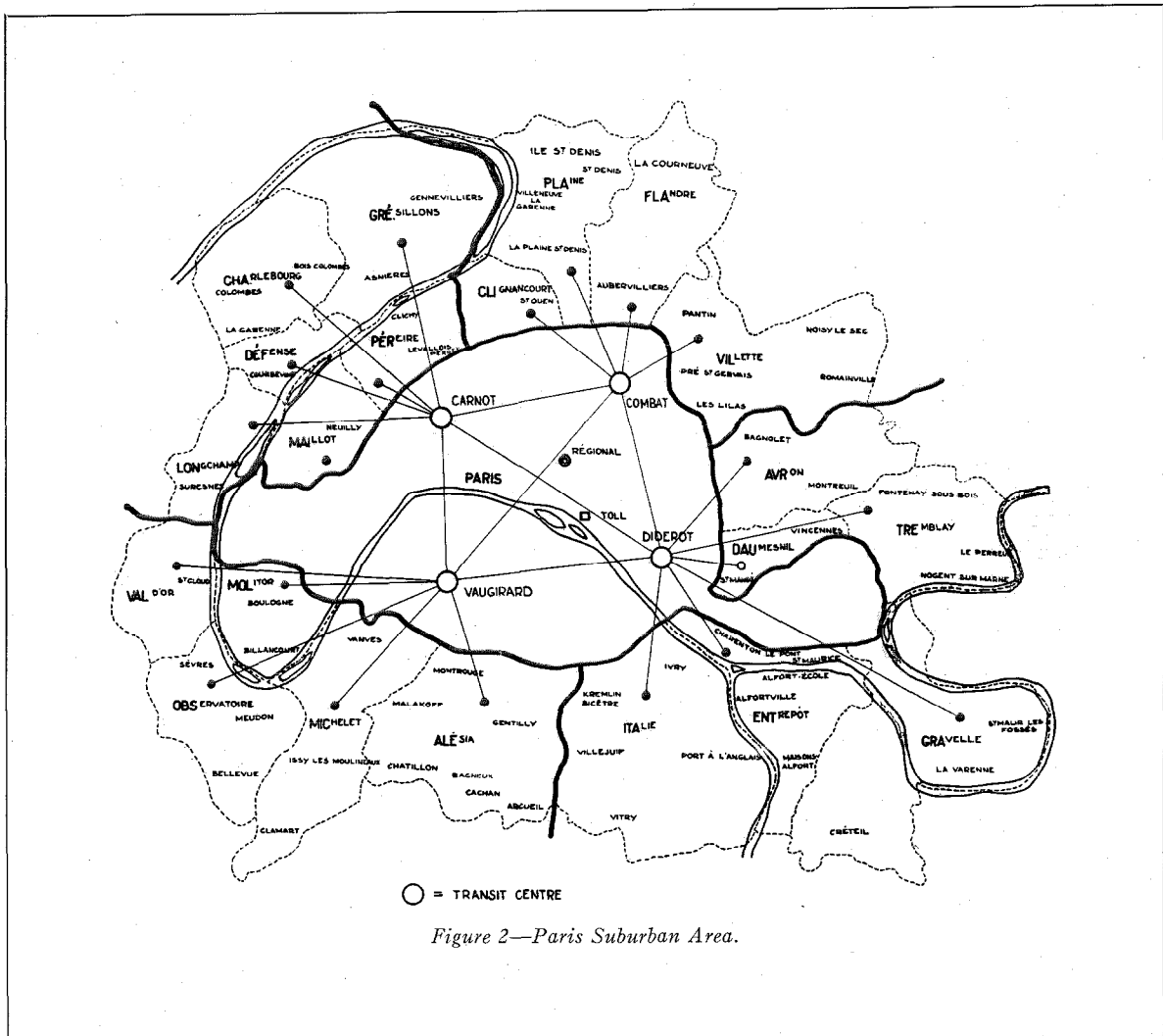

Figure 1—Paris City Area.



### III. Short Description of the Manual Network Before Its Conversion

(1) *In the City Area*, the 30 offices were directly interconnected by trunks, and served by "A" and "B" operators using order wires with automatic distribution to the "B" operators (Fig. 5).

(2) *In the Suburban Area*, 57 localities forming, before 1929, as many distinct networks, directed their traffic towards Paris via tandem offices placed in the nearest periphery city office. The calls from Paris to the suburbs passed through four tandems (Desrenaudes, Danton, Ménilmontant, and Nord), each being responsible for a quarter of the connections to the suburban offices (Fig. 6).

(3) *In the Regional Area*, the numerous offices

obtained Paris, as in the preceding case, through periphery city offices. The calls from Paris to regional were obtained through the central regional office in the Rue du Faubourg-Poissonnière.

### IV. Future Condition of the Network After the Completion of the Conversion to Full Automatic Working

(1) *In the City Area*, all offices will remain directly interconnected and the calls will be handled according to Figs. 7 and 8.

(2) *In the Suburban Area*, the 57 networks will be grouped in 22 offices divided into 4 sections: Northwest, Northeast, Southeast, and Southwest.

In each of these sections, each suburban office will be connected by a single group of trunks to the periphery city office, chosen as the transit center and used for directing automatically the traffic coming from this section to Paris, or vice versa.

(a) Trunking diagrams for these automatic connections are shown in Fig. 9 for Suburban to Paris traffic and in Fig. 10 for Paris to Suburban traffic.

This service requires:

(i) Complete registration and storage of the dialed number in the translator-register at the originating automatic office.

(ii) Repetition of impulses after the transit center tandem selection.

(iii) The setting of third, fourth, and final selectors at the called automatic office.

(b) The traffic between suburban offices connected via two different transit centers, having, for example, to cross the whole of the city area, is routed through the two transit centers in question.

This class of connection is illustrated by Fig. 11, and includes the following operations:

(i) Complete registration and storage of the dialed number in the translator-register at the originating automatic office.

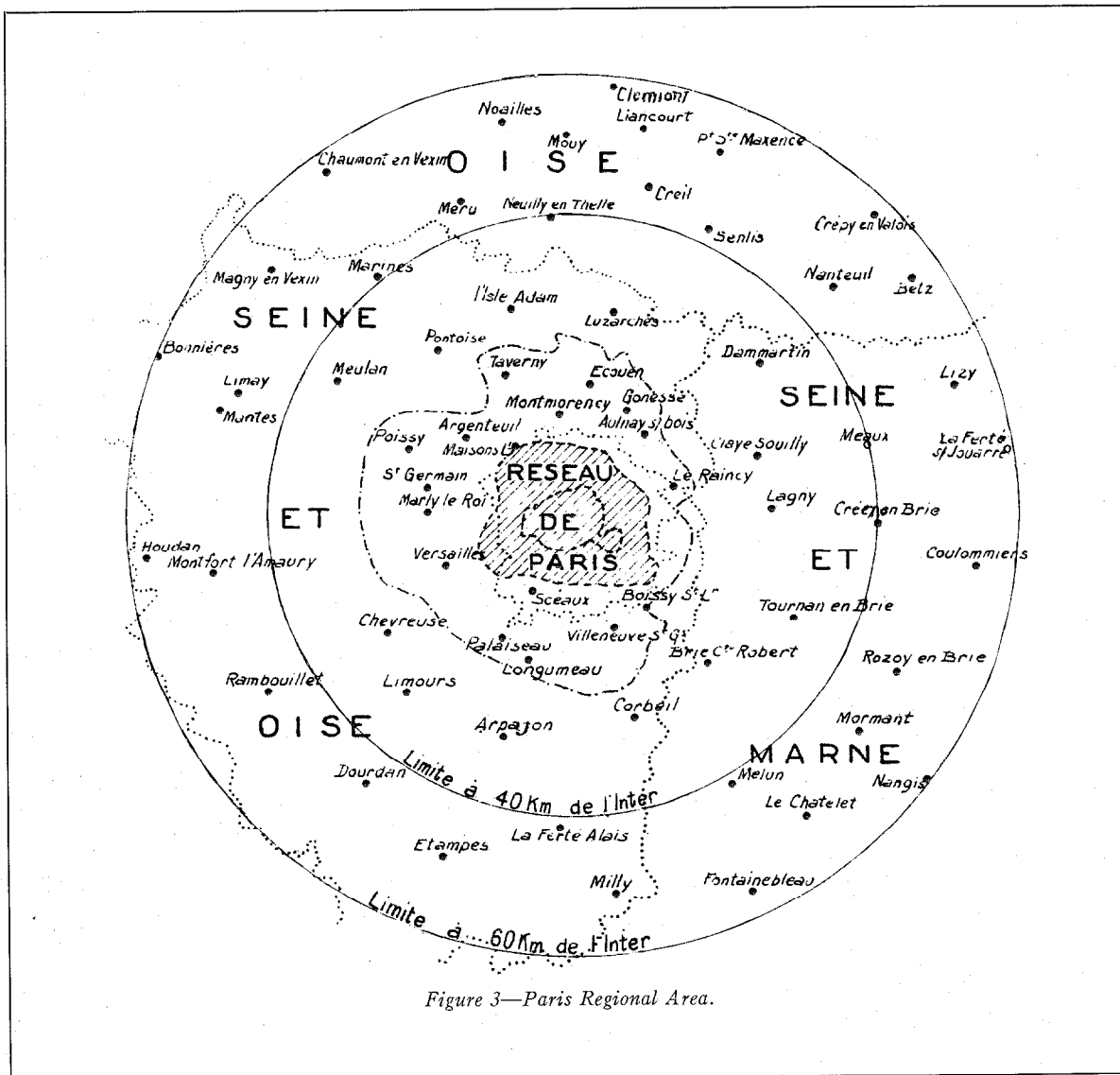

Figure 3—Paris Regional Area.

(ii) Repetition of impulses after the first transit center tandem selection in the calling sector.

(iii) Complete registration and storage of the repeated impulses followed by the second transit center tandem selection in the called section.

(iiii) The setting of the third, fourth, and final selectors at the called automatic office.

(3) *In the Regional Area*, the future condition after conversion to automatic is not defined; several projects are under study, but no decision has, as yet, been taken concerning them.

The following solution could be adopted:

The offices in the area in question would be divided into about 30 regional groups, each consisting of a central group and several satellites.

The method of operation would be as follows:

(a) Connections with the other parts of the automatic network from a subscriber directly connected to a regional group center would be carried out in the same way as in the automatic suburban area (Figs. 10, 11, and 12).

(b) Connections with the other parts of the network from a subscriber connected to a regional satellite would be carried out first by direct registration-translation in the regional group center, and then as in (a).

(c) Connections of two subscribers to the same regional satellite would be carried out by a discriminator placed in the satellite after a temporary connection with a trunk and a translator-

LIST OF AUTOMATIC OFFICE NAMES AND PREFIXES PARIS AREA					
OFFICE NAMES	PREFIXES		OFFICE NAMES	PREFIXES	
	ALPHABETICAL	NUMERICAL		ALPHABETICAL	NUMERICAL
ALESIA	ALE.	253	LAMARTINE	LAM.	526
ANJOU	ANJ.	265	LITRE	LIT.	548
ARCHIVES	ARC.	272	LONGCHAMP	LON.	506
AUTEUIL	AUT.	288	LOUVRE	LOU.	508
AVRON	AVR.	287	MAILLOT	MAI.	624
BALZAC	BAL.	225	MARCADET	MAR.	827
BELLEVUE	BEL.	235	MENILMONTANT	MEN.	636
BOTZARIS	BOT.	208	MICHELET	MIC.	642
CARNOT	CAR.	227	MOLITOR	MOL.	605
CAUMARTIN	CAU.	228	MONTMARTRE	MON.	608
CENTRAL	CEN.	236	NOISY-LE-SEC	NOI.	604
CHARLEBOURG	CHA.	242	NORD	NOR.	607
CLAMART	CLA.	252	OBERRAMPF	OBE.	023
CLIGNANCOURT	CLI.	254	OBSERVATOIRE	OBS.	027
COMBAT	COM.	206	ODEON	ODE.	033
DANTON	DAN.	326	OPERA	OPE.	073
DAUMESNIL	DAU.	328	PASSY	PAS.	727
DEFENSE	DEF.	333	PEREIRE	PER.	737
DIDEROT	DID.	343	PIGALLE	PIG.	744
DORIAN	DOR.	307	PLAINE	PLA.	752
ELYSEES	ELY.	359	PROVENCE	PRO.	770
ENTREPOT	ENT.	368	PUTEAUX	PUT.	788
ETOILE	ETO.	380	RICHELIEU	RIC.	742
EUROPE	EUR.	387	ROQUETTE	ROQ.	700
FLANDRE	FLA.	352	SEGUR	SEG.	734
GALVANI	GAL.	425	SEVRES	SEV.	738
GLACIERE	GLA.	452	SURESNES	SUR.	787
GOBELINS	GOB.	402	TAITBOUT	TAI.	824
GRAVELLE	GRA.	472	TREMBLAY	TRE.	873
GRESILLONS	GRE.	473	TRINITE	TRI.	874
GUTENBERG	GUT.	488	TROCADERO	TRO.	870
INVALIDES	INV.	468	TRUDAINES	TRU.	878
ISSY-LES-MOUL.	ISS.	477	TURBIGO	TUR.	887
ITALIE	ITA.	482	VAL-D'OR	VAL.	825
JASHIN	JAS.	527	VANVES	VAN.	826
KLEBER	KLE.	553	VAUGIRARD	VAU.	828
LABORDE	LAB.	522	VILLETTE	VIL.	845
LAFFITTE	LAF.	523	WAGRAM	WAG.	924

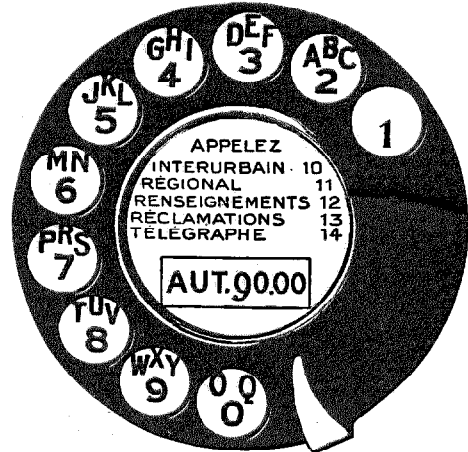

Matériel français pour lignes électriques, access. pour lignes aér. r. Crespin-du-Gast, 14 (11\*), OBERRAMPF 60.40  
 Matériel Radio Electrig. M. S. V. (Lc), av. Trudaine, 31. TRUDAINES 35.91  
 Matériel Roulant (Lc), constr. forg. fond. de Fourchambault, r. d'Aguesseau, 4 (8\*). ANJOU 14.89  
 — r. de Lancry, 65 (10\*). NORD 27.88  
 — des Epinettes, 53 (17\*). MARCHÉ 74.27  
 — r. de la Bourse, 6 (2\*). 2 lignes groupées CENTRAL 94.22  
 — av. de Taillebourg, 11 (11\*). DIDROT 37.25  
 — r. d'Hauteville, 62 (10\*). TAITBOUT 19.85  
 MATERIEL TELEPHONIQUE (Lc), T. S. F., câbles, appareils téléphoniques, siège social, q. de Boulogne, 16\*, 17\*, Boulogne-Billancourt\*, 10 lignes groupées AUTEUIL 90.00  
 \* — même adresse ..... 4 lignes groupées MOLITOR 44.81  
 — serv. comm., av. des Ch.-Elysées, 52. 5 lignes gr. ELYSEES 90.05  
 — laboratoires, av. de Breteuil, 66 (7\*). 4 lignes group. SEGUR 90.00  
 — même adresse..... SEGUR 88.46  
 \*MATERIEL TELEPHONIQUE (Lc), service des installations privées, r. de Vaugirard, 251 à 255 (15\*). 7 lignes group. VAUGIRARD 25.70  
 \*Maternan (Johan), restaur., r. du Montparnasse, 42 (14\*). DANTON 91.34  
 Maternelle Française, Cie anon. d'assur. de nuptialité, av. de Messine, 20 (8\*). LABORDE 64.00  
 Maternité des Diaconesses, r. du Sergent-Bauchat, 18. DIDROT 23.12  
 Maternité Fondation Cognac-Jay, r. Eugène-Milon, 15. VAUGIRARD 48.38  
 Maternité N.-D.-de-Bon-Secours, r. Giordano-Bruno, 11. VAUGIRARD 45.07

Figure 4—List of Paris City and Suburban Office Names and Prefixes.

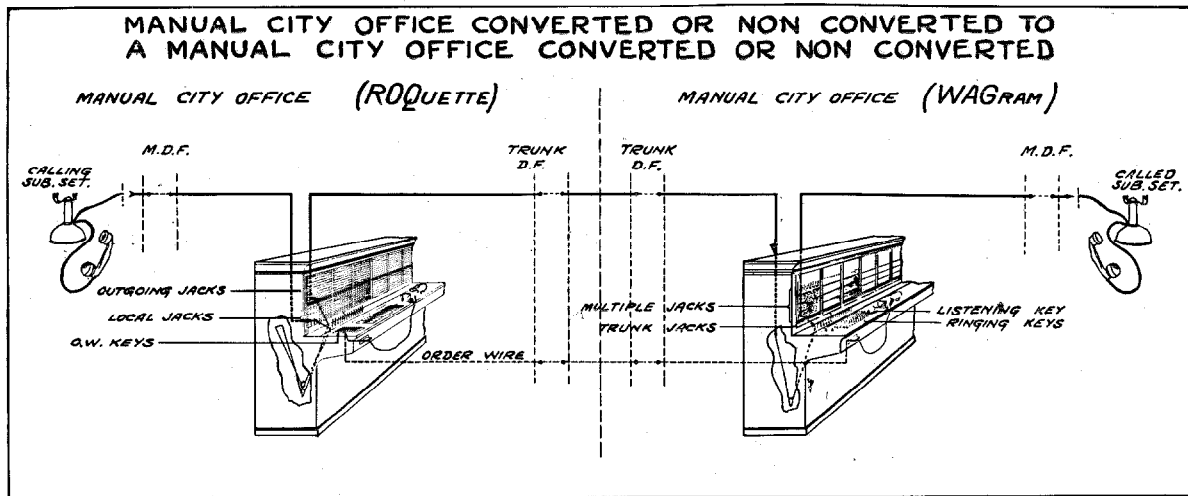

Figure 5.

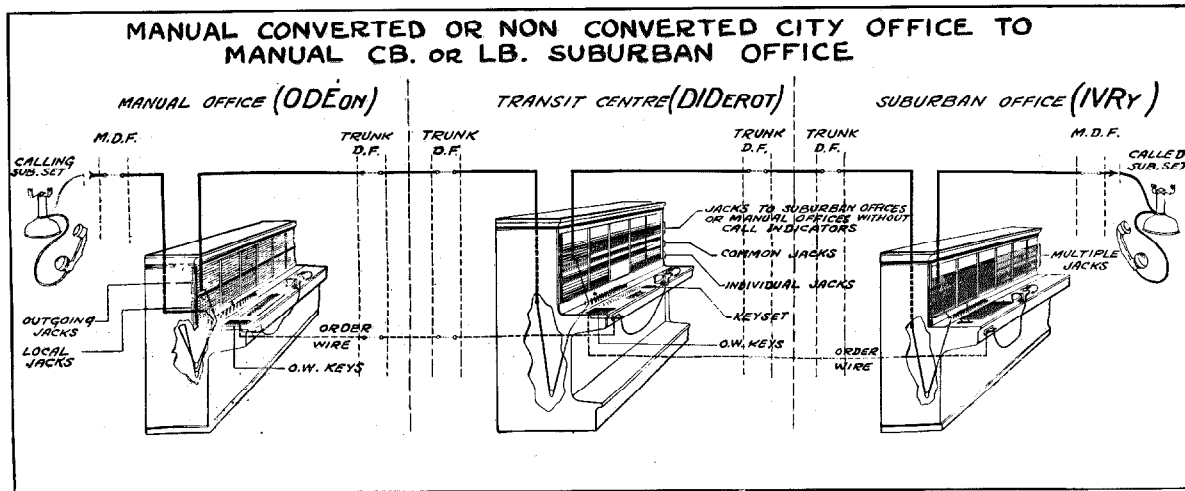

Figure 6.

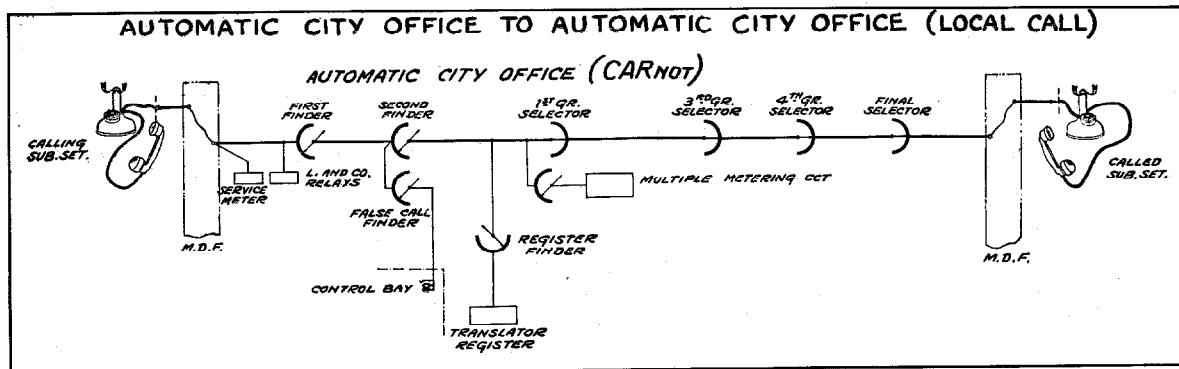

Figure 7.



register in the corresponding group center, according to the well-known rural practice.

### *V. Use of Semiautomatic Trunking Plans During the Different Stages of the Conversion.*

Having described the trunking plans of the former manual network and the trunking plans of the automatic network after conversion to full automatic working, there will now be described the different semiautomatic trunking plans which have yielded the following advantages during the transformation period.

(a) To the automatic or manual subscribers: uniformity of operation during the whole period of the conversion.

(b) To the "A" operators of the manual offices: ease in reaching automatically subscribers in automatic offices.

(c) To the operating organization: economy in "A" and "B" operators.

### *VI. Semiautomatic Trunking Plans in the City Area*

The Paris manual offices have been supplied with semiautomatic equipment enabling them to deal adequately with all traffic to or from automatic offices.

That part of the equipment reserved for manual to automatic traffic is called "direct trunking" equipment, and that reserved for automatic to manual traffic is termed "call indicator trunking" equipment.

#### *(a) Direct Trunking*

Every manual "A" position is fitted with a high-speed keyset of 10 numerical keys.

Trunks towards all the different automatic offices are provided.

Each manual office also has a common group of registers, each provided with a trunk finder.

The method of operation, Fig. 13, is as follows:

When an "A" operator wishes to obtain an automatic subscriber, she plugs, without preliminary test, into an individual jack corresponding to the desired office. This operation places at her disposal a free register, a trunk finder, a jack finder and a trunk to the desired automatic office.

The operator sends on her keyset the number required, i.e., four digits. This operation marks

the recording relays of the direct trunking register, which in turn sets and controls successively by reverse impulses the third, fourth, and final selectors in the called automatic office.

The direct trunking register is then released and the trunk maintains the connection between the two subscribers until the operator removes the plug.

Experience has shown that this device is rapid for the subscriber, easy for the operator, and economical to exploit by reason of the elimination of "B" operators, i.e., only one operator is required to establish a manual to automatic inter-office connection.

#### *(b) Call Indicator Trunking*

A certain number of "B" positions of the manual offices are provided with a luminous lamp panel which serves as a call indicator.

Each "B" position has 30 incoming "B" cords and a group of 3-call indicator-registers. Each register contains three sequence switches and a group of relays capable of setting up any four digit number from 0000-9999, controlling the call indicator lamps.

Call distribution is provided to equalise the load between operators, and the operators have facilities for assisting uncompleted calls.

The trunking plan, Fig. 14, enables an automatic subscriber to call on his dial a manual subscriber without repeating verbally the desired number to a manual operator.

When the automatic subscriber removes the receiver and hears the dialling tone, he is connected with an automatic translator-register and a first group selector. The dialling of the prefix of the manual office desired sets the translator-register to the corresponding translator level. A first selection controlled by this level enables the first group selector to seize a local second selector having access to the called manual office.

A second selection, controlled also by the translator-register position, causes the second group selector to hunt for a free trunk to the called office.

When a free trunk has been seized, a lamp glows on the call indicator monocord at the manual office, while a C.I. register becomes connected to the trunk.

Four selections are made to set the sequence switches of the C.I. register, in accordance with

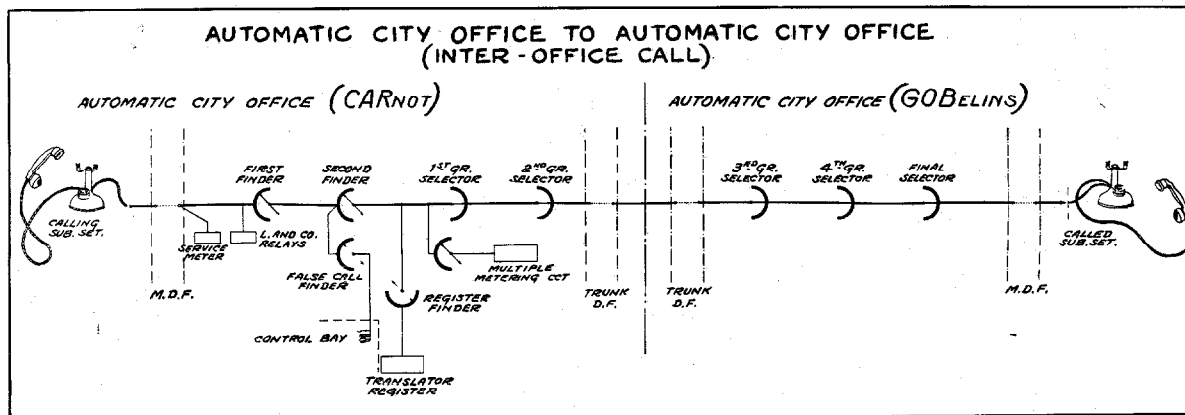

Figure 8.

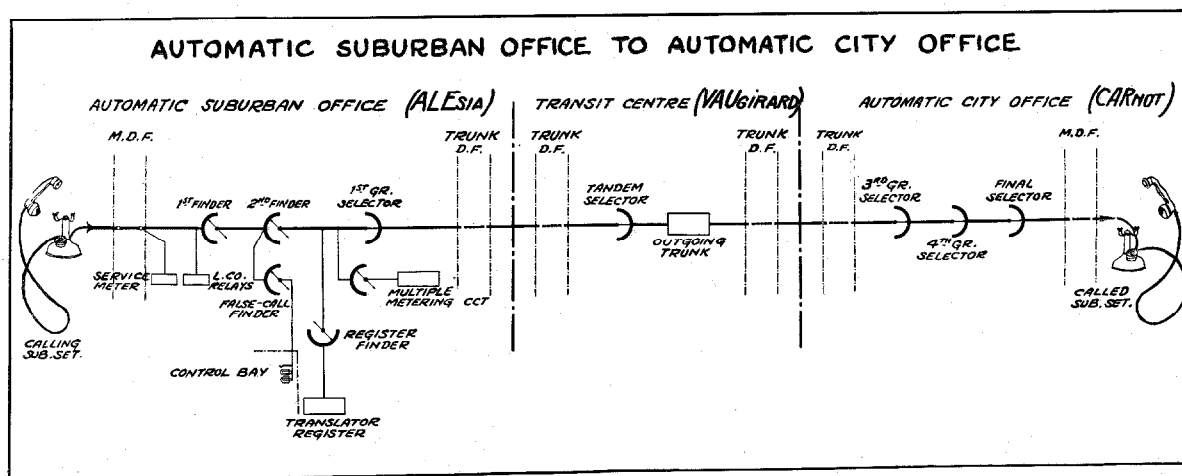

Figure 9.

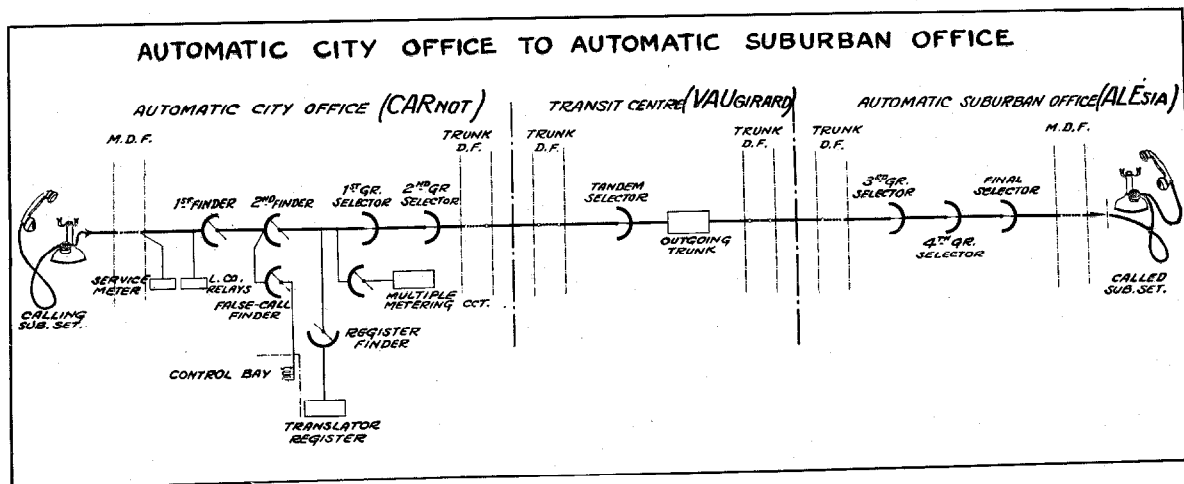

Figure 10.

the position of the 4-digit switches of the automatic translator-register of the calling office; this translator-register is then released.

The number appears on the luminous call indicator panel of the "B" operator who completes the call by plugging in the desired subscriber's multiple jack, thus releasing the C.I. and its register.

Experience confirms that this plan gives great uniformity of operation to the automatic subscribers who do not need to know about the progress of the conversion of the network since, from their standpoint, the desired numbers are dialled in identically the same manner both for automatic or manual subscribers.

### *VII. Semiautomatic Trunking Plans in Transit Centers*

The object of these trunking plans is to ensure the interworking in both directions between the manual suburban offices and the Paris offices. They consist of two distinct schemes:

#### *(a) Transit Direct Trunking*

A transit center is provided with a number of direct trunking positions similar to manual "A" positions (Fig. 15).

These positions, which handle the traffic from the suburbs to Paris, are provided with monocords terminating the incoming trunks from the suburban offices and are fitted with a high-speed keyset with 10 numerical keys. Outgoing trunk jacks to all city offices are provided.

A manual suburban office desiring a city subscriber calls the transit center direct trunking operator, who operates her keyset as in VI(a).

#### *(b) Transit Call Indicator Trunking*

A transit center, in addition to the direct trunking positions, is provided with a certain number of call indicator positions (Fig. 16).

These positions, which handle the traffic from Paris to the suburbs, have outgoing trunk jacks to the suburban offices, monocords terminating the incoming city trunks, and a luminous call indicator panel.

The transit call indicator functions in the same way as that of a city office, as in VI(b). It must be noted, however, that it has five digits instead of four; the transit operator must be given the characteristic number of the called suburban office as well as the number of the desired subscriber.

### *VIII. Semiautomatic Trunking Plans in Suburban Group Centers—Suburban and Regional Areas*

The suburban and regional areas contain a certain number of independent offices and a certain number of offices grouped together.

The grouped offices are connected with the center which works either as a manual tandem center or a semiautomatic rural group center.

Typical cases of these groups are: Charlebourg, for example, for the suburban area, and Enghien for the regional area.

The semiautomatic trunking schemes carried out in these group centers have for their purpose the speeding up of the traffic from the suburban and regional areas to Paris, and the elimination of tandem operators, e.g., one operator instead of two or more. They are similar to, but different from, the direct trunking previously described, and are termed "keyset trunking".

Every "A" position of a suburban office or regional group center thus equipped is provided with a high-speed keyset with 10 numerical keys. The office has, besides outgoing trunks provided with jack finders, a group of keyset registers, each having a trunk finder.

The outgoing trunks are connected to ordinary subscriber's line circuits in the associated automatic office.

The method of operation is as follows:

When an "A" operator wishes to reach a subscriber of a network outside of her group, she plugs, without preliminary test, into a jack field corresponding to an automatic office in the Paris network.

This operation gives her, by means of a jack finder, an outgoing trunk to that automatic office; and then, through its trunk finder, a keyset register becomes connected to the trunk.

The operator keysets the seven digits of the called number.

The digits are registered by marking relays which control the impulse trains produced by an impulse sender and sent out on the trunk. The communication is established in the same way as an ordinary automatic call under the control of a translator-register at the automatic office.

Experience has shown that this plan is very efficient and has the same advantages as the city direct trunking, i.e., rapidity for the subscriber,

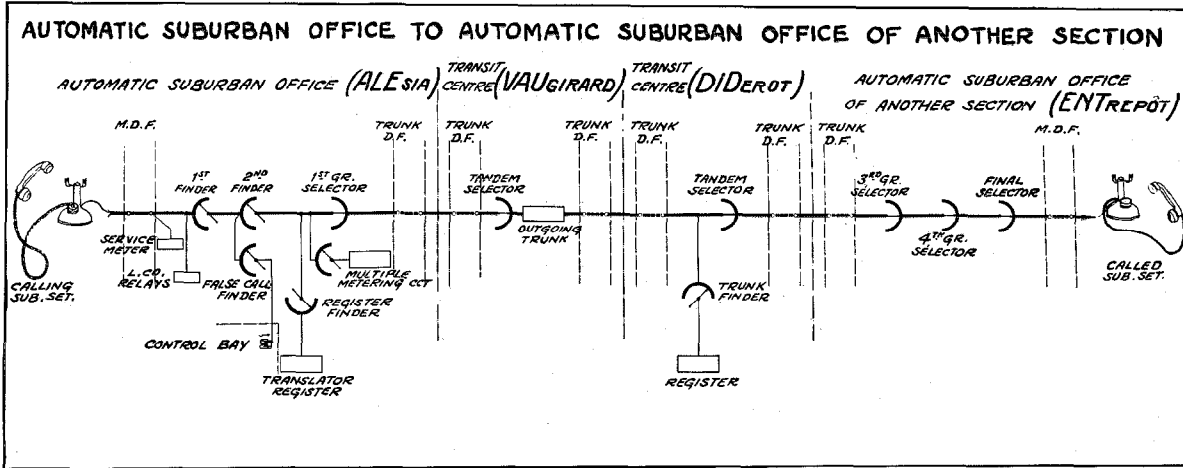

Figure 11.

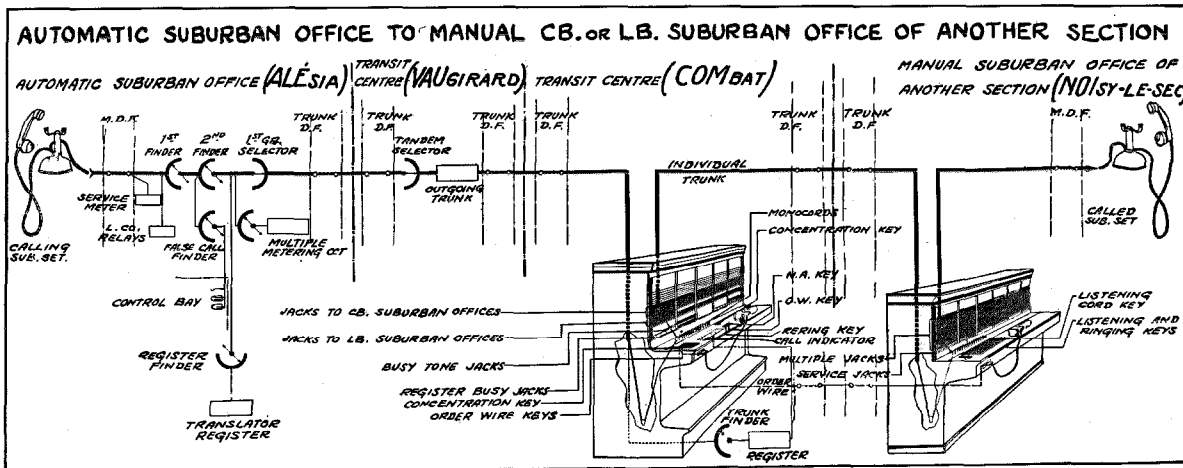

Figure 12.

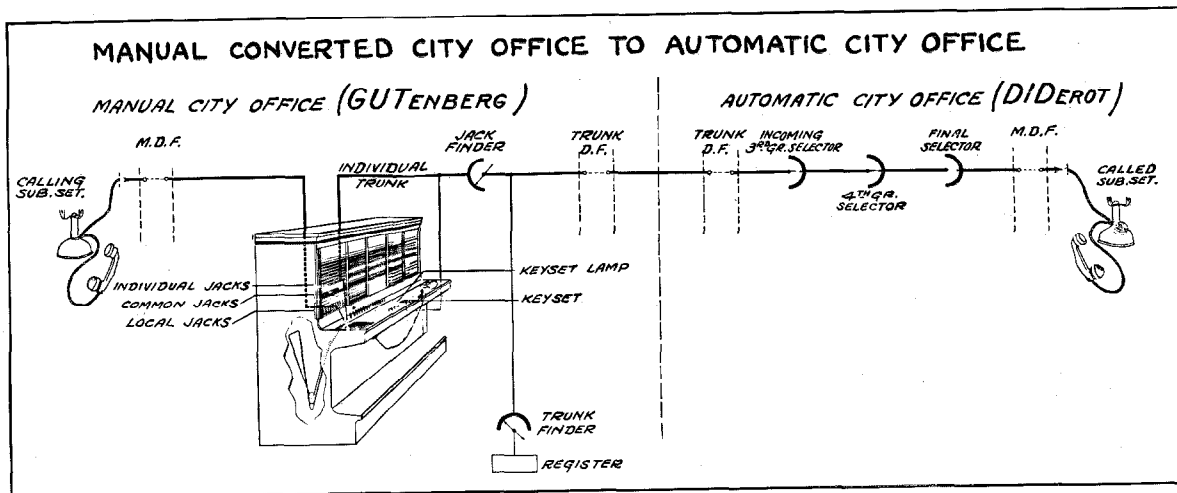

Figure 13.

ease for the operator and operating economy.

It is interesting to note that some of the suburban group centers are supplied with call indicator equipment, as already described for city manual converted offices. The method of operation, being the same, will not be repeated.

In general, such indicator positions have been provided when the volume of traffic is relatively important.

When the traffic is less important:

- (1) Paris-Suburban traffic is routed via the transit center call indicators;
- (2) Paris-Regional traffic is handled via the central regional office.

In this latter class, the traffic is ticketed for rate charging purposes. The central regional office is obtained by dialling a 2-digit prefix and the connections are given on a no-delay basis.

### IX. Other Trunking Schemes

The preceding description deals with trunking schemes employed at the beginning and after completion of the conversion of the network to automatic working; in addition, it may be of interest to describe some of the trunking plans which have been or still are used to ensure without interruption the inter-connection between offices of different kinds.

Certain city manual offices, which were to be replaced within a short time or which were not suitable for the introduction of the call indicator and direct trunking equipment, remained as they were at the beginning of the conversion period.

To permit this, for automatic to manual traffic, cordless tandem call indicator positions were used. The called number appears on the call indicator; at the same time, the trunk to the terminating office is automatically selected, the tandem call indicator operator repeating the displayed number over the order wire to the terminating "B" operator.

Manual to automatic traffic was handled over cordless semi-"B" positions, the "A" operator ordering up the connection over an order wire. The semi-"B" operator assigns the trunk and sets up the number on her 10-button keyset.

The selection is entirely automatic; the release, also automatic, remaining under the con-

trol of the "A" operator when she withdraws the plug at the end of the conversation.

Both the above semi-"B" and tandem call indicator positions were of unit construction so they could readily be located in their associated or other automatic office at will, or could be moved from job to job as the conversion progressed. In many instances, these positions were moved several times.

The substitution of the automatic for the manual system being carried out simultaneously in the city and the suburban area, some suburban offices are already automatic, while some of the city offices are still manual.

The following are the principal trunking problems which arose:

- (1) *City Automatic Office to Non-Converted City Manual Office*

The translator-register in the calling office receives the required number; it exercises direction and control by means of a first group and second group trunking in the calling office. The call being extended to a free trunk ending in the called office on a "B" position monocord, this trunk, the occupation of which gives no signal to the "B" operator of the called office, passes in the calling office via a tandem call indicator position, where it is connected to a call indicator register (Fig. 17).

The call indicator register receives from the translator-register of the calling office the four figures of the number the subscriber has dialled and causes these figures to appear on the luminous call indicator panel before the tandem operator; at this moment only, the lamp of the monocord lights up at the called office. The tandem operator passes verbally the required number to the called office "B" operator and, if necessary, the number of the trunk and monocord. The "B" operator of the called office completes the communication by inserting the plug of the monocord in the called subscriber's multiple jack.

- (2) *Non-Converted City Manual Office to City Automatic Office*

The calling office "A" operator passes by order wire the calling subscriber's request to the semi-"B" position operator in the called auto-

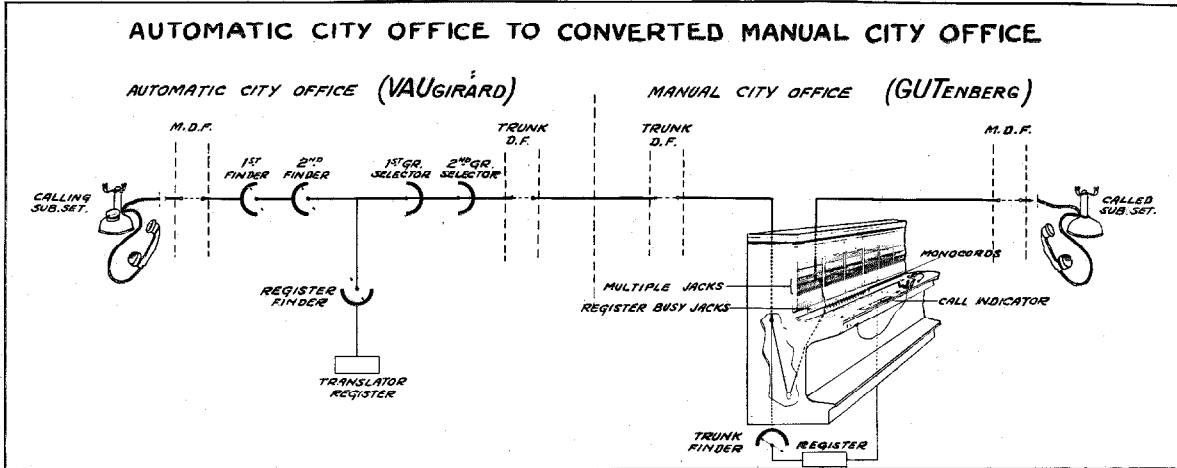

Figure 14.

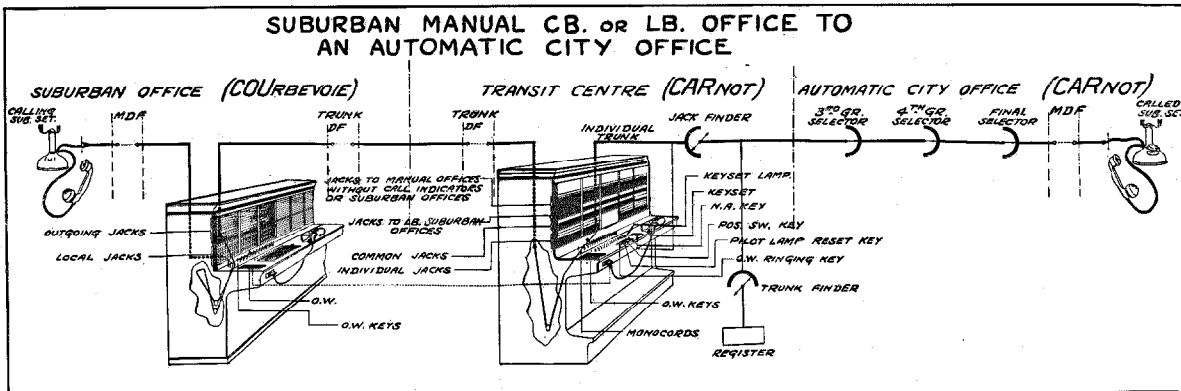

Figure 15.

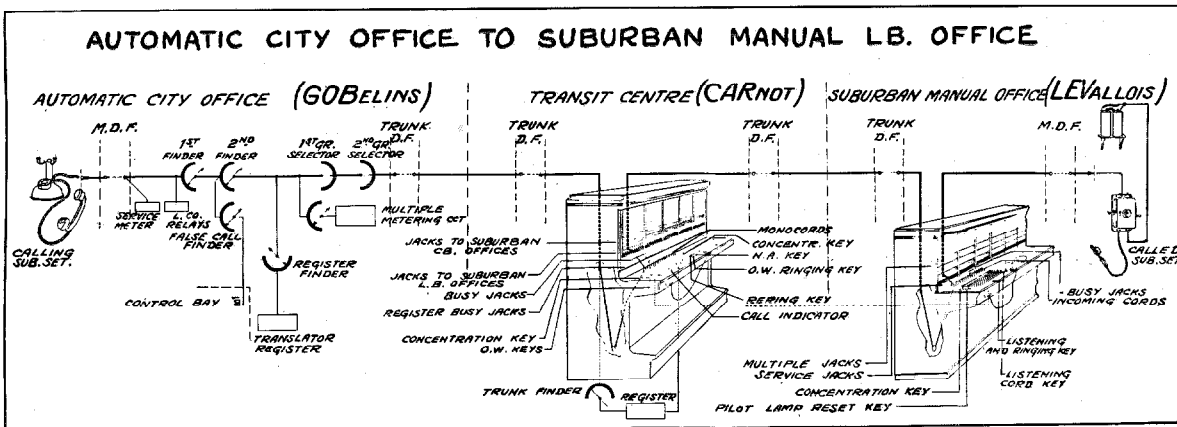

Figure 16.

matic office; this operator assigns a trunk to the calling office "A" operator (Fig. 18).

The trunk ends, in the called automatic office, in an incoming third group selector; its assignment connects it, at the semi-"B" position, to a semi-"B" register and to the operator's keyset.

The semi-"B" operator keysets the four figures of the required number, which are stored in the semi-"B" register. The semi-"B" register directs and controls the selection via a third group incoming selector which extends the trunk to a fourth group selector and via a final selector to the called automatic subscriber's line.

(3) *Converted or Non-Converted Manual City Office to a Suburban Automatic Office*

The calling office "A" operator passes the request by order wire to the direct trunking position operator in the transit center which handles the called office. The transit center operator assigns the trunk and makes the connection with a trunk which is terminated in the called office by an incoming third group selector (Fig. 19).

At the direct trunking position, the trunk between the transit center and the called office is connected automatically to the operator's keyset, and to the direct trunking register.

The transit center operator keysets the four figures of the called subscriber's number; the direct trunking register receives these four figures; it directs and controls the selection of the called subscriber's number in the called office via an incoming third group selector, a fourth group selector, and a final selector.

(4) *Suburban Automatic Office to a Converted Manual City Office*

The register of the calling office directs and controls the selection via a first group selector in the calling office and via tandem selection in the transit center of the sector, the selection of a free trunk ending in a "B" position call indicator monocord in the called office (Fig. 20).

In the called office, this trunk and its monocord are automatically connected to a call indicator register, which receives from the translator-register of the calling office and displays on the lamp panel call indicator, the figures necessary to complete the connection.

The called office "B" operator inserts the

monocord plug in the subscriber's multiple jack corresponding to the number displayed on the call indicator.

(5) *Suburban Automatic Office to a C.B. or L.B. Suburban Manual Office of the Same Section*

The calling office first group selector seizes a free trunk to the transit center of the required section, where it terminates in a monocord at a call indicator position. This call indicator displays the figures denoting the called office and the called subscriber's number; the transit center operator completes the connection, bearing in mind the nature of the equipment of the called office, whose "B" operator is reached by order wire or over a ringdown trunk (Fig. 21).

(6) *C.B. or L.B. Suburban Manual Office to a Converted City Manual Office*

The calling office "A" operator orders up the connection to a direct trunking position operator at the transit center; the transit center operator assigns the trunk and connects this trunk to the called manual city office. In the transit center, the outgoing trunk is connected automatically to the operator's keyset and to a direct trunking register; the incoming trunk in the called manual office terminates in a call indicator "B" position monocord, and is automatically connected to a call indicator register (Fig. 22).

The transit center operator keysets the figures of the called subscriber's number; these figures are transferred to the call indicator register, and displayed on a luminous lamp panel call indicator in the called office; the called office "B" operator completes the connection by inserting the monocord plug in the called subscriber's multiple jack.

(7) *C.B. or L.B. Manual Suburban Office to a Manual Suburban Office of the Same or Another Section*

The call received by the calling office "A" operator is transmitted to a transit center operator of the calling section (Fig. 23).

The transit center operator passes the call to the called office if it is for the same section, or to a transit center operator of the called section; in this latter case, the transit center operator of the called section passes the call to a "B" operator of the called office.

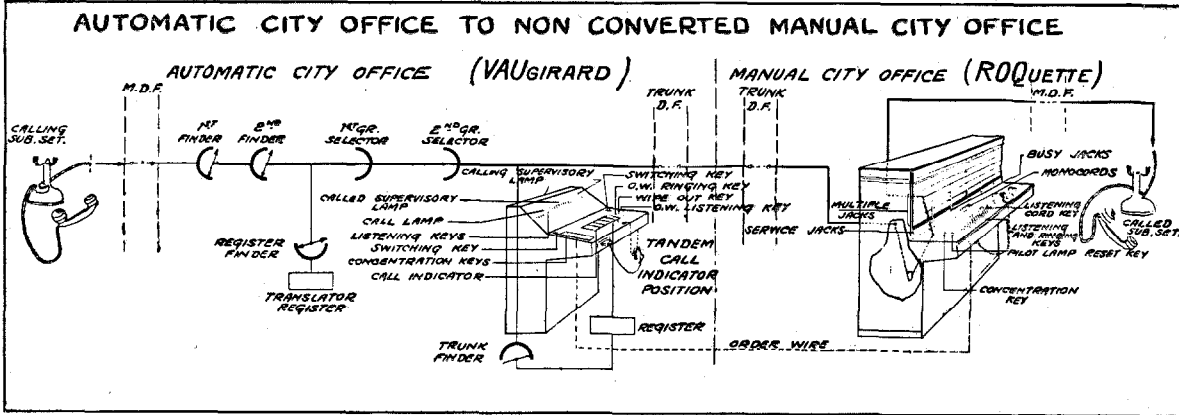

Figure 17.

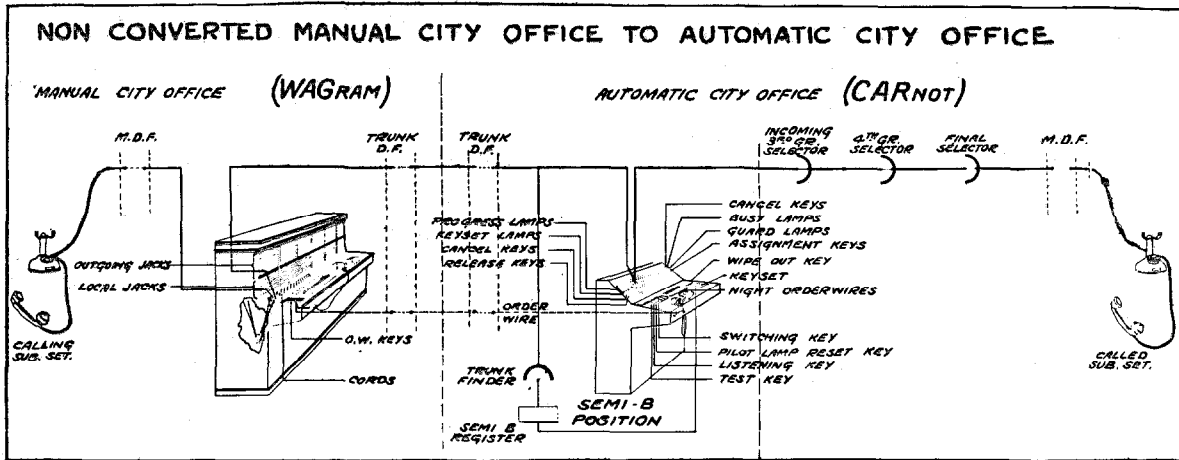

Figure 18.

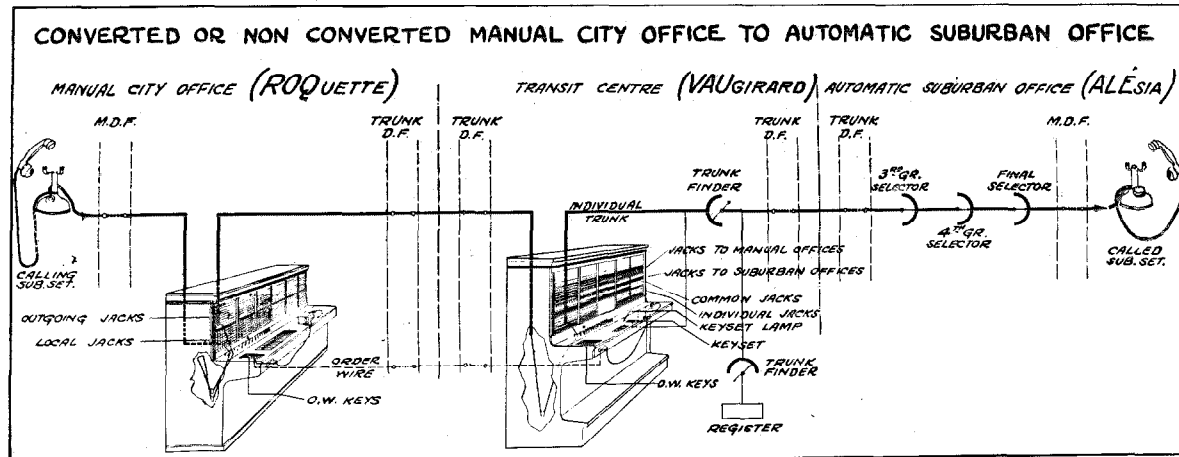

Figure 19.



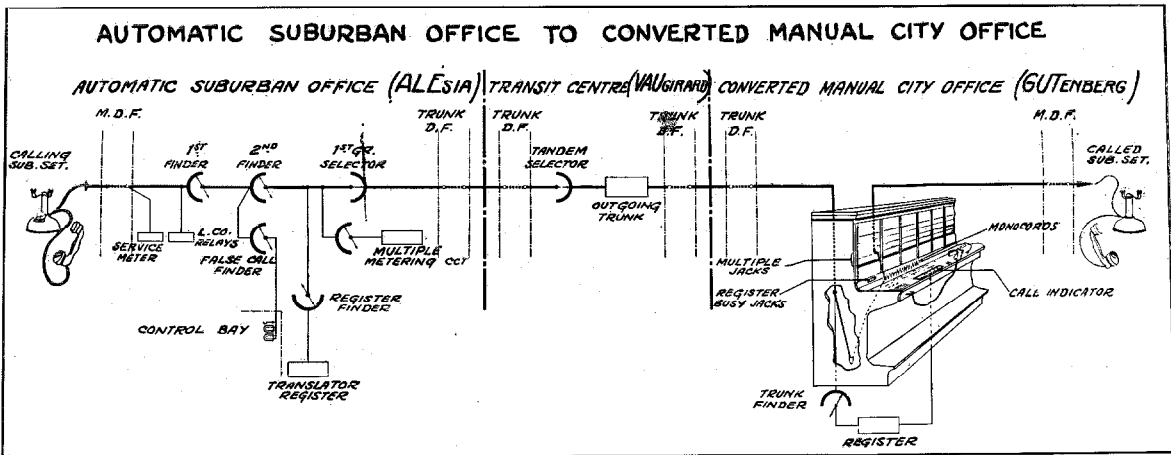

Figure 20.

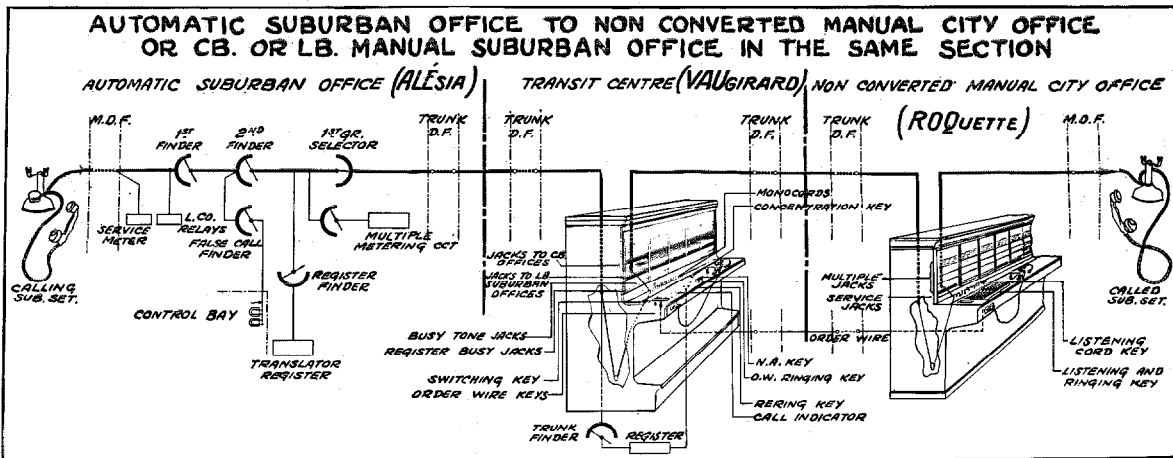

Figure 21.

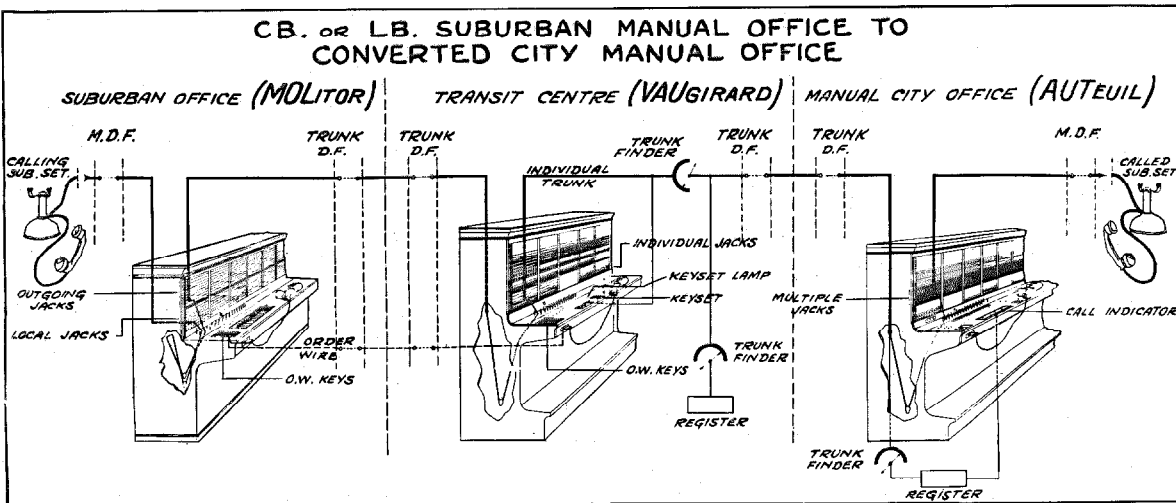
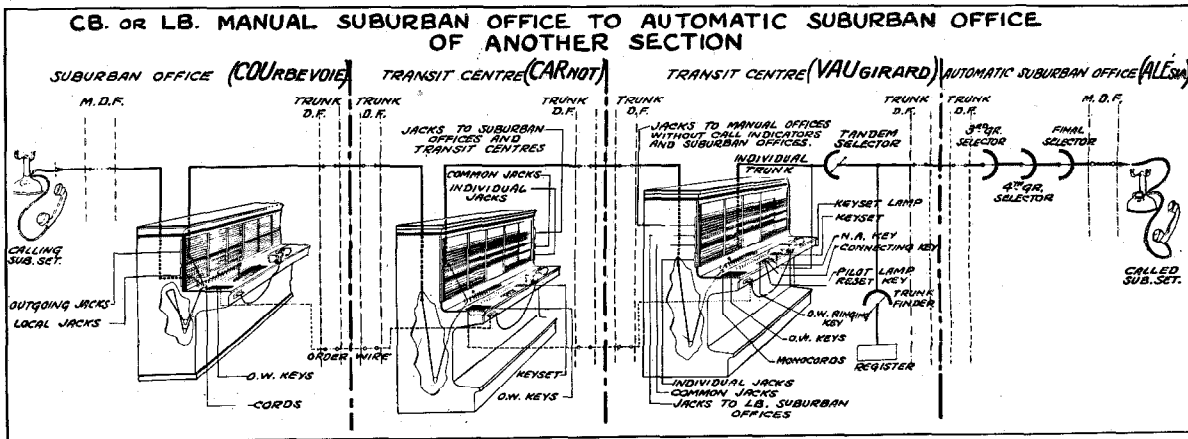
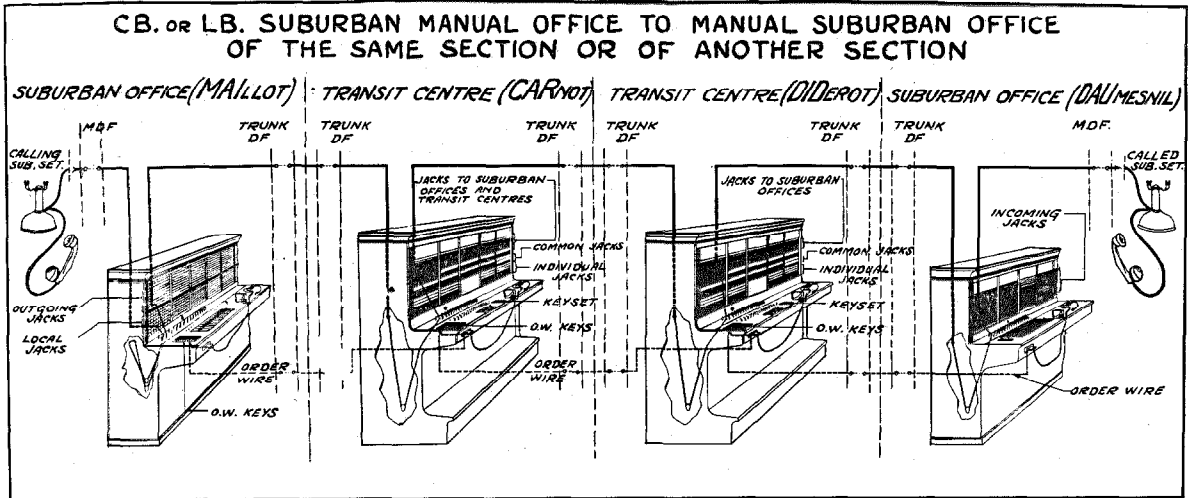

Figure 22.



(8) *C.B. or L.B. Manual Suburban Office to an Automatic Suburban Office of Another Section*

The call sent by the calling office "A" operator is passed to a transit center operator of the calling section, who transmits it by order wire to an operator of a direct trunking position in the transit center of the section required. The transit center operator of the called section connects the monocord to a free trunk to the called office, and keysends the called number (Fig. 24).

The direct trunking register of the transit center of the called section directs and controls in the called office the third group, fourth group, and final selectors necessary to reach the line of the called subscriber.

## X. Conclusion

(A) The semiautomatic direct trunking plans carried out in the city, suburban, and regional offices in the Paris area, have enabled speeding up the traffic between the manual offices of these areas and the automatic Paris offices. They have also realized considerable economy in operators.

This method is applicable in the semiautomatic group centers farthest from the network, such as Melun and Mantes.

(B) The semiautomatic call indicator trunking plans, carried out in the city offices and transit centers, have given to the automatic subscribers manual city and suburban service by means of the same dialling operations, both during and

after the conversion to automatic of any particular office.

(C) To sum up, one can say that, bearing in mind the experience gained with thirty-two cut-overs up to date, the semiautomatic trunking plans utilised in Paris and suburban offices, in the transition stage between manual and full automatic operation, have enabled the progressive conversion to automatic of the network without undue disturbance to the public, and also have improved the service in the offices where they are temporarily installed.

From the economic standpoint, it is important to note that the gradual conversion of such an

important telephone area has been accomplished without extensive modifications to the existing cable network due to application of the translator-registers associated with the equipments mentioned.

The complete conversion to automatic in large telephone areas is, nevertheless, the only solution capable of satisfying subscribers who, since the increase of full automatic working in many places, have become more and more accustomed to demand from their telephone systems, rapid dependable connections, combined with immediate release, i.e., good service including accuracy and speed.

# Wide Band Transmission Over Coaxial Lines\*

By LLOYD ESPENSCHIED

*Fellow A.I.E.E.,*

and M. E. STRIEBY

*Member A.I.E.E.,*

*Bell Telephone Laboratories, Inc., New York, N. Y.*

*In this paper systems are described whereby frequency band widths of the order of 1,000 kc. or more may be transmitted for long distances over coaxial lines and utilized for purposes of multiplex telephony or television. A coaxial line is a metal tube surrounding a central conductor and separated from it by insulating supports.*

IT appears from recent development work that under some conditions it will be economically advantageous to make use of considerably wider frequency ranges for telephone and telegraph transmission than are now in use<sup>1,2</sup> or than are covered in the recent paper on carrier in cable.<sup>3</sup> Furthermore, the possibilities of television have come into active consideration and it is realized that a band of the order of 1,000 kc. or more in width would be essential for television of reasonably high definition if that art were to come into practical use.<sup>4,5</sup>

This paper describes certain apparatus and structures which have been developed to employ such wide frequency ranges. The future commercial application of these systems will depend upon a great many factors, including the demand for additional large groups of communication facilities or of facilities for television. Their practical introduction is, therefore, not immediately contemplated and, in any event, will necessarily be a very gradual process.

## *Types of High Frequency Circuits*

The existing types of wire circuits can be worked to frequencies of tens of thousands of cycles, as is evidenced by the widespread application of carrier systems to the open wire telephone plant and by the development of carrier systems for telephone cable circuits.<sup>2,3</sup> Further development may lead to the operation of still higher frequencies over the existing types of plant. However, for protection against

external interference these circuits rely upon balance, and as the frequency band is widened, it becomes more and more difficult to maintain a sufficiently high degree of balance. Balance requirements may be made less severe by individually shielding each circuit and, with sufficient shielding, balance may be entirely dispensed with.

A form of circuit which differs from existing types in that it is unbalanced (one of the conductors being grounded), is the coaxial or concentric circuit. This consists essentially of an outer conducting tube which envelops a centrally disposed conductor. The high-frequency transmission circuit is formed between the inner surface of the outer conductor and the outer surface of the inner conductor. Unduly large losses at the higher frequencies are prevented by the nature of the construction, the inner conductor being so supported within the tube that the intervening dielectric is largely gaseous, the separation between the conductors being substantial, and the outer conductor presenting a relatively large surface. By virtue of skin effect, the outer tube serves both as a conductor and a shield, the desired currents concentrating on its inner surface and the undesired interfering currents on the outer surface. Thus, the same skin effect which increases the losses within the conductors provides the shielding which protects the transmission path from outside influences, this protection being more effective the higher the frequency.

The system which this paper outlines has been based primarily upon the use of the coaxial line. The repeater and terminal apparatus described, however, are generally applicable to any type of

\* Republished by permission from *Electrical Engineering*, October, 1934.

<sup>1</sup> For all numbered references, see list at end of paper.

line, either balanced or unbalanced, which is capable of transmitting the frequency range desired.

### The Coaxial System

A general picture of the type of wide band transmission system which is to be discussed is briefly as follows: A coaxial line about 0.5 inch in outside diameter may be used to transmit a frequency band of about 1,000 kc., with repeaters capable of handling the entire band placed at intervals of about 10 miles. Terminal apparatus may be provided which will enable this band either to be subdivided into more than 200 telephone circuits or to be used *en bloc* for television.

Such a wide band system is illustrated in Fig. 1. It is shown to comprise several portions, namely, the line sections, the repeaters, and the terminal apparatus, the latter being indicated in this case as for multiplex telephony. Two-way operation is secured by using two lines, one for either direction. It would be possible, however, to divide the frequency band and use different parts for transmission in opposite directions.

A form of flexible line which has been found convenient in the experimental work is illustrated in Fig. 2 and will be described more fully subsequently. Such a coaxial line can be constructed to have the same degree of mechanical flexibility as the familiar telephone cable. While this line has a relatively high loss at high frequencies, the transmission path is particularly well adapted to the frequent application of repeaters, since the shielding permits the transmission currents to fall to low power levels at the high frequencies.

Of no little importance also is the fact that the attenuation-frequency characteristic is smooth throughout the entire band and obeys a simple law of change with temperature. (This is due to the fact that the dielectric is largely gaseous and that insulation material of good dielectric properties is employed.) This smooth relation is extremely helpful in the provision of means in the repeaters for automatically compensating for the variations which occur in the line attenuation with changes of temperature. This type of system is featured by large transmission losses which are offset by large amplification, and it is necessary that the two effects match each other accurately at all times throughout the frequency range.

It will be evident that the repeater is of out-

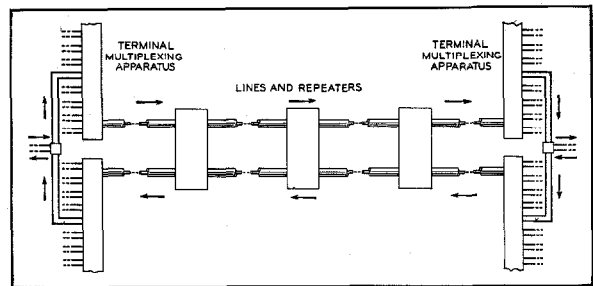

Figure 1—Diagram of Coaxial System.

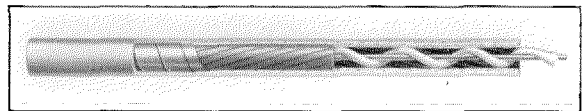

Figure 2—Small Flexible Coaxial Structure.

standing importance in this type of system, for it must not only transmit the wide band of frequencies with a transmission characteristic inverse to that of the line, with automatic regulation to care for temperature changes, but must also have sufficient freedom from intermodulation effects to permit the use of large numbers of repeaters in tandem without objectionable interference. Fortunately, recent advances in repeater technique have made this result possible, as will be appreciated from the subsequent description.

An interesting characteristic of this type of system is the way in which the width of the transmitted band is controlled by the repeater spacing and line size, as follows:

1. For a given size of conductor and given length of line, the band width increases nearly as the square of the number of the repeater points. Thus, for a coaxial circuit with about 0.3-inch inner diameter of outer conductor, a 20-mile repeater spacing will enable a band up to about 250 kc. to be transmitted, a 10-mile spacing will increase the band to about 1,000 kc., and a 5-mile spacing to about 4,000 kc.
2. For a given repeater spacing, the band width increases approximately as the square of the conductor diameter. Thus, whereas a tube of 0.3-inch inner diameter will transmit a band of about 1,000 kc., 0.6-inch diameter will transmit about 4,000 kc., while a diameter corresponding to a full sized telephone cable might transmit something of the order of 50,000 kc., depending upon the dielectric employed and upon the ability to provide suitable repeaters.

### Earlier Work

It may be of interest to note that as a structure,

the coaxial form of line is old—in fact, classical. During the latter half of the last century it was the object of theoretical study, in respect to skin effect and other problems, by some of the most prominent mathematical physicists of the time. Reference to some of this work is made in a paper by Schelkunoff, dealing with the theory of the coaxial circuit.<sup>6</sup>

On the practical side, it is found on looking back over the art that the coaxial form of line structure has been used in two rather widely different applications: First, as a long line for the transmission of low frequencies, examples of which are usage for submarine cables<sup>7,8</sup> and for power distribution purposes, and second as a short-distance high-frequency line serving as an antenna lead-in.<sup>9,10</sup>

The coaxial conductor system herein described may be regarded as an extension of these earlier applications to the long distance transmission of a very wide range of frequencies suitable for multiplex telephony or television.<sup>11</sup> Although dealing with radio frequencies, this system represents an extreme departure from radio systems in that a relatively broad band of waves is transmitted, this band being confined to a small physical channel which is shielded from outside disturbances. The system, in effect, comprehends a frequency spectrum of its own and shuts it off from its surroundings so that it may be used again and again in different systems without interference.

This new type of facility has not yet been commercially applied, and is, in fact, still in the development stage. Sufficient progress has already been made, however, to give reasonable assurance of a satisfactory solution of the technical problems involved. This progress is outlined below under three general headings: (1) the coaxial line and its transmission properties, (2) the wide band repeaters, and (3) the terminal apparatus.

### The Coaxial Line

#### An Experimental Verification

One of the first steps taken in the present development was in the nature of an experimental check of the coaxial conductor line, designed primarily to determine whether the desirable transmission properties which had been disclosed by a theoretical study could be fully

realized under practical conditions. For this purpose a length of coaxial structure capable of accurate computation was installed near Phoenixville, Pa. Fig. 3 indicates the structure used and gives its dimensions. It comprised a copper tube of 2.5 inch outside diameter, within which was mounted a smaller tube which, in turn, contained a small copper wire. Two coaxial circuits of different sizes were thus made available, one between the outer and the inner tubes, and the other between the inner tube and the central wire. The installation comprised two 2,600-foot lengths of this structure.

The diameters of these coaxial conductors were so chosen as to obtain for each of the two transmission paths a diameter ratio which approximates the optimum value, as discussed later. The conductors were separated by small insulators of isolantite. The rigid construction

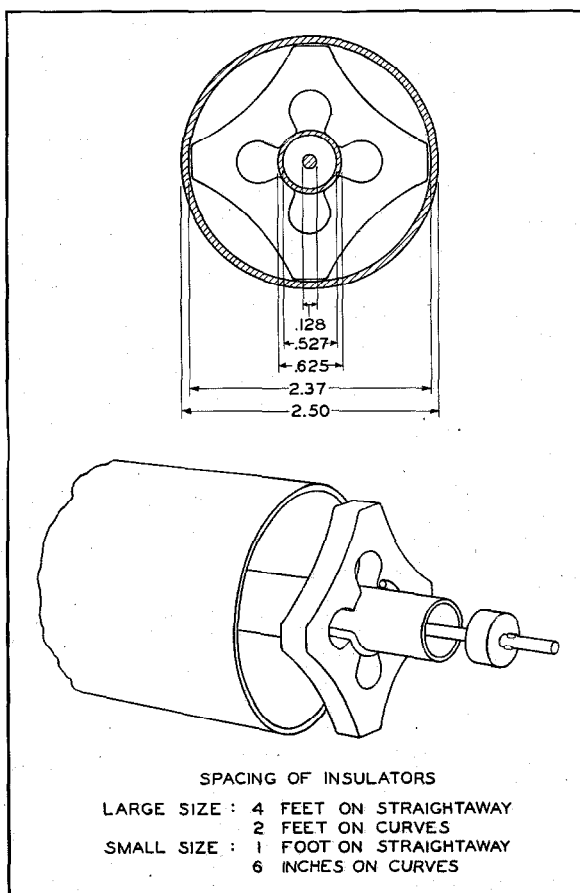

Figure 3—Structure Used in Phoenixville Installation.



Figure 4—Phoenixville Installation Showing Conductors Entering Test House.

and the substantial clearances between conductors made it possible to space the insulators at fairly wide intervals, so that the dielectric between conductors was almost entirely air. The outer conductor was made gastight, and the structure was dried out by circulating dry nitrogen gas through it. The two triple conductor lines were suspended on wooden fixtures and the ends brought into a test house, as shown in Fig. 4.

The attenuation was measured by different methods over the frequency range from about 100 kc. to 10,000 kc. Investigation showed that the departures from ideal construction occasioned by the joints, the lack of perfect concentricity, etc., had remarkably little effect upon the attenuation. In order to study the effect of eccentricity upon the attenuation, tests were made in which this effect was much exaggerated, and the results substantiated theoretical predictions. The impedance of the circuits was measured over the same range as the attenuation. A few measurements on a short length were made at frequencies as high as 20,000 kc..

Measurements were secured of the shielding effect of the outer conductor of the coaxial circuit up to frequencies in the order of 100 to 150 kc., the results agreeing closely with the

theoretical values. Above these frequencies, even with interfering sources much more powerful than would be encountered in practice, the induced currents dropped below the level of the noise due to thermal agitation of electricity in the conductors (resistance noise) and could not be measured.

The preliminary tests at Phoenixville, therefore, demonstrated that a practical coaxial circuit, with its inevitable mechanical departures from the ideal, showed transmission properties substantially in agreement with the theoretical predictions.

#### *Small Flexible Structures*

Development work on wide band amplifiers, as discussed later, indicated the practicability of employing repeaters at fairly close intervals. This pointed toward the desirability of using sizes of coaxial circuit somewhat smaller than the smaller of those used in the preliminary experiments, and having correspondingly greater attenuation. Furthermore, it was desired to secure flexible structures which could be handled on reels after the fashion of ordinary cable. Accordingly, several types of flexible construction, ranging in outer diameter from about 0.3 inch to 0.6 inch,

have been experimented with. Structures were desired which would be mechanically and electrically satisfactory, and which could be manufactured economically, preferably with a continuous process of fabrication.

One type of small flexible structure which has been developed is shown in Fig. 2. The outer conductor is formed of overlapping copper strips held in place with a binding of iron or brass tape. The insulation consists of a cotton string wound spirally around the inner conductor, which is a solid copper wire. This structure has been made in several sizes of the order of 0.5-inch diameter or less. When it is to be used as an individual cable, the outer conductor is surrounded by a lead sheath, as shown, to prevent the entrance of moisture. One or more of the copper tape structures without individual lead sheath may be placed with balanced pairs inside a common cable sheath.

Another flexible structure is shown in Fig. 5. The outer conductor in this case is a lead sheath which directly surrounds the inner conductor with its insulation. Since lead is a poorer conductor than copper, it is necessary to use a somewhat larger diameter with this construction in order to obtain the same transmission efficiency. Lead is also inferior to copper in its shielding properties and to obtain the same degree of shielding the lead tube of Fig. 5 must be made correspondingly thicker than is necessary for a copper tube.

The insulation used in the structure shown in Fig. 5 consists of hard rubber disks spaced at intervals along the inner wire. Cotton string or rubber disk insulation may be used with either form of outer tube. The hard rubber gives somewhat lower attenuation, particularly at the higher frequencies.

Another simple form of structure employs

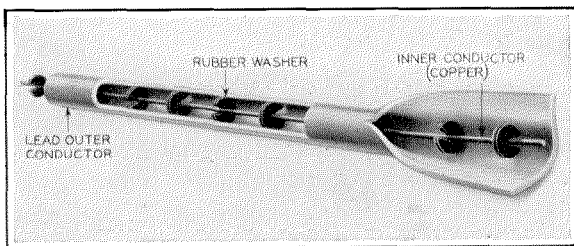

Figure 5—Coaxial Structure with Lead Outer Conductor and Rubber Disk Insulators.

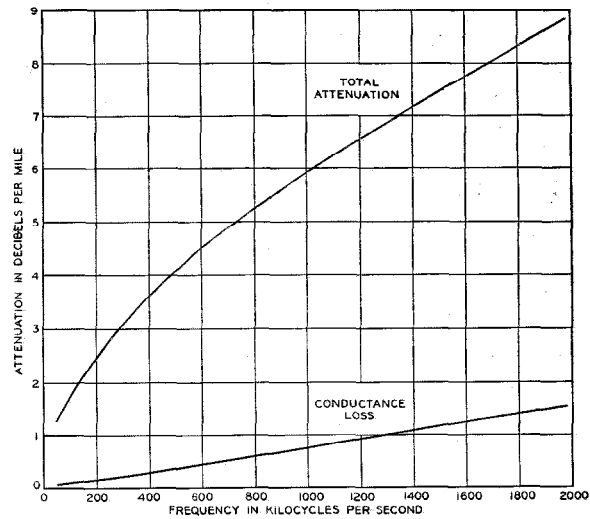

Figure 6—Attenuation of Small Flexible Coaxial Structure Shown in Figure 2.

commercial copper tubing into which the inner wire with its insulation is pulled. Although this form does not lend itself readily to a continuous manufacturing process, it may be advantageous in some cases.

#### Transmission Characteristics—Attenuation

At high frequencies the attenuation of the coaxial circuit is given closely by the well-known formula:

$$\alpha = \frac{R}{2} \sqrt{\frac{C}{L}} + \frac{G}{2} \sqrt{\frac{L}{C}} \quad (1)$$

where  $R$ ,  $L$ ,  $C$  and  $G$  are the four so-called "primary constants" of the line, namely, the resistance inductance capacitance and conductance per unit of length. The first term of equation (1) represents the losses in the conductors, while the second term represents those in the dielectric.

When the dielectric losses are small, the attenuation of a coaxial circuit increases, due to skin effect in the conductors, about in accordance with the square root of the frequency. With a fixed diameter ratio, the attenuation varies inversely with the diameter of the circuit. By combining these relations there are obtained the laws of variation of band width in accordance with the repeater spacing and the size of circuit, as stated previously.

The attenuation-frequency characteristic of



the flexible structure illustrated in Fig 2, with about 0.3-inch diameter, is given in Fig. 6. The figure shows also that the conductance loss due to the insulation is a small part of the total.

It is interesting to compare the curves of the transmission characteristics of the coaxial circuit with those of other types of circuits. Fig. 7 shows the high-frequency attenuation of two sizes of coaxial circuit using copper tube outer conductors, of 0.3-inch and 2.5-inch inner diameter, and that of cable and open wire pairs in the same frequency range.

#### Effect of Eccentricity

The small effect of lack of perfect coaxiality upon the attenuation of a coaxial circuit is illustrated by the curve of Fig. 8, which shows attenuation ratios plotted as a function of eccentricity, assuming a fixed ratio of conductor diameters and substantially air insulation.

#### Temperature Coefficient

With a coaxial circuit, as with other types of circuits, the temperature coefficient of resistance decreases as the frequency is increased, due to the action of skin effect, and approaches a value of

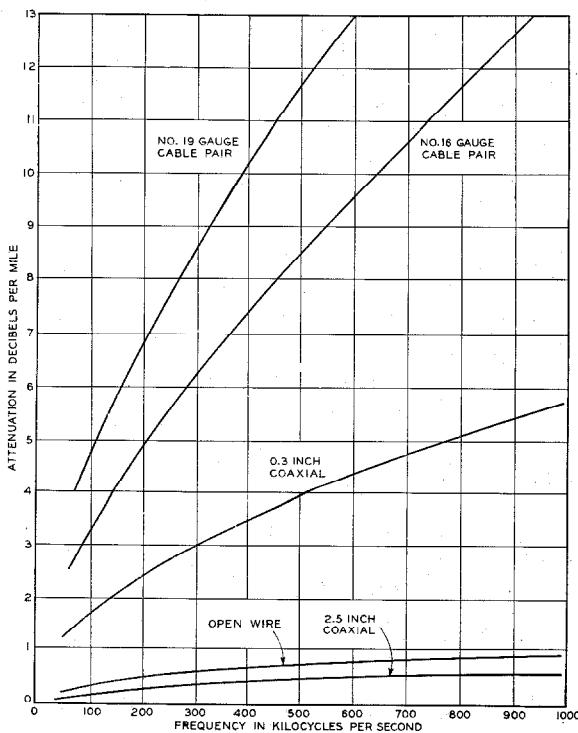

Figure 7—Attenuation Frequency Characteristics of Coaxial and Other Circuits.

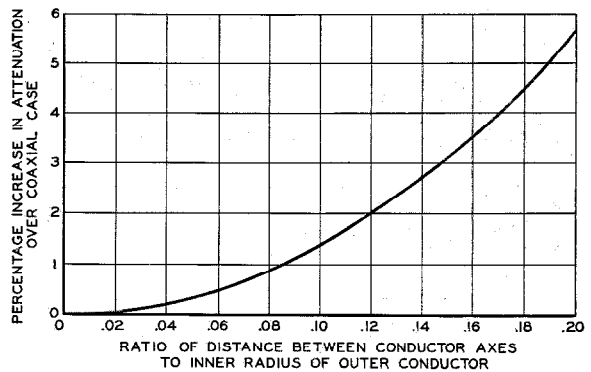

Figure 8—Increase in Attenuation of Coaxial Circuit Due to Eccentricity.

one-half the d-c. temperature coefficient.<sup>12</sup> Thus, for conductors of copper, the a-c. coefficient at high frequencies is approximately 0.002 per degree centigrade. When the dielectric losses are small, the temperature coefficient of attenuation at high frequencies is the same as the temperature coefficient of resistance.

#### Diameter Ratio

An interesting condition exists with regard to the relative sizes of the two conductors. For a given size of outer conductor there is a unique ratio of inner diameter of outer conductor to outer diameter of inner conductor which gives a minimum attenuation. At high frequencies, this optimum ratio of diameters (or radii) is practically independent of frequency. When the conductivity is the same for both conductors, and either the dielectric losses are small or the insulation is distributed so that the dielectric flux follows radial lines, the value of the optimum diameter ratio is approximately 3.6. When the outer and inner conductors do not have the same conductivity, the optimum diameter ratio differs from this value. For a lead outer conductor and copper inner conductor, for example, the ratio should be about 5.3.

#### Stranding

Inasmuch as the resistance of the inner conductor contributes a large part of the high frequency attenuation of a coaxial circuit, it is natural to consider the possibility of reducing this resistance by employing a conductor composed of insulated strands suitably twisted or interwoven.<sup>13</sup> Experiments along this line showed that this method is impractical at frequencies

above about 500 kc., owing to the fineness of stranding required.

### Characteristic Impedance

The high-frequency characteristic impedance of a coaxial circuit varies inversely with the square root of the effective dielectric constant, i.e., the ratio of the actual capacitance to the capacitance that would be obtained with air insulation. The impedance of a circuit having a given dielectric constant depends merely upon the ratio of conductor diameters and not upon the absolute dimensions. For a diameter ratio of 3.6, the impedance of a coaxial circuit with gaseous dielectric is about 75 ohms.

### Velocity of Propagation

For a coaxial circuit with substantially gaseous insulation, the velocity of propagation at high frequencies approaches the speed of light. Hence the circuit is capable of providing high velocity telephone channels with their well-recognized advantages. The fact that the velocity at high frequencies is substantially constant minimizes the correction required to bring the delay distortion within the limits required for a high quality television band.

### Shielding and Crosstalk

The shielding effect of the outer conductor of a coaxial circuit is illustrated in Fig. 9, where the transfer impedance between the outer and inner surfaces of the outer conductor is plotted as a function of frequency. There will be observed the sharp decrease in inductive susceptibility as the

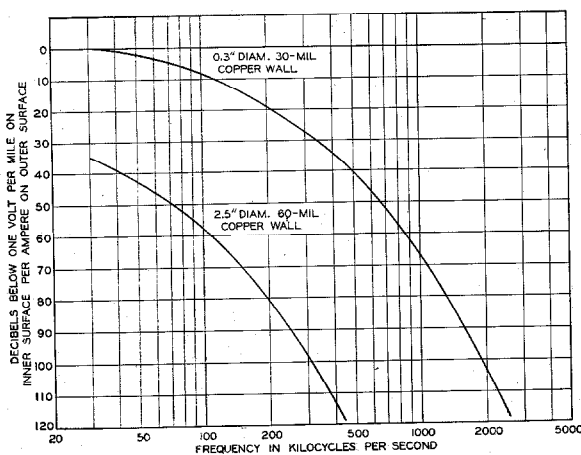

Figure 9—Shielding in a Coaxial Circuit.

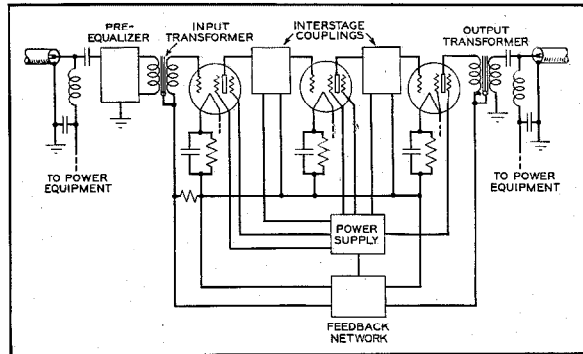

Figure 10—Circuit of 1,000-kc. 3-Stage Feedback Repeater.

frequency rises. On this account, the crosstalk between adjacent coaxial circuits falls off very rapidly with increasing frequency. The trend is, therefore, markedly different from that for ordinary nonshielded circuits which rely upon balance to limit the inductive coupling. As a practical matter, less shielding is ordinarily required to avoid crosstalk than to avoid external interference.

With suitable design the shielding effect of the outer conductor renders the coaxial circuit substantially immune to external interference at frequencies above the lower end of the spectrum. Hence the signals transmitted over the circuit may be permitted to drop down to a level determined largely by the noise due to thermal agitation of electricity in the conductors and tube noise in the associated amplifiers. It appears uneconomical to make the outer conductor sufficiently thick to provide adequate shielding for the very low frequencies. Also it seems impractical to design the repeaters to transmit very low frequencies. Hence the best system design appears to be one in which the lowest 5 or 10 per cent. of the frequency range is not used for signal transmission. The coaxial circuit is, however, well suited to the transmission of 60-cycle current for operating the repeaters, a matter which will be referred to later.

### Broad-Band Amplifiers

In order to realize the full advantage of broad band transmission, the repeater for this type of system should be capable of amplifying the entire frequency band *en bloc*. Furthermore, it should be so stable and free from distortion that

a large number of repeaters may be operated in tandem. Although high-gain radio frequency amplifiers are in every-day use, these are generally arranged to amplify at any one time only a relatively narrow band of frequencies, a variable tuning device being provided so that the amplification may be obtained at any point in a fairly wide frequency range. The high gain is usually obtained by presenting a high impedance to the input circuits of the various tubes through tuning the input and interstage coupling circuits to approximate anti-resonance.

In amplifying a broad band of frequencies, it is difficult to maintain a very high impedance facing the grid circuits. The inherent capacitances between the tube elements and in the mounting result in a rather low impedance shunt which cannot be resonated over the desired frequency band. It is, therefore, necessary to use relatively low impedance coupling circuits and to obtain as high gain as possible from the tubes themselves. The amount of gain which can be obtained without regeneration depends, of course, upon the type of tube, the number of amplification stages, the band width, and also upon the ratio of highest to lowest frequency transmitted.

#### *Repeater Gain*

The total net gain desired in a line amplifier is such as to raise the level of an incoming signal from its minimum permissible value, which is limited by interference, up to the maximum value which the amplifier can handle.

As pointed out above, the noise in a well shielded system is that due to resistance noise in the line conductors and tube noise in the amplifiers. In some of the repeaters which have been built, the amplifier noise has been kept down to about 2 db. above resistance noise, corresponding to about  $7 \times 10^{-17}$  watt per voice channel. In a long line with many repeaters the noise voltages add at random, or in other words, the noise powers add directly. Assuming, for example, a line with 200 repeaters, the noise power at the far end would be 200 times that for a single repeater section. In general, the line and amplifier noise will not be objectionable in a long telephone channel if the speech sideband level at any amplifier input is not permitted to drop more than about 55 db. below the level of the voice frequency band at the transmitting toll switchboard.

The determination of the volume which a tube can handle in transmitting a wide band of frequencies involves a knowledge of the distribution in time and frequency of the signaling energy and of the requirements as to distortion of the various components of the signal. The distribution of the energy in telephone signals has been the subject of much study. This distribution is known to vary over very wide limits, depending upon the voice of the talker and many other factors. It is, therefore, obvious that the problem of summing up the energy of some hundreds of simultaneous telephone conversations is a difficult one. Enough work has been done, however, to indicate fairly well what the result of such addition will be.

As to distortion in telephone transmission, the most serious problem has been to limit the intermodulation between various signals which are transmitted simultaneously through the repeater and appear as noise in the telephone channel. The requirement for such noise is similar to that for line and tube noise, and similarly it will add up in successive repeater sections for a long line. With present types of tubes operating with a moderate plate potential, the modulation requirement can be met only at relatively low output levels. To improve this situation and also to obtain advantages in amplifier stability, the reversed feedback principle employed for cable carrier amplifiers, as described in a paper by H. S. Black,<sup>14</sup> has been extended to higher frequency ranges. It has been found that amplifiers of this type having 30-db. feedback reduce the distortion to such an extent that each amplifier of a long system carrying several hundred telephone channels will handle satisfactorily a channel

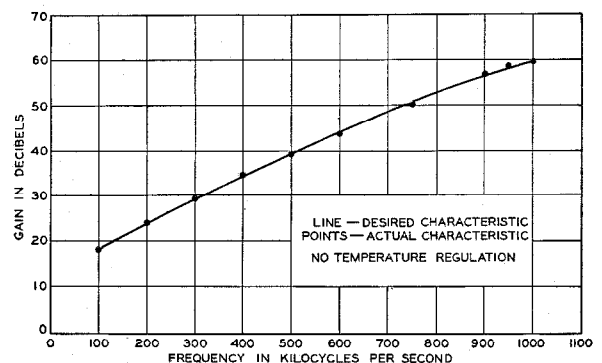

Figure 11—Gain of 1,000-kc. Repeater.

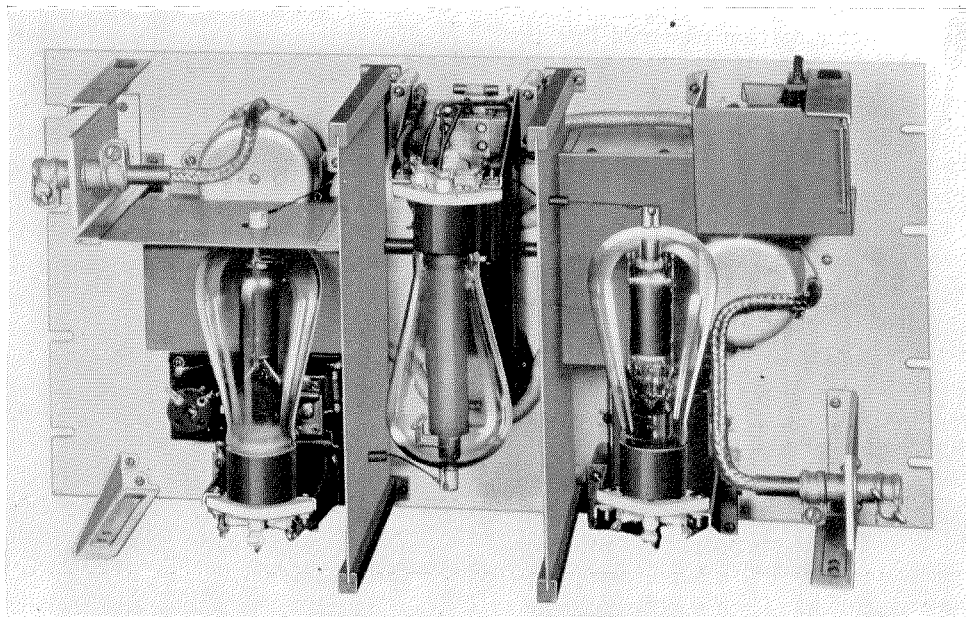

Figure 12—1,000-kc. Repeater.

output signal level about 5 db. above that at the input of the toll line.

The maximum gain which can be used in the repeater, therefore, is, in the illustrative case given above of a long system carrying several hundred telephone channels, the difference between the minimum and maximum levels of 55 db. below and 5 db. above the point of reference, respectively, or a total gain of 60 db. (With a 0.3-inch coaxial line of the type shown in Fig. 2, this corresponds to a repeater spacing of about 10 miles.) If a repeater is to have 60-db. net gain and at the same time about 30-db. feedback, it is obvious that the total forward gain through the amplifying stages must be about 90 db. The circuit of an experimental amplifier meeting the gain requirements for a frequency band from 50 to 1,000 kc. is shown schematically in Fig. 10.

#### *Gain-Frequency Characteristic*

As pointed out above, the line attenuation is not uniform with frequency. For a repeater section which has a loss of, say, 60 db. at 1,000 kc., the loss at 50 kc. would be only about 15 db. Such a sloping characteristic can be taken care of

either by designing the repeater to have an equivalent slope in its gain-frequency characteristic or by designing it for constant gain and supplementing it with an equalizer which gives the desired over-all characteristic. Both methods have been tried out, as well as intermediate ones. In Fig. 11 is illustrated such a sloping characteristic obtained by adjusting the coupling impedances in a 3-tube repeater, designed in this case for 60-db. gain at 1,000 kc. Fig. 12 gives an idea of the apparatus required in such a repeater, apart from the power supply equipment.

#### *Regulation for Temperature Changes*

It is necessary that the repeater provide compensation for variations in the line attenuation due to changes of temperature. In the case of aerial construction such variations might amount to as much as 8 per cent. in a day or 16 per cent. in a year. If the line is underground the annual variation is only about one-third of the above value and the changes occur much more slowly. On a transcontinental line the annual variation might total about 1,500 db. Inasmuch as it is desirable to hold the transmission on a long circuit constant within about  $\pm 2$  db., it is

obvious that the regulation problem is an important one.

In a single repeater section of aerial line the variation might amount to  $\pm 2.5$  db. per day or  $\pm 5$  db. per year. Such variations, if allowed to accumulate over several repeater sections, will drop the signal down into the noise or raise it so as to overload the tubes. It is, therefore, advisable to provide some regulation at every repeater in an aerial line so as to maintain the transmission levels at approximately their correct position. For underground installations the regulating mechanism may be omitted on two out of every three repeaters.

In choosing a type of regulator system the necessity for avoiding cumulative errors in the large number of repeater sections has been borne in mind. In view of the wide band available, a pilot channel regulator system was naturally suggested. Such a scheme employing two pilot frequencies has been used experimentally to adjust the gain characteristic in such a way as to maintain the desired levels throughout the band. The accuracy with which this has been accomplished for a single repeater section is illustrated in Fig. 13. Over the entire band of frequencies and the extreme ranges in temperature which may be encountered, the desired regulation is obtained within a few tenths of a decibel.

#### *Repeater Operation, Power Supply, Housing, Etc.*

In view of the large number of repeaters required in a broad-band transmission system it is essential that the repeater stations be simple and involve a minimum of maintenance. With the repeater design as described it is expected that most of the repeaters may be operated on an unattended basis, requiring maintenance visits at infrequent intervals.

An important factor in this connection is the possibility of supplying current to unattended repeaters over the transmission line itself. The coaxial line is well adapted to transmit 60-cycle current to repeaters without extreme losses and without hazard. The repeaters with regulating arrangements as built experimentally for a 1,000-kc. system are designed to use 60-cycle current, which in this case appears to have the usual advantages over d-c. supply. One repeater requires a supply of about 150 watts. The num-

ber of repeaters which can be supplied with current transmitted over the line from any one point depends upon the voltage limitation which may be imposed on the circuit from considerations of safety.

For a repeater of the type described with current supplied over the line, only a very modest housing arrangement will be required. For the great majority of stations, it appears possible to accommodate the repeaters in weather-proof containers mounted on poles, in small huts, or in manholes.

#### *Higher Frequency Repeaters*

Most of what has been said above applies particularly to repeaters transmitting frequencies up to about 1,000 kc. However, study has been given also to repeaters, both of the feedback and the nonfeedback types, for transmitting higher frequencies. Experimental repeaters covering the range from 500 to 5,000 kc. have been built and tested. These were capable of handling simultaneously the full complement of over 1,000 channels which such a broad band will permit. The frequency characteristic of one of these repeaters, and the measured attenuation of a section of line of the type tested at Phoenixville, are shown in Fig. 14.

#### *Terminal Arrangements*

In order to utilize a broad band effectively for telephone purposes, the speech channels must be placed as close together in frequency as practicable. The factors which limit this spacing are: (1) The width of speech band to be transmitted; and (2) the sharpness of available selecting networks.

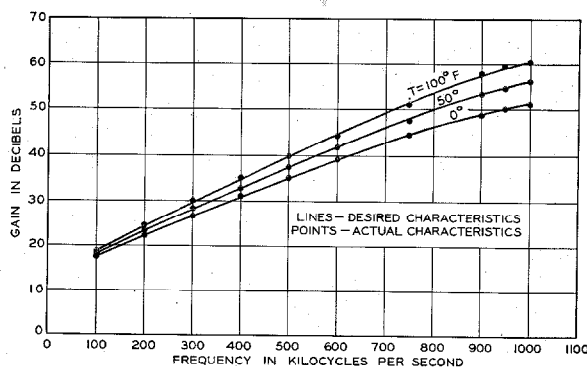

Figure 13—Temperature Regulation—Line and Repeater Characteristics.

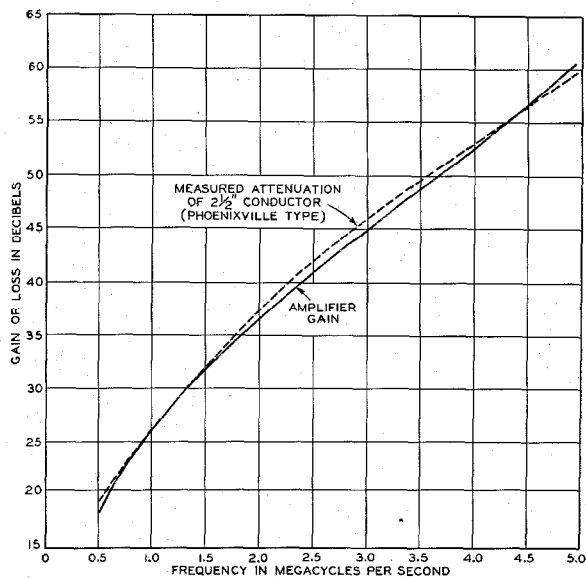

Figure 14—Frequency Characteristic of Coaxial Line and 5,000-kc. Repeater.

As to the width of speech band, the present requirement for commercial telephone circuits is an effective transmission band width of at least 2,500 cycles, extending from 250 to 2,750 cycles. It has been found that a band of this width or more may be obtained with channels spaced at 4,000-cycle intervals. Band filters using ordinary electrical elements are available,<sup>3</sup> for selecting such channels in the range from zero to about 50 kc. Channel selecting filters using quartz crystal elements<sup>15,16</sup> have been developed in the range from about 30 to 500 kc. The selectivity of a typical filter employing quartz crystal elements is shown on Fig. 15.

#### Initial Step of Modulation

The initial modulation (from the voice range) may be carried out in an ordinary vacuum tube modulator or one of a number of other non-linear devices. The method chosen for the present experimental work employs a single sideband with suppressed carrier, using a copper oxide modulator associated with a quartz crystal channel filter. The terminal apparatus required for 2-way transmission over a 2-path circuit is shown diagrammatically on the left-hand side of Fig. 16.

A frequency allocation which has been used for experimental purposes employs carriers from 64 to 108 kc. for the initial step of modulation. The lower sidebands are selected and placed side by

side in the range from 60 to 108 kc., as illustrated in Fig. 17, forming a group of twelve channels.

#### Double Modulation

In order to extend the frequency range of a system to accommodate a very large number of channels, it appears to be more economical to add a second step of modulation rather than carry the individual channel modulation up to higher frequencies. Such a second step of modulation has been used experimentally to translate the initial group of twelve channels *en bloc* from the range 60 to 108 kc. up to higher frequencies. It is possible to place such groups of channels one above another as illustrated in the upper part of the diagram of Fig. 18, up to about 1,000 kc., wasting no frequency space between groups and thus keeping the channels spaced at intervals of 4 kc. throughout the entire range.

The apparatus required for this purpose is shown schematically in Fig. 16, which illustrates the complete terminal arrangements for a single channel employing double modulation. The figure indicates by dotted lines where the other channels and groups of channels are connected to the system.

A modulator for shifting the frequency position of a group of channels inherently yields many different modulation products as a result of the intermodulation of the single frequencies

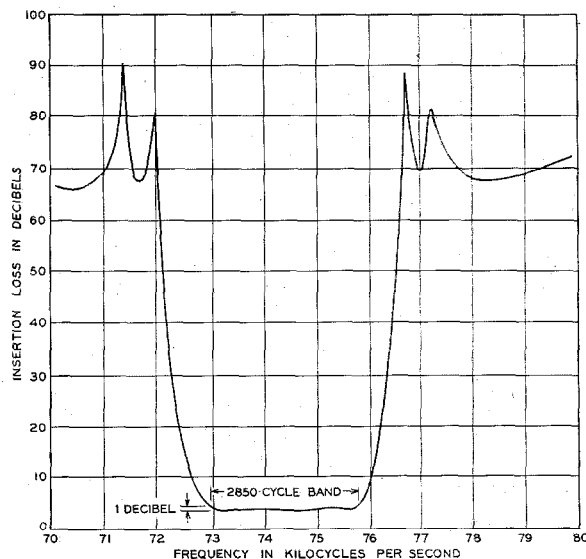

Figure 15—Frequency Characteristic of Quartz Crystal Channel Band Filter.

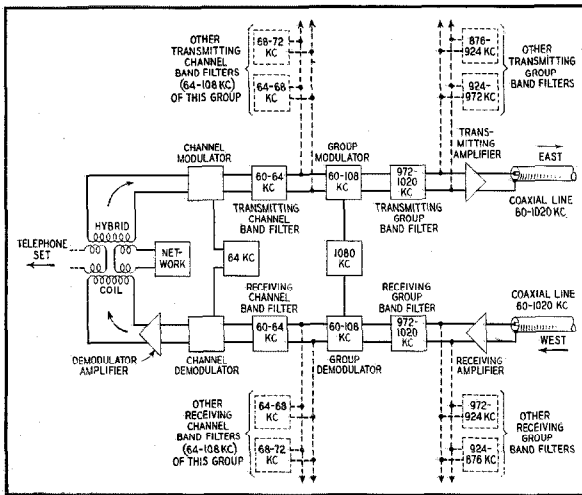

Figure 16—Schematic of 4-Wire Circuit Employing Two Steps of Modulation.

with the carrier frequency and with one another. Out of these products only the “group side-band” is desired. The number of the modulation products resulting merely from the lower ordered terms of the modulator response characteristic is extremely large. All such products must be considered from the standpoint of interference either with the group which is wanted in the output or with other groups to be transmitted over the system. Various expedients may be used to avoid interference as follows: (1) A proper choice of frequency allocation will place the undesired modulation products in the least objectionable location with respect to the wanted signal bands; (2) a high ratio of carrier to signal will minimize all products involving only the signal frequencies; (3) the use of a balanced modulator will materially reduce all products involving the second order of the signal; and (4) selectivity in the group filters will tend to eliminate all products removed some distance from the wanted signal group. Giving due regard to these factors, balanced vacuum tube group modulators have been developed which are satisfactory for the frequency allocations employed.

*Triple Modulation*

For systems involving frequencies higher than about 1,000 kc. it may be desirable to introduce a third step of modulation. In some experiments along this line a “super-group” of 60 channels, or five 12-channel groups, has been chosen. The lower part of Fig. 18 illustrates, for a triple

modulation system, the shifting of super-groups of 60 channels each to the line frequency position. This method has been employed experimentally up to about 5,000 kc. It is of interest to note that even in extending these systems to such high frequencies, channels are placed side by side at intervals of 4,000 cycles to form a practically continuous useful band for transmission over the line.

*Demodulation*

On the receiving side the modulation process is reversed. The apparatus units are similar to those used on the transmitting side, and are similarly arranged. This is illustrated in Fig. 16 for the case of double modulation.

*Carrier Frequency Supply*

In systems operating at higher frequencies it is necessary that the carrier frequencies be maintained within a few cycles of their theoretical position in order to avoid beat tones or distortion of the speech band. Separate oscillators of high stability could, of course, be used for the carrier supply but it appears more economical to provide carriers by means of harmonic generation from a fundamental basic frequency. Such a base frequency may be transmitted from one end of the circuit to the other, or may be supplied separately at each end.

*Television*

The broad band made available by the line and repeaters may be used for the transmission of signals for high quality television. Such signals

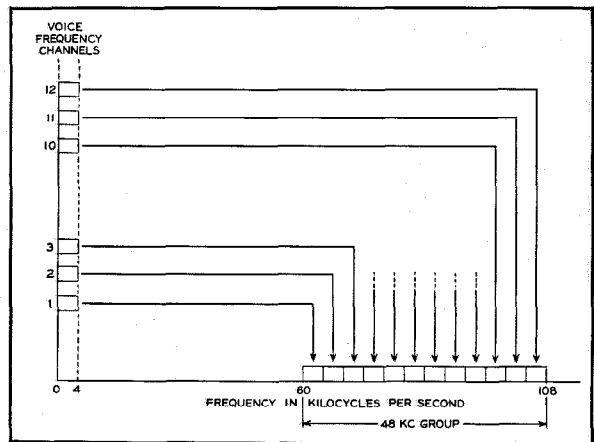

Figure 17—Diagram Illustrating Frequency Allocation for First Step of Modulation.

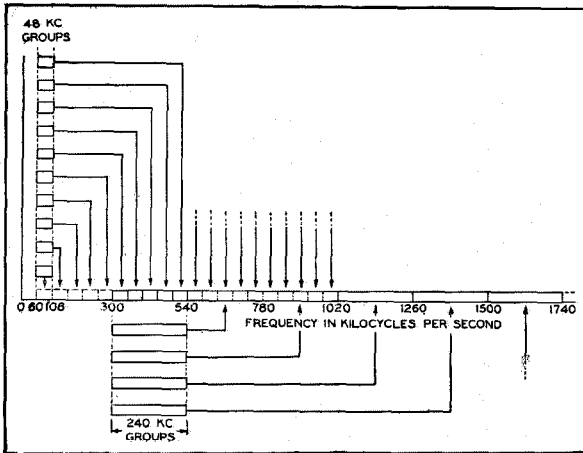

Figure 18—Diagram Illustrating Frequency Allocation for Two or Three Steps of Modulation.

may contain frequency components extending over the entire range from zero or a very low frequency up to 1,000,000 or more cycles.<sup>4</sup> The amplifying and transmitting of these frequencies, particularly the lower ones, presents a serious problem. The difficulty can be overcome by translating the entire band upward in frequency to a range which can be satisfactorily transmitted. To effect such a shift, the television band may first be modulated up to a position considerably higher than its highest frequency and then with a second step of modulation be stepped down to the position desired for line transmission.

This method is illustrated in Fig. 19 for a 500-kc. television signal band. The original television signal is first modulated with a relatively high frequency, 2,000 kc. in this case ( $C_1$ ). The lower sideband, extending to 1,500 kc., is selected and is modulated again with a frequency of 2,100 kc. ( $C_2$ ). The lower sideband of 100 to 600 kc. is selected with a special filter so designed that the low frequency end is accurately reproduced. The television signal then occupies the frequency range of 100 to 600 kc. as shown on the diagram and may be transmitted over a coaxial or other high frequency line. At the receiving end a reverse process is employed. The same method using correspondingly higher frequencies may be used for wider bands of television signals.

#### Other Communication Facilities

The telephone channels provided by the system may be used for other types of communication services, such as multi-channel telegraph,

teletype, picture transmission, etc. For the transmission of a high quality musical program, which requires a wider band than does commercial telephony, two or more adjacent telephone channels may be merged. The adaptability of the broad-band system to different types of transmission thus will be evident.

#### Conclusion

As already noted, the commercial application of these systems for wide band transmission over coaxial lines must await a demand for large groups of communication facilities or for television. The results which have been outlined are based upon development work in the laboratory and the field, and it is probable that the systems when used commercially will differ considerably from the arrangements described.

#### References

1. "Carrier Current Telephony and Telegraphy," by E. H. Colpitts and O. B. Blackwell. *A.I.E.E. Trans.*, v. 40, 1921, p. 205-300.
2. "Carrier Systems on Long Distance Telephone Lines," by H. A. Affel, C. S. Demarest, and C. W. Green. *A.I.E.E. Trans.*, v. 47, 1928, 1360-7; *Bell System Tech. Jl.*, v. 7, 1928, p. 564-629.
3. "Communication by Carrier in Cable," by A. B. Clark and B. W. Kendall, *Elec. Engg.*, v. 52, 1933, p. 477-81; *Bell System Tech. Jl.*, v. 12, 1933, p. 251-63.
4. "Theory of Scanning and Its Relation to the Characteristics of the Transmitted Signal in Telephotography and Television," by P. Mertz and F. Gray. *Bell System Tech. Jl.*, v. 13, 1934, p. 464.

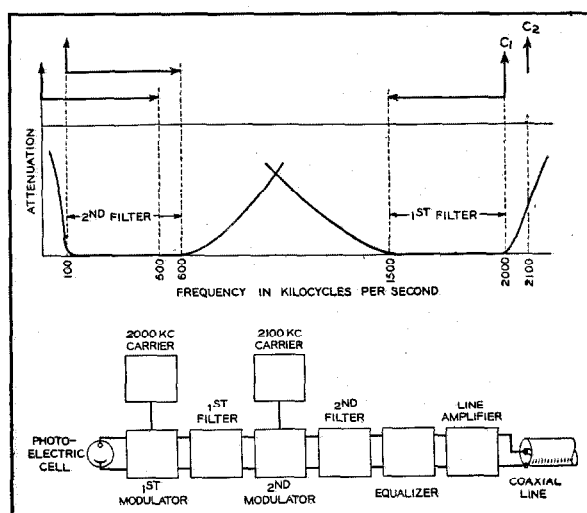

Figure 19—Double Modulation Method of Translating Television Signals for Wire Line Transmission.



5. "A Study of Television Image Characteristics," by E. W. Engstrom. *I.R.E. Proc.*, v. 21, 1933, p. 1631-51.
6. "The Electromagnetic Theory of Cylindrical Transmission Lines and Cylindrical Shields," by S. A. Schelkunoff. *Bell System Tech. Jl.*, v. 13, 1934.
7. "Transmission Characteristics of the Submarine Cable," by J. R. Carson and J. J. Gilbert. *Frank. Inst. Jl.*, v. 192, 1921, p. 705-35.
8. "The Key West-Havana Submarine Telephone Cable System," by W. H. Martin, G. A. Anderegg and B. W. Kendall. *A.I.E.E. Trans.*, v. 41, 1922, p. 1-19.
9. "British Patent No. 284,005," by C. S. Franklin, January 17, 1928.
10. "Transmission Lines for Short-Wave Radio Systems," by E. J. Sterba and C. B. Feldman. *I.R.E. Proc.*, v. 20, 1932, p. 1163-202; also *Bell System Tech. Jl.*, v. 11, 1932, p. 411-50.
11. "U. S. Patents No. 1,835,031," by L. Espenschied and H. A. Affel, Dec. 9, 1931, and "No. 1,941,116," by M. E. Strieby, Dec. 26, 1933.
12. "Transmission Characteristics of Open-Wire Lines at Carrier Frequencies," by E. I. Green. *A.I.E.E. Trans.*, v. 49, 1930, p. 1524-35; *Bell System Tech. Jl.*, v. 9, 1930, p. 730-59.
13. "U. S. Patent No. 1,818,027," by H. A. Affel and E. I. Green, Aug. 11, 1931.
14. "Stabilized Feed-Back Amplifiers," by H. S. Black. *Elec. Engg.*, v. 53, 1934, p. 114-20.
15. "U. S. Patent No. 1,795,204," by L. Espenschied, March 3, 1931.
16. "Electrical Wave Filters Employing Quartz Crystals as Elements," by W. P. Mason. *Bell System Tech. Jl.*, v. 13, 1934, p. 405.

# A New Type of Telephone Kiosk in Norway

By M. L. KRISTIENSEN

*Telephone Director, Oslo Telefonanlegg, Oslo*

**D**UE to the varying climatic conditions in Norway, designing a suitable telephone kiosk for outdoor use has been a rather difficult problem. The Oslo Telefonanlegg (Oslo Telephone Service) therefore initiated a competition for the design and construction of a modern telephone kiosk and more than one hundred of the country's architects competed.

The conditions laid down were that the kiosk should be suitable for all parts of the country. The main features of the design adopted are shown in the accompanying photographic reproduction. The door is arranged so that ice and snow will not obstruct its opening and closing. The upper part of the kiosk has wire-glass panes in order to make possible inspection from all directions outside. It is expected that this feature will help to induce longwinded users to shorten their conversation, when others are waiting.

The lower part is protected by a horizontal metallic grill, but is otherwise open to the air. Experience has shown that, with the lower part completely enclosed, dirt, snow or ice accumulates, sometimes impeding opening and closing of the door and requiring constant cleaning.

A further requirement was that the kiosk should not have its coat of paint renewed or repaired "in situ," because it would be difficult to avoid spoiling the clothes of users or passers-by. When the paint is to be renewed, the kiosk is lifted off its foundation and is taken by a motor lorry to the workshops, where it is spray painted.

In order to make pilfering or robbery difficult, a rather complete system of alarms and signals is provided. If such an attempt is made, concealed contacts close an alarm circuit and a battery-operated horn of the autocar type at the kiosk gives an audible alarm, which can be heard by patrolling police or passers-by. An audible and visual alarm signal is at the same time given at the central office.

The kiosk is provided with electric light inside, the light shining through to display as an illuminated sign the word "TELEPHONE" on all sides. The wires for telephone, signals, and electric light are drawn into solid steel conduit, thus

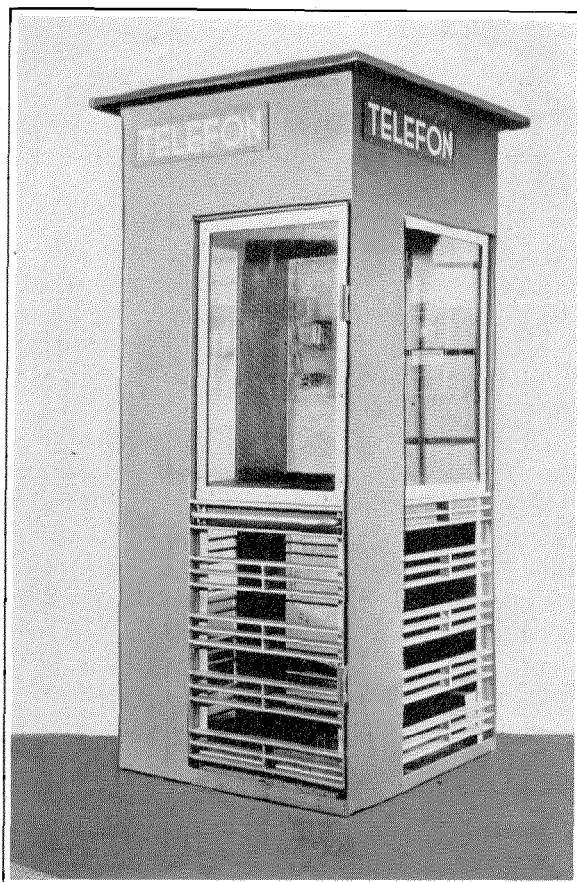

being completely protected against interference.

The kiosk is built upon a structure of angle iron, the sides are made of sheet iron and wire-glass, and the roof of copper plates. The colour is Post Office red. Window frames and the horizontal bars in the sides are silver coloured. The foundation is reinforced concrete, with solid bolts and nuts of brass to facilitate removal of the kiosk for repair or painting. The dimensions are: free height inside 2 metres; inside horizontal dimensions 90 by 90 centimetres. A shelf is arranged for writing notes and for placing parcels, etc., when using the telephone. The kiosk will not be used for advertisements.

A number of these kiosks are already erected in Oslo and seem to be very popular both with the public and the municipal authorities.

# Rediffusion and Teleprogramme Systems

By A. R. A. RENDALL, B.Sc., A.M.I.E.E.

*Standard Telephones and Cables, Limited*

and

S. VAN MIERLO

*Central Laboratories*

"REDIFFUSION" designates a system whereby a radio broadcast programme is received, amplified, and distributed over an independent line network to a community of subscribers while "Teleprogramme" is the term used to describe the system which enables the telephone subscriber by means of a small amount of additional apparatus to receive the radio broadcast programmes over the ordinary telephone network.

While the ultimate aim of both systems is to reproduce the broadcast programme at the subscriber's premises with the maximum fidelity, the means whereby this is accomplished differ so much in each case that it has been considered desirable in this paper to deal with each subject separately.

## *Rediffusion Systems*

As mentioned above, rediffusion is the description applied to a system where a radio broadcast programme is received, amplified, and distributed over an independent line network to a community of subscribers. For convenience, the programme is usually received by radio although, where possible, direct reception from a studio has obvious advantages. The amplifier station delivers the programme energy at such a level that the subscriber has merely to bridge his loudspeaker across the feeder to receive the programme at satisfactory volume. The attraction from the subscriber's standpoint is the extreme simplicity. The choice of programmes is necessarily restricted, as the provision of alternative programmes on rediffusion systems is expensive. Recent rediffusion systems offer a choice of four programmes and, in many localities, this is the greatest number of programmes that can be received reasonably free from interference.

The problem of design is to provide the required standard of quality at a minimum cost. At the outset it is essential to obtain a definition

of "power received by subscribers" which corresponds to the actual programme volume received by the subscriber and yet can be related to steady tone conditions to facilitate the design of the component parts of the system. If the instantaneous peak energy were taken as defining the power received, an exaggerated idea of the power required to drive the loudspeaker would be obtained. If the average power taken by the loudspeaker were considered, then no account would be taken of the overloading of the amplifiers by peaks in the modulated voltage wave.

Although it is possible to formulate definitions which correspond more closely to the conditions, the most satisfactory way is to define "power received" in terms of amplifier ratings. Suppose an amplifier has a vacuum tube in its final stage which is rated at 50 milliwatts, that is to say, the final tube will give an output of 50 milliwatts of sinusoidal power with a given harmonic content (usually 5% on a voltage basis). Let the output vacuum tube be connected to the loudspeaker through a transformer of suitable ratio. If the loudspeaker is of the moving coil type the impedance frequency characteristic of the load is sufficiently uniform to be able to decide the impedance ratio, but if the speaker is of the moving iron type then the matching for best response is obtained by compromise. With a cone type loudspeaker, the vacuum tube and speaker impedance are usually matched at about 400 p.s. If the amplifier is then made to drive the loudspeaker, there will be a fairly well defined maximum volume obtainable before non-linear distortion is noticeable. It can be said that this volume corresponds to 50 milliwatts, meaning that it is the maximum volume obtainable without noticeable distortion from a vacuum tube rated at 50 milliwatts. Although the example given is in terms of 50 milliwatts, any power can be defined in the same way. The actual single frequency voltages which will be impressed across the loudspeaker by an amplifier of a given power rating can now

be determined for the whole frequency range, and can be made the standard of reference both from the point of view of the "power received" and frequency distortion. If a line network is interposed between the amplifier and loudspeaker, any resultant loss or distortion may be defined as "insertion loss" and "insertion distortion," and these quantities may be determined by single frequency measurements. To return to the above example, suppose a single frequency tone at 800 p/s were impressed on the input of the amplifier, and a voltage  $V_{(800)1}$  were delivered to the loudspeaker if directly connected to the amplifier output. If a network is now interposed between the amplifier output and the loudspeaker with the result that the voltage across the loudspeaker is reduced to  $V_{(800)2}$ , then the "insertion loss" in decibels is  $20 \log_{10} \frac{V_{(800)1}}{V_{(800)2}}$ .

Similarly, suppose the single frequency tone is at some other frequency  $f$  and that  $V_{(f)1}$  is the voltage delivered to the loudspeaker at that frequency if directly connected to the amplifier, and let  $V_{(f)2}$  be the voltage delivered to the loudspeaker with the network interposed. If the frequency distortion is a comparison between the voltage at  $f$  and at 800 p/s, then

$\frac{V_{(f)1}}{V_{(800)1}}$  is the ratio with direct connection

$\frac{V_{(f)2}}{V_{(800)2}}$  is the ratio with the line interposed.

And the insertion distortion in db. =

$$20 \log_{10} \frac{V_{(f)1}}{V_{(800)1}} \times \frac{V_{(800)2}}{V_{(f)2}}$$

#### Standard of Volume and Quality

Many radio listeners work their sets with an output valve rated at 500 milliwatts or higher. The provision of such an amount of power to each subscriber on a rediffusion system would be exceedingly costly and most systems at present installed are based on 50–100 milliwatts per subscriber.

The standard of quality aimed at is again a question of cost. A satisfactory limit of distortion for average load condition is 5 db. over a frequency range of 100–5000 p/s, taking the above definition of distortion and 800 p/s as the ref-

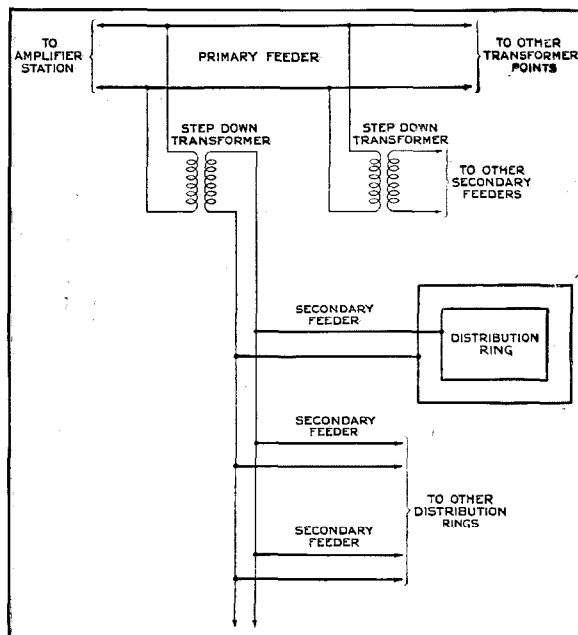

Figure 1—Rediffusion Feeder System—General Layout.

erence frequency. On very light loads the distortion at 5000 p/s may be as high as 10 db., due to the capacity of the distribution network.

Where alternative programmes are offered, a limit must be placed on the crosstalk between the circuits carrying the different programmes. There is no appreciable difference between the nominal levels of the circuits, but the instantaneous level difference can be as great as 40 db. An overall crosstalk requirement of 72 db. is satisfactory.

The system should be as free as possible from all noise due to external interference.

#### General Features of System

The receiver station should be located where the interference from power circuits is small. The amplifier station, normally, will be located as centrally as possible to reduce distribution costs. The receiver and amplifier stations should be interconnected by shielded cable. If these precautions are taken, the noise on the system due to external interference will be small since the programme level on the feeder system itself is sufficiently high to prevent noise picked up by the feeders from disturbing the programme reception.

Fig. 1 shows the general layout of a rediffusion feeder system, and it will be seen that it follows

quite closely the lines of a lighting network. The area is divided into districts which are fed by primary feeders. The subscribers are bridged across distribution rings. As the subscriber load consists of a large number of loudspeakers in parallel, the load impedance is very low and a reduction in transmission loss is obtained if a step-down transformer is interposed between the primary feeder and the load. If the primary feeder is very short then the saving may be so small that the expenditure on transformers is not warranted.

The actual method of running the feeders depends upon local conditions. The primary feeders should preferably be run underground in ducts, or as armoured cable directly in the ground. The secondary feeders and distribution rings may be run under the eaves of houses or again, in some cases, underground. The cost of the distribution system will vary considerably depending upon the method adopted and, since the distribution system and its installation are a very large item in the total cost, a study of the best layout is essential in every case.

#### *Design of System*

The requirements of the system having been fixed, the parts of the system must be designed to achieve the desired result with the maximum economy.

In order to strike an economic balance between the amplifier station and the cable network, two facts must be known: (1) the annual cost of programme power at the amplifier station, and (2) the variation in the annual cost of the feeder system for varying loss in the feeder system.

The first factor is fairly easy to determine in terms of standard types of amplifiers used for rediffusion purposes. The complex nature of the feeder system makes the determination of the second factor more difficult, but it is important that at least an approximate answer should be obtained. A detailed consideration will not be given here but the method of attack will be outlined.

In the first place, the feeder system must be designed so that for any given loss the expenditure is a minimum. The run of cable must be kept as short as possible and the different sections of the feeder system must be proportioned so that the copper is used to the greatest advantage. The

first requirement is met by observing the simple rule—never run two cables along a common route where one, with heavier conductors, will serve. The application of this rule will sometimes conflict with the requirements for maximum economy of copper, and there are therefore exceptions, but generally the saving made by reducing the total length of cable required is greater than the loss due to the reduction in copper efficiency. Manufacturing considerations limit the size of conductors in a telephone type of cable, to about 2.8 mm., and this restriction may demand the use of two cables in exceedingly large installations. Having fixed the run of the feeders, the relative conductor sizes in the branches are fixed, so that each subscriber will receive approximately the same power. It is important that the relative conductor sizes in the primary and secondary feeders, where transformers are employed, should be correct. The following simple relationship can be deduced:

if  $r_p$  = the resistance per unit length of the feeder on the primary side,

$r_s$  = the resistance per unit length of the feeder (or feeders in parallel) on the secondary side,

$$t = \frac{\text{primary turns on transformer}}{\text{secondary turns on transformer}}$$

then for maximum economy  $r_p = t \cdot r_s$

The method of handling the problem has been simplified by introducing the concept of "equivalent feeder." Where two feeders join, they are replaced by a single equivalent feeder which has the same total weight of copper as the two single feeders, and introduces the same effective resistance in the circuit as the feeders. When the "equivalent feeder" is transferred from the secondary side of the transformer to the primary, its equivalent length is multiplied by  $t$ . The whole feeder system is thereby reduced to a single equivalent feeder and, if a conductor size is assigned to this equivalent feeder, then the weight of copper in the whole system and the resistance introduced by the feeder system is immediately fixed. The cost of copper in the system is thus available in terms of a single variable and the variations in the cost of the amplifier power can be expressed in terms of the same variable. It is now a simple matter to determine that value of the variable which will give the minimum total annual charge for the whole

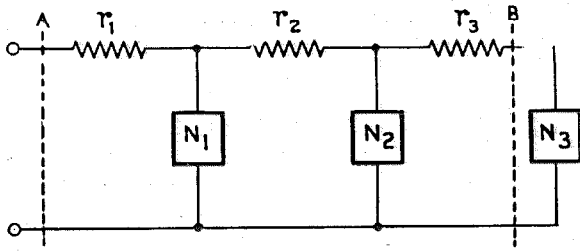

Figure 2.

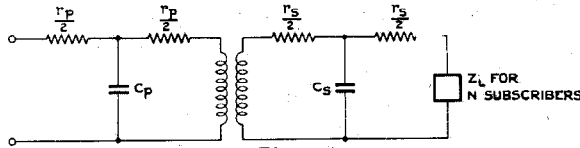

Figure 3.

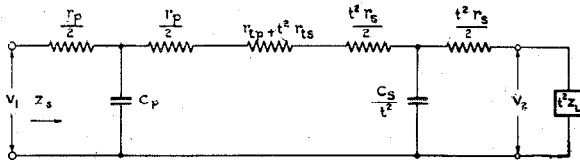

Figure 4.

found most useful in assigning the sizes to the main and branch feeders.

The precise amplifier requirements must now be calculated for the feeder system as finally designed. The determination is made at 800 p/s and the amplifier power decided on this basis. It is then necessary to check that the distortion is within the limits prescribed. At 800 p/s the resistance and capacity of the system only need be considered. As described earlier herein, the aim of the design is to supply each subscriber with the same amount of power. This means that the effective resistance drop due to the feeder should be the same for each subscriber. The voltage drop along the feeder can be assumed to be proportional to the number of subscribers served. This is not strictly true since the shunt capacity is not proportional to the number of subscribers.

Hence, in the system illustrated in Fig. 2, where  $N_1$ ,  $N_2$ ,  $N_3$  are groups of subscribers branched off at intervals, and  $r_1$ ,  $r_2$  and  $r_3$  are the resistances of the sections, the effective resistance introduced between A and B per subscriber of the group  $N_3$  is

$$r_t(N_1 + N_2 + N_3) + r_2(N_2 + N_3) + r_3N_3.$$

The system should be designed so that the value of this quantity for subscribers in the groups  $N_1$ ,  $N_2$  and  $N_3$  is substantially the same, and the total effective resistance for the whole load on that feeder becomes:

$$r_t = \frac{r_1(N_1 + N_2 + N_3) + r_2(N_2 + N_3) + r_3N_3}{N_1 + N_2 + N_3}$$

The quantity  $r_t$  is distributed between the primary and secondary feeders. For the purpose of this calculation the division of  $r_t$  between the two parts of the system is necessary, because the loss introduced by the resistance is dependent upon the distribution of capacity. The reactance of the shunt capacity is usually high compared with the series resistance, so that the disposition of the capacity with regard to the resistance is not critical. It is satisfactory to assume that the network Fig. 3 represents the cable network system, where  $r_p$  and  $r_s$  refer to the primary and secondary feeder effective resistances for  $N$  subscribers, respectively,  $C_p$  to the primary and  $C_s$  to the secondary capacities.

The secondary feeder impedances may be referred to the primary of the transformer by

system, amplifiers plus cable network. Although the value varies from one system to another, it may be of interest to note that the total resistance of the equivalent feeder, per subscriber of full load, was 7000 ohms in the case of one system and 4000 ohms in the case of another.

From the size of the equivalent feeder, the diameters of the actual feeders can be deduced by a reverse process. As a result of this calculation a whole range of conductor sizes is indicated, but practical considerations demand that the sizes should be restricted in number so that a reasonable length of any one size of cable can be ordered.

In addition, there are the limits of conductor size fixed by manufacturing reasons, that is, about 2.8 mm. conductors maximum and .5 mm. minimum. In a fairly large project the following sizes have been found convenient:

- 2.5 mm.
- 1.8 mm.
- 1.3 mm.
- .9 mm.
- .5 mm.

In a smaller project, the number of sizes might be advantageously reduced. The cross-sectional areas of adjacent sizes have been chosen in the ratio of 2:1, approximately, as these have been

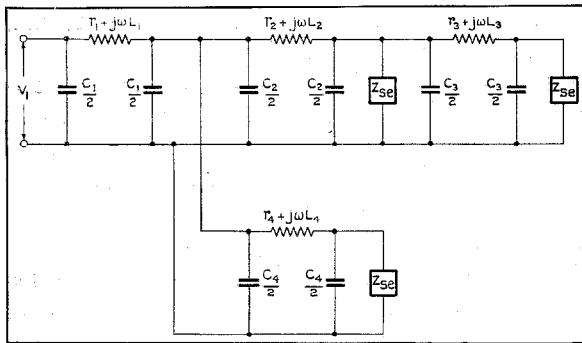

Figure 5.

multiplying them by the impedance ratio of the transformer. The effects of the leakage reactance and the mutual inductance of the transformer can be neglected at 800 p.s and its resistance only need be considered.

If this transformation is made, the circuit of Fig. 3 is replaced by that of Fig. 4 where  $r_{tp}$  = resistance of transformer primary,  $r_{ts}$  = resistance of transformer secondary,  $t$  = the turns-ratio of the transformer,  $V_1$  = sending end voltage and  $V_2$  = receiving end voltage.

The quantities desired to complete the calculation are the ratio  $\frac{V_1}{V_2}$  for the subscribers

located in the most unfavourable position and the value of the sending end impedance ( $Z_s$ ) for the whole system.

The value of  $\frac{V_1}{V_2}$  should not vary very much from feeder to feeder, and the worst case is usually apparent. The sending end impedance of the different feeders, however, can vary considerably due to the different values of total feeder capacity. This is particularly so in the case of certain load conditions. Very little labour is involved in making a separate determination of the sending end impedance for each feeder for different loads and, although in many cases it is not strictly necessary, it is the safer method.

Assume then that  $\frac{V_1}{V_2}$  and  $Z_s$  have been calculated for several load conditions. If  $P_2$  is the power to be supplied to the subscriber,  $V_2$ , in accordance with the definition given at the beginning of the paper, is the voltage which an amplifier rated at  $P_2$  watts would deliver to the

loudspeaker at the frequency under consideration, namely, 800 p.s.,  $V_1$  follows from  $V_2$ . The amplifier impedance  $R$  should bear a definite relation to  $Z_s$  in order to obtain the conditions for operating the amplifier with a minimum non-linear distortion.  $R$  should be about .4 to .5  $Z_s$ .

The internal e.m.f.(e) in the plate circuit of the amplifier must be  $V_1 \times \frac{Z_s + R}{Z_s}$ .

The power delivered by the amplifier when working into a pure resistance load equal to 2.5  $R$  is, therefore,

$$\frac{1}{2.5 R} \left( c \times \frac{2.5}{3.5} \right)^2.$$

As  $V_2$  is derived directly from  $P_2$  and the definition given, it follows that a loudspeaker connected at the end of the system will be energized to the same extent (except for distortion) as a loudspeaker directly connected to an amplifier, whose output rating is  $P_2$  watts. The amplifier power output to satisfy the 800 p.s condition is determined in this manner for several loads. It must now be ascertained whether this solution satisfies the distortion requirements.

The distortion at the lowest frequency (100 p.s) is easily determined since the line resistance and the shunt inductance of the transformer are the only factors which need be considered. The networks of Fig. 4 with the capacity omitted and the transformer shunt inductance added is quite satisfactory for determining this distortion. The distortion at the highest frequency (5000 p.s) is somewhat more complex.

The distributed inductance of the feeders has a very important effect. On the heavier gauges of conductors, the series reactance at 5000 p.s is greater than the resistance. The effects are most marked on very light load, when a single amplifier might be supplying the system. The impedance of the feeder system can drop to a very low value, due to the interaction of the distributed inductance and capacity, and although this effect may be accompanied by a rise in voltage along the feeder, other feeders which are connected in parallel can be heavily shunted. The problem can only be resolved by taking the line, section by section, and representing it as a network and evaluating by ordinary vectorial

computation the sending end impedance and the distribution of voltage. The secondary feeder system is very short electrically, and its impedance can be represented satisfactorily by a resistance in series with capacity. For the purpose of calculation, a feeder at 5000 p:s and light load will take the form of the network of Fig. 5, where  $r$ ,  $L$  and  $C$  are the constants of the line, and  $Z_{se}$  is the secondary impedance viewed through the transformer. In calculating  $Z_{se}$  the effect of the leakage inductance of the transformer must be included. From this calculation the ratio  $\frac{V_1}{V_2}$  and  $Z_{s(5000)}$  will be obtained. The ratio of  $\frac{V_1}{V_2}$  taken must be for the worst case, which is likely to be at a transformer point near the amplifier station. The sending end impedance at 800 p:s, ( $Z_{s(800)}$ ) for the light load condition can be deduced from the network of Fig. 4.

A limiting value for the ratio between  $V_{2(800)}$  and  $V_{2(5000)}$  is fixed by the distortion requirement; and, taking the definition of distortion given, this value  $\frac{V_{2(800)}}{V_{2(5000)}}$  can be immediately obtained. From this  $\frac{V_{1(800)}}{V_{1(5000)}}$  is obtained.

Now if  $R$  is the amplifier impedance for the light load condition and  $e$  the e.m.f.,

$$V_{1(800)} = e \frac{Z_{s(800)}}{Z_{s(800)} + R} \text{ and}$$

$$V_{1(5000)} = e \frac{Z_{s(5000)}}{Z_{s(5000)} + R}$$

$$\frac{Z_{s(800)}}{Z_{s(5000)}} \times \frac{Z_{s(5000)} + R}{Z_{s(800)} + R} = \frac{V_{1(800)}}{V_{1(5000)}}$$

The only unknown is  $R$ , which the equation will give. Hence, there is a certain value of  $R$  which cannot be exceeded without exceeding the distortion limit. The required e.m.f. can be determined from the equation for  $V_{1(800)}$  and hence the minimum amplifier power which will satisfy the distortion requirements is determined.

The voltage drop in the feeder at light load is less than at full load, and therefore the e.m.f. of the amplifier may be decreased for smaller loads. Taking advantage thereof, the output impedance of the amplifier may be reduced for

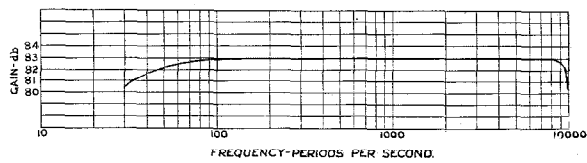

Figure 6—Gain Frequency Characteristic of 250 Watt Amplifier for Rediffusion Service.

light load conditions by tapping the output transformer. This feature very materially reduces the power required to meet a given distortion.

#### Amplifier Equipments

A detailed description of the equipment is not within the scope of this article, but it is hoped that a later contribution will deal with this important part of a rediffusion system.

If rediffusion systems are to compete successfully with receiving sets offered at continually reduced prices, it is essential that the quality of reproduction should be at least as good as that obtained from a first class receiving set, and the amplifiers described have been designed to give the same grade of quality as the amplifiers in the speech input equipment of a broadcasting station.

A comprehensive range of amplifiers is available to meet all the needs of the rediffusion service. This includes amplifiers with power outputs of 15, 30, 100 and 250 watts rated on the basis of 5% voltage harmonic. If 10% voltage harmonic is admitted, the output power is much increased, particularly in the case of the 250 watt amplifier, which will give 450 watts for 10% harmonic. These 100 and 250 watt amplifiers represent the latest development in rediffusion amplifiers intended for large schemes, where it is essential to keep the annual charges, per watt output, as low as possible. The gain frequency characteristic of the 250 watt amplifier is shown in Fig. 6. It will be seen that deviation of the gain within the frequency range 30–10,000 p:s is less than 3 db.

#### Operation of Amplifier Station

In rediffusion systems the maintenance of a high and uniform standard of quality is of first importance. A partial failure or periods of poor quality are likely to lead to unfavourable publicity which will seriously injure the prospects of the concern. On the other hand, operation and



maintenance must be cheap. The behaviour of the system must therefore be effectively and simply displayed to the attendant.

The two types of instrument required are a load indicator and a programme level indicator. The first indicates the number of subscribers listening on any particular programme, and the second the actual level of the programme.

#### *Load Indicator*

A device for measuring the load on a feeder is essential if the amplifier station is to be run economically. This is particularly true in a multi-programme system, where it would be expensive to provide sufficient amplifier power to carry the full load on each programme. The amplifiers must be switched in accordance with the number of subscribers listening on any one programme. In some systems the direct current resistance is measured to determine the load, but the method is inadmissible where transformers are used. The alternating current impedance is the quantity which can be taken quite generally to indicate the load.

The load indicator measures the ratio of the signal voltage to signal current in a selected frequency band, and thereby gives a continuous indication of the feeder impedance (or admittance), without disturbing the service at all. In modified forms the instrument will give an alarm for a prescribed change in load, or for an abnormal load such as a short circuit.

#### *Programme Level Indicator*

The programme level indicator is required to ensure that the level of the programme is adequate and not excessive, so that the amplifiers will be fully loaded but not overloaded. Three types of programme level indicating apparatus are available, the volume indicator, the peak power indicator, and the programme meter. The major difference between the first two is the integrating time, that is, the duration of a peak necessary to give an indication corresponding to the full amplitude of the peak voltage. The programme meter includes non-linear devices so that the indicating meter scale is divided uniformly in decibels.

The volume indicator is essentially a rectifier and meter; the damping of the meter and the calibration have been so chosen that the de-

flections of the meter indicate the programme level.

In one of the available instruments a vacuum tube rectifier is employed. Its input impedance is high so that it may be bridged directly across the circuit on which the level is to be observed. A milliammeter is connected in the plate circuit of the valve and the level is read directly on this meter but, in order to increase the range, keys are provided for changing the tap on the input transformer. The complete range of the instrument is  $-10$  to  $+40$  db. referred to an instantaneous peak power of 5 milliwatts. The movement of the needle of the meter is erratic but results can be repeated to an accuracy of  $\pm 2$  db. A second form of volume indicator is available which employs a copper oxide rectifier instead of a vacuum tube rectifier.

The peak power indicator is similar to that recommended by the C.C.I.F.<sup>1</sup> for measuring programme levels on broadcasting circuits. It has a pick-up time of 20 milliseconds and a falling-off time of 6 seconds. The scale is graduated in an approximately uniformly divided scale of volts, and the instrument reads a maximum of 6 volts i.m.s. The long falling-off time makes it much easier to read than the volume indicator.

The programme meter gives a direct reading on an approximately evenly divided scale of decibels from  $+5$  db. to  $-35$  db. relative to 4 volts. The pick-up and delay time of the instrument is not so important as its scale is very compressed. It is similar in its performance to the programme meter used by the British Broadcasting Corporation.

#### *Teleprogramme Systems*

In this system the radio broadcast programme is received at the subscriber's premises over the ordinary telephone network. As the telephone lines are generally only in use during a small part of the day and still less during the evening, this additional use is very logical. The inconvenience is, of course, that the programme may be interrupted for a telephone call. For subscribers with a high calling rate an additional telephone pair can be used for the transmission of programmes.

In most cases the subscriber should have a choice between several programmes. Each tele-

<sup>1</sup> Livre Rouge IV, Aa. Subsection CIII, p. 67.

phone line arranged for this service is therefore provided in the telephone exchange with a step-by-step selector which can be controlled by the subscriber who chooses the desired programme.

It is desirable to limit the transmission level used for the teleprogramme service to about the same value as the normal speech level, and it is therefore necessary to use an amplifier with the subscriber's loudspeaker. In this respect, the re-diffusion system, which does not need an amplifier since the transmission level can be much higher, has an advantage.

It is sometimes found desirable to remove the loudspeaker from the line during a telephone call. In this case a drop has been provided at the subscriber's premises, operated by both incoming and outgoing calls. It also interrupts the current of the amplifier. This apparatus may be installed or not, depending on the wishes of the customer or the telephone administration. In no case is it necessary to change the subscriber's set.

#### Exchange Equipment

As the programme switch should be operated

independently from the line relay, it is necessary to connect it to battery so that the subscriber can operate it through one of the line wires by grounding this wire. It appears, therefore, necessary to remove the line relay from battery to ground, which can easily be done.

As shown by the circuit of Fig. 7, the programme selector is connected to the back contacts of the cut-off relay through two condensers. Also shown in Fig. 7 and illustrated in Fig. 8, is the four-programme switch. This has 8 positions: 4 positions connect the line to one of the programme amplifiers and 4 are intermediate normal positions.

The electromagnet of this switch must fulfil several requirements:

1. Its impedance should match to a certain extent that of the line relay, since the line would otherwise be unbalanced. This balance need, however, not be perfect if the middle point of the low impedance windings of the output transformers are grounded.
2. The switch should not operate on short lines during a telephone call (in series with the line relay).
3. It should operate on all subscribers' loops from 0 to about 1000 ohms. When considering battery varia-

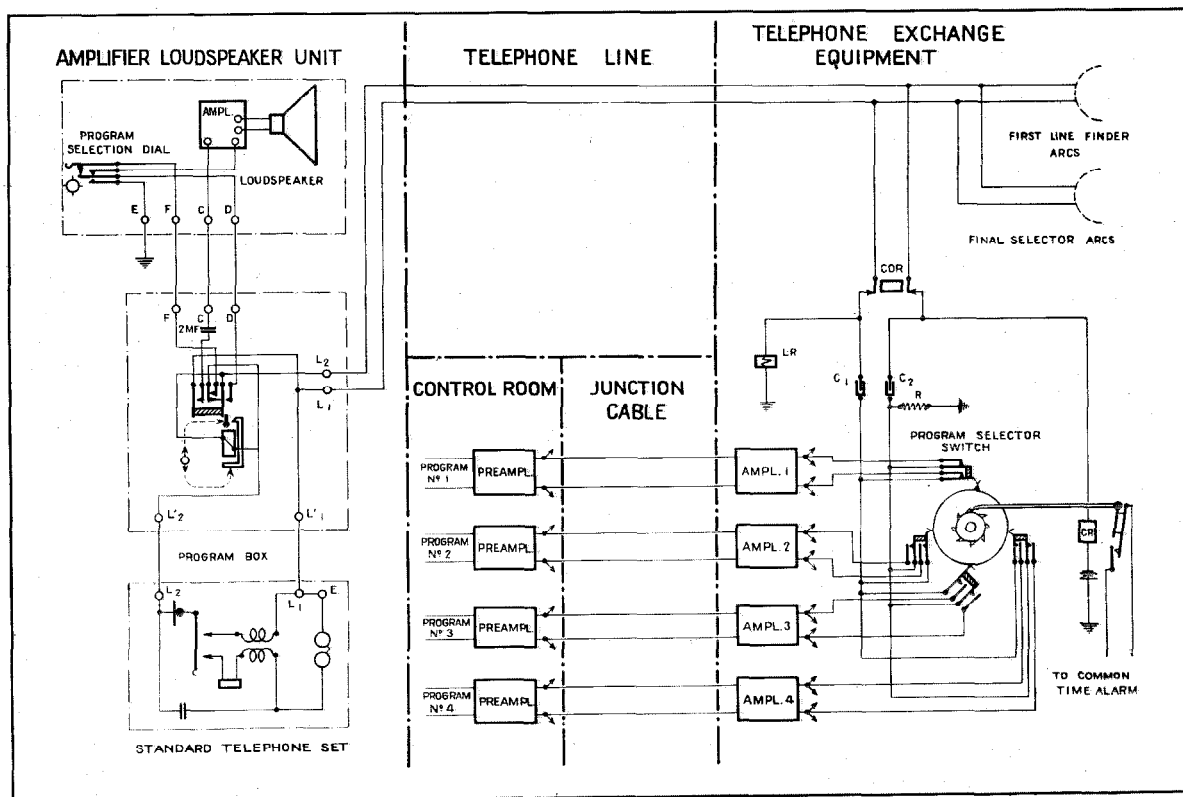

Figure 7—Teleprogramme System.

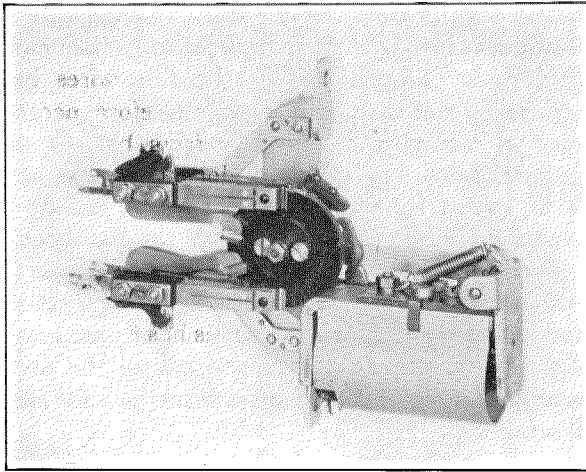

Figure 8—Four Programme Switch.

tions of 44 to 52 volts and ground potentials, it is not possible to satisfy these requirements by using only one adjustment. The switches are therefore adjusted to operate on lines from 0 to 500 ohm loop or on loops of 500 to 1000 ohms.

In order to avoid contact noise, which would degrade the quality of reception, the switches are not provided with wiping contacts. The springs are controlled by means of cams and the contacts can therefore be made of special contact metal.

As the line relay has been removed to the ground side of the line, it can no longer indicate a permanent ground. The switch has therefore been provided with a contact which operates a time alarm.

In order to reduce the transient currents on the line due to the operation of the switch, a resistance  $R$  has been provided. This could be replaced by a dry rectifier.

The amplifiers, selectors and condensers are mounted on racks.

The impedance of the output transformer of these amplifiers is rather low, so that the voltage is little dependent on the number of subscriber lines connected simultaneously to one amplifier.

#### Subscriber's Equipment

This equipment may simply consist of an amplifier-loudspeaker connected to the line. The input impedance of the amplifier is normally 1000 ohms, but it can be increased to more than 5000 ohms at 100 cycles per second and more than 10,000 at 1000 cycles per second by re-

moving the input shunting resistance. Its range is about 100 to 5000 cycles per second and, for an input of 0.6 volts, its output is about 1 watt. A potentiometer is provided to adjust the volume. Two tubes are used: a  $PA_1$  micromesh as amplifier and  $R_1$  micromesh as rectifier. The amplifier can be operated from 50 or 60 cycle mains of 110, 115, 125, 155, or 220 volts.

The moving coil loudspeaker has a seven inch diaphragm. For selecting the programme, a dial with illuminated indicating disc is mounted on the amplifier-loudspeaker (Fig. 9). This enables the subscriber to see at any moment what programme he is receiving.

In case it is desired to remove the above equipment from the line during telephone calls, a programme box can be installed near the subscriber's set. It works with all usual sets with or without extension sets. The drop is operated by the ringing current of an incoming call or by the d.-c. current when the subscriber originates the call. Fig. 10 shows this programme box.

#### Operation

Reference will be made to the complete system including the programme box. Fig. 7 shows the connections. When the subscriber wants to get one of the programmes, he turns the non-locking knob of his programme box and thereby sets the drop. The amplifier-loudspeaker is then connected to the line and the drop winding connected in series with the subscriber's set. The subscriber may now place the selection dial in the position corresponding to the wanted programme. This grounds the line wire  $L_2$  a certain number of times and moves the programme switch to the desired position.

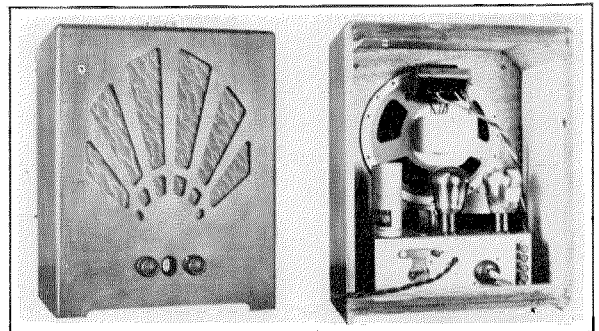

Figure 9—Amplifiers—Loudspeaker (Front View and Rear View).

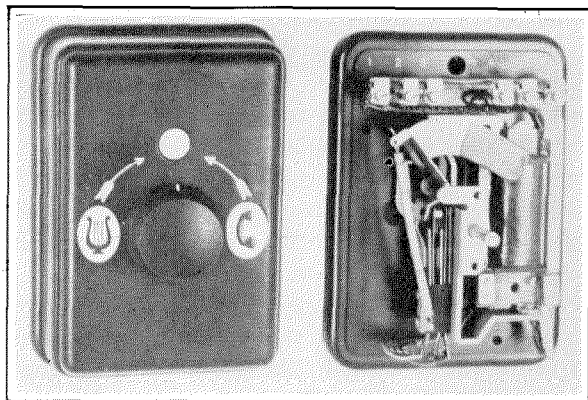

Figure 10—Programme Box.

To stop the reception, the subscriber turns the knob of the programme box in the opposite direction. This disconnects the amplifier and short-circuits the drop winding, so that the normal conditions are restored. In case the subscriber has no programme box, he moves the selection dial to a rest position, so that the programme selector disconnects the line from the amplifier.

In case the subscriber is called when he receives the programme, the cut-off relay at the exchange disconnects the line from the exchange amplifier and the ringing current operates the drop of the programme box, disconnecting the subscriber's amplifier. Only a short click is heard in the loudspeaker. At the end of the conversation, the subscriber may connect the same programme again by turning the knob of the programme box.

The subscriber may at any time use his telephone set. By taking the receiver off the switchhook he operates the drop and disconnects his amplifier.

When no programme box is provided, the telephone conversation can of course be followed by other people and the loudspeaker also reproduces clicks, ringing and tones.

#### Transmission Problems

There is no particular difficulty in the design of the exchange amplifiers. The difference in gain between 100 and 1000 p.s and between 1000 and 5000 p.s can for instance easily be kept within limits of 0.5 db. The distortion due to the line and the variable impedance of the amplifier-

loudspeaker are, however, more important. In order to avoid the variations due to the receiving equipment, it has been shunted by a non-inductive resistance so that the impedance is nearly 1000 ohms at all frequencies. A certain amount of energy is wasted, but its cost is very small. The distortion of course depends on the length of the line.

The curves of Fig. 11 give an idea of the overall characteristics due to the line and the variable terminal impedance. The variations are of course much smaller in case the amplifier-loudspeaker is shunted. This advantage can be used to the full when a programme box is used, since the impedance can then be made practically 1000 ohms for the whole frequency range. Without the programme box, the amplifier-loudspeaker remains connected to the line during telephone calls and the 1000-ohm shunt then causes an attenuation of more than 1 db. It is therefore necessary in this case to increase the shunt or leave it off altogether and accept a less uniform attenuation for the programmes. It will be realised that this is another reason for the use of this programme box.

Another problem is that of the best transmission level for the programme. On the one hand, this level should be high to keep a large margin between the music and noise levels. On the other hand, the level should not be large enough to cause objectionable crosstalk. This

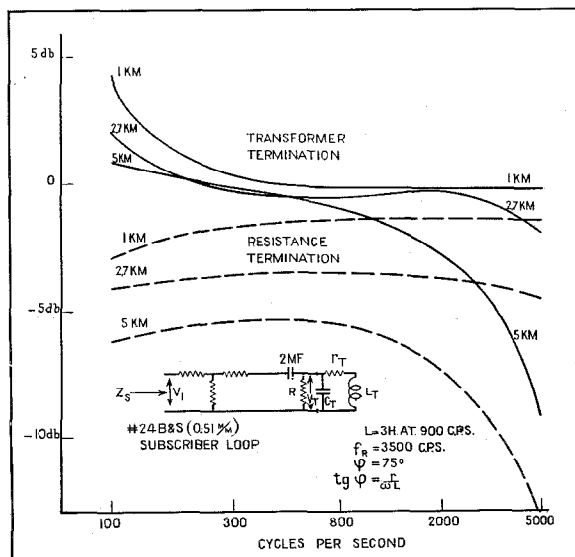

Figure 11—Transmission Characteristics of Telephone System.

question has to be considered in each particular case, since the best level depends on the conditions of the telephone network. In general, the average peak voltage impressed on the line should be of the order of 0.5 to 3 V. When considering groups of 500 subscribers and a maximum of 60% simultaneous connections to a given programme, the amplifiers should have a rated power of about 2 to 40 watts. This takes into account the provision of a low output impedance which reduces the voltage variations when the number of listeners changes.

A further problem is that of the unbalance which can be tolerated between the line relay

and the programme selector. Fortunately, this is rather easily solved as the output impedance of the exchange amplifier is small. By connecting the middle of the transformer winding to ground a relatively large unbalance can be tolerated for the above apparatus since their impedance is very large compared to that of the transformer. In one case the unbalance ratio, computed as the sum of the impedances divided by their difference, was 15% for the line relay and switch, and only 0.3% when the middle of the transformer was grounded. The larger the unbalance, the lower of course should be the programme level for a given amount of cross-talk.

## Recent Telecommunication Developments of Interest

**A**PPARATUS for the measurement of acoustic pressure of complex sounds at a given point has recently been developed by Le Matériel Téléphonique, Paris-Boulogne. Such an apparatus provides an easy means for determining the level of sound pressure in a room or street, for comparison of materials with respect to sound absorption or for improving working conditions as regards noise of machines, etc.

The apparatus comprises:

- (a) an electrodynamic microphone N° 4017-A
- (b) a two-stage input amplifier (4020-A lamps)
- (c) a variable attenuator capable of an attenuation of 80 decibels, and
- (d) a three-stage output amplifier (4020-A lamps)

Measurements are made by the "false zero" method. The output current of the three-stage amplifier is connected to a thermocouple associated with a microammeter. The deviation obtained when a known acoustic pressure is applied to the microphone is indicated by means of a mark. The measurement of an unknown pressure is made by adjusting the attenuator so as to bring the hand of the microammeter to the mark. A simple reading gives the ratio of the effective value of the pressure measured to that of the basic pressure.

A network reproducing the curve of the audibility threshold with respect to frequency may be inserted in the apparatus, so that in the case of single frequency sounds the apparatus permits

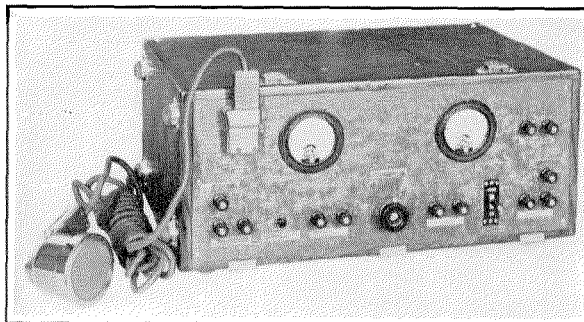

*Noise Measuring Set*

measurement of the level difference between the measured sound and the audibility threshold for various frequencies.

Batteries are used as the power supply. The batteries required are one of 16 volts, 0.25 amperes and one of 220 volts, 6 milliamperes.

One box contains all the apparatus except the batteries and the attenuator. Electrostatic screening and acoustic protection is provided.

The general characteristics are as follows:

Frequency range:	30 to 10,000 cycles
Pressure range:	3 to 30,000 millibars
Non-linear distortion:	negligible
Linear distortion:	below 2 decibels
Electrical amplification after the microphone:	approximately 130 decibels
Dimensions of the main box:	420 x 340 x 220 mm.
Weight of the main box:	25 kg.
Dimensions of the attenuator box:	270 x 190 x 180 mm.
Weight of the attenuator box:	5.5 kg.

**P**OWER cable joints, particularly those acting as stop-joints, tend to become bulky if the electrical strength factor is to be maintained at a level equivalent to that of the cable. The problem of accommodation and protection for joints is therefore becoming serious in congested areas and in cable routes in which several multi-phase cables in parallel are required to transmit bulk supply of electricity. Moreover, the cost of excavation, etc., for such joints is very considerable.

The ideal joint is one which occupies no more space than would be occupied by the cable itself if no joint were required—and which at the same time introduces no increased risk of breakdown

into the transmission system. This ideal joint is closely approximated to by the newly developed "polymerised joint" which can be made shorter in length than existing types, and with a diameter only about 7½% greater than that of the cable.

The joint is of normal construction insofar as the application of the paper tapes is concerned, and the method of impregnation follows practice that is in common use by many cablemakers. The impregnating and filling compounds are, however, made up of a mixture of specially selected hydrocarbons which on heating polymerise into a solid leathery mass of very high dielectric strength. In this polymerisation process the surface between the stepped or tapered

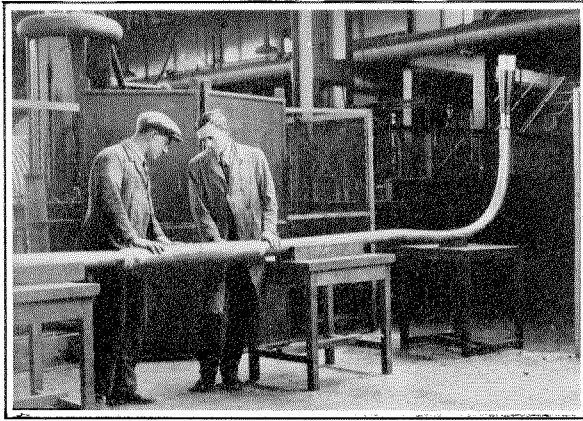

*3-Core Screened 33 kv. Joint*

termination of the cable and the newly applied

insulation of the joint is totally eliminated as if by a welding action.

Owing to the solidification of the insulation the joint automatically acts as a stop or barrier joint, resisting all fluid flow from one length of cable to the next, provided a solid ferrule is introduced into the bond between copper conductors of the consecutive lengths.

Life tests with heavy current loadings at over-voltages have been made on a series of joints of this type, the duration of the tests extending over several months. The joints so tested were thereafter subjected to breakdown tests but in each instance the cable itself, outside the joint, broke down, leaving the joint unaffected.

**T**HE high precision quartz crystal oscillator unit is a precision instrument (stability better than  $\pm 5$  parts in a million) developed by the Central Laboratories and primarily intended for the accurate control of the radiated frequency of broadcasting transmitters working on shared wavelengths and International common wavelengths.

The unit is entirely self-contained, with power supply system, and operates from the 220 volt a-c. supply mains.

On the right of the illustration is shown the crystal oven and thermostat temperature control system. The quartz crystal is contained in a double thermostat, the temperature of each chamber being controlled by mercury thermometers operating the control grid of hot cathode gas discharge tubes. On the left are shown the three radio frequency valves and the rectifier valve.

Controls are provided permitting a continuous

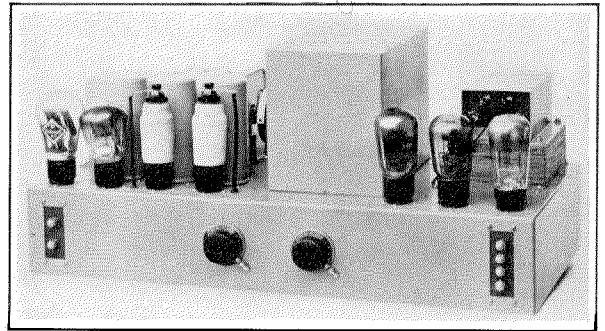

*Type C. O. 4 High Precision Oscillator*

variation of frequency of  $\pm 20$  cycles from the nominal value to allow exact initial setting of frequency, and for adjustment of output power.

A measured stability of considerably better than  $\pm 5$  parts in a million is obtained for ambient temperature variations from  $10^{\circ}\text{C}$ . to  $45^{\circ}\text{C}$ . The effects of supply voltage variations and vibration have been made inappreciable.

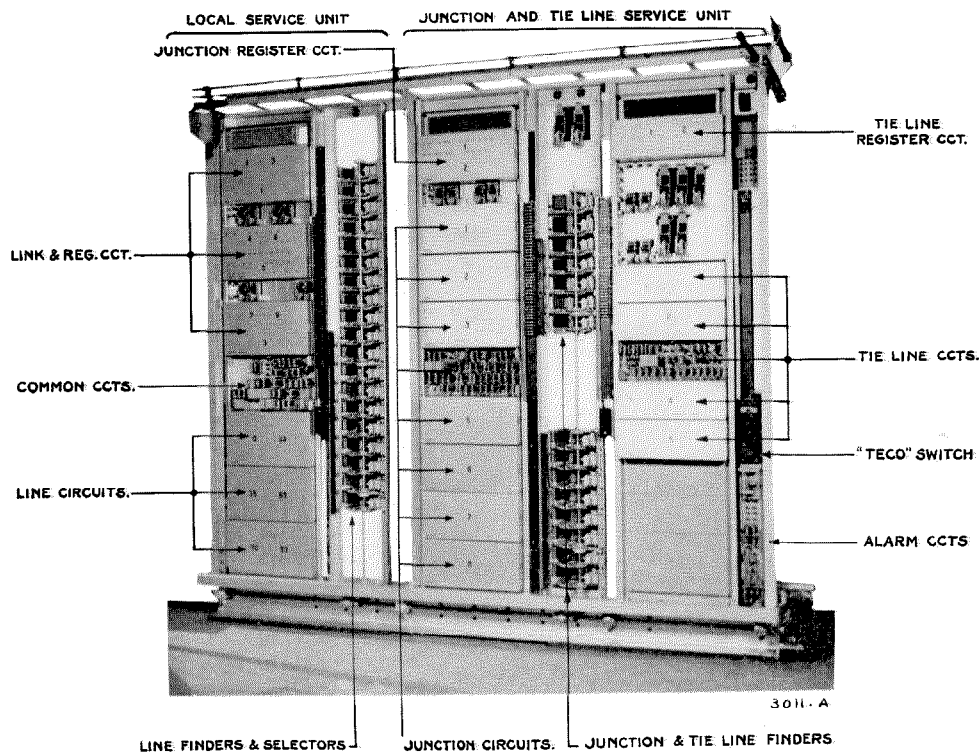

To meet home, institutional, industrial, and factory needs, private branch exchange equipments have been developed for a wide variety of service conditions.

The modern private automatic branch exchange can be furnished to include many valuable special features, such as: tie lines to other P.A.B.X's.; conference circuits for interconnecting simultaneously a predetermined number of stations; preference service permitting certain stations to break-in on an existing connection to convey urgent information; code calls for operating a number of call bells or lamp signals; and fire alarm calls.

P.A.B.X's. are available in practically all sizes from a few lines to several hundred. They are suitable for use in localities served either by manual or automatic central offices, and provide high-grade service during all hours of the day and night with connections that are secret.



---

---

## *Licensee Companies*

- BELL TELEPHONE MANUFACTURING COMPANY.....*Antwerp, Belgium*  
*Branches: Brussels.*
- BELL TELEPHONE MANUFACTURING COMPANY.....*Berne, Switzerland*  
BELL TELEPHONE MANUFACTURING COMPANY.....*The Hague, Holland*
- CHINA ELECTRIC COMPANY, LIMITED.....*Shanghai, China*  
*Branches: Canton, Hankow, Hongkong, Peiping, Tientsin.*
- COMPAÑÍA STANDARD ELECTRIC ARGENTINA.....*Buenos Aires, Argentina*
- INTERNATIONAL STANDARD ELECTRIC CORPORATION, *Branch Office,*  
*Río de Janeiro, Brazil*
- LE MATÉRIEL TÉLÉPHONIQUE.....*Paris, France*  
*Branch: Rabat, Morocco*
- NIPPON DENKI KABUSHIKI KAISHA.....*Tokyo, Japan*  
*Branches: Osaka, Dairen, Taihoku.*
- FERDINAND SCHUCHHARDT, BERLINER FERNSPRECH-UND TELEGRAPHENWERK  
AKTIENGESELLSCHAFT.....*Berlin, Germany*
- STANDARD ELECTRIC AKTIESELSKAB.....*Copenhagen, Denmark*
- STANDARD TELEFON—OG KABELFABRIK A/S.....*Oslo, Norway*
- STANDARD ELECTRIC COMPANY W POLSCE SP. Z. O. O.....*Warsaw, Poland*
- STANDARD ELECTRIC DOMS A SPOLECNOST.....*Prague, Czechoslovakia*  
*Branch: Bratislava.*
- STANDARD ELECTRICA ROMANA S/A.....*Bucharest, Rumania*
- STANDARD ELÉCTRICA, S. A.....*Madrid, Spain*  
*Branches: Barcelona, Santander.*
- STANDARD ELECTRICA, S. A.....*Lisbon, Portugal*
- STANDARD ELETTRICA ITALIANA.....*Milan, Italy*  
*Branch: Rome.*
- STANDARD TELEPHONES AND CABLES, LIMITED.....*London, England*  
*Branches: Birmingham, Glasgow, Leeds, Manchester, Dublin, Cairo, Johannes-*  
*burg, Calcutta, Singapore.*
- STANDARD TELEPHONES AND CABLES (AUSTRALASIA), LIMITED.....*Sydney, Australia*  
*Branches: Melbourne; Wellington, New Zealand.*
- STANDARD VILLAMOSSÁGI RÉSZVÉNY TÁRSASÁG.....*Budapest, Hungary*
- SUMITOMO ELECTRIC WIRE & CABLE WORKS, LIMITED.....*Osaka, Japan*
- VEREINIGTE TELEPHON-UND TELEGRAPHENFABRIKS AKTIEN-GESELLSCHAFT,  
CZEIJA, NISSL & CO.....*Vienna, Austria*

---

*Sales Offices and Agencies Throughout the World*

---

---