

3RD COPY

M. 876 1100

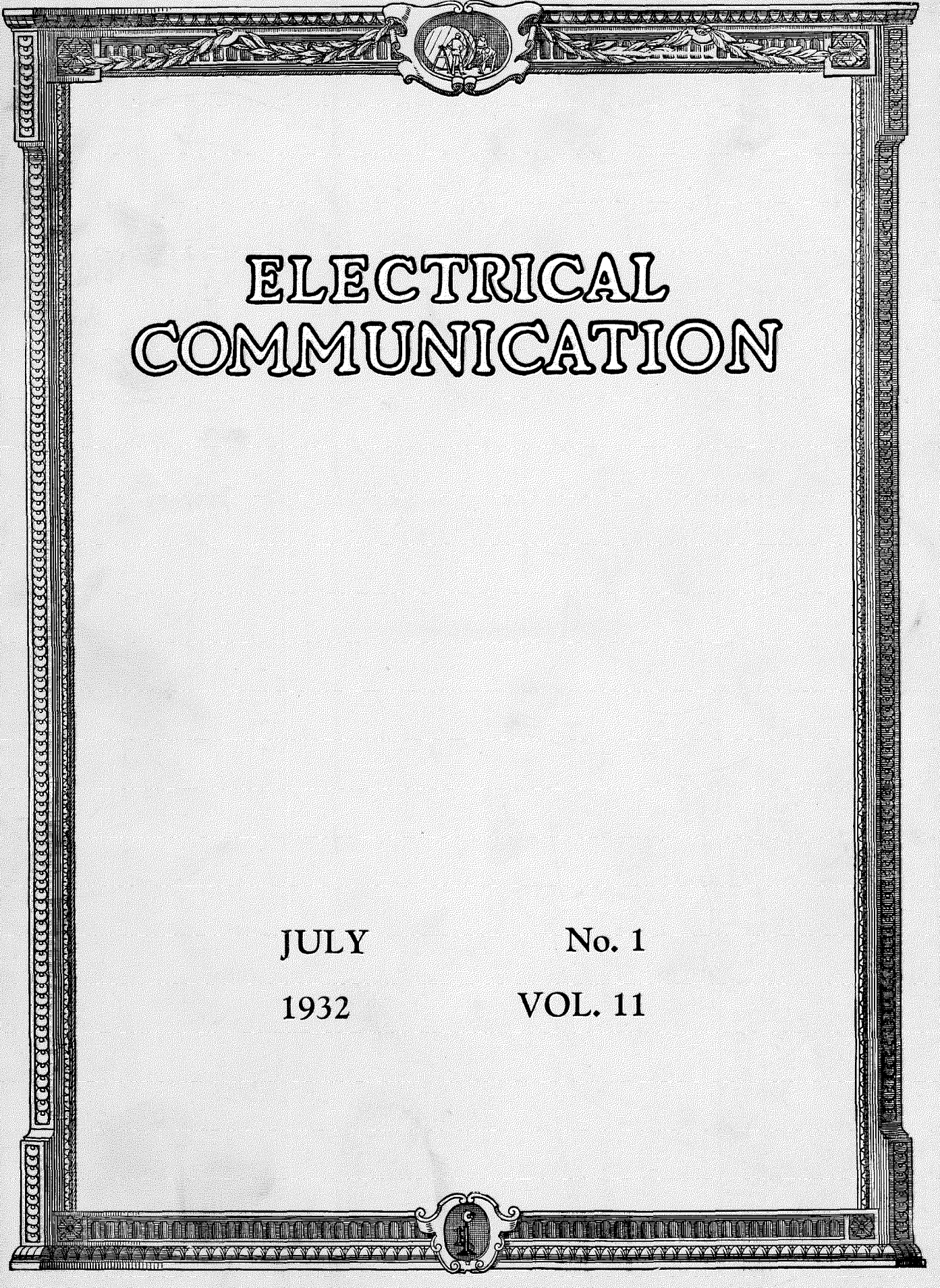

ELECTRICAL COMMUNICATION

JULY

No. 1

1932

VOL. 11

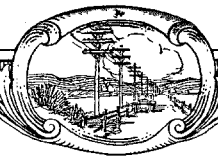

ELECTRICAL COMMUNICATION

A Journal of Progress in the
Telephone, Telegraph and Radio Art

H. T. KOHLHAAS, Editor

EDITORIAL BOARD

J. L. McQuarrie F. Gill G. Deakin P. E. Erikson G. H. Nash John W. Foard
G. E. Pingree P. K. Condict E. A. Brofos E. M. Clark Frank C. Page

Published Quarterly by the

International Standard Electric Corporation

Head Offices

67 BROAD STREET, NEW YORK, N. Y., U. S. A.

European General Offices

CONNAUGHT HOUSE, ALDWYCH, LONDON, W. C. 2, ENGLAND

G. E. Pingree, President

S. G. Ordway, Secretary

James E. Fullam, Treasurer

Subscription \$3.00 per year; single copies 75 cents

Volume XI

JULY, 1932

Number 1

CONTENTS

	PAGE
THE NEW SWISS BROADCASTING STATION.....	3
<i>By F. C. McLean, B.Sc., A. M. I. R. E.</i>	
THE SWISS BROADCAST NETWORK.....	9
<i>By A. Muri</i>	
STANDARD BROADCASTING LAND LINE EQUIPMENT.....	13
<i>By A. R. A. Rendall, B.Sc., A. M. I. E. E. and J. S. Lyall, B.Sc., A. M. I. E. E., A. C. G. I.</i>	
TELEPRINTER NETWORK OF THE BERLIN POLICE ADMINISTRATION	22
<i>By Police Captain Voit</i>	
THE 7-D ROTARY SYSTEM FOR SMALL COMMUNITIES.....	32
<i>By W. Hatton</i>	
THE RECONSTRUCTION OF THE SHANGHAI TELEPHONE SYSTEM.....	39
<i>By J. Haynes Wilson, M. C.</i>	
TELEPHONE AND TELEGRAPH STATISTICS OF THE WORLD....	50

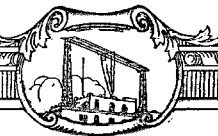



INTERNATIONAL TELEPHONE BUILDING
67 Broad Street, New York

The New Swiss Broadcasting Station

By F. C. McLEAN, B.Sc., A.M.I.R.E.

EARLY in 1930, the Swiss Administration decided to proceed with their plans for reorganising the broadcasting service of their country on the most modern lines. The new system, which is well on the way to completion, will give listeners a greatly improved service owing not only to increased facilities for the interchange of programmes between the principal cities of the country, but also to a very definite improvement in the conditions of reception. The latter is being ensured by the installation of new transmitting equipments capable of meeting the highest present day standards of performance.

Briefly, the scheme involves the provision of repeatered "broadcast" circuits in the telephone cables connecting the principal broadcasting centres, together with the erection of a number of low power relay stations and two main high power transmitting stations. The two latter are intended as the "National" broadcasting stations for the French-speaking and German-speaking parts of the country, respectively. A third high power station, to be erected in the Italian part of Switzerland, is planned for a later date.

The first of the new high power stations to be ready for service was the one allocated to the French-speaking area, which was officially opened on March 25, 1931. For this station a "Standard" broadcasting equipment, having an unmodulated antenna power of 25 kw. (C.C.I.R. rating on 100% modulation, 37.5 kw.), had been chosen.

Before actually deciding on the site for the new station a considerable amount of work was done by the Radio Department of the Administration to determine the most satisfactory locality for the new station. A portable radio transmitter was stationed at various places which seemed likely to give favourable results, and field strength contour maps were made of the radiation from each of these sites with the aid of a "Standard" field strength measuring set. These maps were then investigated to find

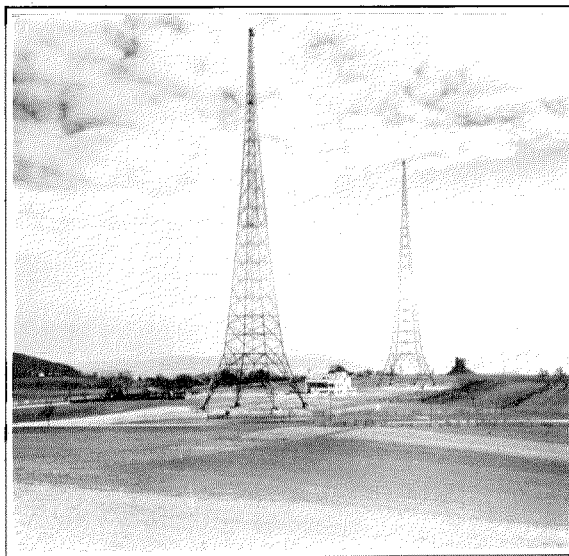

Figure 1—New Swiss Broadcasting Station

which of the sites gave most satisfactory distribution of field strength.

The necessity for this work will be appreciated when the mountainous nature of the country is considered. Whatever the location and power of the transmitter it would be virtually impossible to give a good service over the whole country, and considerable care was necessary to choose the site to give the best possible service to the maximum number of people.

The site finally chosen was near the village of Sottens in the Jorat Highlands, which rise from the plain between the Jura Mountains and the Alps. The radio station is at one of the highest points of this range of hills, at a height of 2,500 feet above sea level. It is located at a distance of about 12 miles from Lausanne on a line joining this town to the Lake of Neuchatel. Figure 1 shows the station and masts. As will be seen from this photograph the site chosen is excellent from a transmission standpoint. The immediate vicinity is free from any obstructions of a nature likely to interfere with radiation, and the nearest mountains are some forty miles away.



Figure 2—Transmitter Room Looking Towards the Machine Room at the Far End

The equipment was manufactured by Standard Telephones & Cables, Ltd., at their London Works. It is similar in type to the equipment described in a previous issue of *Electrical Communication*.¹

The transmitter is designed to give a carrier power into the antenna of 50 kw. which can be modulated 100%. The last stage of amplification is divided into two sections, one of which can be used alone to give an output carrier power of 25 kw. At the time of writing only one-half of the last stage had been installed, but the station has been engineered with a view to ultimate extension by the addition of the second unit.

One of the respects in which the station differs from the equipment previously described is that special filter circuits have been provided to reduce the radiation on the harmonics to a low value. This consists of circuits designed to bypass the harmonics directly between the plate and earth in the amplifier unit, and also to offer a high impedance to prevent the harmonic currents flowing to the output circuit. The antenna coupling condenser is also tuned to offer a very low coupling impedance to the harmonic frequencies. By these means the harmonic radiation is reduced to a very low value.

The power consumption of the transmitting equipment when running with 50 kw. carrier power fully modulated, is about 250 kw., and the consumption for carrier power at 25 kw. fully modulated is 150 kw. This includes the power taken by all auxiliary machines, pumps and fans,

and is measured on the high tension side of the main incoming supply transformer.

The power taken for lighting and heating the building during the winter is approximately 30 kw. This power is delivered to the station at a tension of 8000 volts. Two sources of supply are provided from entirely separate power stations, the power being brought to the station by two separate high tension feeders. The power lines are of the open wire type but within a distance of about 220 yards before reaching the station they are run underground.

The 8,000 volt incoming supply is stepped down to 380 volts, from which the whole transmitter is designed to operate. Two 8,000/380 volt stepdown transformers are provided, one being a spare, and either transformer can be connected to either of the incoming supply feeders.

Station Building and Layout

The transmitting station building, which is of modern architectural design, has been arranged to give a light and airy interior with large windows on all sides. It comprises an upper floor and a basement.

The radio transmitter room, the machine room, and the necessary offices are located on the ground floor, while the basement accommodates the high tension enclosure, the pump and ventilator room, the stores and the workshop. By distributing the various parts of the equipment in this manner most of the heavy and noisy machinery has been concentrated in the basement. The machines for supplying the

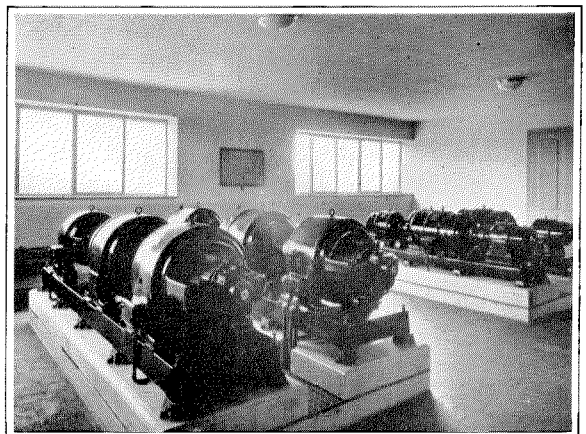

Figure 3—The Machine Room

¹ D. B. Mirk, "A New High Power Radio Broadcasting Equipment," *Electrical Communication*, April, 1929.

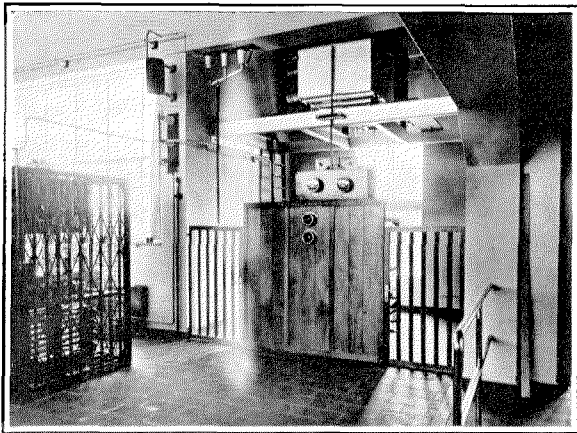

Figure 4—Output and Antenna Circuit Enclosure

various voltages to the equipment were, however, left on the ground floor in order to facilitate the work of the personnel in supervising their operation.

Figure 2 is a view looking down the transmitter room towards the machine room at the far end. On the left are the high tension rectifier, supplying the 12,000 volt anode tension to the amplifier valves, and the power control board. On the right is the radio transmitter. At the far end of the room are the power board for the lighting and heating of the building, and the change-over switchboard for employing one or other of the duplicate sets of machines provided.

In order to provide against interruption of service due to breakdown, all rotating machinery is installed in duplicate. The switching system provided on the change-over switchboard is such that it is possible to use the output of any individual machine; that is, the machines are not changed over in groups, but in units.

The voltage of the supply to the filaments of the water-cooled valves is kept constant by means of an automatic voltage regulator.

Figure 3 shows the machine room. In the background is the three-unit machine and its spare for supplying the filament and plate power to the oscillator modulator unit. In the foreground is the four-unit machine and its spare supplying the grid bias tension and the filament power for the amplifier valves. It will be noticed that the machines are mounted on anti-vibration supports to minimize vibration in the building.

Figure 4 shows the output and antenna cir-

cuit enclosure. The output from the six valve amplifier unit passes through a harmonic suppressing filter to the parallel-tuned output circuit which is capacitively coupled to the antenna. Rough tuning of this circuit is effected by means of tappings on the inductance coil and by adjusting the value of the capacity in circuit from the number of fixed condensers supplied; line tuning is effected from the front panel by means of a rotating short-circuited turn in the field of the inductance coil. Access to this enclosure is obtained through doors which, like all the other doors in the equipment giving access to places where high tension exists, are fitted with safety contacts which remove the high tension immediately the doors are opened. Above the output circuit is seen the variable air condenser which is used for tuning the antenna. The space in front of the output circuit is reserved for the installation of the second amplifier for raising the power of the station to 50 kw.

Figure 5 shows a view looking along the back

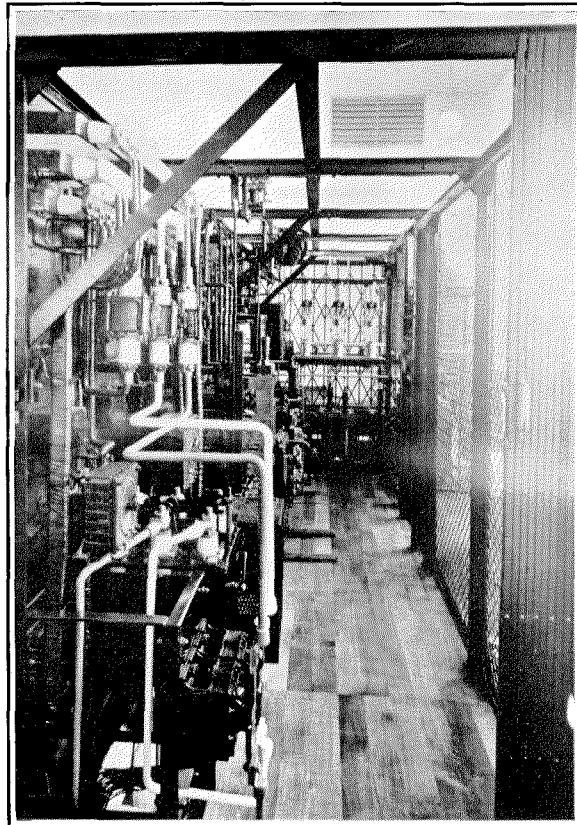

Figure 5—View Along the Rear of Power Board Towards the Rectifier Unit

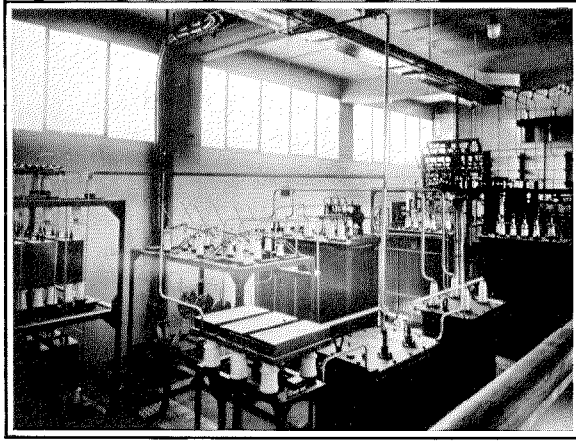

Figure 6—High Tension Enclosure in Basement

of the power board with the back open towards the rectifier unit.

The high tension enclosure in the basement is seen in Figure 6. In the foreground is part of the high tension smoothing condenser rack, the smoothing choke, the resistance for the 12,000 volt voltmeter, the interphase reactor, the protection rack, containing protective spark gaps and resistances, and the high tension transformer. In the background are the incoming power supply transformers and the associated switch-gear.

Water Cooling System

For filling and replenishing the water cooling system, rain water is collected on the copper

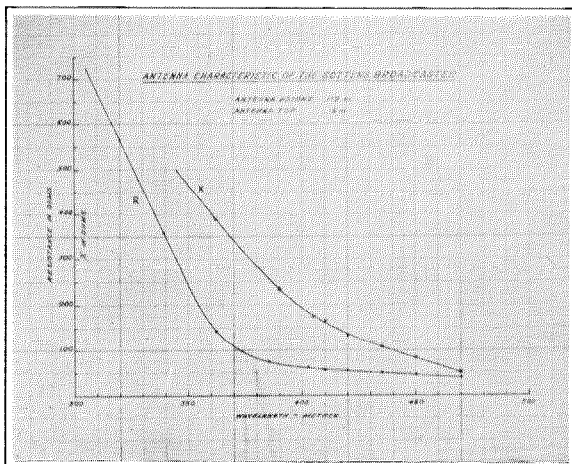

Figure 7—Antenna Resistance and Reactance

covered roof. The rain water is stored in galvanized steel tanks, having a total capacity of 1,500 gallons, which are located in the basement of the building. As the same water circulates continuously round the system, and the evaporation is negligible, the station could work almost indefinitely with the water stored; there is thus no need to fear the effect of any spell of dry weather.

From these tanks the water is taken by one of two centrifugal pumps, and passes through the anode jackets of the valves, along to the coolers and back to the pumps. The coolers consist of large honeycomb radiators over which air is blown by fans. The coolers and fans are provided in duplicate, and one or both may be employed, depending on the external air temperature.

Antenna and Earth System

The antenna is supported by two steel towers 410 feet high standing 218 yards apart. The towers, which are of the self-supporting type, are insulated at the base by means of porcelain insulators. The design of the insulating arrange-

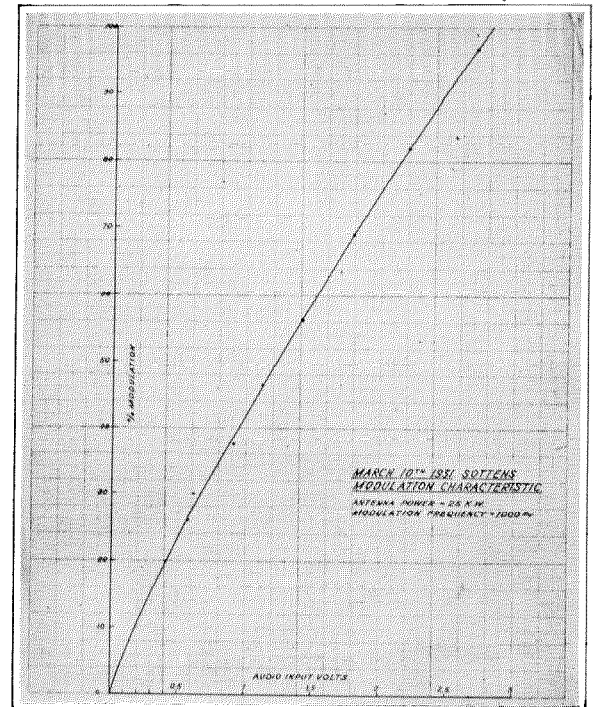

Figure 8—Modulation Characteristic on Antenna Carrier Power of 25 kw.

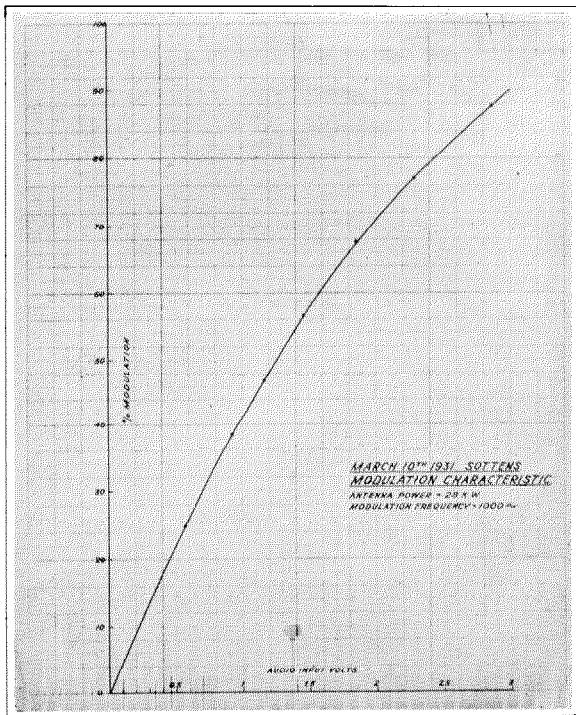

Figure 9—Modulation Characteristic on Antenna Carrier Power of 28 kw.

ments was specially studied with a view to reducing the capacity between the base of the mast and earth.

The antenna finally adopted as making best use of the available height of the towers is a simple high "T" antenna with a short horizontal top. The vertical member consists of a cage 328 feet high, and the horizontal top is 16 feet 6 inches long. The resistance and reactance of this antenna was measured by means of a special high frequency impedance bridge; the results of the measurements are given in Figure 7.

The earth system consists of a buried network extending for a distance of 109 yards on both sides of the centre line between the two masts. The overall dimensions of the earth system are 218 yards wide and 273 yards long. It is composed of 3 mm. copper wire spaced 6 feet 6 inches apart, and buried to a depth of 19½ inches in the ground. The wires are buried to this rather unusual depth in order to allow the ground to be used for agricultural purposes. The connection from the earth network to the radio frequency earth of the equipment is made by a copper tube 3 inches in diameter.

Line and Speech Input Equipment

The incoming programme lines come in a special cable from the town of Moudon at a distance of 7 kilometres, where they link up with the special broadcast pairs in the Lausanne-Bern telephone cable. Programmes may be taken from Lausanne, Bern, or Geneva, "Standard" broadcast repeaters being provided in Lausanne and Bern to enable the necessary levels for the transmission over the cable to be made.

The telephone cable, which is aerial for the greater part of the distance between Moudon and Sottens, passes underground about 1 kilometre before it approaches the station. This is partly to avoid radio frequency induction on the line, but the distance has been made so great because the position of the station is too exposed to permit the use of aerial telephone cable in its vicinity. The line therefore goes underground as soon as it leaves the valley.

At the radio station a "Standard" line amplifier equipment is used to amplify the output of the cable to a sufficient level for the input of the radio transmitter. This line amplifier equipment also provides facilities for a local microphone and gramophone pick-up.

Performance

The output power of the transmitter was measured by observation of the current delivered into the antenna, the resistance of which was known from measurements made with the high frequency impedance bridge. The power was

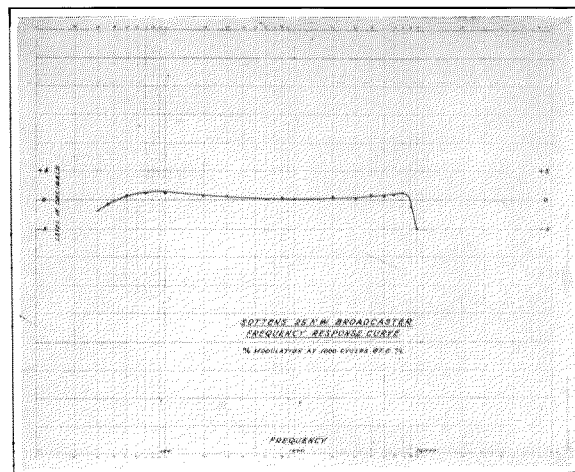

Figure 10—Frequency Response Characteristics

also measured by observations on the artificial antenna. The results from both methods indicated a carrier output of 25 kw. The degree of linear modulation which could be effected on this carrier power was determined by means of a cathode ray oscillograph. The results are given in Figure 8, from which it is seen that modulation on a carrier of 25 kw. is practically linear up to 100%.

A modulation curve for an antenna carrier

power increased to 28 kw. is shown in Figure 9.

In Figure 10 frequency response characteristics are shown which were obtained by observing the degree of modulation obtained with different input frequencies at a fixed input level. An examination of this curve shows that the level of modulation at any frequency between 30 cycles and 8,500 cycles does not depart by more than two decibels from the value for an input at 1,000 cycles.

The Swiss Broadcast Network

By A. MURI

Chief of the Technical Department of the Post, Telegraph and Telephone Administration, Bern.

ALTHOUGH it may perhaps sound paradoxical, it will be seen from this article that radio transmission can only be utilised to its maximum advantage by means of wire connections. Radio has, since its development, been a competitor to wire transmission and has offered keen competition. With time this competition has become less marked, until today it has been replaced by co-operation, and the development of each proceeds hand in hand. In the broadcast system the transmitting stations are usually situated outside the main cities and studios are connected from various localities by means of cable wire circuits specially allocated for broadcast transmissions. This circuit network contains the necessary links for inter-connecting

the various transmitters and studios, the latter usually being situated in the large towns.

Twelve years ago when the main features of the Swiss Toll Cable project were first determined, the necessity for broadcast circuits was not anticipated and consequently was not catered to in the first cable designs. It was only with the further development of the cable network and with the duplication of the cables that it was possible to provide special circuits for broadcast as well as for normal speech transmission. In the year 1928, the cables Zurich-Stuttgart, St. Gallen-Innsbruck and Zurich-Gotthard-Milan were commenced containing such circuits. These were followed in the years 1929-30 by the cables Zurich-Olten-Basel; Olten-

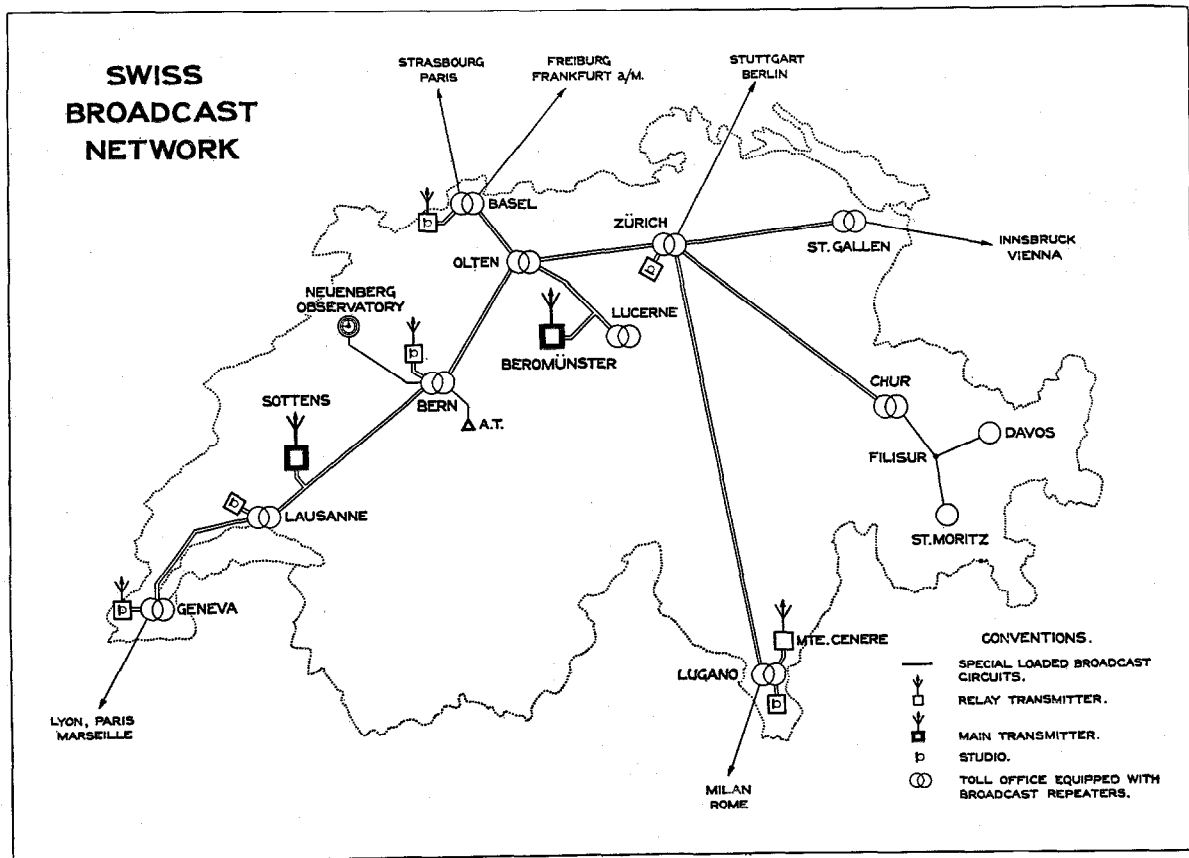

Swiss Broadcast Network

Bern-Lausanne; and, in the year 1931, by the cables Lausanne-Geneva and Zurich-St. Gallen. In the year 1931 the mountain resorts of St. Moritz, Davos, and Arosa were connected to Chur by means of cables containing such broadcast circuits, and at the present time the completion of this link by means of the cable Zurich-Chur is being undertaken.

The Swiss broadcast network extends today, as shown on the diagram, from Geneva over Lausanne-Bern-Olten-Basel, Olten-Zurich towards St. Gallen, and from Zurich via the Gotthard towards Lugano, with Olten and Zurich as the main switching centres. All switching points are equipped with amplifiers and apparatus enabling every studio to be connected to any transmitter.

The layout of the underground cable circuit network involved a consideration of all the following factors: the disposition of the localities to be supplied, the number and position of the transmitters and studios, as well as the existing duct route facilities. Before considering in more detail the structure of this network, a short description of the broadcast system, as shown in the diagram, will be of interest.

On the occasion of the re-organisation of the Swiss broadcast system in the year 1929, Switzerland was divided into three zones, viz.:

- (a) *French-speaking Switzerland*, with the main transmitter at Sottens and a relay transmitter at Geneva. Both these transmitters, which broadcast the same programme, are fed by the studios of Lausanne and Geneva.
- (b) *German-speaking Switzerland*, with the main transmitter at Beromünster and two relay transmitters at Bern and Basel. All three transmitters broadcast the same programme, and are fed from the studios at Zurich, Bern, and Basel as required.
- (c) *Italian-speaking Switzerland*, with the main transmitter, which is still under construction at Mte. Cenere. When completed, it will be served by the studio at Lugano.

In Switzerland it is usual for three programmes to be broadcast daily. For every transmitter, definite normally-associated studios are allocated. It can, however, happen that the main transmitter of German-speaking Switzerland can take the programme of Sottens or Mte. Cenere and vice versa. The line network must be capable of satisfying all these requirements, and especially must the transmission be free from

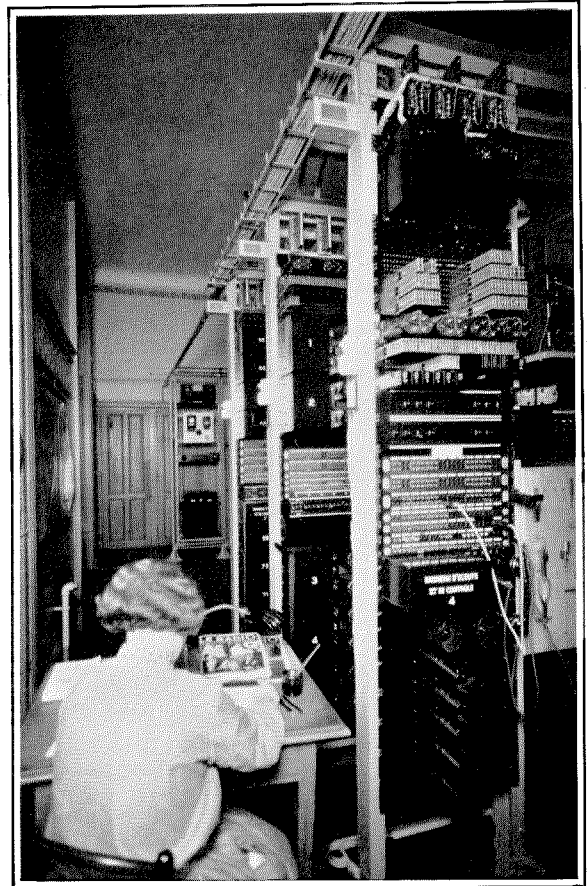

Broadcast Repeater at Lausanne Repeater Station

distortion and of adequate power for the transmitter.

In order to meet the special requirements for music transmission, two circuits separately screened, either by means of a lead sheath or by means of Staniol foil, are provided in the centre of the toll cables; these pairs have a guaranteed crosstalk attenuation of more than 12 népers. The conductors of these pairs are of 1.0 to 1.5 mm. diameter, according to the length of the repeater section, and are loaded on a spacing of 1.83 km. Pair circuits are loaded with coils of 15.5 millihenrys, and on other cable routes where a quad has been provided, 9.5 millihenrys phantom loading is used. This loading provides a circuit having in each case a cut-off frequency of 10,000 cycles which, in turn, enables a transmission range of 35-7500 cycles to be obtained without distortion. By means of the duplicated circuit groups, it is possible, for example, to

arrange for the studio at Lugano to provide the programme for the Sottens transmitter without interfering with the transmission of the German speaking zone, and also for the studio at Geneva to send a programme to the Mte. Cenere transmitter without interfering in any way with the transmission being radiated from Sottens and Beromünster.

The following connections can be established:

(a) *In French-speaking Switzerland.*

1. The Geneva Studio sending:

The programme via the toll office at Geneva is supplied to Lausanne and at the same time to the relay transmitter in Geneva. The toll office at Lausanne further supplies the programme direct to the Sottens transmitter.

2. The Lausanne Studio sending:

The toll office at Lausanne makes a direct connection between the Studio and the Sottens transmitter, and at the same time makes connection to the line to Geneva. At Geneva the connection will be continued to the local relay transmitter, whilst the local Studio line is left disconnected.

(b) *In German-speaking Switzerland.*

1. The Zurich Studio sending:

The toll office at Zurich connects the Studio with Olten; Olten makes connection with Bern, Basel and Beromünster; Basel connects the incoming Olten line to the relay transmitter at Basel and at Bern connection is made to the relay transmitter at Bern.

2. The Bern Studio sending:

The toll office at Bern connects the line from the Bern Studios with Olten; Olten switches the circuit to Zurich, whilst as far as Basel is concerned nothing need be changed.

3. The Basel Studio sending:

To Olten the connection is the same as under 2. In Basel connection is made to the Studio line, and in Bern the Studio line connections are broken down.

(c) *In Italian-speaking Switzerland.*

These connections are generally established and maintained between the Studios at Lugano and the transmitter at Mte. Cenere. Nevertheless, it is possible to establish a connection between this transmitter and the Studios of the French and German speaking zones, and on the other hand, between the Studio at Lugano with the transmitters of Sottens and Beromünster.

It is, of course, understood that the amplifiers at the various switching points can be connected into the circuit to take account of the different directions of transmission. It can readily be seen from the diagram how, apart from the normal

connections of studios and transmitters, it can easily be arranged for the interconnection of the different zones.

In addition to the use of screened pairs for the establishment of long distance circuits, screened pairs are also used to connect the various toll offices with their associated studios and transmitters. In general, the latter are of 0.8 mm. conductors which are loaded for music transmission if of sufficient length, or where non-loaded, are equalised. It will be understood that in the case of these connections also, distortion is avoided. The cables containing these connections are laid in the duct lines of the local network, and contain from 6 to 8 screened pairs.

In Bern a connection exists to the Neuenburg Observatory, from which, twice daily, a time signal is broadcast for the French and German-speaking zones. Between the offices of the "Schweiz Depeschagentur" in Bern and the Bern Station there are two special connections to enable the broadcast twice daily of the latest news simultaneously for the French and German speaking zones, via the transmitter at Sottens and its relay at Geneva, and the transmitter at Beromünster and the relay stations at Bern and Basel. After the opening of the main transmitter at Mte. Cenere, a third connection will also be established for the benefit of Italian-speaking Switzerland.

In addition to this network of circuits for music transmission, there exist light loaded circuits having a cut-off frequency of 6800 cycles

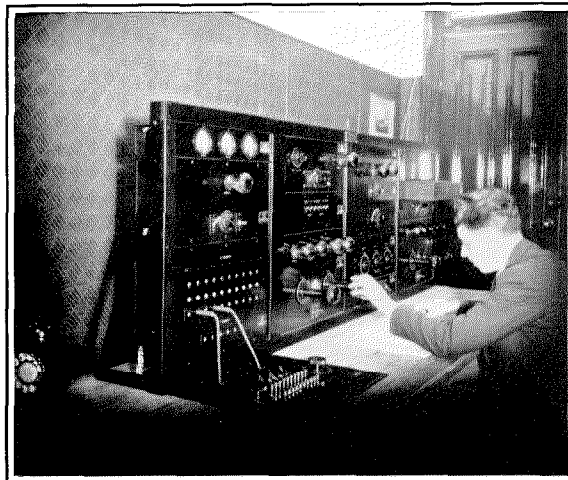

The Studio Equipment at Lausanne

which enable an equalised transmission range to be obtained of 150-5000 cycles. These circuits are intended for broadcast speech transmission. This additional network is connected up in a manner similar to that for the music network, and extends from Geneva over the Lausanne-Bern-Olten cable to Zurich, and from there via the Gotthard to Lugano. Over the whole stretch two pairs are available which enable connections to be established in either direction.

There are also special music circuits loaded to a cut-off frequency of 10,000 cycles available for connecting into the networks of foreign countries. These exist from Zurich towards Stuttgart, from Zurich towards Innsbruck and Vienna, and from Basel towards Freiburg and Frankfurt a/M. France and Italy can only be connected at present by means of circuits having a cut-off frequency of 6800 cycles.

At present 87% of all the toll circuits are in underground cable. Further extension of the cable network is planned within the next few years, so that, in the near future, every important toll exchange will be connected in the cable system. As this construction proceeds, the possibility will be offered to all the telephone subscribers in Switzerland to have connection to this network of circuits for music transmission. This new branch of the art of providing direct music transmission to the subscribers via this cable network is already proving very attractive, but it is essential that the transmission be kept absolutely free from any external interference which would affect the broadcast transmission up to the subscribers' station. Without looking



The Announcer's Control Equipment at the Lausanne Studio

too far into the future, it must already be acknowledged that this transmission over wire circuits offers a wide field which can be constantly extended without causing the actual radio transmission to suffer any great loss. Both will develop in useful co-operation, and, each aiding the other, will tend to serve the community to the maximum advantage.

Standard Broadcasting Land Line Equipment

By A. R. A. RENDALL, B.Sc., A.M.I.E.E. and J. S. LYALL, B.Sc., A.M.I.E.E., A.C.G.I.

International Telephone and Telegraph Laboratories, Incorporated

THE extensive use of cable and open wire circuits for the distribution of radio programmes has necessitated the development of special equipment to meet the high grade requirements which this service imposes. This includes the design of loaded cables, line amplifiers, repeating coils and distortion correcting devices, as well as arrangements for branching and switching.

In designing the Standard system, all stages of the development of the broadcasting network have been considered. It has not only been made as flexible as possible so that extensions can readily be added, but the components have been designed so that economy can be achieved in the initial installation of a network, and means for giving the highest performance added later.

While special types of loading have been chosen for broadcast circuits, the amplifiers and equalisers can be used on any type of loaded circuit and on open wire lines.

The object of the present paper is to describe in general terms the features of the Standard system. Among the networks to which this system has been applied is that in Switzerland which is described in the preceding paper.

The Requirements of a Broadcasting System

The transmission requirements which international broadcast circuits should meet have been drawn up by the Comité Consultatif International (C. C. I.)¹. As these requirements are applicable to most long distance broadcast circuits, the more important of them are given below, and explanatory notes are added where necessary. The Standard equipment meets the C. C. I. requirements even when used in the most economical manner.

FREQUENCY RANGE AND ATTENUATION DISTORTION

The frequency range transmitted by the complete

circuit should be at least 50—6400 p. p. s., and in this range the attenuation at any frequency should not exceed that at 800 p. p. s. by more than 0.5 néper (4.3 decibel).

Although a more extended frequency range is covered by musical instruments, the present design of radio receiving sets does not warrant the expenditure on higher grades of circuit. Cable circuits, however, remain in service for a number of years and must, therefore, anticipate an improvement in receiving sets. The Standard broadcast circuits are arranged to transmit frequencies up to 7500 p. p. s. with the degree of distortion defined above.

DELAY DISTORTION

The provisional requirement is that the difference in transmission time of the highest frequency transmitted (6400 p. p. s.) and that at 800 p. p. s. should not exceed 10 milliseconds, while the deviation of the delay of the lowest frequency transmitted (50 p. p. s.) should not exceed 80 milliseconds.

By delay distortion is meant that the various frequency components of speech or music are delayed by different amounts in transmission over the circuit and, if this delay is excessive, objectionable distortion results. The phase distortion of the upper frequencies is caused by the lumped loading of the cable circuit, and that of the lower frequencies is due mainly to the transformers occurring in the repeater stations along the circuit. For circuits up to 1600 km. in length, phase distortion is not likely to be troublesome, and for longer circuits delay correctors can be added to equalise this form of distortion.

CIRCUIT ATTENUATION

The net loss of the circuit, measured between the output of the first repeater and the output of the last repeater, should be zero at 800 p. p. s. with a tolerance of 0.3 néper or 2.5 db.

The adoption of a zero net loss simplifies the switching of a number of circuits in tandem as the overall loss is independent of the number of links. In the Standard system the repeater gain

¹ Plenary Session, Paris, 1931, Section A. b. 3

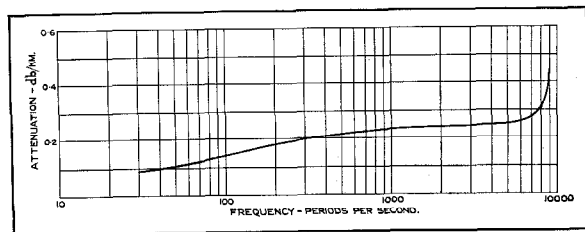

Figure 1—Typical Transmission Loss-Frequency Characteristic of 1.3 mm. H.15 Screened Pair

is made equal to the loss of the preceding line section including low frequency equalisers, so that the above requirement is automatically fulfilled.

LEVEL

The maximum power sent into a broadcast circuit should be such that the maximum voltage corresponds to a single frequency sinusoidal power of 5 milliwatts. At any point in the circuit the level should not exceed + 1.15 népers (10 db.) relative to that at the sending end of the circuit.

The considerations that fix the above maximum level are as follows: The level must never rise so high as to overload the repeaters or to cause disturbance to other circuits; on the other hand, it must not fall so low that, at points of the circuit where the level is a minimum, the interference due to extraneous sources is objectionable.

NON-LINEAR DISTORTION

The non-linear distortion in the system shall be such that spurious harmonics are at least 2.3 népers (20 db.) below the fundamental for the maximum power and for any frequency in the band effectively transmitted.

VOLUME RANGE AND LEVEL RELATIVE TO NOISE

The volume range to be transmitted without appreciable extraneous interference shall be 40 db. The lowest level at the receiving end of the circuit must be at least 20 db. greater than the level of noise.

Although the above range does not represent the full variation in volume, as heard directly from a full orchestra, it is the range which is satisfactory both from considerations of interference in the radio path and of the volume range capacity of radio receiving sets.

CROSSTALK

The crosstalk attenuation between lines used for broadcasting transmission or between one of these

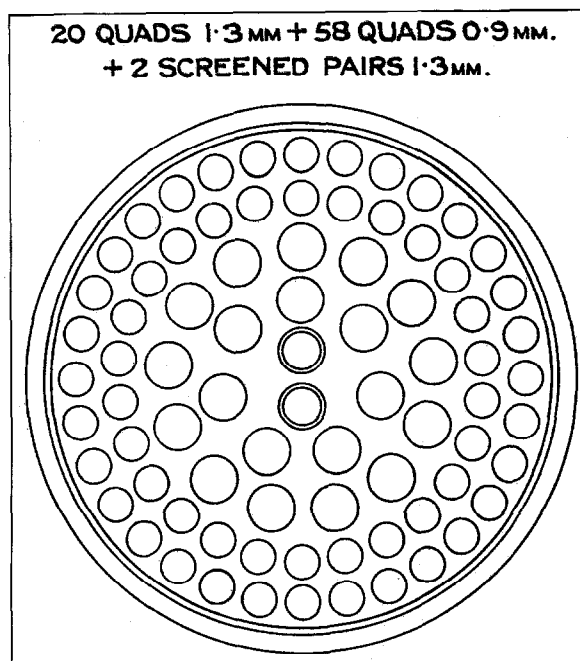

Figure 2—Typical Cable Lay-up Showing Location of Broadcasting Pairs

lines and a telephone line must be at least 9 népers (78 db.) for cable circuits and 7 népers (60.8 db.) for open wire circuits.

Cable Circuits

In order that frequencies up to 6,400 p. p. s. may be transmitted without meeting with serious difficulties in correcting for attenuation and delay distortion, the cut-off frequency of the cable should not be less than 8,500 p. p. s. To anticipate future improvements, Standard broadcast circuits are loaded to give a cut-off frequency of approximately 10,000 p. p. s. Loading coils having an inductance of 15 millihenrys are spaced at 1,830 metre intervals, the standard loading spacing for telephone circuits. Phantom circuits have been loaded with 9 millihenry coils for broadcasting purposes, but this type of circuit is not so generally used.

In the future, the cable cut-off may be raised still further if the quality of reproduction of radio apparatus justifies a wider frequency range.

A typical transmission loss-frequency characteristic of 1.3 mm. 15 millihenry loaded screened pair is shown in Figure 1. The average repeater spacing on these circuits is 80 km.

The volume range and the nature of the service which broadcast transmissions are required to

render make it essential that broadcast circuits should be as free as possible from crosstalk from other circuits in the cable and from power interference. The crosstalk due to capacity unbalance can be practically eliminated by shielding the broadcast circuit by a screen of tin foil or metalised paper, and the crosstalk from other unbalances can be reduced to a negligible amount by careful design. By these means a crosstalk attenuation per repeater section of about 13 népers (113 db.) is obtained between two broadcast circuits or between a telephone circuit and a broadcast circuit in the same cable.

Interference from power circuits is reduced by locating the broadcast circuits in the centre of the cable and by reducing the unbalances to the screen. A typical cross section of a cable containing two broadcast pairs is shown in Figure 2.

Repeater Requirements

The repeaters used in the system have been designed to meet the particular C. C. I. requirements² referring to broadcasting repeater units. These should not be confused with the requirements already stated for the complete system. The most important of the repeater requirements are as follows:

The maximum power output from the repeater without distortion must lie in the neighbourhood of 50 milliwatts.

The level of harmonics generated must be at least

3.2 népers (28 db.) below that of the fundamental for maximum power and for any frequency within the band of frequencies effectively transmitted.

The input impedance of the repeater must lie as close as possible to the line impedance, but the output impedance may have a value which is less than the line impedance.

The level of interfering noise must be at least 9 népers (78 db.) below the maximum level employed.

The crosstalk attenuation measured under conditions of service at the output terminals must be at least 10 népers (87 db.) between two repeaters used for broadcasting or between one of these repeaters and a repeater used for ordinary telephony.

Broadcasting Repeaters

The broadcasting repeater has been designed

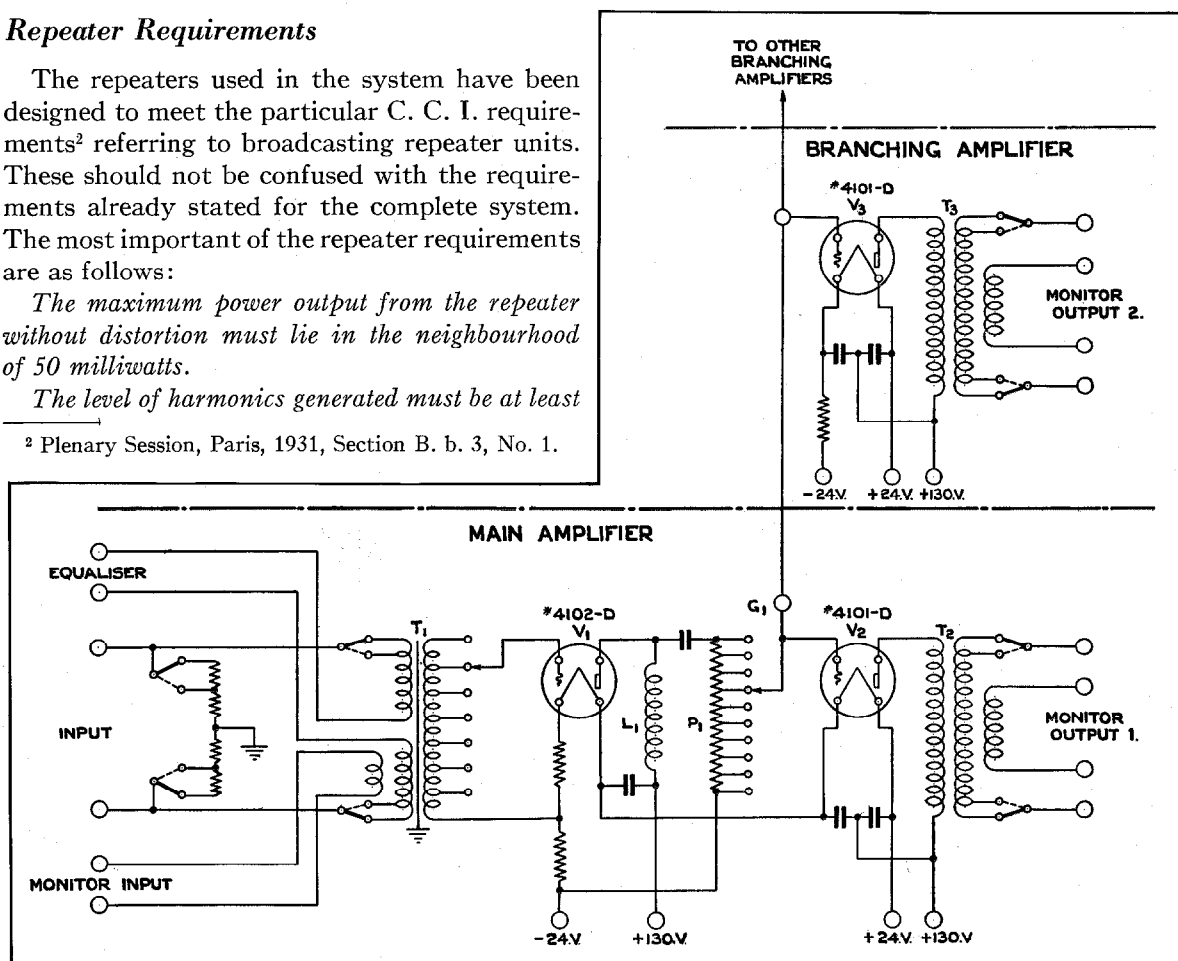

Figure 3—Schematic of Main Amplifier with Branching Amplifier Connected for Inter-stage Branching

² Plenary Session, Paris, 1931, Section B. b. 3, No. 1.

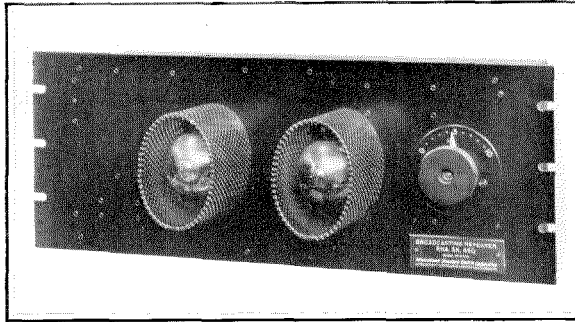

Figure 4—Front View of Main Amplifier

to operate from the same power supply as an ordinary four wire repeater, and requires a similar grade of maintenance. A circuit is shown in Figure 3 with a branching repeater connected. A photograph of the main amplifier is reproduced in Figure 4.

It will be seen from Figure 3 that the main amplifier consists of two choke coupled stages; the input circuit consists of an input transformer T_1 having a high impedance primary winding which, when shunted by the appropriate resistance, gives an impedance constant with frequency. Impedance tapplings are provided which enable the repeater to be used without repeating coils on 300 ohm or 500 ohm circuits, the full lines in Figure 3 giving 500 ohm input and output impedances and the dotted connections 300 ohm impedances. The use of repeating coils is preferred by some Administrations on the grounds that it simplifies the problem of switching in cases where the repeaters may be connected to a number of circuits having different impedances.

It will be noted that the primary winding of the input transformer is divided into two halves, each being brought out to terminals. The extra terminals permit the external connection of inductance in series with the winding as in the standard four wire repeater; this inductance provides means of giving the repeater a gain characteristic which rises with frequency, and so makes it capable of equalising the increasing attenuation of the cable at higher frequencies. The particular value of inductance required is governed by the high frequency attenuation characteristic of the line connected to the input of the repeater, and the appropriate value is therefore switched into circuit at the same time as any line is connected to the input.

The repeating coils, input and output transformers and the coupling chokes all have Permalloy cores. Typical gain frequency characteristics of the factory product, without the addition of tuning inductance, are shown in Figure 5; the maximum gain afforded is 4.1 népers (36 db.).

Gain adjustment is provided by tapplings on the secondary winding of the input transformer T_1 to give 6 steps of 0.5 néper (4.3 db.), and by tapplings on the grid resistance P_1 of the vacuum tube V_2 to give 9 steps of 0.1 néper (0.87 db.), the latter being controlled by a dial and the former by soldered connections to the transformer.

Branching

To permit the distribution of a single programme to a number of transmitters single stage branching amplifiers are employed. In effect, they convert the broadcasting repeater to an amplifier with a single input and any required number of outputs. Two types of branching amplifier are available, one having a power handling capacity of 50 milliwatts, and one having a power handling capacity of 250 milliwatts. Both operate from the same value of power supply voltage. The circuit of the 50 milliwatt amplifier is shown in Figure 3 and of the 250 milliwatt amplifier in Figure 6. A photograph of the 50 milliwatt branching amplifier is reproduced in Figure 7.

Two methods of branching are used:

- (a) Inter-stage branching is employed where a single programme is received from one circuit and has to be transmitted simultaneously to a maximum of five others.
- (b) Output branching is used where more than five outputs are required, and also where more than one programme is received in a station and each programme may be branched to any number of circuits.

In both cases the battery supply to each branching amplifier is individual and separate from the supply to the main amplifier so that any of the amplifiers can be switched on and off independently.

INTER-STAGE BRANCHING

This method has the advantage of simplicity and economy since n branching amplifiers can

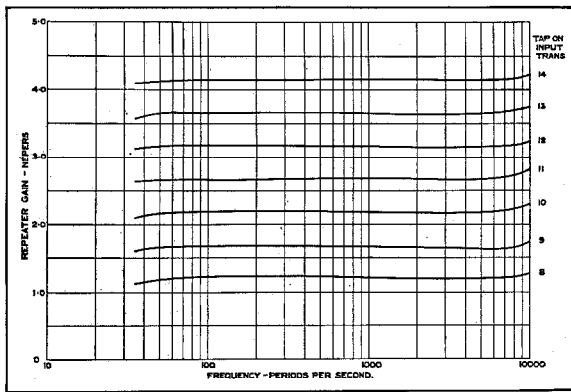

Figure 5—Typical Gain-Frequency Characteristics of Main Amplifier

supply $n+1$ lines, as the main amplifier also feeds one line.

It will be noted in Figure 3 that terminal G_1 is shown connected directly to the grid of vacuum tube V_2 . This terminal is used for inter-stage branching, further output stages exactly similar to that of the main amplifier being connected to G_1 , thus providing a number of outputs at the same level. The leads to terminal G must be made as short as possible in order to prevent capacity in the leads from causing undue loss at high frequencies. Terminal G_1 and its associated terminals on the auxiliary amplifier are therefore located in a vertical line and a short direct lead is run from panel to panel through special apertures in the dust covers. With this method of connection, four auxiliary amplifiers cause a drop in gain of 0.09 néper at 7000 p. p. s.

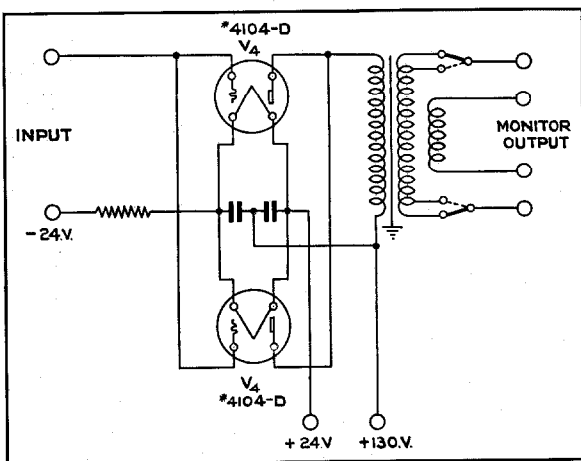

Figure 6—Schematic of Branching Amplifier Giving Output of 250 Milliwatts

owing to grid filament capacity. For this reason it is considered that not more than four auxiliary amplifiers should be connected in this way.

The necessity for short connections renders this system of branching comparatively inflexible on account of the inability to bring the grid connections out to jacks or keys for rapid changes in the case where two or more main amplifiers are used and the output stages may be associated with any main amplifier.

OUTPUT BRANCHING

The second method of branching is extremely flexible and universally applicable, since it caters for any number of programmes and any number of branches, either initially or ultimately. The system may be regarded as a development from the method described above, the main difference being that a circuit of comparatively low impedance (about 2000 ohms) is provided, from which the auxiliary amplifiers are tapped. This is achieved by a modification of the main amplifier, the output transformer being omitted and replaced by a choke feed (L_2) followed by a coupling circuit to the auxiliary amplifiers as shown in Figure 8. The output resistance P_2 is tapped and the tapping normally used is chosen so that the extra gain contributed by the branching stage is made to disappear. Other taps are, however, provided, and are intended to be used to give increased gain, either when it is required to load a high power branching amplifier more fully, or when the repeater follows a section of abnormally high attenuation. This increase in gain gives the combination a possible maximum of 5.1 népers (44.3 db.).

The connection to the point G_2 on the output coupling circuit shown in Figure 8 is now taken through the panel cable form and external cable form to jacks, whence it can be patched to any number of auxiliary amplifiers, as described below.

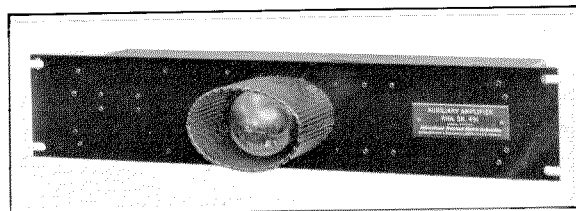

Figure 7—Front View of 50 Milliwatt Branching Amplifier

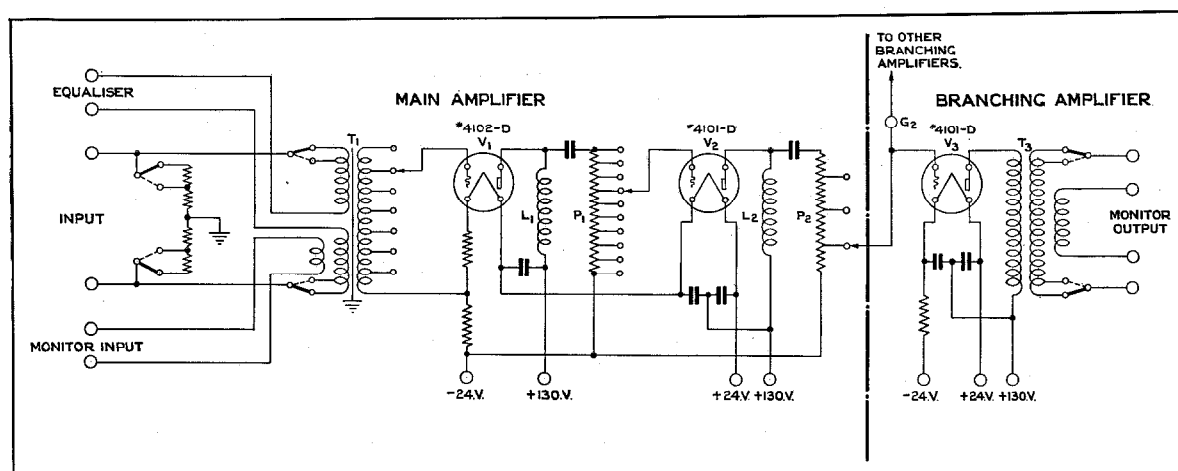

Figure 8—Schematic of Main Amplifier with Branching Amplifier Connected for Output Branching

Output stage branching also possesses a further advantage, since it has been found that, when the coupling between the vacuum tubes V_2 and V_3 is such that V_2 and V_3 both work into the same impedance and the amplitude of their inputs is equal, the even harmonics generated in V_2 are equal in amplitude and opposite in phase to those in V_3 , provided that similar phase rotation occurs in each coupling circuit. By selecting the vacuum tubes V_2 and V_3 in pairs, a reduction in harmonics is obtained.

It should be noted that the main amplifier shown in Figure 3 can be easily and quickly modified for output stage branching after installation by substituting for the output transformer the components constituting the output coupling shown in Figure 8.

Equalisation

With loaded cable circuits it is convenient to consider the cable attenuation as increasing at high frequencies, e.g., above 2,000 p. p. s., and decreasing at the lower frequencies, e. g., below 2,000 p. p. s. The methods for equalising the high and low frequency ranges are quite different. Compensation for the high frequency range is provided by a rising repeater gain, as in the case of the normal four wire telephone repeater, and the low frequency attenuation is increased by the addition of simple series equalisers.

A special case arises with non-loaded cable circuits due to the fact that the shape of the attenuation characteristic cannot be accurately simulated by the rising gain characteristic of

the repeater. The non-loaded cable equaliser is, therefore, of a type which provides equalisation over the whole frequency range transmitted.

Equalisers have been standardised for the circuits recommended and normally used for broadcasting, but for other circuits, where the loading, conductor gauge, coil spacing, etc., are non-standard, special equalisers must be designed for each separate case.

HIGH FREQUENCY EQUALISATION—LOADED CABLE CIRCUITS

An inductance is inserted in the middle of the repeater input transformer to secure the necessary gain rise and, resonating with the effective capacity across the secondary winding, it makes the repeater gain rise above the gain due to the turns ratio of the transformer. It is, therefore, truly an increase in gain and not an addition of attenuation, and so has obvious advantages. The required inductance is located externally to the repeater panel, so that it can be changed when the repeater input is connected to different lines. The repeater gain thus equalises the section preceding the repeater.

LOW FREQUENCY EQUALISATION—LOADED CABLE CIRCUITS

A special feature of the equaliser used is the very close impedance matching of the cable which is obtained at the receiving end by the use of an extremely simple network which combines the function of attenuation equaliser and impedance matching network. It is evident that it is only necessary to secure impedance match-

ing at the receiving end of the circuit since this effectively prevents all possible reflections.

At the receiving end of each repeater section there is located a series equaliser, A, shown in Figure 9. It has been found that a network of the type shown at A, when designed to build out the repeater to match the line impedance, gives almost exact equalisation for a certain length of circuit. A further network B is inserted at the sending end of the circuit in order to provide the additional attenuation necessary to equalise the complete section. The resistance and capacity elements of this network are made variable in order to cater for different lengths of circuit. As shown in Figure 8, the two portions of the equaliser are located between the balanced halves of the office winding of the line repeating coils at opposite ends of the circuit. When repeating coils are not used the equaliser has to be split, two exactly similar structures C of half the impedance being placed in series with each conductor of the circuit, as in the lower part of the figure, the variable portion corresponding with B being shown at D.

Figure 10 illustrates the degree of impedance matching which is obtained at the receiving end by the use of this type of equaliser; the dotted line is the impedance of 1.3 mm. H.15 pair and the full line is the impedance of the receiving equaliser used. It will be seen that extremely close impedance matching is maintained up to 6,000 p. p. s. and the deviation up to the limiting frequency to which the cable can be used is very small. In any case, reflections at the higher frequencies are quite unimportant because the cable attenuation is always high at these fre-

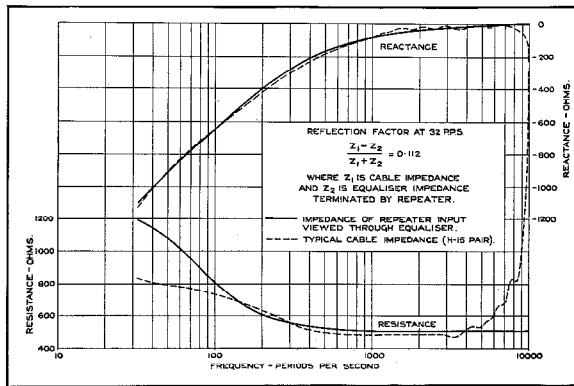

Figure 10—Typical Impedance-Frequency Characteristic of 1.3 mm. H.15 Pair and Associated Low Frequency Equaliser

quencies. Figure 11 shows a typical characteristic, obtained in practice, of an equalised repeater section.

NON-LOADED CABLE CIRCUITS

For equalisation of these circuits, a shunt type equaliser is usually employed and is bridged across the circuit on the office side of the line repeating coils at the receiving end of the line. This equaliser is arranged in the well-known form consisting of a resistance in series with a resonant circuit containing a condenser and retardation coil. The resistance is variable in steps to cater for different lengths of circuit, while the parallel resonance circuit is fixed and arranged for equalisation up to a frequency of 10,000 p. p. s.

Switching System

It is necessary to have available a rapid and flexible means of switching the programmes from one line to another.

The simplest switching operation occurs at an intermediate repeater station, where it must be possible to reverse the direction of transmission. The most complicated case is at an important junction where a number of land lines converge and where separate programmes are received from certain lines and must be distributed to other lines. The complexity of the problem may be appreciated by considering an example.

Suppose P is the junction point of a number of cable routes, as shown in Figure 12. At one

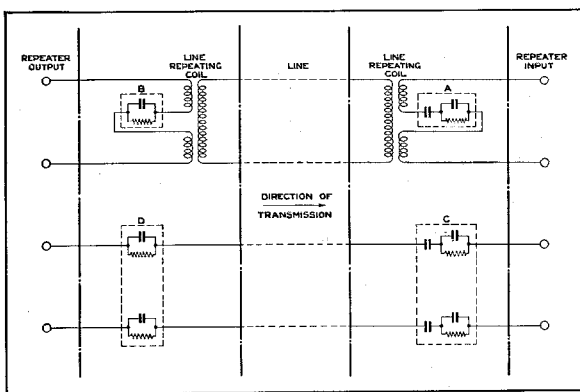

Figure 9—Diagram Showing Insertion of Low Frequency Equalisers

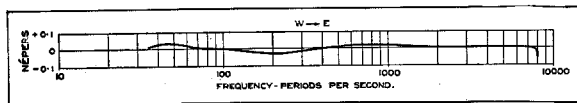

Figure 11—Typical Attenuation Characteristic of Equalised Repeater Section

period a programme may be received from A and distributed to D, E, and F, and some time later a re-switching may have to be done so that a programme received from G is sent to A, D, and C. In general, it must be possible for two programmes or more to be dealt with simultaneously.

As it is desirable that the broadcast transmitter should be worked at maximum efficiency, the line plant should be capable of fully loading the transmitter, without itself overloading. This condition must hold for all possible combinations of switched connections, and an important requirement which must be satisfied is that the amplifiers must deliver the same energy level to the circuit, irrespective of the other connections. Another requirement is that the equalisation of circuit attenuation must be maintained for all circuit conditions.

The simplest way of meeting these requirements is to build all line sections permanently

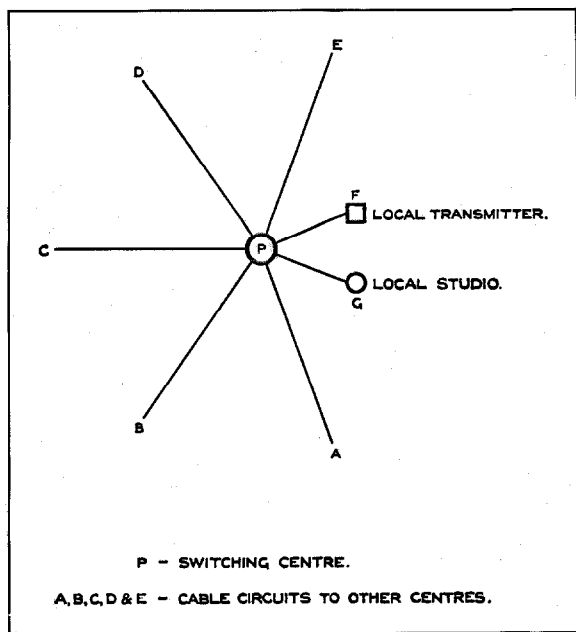

Figure 12—Diagram of Broadcasting Routes at an Important Switching Centre

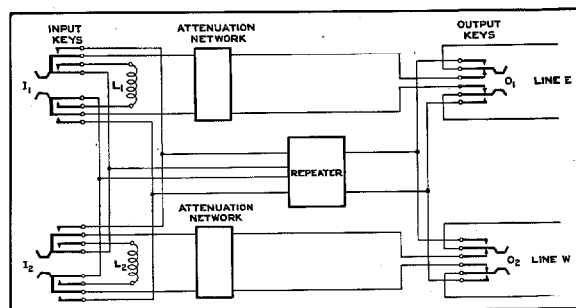

Figure 13—Switching Arrangements for Reversal of Direction of Transmission at an Intermediate Station

up to a fixed attenuation over the whole frequency range by artificial lines, so that in effect all line sections are the same. The disadvantage of this method is that for one direction of transmission the output from the amplifier may be attenuated before reaching the line, resulting in a less favourable relation between the programme level and noise. In the Standard system the principle applied is that the repeater gain should neutralise the attenuation of the preceding line section. The gain and gain characteristic is automatically varied to cater for different line sections.

The strict interpretation of this principle involves the provision of a low frequency equaliser at each end of a repeater section, the equaliser being switched in circuit when that particular end is in the receiving condition, but switched out when it is in the transmitting condition. In the Standard system the main low frequency equalisation is done at the receiving end of the circuit, as previously described. In many cases the noise level is sufficiently low to permit the reversal of the direction of transmission without interchanging the send and receive equalisers and, where this can be done, one set of equalisers can be associated permanently with the circuit and a saving thereby effected.

Figure 13 shows the switching means employed for reversing a repeater at an intermediate station. An input and output key is associated with the line in each direction. If transmission is to be from line E to line W, then keys I_1 and O_2 are operated. The output keys are of a special anti-crosstalk type to ensure that no coupling will exist between the input and output circuits.

Figure 14 shows a rather more complicated

case at a junction of three lines, 1, 2, and 3. A programme might be received from any of the three lines and have to be transmitted to either or both of the remaining two circuits.

An output key is associated with each line but when it is not operated the line is through to the input key via a pad, building the attenuation of the shorter lines up to the same value as that of the longest line. It will be noted that the pad is in the line only when it is connected to the input of the amplifier.

In addition, when a line is connected to the repeater input a tuning circuit, L_1 , L_2 or L_3 is associated with the repeater so that its gain characteristic equalises for the high frequency attenuation of the line.

The system can be built up to provide for more lines than three, but in a complicated case, especially when more than one programme has to be handled at a time, the facility for rapidly re-grouping the auxiliary and main amplifiers is necessary. Where output branching is employed it is permissible to connect the branching amplifiers to the main amplifier by means of plugs and cords. The switching scheme for a large station is shown in Figure 15.

It will be noticed that the lines entering the station are divided into three groups. Lines which are required for incoming and outgoing programmes (Figure 15-A) are brought through an output key. When the line is connected to the output of an auxiliary amplifier the programme is sent straight to the line, but when it is connected to the input jacks the pad is in-

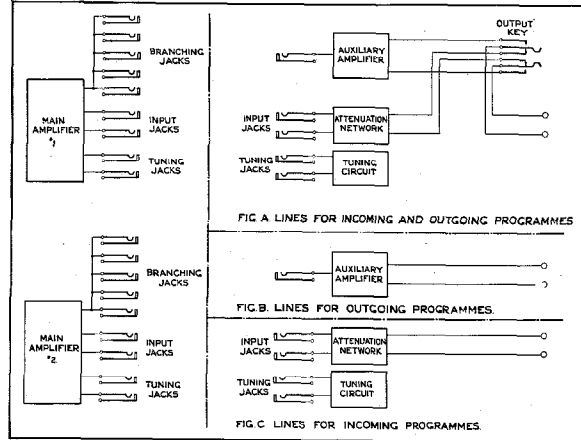

Figure 15—Switching Arrangements for Branching at a Station with a Large Number of Lines

cluded in the circuit. Figure 15-B shows a line intended for outgoing programmes only, such as a line to the local transmitter, and is connected straight to an output amplifier. Figure 15-C shows a line for incoming programmes only, such as a line to the local studio, and is equipped with a pad.

Considering the system indicated in Figure 12, the lines fall into the three categories as follows:

Class shown in Figure 15-A—Lines A, B, C, D, E.

Class shown in Figure 15-B—Line F.

Class shown in Figure 15-C—Line G.

These lines can be associated with the amplifier equipment in any desired combination and, whatever the arrangement, the amplifier will annul and equalise the attenuation of the line section which precedes it. The output of any auxiliary amplifier will deliver undistorted energy at a fixed level.

Switching means for the low frequency equalisers have not been shown. Where this is required the inter-change of the sending and receiving equalisers can be simply effected.

The arrangements described above give the maximum flexibility, and can often be simplified in particular cases. Keys can be employed in place of jacks and cords but, in a station with several main and a large number of auxiliary amplifiers, the number of keys necessary to give all possible combinations becomes unwieldy.

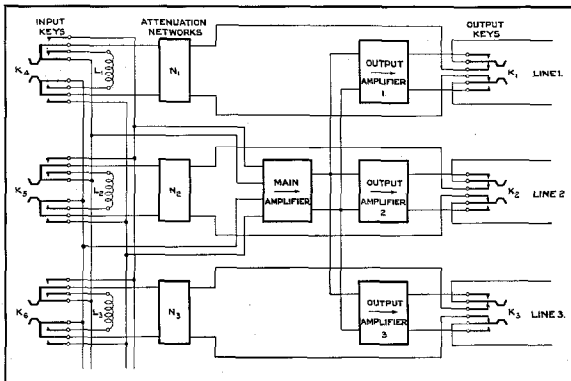

Figure 14—Switching Arrangement for a Branching Station with Three Lines

Teleprinter Network of the Berlin Police Administration

By POLICE CAPTAIN VOIT

Director, Technical Communication Bureau

BEGINNING with the year 1853, the Berlin Police Administration operated a Morse telegraph network including its own cable system. The apparatus was arranged in loops as indicated in Figure 1 which illustrates the oldest available sketches of this network.

With the tremendous growth of the city and the development of Greater Berlin, the system was no longer capable of adequately meeting the requirements of a modern Police Administration. In the earlier years experiments had been made to increase the capacity of the system by the use of the step-by-step ticker, teleprinters, and other apparatus. All of these experiments, however, led to no definite results since the apparatus employed therein was not sufficiently dependable. It was only with the further development of telegraph apparatus and especially the introduction of the start-stop principle in printing telegraphy that equipment was produced capable of meeting all the requirements as regards performance and reliability demanded by the Police. The advent of the Lorenz teleprinter in particular, which represents the most modern type of this group of start-stop apparatus, offered the opportunity to rearrange the telegraph network of the Police Administration. Even the early experiments proved conclusively that this apparatus provided a means for adequately meeting every requirement with the result that the Prussian Ministry of the Interior decided to provide the necessary funds for the installation of a modern teleprinter network.

System Development and Operation

While the type of apparatus to be adopted had become obvious, the problem of the network to be employed still required solution. Experience had shown that the operation of its own cable network by a modern Police Department was open to the objection of lack of flexibility in that every removal of a Police Service Station necessitated troublesome cable changes. In addition, maintenance costs were very high. It was decided, therefore, to make available a new

cable network by means of facilities which were to be leased from the Reichspost and which could be modified or partially discontinued on short notice. The old loop system, moreover, was felt to be entirely inadequate under modern conditions inasmuch as it was essential that any teleprinter should be capable of being connected promptly with any other teleprinter in the network exactly as in the case of a modern telephone system. Obviously also, the new network would have to be designed to correspond closely with the organization of the Police Department.

The teleprinter network finally adopted is illustrated in schematic form in Figure 2. The central exchange is located at Police Headquarters and is equipped with ten local teleprinter stations and forty trunk lines as well as interconnecting switching means whereby messages may be transmitted to a number of stations simultaneously. In addition, the central switchboard has facilities for direct printer connection with the Telegraph Headquarters of the Reichspost and with the Fire Department.

At the present time the Headquarters' Teleprinter Exchange (Figure 3) is connected with fifteen sub-exchanges of the various police divisions and inspectors' offices. Wherever the division and inspectors' offices are not adjacent, these offices are interconnected by means of special trunks. The switchboards of the inspectors' offices are provided with two or three local teleprinter stations and are connected with the stations of the police beats and the patrol booths of railway stations which at present total 247.

A view of a division or inspectors' teleprinter exchange is shown in Figure 4. As in the case of the Headquarters Exchange, provision is made for establishing individual or group connections. Thus, an inspector may transmit an order simultaneously to the patrol booths of all beats or an important message may be communicated from a patrol booth on a beat to all other booths of its and neighboring districts. Similarly, a message may be sent from any service station of the entire network to all other service stations, though this

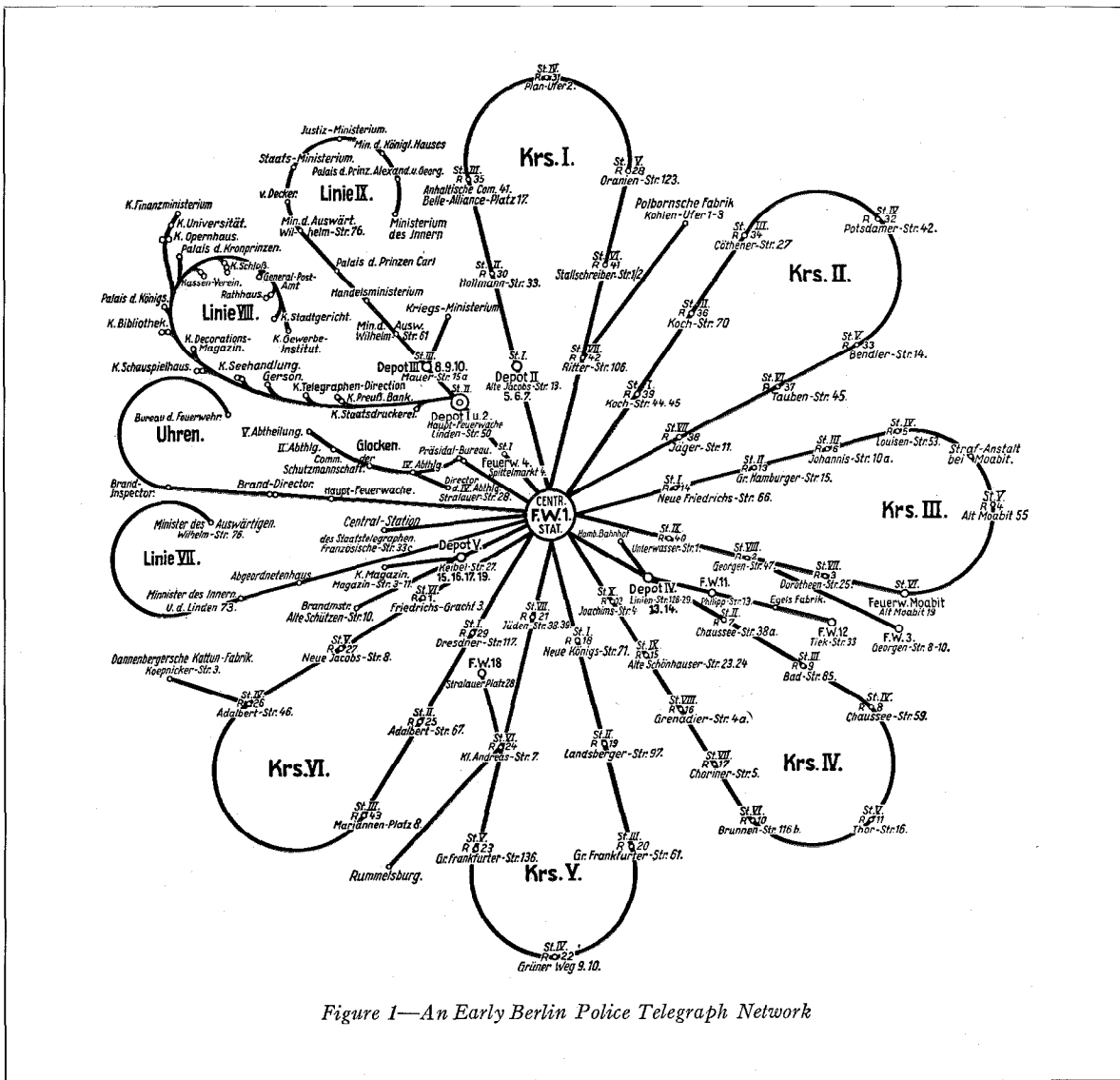

Figure 1—An Early Berlin Police Telegraph Network

type of communication ties up the entire network and obviously should be made use of only in cases of extraordinary importance. Usually, moreover, a general alarm should go out from the Headquarters Exchange which is equipped with a high-speed transmitter so that the network may be free with maximum dispatch for the more ordinary traffic. Such general alarm messages are perforated on a tape which passes through the transmitter at a rate of 360 letters per minute. Figure 5 shows the arrangement of a speed transmitter such as is used at Police Headquarters.

For the preparation of general alarm messages, about two minutes are required. In view of the

fact that any such messages transmitted from headquarters to the other exchanges or stations contain information of the utmost importance, a record of the exact time of transmission with consequent fixing of responsibility within the entire organization of the department is absolutely necessary. This can be accomplished in a simple manner by means of an automatic timing device for sending out time signals just before and after the transmission of the message.

In addition to the normal telegraph service, a so-called "subscriber's service" has been inaugurated. Formerly it was necessary for the sender to prepare and write the message and send

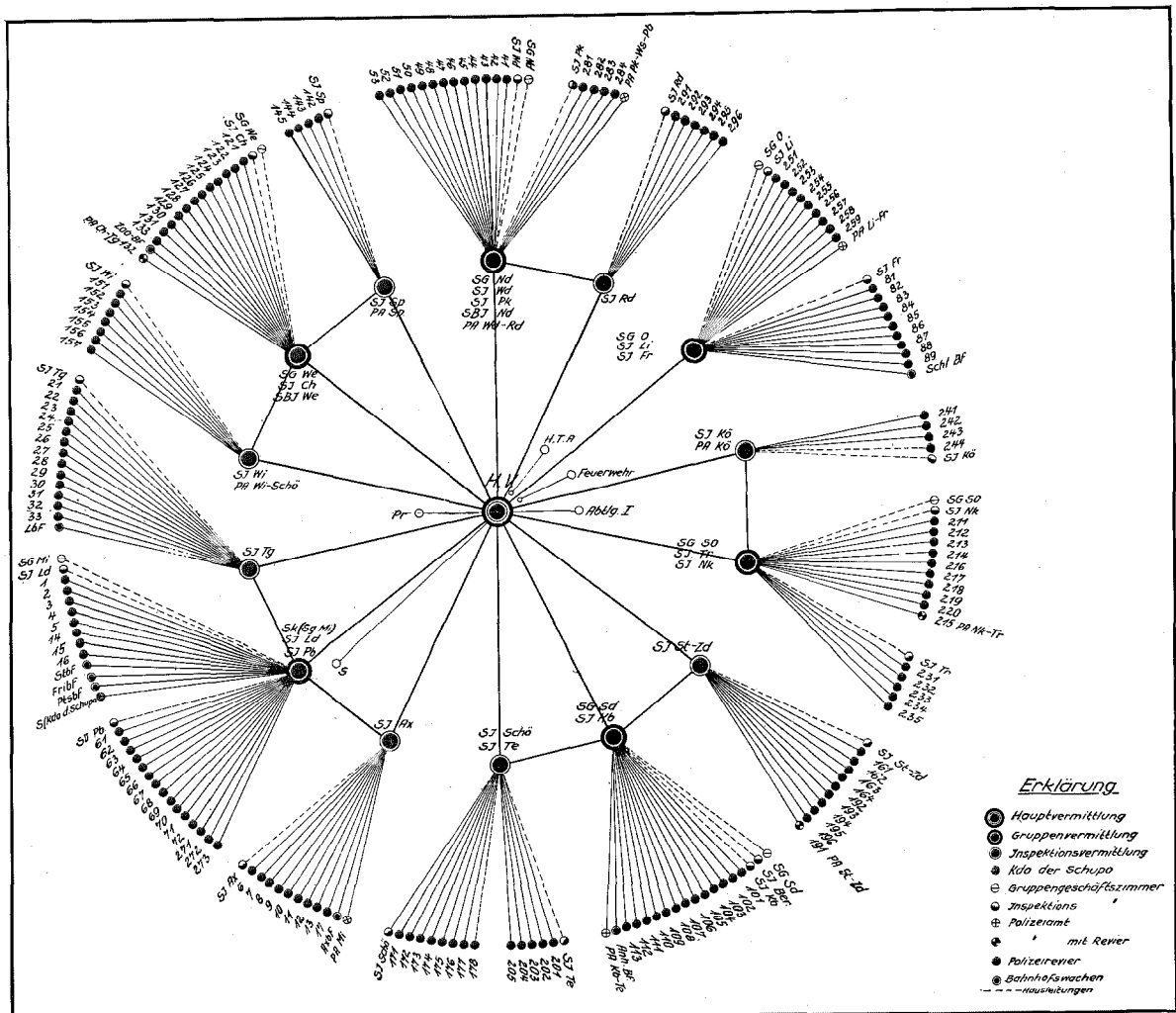

Figure 2—The New Berlin Police Teleprinter Network

it to the office for copying and forwarding by messenger to the telegraph office where it was in turn telegraphed to the receiving station for delivery. Today the message merely requires typing on the teleprinter and is reproduced at the receiving office directly in typewritten form. Teleprinters have been installed also at other important service points, for instance, in the press room and the headquarters receiving desk. Inasmuch as the system makes possible a considerable saving in time and labor, it is planned to expand it in the near future.

When sending the foregoing types of messages, it is the practice to retain at the sending office the recording tape for record purposes. While it is possible to employ duplex methods whereby

messages may be exchanged between two stations simultaneously with consequent doubling of message capacity, simultaneous operation is open to the objectionable necessity of dispensing with the home record tape. The original record of the message may be dispensed with in private communications but it is of great importance in the police service.

Traffic over the teleprinter network is handled by twenty-four men and is very heavy. The Headquarters Exchange alone receives a monthly average of about 7500 messages, transmits about 3200, and establishes about 4200 cross connections.

A not unimportant factor in this heavy traffic volume is the logical and exceptionally conve-

nient arrangement of the keyboard of the teleprinter machines. As is customary with most telegraph companies, the keyboard has been arranged in the well-known three row form. If necessary, any interchange of traffic with other communication services employing different apparatus such as the Reichspost, can be effected without difficulty due to the fact that the Lorenz teleprinter has been equipped for use with an international telegraph code recognized by the International Consulting Committee on Telegraph Communications (C. C. I. T.). Another reason why Lorenz teleprinters give good results is that the different operations involved in sending, receiving and printing are carried on by strictly mechanical means. Notwithstanding the heavy volume of traffic handled, only minor repairs have been required. A special advantage obtained with these machines is that they permit the recording of messages in the absence of the receiving operator. Previous to their adoption, all precincts and telegraph service stations required the services of three specially trained operators, making a total of about 1,000 telegraph operators throughout Berlin while today the person on duty also performs the duty of operating the teleprinter. In order that the machine will not require an operator's undivided attention, it has been provided with a signalling bell which is controlled from the sending station.

In general, the Berlin Police Administration employs Lorenz tape printers almost exclusively. The printer tape is pasted on forms as is also the practice of the Reichspost. When page printers are used, the messages, however, are recorded directly on the finished form or page. These machines are consequently preferable where messages must be transmitted to all stations simultaneously for the information of a considerable number of individuals. The page printer has the additional advantage of being able to reproduce at the same time a greater number of copies of the message, thus making it possible to supply various individuals or offices in the same building with messages produced simultaneously on the same machine.

Since both machines operate on the same principle, they may be employed at random in the same network so that in this respect also the teleprinter meets all the special requirements of the police service. Technical details and special features of these machines are referred to in the following paragraphs:

Machines

The construction of the Lorenz start-stop teleprinter is based on the latest design principle. In addition to its extreme simplicity of construction and compactness as regards space

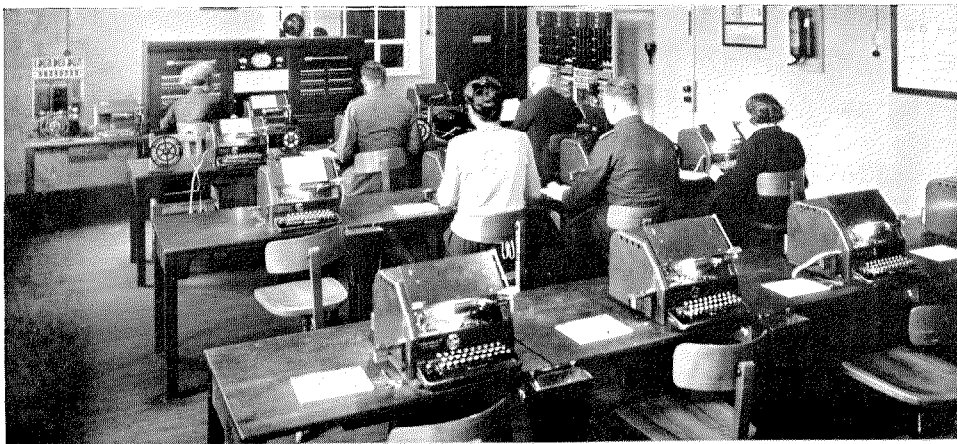

Figure 3—The Berlin Police Headquarters Teleprinter Exchange

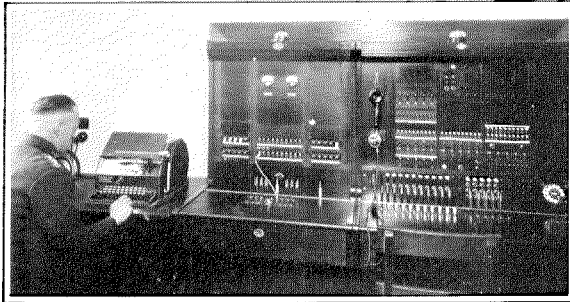

Figure 4—A Division or Inspector's Teleprinter Exchange



Figure 5—Automatic Transmitting Device at Berlin Police Headquarters

occupied, these machines have the advantage of not requiring a more or less complicated synchronizing mechanism.

The transmission of signals between two interconnecting machines is effected by electrical impulses which follow consecutively according to a pre-arranged scheme which involves different series of impulses representing letters or numbers and which is called a telegraph code. The Lorenz teleprinter employs the internationally recognized C. C. I. T. five-unit code arranged by Murray (Figure 6).

The start-stop principle implies non-continuous operation of the sending and receiving mechanisms which are started and come to rest just before and after the transmission of each letter. Since five impulses are required for transmitting a letter or signal proper plus the start and stop impulses, each signal involves a total of seven separate impulses. The start and stop impulses are always the same but of opposite sign. The speed of operation of the apparatus is 360 characters per minute with a maximum of 420. As mentioned previously, the speed is auto-

matically maintained, and the sending and receiving machines are kept in synchronism by means of centrifugal governors.

The transmission of a letter or sign is accomplished by depressing the key of the sending mechanism which causes the setting of five selector bars according to the predetermined series of impulses required. Depressing the key also starts rotation of the sending motor and causes closing of contacts corresponding to the setting of the

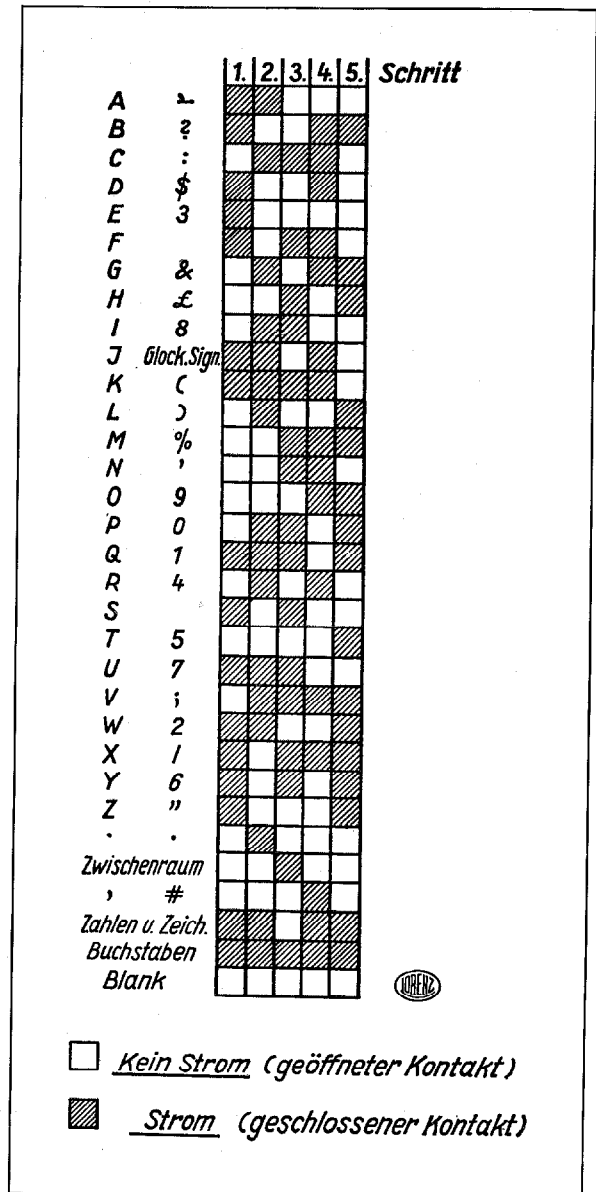

Figure 6—Five-Unit Murray Code

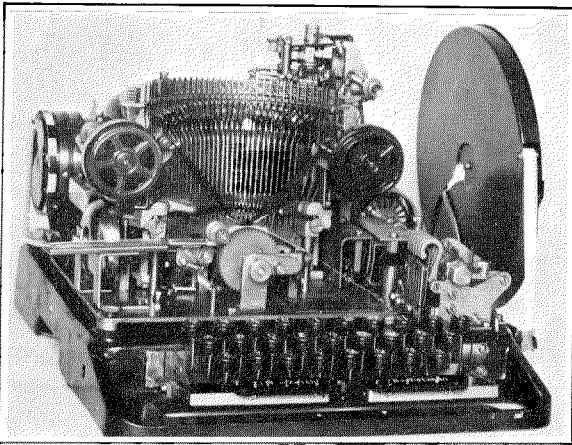

Figure 7—Lorenz Tape Teleprinter With Cover Removed

selector bars with the result that the required impulses are sent out over the line. At the receiving end the arriving impulses cause the operation of a magnet and the rotation of a cam shaft in unison with the sending teleprinter. These cams strike an armature extension and register the position of the armature, i.e., whether operated or not operated, according to the impulses transmitted, by means of selecting arms which in turn bring about the selection of a type lever and the printing of its associated letter.

The sending and receiving shafts are driven by a common motor which may be operated from any power network. With this arrangement the time required for sending and receiving a letter will be the same. Other features include the calling of the receiving station by means of a bell, a paper control device equipped with an audible signal and remote control of the driving motor from the distant end. While older types of telegraph apparatus employed rolls of felt soaked with ink for the purpose of supplying ink to the type face, the new teleprinter follows ordinary typewriter practice in that the ink is supplied by means of a ribbon, a method which produces a clearer and more even imprint. As in the case of a typewriter also, the ribbon feeding mechanism is equipped with an automatic reverse device.

In addition to these features which refer mainly to the operation of the tape printer, a number of special devices have been incorporated in the construction of the page printer as, for example, devices for carriage returning and line feeding.

It is now possible to reproduce a large number of copies which may be fed from a paper roll or in manifold forms which remain in their correct position so that even printed forms can be properly filled in.

So far as operating requirements permit, the Lorenz tape printer and the page printer employ identical parts, the entire sending mechanism and a large percentage of the parts comprising the receiving mechanism being the same in both machines. In a large teleprinter network, this correspondence of parts obviously greatly simplifies the maintenance problem as well as the stocking of supply parts, since a combination of the two types of machines in the same network is frequently desirable. For example, some messages may have the character of telegrams intended for individuals and may best be handled on the tape printer. Others may be urgent and of general interest to a number of persons and may best be handled by the page printer.

The tape printer as used by the Berlin Police Department is shown with the cover removed in Figure 7. Figure 8 depicts the page printer.



Figure 8—Lorenz Page Printer

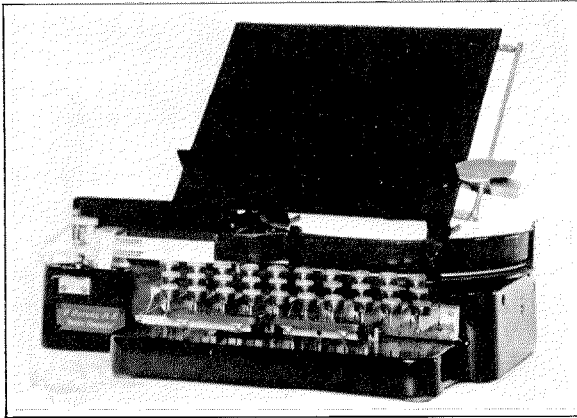

Figure 9—Tape Perforator

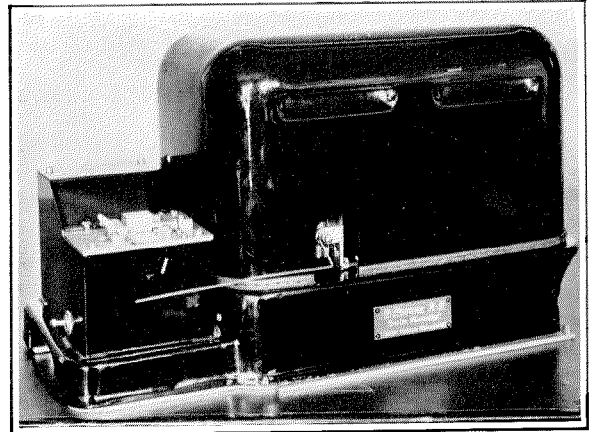

Figure 10—Automatic Transmitter

Figure 9 illustrates the tape perforator. It permits messages to be prepared for automatic transmission on a perforated tape. By pressing a key lever the perforator dies are placed in position corresponding to the previously mentioned 5-unit code. After perforation, the tape is run through the automatic transmitter,

Figure 10, which transmits the corresponding current impulses to the line by means of contacts made through the tape perforations and a suitably arranged distributing disc. Like the teleprinter, the speed transmitter is driven by a motor operated on power current and equipped with a speed regulator.

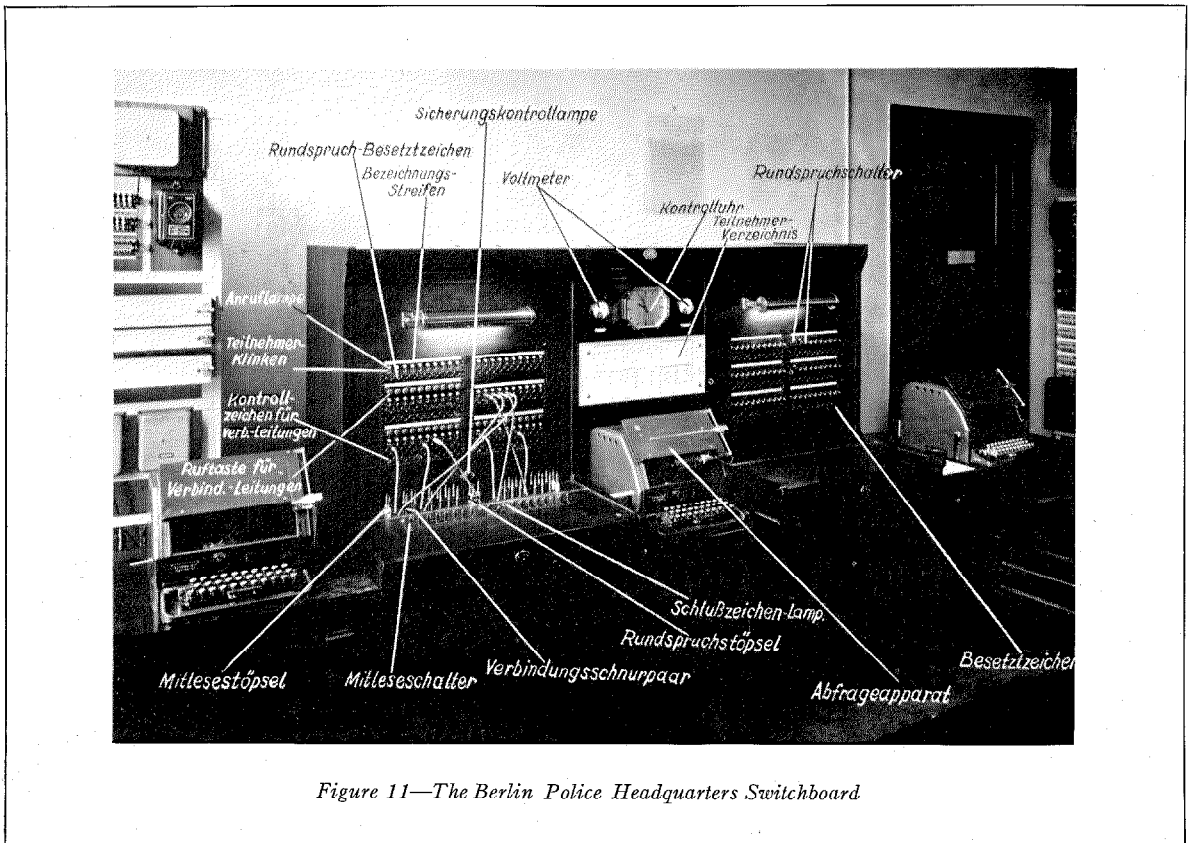

Figure 11—The Berlin Police Headquarters Switchboard

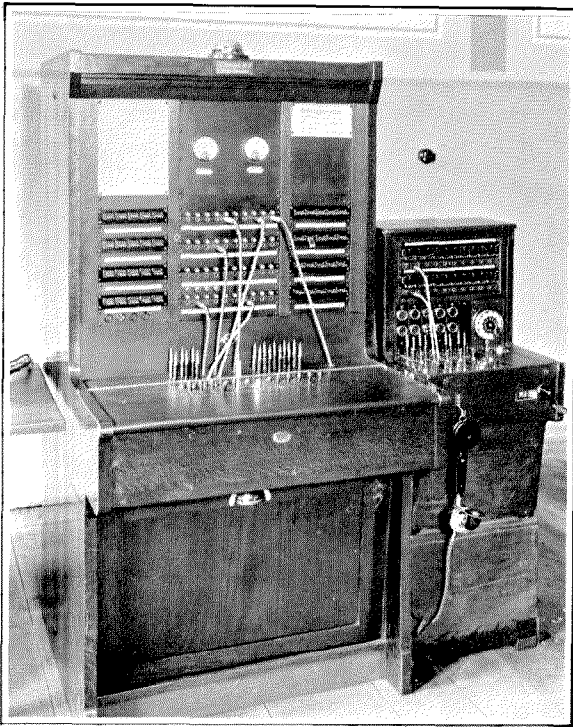

Figure 12—The Berlin Police Sub-exchange Switchboard

Exchange Equipment

The equipment of a teleprinter exchange is similar to a telephone exchange in its general aspects. Two different types may be employed, the manual and the automatic exchange. The latter embodies the latest developments in telegraph engineering but the manual system has the advantage of adaptability and flexibility. Due to the organization of the Police Department, the question of personnel is not a difficulty, since the operators serving the telephone exchange are also available for attending the teleprinter exchange. Furthermore, the factor of adaptability is of special importance in the police service so that manual operation is preferable under these conditions. While it might be thought that manual operation of a teleprinter switchboard would be slower than that of a telephone exchange, experience has proven that such is not the case.

Corresponding to the organization of the Police Department, the teleprinter exchange system, as previously indicated, consists of one principal or headquarters exchange and fifteen sub-exchanges. The headquarters switchboard is

shown in Figure 11. The sub-exchanges are connected with the principal exchange by trunk lines. The 260 police stations can be reached through these sub-exchanges over subscribers' lines. Traffic within an inspector's district is conducted through the sub-exchanges. When connection is to be made with another inspector's district, it is established through the principal exchange but in order to relieve the trunk lines between the principal exchange and the districts, direct cross connections have also been made between the different inspectors' bureaus. The fifteen trunk lines extending from the principal exchange to the sub-exchanges serve also for broadcast purposes. Arrangements are such that broadcasting can also be effected on a more restricted scale within the different inspectors' districts.

The two sections of the principal switchboard, Figure 11, have been equipped respectively for individual and message traffic and for broadcasting, the left section serving the individual and message traffic. The trunk lines, which are equipped with a calling lamp and a ringing key,

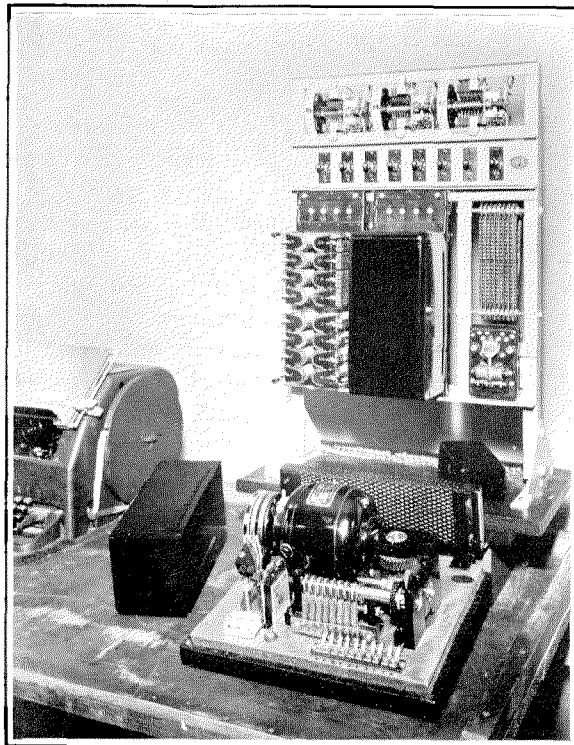

Figure 13—Time Signal Indicator

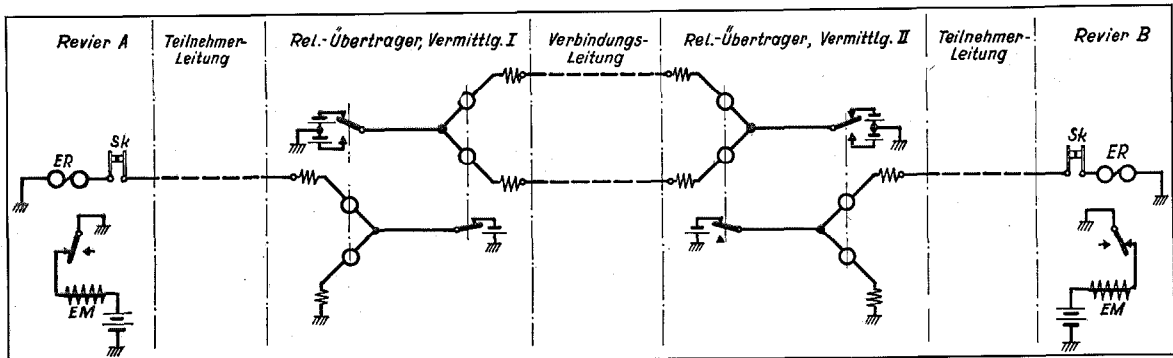

Figure 14—Diagram of Trunk Circuits

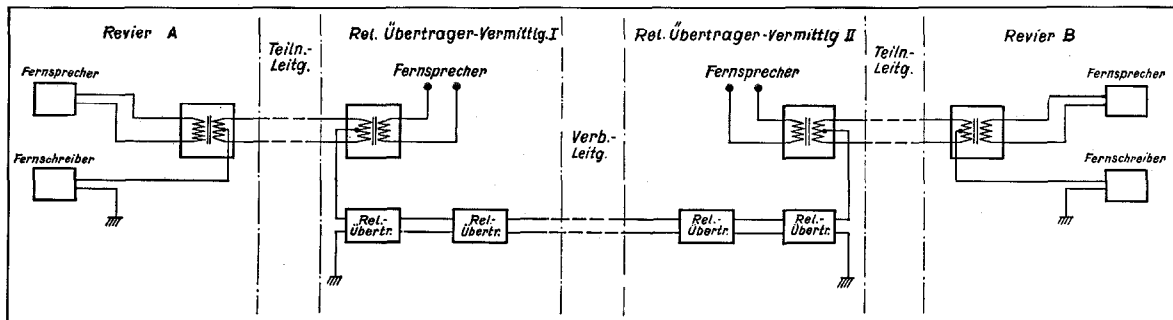

Figure 15—Circuit Diagram for Simultaneous Operation

are terminated by jacks. Each trunk is also furnished with a signal for supervising the teleprinter traffic.

The key shelf is equipped with pairs of connecting cords and plugs for broadcast connections. Each cord circuit is furnished with a control switch and a clearing lamp. The section at the right is provided with lever switches and broadcasting supervisory control lamps for each line. A battery voltmeter and an electric clock are installed in the center position. It will be noted that the operator's teleprinter machine has been placed in the center of the switchboard and built into the key shelf.

For technical reasons two calling methods are employed. Calls from subscribers' lines to the central exchange are effected by means of the 24 volt telephone battery with which each sub-exchange is equipped. Calls over the trunk and tie lines require 50 cycle alternating current. Where the alternating current is furnished from a public supply network, a transformer is used.

Where direct lighting current is employed, a rotary converter is used for conversion to alternating current.

A call coming over a trunk line lights up the respective calling lamp. By means of a pair of free cords, a disengaged machine may be connected with the trunk line thus automatically starting the motors of the two teleprinter machines. On instructions from the calling party, a connection is established using the same pair of cords.

To facilitate the reception and supervision of calls, a machine that is not otherwise engaged may be plugged into the circuit. After termination of a message, i.e., thirty seconds after the last telegraph impulse is transmitted, the clearing lamp flashes. By removing the plugs from the jacks, the connection is terminated and the driving motors of the two machines are brought to rest. Broadcasting connection is also established in the manner just described.

The automatic speed transmitter is connected

into the circuit the same as a subscriber's line. Traffic in the sub-exchange is handled in the same manner as in the headquarters exchange. The switchboard is illustrated in Figure 12 and is naturally much smaller than the principal exchange. The necessary telegraph relays and broadcasting cascade relays are mounted on special relay racks which also carry the necessary fuses, protectors, testing, and supervisory devices.

Figure 13 shows a time signal indicator which consists of selectors and relays and which transmits the time automatically as required in the form of a series of electrical impulses.

Line Engineering

For the transmission of telegraph signals over the comparatively short local lines of the Berlin Police network, direct current telegraphy is employed. Over lines between the inspectors' bureaus and the police stations "single" current, namely, signals comprising current and no current intervals, is used. Double current working is used in connection with the operation of trunk and tie lines (Figure 14). These have the advantage that the distortions are kept so small that they do not prevent satisfactory operation over a great number of relay repeaters.

While the trunk lines and tie lines are usually run as 2-wire circuits and serve merely for transmission of a telegraph message, the lines connecting the inspectors' bureaus with the police stations are simultaneously operated (Figure 15), both for telephone and telegraph service.

Simultaneous operation has the economic advantage that a second telephone channel is established with a resultant saving in line rental

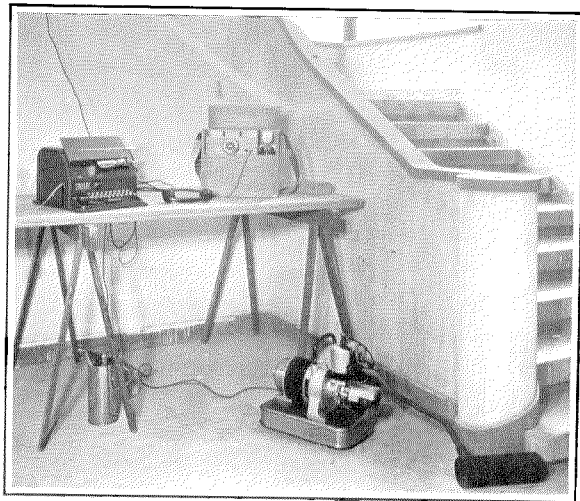

Figure 16—Portable Teleprinter Installation

charges. The additional equipment is comparatively simple, merely consisting of a line transformer which in the case of permanent teleprinter lines is mounted on special racks. In the case of temporary teleprinter installations, the additional equipment is provided in portable boxes, as illustrated in Figure 16, which shows a portable or "flying" teleprinter station.

Where ground connections cannot be used because of the danger of high tension voltage through ground return or for other reasons, a voice frequency telegraph system can be used. This system, as its name indicates, employs a voice frequency carrier on which the telegraph impulses are superposed. Included in the necessary equipment is a voice frequency generator at the transmitting end, and a rectifier at the receiving end.

The 7-D Rotary System for Small Communities

By W. HATTON

International Telephone and Telegraph Laboratories

PROGRESS in the design of automatic telephone systems for small communities has not yet reached the point where further advance is restricted to the slow process of refinement now seen in the design of systems for urban networks. As recently as 1926, automatic telephone equipment for small communities was of a relatively simple nature, and only provided for the automatic completion of local connections. All outside connections were directed to an operator at the nearest toll or manual exchange. Present day requirements, however, are such that equipment for small communities must be capable of automatically completing connections over a wide area, including connections to and from the nearest large city.

Outside the limits of most large cities there are suburban districts which require rapid means of communication with the city. Many of the residents have their business or employment in the city and, to some extent, persons living in the city are employed in the suburbs. Manufacturers frequently find it economical to locate their offices in the city, and to find a site for their factories at some distance from the city, where ground rents and taxes are usually lower. In many cases this community of interest factor is not limited to the suburbs proper, but may include neighbouring smaller towns as far distant as 25 kilometres. Under these circumstances, it is natural to assume that most of the telephone traffic is to and from the city; in fact, experience shows that these connections are usually between 80% and 90% of the total, and rarely fall below 60%. It is evident that for this nature of telephone service, the type of equipment which restricts full automatic service to the small percentage of local connections, and requires the assistance of an operator for connections to and from the city, is neither suitable nor economical.

In 1928, Les Laboratoires L. M. T., Paris, commenced the design of a system (since named the No. 7-D Rotary System), which would enable small communities to be connected automatically with their parent city, and with each other. This

system is now in operation in Switzerland, Italy,* Czechoslovakia, and is being manufactured for Holland, Belgium, Luxembourg and other countries. In the design of the system, the two most important problems to be solved were: first, the tariff system to be adopted, and the method of recording the number and duration of connections per subscriber; second, the system of numbering to be followed enabling the large number of small exchanges frequently found in this type of network to be economically connected together.

This paper outlines very briefly the main features of the 7-D District System. At a future date it is planned to publish further information describing networks which have been placed in operation.

Metering

The metering or registration of the connections is particularly interesting because, with the elimination of the operator, it follows that such registrations must be made on the subscriber's service meter, and that to account for both distance and time, the meter must be operated a number of times per connection. It follows, therefore, that no record of such individual connection can be retained, as was the case where all connections other than local passed via an operator, and were "ticketed." Administrations have therefore no means of checking subscriber's complaints, and for this reason in some cases hesitate to dispense with the operator.

Another difficulty which arises with the introduction of time and distance metering is when a certain number of local calls are given free of charge, and all outgoing calls are charged on a time and distance basis. A third case is when the fee for outgoing connections is not a multiple of the fee for local connections, e.g., a local call might be 25 centimes, time unlimited, and an outgoing call 70 centimes for each period of three minutes.

* Rapid Toll, Suburban and Rural Automatic Telephone Services in Tuscany, by L. A. Zanni, *Electrical Communication*, April, 1930.

The first difficulty can be overcome by installing at the subscribers' premises, meters which are operated over the line, either during or after conversation from the time and distance metering apparatus in the exchange, and which indicate to the subscriber the amount spent on each connection. Such meters are particularly useful in hotels where it is necessary to debit the cost of the connection to the hotel guest. In the second case, two service meters can be installed per line, the first indicating the total number of local connections, and the second the number of units spent on outgoing connections. The third case can be solved in the same manner.

A scale of payment with a unit fee for local connections and a multiple of this unit for outgoing connections is, however, clearly the correct solution. The calculation of a unit which will prove satisfactory to the subscribers and at the same time will not involve any loss of revenue to Administrations can sometimes be simplified by taking into account the length of time permitted on outgoing connections. Although three minutes is the general length of time at present in force, there is no reason why it should not be three and a half, or four minutes. A graduated scale decreasing with each successive period of three minutes is also possible, without unduly complicating the time and zone metering apparatus.

Another point is that the reduced rate usually given during certain hours of the day must also be a multiple of the unit fee. Despite these apparent drawbacks the public invariably favours the installation of full automatic equipment, and the increase in the number of new subscribers following its introduction proves the appreciation of a twenty-four hour no-delay service. Encouraged by these results, Administrations are now planning national full automatic service with subscriber-to-subscriber dialling, with time and distance metering on both short and long haul toll connections.

The 7-D Rotary system is arranged to give six classes of metering, local calls being metered once and unlimited in duration. As one example, outgoing calls may be metered 2, 3, 5, 7 or 10 times for each three minutes. The duration of other than local connections may be limited to a maximum of 6, 9 or 12 minutes, and 10 seconds

before the expiration of this time, a warning tone is given indicating the approach of the time limit.

The repeated metering is made dependent on the air line distance separating the two exchanges. For this purpose metering control circuits in the exchange where the connection is originated, take a record of the first two or the first three digits of the dialled number. By this means the identity of the distant exchange, and therefore the class of metering, are determined. One example of the application of this method of time and distance metering is as follows: Connections remaining within a radius of 5 kilometres, defined as the "office area," are metered once, and are unlimited in duration; connections outside the office area, and within a radius of 10 kilometres are metered twice; between 10 and 20 kilometres, three times; between 20 and 30 kilometres, five times; between 30 and 50 kilometres, seven times; and between 50 and 100 kilometres, ten times. All connections outside the office area are metered at the beginning of each three minute period.

The metering control circuits referred to above include a step-by-step switch on which there is provided a terminal for each exchange in the area. By recording sufficient digits of the dialled number, the step-by-step switch is positioned on a terminal which corresponds to the distant exchange, and which is used to select the appropriate class of metering. The six classes of metering are not necessarily fixed at 1, 2, 3, 5, 7, and 10, but can be varied to suit the currency and tariff of the country, and, for example, might be 1, 2, 4, 6, 8, and 10. The system of metering is therefore extremely flexible, and the difference between this method and methods of dividing the area into definite groups of exchanges, or definite blocks of numbers forming zones, should be carefully noted.

Numbering

When planning numbering schemes, both the physical and industrial characteristics of the country must be considered. Certain countries, by reason of their lack of physical unity, or because of well defined centres of industry, are readily divided into conveniently sized telephone networks. In other countries, due to overlapping of urban areas, the formation of distinct net-

works cannot be accomplished if the numbering scheme is to be kept within reasonable dimensions. Three systems of numbering are available:

The first, termed "closed" numbering, includes the urban, suburban and rural exchanges of the network in a uniform numbering scheme without prefixes, all the exchanges in the area thus forming a homogeneous switching unit. Closed numbering is applicable to countries permitting the formation of well defined areas. This method requires careful planning beforehand, and estimation of reserve capacity, since unexpected growth in any one sector is capable of reacting on the whole area. It has, however, the extremely important advantage of reducing to the minimum the number of digits to be dialled by the subscriber, with a corresponding increase in the efficiency of the equipment since the conversation time forms a greater percentage of the total holding time. Further, a numbering scheme permitting subscribers to complete connections inside the network by simply dialling the wanted number is generally preferred to schemes employing office selection by prefix with or without a second dialling tone.

The second is a prefix system of numbering termed "open" numbering, each exchange being designated by a prefix consisting of a letter followed by two or three numerals. Where automatic connection between different networks is provided, three numerals are required, the first indicating the network, the second the sector, and the third the exchange in the sector. For local connections it is not necessary to dial the prefix. This method of numbering is applicable to countries where self contained networks cannot be formed easily, or where the percentage of local traffic is high. That the capacity of any one exchange is independent of the rest of the area, is admittedly an advantage, but on the other hand, with exchanges in the environs of large towns, where most of the calls are to and from the town, the dialling operation on such connections becomes too complicated. For example, connections to town exchanges with 5-digit numbering demand dialling nine times, viz., the prefix with its letter and three numerals, followed by the five numerals of the town exchange subscriber.

The third method is a mixture of open and

closed numbering, the closed being retained for connections remaining within the network, and open for connections to other networks.

Junction Layout

In urban areas it is common practice for a number of main central exchanges to be connected together with direct connections, but in suburban and rural areas where distances are greater and junction groups smaller, it is clearly not economical to provide junctions between each exchange and every other exchange in the network, or between a central exchange and every other exchange. In manually operated suburban and rural areas, direct junctions between exchanges are a necessity. These junctions are generally operated at very low efficiency, and, moreover, represent heavy capital investment. One of the outstanding advantages of automatic equipment is that without unduly complicating the numbering scheme, or delaying the service, it permits simplification of the junction layout and concentration of the junctions in large groups to be operated at high

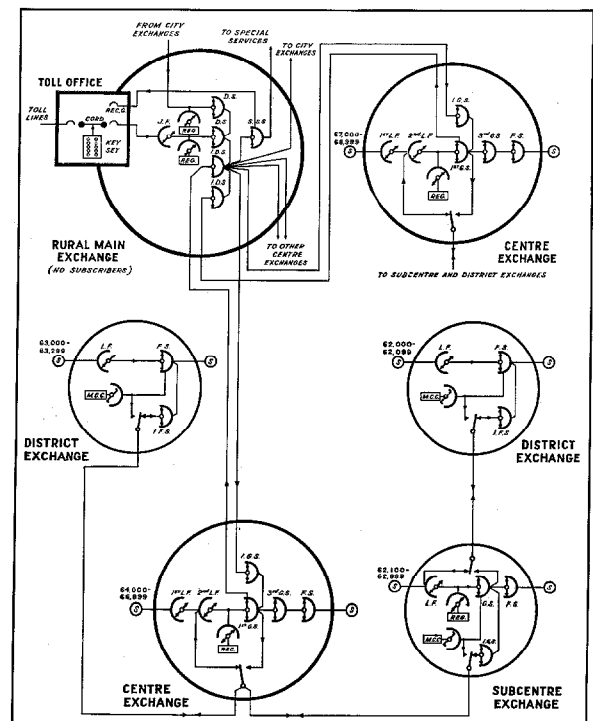

Figure 1—Typical Junction Diagram for Environs of Large Town (Uniform 5-Digit Closed Numbering)

efficiency. Typical 7-D Rotary System junction diagrams (see Figures 1 and 2) show a star formation junction layout. From the parent urban network junctions radiate to centre exchanges, and from the centre exchanges to sub-centre and district exchanges; a centre exchange and its subsidiary sub-centre and district exchange form a sector.

Connections originating at district and sub-centre exchanges preselect a junction to their parent centre. The number dialled is received by a register circuit in the centre exchange, and is also recorded by a metering control circuit at the district or sub-centre exchange. In the event of the connection remaining local in sub-centre or district, the junction is caused to release by the metering control circuit, and the connection is completed on the local switching train. In areas of this nature it is fair to assume that the greater the distance from the main urban network, the higher the percentage of local calls. In certain sectors the centre exchange may form a "centre of interest" for the surrounding group of sub-centre and district exchanges in the sector. For this reason, connections originating in centre exchanges do not preselect a junction to the urban network. In this case the dial impulses of the calling subscriber are received by the centre register circuit only, which then takes complete control of the progress of the connection.

The register circuit includes a simple translator which, in addition to selecting the class of metering, also permits the selection of the called subscriber without a direct relation to the number dialled. By this means it is possible to arrange for capacities such as 200 or 2000 lines with single trunk groups without additional group selectors. On a purely decimal basis, a 200-line unit could only be provided by reserving 1000 lines in the numbering scheme, or by providing a separate group of junctions for each 100 lines. In the same manner, any capacity above 1000, and less than 10,000, would require either a separate group of junctions for each 1000 lines or, alternatively, must be given a whole block of 10,000 numbers.

The register circuit also has the advantage of freeing the selectors from the control of the subscribers. Junction hunting is therefore not controlled by the dial pulses, and groups of junctions

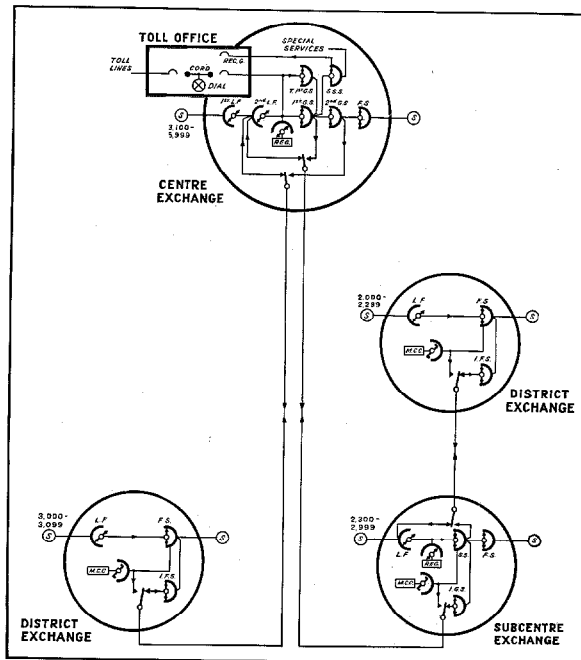

Figure 2—Typical Junction Diagram for Small Town and Environs (Uniform 4-Digit Closed Numbering)

of any size within the capacity of the switch may be employed. Where the mutual traffic between centre exchanges is sufficiently high, the register permits the introduction of direct tie lines without dialling a special prefix.

In planning the junction layout for a system where the average number of subscribers per exchange is relatively small, and the cost of outside plant therefore is a high percentage of the total, one of the problems presented is the choice of a switch giving full availability on all junction groups. The conventional two-motion switch, either step-by-step or power driven, with its rigid division of arc capacity into ten levels, is obviously not suitable since the number of junctions per group in areas of this kind may vary between 2 and 40. For this reason a single motion switch on which the arc capacity can be used to its full extent, is more economical. The switch adopted for the No. 7 District System is the well-known 100-point gear-driven finder which, because of its simplicity and its robust manufacture, is ideally suited for use in rural exchanges which must operate unattended for long periods.

Influence of Register on Impulse Repetition

In non-register circuit systems a dial impulse originating at a distant exchange, and destined for a district exchange of another sector, would have to pass via sub-centre, centre, rural main, and the centre and sub-centre exchanges of the second sector, thus making a total of six repetitions of the original impulse.

The problem of impulsing from end to end of the network becomes more complicated when it is remembered that, to comply with modern transmission standards, many of the inter-exchange junctions will be of loaded cable with a relatively high ohmic resistance and a marked influence on the operating and releasing times of the impulse receiving relay. Another disturbing element requiring consideration is the introduction of repeating coils for transmission reasons or for obtaining phantom circuits, and in consequence the provision of means for impulse repetition using 50 cycle A. C.

As previously explained, the No. 7 District System provides register circuits in the centre exchanges which receive all dial impulses. From the centre onwards, fresh impulses are forwarded which are created by an impulse sender in the register circuit, and the enormous advantage of this feature will be readily appreciated. First, the number of impulse repetitions is decreased from six to three; second, the impulses are forwarded at constant speed; third, the ratio of closure and opening, and the speed of sending, can be changed if necessary, and fourth, no special limitation of dial speed need be imposed.

Interworking with Town Exchanges

Full automatic interworking between the town exchanges and the suburban and rural exchanges immediately liberates operators and equipment in the toll exchange but, on the other hand, requires increase in the automatic equipment of the town exchanges. Since, in the majority of cases, the suburban and rural connections originating at the town exchanges will not exceed 15% of the total, the net increase of automatic equipment will be small. Further, it is most likely that the town exchanges have been in operation for some years, and do not include the necessary interworking equipment, or sufficient

free levels to include the rural exchanges in the town numbering scheme.

With rural equipment of the No. 7-District type, one free level is required on either the first or second group selectors of the town exchanges, and the junctions leading from this level are terminated in direction switches in the rural main exchange. The time and distance metering apparatus is located in the junction circuits, and the appropriate metering is indicated by the interworking register circuit. When the town exchanges are of the Rotary type, the interworking register re-sets the local register circuits with reverive impulses, and sends "forward" impulses to the rural network, translated as desired. The same idea is followed when interworking with step-by-step exchanges, except that in this case one of the digits is accepted in the junction circuit itself, which allows sufficient time for a register circuit to become attached and receive the remaining digits.

Connections incoming to the town exchanges from the rural network are received direct on the existing automatic equipment since, as previously explained, the centre register forwards impulses which can be accepted by step-by-step equipment or received on Rotary register circuits.

For toll connections, the equipment necessary depends largely on the design of the existing toll board, and the operating practise in force. Where the toll positions are provided with key sets, a small group of register circuits which accept the key-set combinations and transform them into impulses, will be required; and where dials are used on the toll positions, registers will, in general, be required in order to obtain the translation necessary for the large number of different directions included in the numbering scheme.

Equipment

In the design of the equipment great attention has been paid to the fact that, in the majority of cases, the installations will not be housed in buildings specially arranged for the purpose, so that the floor space and ceiling height required by the equipment should be as limited as possible. Further, the weight of each unit has been reduced to facilitate handling and installation without special appliances, it being recognised that the same degree of skill cannot always be

obtained as on the installation of telephone plant in large cities.

To provide equipment which will be economical for the exchange capacities required initially, and which will at the same time permit easy extension, five different units have been designed, as follows:

- (1) Centre Exchange— Type, Power Driven—Capacity 200 or 300 to 5000 lines.
Function—Centre exchange of sector.
- (2) Sub-Centre— Type, Power Driven—Capacity 100 to 1000 lines.
Function—Subsidiary exchange of centre. It also serves as tandem point for connection of district exchanges, in which case the capacity of a sub-centre with its associated districts may be increased to 3000 lines.
- (3) District Exchange—Type, Power Driven—Capacity 100 to 300 lines.
Function—Secondary exchange connected to either sub-centre or centre.
- (4) District Exchange—Type, Step-by-Step—Capacity 50 to 100 lines.
Function—Secondary exchange connected to either sub-centre or centre.
- (5) Satellite Exchange—2 Types—10 or 20 lines.
Function—Satellite on any of above units.
NOTE: Takes same metering as parent exchange.

Centre Type

The centre type exchange employs 100-point gear-driven finders at all switching stages. The most general switching scheme includes first and second line finders, first group, second group and final stages. In certain cases where the capacity is below 800 lines, and where there are no subsidiary exchanges attached, the second groups may be omitted. Similarly for low capacities, the second line finders may also be omitted.

An important feature of the system is the provision at various selecting stages of a control circuit to direct the switches to the wanted line. The advantage of this arrangement is that it is possible to reduce the switching equipment actually engaged on a connection and held during conversation to the simplest form for ensuring such connection, and maintaining the

switches in the engaged condition. The control circuits release immediately after their function is completed, and are then available for further calls; they are only engaged for a very short space of time and consequently their number is relatively small.

Register circuits are provided at the centre exchanges for receiving and registering the impulses from the calling subscribers of centre and subordinate sub-centres and districts, for translating these impulses into the necessary number of selections, and for sending out the requisite series of impulses.

Since the centre type exchange forms the switching centre of a sector, the junctions to the main Urban area are usually sufficiently numerous to make one-way working less costly than both-way working. The junctions incoming to centre from main carry the traffic from the urban exchanges, the toll exchanges and other centre exchanges. The junction circuits are designed for D. C. dialling, and signalling, and also 50 cycle alternating current operation. This feature of convertibility from D. C. to A. C. operation applies to all junctions throughout the system.

Trunk offering, breakdown, re-ring and other special toll features, such as delayed ringing, distinctive toll ringing, have also been included.

Centre exchanges of 700 lines or less function as unattended exchanges, in which case fault alarm signals are transmitted to the nearest attended exchange, or to the rural main. These alarms indicate the following causes of disturbance:

- Failure of the main current supply.
- High or low voltage at bus-bars.
- Stoppage of a switchmotor.
- Ringing current failure.
- Blown fuses.
- Blown heat coils.
- Failure of the register to release.

For smaller centre exchanges a number of permanent glow circuits are provided, and evidence that part of these permanent glow circuits are engaged by lines in trouble may be obtained at the controlling attended exchange.

Sub-Centre Exchange

This unit includes line finder, group and final stages. The group switch selects not only the

finals but also junctions to centre and to attached districts. The most important difference between the centre and sub-centre type is that a subscriber of the latter, when calling, preselects a junction to centre. The dial impulses are received by a register at centre, and are also recorded by a metering control circuit at sub-centre. A small number of simple register circuits are provided; they function only if the call remains local or is destined for one of the district exchanges attached. Tie lines may be provided between neighbouring sub-centres, in which case the register is also brought into action to control the selection at the distant sub-centre.

The junctions between centre and sub-centre may be arranged for either one-way or both-way working, with D. C. or A. C. operation.

District Exchange

The power-driven type of district exchange comprises three main units—link circuits, junction circuits and metering control circuits. For capacity of 100 lines, the link circuit has a 100-point gear-driven line finder, and a second finder of the same type which gives access to a free junction, and also serves as a final to connect with the wanted line on a local connection. For capacity of more than 100 lines, a second finder is added in parallel, giving access to the second group of 100 subscribers.

A district subscriber when calling, immediately occupies a junction to sub-centre and centre, and on receipt of the dialling tone, which is given only when a free register in centre and a metering control circuit in district are both attached, dials the wanted number, which is received in centre and recorded in the metering control circuit in district. In the event of all the junctions between sub-centre and centre being engaged, arrangements are provided which enable a connection to sub-centre or to the attached districts to be completed, and in the event of all junctions be-

tween district and sub-centre being engaged, the district subscriber can still complete a local connection. The junction circuits are here also arranged for either one-way or both-way working with either A. C. or D. C. operation.

Routine Testing

Since most of the exchanges are designed to operate as unattended plant, permanent routine testing equipment has not been provided. Small portable test boxes, however, have been designed which enable all the circuits in the exchange to be tested rapidly, and which can be conveniently transported from exchange to exchange. For the centre exchanges above 700 lines, automatic routine test circuits have been designed following the same general principles as are applied nowadays to routine testing equipment for town exchanges.

Remote control test circuits have been designed which permit a large proportion of the equipment in every exchange of the network to be tested from the rural main. At each centre exchange a test number is provided which can be dialled from rural main. This test number, in addition to apparatus required for making tests in the centre exchanges, includes a step-by-step switch giving access to all the junctions to the attached district and sub-centre exchanges. This step-by-step switch responds to impulses sent from main, and can be advanced step by step until all the junctions have been tested. In a similar manner, a test number in each district and sub-centre exchange includes a switch enabling the junctions to be tested for operation in the reverse direction, namely, district to centre or sub-centre to centre.

The idea of remote control routine testing is capable of further development and will, no doubt, prove of great assistance in maintaining rural automatic equipments.

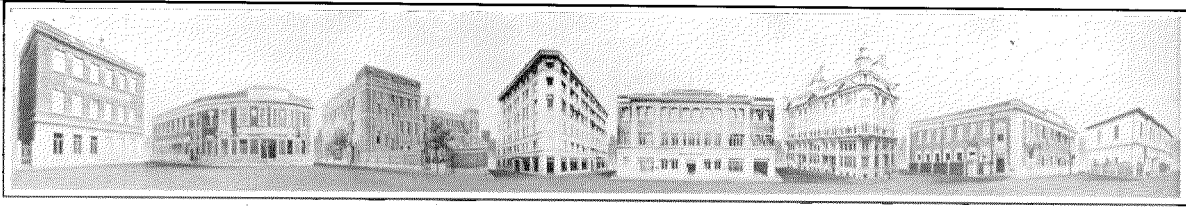

NORTH
CENTRAL
OFFICE

WAYSIDE
CENTRAL
OFFICE

WEST
CENTRAL
OFFICE

FOKIEN
CENTRAL
OFFICE

MONTIGNY
CENTRAL
OFFICE

CENTRAL
OFFICE

PICHON
CENTRAL
OFFICE

LUCERNE
CENTRAL
OFFICE

“THE TELEPHONE BUND”—SHANGHAI

The Reconstruction of the Shanghai Telephone System

By J. HAYNES WILSON, M. C.

EDITOR'S NOTE: *Paper presented before the Engineering Society of China, 13th January, 1932, and reprinted by permission.*

Since this paper was delivered, two additional Rotary Automatic offices have been cut over: North Exchange in February, and West Exchange in March. The cutting over of these exchanges marks the completion, four months ahead of schedule, of the Shanghai Telephone Company's contract with the Municipal Councils to convert Shanghai's telephones to automatic operation. The Shanghai Telephone System is now 93.5 per cent automatic, 3 per cent semi-automatic, and 3.5 per cent manual. The semi-automatic and manual exchanges are all outside of the International Settlement and the French Concession.

COINCIDENT with the development of Shanghai it has been necessary to take steps to furnish the city with an up-to-date telephone system, and it is the purpose of this paper to indicate in a general way the means taken to do so.

Previous to August, 1930, plans were in existence to convert the telephone system to automatic working over a period to terminate in 1937, and some progress in this direction had already been made.

Approximately 972 lines were in operation in the Eastern area connected to an automatic exchange, while some 8,216 lines were connected to an automatic exchange in the Central District.

Equipment for two new exchanges, one of 4,000 lines in the French Concession, and for one of 5,000 lines on Fokien Road had been ordered, and suitable buildings to accommodate these were in the course of erection.

Due largely to the realization that the plans in existence would have to be speeded up to meet the demands of the increasing number of telephone users, and to the fact that very considerable capital would be necessary in order to carry out the conversion in a much shorter time than was at first anticipated, negotiations were ini-

tiated to obtain the benefits accruing from association with an organization having world-wide interests and experience in telephonic communication and operation.

After somewhat prolonged negotiations The Shanghai Mutual Telephone Company was taken over by the International Telephone and Telegraph Corporation and Shanghai Telephone Company came into existence. This Company took the work in hand on August 5, 1930, and gave an undertaking that within two years the Shanghai telephone system would be converted to automatic operation.

On December 13, 1931, 70 per cent of the Shanghai telephone stations were automatic and four new central offices were in operation, namely, Wayside, Pichon, Fokien and Montigny; two more central offices will be opened early in 1932, thus completing the undertaking except for extra Settlement lines, the conversion of which has had to be postponed for political reasons.

The completion of the programme is then within sight but has entailed immense effort.

The goal is to provide apart from an automatically operated system, a plant with sufficient flexibility to serve future possibilities and which can reasonably be expected to serve its full life.

Studies

The studies covering estimated development—plant requirements, economic layout and so on, warrant detailed attention, hence it is proposed to pass over this phase of the undertaking and proceed to what must be a brief indication of the construction work done. It should, however, be mentioned that a large force of engineers has been engaged upon such studies in order to prepare the specifications necessary.

Man Power

It became immediately obvious that the programme could not be put through without outside help and the International Telephone and Telegraph system was called upon for suitable specialists—assistance being required for planning, construction, traffic and commercial duties. Assistance arrived from all over the world—57 telephone specialists converging upon Shanghai from Great Britain, United States of America, South America, Spain, Japan, etc.

A new organization was built up and new labour recruited, resulting in an increase of staff employed by Shanghai Telephone Company from 3,180 to 4,137 persons within six months.

Buildings

An early decision as to central office buildings

was necessary and involved a re-arrangement of central office areas, the re-arrangement being influenced by existing offices, geographical considerations, political boundaries, the number of existing and ultimate subscribers, traffic requirements and the configuration of the existing plant.

Six new buildings have been erected, particulars of which are given in Table I.

TABLE NO. I
BUILDING PARTICULARS

Exchange	Building Capacity lines	Present Equip-ment lines	Building Started	Building Completed	Building Period mos.
Pichon . . .	10,000	4,000	14 Aug. 1929	1 Apr. 1930	7½
Fokien . . .	20,000	5,000	3 Nov. 1929	4 Oct. 1930	11
Wayside . .	10,000	5,000	21 June 1930	15 Dec. 1930	6
North	20,000	7,000	15 Oct. 1930	14 Apr. 1931	6
West	20,000	6,000	26 Sept. 1930	30 July 1931	10
Montigny	20,000	6,000	15 Aug. 1930	16 Mar. 1931	7

The total floor space provided is 136,925 square feet, generous provision for the future being made as is indicated by the capacity of the various buildings compared with the present equipment: it is already necessary to increase the equipment in certain areas to meet growth requirements.

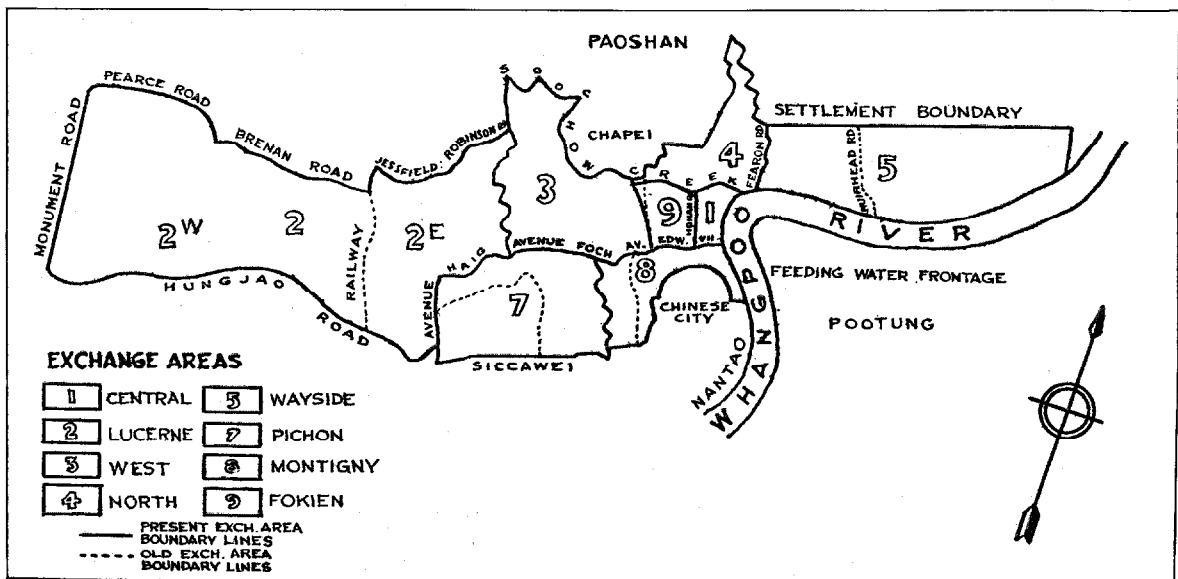

Plate No. 1—Conversion Programme 1930-32. Rearrangement of Exchange Areas

The size of a Central Office is not directly proportional to the number of telephones to be served, community interest having a strong influence. This is illustrated by the amount of equipment in the West and Montigny offices, each having a present equipment capacity of 6,000 lines.

West serves a residential and Montigny a business area. Table II shows the variation in the amount of equipment required.

TABLE NO. II
COMPARISON OF SWITCHING PLANT WEST AND MONTIGNY EXCHANGES

Switch Group	West	Montigny
1st Line finders.....	600	960
Registers.....	60	110
1st Group selectors.....	300	585
2nd Group selectors (local).....	95	150
2nd Group selectors (Incoming from other exchanges).....	275	473
3rd Group selectors.....	352	606
Final selectors.....	432	610

Table III further demonstrates the variation of traffic giving the average number of calls originated per subscriber in various central offices during the busy hour.

TABLE NO. III
COMPARISON OF BUSY HOUR ORIGINATING CALLING RATES—ALL EXCHANGES

Exchange Name	Code Digit	Nature of Area	Originating Calling Rate Calls per line
Central.....	1	Business	2.58
Lucerne.....	2	Residential	1.04
West.....	3	Residential	0.86
North.....	4	Business	1.36
Wayside.....	5	Business	1.96
Pichon.....	7	Residential	1.23
Montigny.....	8	Business	2.08
Fokien.....	9	Business	2.41
System Overall Ave.			1.79

Central Office Equipment

The automatic equipment ordered was manufactured in Paris and Antwerp, the factories there being asked to meet a stiff schedule of deliveries. The results were gratifying inasmuch as the material arrived as required.

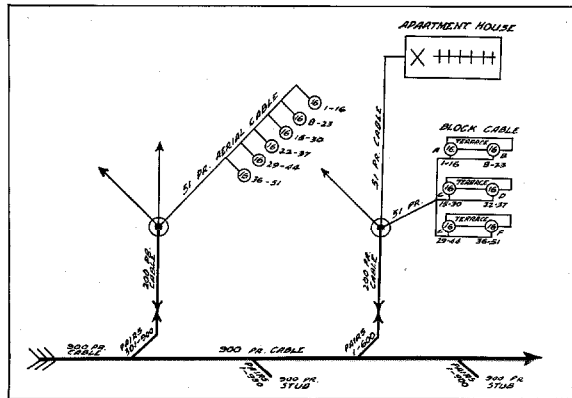

Figure 1—Diagram of Feeder Cable

Installation of Automatic Equipment

A contract was placed with the China Electric Company to install the automatic equipment.

In order to carry out the work in the required time, the China Electric Company proceeded to form an Installation Department that would be capable of handling many different classes of labour. The preliminary step was to arrange for experienced installing engineers to be sent from the various Companies which already had similar departments formed.

Three London installers who had been engaged upon an extension to the existing Central automatic exchange were available in Shanghai and within six months from the contract being placed, fourteen additional experts arrived to assist in supervision and training. Of these, four came from Paris, six from Antwerp, and one each from Cairo, Peru, United States of America, and Rio de Janeiro.

Pending the arrival of automatic equipment, steps were taken to train local help—Chinese students returned from United States of America, Russians and others were engaged for special work or junior supervisors. By good fortune several men were found who had performed duties in telephone exchanges in various parts of the world.

Men with some training in the use of tools were recruited and trained for special work such as erecting apparatus, running cables, simple wiring, switch adjusting and so on. The China Electric Company's factory in Chapei was called upon to supply as many trained wiremen as could be spared and additional assistance was

P. C. 4	
Old Tele. No.....	New Tele. No.....
Name.....	
Address.....	
Cable No.....	Pair..... Protected/Non-Protected.....
Commercial "Equipt." Circ.....	Date Sent.....
Apparatus at Present.....	Required.....
Apparatus Fitted (Date).....	Test Ref. No.....
Commercial "No. Change" Circ.....	Date Sent.....
Old Mult-Ch'kd. to New M.D.F. (Date)...	Ref. No....
Tested After Cut-over (Initials).....	Ref. No....

Figure 2—Shanghai Telephone Company—Subscriber's Conversion History Card

given by the Shanghai Telephone Company who sent men into each of the new exchanges during the installation period in order that they might become familiar with the equipment and thus be better able to maintain it after it was brought into operation.

Ordering of Supplies

While plans were in the course of preparation, estimates were made of materials required and a schedule drawn up of delivery dates. This in itself was quite a study as the programme did not permit of any shortage of materials when the plans were ready. On the other hand care had to be taken that there would not be an undue surplus of material at the end of the job, and that unnecessary expense should not be incurred due to material lying idle pending use.

Major items such as underground ducts and underground cable could be estimated accurately, but aerial cable, suspension wire, distribution boxes, wire and a multitude of other miscellaneous items presented considerable difficulty. The preliminary step was to use prepared block plans of the town, study a number carefully and base further calculations upon data thus obtained.

Outside Plant Reconstruction

A convenient manner of reviewing the activities involving the distribution network as distinct from the central offices and equipment is to follow the course of a subscriber's line from a central office to the telephone user's premises.

Main Distribution Frame

It is at this point that the connection between the exchange apparatus and the distribution network is carried out. Here the lines entering the exchange are sorted from geographical order to numerical order, and the arrangement is such that a subscriber's allocation outside the exchange can readily be rearranged when desired, as for instance, in the case of a subscriber removing from one part of the area to another.

On this frame also, protection is provided against lightning and power contact hazards for all subscribers' lines entering the exchange.

Cable Vault

Entry to the central office is always effected by means of underground cables which may contain up to 1,200 pairs of wires. Subscribers and inter-exchange cables are concentrated in the cable vault, which is located immediately below and parallel to the main distribution frame. This vault is designed to facilitate tidy termination and to provide protection against fire or mechanical injury.

Since the street cables are of large size and are insulated with paper, they are not suitable for direct termination on the main distribution frame, and consequently it is necessary to splice these cables into a number of smaller cables which are insulated with silk and cotton; this splicing is carried out in the cable vault.

The street cables leave the cable vault to feed the distribution network, and they radiate in all directions from the exchange through duct routes built up of 3, 6, 9, 12 or 15 ducts.

Ducts

In addition to 340 duct miles which already existed in 1930, a total of 40 duct miles has been laid during the reconstruction period.

Concrete ducts, vitrified clay ducts, iron pipes, and in some cases fibre conduit have been used in this work, some of the ducts having been manufactured in our own yards, while others were imported.

At intervals along the duct routes are wells or manholes, which, whenever possible, are constructed to certain standards which have been



West Exchange—September, 1931

proved to be the most suitable for particular conditions.

In many cases the standard well could not be built due to what one might call the rather unsystematic arrangement of the pipes, drains, cables, etc., which were buried underground many years ago by the various Utility Companies and others, not excluding the Telephone Company. For example, in one particular case, it was necessary to sink a well 12 feet underground in order to clear a sewer.

When the work started cables were pulled through ducts by hand winches, but later by a winch designed and fitted locally on a Ford truck, and finally by a truck which was specially imported for this purpose; the mechanical means proving to be both speedy and economical.

Existing ducts were utilized to the greatest possible extent, in many cases small cables being replaced by large ones, this being possible due to development in cable design which now enables a 900 pair cable to be manufactured the

diameter of which is not much greater than of a 300 pair manufactured some years ago.

In certain instances the old ducts were found to be full of mud, and in order to clear out this accumulation the P. W. D., the Water Works Company and the Fire Brigade were called upon to assist in an experiment of flushing the ducts with water. This proved successful, it being found that 40 lbs. pressure of water cleared of obstruction approximately 100 yards of duct.

Splicing

Mention has already been made of the wells or man-holes which are located at intervals of approximately 200 feet along the duct routes. These are used as jointing chambers, the cable being ordered in proper lengths according to the location in which it is to be used.

The splicing of cable in a man-hole requires a high degree of accuracy and skill, because each pair of wires must be connected in a pre-determined manner, and it is of the utmost importance

that the two wires forming the pair for a telephone circuit must not be separated from each other, anywhere between the exchange and the subscriber.

The cable splicer spends a large part of his time in joining wires, one splice of 1,200 pair cable involving 4,800 wire ends or even more under certain circumstances. Within the last 18 months over 4,000,000 wire joints have been made in underground and serial cables.

The average time taken to complete a 1,200 pair splice is 24 hours and a 900 pair, 20 hours.

The work of splicing cables in man-holes is frequently handicapped by the presence of water and it is necessary to consider the tides at certain times of the year. In order to empty man-holes Ford pick-up vans fitted with pumps have proved invaluable; hand pumps are found sufficient as a rule to keep down seepage. Wells must be kept as dry and as clean as possible while splicing operations are in progress, because the cables used are of the dry core, paper insulated type which demand a high degree of insulation, and to which dampness in any form is a deadly menace.

Upon completion of wire jointing, the cable splice is covered with a lead sleeve and is made watertight with a plumber's wipe.

Distribution

The feeder cables already mentioned as radiating from the exchange, are each designed to serve a certain area, further distribution being carried out by smaller cables in three ways: (1) by being led under ground to a large building; (2) by cable placed on the walls of blocks or alley-ways; (3) by aerial cable carried on poles.

The main feeder cable, which is a very expensive item, usually provides for not more than from five to eight years development of the area which it is designed to serve; but it is so arranged that the initial area may, at a later date, be subdivided into two or more ultimate areas; the additional area or areas being served by new feeder cables. The initial feeder cable is so planned that it can be picked up by the new cable at some prearranged point, without altering its physical lay-out.

This is accomplished by placing stubs in the feeder cable at points where distribution cable

connections are, or will be required. The arrangement is such that all the pairs in the feeder cable are available in the stubs designed to serve each ultimate area.

In the case of a large building the distribution cable is terminated on a special frame which provides cross-connecting facilities between the external cable and the building cable, further distribution inside the building being effected by house cable connected to small terminal boxes placed at convenient distribution points. House cables are designed to meet the ultimate requirements; and unless this is known in proper time and suitable accommodation is provided for cables, the installation may be exposed and subject to damage or be unsightly.

It is therefore very important that owners and architects when preparing plans for new buildings should make suitable arrangements for cable terminal boxes and station wiring.

Aerial and block distribution are similar in most respects, in that the distribution cables terminate on a series of distribution boxes placed at convenient locations on poles or on buildings. From these boxes the final distribution is carried out by individual pairs of wires running to the subscriber's premises.

The distribution boxes used on the block and aerial systems are of a type specially designed to prevent the ingress of moisture to the cable. Lengths of dry core, paper insulated stub cables containing from 10 to 20 pairs are supplied ready connected to these boxes, the free ends of these cables being joined to cables led from the main feeder cable.

Inside the box the stub cable connections are effectively sealed from contact with the atmosphere in order to guard against the lowering of the insulation of the cable.

Provision is made for testing the cable pairs, and for readily effecting changes in the distribution of the subscribers, without the necessity of re-opening the sealed connections. To provide these facilities, each conductor is terminated on a non-hygroscopic panel which forms part of the cable sealing chamber.

Previous to the re-construction, the distribution network had become congested and had lost its flexibility; and consequently in order to meet the demand for service, individual wires had fre-

quently to be run, not to the nearest terminal, but to the nearest one containing spare cable pairs. This resulted in an excessive use of drop or lead-in wires, some premises being served from points which, from a distribution aspect, were certainly not in the vicinity.

Additional points of distribution and re-routing necessitated different points of entry into subscribers' premises, resulting in very many cases, in the re-wiring of the installation from the point of entry to the telephone; more than 700,000 feet of wire have been used for this work alone.

During the work of re-constructing the outside plant, a high standard of distribution was set, and whenever such a procedure was economically sound, telephone lines have been transferred from overhead to underground, or from open wire to aerial or block cable, thus introducing the benefits of greater permanency and less liability to interruption, and also resulting in lower maintenance costs.

Up to the present 1,300 poles have been removed and 500 more are scheduled to be taken down in the near future. 430,000 feet of underground cable, 840,000 feet of aerial cable and 6,500 new distribution boxes have been placed up to date.

Subscribers' Apparatus

At the point of entry into the subscribers' premises, protection is provided where necessary against lightning and power contact hazards. According to whether the line is unexposed or exposed a terminal block, or protector consisting of carbons and fuses is inserted between the outside and inside wires.

Subscribers in the 60,000 and 70,000 groups of numbers were already operating on what is known as the Common Battery System, and in these cases the existing instrument was rendered suitable for automatic working merely by fitting a dial. Some 3,500 dials have been fitted to instruments of this type. In the case of the magneto instruments, the question of conversion was not so simple, in that every instrument had to be entirely replaced.

The conversion of a whole exchange area to automatic working takes place in the space of from two to four minutes, and consequently this

replacement of instruments involved the fitting of the new telephone in such a way that the subscriber could continue to use the old instrument right up to the time of the change over, and could then immediately commence using the new one. Thus in the case of magneto subscribers the new instrument was installed adjacent to the old one some time prior to the actual change over, and the old telephones were recovered after the conversion had taken place. Approximately 14,000 instruments have been or are to be duplicated in this manner.

Some difficulty was met in this respect due to the fact that the shape and size of the automatic instruments is quite different to that of the magneto types. This necessitated, in the case of wall instruments, the installation of a special back board, which was designed to facilitate the fitting of two telephones without any additional drilling of walls, and at the same time to obscure any defacement of decorations which might result from the removal of the old and larger telephone.

Subscribers' Private Branch Exchanges were changed prior to the actual conversion to automatic working, special arrangements having been made to permit the new type board operated over the old central office until the changeover took place.

Up to the present approximately 800 magneto P B Xs have been replaced by the new types.

Cable Arrangements

Further operations in connection with the conversion of the subscribers' apparatus were necessary in order to make the distribution network accessible to both the old and the new exchanges.

Two methods were adopted for this purpose: One method was to divert the old lines into the new exchange building, and then to connect them *via* the new exchange main distribution frame and back by a special cable to the old exchange.

The other method involved the running of a new feeder cable from the new exchange to a convenient point where it could be teed into the old cable. With this method the subscriber's line terminated at both the old and the new exchanges.

This work alone involved the use of 570 miles

of cross-connecting wire on the new and old central office main distribution frames.

Cable Records

The keeping of records during the re-construction period has been a matter requiring considerable care and ceaseless vigilance. The possibility of error may be conceived when it is known that in 1930, 36,980 pairs radiated from the various central offices, and that upon completion of the re-construction there will be 72,780 pairs, each pair with a separate identity. Hundreds of pair changes have been necessary daily, and not a single pair could be changed without reference to the records.

A staff of 25 men have devoted their whole time to this work,—have issued authority for every contemplated change,—kept trace of the cable pair used for every new telephone installed—every old one taken down—and every change necessary to clear trouble on working lines.

Staff Training

The training of staff required special consideration, personnel with a knowledge of telephone practice being difficult to recruit. Steps had to be taken to train new recruits in the various types of work, and also to train the existing staff concerning new methods and the new standards which it was desired to obtain.

More than 700 men have passed through our Telephone Training School, receiving courses the duration of which varied from one week to three months, while approximately 500 men including 152 foreigners have received tuition at evening classes in the same school. In addition much training work was done in the field.

Instruction of Subscribers

For this very necessary and important part of the programme, special arrangements had to be made. A staff of 46 persons took care of the instruction of subscribers. The number of visits and revisits to subscribers made by this section up to the present time total 30,530.

Demonstration offices were established in various parts of the city, and subscribers were

invited to attend these offices in order to receive demonstrations and practice in the use of the automatic telephone. Up to the present time 17,250 persons have taken advantage of this invitation.

Cut-over Arrangements

“Cut-over” is a term applied, in the telephone sense, to the transfer of lines from one exchange to another, and all work in connection with the transfer is generally termed “Cut-over arrangements.”

In Shanghai a special division was organized to be responsible for the details of these arrangements, which included arranging of schedules, recording progress of the conversion and compilation of a new Master File of subscribers in addition to the issue and control of the Cut-over Day Programme.

The new Master File was in two sections. One section gave all details of lines connected both to the old and the new exchange, so that a considerable time in advance of the cut-over a complete list of subscribers to be connected to each new exchange was available; the other section consisted of one history card for each line; this was used for recording the various stages of the conversion, *i.e.*, the change of telephone number, change from old to new cable and the various tests and advices to the subscriber, etc.

For the proper co-ordination of all work in connection with the final stages of conversion and the actual cut-over to a new exchange, a very detailed schedule or programme is required. This includes a general summary of the work involved, detailed duties of all personnel

CUT-OVER DAY PROGRAMME: SECTION 6 - TIME TABLE. DUTY "A"(3) (TIME TAKEN FOR CUT-OVER OPERATIONS)						FOKJEN EXCHANGE DATE 13 SEPTEMBER, 1931. SIGNALS SHOWN SMALL TYPE RECEIVED BY "A" " " CAPITAL TYPE GIVEN BY "A"	
ITEM	SCHEDULED TIME		ACTUAL		DUTY	SIGNAL	WORK TO BE DONE
	BEGIN	END	BEGIN	END			
	A.M. 100	AM 103			P-MDF-1	ORDER	"CUT-OUT CENTRAL"
	100	101			P-10	ORDER	"CUT-OUT JUNCTION CABLES"
	100	101			P-3	ORDER	"CUT-OUT WEST-FOKJEN"
	103	104			P-10	ORDER	"CUT-IN FOKJEN"

Figure 3—Shanghai Telephone Company—Section of Cut-over Controlling Engineer's Time Table

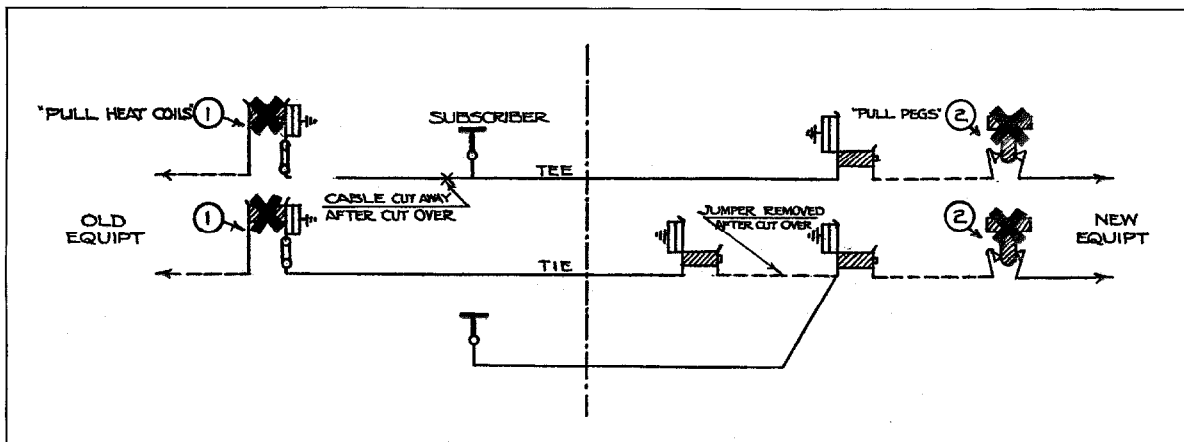

Figure 4—Shanghai Telephone Company—Illustration of Cut-over Operations

engaged, and an analysis of all operations which must be completed before the words “cut-out” —“cut-in” can be given.

To facilitate control, time tables were prepared stating the scheduled times for each order to, or report from each duty, while a Master Time Table was prepared for the use of the Controlling Engineer. A section of such a Time Table used in one of the recent cut-overs in Shanghai is shown in Figure 3. Cut-over Day Programmes were made up for each cut-over, each programme consisting of a book of some 70 pages.

The actual cut-over of a telephone net work is a striking example of the demand for strict discipline and co-operation. Failure of one cog in the machine at the critical hour could easily cause considerable dislocation.

It is usual to carry out a number of rehearsals several days in advance of the actual cut-over, especially to determine that each duty can be relied upon and that each Time Table properly interlocks.

The actual cut-over operation, which is more commonly referred to as the “Cut-over,” consisted of cutting out the old and cutting in the new exchange. There are several places where this might be done, *e.g.*, old underground cables or internal cables leading to the old switchboard might be sawn off. This method is not ideal, for, in addition to the time factor, it is attended by some degree of risk through faults developing during the operation. The method adopted in Shanghai has been to cut out the old exchange

by the removal of heat coils or line fuses on the old distribution frame, and cut in the new exchange by the removal of insulating pegs from the line test jacks on the new distribution frame. These insulating pegs were designed and made in Shanghai and permit of a record rapid removal.

A schematic drawing of the method of cut-over used in Shanghai is shown in Figure 4.

Immediately after the cut-over every line was retested to prove that it had been properly cut in, and subscribers were called up over the new exchange system to make sure not only that their line was in proper order, but that they understood how to use the new telephone. A staff of instructors was in readiness to immediately visit any subscriber requiring additional instruction.

The cut-over of Fokien Exchange involved the removal of more than 7,500 heat coils and 4,000 insulating pegs; this operation was made in three minutes. The number of retests made totalled 8,000.

Schedules

The various operations have been mentioned in sequence; actually each separate portion of the work was carried out by a distinct force, the object being to permit of specialization on particular types of work, to facilitate supervision and to control labour, the latter being largely inexperienced.

The successful completion of the programme necessitated the proper co-ordination of the many varied activities. This was obtained by

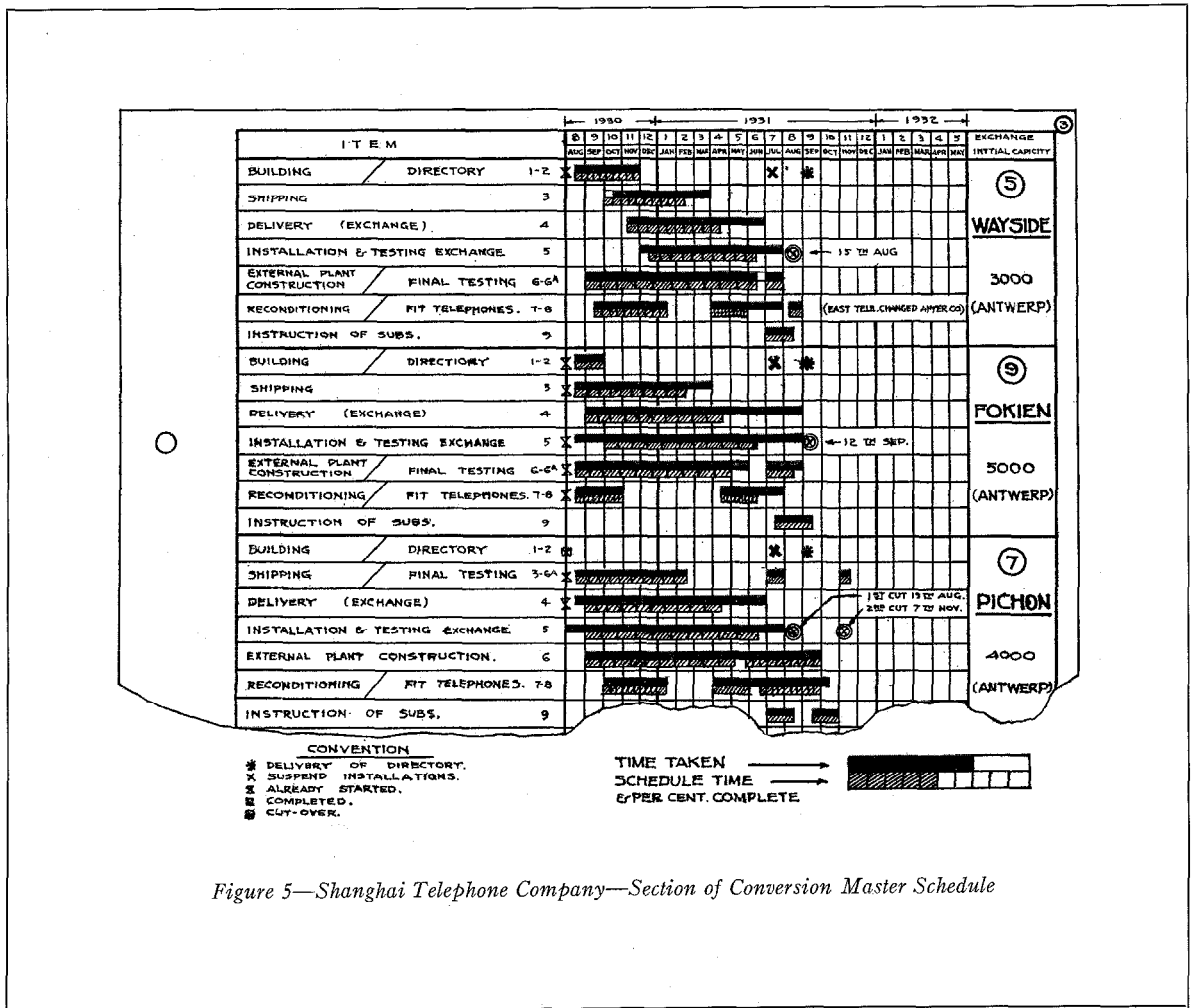

Figure 5—Shanghai Telephone Company—Section of Conversion Master Schedule

preparing schedules for each item of the work, showing the period of time in which each item had to be completed and having due regard to the delivery dates of material and economy in staff.

The schedule was divided into seven main sections: (1) Engineering for buildings, plant, equipment and traffic; (2) Erection of buildings; (3) Installation of exchange equipment; (4) Reconstruction of outside plant; (5) Fitting of subscribers' equipment; (6) Demonstration and instruction of subscribers in the use of the new system; and (7) Commercial, preparation of Directories, Changed No. lists and circulars.

These main sections were further divided into a number of sub-sections so as to facilitate control and checking of progress. A section of

the master schedule is shown in Figure 5 and a section of a sub-schedule in Figure 6.

The success of an automatic system depends largely upon intelligent use by the subscriber; that is, on the proper observance of the tones or signals provided during the setting up of a call, the correct methods of dialling,—and generally, using the instrument according to the instructions provided.

In Shanghai at the present time, of 300,000 calls originated, 77.4 per cent result in conversations, 18.6 per cent find the subscriber busy or receive no reply.

Approximately 3.2 per cent of the total attempts made are abortive due to the subscriber abandoning the call, while only 0.8 per cent are due to equipment failure.

Maintenance of Service

The maintenance of the existing service and the continuous demand for rearrangements has been a matter of primary importance—conditions have naturally not been ideal from a maintenance aspect, for there is no escape from interference with existing plant during a period of reconstruction. Every practical precaution has been taken to keep the number of interceptions at a minimum, but there is no doubt that Shanghai telephone users have shown considerable forbearance for which Shanghai Telephone Company is duly grateful. Both the company's

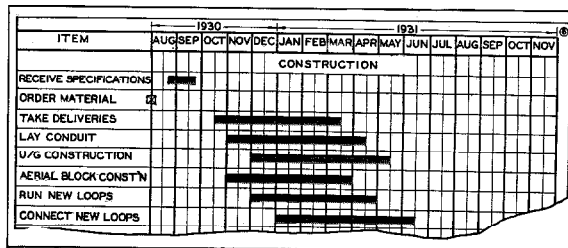

Figure 6—Shanghai Telephone Company—Conversion Programme. Section of Schedule of Sub-items

records and the general public opinion indicate that the service is definitely improving as the programme advances.

Acknowledgment is made of valuable assistance rendered by a number of the staff of Shanghai Telephone Company.

ERRATUM

Electrical Communication, Vol. X, No. 4, April, 1932. Page 181, Figure 7—Final Toll Centering Plan for Rumania.

The plan shown in the Figure has been modified to include the following direct groups not originally called for:

- Bucharest-Prague.
- Bucharest-Vienna.
- Bucharest-Paris.
- Bucharest-Berlin.

All of these direct groups have been established and, as far as can be foreseen, will, under any general European toll plan, continue to exist.

Telephone and Telegraph Statistics of the World

Compiled by Chief Statistician's Division, American Telephone and Telegraph Company

Telephone Development of the World, by Countries January 1, 1931

	NUMBER OF TELEPHONES			Per Cent of Total World	Telephones per 100 Population	Increase in Number of Telephones During 1930
	Government Systems	Private Companies	Total			
NORTH AMERICA:						
United States.....	—	20,201,576	20,201,576	57.17%	16.4	133,553
Canada.....	241,309	1,161,552	1,402,861	3.97%	14.0	2,875
Central America.....	11,893	13,376	25,269	.07%	0.4	638
Mexico.....	1,427	90,632	92,059	.26%	0.6	10,364
West Indies:						
Cuba.....	485	67,991	68,476	.20%	1.8	-8,341
Porto Rico.....	602	11,776	12,378	.04%	0.8	118
Other W. I. Places*.....	8,222	13,531	21,753	.06%	0.3	1,198
Other No. Am. Places*.....	100	11,829	11,929	.03%	3.3	520
Total.....	264,038	21,572,263	21,836,301	61.80%	13.0	140,925
SOUTH AMERICA:						
Argentina*.....	—	303,000	303,000	.86%	2.6	23,000
Bolivia.....	—	2,333	2,333	.01%	0.1	-174
Brazil*.....	674	162,000	162,674	.46%	0.4	3,000
Chile.....	—	48,687	48,687	.13%	1.1	3,448
Colombia.....	*2,500	26,888	29,388	.08%	0.3	1,016
Ecuador.....	1,500	2,700	4,200	.01%	0.2	50
Paraguay.....	185	1,905	2,090	.01%	0.2	120
Peru.....	—	13,745	13,745	.04%	0.2	446
Uruguay.....	—	29,356	29,356	.08%	1.6	334
Venezuela.....	591	20,931	21,522	.06%	0.7	1,672
Other So. Am. Places*.....	2,830	—	2,830	.01%	0.5	62
Total.....	8,280	611,545	619,825	1.75%	0.7	32,974
EUROPE:						
Austria.....	233,912	—	233,912	.66%	3.4	11,676
Belgium.....	292,633	—	292,633	.83%	3.6	32,960
Bulgaria*.....	19,000	—	19,000	.05%	0.3	500
Czechoslovakia.....	147,028	17,451	164,479	.47%	1.1	6,772
Denmark (March 31, 1931).....	13,593	340,722	354,315	1.00%	9.9	12,516
Finland.....	1,642	126,500	128,142	.36%	3.5	6,078
France.....	1,153,560	—	1,153,560	3.26%	2.8	97,526
Germany.....	3,248,854	—	3,248,854	9.19%	5.0	66,549
Great Britain and No. Ireland.....	1,996,897	—	1,996,897	5.65%	4.3	110,171
Greece.....	12,800	—	12,800	.04%	0.2	*1,000
Hungary.....	115,273	—	115,273	.33%	1.3	13,960
Irish Free State (March 31, 1931).....	30,601	—	30,601	.09%	1.0	2,609
Italy (June 30, 1930).....	—	381,992	381,992	1.08%	0.9	48,935
Jugo-Slavia*.....	70,000	—	70,000	.20%	0.5	3,000
Latvia (March 31, 1931).....	51,530	—	51,530	.15%	2.7	9,341
Netherlands.....	306,554	—	306,554	.87%	3.9	22,121
Norway (June 30, 1930).....	115,164	*77,400	192,564	.54%	6.7	4,326
Poland.....	108,683	90,696	199,379	.56%	0.6	13,277
Portugal.....	7,803	28,963	36,766	.10%	0.6	2,208
Roumania.....	—	49,809	49,809	.14%	0.3	—
Russia (October 1, 1930)¶.....	377,586	—	377,586	1.07%	0.2	46,334
Spain.....	—	222,382	222,382	.63%	1.0	37,840
Sweden.....	534,722	1,670	536,392	1.52%	8.7	27,331
Switzerland.....	297,930	—	297,930	.84%	7.3	29,216
Other Places in Europe*.....	99,507	16,365	115,872	.33%	1.4	2,905
Total.....	9,235,272	1,353,950	10,589,222	29.96%	2.0	609,151
ASIA:						
British India*.....	22,000	35,000	57,000	.17%	0.02	100
China.....	84,000	69,000	153,000	.43%	0.03	-3,000
Japan (March 31, 1931).....	913,157	—	913,157	2.58%	1.4	47,641
Other Places in Asia*.....	108,881	17,502	126,383	.36%	0.1	3,792
Total.....	1,128,038	121,502	1,249,540	3.54%	0.1	48,533
AFRICA:						
Egypt*.....	46,000	—	46,000	.13%	0.2	1,000
Union of South Africa#.....	112,900	—	112,900	.32%	1.4	3,963
Other Places in Africa*.....	86,871	1,320	88,191	.25%	0.1	5,854
Total.....	245,771	1,320	247,091	.70%	0.2	10,817
OCEANIA:						
Australia§.....	520,169	—	520,169	1.47%	8.1	14,615
Dutch East Indies.....	49,447	4,598	54,045	.15%	0.1	951
Hawaii.....	—	25,104	25,104	.07%	6.6	738
New Zealand#.....	164,739	—	164,739	.47%	10.2	3,698
Philippine Islands.....	*6,000	20,017	26,017	.08%	0.2	3,113
Other Places in Oceania*.....	3,638	776	4,414	.01%	0.2	214
Total.....	743,993	50,495	794,488	2.25%	1.0	23,329
TOTAL WORLD.....	11,625,392	23,711,075	35,336,467	100.00%	1.8	865,729

* Partly Estimated. # March 31, 1931. § June 30, 1930. ¶ U. S. S. R., including Siberia and Associated Republics.
 † Includes approximately 10,860,000 automatic or "Dial" telephones, of which more than 50% are in the United States.

Telephone and Telegraph Wire of the World, by Countries

January 1, 1931

	Service Operated by (See Note)	MILES OF TELEPHONE WIRE			MILES OF TELEGRAPH WIRE		
		Number of Miles	Per Cent of Total World	Per 100 Population	Number of Miles	Per Cent of Total World	Per 100 Population
NORTH AMERICA:							
United States.....	P.	83,110,000	59.35%	67.3	2,315,000	32.52%	1.9
Canada.....	P.G.	4,880,224	3.48%	48.9	371,747	5.22%	3.7
Central America.....	P.G.	55,252	.04%	0.8	21,506	.30%	0.3
Mexico.....	P.G.	372,000	.27%	2.2	85,884	1.21%	0.5
West Indies:							
Cuba.....	P.G.	300,600	.22%	8.1	*14,000	.20%	0.4
Porto Rico.....	P.G.	33,871	.02%	2.2	1,077	.01%	0.1
Other W. I. Places*.....	P.G.	100,222	.07%	1.6	5,963	.08%	0.1
Other No. Am. Places*.....	P.G.	20,000	.01%	5.6	10,000	.14%	2.8
Total.....		88,872,169	63.46%	52.7	2,825,177	39.68%	1.7
SOUTH AMERICA:							
Argentina*.....	P.	970,000	.69%	8.4	210,000	2.95%	1.8
Bolivia.....	P.	5,292	.004%	0.2	*5,000	.07%	0.2
Brazil*.....	P.G.	460,000	.33%	1.1	110,000	1.54%	0.3
Chile.....	P.	168,000	.12%	3.9	*40,000	.56%	0.9
Colombia*.....	P.	45,000	.03%	0.5	21,000	.29%	0.2
Ecuador*.....	P.G.	5,000	.004%	0.2	5,060	.07%	0.2
Paraguay.....	P.G.	6,010	.004%	0.7	2,236	.03%	0.2
Peru.....	P.	44,670	.03%	0.7	13,216	.19%	0.2
Uruguay.....	P.	45,085	.03%	2.4	7,535	.11%	0.4
Venezuela.....	P.G.	53,223	.04%	1.6	6,989	.10%	0.2
Other So. Am. Places*.....	G.	5,600	.004%	1.1	770	.01%	0.1
Total.....		1,807,880	1.29%	2.1	421,806	5.92%	0.5
EUROPE:							
Austria.....	G.	705,791	.50%	10.3	49,012	.69%	0.7
Belgium (November 1, 1930).....	G.	1,269,788	.91%	15.6	30,244	.42%	0.4
Bulgaria.....	G.	*55,000	.04%	0.9	7,400	.10%	0.1
Czechoslovakia.....	P.G.	481,263	.34%	3.3	43,292	.61%	0.3
Denmark (March 31, 1931).....	P.G.	983,651	.70%	27.4	7,485	.11%	0.2
Finland.....	P.G.	333,000	.24%	9.0	12,500	.18%	0.3
France.....	G.	4,200,000	3.00%	10.0	520,000	7.30%	1.2
Germany.....	G.	14,555,000	10.39%	22.5	277,000	3.89%	0.4
Great Britain and No. Ireland#.....	G.	9,117,000	6.51%	19.7	378,000	5.31%	0.8
Greece.....	G.	16,635	.01%	0.3	32,882	.46%	0.5
Hungary.....	G.	375,500	.27%	4.3	52,200	.73%	0.6
Irish Free State#.....	G.	106,919	.08%	3.6	21,305	.30%	0.7
Italy (June 30, 1930).....	P.G.	990,000	.71%	2.4	231,658	3.25%	0.6
Jugo-Slavia*.....	G.	110,000	.08%	0.8	59,000	.83%	0.4
Latvia*.....	G.	200,000	.14%	10.5	5,000	.07%	0.3
Netherlands.....	G.	*770,000	.55%	9.7	26,000	.37%	0.3
Norway (June 30, 1930).....	P.G.	602,000	.43%	20.9	32,080	.45%	1.1
Poland.....	P.G.	710,000	.51%	2.3	52,000	.73%	0.2
Portugal.....	P.G.	100,000	.07%	1.6	*20,000	.28%	0.3
Roumania.....	P.	156,097	.11%	0.8	47,578	.67%	0.3
Russia§.....	G.	1,100,000	.79%	0.7	500,000	7.02%	0.3
Spain.....	P.	905,000	.65%	4.0	89,620	1.26%	0.4
Sweden.....	G.	1,730,000	1.23%	28.2	51,000	.72%	0.8
Switzerland.....	G.	897,338	.64%	22.1	17,180	.24%	0.4
Other Places in Europe*.....	P.G.	307,875	.22%	3.9	39,572	.56%	0.5
Total.....		40,777,857	29.12%	7.5	2,602,008	36.55%	0.5
ASIA:							
British India*.....	P.G.	360,000	.26%	0.1	420,000	5.90%	0.1
China*.....	P.G.	400,000	.29%	0.1	125,000	1.75%	0.03
Japan#.....	G.	3,240,000	2.31%	5.0	180,000	2.53%	0.3
Other Places in Asia*.....	P.G.	322,380	.23%	0.3	141,614	1.99%	0.1
Total.....		4,322,380	3.09%	0.5	866,614	12.17%	0.1
AFRICA:							
Egypt*.....	G.	200,000	.14%	1.0	38,000	.53%	0.2
Union of South Africa#.....	G.	429,000	.31%	5.3	41,000	.58%	0.5
Other Places in Africa*.....	P.G.	210,653	.15%	0.2	147,691	2.07%	0.1
Total.....		839,653	.60%	0.6	226,691	3.18%	0.2
OCEANIA:							
Australia (June 30, 1930).....	G.	2,450,000	1.75%	38.0	109,000	1.53%	1.7
Dutch East Indies.....	P.G.	234,535	.17%	0.4	28,380	.40%	0.05
Hawaii.....	P.	81,543	.06%	21.5	0	.00%	0.0
New Zealand#.....	G.	566,000	.40%	35.6	26,000	.37%	1.6
Philippine Islands*.....	P.G.	80,000	.05%	0.6	10,100	.14%	0.4
Other Places in Oceania*.....	P.G.	8,616	.006%	0.4	3,889	.06%	0.2
Total.....		3,420,694	2.44%	4.3	177,369	2.50%	0.2
TOTAL WORLD.....		140,040,633	100.00%	7.1	7,119,665	100.00%	0.4

Note: Telegraph service is operated by Governments, except in the United States and Canada. In connection with telephone wire, P. indicates telephone service operated by private companies, G. by the Government, and P.G. by both private companies and the Government.

See preceding table.

*Partly estimated. # March 31, 1931. § U. S. S. R., including Siberia and Associated Republics; partly estimated.

Telephone Development of Large Cities

January 1, 1931

Country and City (or Exchange Area)	Estimated Population (City or Exchange Area)	Number of Telephones	Telephones per 100 Population
ARGENTINA:			
Buenos Aires.....	2,486,000	163,057	6.6
AUSTRALIA:			
Adelaide.....	324,000	30,422	9.4
Brisbane.....	313,000	24,868	7.9
Melbourne.....	1,015,000	95,117	9.4
Sydney.....	1,254,000	114,630	9.1
AUSTRIA:			
Graz.....	165,000	9,469	5.7
Vienna.....	2,020,000	155,128	7.7
BELGIUM:			
Antwerp.....	519,000	37,795	7.3
Brussels.....	948,000	95,632	10.1
Liege.....	424,000	20,669	4.9
BRAZIL (June 30, 1931):			
Rio de Janeiro.....	1,600,000	47,000	2.9
CANADA:			
Montreal.....	950,000	195,976	20.6
Ottawa.....	184,300	38,883	21.1
Toronto.....	735,500	207,218	28.2
CHINA:			
Hong Kong.....	500,000	12,100	2.4
Nanking.....	570,000	2,910	0.5
Pelping.....	1,200,000	*13,000	1.1
Shanghai.....	1,200,000	35,432	3.0
CUBA:			
Havana.....	685,000	49,801	7.3
CZECHOSLOVAKIA:			
Prague.....	850,000	40,571	4.8
DANZIG:			
Free City of.....	235,000	17,534	7.5
DENMARK:			
Copenhagen.....	771,000	142,323	18.5
FINLAND:			
Helsingfors.....	255,000	33,384	13.1
FRANCE:			
Bordeaux.....	266,000	21,013	7.9
Lille.....	210,000	15,116	7.2
Lyons.....	592,000	29,946	5.1
Marseilles.....	677,000	27,080	4.0
Paris.....	2,980,000	400,528	13.4
GERMANY:			
Berlin.....	4,325,000	525,689	12.2
Breslau.....	617,000	44,546	7.2
Cologne.....	737,000	70,045	9.5
Dresden.....	633,000	63,278	10.0
Dortmund.....	535,000	23,941	4.5
Essen.....	648,000	30,495	4.7
Frankfort-on-Main.....	625,000	68,405	10.9
Hamburg-Altona.....	1,605,000	179,435	11.2
Leipzig.....	710,000	71,003	10.0
Munich.....	740,000	77,642	10.5
GREAT BRITAIN AND NORTHERN IRELAND (March 31, 1931):			
Belfast.....	415,000	16,060	3.9
Birmingham.....	1,168,000	52,502	4.5
Bristol.....	410,000	18,740	4.6
Edinburgh.....	439,000	28,468	6.5
Glasgow.....	1,176,000	56,100	4.8
Leeds.....	506,000	21,751	4.3
Liverpool.....	1,178,000	56,185	4.8
London.....	8,210,000	712,493	8.7
Manchester.....	1,091,000	61,152	5.6
Newcastle.....	468,000	18,418	3.9
Sheffield.....	512,000	18,708	3.7
HAWAII:			
Honolulu.....	139,000	17,273	12.4
HUNGARY:			
Budapest.....	1,005,000	73,768	7.3
Szeged.....	135,000	2,452	1.8

Telephone Development of Large Cities—(Concluded)

January 1, 1931

Country and City (or Exchange Area)	Estimated Population (City or Exchange Area)	Number of Telephones	Telephones per 100 Population
IRISH FREE STATE (March 31, 1931):			
Dublin.....	412,000	16,338	4.0
ITALY:			
Genoa (January 1, 1930).....	628,000	22,516	3.6
Milan.....	928,000	68,253	7.4
Rome (January 1, 1930).....	950,000	40,393	4.3
JAPAN (March 31, 1931):			
Kobe.....	788,000	29,562	3.8
Kyoto.....	815,000	34,196	4.2
Nagoya.....	907,000	28,748	3.2
Osaka.....	2,454,000	101,478	4.1
Tokio.....	3,410,000	151,000	4.4
LATVIA (March 31, 1931):			
Riga.....	385,000	21,677	5.6
MEXICO:			
Mexico City.....	955,000	49,334	5.2
NETHERLANDS:			
Amsterdam.....	752,000	49,670	6.6
Haarlem.....	148,000	10,051	6.8
Rotterdam.....	598,000	41,510	6.9
The Hague.....	472,000	43,476	9.2
NEW ZEALAND (March 31, 1931):			
Auckland.....	207,000	21,759	10.5
NORWAY (June 30, 1930):			
Oslo.....	252,000	47,064	18.7
PHILIPPINE ISLANDS:			
Manila.....	380,000	17,199	4.5
POLAND:			
Lodz.....	836,000	13,699	1.6
Warsaw.....	1,116,000	56,332	5.0
PORTUGAL:			
Lisbon.....	590,000	21,837	3.7
ROUMANIA:			
Bucharest.....	630,000	17,103	2.7
RUSSIA (October 1, 1930):			
Leningrad.....	2,228,000	68,255	3.1
Moscow.....	2,780,000	74,391	2.7
SPAIN:			
Barcelona.....	850,000	38,104	4.5
Madrid.....	815,000	42,218	5.2
SWEDEN:			
Gothenburg.....	244,000	37,588	15.4
Malmö.....	128,000	18,735	14.6
Stockholm.....	428,000	133,441	31.2
SWITZERLAND:			
Basel.....	147,000	22,885	15.6
Berne.....	112,000	18,562	16.6
Geneva.....	143,000	21,956	15.4
Zurich.....	250,000	42,750	17.1
UNITED STATES:**			
New York.....	7,014,900	1,786,270	25.5
Chicago.....	3,424,000	981,325	28.7
Los Angeles.....	1,320,000	401,887	30.4
Total 8 cities over 1,000,000 Population.....	19,602,800	4,875,830	24.9
Pittsburgh.....	987,300	231,435	23.4
Milwaukee.....	725,100	158,003	21.8
San Francisco.....	653,300	262,470	40.2
Washington.....	508,500	172,998	34.0
Total 10 cities with 500,000 to 1,000,000 Population.....	6,927,700	1,605,282	23.2
Minneapolis.....	497,600	133,477	26.8
Seattle.....	403,900	128,447	31.8
Denver.....	290,100	91,965	31.7
Omaha.....	228,800	67,102	29.3
Total 34 cities with 200,000 to 500,000 Population.....	10,228,400	2,204,289	21.6
Total 52 cities with more than 200,000 Population.....	36,758,900	8,685,401	23.6

* Partly estimated.

** There are shown, for purposes of comparison with cities in other countries, the total development of all cities in the United States in certain population groups and the development of certain representative cities within each of such groups.

Telephone Development of Large and Small Communities—January 1, 1931

Country	Service Operated by (See Note)	NUMBER OF TELEPHONES		TELEPHONES PER 100 POPULATION	
		In Communities of 50,000 Population and Over	In Communities of less than 50,000 Population	In Communities of 50,000 Population and Over	In Communities of less than 50,000 Population
Australia (June 30, 1930)*	G.	295,165	225,004	9.0	7.1
Austria	G.	176,153	57,759	7.5	1.3
Belgium	G.	203,106	89,527	6.1	1.9
Canada	P.G.	730,000	672,861	23.7	9.7
Czechoslovakia	P.G.	65,543	98,936	4.1	0.8
Denmark	P.G.	158,910	192,400	17.5	7.2
Finland	P.G.	48,156	79,986	10.4	2.5
France	G.	676,125	477,435	7.5	1.5
Germany	G.	1,978,418	1,270,436	8.8	3.0
Great Britain and No. Ireland#	G.	1,432,700	588,900	5.7	2.8
Hungary	G.	85,675	29,598	4.9	0.7
Japan (March 31, 1931)	G.	548,762	364,395	3.5	0.7
Netherlands	G.	202,228	104,326	6.4	2.2
New Zealand (March 31, 1931)	G.	63,742	97,997	12.2	9.2
Norway (June 30, 1930)	P.G.	65,931	126,633	16.1	5.1
Poland	P.G.	111,500	87,879	2.9	0.3
Spain	P.	137,327	85,055	3.2	0.5
Sweden	G.	215,441	320,951	21.7	6.2
Switzerland	G.	130,809	167,121	15.5	5.2
Union of South Africa	P.	59,060	52,840	6.3	0.7
United States	P.	11,152,076	9,049,500	22.6	12.2

Note: P. indicates telephone service operated by private companies, G. by the Government, and P.G. by both private companies and the Government. See first table.
 * Partly estimated.
 # March 31, 1931.

Telephone Conversations and Telegrams—Year 1930

Country	Number of Telephone Conversations	Number of Telegrams	Total Number of Wire Communications	PER CENT OF TOTAL WIRE COMMUNICATIONS		WIRE COMMUNICATIONS PER CAPITA	
				Telephone Conversations	Telegrams	Telephone Conversations	Telegrams
Australia	456,000,000	16,506,000	472,506,000	96.5	3.5	71.1	2.6
Austria	*550,000,000	2,693,000	552,693,000	99.5	0.5	80.8	0.4
Belgium	223,251,000	5,657,000	228,908,000	97.5	2.5	27.6	0.7
Canada	2,626,753,000	14,034,000	2,640,787,000	99.5	0.5	264.8	1.4
Czechoslovakia	270,000,000	5,092,000	275,092,000	98.1	1.9	18.4	0.4
Denmark	343,457,000	2,119,000	345,576,000	99.6	0.4	152.2	0.6
Finland	172,000,000	727,000	172,727,000	99.6	0.4	47.0	0.2
France	845,029,000	34,999,000	880,028,000	96.0	4.0	20.3	0.8
Germany	2,551,000,000	25,100,000	2,576,100,000	99.0	1.0	39.6	0.4
Great Britain & No. Ireland	1,530,000,000	51,141,000	1,581,141,000	96.8	3.2	33.1	1.1
Hungary	170,388,000	3,404,000	173,792,000	98.0	2.0	19.7	0.4
Japan	3,194,340,000	52,597,000	3,246,937,000	98.4	1.6	49.6	0.8
Netherlands	*500,000,000	4,669,000	504,669,000	99.1	0.9	63.5	0.6
New Zealand	328,544,000	6,423,000	334,967,000	98.1	1.9	208.3	4.1
Norway	246,000,000	3,449,000	249,449,000	98.6	1.4	85.7	1.2
Poland	761,791,000	5,461,000	767,252,000	99.3	0.7	24.8	0.2
Spain	613,000,000	22,290,000	635,290,000	96.5	3.5	26.8	1.0
Sweden	810,000,000	4,157,000	814,157,000	99.5	0.5	132.1	0.7
Switzerland	230,900,000	2,800,000	233,700,000	98.8	1.2	56.9	0.7
Union of South Africa	198,062,000	5,348,000	203,410,000	97.4	2.6	24.7	0.7
United States	27,800,000,000	215,000,000	28,015,000,000	99.2	0.8	226.0	1.8

Note: Telephone conversations represent completed local and toll or long distance messages. Telegrams include inland and outgoing international messages.
 * Partly estimated.

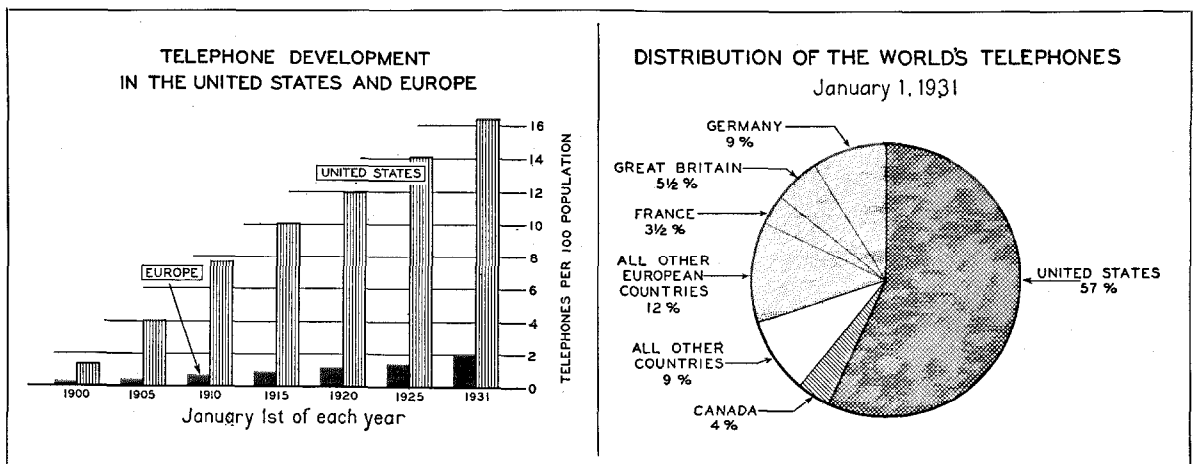

INTERNATIONAL TELEPHONE AND TELEGRAPH CORPORATION

BOARD OF DIRECTORS

FREDERIC W. ALLEN Lee, Higginson & Company	RUSSELL C. LEFFINGWELL J. P. Morgan & Co.
ARTHUR M. ANDERSON J. P. Morgan & Co.	CLARENCE H. MACKAY Chairman of the Board, Postal Telegraph and Cable Corporation
HERNAND BEHN, President	JOHN L. MERRILL President, All America Cables, Incorporated
SOSTHENES BEHN, Chairman	CHARLES E. MITCHELL Chairman, The National City Bank of New York
F. WILDER BELLAMY Dominick & Dominick	WALTER E. OGILVIE President, Havana Terminal Railroad Company
EDWARD J. BERWIND Chairman, Berwind-White Coal Mining Company	HENRY B. ORDE, Vice-President
JOHN W. CUTLER Edward B. Smith & Co.	BRADLEY W. PALMER Chairman of the Executive Committee, United Fruit Co., Boston
R. FULTON CUTTING Financier	GEORGE E. PINGREE President, International Standard Electric Corporation
GEORGE H. GARDINER Davis Polk Wardwell Gardiner & Reed	WOLCOTT H. PITKIN Vice-President and General Attorney
ALLEN G. HOYT Vice-President, The National City Bank of New York	LANSING P. REED Davis Polk Wardwell Gardiner & Reed
GEORGE H. GARDINER General Counsel	

OFFICERS

<i>Chairman</i>		<i>President</i>	
SOSTHENES BEHN		HERNAND BEHN	
<i>Vice-Presidents</i>			
HENRY B. ORDE	PHILIP K. CONDUCT	WILLIAM F. REPP	A. H. GRISWOLD
LEWIS J. PROCTOR	JOHN L. MERRILL	FRANK GILL	LOGAN N. ROCK
GEORGE E. PINGREE	FRANK W. PHELAN	FRANK C. PAGE	GEORGE S. GIBBS
<i>Vice-President and General Attorney</i>		<i>Vice-President and General Technical Director</i>	
WOLCOTT H. PITKIN		JAMES L. McQUARRIE	
<i>Comptroller</i>		<i>Secretary</i>	
EDWIN F. CHINLUND		S. G. ORDWAY	
		<i>Treasurer</i>	
		JAMES E. FULLAM	

THE International Telephone and Telegraph Corporation was organized to cooperate and assist technically and financially in the general development of electrical communications in a broad international sense, and, with respect to the organization and development of national communications systems, it is the purpose of the International Telephone and Telegraph Corporation to develop truly national systems operated by the nationals of each country in which the International Corporation is or may become interested. The International Corporation was not organized with a single profit-making purpose to itself nor with the desire of imposing American practices in its foreign activities. There appeared to be a fruitful field of service to be ren-

dered in bringing together under one general organization electrical communications systems, and the extension by the International Corporation to the Associated Companies of the technical and financial facilities and direction that might be needed for their intensive and efficient development. The best American practices have been suggested but never imposed. On the contrary, the International Corporation has always been ready and quick to adjust American practices to local conditions and to adopt such local practices as were conducive to the successful development of the various entities. The combined and co-ordinated effort of the Associated Companies of the International System is today justifying the plans and purposes of the Corporation.

The International Standard Electric Corporation and its Licensee Manufacturing and Sales Companies present the following list of radio broadcasters which they have furnished:

EUROPE		PORTUGAL		WATTS		SOUTH AMERICA	
GREAT BRITAIN	WATTS	Lisbon.....	15,000	(under construction)		ARGENTINE	WATTS
Daventry.....	15,000	POLAND		Buenos Aires.....	15,000	Buenos Aires.....	5,000
	(short wave)	Kattowice.....	10,000	Buenos Aires.....	500	Buenos Aires.....	100
Daventry.....	15,000	Poznan.....	1,000	Buenos Aires.....	10	Mendoza.....	10
	(short wave)	FINLAND		La Plata.....	1,000	Rosario.....	100
IRISH FREE STATE		Helsingfors.....	10,000	Olivos.....	1,000	BRAZIL	
Cork.....	1,000	HUNGARY		Rio de Janeiro.....	500	Bello Horizonte.....	500
SWEDEN		*Budapest.....	120,000	Bahia.....	50	Sao Paulo.....	1,000
Malmö.....	1,250	Nyiregyhaza.....	6,000	URUGUAY			
Uddevalla.....	50	Miskulcz.....	1,000	Montevideo.....	1,000	Montevideo.....	100
Gothenburg.....	10,000	Gyor.....	1,000	CUBA			
Sundsvall.....	10,000	Pecs.....	1,000	Havana.....	500	CHILE	
Horby.....	10,000	Budapest (short wave).....	10,000	Valparaiso.....		San Fernando.....	100
		(all under construction)		PORTO RICO			
NORWAY		AFRICA		San Juan.....	500	San Juan.....	1,000
Notodden.....	50	Johannesburg.....	10,000	(under construction to replace the 500 w. station)			
Rjukan.....	150	AUSTRALASIA		EL SALVADOR			
Bergen.....	1,000	AUSTRALIA		San Salvador.....	50	San Salvador.....	50
Tronso.....	100	Newcastle.....	2,000	San Salvador.....	50	VENEZUELA	
DENMARK		Rockhampton.....	2,000	Caracas.....	1,000	HAITI	
Kalundborg No. 1.....	7,500	Port Pirie.....	7,500	Port au Prince.....	1,000	SOUTH ORKNEY ISLAND.....	
Kalundborg No. 2.....	60,000	Corowa.....	7,500	100			
(under construction)		NEW ZEALAND					
ITALY		Christchurch.....	500				
Turin.....	7,500	Auckland.....	500				
Genoa.....	1,000	Wellington.....	5,000				
Bolzano.....	1,000	ASIA					
SPAIN		JAPAN					
Barcelona.....	5,000	Sendai.....	10,000				
Oviedo.....	500	Hiroshima.....	10,000				
San Sebastian.....	500	Sapporo.....	10,000				
Valencia.....	500	CHINA					
CZECHO-SLOVAKIA		Canton.....	1,000				
Prague (standby).....	5,000	NORTH AMERICA					
Mor Ostrava.....	10,000	MEXICO					
Kosice.....	2,000	Mexico City.....	500				
*Prague.....	120,000						
SWITZERLAND							
Sottens.....	25,000						
AUSTRIA							
Innsbruck.....	500						
Salzburg.....	500						

German stations furnished by C. Lorenz A. G. (International Telephone and Telegraph Licensee Manufacturing Company):

Heilsberg.....	WATTS	Flensburg.....	WATTS	*Leipzig (new).....	WATTS
Frankfort.....	60,000	Aachen.....	600	150,000	
	20,000	Münster.....	300	(under construction)	
	(under construction)	Köln.....	600	Berlin O.....	600
Munich I.....	1,700	Nürnberg.....	1,700	Stettin.....	600
Munich II.....	75,000	Leipzig (old).....	2,300	Magdeburg.....	600
	(under construction)		2,300	Witzleben.....	1,700
		Kaiserslautern.....	1,700		

*The Prague, Leipzig and Budapest broadcasting equipments are among the world's largest.

Licensee Companies

BELL TELEPHONE MANUFACTURING COMPANY.....	<i>Antwerp, Belgium</i>
<i>Branches: Berne, The Hague, Brussels.</i>	
STANDARD ELECTRIC DOMS A SPOLECNOST.....	<i>Prague, Czechoslovakia</i>
CHINA ELECTRIC COMPANY, LIMITED.....	<i>Shanghai, China</i>
<i>Branches: Canton, Hankow, Harbin, Mukden, Peiping, and Tientsin, China.</i>	
COMPAÑIA STANDARD ELECTRIC ARGENTINA.....	<i>Buenos Aires, Argentina</i>
INTERNATIONAL STANDARD ELECTRIC CORPORATION, <i>Branch Office,</i>	
	<i>Rio de Janeiro, Brazil</i>
INTERNATIONAL STANDARD ELECTRIC CORPORATION OF MEXICO . . .	<i>New York, N. Y.</i>
INTERNATIONAL TELEPHONE AND TELEGRAPH LABORATORIES, INCORPORATED	
	<i>Hendon, England</i>
LE MATÉRIEL TÉLÉPHONIQUE.....	<i>Paris, France</i>
NIPPON DENKI KABUSHIKI KAISHA.....	<i>Tokyo, Japan</i>
<i>Branches: Osaka, Dalny, Seoul, Taihoku.</i>	
FERDINAND SCHUCHHARDT, BERLINER FERNSPRECH-UND TELEGRAPHENWERK	
AKTIENGESELLSCHAFT.....	<i>Berlin, Germany</i>
STANDARD ELECTRIC AKTIESELSKAP.....	<i>Oslo, Norway</i>
AKTIESELSKABET SKANDINAVISKE KABEL- OG GUMMIFABRIKER.....	<i>Oslo, Norway</i>
STANDARD ELECTRIC AKTIESELSKAB.....	<i>Copenhagen, Denmark</i>
STANDARD ELECTRICA ROMANA S/A.....	<i>Bucharest, Rumania</i>
STANDARD ELÉCTRICA, S. A.....	<i>Madrid, Spain</i>
<i>Branches: Barcelona, Bilbao, Sevilla, Santander.</i>	
STANDARD ELETRICA ITALIANA.....	<i>Milan, Italy</i>
<i>Branch: Rome.</i>	
STANDARD TELEPHONES AND CABLES, LIMITED.....	<i>London, England</i>
<i>Branches: Birmingham, Glasgow, Leeds, Manchester, Dublin, Cairo, Johannes-</i>	
<i>burg, Calcutta, Singapore.</i>	
STANDARD TELEPHONES AND CABLES (AUSTRALASIA), LIMITED.....	<i>Sydney, Australia</i>
<i>Branches: Melbourne, Wellington.</i>	
STANDARD VILAMOSÁGI RÉSZVÉNY TÁRSASÁG.....	<i>Budapest, Hungary</i>
SUMITOMO ELECTRIC WIRE & CABLE WORKS, LIMITED.....	<i>Osaka, Japan</i>
VEREINIGTE TELEPHON-UND TELEGRAPHENFABRIKS AKTIENGESELLSCHAFT,	
CZEIJA, NISSEL & CO.....	<i>Vienna, Austria</i>
<i>Branch: Tallinn.</i>	
STANDARD ELECTRIC COMPANY W POLSCE SP. Z O. O.....	<i>Warsaw, Poland</i>

Sales Offices and Agencies Throughout the World
