



~~FILE COPY~~

~~Not to be removed from
the offices of Electrical
Communication.~~

ELECTRICAL COMMUNICATION

APRIL

No. 4

1932

VOL. 10

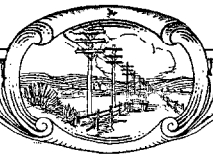

ELECTRICAL COMMUNICATION

A Journal of Progress in the
Telephone, Telegraph and Radio Art

H. T. KOHLHAAS, Editor

EDITORIAL BOARD

J. L. McQuarrie F. Gill G. Deakin P. E. Erikson G. H. Nash John W. Foard
G. E. Pingree P. K. Condict E. A. Brofos E. M. Clark Frank C. Page

Published Quarterly by the

International Standard Electric Corporation

Head Offices

67 BROAD STREET, NEW YORK, N. Y., U. S. A.

European General Offices

CONNAUGHT HOUSE, ALDWYCH, LONDON, W. C. 2, ENGLAND

G. E. Pingree, President

S. G. Ordway, Secretary

James E. Fullam, Treasurer

Subscription \$3.00 per year, single copies 75 cents

Volume X

APRIL, 1932

Number 4

CONTENTS

	PAGE
TELEPHONE PROBLEMS AND PROGRESS IN RUMANIA.....	175
<i>By G. A. Ogilvie and Bruce H. McCurdy</i>	
A NEW VOICE FREQUENCY TELEGRAPH SYSTEM.....	184
<i>By J. A. H. Lloyd, W. N. Roseway, V. J. Terry and A. W. Montgomery</i>	
AN AUTOMATIC CONCENTRATION UNIT FOR PRINTING TELE- GRAPH CIRCUITS.....	200
<i>By G. S. Vernam</i>	
DIRECT PRINTING OVER LONG NON-LOADED SUBMARINE TELEGRAPH CABLES.....	210
<i>By M. H. Woodward and A. F. Connery</i>	
BALANCING CABLES BY INDUCTIVE NETWORKS.....	218
<i>By M. I. Pupin</i>	
MODERN LOADING EQUIPMENT.....	223
<i>By J. B. Kaye</i>	
HONGKONG-CANTON TOLL TELEPHONE CABLE.....	237
<i>By P. T. Carey and R. E. Burnett</i>	

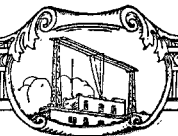

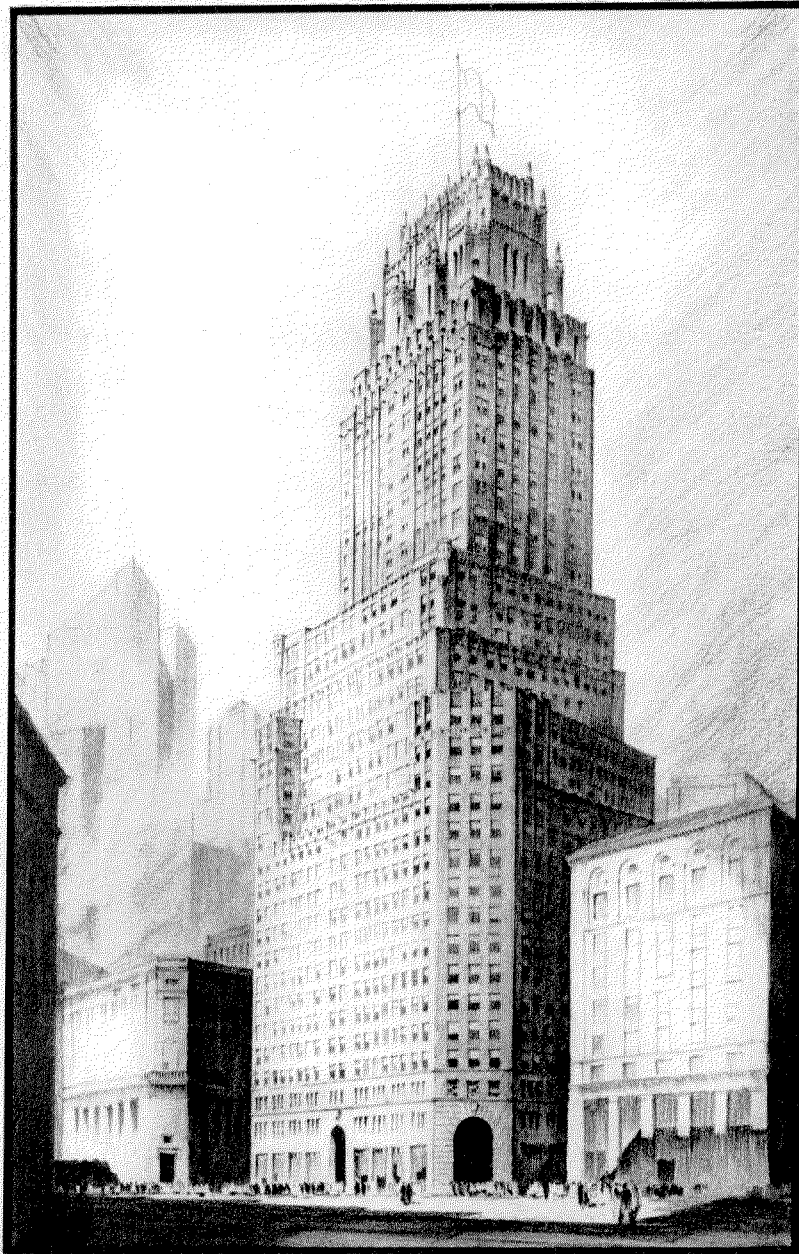

INTERNATIONAL TELEPHONE BUILDING
67 Broad Street, New York

Telephone Problems and Progress in Rumania

By G. A. OGILVIE

General Manager, Societatea Anonimă Română de Telefoane

and BRUCE H. McCURDY

Engineer of Toll Lines and Transmission for Rumania

ON January 1st, 1931, the Societatea Anonimă Română de Telefoane, an operating company in the International Telephone and Telegraph group of companies, took over the operation of the telephone network, both local and toll, of Rumania. This network included 1380 exchanges with approximately 52,000 stations and a toll network of over 56,000 circuit kilometers spread over an area of 122,282 square miles (316,700 square kilometers). In general, the plant and equipment taken over was in fairly good condition. However, in the local plant, equipment ranging from the earliest magneto to the latest rotary automatic has been found, while in the toll network it has been necessary to deal with numerous completely different types of construction and with circuit arrangements varying with almost every kilometer. The problem of welding such a network into a unified system and of providing economically the necessary additions to handle the traffic demand over the period of reconstruction has been one of great complexity and unusual interest.

Development of Toll Service

With the exception of Bucarest, where there was a very large unsatisfied local demand for service, the most urgent requirement has been for an amplification and improvement of the toll service, especially that between Rumania and other points in Europe. Fortunately it was in this very field that the greatest amount of immediate relief could be given. This relief took the form of (a) new circuits provided by carrier, (b) new circuits obtained by the phantoming of existing wires, (c) stringing of new copper circuits and (d) the bettering of service by means of transmission cleanups and revision of routings.

a). Carrier Development.

Within three months of the taking over of the plant a C-S-3, three-channel Standard Electric

carrier system was installed between Bucarest and Timișoara over an existing 4 mm. bronze circuit (Figure 1). A month later a second similar system was installed between Bucarest and Oradea with repeaters at Brașov and Cluj (Figure 1). The terminal points for these first systems were selected with a view to getting as wide a distribution of new high-grade circuits as possible. Individual channels were extended over new or existing voice frequency circuits and as a result it was possible with these two systems to obtain direct circuits from Bucarest of 6 db equivalent to Timișoara, Oradea, Budapest and Vienna, none of which, with the exception of Timișoara had been provided with such direct circuits before.

With the opening of the direct circuits to Budapest and Vienna it was possible to offer to the public international service not only between Rumania and the two capitals involved but also to the majority of the countries in Europe. Some advertising was attempted as soon as the new circuits were put in service but the flood of traffic was such that it had to be discontinued almost immediately and steps taken at once to provide still more facilities for international service. The same proved true in the case of the new and better internal service made possible by these systems.

The provision of more facilities by carrier presented a number of very complex engineering problems. The two systems already installed to the west had utilized the only existing pole line routes suitable for carrier. Although the working of more than one carrier circuit over the same line is quite feasible, there were serious difficulties in the particular case in question since in no case where parallel systems were desired were there available two circuits of the same gauge and characteristics. Extensive tests were made, however, and a system of transposition designed to allow working a single channel system (D-1) between Bucarest and Brașov over the same

route utilized by the Oradea system and a second (DA-1) between Bucarest and Szeged (Hungary) over the route of the Timișoara system. These systems were installed in July and August respectively and, as predicted by the preliminary calculations, the voice frequency crosstalk between interfering channels in both cases was less than 600 units (over 7.4 népers). As a commentary on the results possible with such carrier systems it is interesting to note that the Bucarest-Szeged DA-1 system—which forms a part of the direct Bucarest-Budapest circuit—works without an intermediate repeater over a line consisting of 563 km. of 4 mm. plus 109 km. of 3 mm. and 1.3 km. of toll entrance cable, is by-passed at three points and still allows a 3.0 db circuit to be obtained for the carrier portion of the circuit. The normal noise on this circuit is less than 200 units. In fact, the quality (see Figure 2) and stability of this circuit was such

that it was selected as the most suitable circuit for use in the recent demonstration between Washington and Bucarest and gave perfect results.

Up to the present Bucarest has been provided with the following new direct international circuit groups, all by means of carrier within the Rumanian territory:

Bucarest-Paris.....	1
Bucarest-Vienna.....	1
Bucarest-Budapest.....	2
Bucarest-Prague.....	1

A second Bucarest-Vienna and a Bucarest-Berlin circuit are now being provided for by replacing the DA-1 with a three-channel (C-N-3) system between Bucarest and Szeged.

In the case of all of these international circuits the greatest co-operation has been shown by the Hungarian Administration of Posts and Telegraphs, who have provided in their territory open

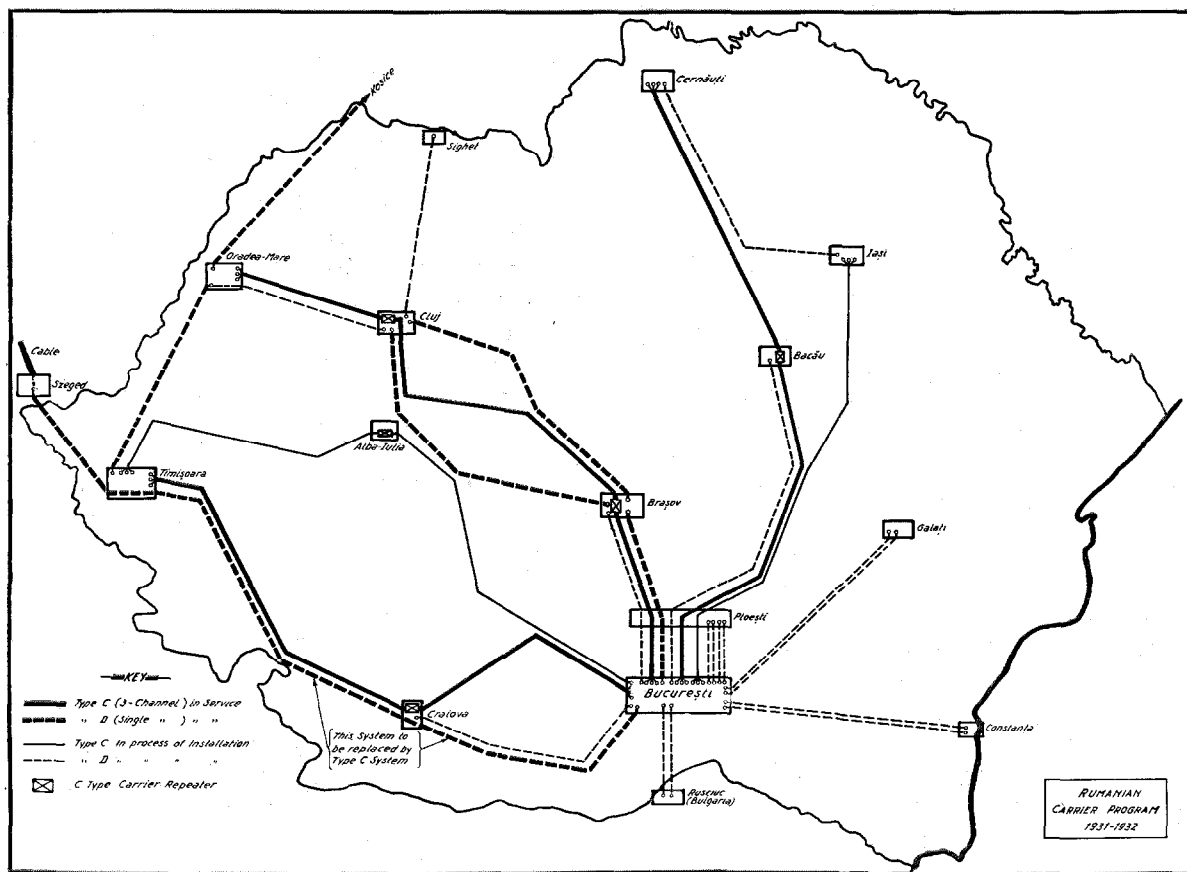

Figure 1—Rumanian Carrier Program, 1931-1932.

wire circuits from the Rumanian frontier to their cable terminals at Szeged and Solgnod as well as cable circuits from these points to Budapest and beyond.

Shortly before the installation of the two type D systems mentioned above, a third three-channel (C-N-3) carrier system was installed between Bucarest and Cernaui. Here again the question of interference had to be solved since between Bucarest and Ploesti, a distance of 65 kms., this system utilized the same pole line as the Bucarest-Oradea C-S-3 and the Bucarest-Brasov D-1 systems. As a further complication the Bucarest-Timisoara and the Bucarest-Szeged DA-1 system utilized this same pole lead for the first 15 km. out of Bucarest. By proper segregation and transposition and adjustment of

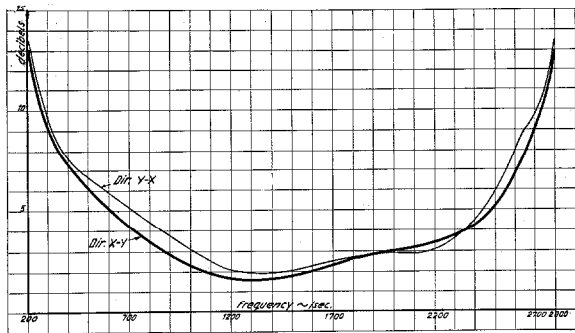

Figure 2—Overall-Loss-Frequency Curve, Bucaresti-Szeged, DA-1 Carrier System.

energy levels, however, it has been possible in every case to reduce the voice frequency crosstalk between interfering channels to less than 600 units.

So successful has carrier proved in Rumania that as soon as it was possible definitely to predict traffic demands, three additional type C three-channel systems and 15 type D and DA single channel systems were placed on order, three of the D systems actually being in service at the time of preparing this paper. The rest are to be installed as indicated in Figure 1. In the majority of instances it has been found possible to install these systems without extensive re-transpositions except where more than one system is to be used on a lead, the only transpositions cut in for the case of single systems on a lead being those necessary to eliminate absorp-

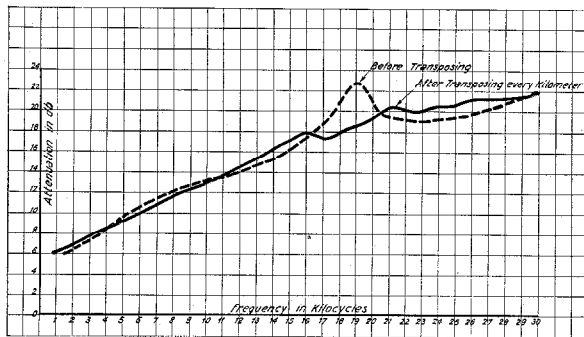

Figure 3—Attenuation-Frequency Curve, Bucaresti-Craiova, 4 Mm. Circuit.

tion points (Figure 3). Between Bucarest and Ploesti, where there will be a high concentration of both C and D carrier systems, an elaborate system of carrier transposition is being made. In order to obtain the greatest efficiency out of such transpositions the standard International Telephone and Telegraph point transpositions (Figure 4) will be used rather than the rolling transpositions normally employed on voice frequency lines.

b). New Phantom Circuits.

In the toll plant taken over it was found that practically no use had been made of possible phantom facilities. Only one phantom circuit of commercial grade, and this one only approximately 60 km. in length was in operation in January of 1931. It was decided, therefore, in order to meet the requirements for shorter-haul

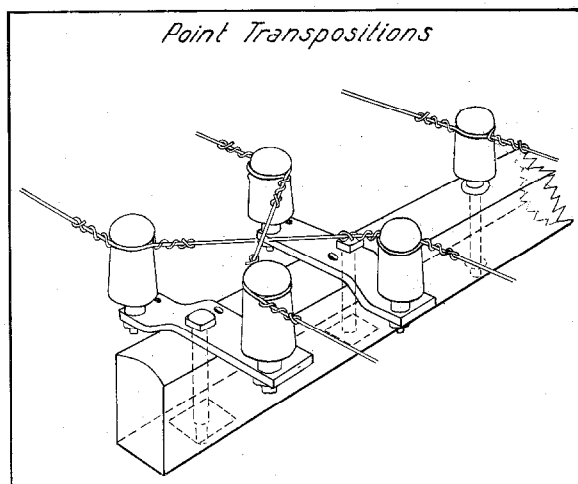

Figure 4—Point Transpositions.

the quality leaves considerable to be desired. This particular super-phantom, however, has proved very satisfactory for terminal connections between Oradea and Cluj and is actually being commercially exploited. All of the regular phantoms put in service in Rumania during 1931 have proved very satisfactory both from the standpoint of quality and dependability and are being used indiscriminately with physical and carrier circuits for both short-haul and long-haul service.

c). *New Copper Circuits.*

Of the 10,000 circuit kilometers added to the Rumanian toll plant in 1931 less than 250 circuit kilometers have required the stringing of new copper. Where new copper has been added it has, in general, been strung on existing types of supports and, wherever possible, it has been coordinated with existing wires to permit phantoming. Such new copper, however, has been kept at a minimum pending detailed studies of future routes and of the condition of the existing pole plant.

d). *Transmission Improvement and Toll Centering.*

In addition to an actual lack of facilities two other hindrances to good toll service were found

to exist. In the first place the majority of circuits were found to be low in insulation and to contain high resistance joints, etc., with the result that the actual transmission losses were high and the noise almost generally considerably beyond allowable limits for efficient service. In the second place the arrangement of the circuits was such that effective and efficient toll routings for via business could not be given. By means of an extensive program of transmission measurements to locate faults and to determine actual transmission losses with a subsequent clean-up program on all lines found to be in trouble, a very decided step toward eliminating the first of these hindrances has been made. Simultaneously, and with the aid of the transmission results obtained through this general transmission improvement program, the second of these hindrances has been attacked through the agency of a combined traffic and transmission study which has taken the form of a general toll centering plan similar to that now in force in the United States. In general, this plan consists of providing extra high-grade facilities interconnecting a certain few strategically located concentration centers. These centers are in turn provided with high grade circuits to all toll

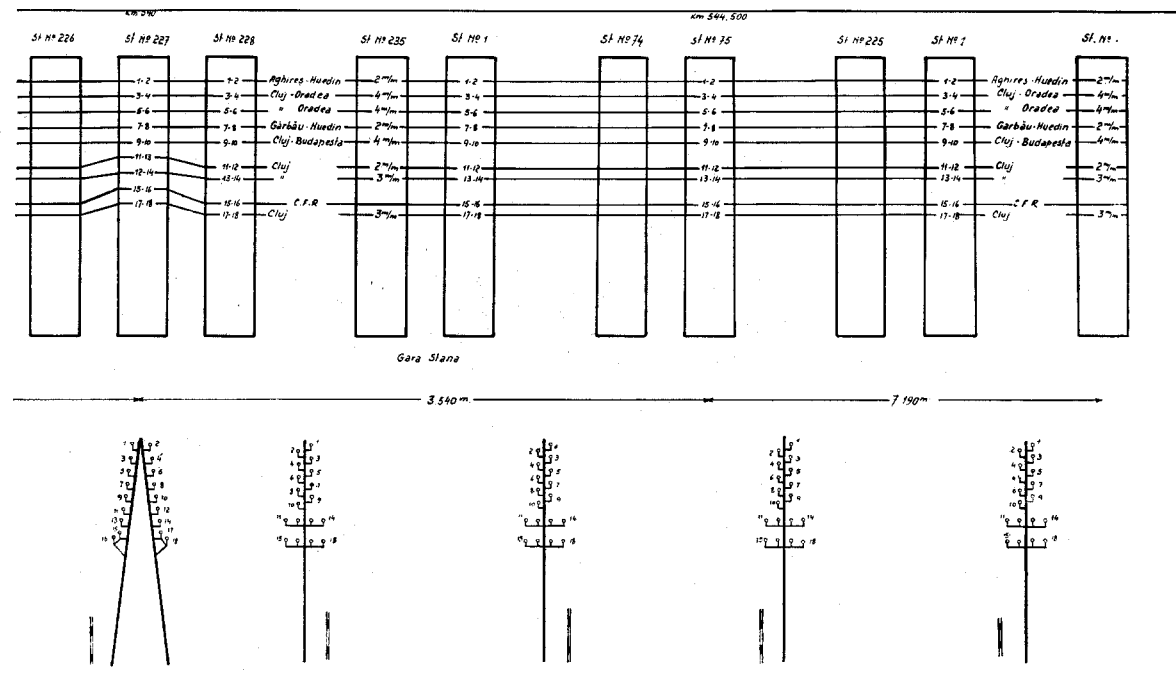

Mounting Encountered on Toll Lines.

centers in the areas immediately surrounding them. By coordinating the traffic and transmission factors involved, there is being set up a general switching plan which will allow extending toll service to all points in Rumania with the minimum possible increase in circuit groups and in expenditure for improved transmission on secondary lines which are used primarily for short-haul traffic.

The region around Cluj may be taken as an instance of the operation of the new switching plan. Turda, Dej, Bistrița and other towns immediately surrounding Cluj (Figure 6) all were found to have potential traffic to Bucarest and beyond, both in Rumania and to points outside of Rumania. Under the arrangement of circuits in existence the first of the year practically none of these points could talk beyond Braşov in the direction of Bucarest or beyond Oradea to the West. Under the new plan all of such points are

concentrated at Cluj which in turn is provided with a high grade circuit to Bucarest. The result has been that every one of the above points is now in quick contact with Bucarest at transmission losses well within the permissible transmission range and through Bucarest can be connected to the remainder of the country as well as to the rest of Europe over the international network terminating at Bucarest. All this was accomplished through certain circuit rearrangements which permitted setting up a high grade Bucarest-Cluj circuit and the concentration of the centers at Cluj over circuits of suitable grade. Incidentally, the demand for traffic from these centers has grown to such an extent that it will be necessary to increase the Bucarest-Cluj facilities by adding two circuits before the end of 1932.

The main network of high grade circuits which will be available for 1932 is illustrated in Figure

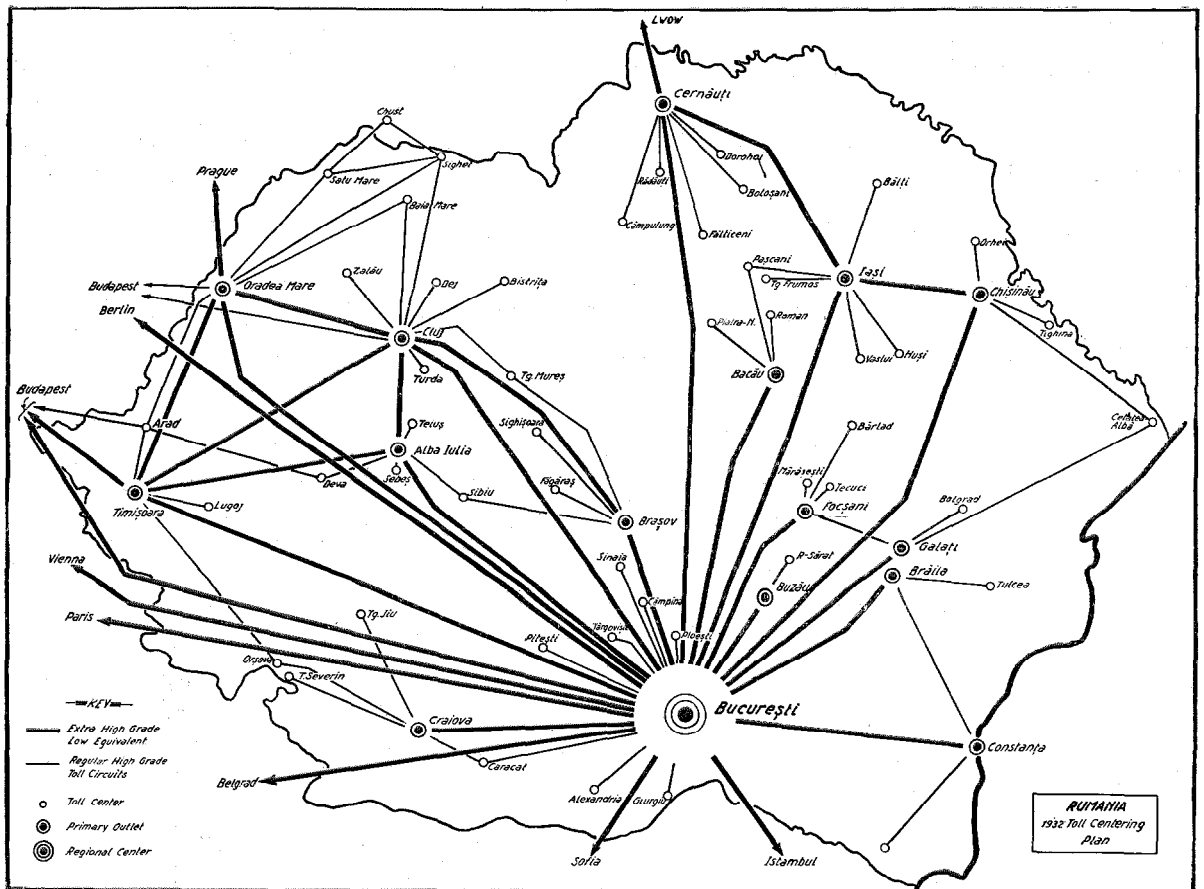

Figure 6—Provisional Toll Centering Plan for 1932.

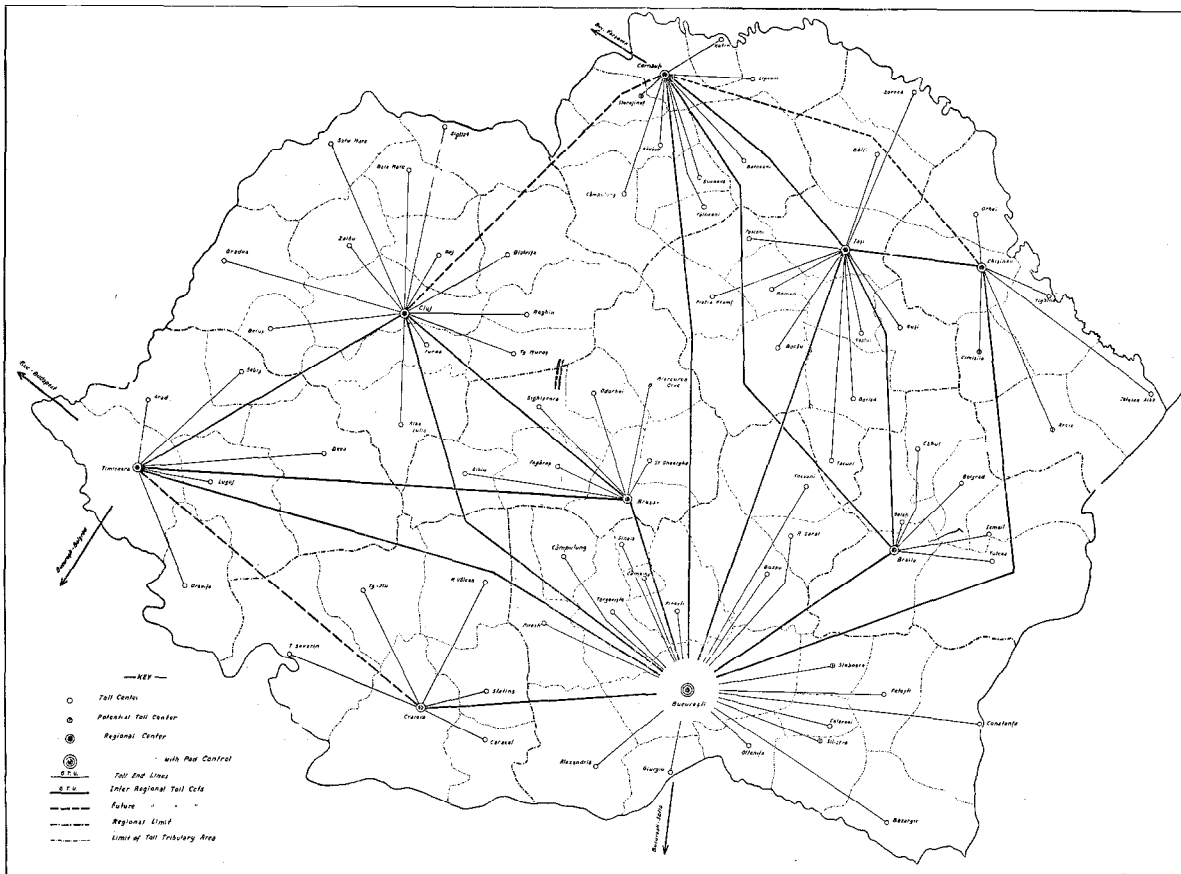

Figure 7—Final Toll Centering Plan for Rumania.

6. This will undergo some modification as new circuits are added and will within a few years be reduced to the final toll centering plan shown in Figure 7. As will be noted the final plan reduces the number of major concentration centers of the type mentioned above from 15 to 9.

Growth of Toll Traffic

By means of the additional facilities mentioned above (i.e., carrier, phantom and new copper) over 10,000 circuit kilometers have been added to the toll network during 1931. Due to the large use of phantoms and carrier this has been accomplished more economically than would have been the case if the circuits had all been provided by new 3 mm. copper. As a result of these additions and the more efficient utilization of existing circuits obtained by the transmission improvement and toll centering programs, the toll traffic has increased at a surprising rate, as

will be seen from Figure 8, at a time of increasing economic strain when in almost every other part of the world toll traffic has been decreasing.

Development of Local Service

The existing local plant in Rumania utilizes for the most part, except in Timișoara and Bucharest, open-wire circuits which are carried on poles along the streets or on special roof-top structures of the type shown in Figure 9. Considerable difficulty is being experienced in adding to this open-wire plant due both to the over-loaded condition in which these lines are found and to the objection of having more open-wires hung in the central business areas where the exchanges are usually located. In certain cases, where the demand for new circuits has been especially urgent, it has been found possible and economical to install short sections of aerial or block cable in the central portions of the town. In the

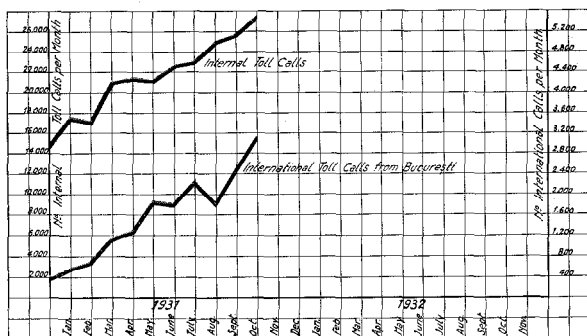

Figure 8—Toll Calls Completed Per Month.

majority of instances, however, immediate relief has had to be confined to such bettering of existing service as could be obtained by clearing the numerous cases of trouble which have been found to exist in both plant and equipment. A very large amount of this type of work has been done with a very marked increase in the grade of service given to the public.

In Bucarest, on the other hand, it has been possible to coordinate additions to both plant and equipment with the plans for the ultimate conversion of all Bucarest to automatic. Twenty-four hundred lines of automatic equipment with its accompanying outside plant have been added to care for new subscribers in the existing automatic area and to allow taking over temporarily a small portion of the existing manual area. The plant and switchboard facilities released in this way were thus made available for additions in the manual area. In Ploesti, the first city in Rumania to be completely converted, a new rotary automatic exchange is practically ready for cutover.

The problem of converting Bucarest entirely to automatic is presenting a number of very interesting engineering problems, chief among which has been that of determining the most economic arrangement and location of exchanges. Based on detailed commercial studies of expected growth by city blocks, various trial distributions are being engineered using one, two, three, four, and five separate exchanges. These studies are sufficiently well advanced to permit the preparation of more detailed engineering plans for the actual duct work and for a large portion of the initial cable plant. In fact, intensive work on this outside plant is now under full

headway and it is expected that by July of 1933 Bucarest will be fully converted to rotary automatic.

A second very interesting feature of these studies has been the consideration of the possible use of 26 gauge (0.4 mm.) cable circuits for a portion of the local distribution. This possibility has arisen as a result of three main factors. In the first place, in the toll fundamental plan for Rumania, a toll distribution of such characteristics is assumed that in the special case of Bucarest "toll terminal losses"¹ as high as 10 db may be allowed. This means that the local plant can be engineered for almost all combinations of gauges up to the extreme limits determined from purely local consideration.

The transmission standards actually met are:

- a). Maximum subscriber-to-subscriber loss²
 - Residential area to residential area 24 db
 - Residential area to business area 20 db
 - Business area to business area 18 db
- b). Maximum toll connection from limiting Bucarest subscriber to limiting subscriber in provinces 30 db
- c). Maximum toll connection from limiting Bucarest subscribers to limiting subscriber in main toll centers of Rumania 27 db

¹ The toll terminal loss is defined as the average of the transmission losses, transmitting and receiving, of the circuit from and including the subscriber's station to the toll line jacks at the toll switchboard.

² This includes, of course, the battery supply losses.



Figure 9—Existing Roof Type Local Distribution.



Underground Conduit Work in Progress in Bucharest.

It should be noted in connection with the above standards that whereas the design standards given are maximum values, actually very few connections will reach as high values of loss as those given in the tabulation. This is well illustrated in Figure 10.

A second factor which has led to a consideration of 26 gauge cable is the high efficiency of the present type Bell Telephone Manufacturing Company subset which will be used throughout Bucharest. Even discounting the increase in "effective transmission" due to the increased articulation and reduction of room noise obtained with the new set, a very material increase in efficiency is accomplished, as compared with the transmission from the older type sets.

A third factor which has extended the possible field of use of 26 gauge cable is the fact that whereas such cable, up to the present, was available only in the 1818 pair size, the International Standard Electric Corporation have recently announced that such cable is available in a number of sizes from 101 pairs to 1818 pairs, thus allowing a much more flexible layout following closely the actual need for circuits than

could be obtained when but one size cable was available.

Future Development

The future development of the toll network will, of course, be dependent upon the extent and volume of demand for additional service, which can only be determined as time goes on.

Detailed cost studies are now under way to determine the possible use of cable on the main toll leads. Although it is still too early for accurate prediction, it appears very probable that as traffic demands grow, certain of the principal open-wire leads will give way to toll cable.

In the local field plans are being prepared with a view to converting before the end of 1935, in addition to Bucharest, the following cities to rotary automatic: Arad, Brăila, Cernaui, Chişinău, Cluj, Constanţa, Oradea, Craiova, Galaţi, Iaşi, Ploeşti and Timişoara. As has already been mentioned the first of these, Ploeşti, is practically ready for cutover.

The problems which are being encountered in this development of the Rumanian telephone system are complex and interesting in the extreme requiring a knowledge on the part of the engineers of every new phase in the service and practice of electrical communication, and it is hoped that as the plans mature and the results obtained are analyzed a fund of useful knowledge covering all phases of telephone development will be obtained in a form in which it may be made available to all who are engaged in the samework.

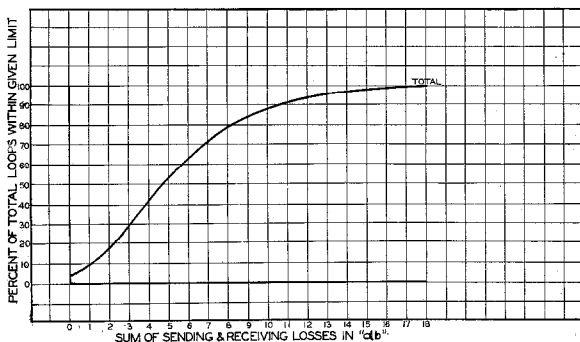

Figure 10—Bucuresti Loop and Trunk Study Two Office Plan, Number of Loops Within a Given Transmission Range. Bell Telephone Manufacturing Company Set.

A New Voice Frequency Telegraph System

By J. A. H. LLOYD, W. N. ROSEWAY, V. J. TERRY, and A. W. MONTGOMERY

International Telephone and Telegraph Laboratories, Incorporated

SYNOPSIS—This paper describes a new voice frequency telegraph system designed particularly to increase the total telegraph carrying capacity of any given voice frequency telephone circuit. Part I gives general details of the system, including notes on its uses and equipment features, and Part II covers the technical considerations involved in the development of the system.

PART I

General

THE Voice Frequency Telegraph System described in *Electrical Communication*, Vol. III, p. 288, has given good service for several years and is capable of continuing to do so for many more. However, improvements in the communication art and in apparatus design and equipment practice have offered opportunities to develop the more effective system described in this paper, which is intended primarily to provide up to 18 two-way telegraph

channels on a 4-wire cable circuit. Twelve-channel systems of this type are already in operation on 4-wire circuits in Great Britain and France.

In planning the new system, features of the old system which have proved to be most satisfactory were retained. Thus, the speed of signalling remains unaltered at 70 bauds per channel, and although the carrier frequencies have been spaced more closely together, they are still obtained from a motor generator, all being odd harmonics of a common base frequency, now 60

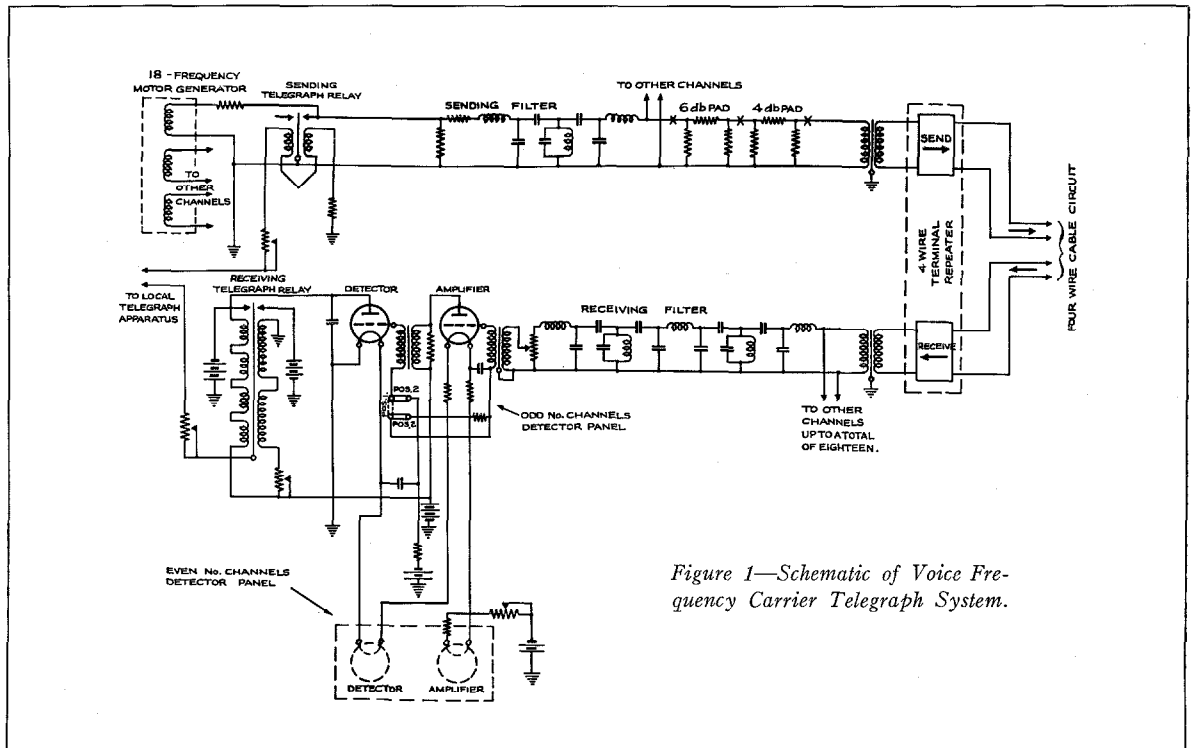

Figure 1—Schematic of Voice Frequency Carrier Telegraph System.

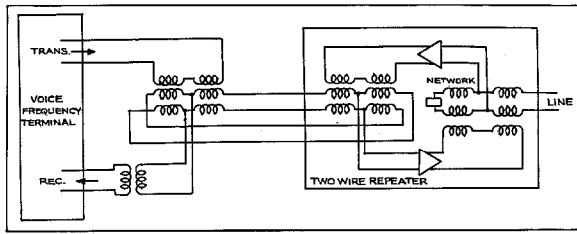

Figure 2—Circuit Arrangement for Two-wire Operation.

p.p.s. instead of 85 p.p.s. The frequencies actually used are shown in Table I, those of corresponding channels in the old system being given for comparison.

TABLE I.

Chan.	New	Old	Chan.	New	Old
1	420	425	10	1500	1955
2	540	595	11	1620	2125
3	660	765	12	1740	2295
4	780	935	13	1860	—
5	900	1105	14	1980	—
6	1020	1275	15	2100	—
7	1140	1445	16	2220	—
8	1260	1615	17	2340	—
9	1380	1785	18	2460	—

The considerable reduction of frequency range used for a given number of channels or, alternatively, the greater number of channels which can be obtained in a specified frequency range, gives the new system an important advantage. It is to be noted that in this, as in all other features dealt with by that body, the system meets the requirements of the C. C. I. T.

A simplified schematic of the complete system is shown in Figure 1. The general principle of operation of the circuit is self-evident, but detectors and filters demand fuller description, as does the equipment as a whole.

Applications

The system can be used over various types of circuit, the most usual of these being the 4-wire loaded and repeatered cable circuit. In this case the 4-wire terminating set used when the circuit is set up for voice transmission is removed and the transmitting and receiving terminals are each connected to one of the two pairs forming

the 4-wire circuit. The repeater gains along the line are not altered from their customary values, alterations in gain being made only at the terminal repeaters. It is to be noted that the repeaters are not in danger of being overloaded by the numerous telegraph channels—12 to 18 two-way channels in the usual case—as the maximum load with which each must deal is less than when speech is being transmitted, the maximum power at any point in the line, per channel, being of the order of 100 microwatts. In the operation of the system over actual circuits of this nature, variations in the line equivalent of as much as ± 8 db can be tolerated without any need for readjustment of the detectors.

If a 4-wire circuit is not available the system may be operated over a 2-wire circuit, the number of channels in this case being half that obtainable on a 4-wire circuit, since different frequencies are used for transmission in the two directions. The circuit is set up as if for voice operation except that, where not already in use, 2-wire terminal repeaters are added. A hybrid coil scheme, shown in Figure 2, is used to assist in separating transmitting from receiving frequencies.

Of many other possible circuits two may be taken as typical. In the first, indicated in Figure 3, provision is made for communication to and from points along the route. It is evident that different frequencies must be used for communication between A and B, B and C, and C and A, as all frequencies can pass over the whole route. The use of hybrid coils or 4-wire terminating sets at intermediate points enables minimum alteration to be made to the circuit when voice frequency telegraphy is substituted for speech. An additional advantage is that V. F.

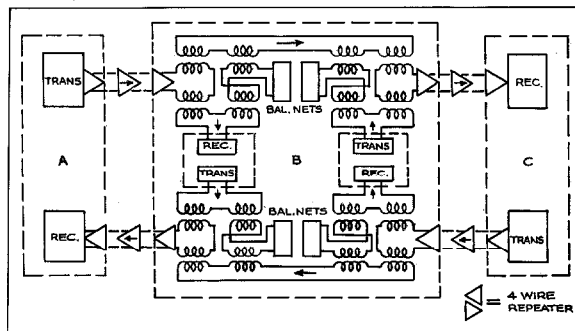

Figure 3—Telegraph Facilities at Intermediate Points (1).

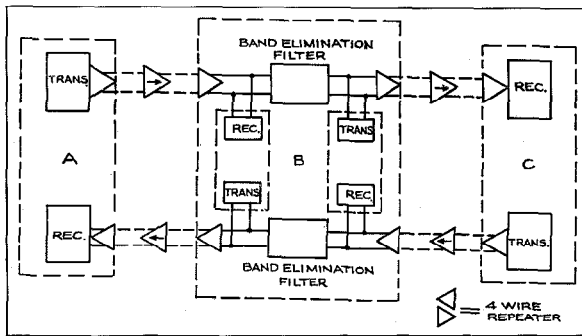

Figure 4—Telegraph Facilities at Intermediate Points (2).

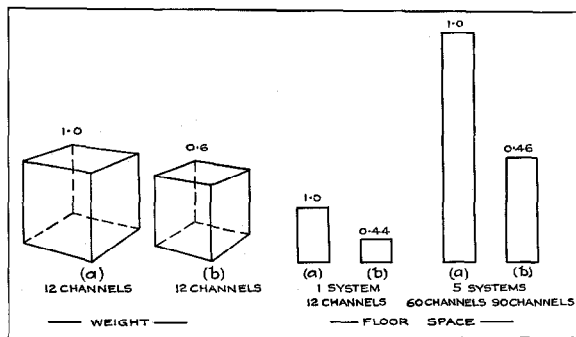

Figure 5—Relative Weights and Floor Spaces of (a) Old and (b) New Systems.

telegraph equipment at the intermediate point can be removed from the circuit if required without interfering in any way with the operation of the end-to-end channels.

In the second circuit, shown in Figure 4, communication is also provided for intermediate points. Since in this arrangement filters are inserted in the line, frequencies already used for communication between one terminal and the intermediate point can also be used for different messages between the intermediate point and the other terminal.

Equipment Features

In giving the circuits physical form, equipment practices and apparatus designs which have been prepared for general use on all toll systems were adopted. As more complete descriptions thereof will appear at a later date, it is only necessary to deal with them briefly in so far as they affect the system described in the present paper.

Three types of bay are used, these being:

- (a) Channel bay equipped for 6 channels.
- (b) Battery supply and generator bay capable of mounting circuits for ten 18-channel 4-wire systems.
- (c) Fuse bay, capable of mounting circuits for five 18-channel 4-wire systems.

Each bay has an iron framework 10 ft. 6 in. high, and occupies a floor space of 1 ft. 8¼ in. x 1 ft. 3 in. An eighteen-channel system requires five bays, i.e., one fuse bay, one battery supply and generator bay and three channel bays, and so occupies a floor space of 8 ft. 5¼ in. x 1 ft. 3 in. Figure 5 affords an interesting comparison between the sizes and weights of a 12-channel system of the new and old types.

By mounting individual pieces of apparatus on one side of a mounting plate only, with all wiring tags towards the front of the panel, it is possible to equip panels on both sides of a rack framework. With newly developed mounting plates and apparatus this proves to be an eco-

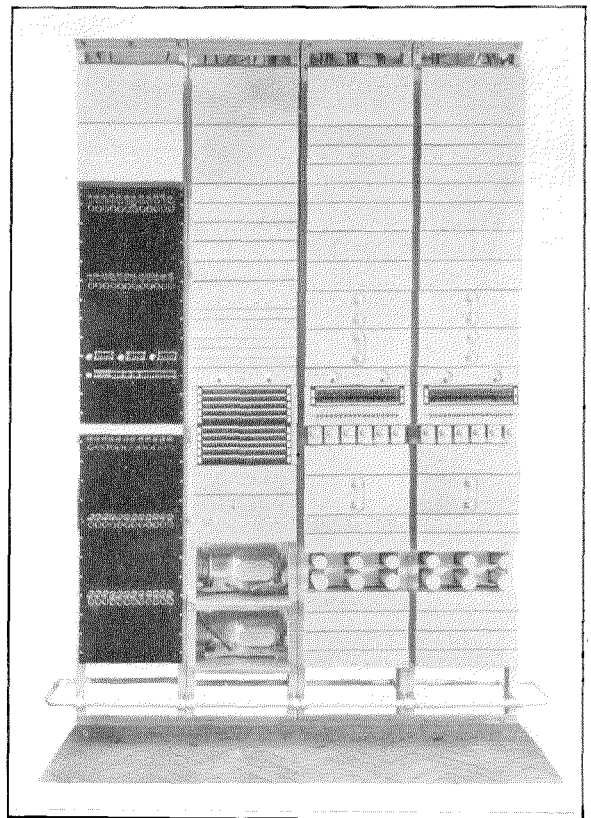

Figure 6—Complete Equipment, Front View.

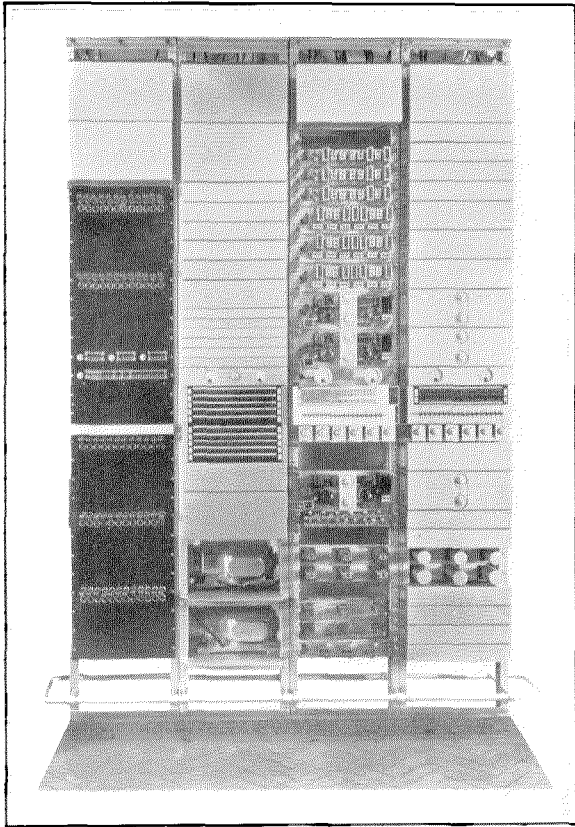

Figure 7—Complete Equipment, Front View, Showing Covers Removed From One of the Channel Bays.

nomical solution of the equipment problem. Wiring remains entirely accessible and complete circuits are to be found on each side of the rack.

All panels project from the rack by a uniform amount ($3\frac{3}{4}$ in.), and covers of this height are provided for most panels. This applies also to the main terminal strips at the top of the bays which are mounted on both sides of the rack, staggered relatively to each other on the two sides to make wiring accessible. Where apparatus, such as jacks, keys, meters, etc., must be continuously visible for operating reasons, other arrangements are made, and these can be seen from the photographs, Figures 6, 7, and 8, which also show the general appearance of the system. A mounting of particular interest is that for jacks and keys. This is hinged so that the single-sided mounting system can be adhered to while still keeping the wiring accessible. The cable form leading to the jacks or keys hinges from the main cable form, which runs along the inside

of the channel irons of which the racks are made.

It was decided to abandon the practice of connecting meters permanently in the local telegraph sending and receiving legs (formerly necessary when the concentration of so many channels on one bay had not been accomplished) and to provide one set of meters, located on each side of a bay, for use on any channel by simple patching between jacks provided in the jack field.

A special meter incorporating a metallic oxide rectifier is used for measuring the output voltages from the various windings of the voice frequency generator.

Protection has been provided by the use of resistance lamps in plate and telegraph circuits and by fuses in filament circuits, lamps and fuses

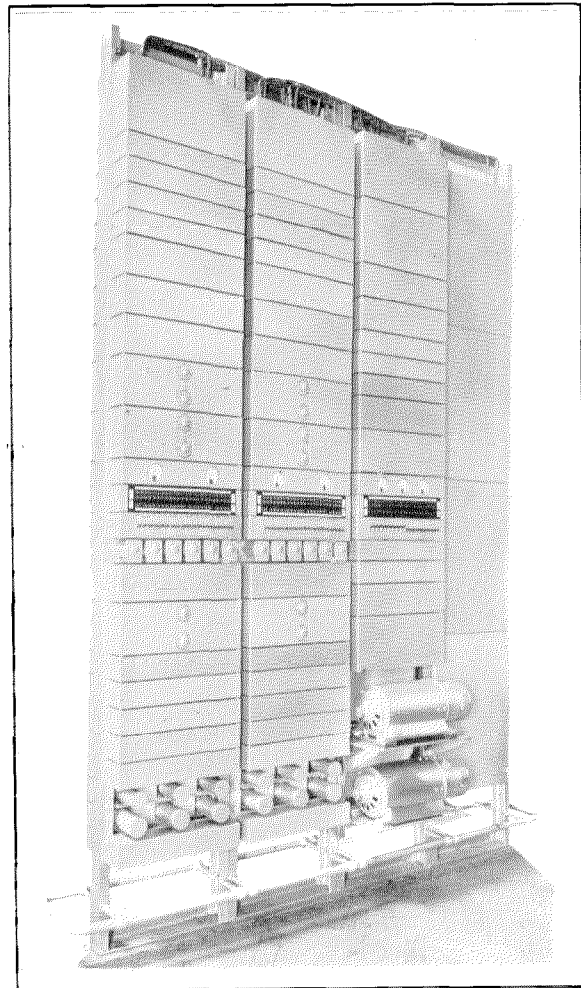

Figure 8—Complete Equipment, Rear View.

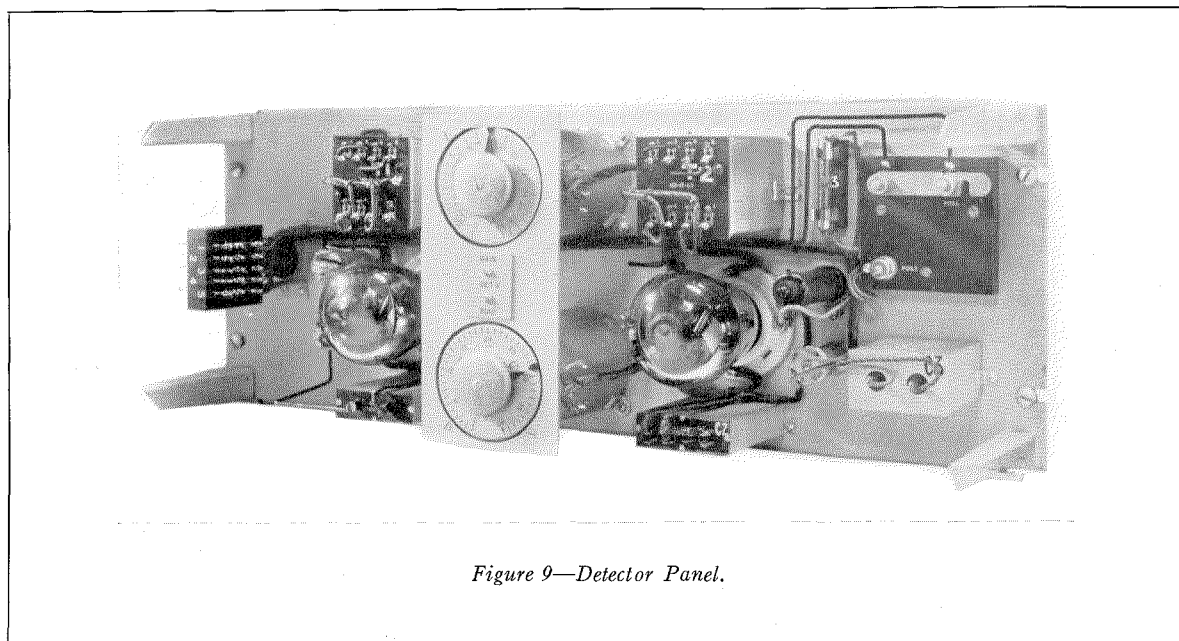

Figure 9—Detector Panel.

being mounted on panels made from Sindanyo, a fire-resisting compound. Dummy panels on the fuse bay are also of this material. The customary alarm circuits indicate failure of any of the current supplies.

New Apparatus

Of the new apparatus designs which have assisted in enabling the new equipment ideas to be put into practical use, the following may be briefly mentioned:

Mounting Plates—The use of thin steel mounting plates (0.078 in. thick) strengthened by means of a double flange running across their lengths has contributed to the reduced weight of the equipment. All apparatus is held to these plates by means of screws, this type of plate being very easy to drill and tap. A detector panel of the system, shown in Figure 9, illustrates these points.

Condensers—Paper condensers have been reduced in size by the use of "Halowax" as an impregnating compound; a more constant temperature-capacity curve also results. A new manufacturing process applied to mica condensers has led to better stability and reduced losses, phase angles regularly obtained being of the order of $\frac{1}{2}$ minute.

Coils—As Permalloy has been used in the

cores of the transformers, repeating coils and inductances, a considerable reduction in size has been possible without detriment to efficiency. A note on the coils used in the filters appears elsewhere in this paper.

Mouldings—Much use has been made of moulding in producing the new apparatus. Resistance spools and valve sockets have been moulded in Steatite, and many parts of a new potentiometer are formed of a moulded phenol product.

Valves—Two valves of different types are used in each detector. Both take 0.25 amp. filament current, and as the valves of two detectors are connected in a series filament circuit, the total filament current drain for an eighteen-channel system is thus only 2.25 amps.

PART II

TECHNICAL CONSIDERATIONS INVOLVED IN THE DEVELOPMENT

In order to make clear the reasons for using the types adopted it is necessary to enter into some discussion of what is involved in the reception of voice frequency telegraph signals.

The essence of any telegraph channel is that it should indicate at one end the instant at which changes of some sort or another are

effected at the other end, although a delay in the indications is immaterial so long as it is the same for all changes.

With some telegraph codes it is essential also to distinguish between different kinds of changes made at the transmitting end; but with the majority of codes it is otherwise. In the latter the changes (or signals as we shall presently call them) may be of one sort only, or of two sorts identical except in sense, in which case they are used alternately to prevent cumulative changes in the telegraph channel; the Morse (land) code, the teleprinter code and the Baudot code are examples of this class. It might at first sight be thought that these codes demand the ability to distinguish between marking and spacing currents, but this is not so; in each the beginning of a letter, word, or message can be identified by consideration only of the intervals separating signals; thus, in the Morse code an interval of five time units precedes the beginning of each word, in teleprinter code an interval of a definite fractional number of time units denotes the beginning of a letter, and in the Baudot code the synchronising signal, recurrent at intervals of 12, 17, or 22 time units, provides the same information, though not so readily. There are, nevertheless, several disadvantages attaching to a telegraph channel that is not inherently capable of distinguishing between the signals which start marks (positive signals) and those that stop them (negative signals). Of these the most important is that all automatic telegraph receivers at present available require the first signal of every message to be of the same polarity, and a special attachment would be necessary to make them independent of such restriction.

With these considerations in mind it is interesting to review some of the large number of methods which may be employed to convey telegraph signals through a channel using alternating currents restricted to a narrow band of frequency.

The first and second methods are closely related, signals being transmitted in one by momentary application of a current to the line, and in the other by momentary withdrawal of the current from the line. A third method consists in transmitting a steady alternating current whose phase is reversed for each signal (closely resembling double current working in ordinary

telegraphy). The almost universally adopted arrangement of transmitting an alternating current to indicate a positive signal and suppressing it to indicate a negative signal is a fourth method; and variations of this method in which positive signals are marked by the transmission of an alternating current of one frequency and negative signals are indicated by the transmission of current of another frequency constitute a fifth system. Because they make no distinction between positive and negative signals, the first three methods are unsuitable for

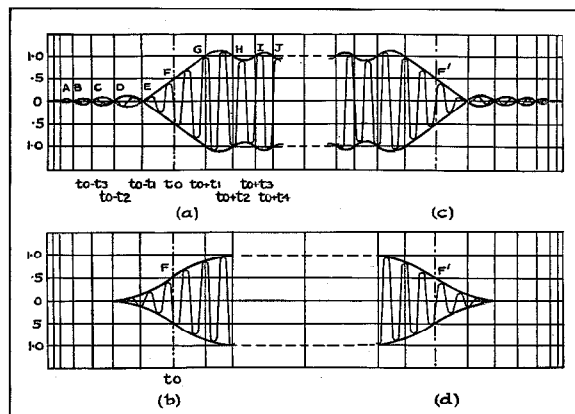

Figure 10-a, b, c, d—Oscillations Resulting From Positive and Negative Signals.

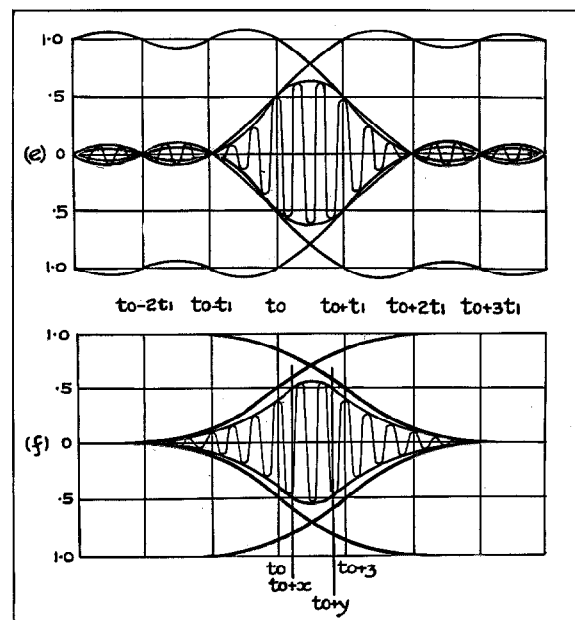

Figure 10-e, f—Oscillations Resulting From One Positive Signal Closely Followed by One Negative Signal.

general use; this is to be regretted, as they each possess considerable advantages. The fourth method has the beauty of simplicity and, compared with the fifth method, economises in both frequency range and selective circuits. In combination these economies are more than sufficient to justify the choice of the fourth method notwithstanding the difficulties that attach to it in actual practice. These difficulties centre round the slow but unavoidable variations which take place in the strength of the signals when transmitted to a distance, and will be best understood by consideration of the following simple example:

Imagine a telegraph channel consisting of a source of constant frequency oscillations whose output is controlled by a sending relay, a transmission path passing a narrow symmetrical band of frequencies, a rectifier, a low pass filter, and a receiving relay with controllable bias. For the sake of simplicity we may imagine that the frequency of the oscillations lies in the middle of the pass range of the transmission path, and that the phase change in transmission is proportional to frequency. It will further aid our consideration to assume that both relays are ideal, that is to say, that the sending relay acts instantaneously in response to control currents, and the receiving relay also operates instantaneously to mark or to space whenever the current in its windings rises above, or falls below, a given amount which is the effective bias current. With the assumptions made, the envelope of the oscillations after transmission would take on one or other of the forms illustrated in Figures 10 (a) and (b) following the transmission of a positive signal, (beginning of transmission of oscillations). The transmission properties assumed (which, although theoretically impossible of exact realisation, are good approximations to actual conditions) cause those envelopes to assume skew symmetry about the point F, at which the amplitude reaches half its steady state. Figure 10 (a) shows the kind of envelope resulting from a transmission path with sharp "cut-offs" at each end of the transmission range; more gradual cut-off would result in the envelope shown in Figure 10 (b). By control of the attenuation characteristic of the transmission path it is theoretically possible to make $t_1 = \frac{1}{2} t_2 = \frac{1}{3} t_3$, etc., a procedure which has big advan-

tages if it is necessary to signal only at a speed $\frac{1}{t_1}$ bauds.

Types of Detector Considered

The oscillations are not suitable for direct operation of the receiving relay, since the latter (being ideal) will follow the rise and fall of each oscillation which exceeds the value of the relay bias. The oscillations must therefore be rectified, and when this has been done a new current is obtained whose amplitude at any instant is related to that of the original wave at the same instant, but in general is not proportional to it. The rectified current is, however, still unsuitable for application to the relay since it reaches zero value as many times as the original wave, and would cause the relay to vibrate in a similar way. A low pass filter strongly attenuating all frequencies passed by the transmission path obviates this difficulty and produces a current having smooth variations. This filter (which in practice usually consists of the inductance of the relay and a single condenser in shunt) should pass a band of frequencies at least as wide as that passed by the original path, with uniform efficiency and linear phase change. If it fulfills these conditions and the rectifier has a simple characteristic without discontinuities, the output from the filter will be a current whose amplitude is a delayed replica of the envelope of the rectified current. Allowing for this delay (which, being constant, is of no effect) the value of the rectified current at any instant is dependent only upon the value of the original input to the detector at the corresponding instant, no matter whether the amplitude be rising or falling or constant.

From this it follows that the receiving relay will operate whenever the incoming oscillations pass through the value at which the rectified current counterbalances the relay bias, and the characteristic of the rectifier (so long as it is simple and not variable with respect to time) will not influence the transmission of signals at all. A special interest attaches to this property, although it is strictly true only for telegraphy with ideal relays, because of the great importance formerly attached to the form of static rectifier characteristics.

Referring to Figures 10 (a), (b), (c), and (d)

it is seen that if the intervals between the operations of the receiving relay are to be the same as those separating the original signals, the value of the relay bias must be equal and opposite to the rectified current corresponding to the amplitude of the oscillations at the points F and F¹, i.e., half the steady state amplitude. The repetition will not, however, be exact if the signals follow one another so closely that the transient oscillations associated with one have not died down before the arrival of the next. Figure 10 (f) illustrates the production of distortion in this way, by showing the oscillations resulting from the receipt of a positive signal followed after an interval z by a negative signal. The thin lines indicate the envelopes of the oscillations produced by the signals individually, and the thick line the result of combining the two. It will be seen that instead of operating at times t_0 and t_0+z the relay will operate at times t_0+x and t_0+y , introducing distortion $(x+z-y)$. Figure 10 (e) illustrates the interesting case in which transient oscillations introduce no such distortion, although the transients following the receipt of the positive signal are still quite strong when the negative signal arrives. The absence of distortion is due to the fact that the signals are transmitted at integral intervals of the period t_1 , and that at every such interval the envelope of oscillations passes through its initial or final value.

By resorting to this device a telegraph channel can be made to operate with small distortion at a speed in bauds closely approaching the band width of the transmission path; but because it cannot be made to work so well at all slower speeds the principle is not suitable for ordinary carrier telegraph systems. Accordingly, oscillations of the type shown in Figures 10 (a) and (c) will not be further considered, and it will be assumed that signals are transmitted at sufficiently wide intervals to avoid distortion of the type illustrated in Figure 10 (f).

The effect of varying signal strength upon the reception of signals will be seen on reference to Figure 11. If the relay bias is set for correct reception of the larger amplitude so that signals are received at times t_0 and t_1 , then if the amplitude of the oscillations is reduced to the smaller value the receiving relay operates at times t_0+

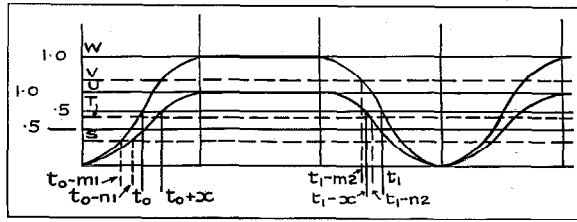

Figure 11—Effect of Variation of Amplitude on Detectors of Types 1 and 2.

x and t_1-x introducing a distortion of $2x$.

One method of overcoming this difficulty is to employ a detector of what we may call type 2. This differs from the one already considered (which we may call type 1) in that the sensitivity of the detector characteristic varies, not only with the load applied, but also with time.

Figure 12 shows the circuit for a type 2 detector and Figure 13 its characteristic.

For slow variations of input the rectified current follows the curve O P A C E both upwards and downwards, and P marks the point at which the peak input voltage exceeds the grid bias voltage and grid current commences to flow, charging up condenser C (Figure 12) and increasing the grid bias. If, when the current has the magnitude A, it is suddenly reduced before the condenser C has time to discharge through the resistance R, the rectified current follows the curve AB. Similarly a rapid descent from an input voltage corresponding to the points C or E causes the variation of rectified current to follow the curves C D O or E F O.

The use of a detector of this type in conjunction with a relay bias corresponding to the rectified current produced by amplitude OS (Figure 13) causes a positive signal to be received at time t_0-m_1 or t_0-n_1 according to the signal amplitude, and a negative signal to be received at time t_1-m_2 or t_1-n_2 . These time values are obtained by comparison between Figures 11 and 13 where it can be seen, for example, that OT is the input voltage giving the same rectified current when the input descends rapidly from the value OU, as is given with a rising input by the input OS; and if this be suitably chosen m_2 may be made equal to m_1 , and n_2 to n_1 , so that variation of input need not distort the signals. It is, of course, necessary for successful working in this way that the condenser C should retain its charge while the input current falls from OW

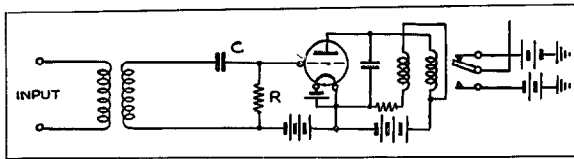

Figure 12—Schematic of Detector of Type 2.

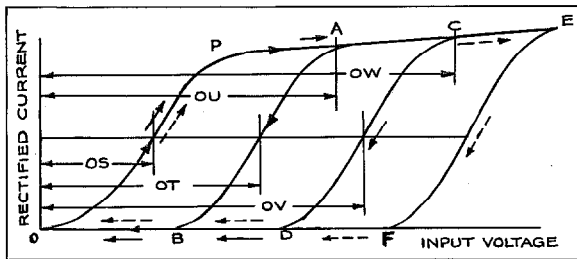

Figure 13—Hysteresis Characteristic of Detector of Type 2.

to OV, or from OU to OT, and yet it must be completely discharged in time for the next signal. In practice this cannot be done sufficiently well to prevent serious distortion without greatly reducing the speed of signalling, or having recourse to auxiliary apparatus such as a relay operated by the receiving relay and arranged to short-circuit resistance R during spacing periods, whereby the discharge of condenser C is hastened after the receiving relay has operated in response to a negative signal. Detectors of type 2 therefore lie between the Scylla of slow speed and the Charybdis of complexity.

Another and entirely different method of overcoming the difficulty of variation of amplitude is to use "impulse" working. This demands for perfection a detector (type 3) of which the output of rectified current is approximately proportional to the input of alternating current, together with a network the transmission efficiency of which from zero frequency up to a frequency equal to the band width of the transmission path is proportional to frequency, and which produces a phase change commencing at 90 deg., and varying uniformly with frequency. The output from such a network is a current whose magnitude is proportional to the rate of rise or fall of the input current, and it may therefore be called a "differentiating network." Figure 14 shows the result of applying to a differentiating network the current obtained by rectifying oscillations of the types shown in Figures 10 (b) and (d). The full lines show the results obtained

with isolated signals and the dotted line the result of positive and negative signals following as closely one upon the other as could be permitted in general practice. The relay used with such a combination should operate for a positive signal when the impulse current reaches the value OA, and should be arranged not to operate again for a negative signal until the current reaches the value OB ($OB = -OA$). The insensitivity of an ordinary relay may suffice but a sensitive relay with the holding arrangement shown in Figure 15 is better. Figure 14 also shows, in the difference between the full and dotted lines, the distortion introduced on account of the close proximity of adjacent signals. With the amplitudes shown this is small, but would greatly increase for larger amplitudes (equivalent to reducing OA and OB), since operation due to the first signal would be hastened relative to that due to the second. Given a linear detector, impulse working eliminates very completely the effect of amplitude variation in producing bias, but to avoid other forms of characteristic distortion the signalling speed for a given transmission band must be diminished, as the differentiating network considerably extends the time occupied by transients following a signal. Another difficulty with this form of detector is the large amount of power with which the detector has to deal without overloading. For example, for a range of ± 5 db in the efficiency

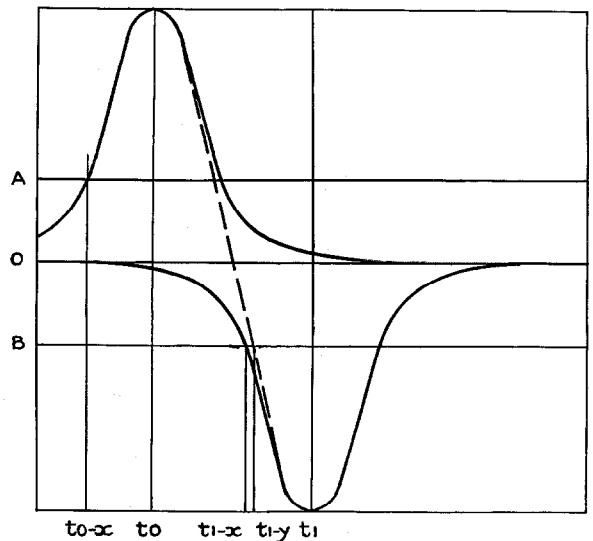

Figure 14—Impulse Working (Type 3 Detector).

of the transmission path, the detector must be capable of giving ten times the minimum power required for satisfactory operation of the relay. Impulse working also renders a telegraph system very liable to false operation by interference owing to the small force holding the relay between widely separated pulses.

When an impulse circuit is used in combination with a detector not having a linear characteristic, independence of amplitude is sacrificed but the disadvantageous sensitivity to interference may be reduced.

Description of Detector Finally Adopted

In an attempt to combine the advantages of a detector of type 1 with an ability to tolerate variations of amplitude, an amplifier detector has been devised in which the gain of the amplifying valve is controlled by the maximum value of the input voltage. For this purpose advantage is taken of the fact that with all ordinary telegraph systems the intervals not spent in the repose conditions are short, and by arranging that current is transmitted during repose periods, the gain of the amplifier may be kept adjusted and ready for signalling. It differs from an amplifier detector of type 2 in that during periods of no input the gain rises very slowly, so that no appreciable change occurs during the longest of such periods necessitated by the telegraph code. The gain is, however, reduced very rapidly to the required value upon the reception of alternating current, so that even a very short period in the repose condition will enable the detector to adjust itself.

It would have been possible to make an amplifier with this property which could have been used in conjunction with any detector of type 1, but it was found simpler to combine it with a detector in a somewhat different circuit to make what may be described as a detector of type 4, the circuit of which is shown in Figure 16. It consists of an amplifying valve, transformer coupled to a detector valve, and the special features lie in the method by which grid bias is supplied to the two valves. The return ends of the secondary windings of both transformers are connected together and to the filament circuit through a condenser and resistance. The filaments of the valves are connected in series

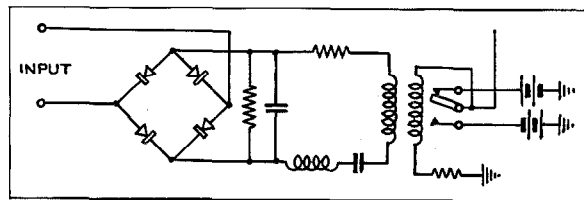

Figure 15—Schematic of Detector of Type 3.

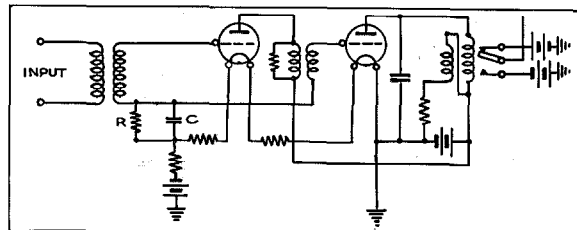

Figure 16—Schematic of Detector of Type 4.

through resistances, so that the amplifier has sufficient grid bias for efficient amplification when the detector valve has the minimum bias necessary to reduce its plate current to a very small value with no input to the detector. When the amplifying valve receives such input that, even when amplified, the peak voltage applied to the detector valve remains less than the original grid bias voltage, no grid current flows and the detector behaves as if it were of type 1. When, however, the input is increased beyond this amount, grid current flows, increasing simultaneously the grid bias of both valves. The amplifying valve has a higher amplification factor than the detector valve and is accordingly more affected, its gain being reduced while, to a less extent, the sensitivity of the detector is reduced also; the reduction continues until the peak value of the input to the detector is just a little greater than the new grid bias voltage. Hysteresis characteristics of the new detector are shown in Figure 17. They resemble somewhat the characteristics of a detector of type 2 but differ in an important respect which is made clearer in Figure 18. Here the characteristics are redrawn with the input voltage expressed as a fraction of the maximum value. It will be seen that, though with differing inputs rectified current starts at different fractions of the maximum input voltage, and though it reaches different maxima, yet for an input of half the maximum value it always produces the same rectified

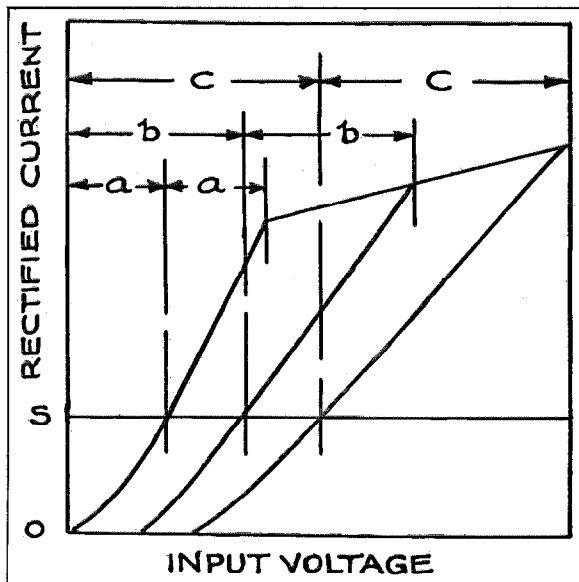

Figure 17—Hysteresis Characteristics of Detector of Type 4.

current. Since it is at the rectified current corresponding to an input of half the steady state value that the receiving relay must work, this is the most important consideration. It is interesting, however, to note the reason for the increase of maximum rectified current with input voltage. With large input voltages the grid bias of the amplifier valve is high and its output is much distorted by the introduction of even harmonics; one-half of the wave is low and long, the other is short and high. Since the positive peak voltage applied to the detector is adjusted almost to a constant value it is easy to see that the long low half wave rectified will produce a bigger current than the short high one. If the secondary of the interstage transformer is reversed so that the other half wave is rectified, the maximum rectified current will diminish with increase of input and an unsuitable characteristic like that shown dotted in Figure 18 will be produced. This characteristic is unsuitable, not because of the low value of maximum rectified current, but because it does not provide a constant value of rectified current for half the maximum input voltage.

A resistance is shunted across the primary winding of the interstage transformer to increase the sensitivity of the amplifier to change of grid bias. When the bias is altered the internal

impedance of a valve changes more rapidly than its magnification factor, but the voltage amplification obtained from a valve and transformer is almost entirely determined by the amplification factor if the load has a high impedance. With a low impedance load, variation both of impedance and amplification factor are effective to vary gain. Rather than use a different value of transformer inductance for each different frequency in order to obtain the correct low impedance in the plate circuit of the valve, a shunt resistance has been used which is suitable for any frequency within the voice range.

It is clearly desirable to supply the amplifier-detector with current during the repose condition so that its gain may remain suitable for the reception of signals whenever they may be transmitted. In teleprinter circuits, marking is usually the repose condition; hence alternating current is transmitted for a mark. For Baudot, on the other hand, spacing is the repose condition, and so, on channels used for Baudot or similar work, alternating current should be transmitted for a space. Any inversion of a channel necessary to fulfill this condition can be readily carried out

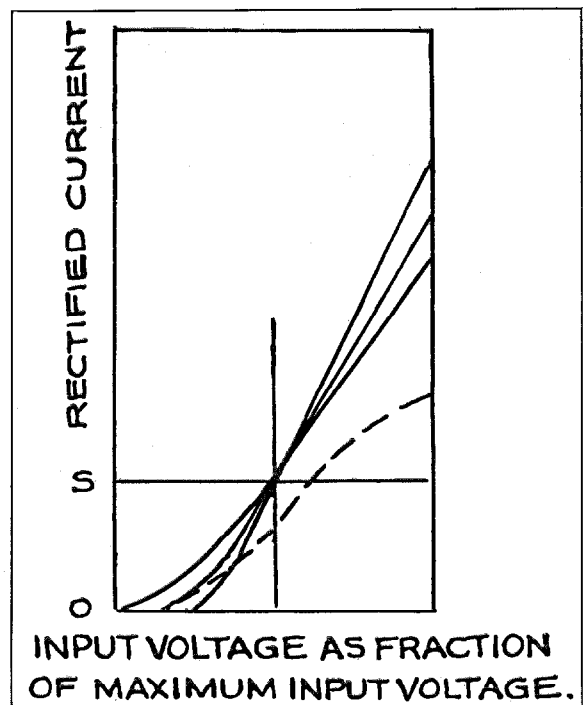

Figure 18—Hysteresis Characteristics of Detector of Type 4. (Input Voltage as Fraction of Maximum Input Voltage).

by keys provided on the system for reversing the sending relay and the receiving relay battery polarities.

It is necessary for the successful application of a detector of type 4 that the characteristic of the transmission path should not produce oscillations of the types shown in Figures 10 (a) and (c), since these, by rising above the steady state value, reduce the gain of the amplifier detector below its proper value. This condition is not normally met, since oscillations of this type are only produced by filters having a much squarer characteristic than can economically be used in practical systems.

Filters

As is always the case, the economical design of sending and receiving filters involved compromise between electrical transmission characteristics and cost.

As regards transmission characteristics the following general requirements had to be satisfied:

- (a) The attenuation characteristic was to be symmetrical about the mid-band frequency, i.e., the attenuations introduced by the filter at frequencies equidistant above and below the mid-band frequency to be approximately equal.
- (b) The phase characteristic was to be of equal and opposite symmetry about the mid-band frequency, to pass through zero at, and to approximate closely to a straight line ± 35 p.p.s. from, the mid-band frequency.

Among the particular transmission requirements to be satisfied, the following may be mentioned:

- (a) The attenuation of each receiving filter ± 35 p.p.s. from its mid-band frequency was to be not more than 2.5 db above that at its mid-band frequency.
- (b) The attenuation of each receiving filter ± 120 p.p.s. from the mid-band frequency, i.e., at the mid-band frequencies of the filters directly adjacent to it, was to be not less than 30 db above that at its mid-band frequency.

In view of the above requirements the so-called "confluent" band pass filter section of the constant k type has been employed as the basis of design, since it satisfies them very closely, and its simplicity makes it satisfactory economically. The use of derived or "m" type filter sections was considered, but they did not appear to offer any considerable advantage over the proto-

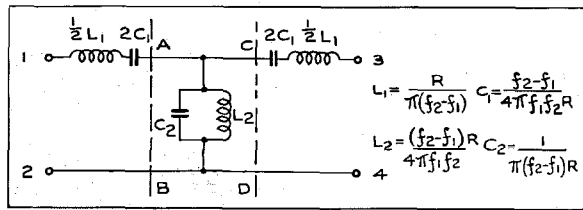

Figure 19—Prototype Band Pass Filter Section.

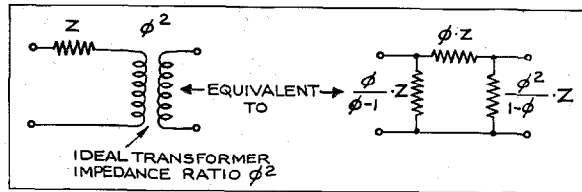

Figure 20—Equivalence Used in Designing Impedance Transforming Filter Sections.

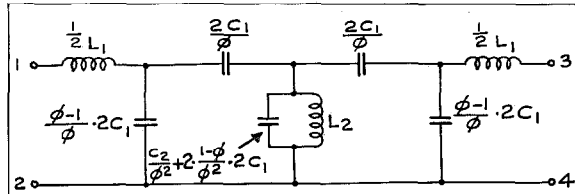

Figure 21—Band Pass Filter Section, With Internal Impedance Transformations Electrically Equivalent to Figure 19.

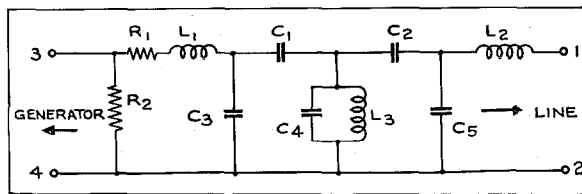

Figure 22—Sending Filter Schematic.

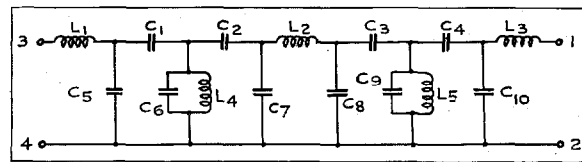

Figure 23—Receiving Filter Schematic.

type section, and their greater complexity would have increased the cost of the filters.

To satisfy the particular attenuation requirements, a single section has been used for each sending filter, and two sections for each receiving filter.

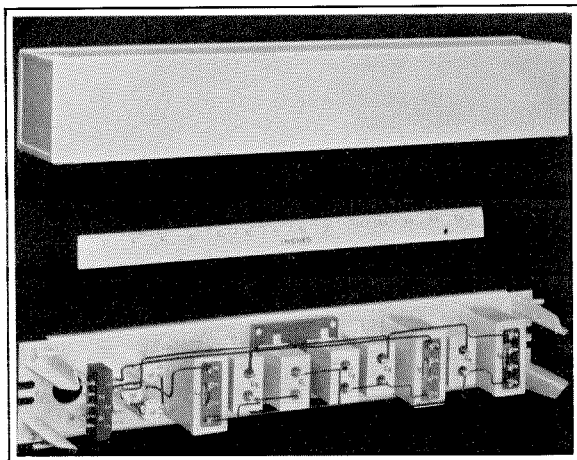

Figure 24—View of Sending Filter.

On Figure 19 is represented a full section, with mid-series termination, of the basic structure, together with the formulae for calculating the impedance elements. In these formulae f_1 and f_2 are the lower and upper cut-off frequencies, respectively, and R the impedances between which the filter is to be inserted, R for the filters concerned being a pure resistance of 600 ohms; the band width $(f_2 - f_1) = 120$ p.p.s.

From a consideration of the equations given in Figure 19 it is seen that the condenser C_2 is of constant magnitude if the band-width $(f_2 - f_1)$ and the impedance R are constants and, for the values of these factors given above, is found to be 4.421 μF . Further, since the band-width is small compared with the product of the cut-off frequencies, the formula for the inductance L_2 shows that the latter is of a relatively small value and decreases progressively as the frequency increases. At the lowest carrier frequency, 420 p.p.s., its value is 0.033 henrys; at the twelfth carrier frequency, 1740 p.p.s., its value is 0.0019 henrys; and at the eighteenth carrier frequency, 2460 p.p.s., its value is 0.00095 henrys.

From both the economic and the electrical standpoints, the values of both L_2 and C_2 are very unsatisfactory. Thus, the condenser C_2 of value 4.421 μF would, on the basis of reasonable cost, have to be of the paper dielectric type, a type which is difficult to adjust within close limits, has high dielectric losses, and is subject to

large variations with respect to temperature and time. Again the low values of the inductances L_2 would cause considerable difficulties in their manufacture to within close limits; for example, on the type of coil it was proposed to use in these filters an inductance of 0.0019 henrys would require about 120 turns, so that the removal or addition of only one turn would vary the inductance by $\pm 1.5\%$, a variation considerably in excess of that permissible from a consideration of the transmission requirements.

To avoid the difficulties thus presented, use has been made of impedance transforming filter sections effectively, obtained by introducing an ideal step-up transformer at the section AB of the filter shown in Figure 19, and an ideal step-down transformer at the section CD.

The equivalence used in designing such filter sections is shown in Figure 20 and by applying it to the structure of Figure 19, in which the condenser $2C_1$ forms the impedance Z of Figure 20, the equivalent structure of Figure 21 is obtained.

It will be noticed that the number of elements has been increased, three shunt condensers being required in place of the one shunt condenser of Figure 19, but the advantages gained by the use of this structure more than offset the increase in number of elements. Thus, by a suitable choice of ϕ , the condenser C_2 can be reduced in value

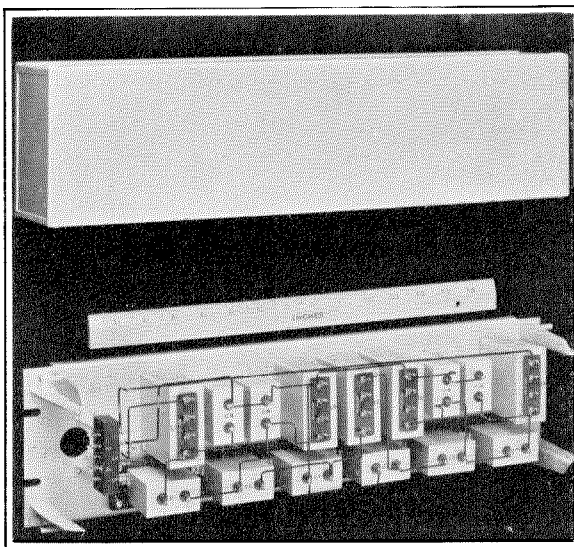

Figure 25—View of Receiving Filter.

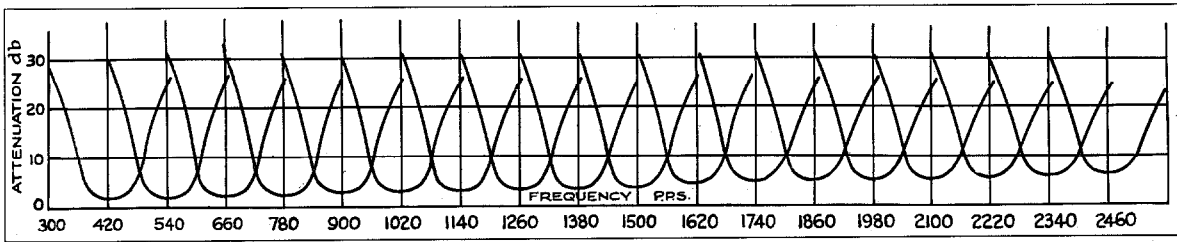

Figure 26—Attenuation Characteristics of Sending Filters for 18 Channel System.

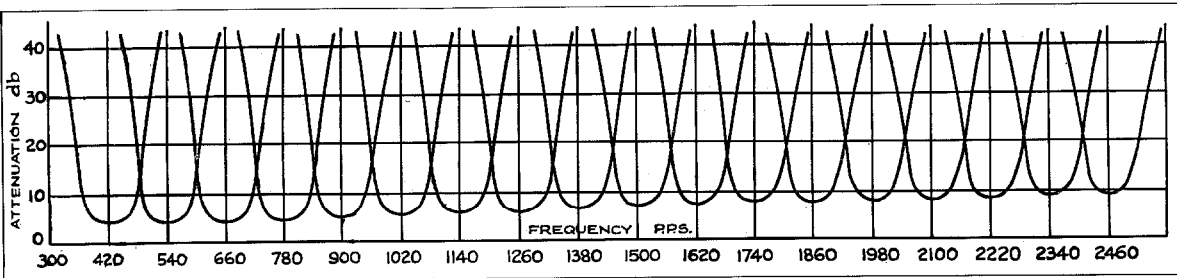

Figure 27—Attenuation Characteristics of Receiving Filters for 18 Channel System.

until it can be manufactured as a mica-dielectric type of the same dimensions as the rest of the condensers in the structure, thereby standardising the type of condenser. Furthermore the use of mica-dielectric condensers offers important advantages as they are readily adjustable within close limits, have low dielectric losses and high stability. Similarly the shunt inductance $\phi^2 L_2$ can be brought to a value of the same order as the series inductances, and therefore can be manufactured to the same limits and electrical efficiency. The series condensers $\frac{2C_1}{\phi}$ are of low value compared with the shunt condensers, but it can readily be shown that they can vary within relatively wide limits without appreciably affecting the performance of the filters.

A further simplification of the structure is obtained by making all the shunt condensers of equal value. This, of course, fixes the value of ϕ , which is then given by the relation

$$\phi = \frac{1}{2} \left(\sqrt{\frac{2C_2}{C_1} + 9} - 1 \right)$$

Table II gives the values of the factors ϕ , ϕ^2 and the impedance elements of the filters for the 1st, 12th and 18th channels.

TABLE II

Channel	1	12	18
Mid-band frequency p.p.s.	420	1740	2460
ϕ	4.62	20.04	28.52
ϕ^2	21.34	402	814
$\frac{1}{2} L_1$ (Henrys).....	0.796	0.796	0.796
L_2 (Henrys).....	0.708	0.762	0.772
$2C_1 \frac{\phi-1}{\phi}$ (μ F).....	0.1443	0.01	0.005080
$\frac{2C_1}{\phi}$ (μ F).....	0.03987	0.000525	0.000185

All the filters are of the unbalanced type having a theoretical band-width of 120 p.p.s. and a characteristic impedance of 600 ohms, being terminated at $x=0.8$ at the common ends, and at $x=0.5$ at the ends that are not common. The general schematics for the sending and receiving filters and photographs of a sending filter panel and a receiving filter panel are shown on Figures 22, 23, 24, and 25. The resistances R_1 and R_2 shown on the sending filter schematic, Figure 22, serve both to adjust the power output of each channel and to prevent too large a change in the impedance facing the input of the filter for the open and closed position of the transmitting telegraph relay.

The coils and condensers for each filter are mounted on one side of a thin steel mounting plate, the dimensions of the latter being 19 in.

x 3½ in. for the sending filters, and 19 in. x 5¼ in. for the receiving filters; both sending and receiving filters are provided with dust covers 3¾ in. high. A considerable reduction in weight has been obtained as compared with the filters employed on the older system, as can be seen from Table III.

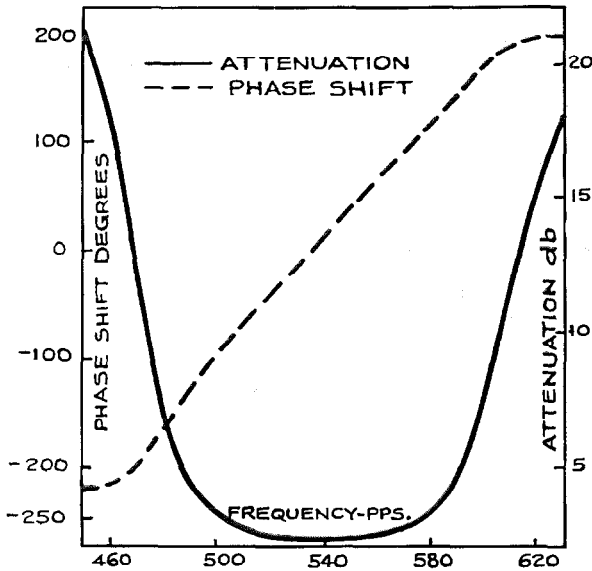

Figure 28—Attenuation and Phase Shift of Sending Filter Flanked on Both Sides.

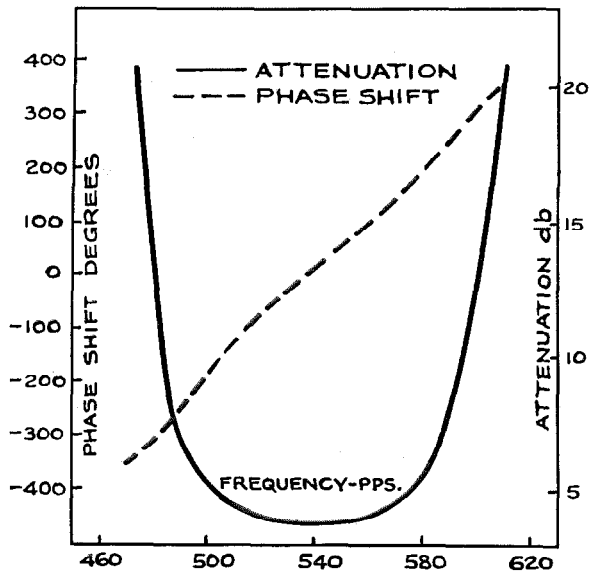

Figure 29—Attenuation and Phase Shift of Receiving Filter Flanked on Both Sides.

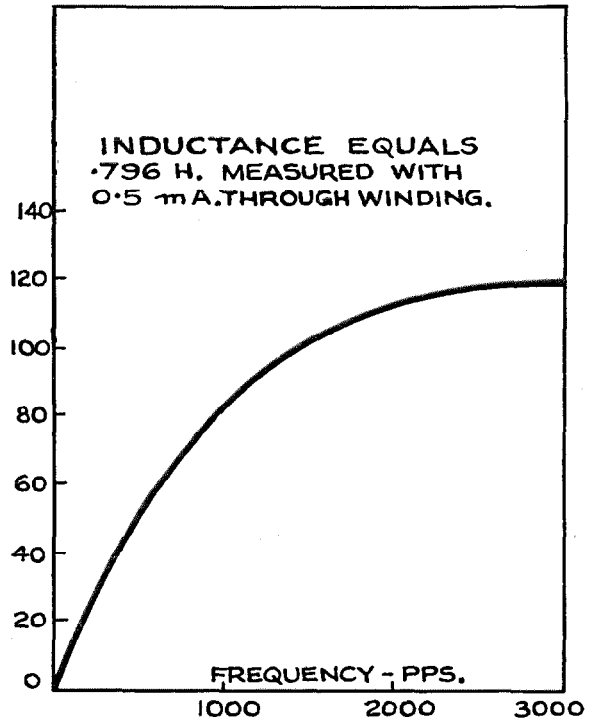

Figure 30—Filter Retardation Coils Variation of "Q" = $\frac{wL}{R}$ With Frequency.

TABLE III

	Old System	New System
Weight of sending filter.....	17 lb.=7.7 kgm.	6 lb.=2.8 kgm.
Weight of receiving filter.....	27 lb.=12.5 kgm.	10 lb.=4.5 kgm.

These reductions are due to the use of a thin steel mounting plate, and to the reduced size and weight of the filter elements.

Some representative transmission characteristics are given in Figures 26, 27, 28, and 29. Figure 26 shows the attenuation characteristics of the sending filters for channels 1 to 18 measured with the filters paralleled on the output side and the input attenuation pads removed, and Figure 27 shows similar characteristics for the receiving filters with the filters paralleled on the input side. Figures 28 and 29 show to a larger scale the attenuation and phase shift characteristics of the sending and receiving filters, respectively, of channel 2, carrier frequency 540 p.p.s.

It is evident from these characteristics that the filters easily meet the general and particular

requirements previously outlined. As regards the filter elements employed, the condensers are of a small mica-dielectric type, and the coils use a core of Permalloy dust material having a permeability of 110.

The aim in designing these coils was to find the minimum size and weight capable of providing the electrical properties determined by the filter requirements. Table IV gives a comparison between these coils and the coils used on the older system, both the new and old type coils having practically identical electrical characteristics.

TABLE IV

Comparison of Filter Retardation Coils		
	Old Type	New Type
Core Material.	Iron dust ($\mu=35$)	Permalloy dust ($\mu=110$)
Core Volume...	5.4 in. ³ = 88.5 cm. ³	.89 in. ³ = 14.7 cm. ³
Panel area occupied.....	10.7 in. ² = 69.0 cm. ²	4.6 in. ² = 29.7 cm. ²
Height over terminals.....	4.56 in. = 11.6 cm.	3.0 in. = 7.6 cm.
Weight.....	4.0 lb. = 1.8 kgm.	0.87 lb. = 0.4 kgm.

Figure 30 is a representative curve for the variation of "Q," the ratio of reactance to resistance, with frequency, for the new type coils.

An Automatic Concentration Unit for Printing Telegraph Circuits*

By G. S. VERNAM

International Communications Laboratories, Inc., New York, N. Y.

SYNOPSIS:—Where lightly loaded telegraph circuits terminate at a central telegraph office, they are usually grouped together on a switchboard or "Concentrator." The paper describes a Concentrator for start-stop printing telegraph circuits that uses step-by-step automatic switches and calling dials for establishing the connections. Certain special features are described, including a "Busy Position Locator" which enables a central office operator, upon calling a busy station, to locate the other operator's position which is in communication with the desired station, so as to forward the message to that operator, while the connection is maintained.

Introduction

THIS paper describes a Concentration Unit for Printing Telegraph Circuits, which uses automatic switches of the step-by-step type, similar to those employed in certain dial telephone systems, for performing various switching operations.

Where a number of lightly loaded telegraph circuits terminate at a central telegraph office, and the number of messages over each circuit is insufficient to keep an operator fully employed, it is obviously desirable to group the circuits and to provide switching means so that a single operator at the central telegraph office can send and receive messages over any line of the group at will. Switching facilities for this purpose are usually called "Concentrators" or "Concentration Units."

Printers or "teletypewriters" of the so-called "start-stop" type are being used to a large and increasing extent on such lightly loaded circuits. They are used on lines connecting public branch offices of the telegraph companies within a metropolitan area with the main telegraph office, and are installed in offices of private customers of the telegraph companies to provide direct communication with the central telegraph office. As a result, concentration units are being used to an increasing extent for printing telegraph circuits.

Manually operated telegraph concentrators

*Presented at the Winter Convention of the American Institute of Electrical Engineers, New York, January, 1932.

Copyright, 1932, by International Communications Laboratories, Inc., New York, N. Y.

have been used for many years. They are usually small switchboards, with a jack and some form of calling signal for each line, and one or more cords associated with central office operators' telegraph sets or printers and adapted to be plugged into the jack of any line for the purpose of sending or receiving a message. In small installations, the jacks and signals may be mounted in small turrets placed within the reach of from one to four telegraph operators, so that they can make their own connections directly with the branch lines, but in larger installations the connections may be established by a separate switching operator stationed at a manual switchboard or concentrator. Such switchboards are commonly equipped for about 120 lines and arranged for use with a dozen or more central office telegraph sets or printers.

In another type of manual Concentration System¹, one or two 100-line turrets are provided for each printer operating table, the lines are multiplied to the jacks on each turret, and a cord and plug is provided for each printer operator to directly establish connections from her printer to any desired line. This system requires a large number of jacks, a considerable amount of multiple cabling, etc., which tend to make the system expensive. Very ingenious methods have been used to reduce the cost of the equipment, however, including the use of special circuits that permit a one-conductor multiple and still provide the necessary busy test feature, etc., and

¹ See Wm. B. Blanton, "A Printing Telegraph Concentrator," A. I. E. E. Trans., June, 1931, Vol. 50, Page 414.

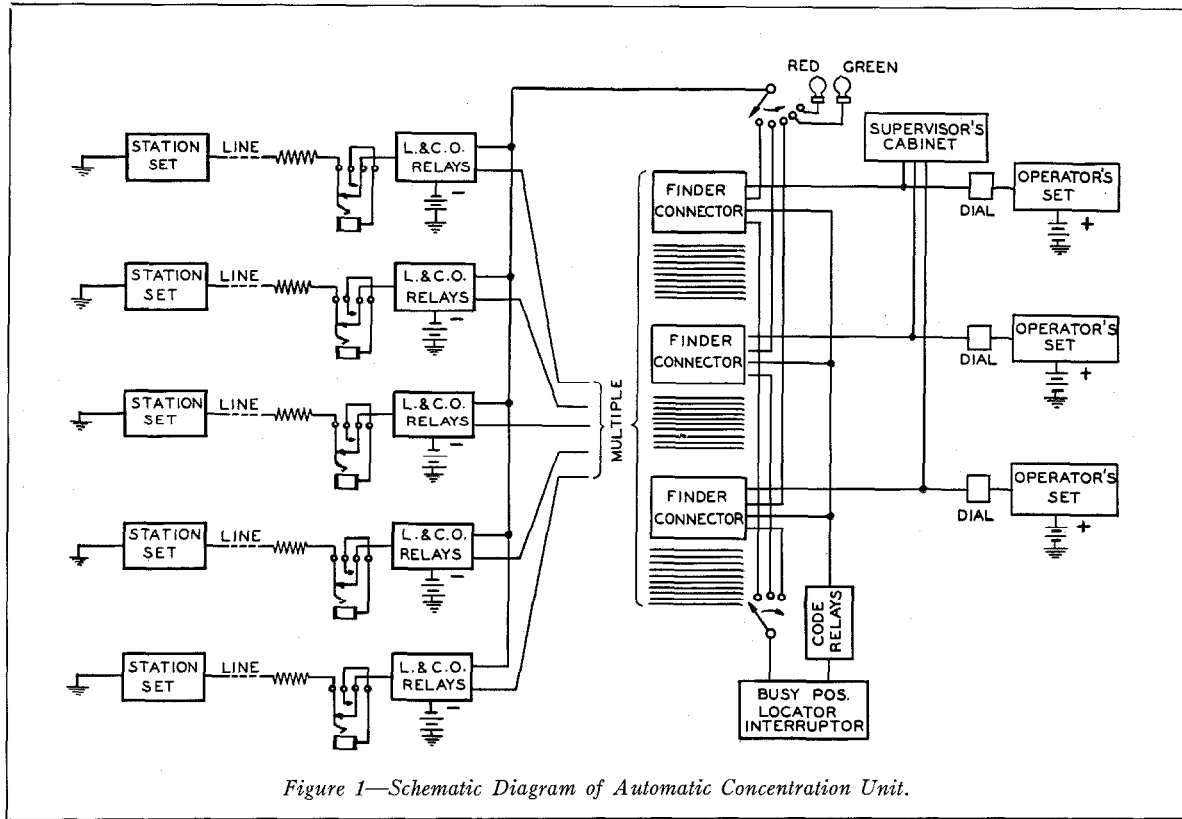

Figure 1—Schematic Diagram of Automatic Concentration Unit.

the use of studs in a moulded panel in place of the usual type of jack.

The Automatic Concentrator to be described is now being employed by the record communication companies of the International Telephone and Telegraph System² to permit the individual printer operators to set up their own connections by dialing for outward calls without requiring multiple turrets or switching operators and to permit inward calls to be established automatically to idle positions without the delay involved in manual switching operations.

To dial a branch station from the central office takes about four seconds, while inward calls from the branch stations are switched through automatically to idle central office operators in an average time of less than two seconds, and, as explained later, the branch station operator may start to send without waiting for a response or "go ahead" signal from the central office operator. About one second is re-

quired for releasing any connection. It is obvious that the switching operations are accomplished in much less time than with the manual system.

If idle operators are available, a single call will be switched through in about one second, but if two calls arrive at the same time, they will be connected to idle operators in succession and the second call may require two or three seconds. At rare intervals, three or more simultaneous calls may occur and require slightly longer time.

Because of the quicker switching, the central office operators spend a greater proportion of their time in actually sending and receiving messages, and our present limited experience with the system indicates that the number of messages handled per operator per hour is increased by about 20% as compared with that form of manual system in which a separate switching operator establishes the connections between the branch lines and the central office operators. This permits a corresponding reduction in central office printers and operators with a resultant saving in operating and equipment charges.

² Postal Telegraph-Cable Company, The Commercial Cable Company, All America Cables, Inc., and Mackay Radio and Telegraph Co.

General Description of Automatic Concentration Unit

The Automatic Concentration Unit consists essentially of a group of step-by-step switches and relays, and certain auxiliary and supervisory equipment, including a Line Jack Panel, a Supervisor's Control Cabinet and a Busy Position Locator. This equipment is associated with a number of operators' printer sets in the central telegraph office, and a larger number of start-stop printers or teletypewriters installed in various offices usually within a metropolitan area, each such machine being connected over a single-wire line to the concentration unit at the central telegraph office.

The general arrangement of a system for not more than 100 lines is shown in Figure 1. Each branch station line extends through a resistor (for adjusting all lines to the same resistance), and a test jack to a pair of "line" and "cut-off" relays, which are multiplied to the bank contact terminals of all of the step-by-step switches. When used for handling incoming calls from the branch stations, these step-by-step switches are called "line finders" as they serve to automatically find a calling line and connect it to an idle operator's position. When used for handling outgoing calls to the branch stations, the switches are called "connectors" as they connect the calling operator to the line corresponding to the number dialed. Concentration systems have been developed and installed, in which separate groups of switches were used for these two purposes, this arrangement being particularly suitable for cases where separate groups of operators are employed for handling inward and outward messages.

In the arrangement shown in Figure 1, however, the step-by-step switches are called "finder-connectors" because they combine in each switch the functions of both a "line finder" and a "connector," as each switch can handle calls in both directions. One finder-connector is associated with each central office operator's printer set and each operator is both an "inward" and an "outward" operator. Connections are also provided from each finder-connector to the "busy position locator" and to the lamps and keys of the supervisor's control cabinet. The switches are mounted in an enclosed rack of sectional

construction, which is shown, with covers removed, in Figure 2.

Each central office operator's set is equipped with a dial unit, consisting of a metal case about four inches (10 cm.) square on which is mounted a calling dial, a three-position lever key and a small lamp used as a busy signal. This dial unit is mounted on the shelf of the printer table, to the right of the printer, as shown in Figure 3. In addition to the usual gumming desk, time stamp, numbering stamp, message boxes, etc., the printer table includes a push button type release key and two associated signal lamps, known respectively as the "hold" signal and "guard" signal. These are mounted in the table top back of the gumming desk, as shown in Figure 3.

The supervisor's control cabinet, see Figure 4, is mounted on the supervisor's desk, and is so located as to be visible to the supervisor from

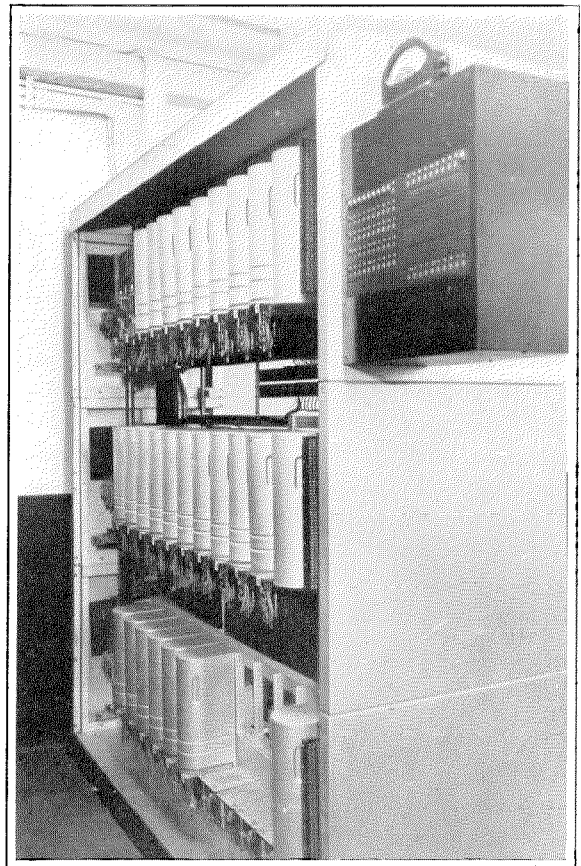

Figure 2—Switch Rack with Covers Removed and Line Jack Panel.

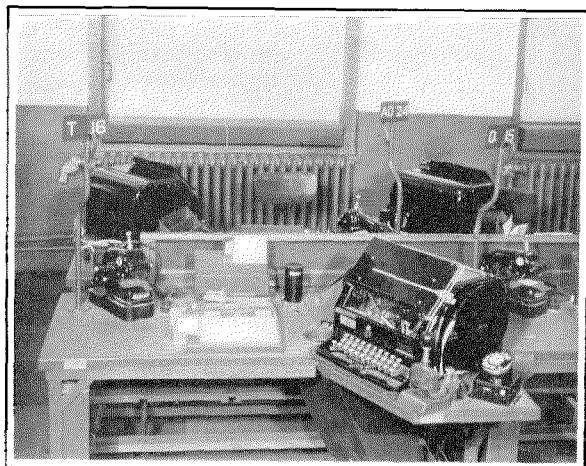

Figure 3—Central Office Printer Set.

almost any position near the operators' sets. This cabinet has a lamp and a key for each operator's set, known respectively as the "idle operator light" and the "make busy switch." Three electro-magnetically operated counters or service meters are also mounted in this turret. The lamps serve to keep the supervisor advised at all times as to how many operators are available for handling inward calls. The keys or "make busy switches" permit the supervisor to switch off any operator's position that is not covered by an operator, or that is to be used exclusively for sending, and thus prevent any incoming calls from being routed to such positions. The electro-magnetic counters may be used to determine the total number of inward, outward and busy calls during any given period.

In addition to the control cabinet, a standard, bearing a large green and a red lamp, is also mounted on the supervisor's desk. The green lamp lights when all operators' positions are "busy," i.e., actually busy and connected to a branch station, or made busy by the "make busy switches." The red lamp lights when there is an incoming call waiting with no idle positions to answer it. These lamps, together with the "idle operator lights," aid the supervisor in regulating the size of the staff so as to handle the messages efficiently and without delay, in spite of variations in the traffic load at different times. The location of the supervisor's control cabinet in relation to the operator's printer tables in a typical installation, is shown in the photograph, Figure 5.

The Line Jack Panel is mounted on the end of the switch rack (see Figure 2) and has a jack for each line. These jacks are used for testing the lines, measuring line current, etc. If a certain branch station is so busy during part of the day that it can keep a central office operator fully occupied in handling its messages, the branch station line can be "tabled," i.e., connected directly to a special central office printer set reserved for this purpose. A few extra jacks, associated with such sets, are provided in the Line Jack Panel, and lines to be "tabled" are connected to such jacks by cords with plugs on both ends. During light load periods, these cords are removed to re-connect such lines back onto the automatic switches. This arrangement decreases the number of automatic switches required, as it reduces the traffic handled through the switches during the busy hours.

The Busy Position Locator consists of a special sending device or interrupter, shown in Figure 6, which operates in conjunction with a rotary step-by-step switch and certain relays shown in the rear view of the switch rack, Figure 7. It serves to locate the operator who is connected with a busy branch station, as will be described later.

Operation of System

The general method of operation of the Automatic Concentration System may be best explained by following the operations that occur in handling typical outgoing and incoming messages.

Outgoing messages to be sent to the branch offices connected to the Concentration Unit are received from other sections of the central telegraph office. They will ordinarily be messages that have come in from distant parts of the country over long land lines, or from other countries by cable or radio. The number of the branch office is marked on the message by a routing clerk and the message is then handed to an idle printer operator. If several messages for the same branch office are received at about the same time, they will all be handed to the same operator for transmission. This operator first moves the handle of the lever key of her dial unit to the right. This lights the guard lamp on her table, extinguishes the "idle operator light"

corresponding to her position on the supervisor's control cabinet, and makes her position "busy" to inward calls. She then dials the number of the branch office (two digits), which causes her finder-connector switch to select the terminals of the desired branch line, to test to determine if the line is busy, and if not, to connect the operator's set to the branch station line. After dialing, the operator glances at the "busy" lamp on her dial unit and restores her key to its normal central position. If the called line is busy, the lamp lights, and when the key is restored the busy position locator starts, as described later. On the other hand, if the called line is not busy, the light does not light, and restoring the key starts the printer motor at the branch station so that the operator may send the message or messages. After sending the message or messages and receiving an acknowledgment from the branch station, the operator depresses her release button, which stops the branch station motor, restores the finder-connector switch to its normal position, extinguishes her guard lamp and lights the "idle operator light" on the supervisor's control cabinet.

If a branch station has a message to send, the branch office operator operates a calling key on the printer set which starts the first idle finder-connector switch and causes it to automatically select and connect its associated operator's printer set with the calling line. While the switch is hunting for the calling line, it is controlled by a common group of relays, which cause the switch to step vertically until it reaches the proper level, and then to rotate until it reaches the terminals of the calling line, after which the common relays are released and serve to control another switch in handling succeeding calls. The guard lamp at the operator's position lights as soon as the finder-connector starts to find the calling line, and the corresponding "idle operator light" in the supervisor's cabinet is extinguished. The operator's dialing circuit is also disabled at this time so that she cannot interfere with the action of the switch by attempting to dial. As soon as the connection is switched through, which normally requires about one second, the motor at the calling station starts automatically. The calling station operator starts to send the message immediately without waiting for a

response from the central office operator as the starting of the printer motor serves as a "go ahead" signal. When the message has been transmitted and acknowledged, the central office operator releases the connection in the same manner as for an outward call.

Circuit Features—Station Line Circuit

The circuits of the finder-connector switches are similar to those of step-by-step connectors used for telephone service, except for some changes of minor importance, such as the use of one instead of two wires for the line circuit, and the elimination of the usual ringing and talking battery circuits. These circuits are well known

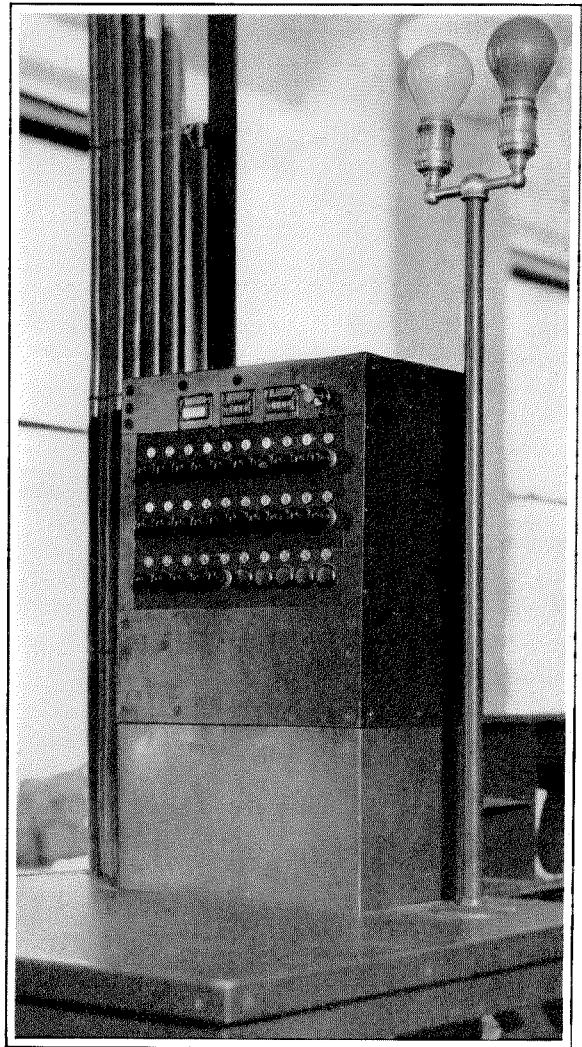

Figure 4—Supervisor's Control Cabinet.

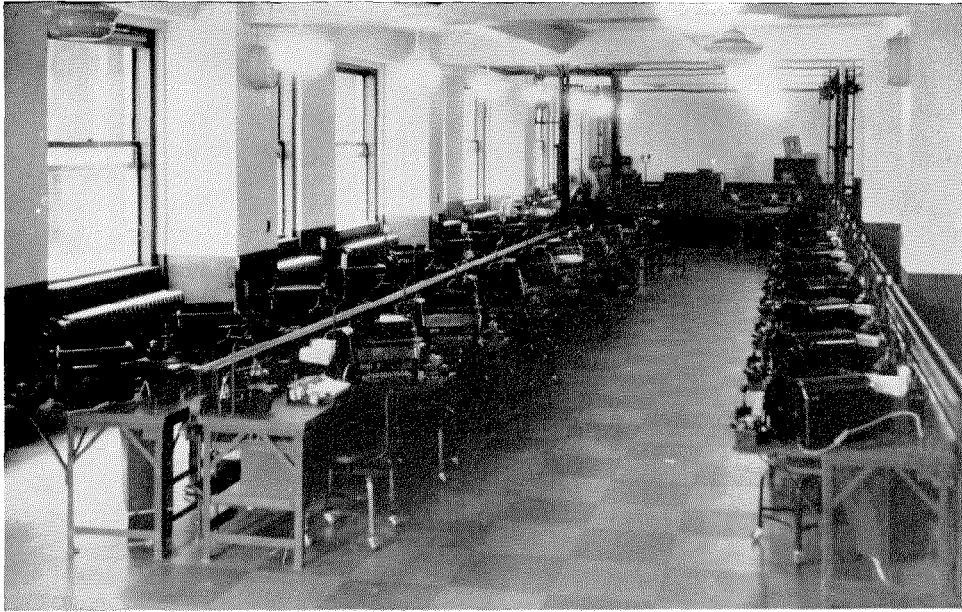

Figure 5—Typical Installation of Central Office Printer Sets.

and need not be described in detail. The circuits of certain other parts of the system may be of interest, however.

The circuit of the branch station printer set is shown in Figure 8. It should be understood that the line, shown at the top of the figure, normally extends from the branch station to the central office and through the line relay at the

central office to the negative 110-volt power supply, while the station is idle. When the station is connected to a central office operator, however, the positive 110-volt supply is connected to the station line through the operator's printer. While the station is idle, the polar relay at the station is operated, as shown, and the high resistance winding of this relay reduces the line current to about 6 milliamperes.

To call, the branch station operator shunts this winding by operating the calling key and the line current increases to about 40 milliamperes to operate the line relay at the central office and to start the first idle finder-connector. When the call is switched through, positive potential from the operator's printer reverses the line current and releases the polar relay. The control relay now starts the printer motor and the branch station may send its message. Opening and closing the line in sending printer signals will have no effect on the polar relay.

In the case of calls from the central office, the positive potential applied to the line through the operator's printer, after dialing, reverses the line

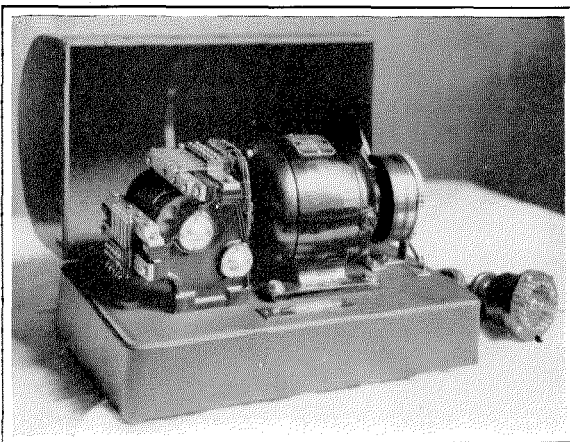

Figure 6—Busy Position Locator Interrupter.

messages, by holding them while repeated attempts are made to obtain a connection by dialing.

In all cases, when a line is found busy, it is connected with some other operator in the same central office. If it is possible for the calling operator to determine the number of the other position that is already in communication with the desired branch station, the message can be re-routed to this position and sent with but little delay. The purpose of the "Busy Position Locator" is to furnish the information for re-routing such messages.

When a calling operator dials a busy line, the "busy" lamp of her dial unit lights to notify her that the called station is busy. Her printer set becomes automatically associated with the "Busy Position Locator," which automatically finds the "busy" position that is already connected to the called line, and causes the "hold" lamp on that position to light. The interrupter of the busy position locator sends signals in the usual printer code representing the number of the "busy" position into the printer of the calling operator, which prints the number of the "busy" position. The printed record is in the form "-14-14-14," etc., and advises the calling operator to send the message to position No. 14 and to release the circuit. The "hold" lamp, which was lighted at the "busy" position, serves to notify that operator to hold the connection. The "hold" lamp is not extinguished until the connection to the branch station is released.

In order to accomplish these results, it is necessary to establish connections between the "busy position locator" and the finder-connector switches of the two operators concerned, i.e., the "busy" operator who is already in communication with the branch station and the "calling" operator who is attempting to call the same branch station. By means of these connections, the "hold" lamp is lighted at the "busy" position, the interrupter motor is started, and certain so-called "code relays" associated with the interrupter are operated to control the interrupter and cause it to send to the calling operator's printer signals corresponding to the number of the "busy" operator's position.

As the busy position locator interrupter is common to a large group of operators, and as

two or more operators may dial busy lines at the same time, the circuit must be arranged so that it can respond to only one such busy call at a time in order to prevent false indications. For this reason, a rotary switch is provided to connect the interrupter to the calling operator's circuit. If two or more operators dial busy lines at the same time, the wipers of the rotary switch start and rotate until they reach terminals connected to the circuit of one of these calling operators, and then stop. The rotary switch, therefore, serves to connect the busy position locator to only one calling operator at a time.

After dialing a busy line, the finder-connector switch wipers of the "calling" operator are resting on terminals of the same line as those of the "busy" operator's finder-connector. An extra wiper, known as the "test" or "T" wiper, is provided on each switch, and this is associated with an extra set of bank contacts that are multiplied to all switches. These wipers serve to establish a connection between the two finder-connectors for the purpose of operating the "hold" lamp and controlling the number signals to be transmitted by the interrupter, as described later.

The circuit of the busy position locator is shown in schematic form in Figure 9. In the drawing, the circuit has been modified slightly in order to simplify it. Only two finder-connectors are shown in the drawing, and the operating circuits of these have been omitted, and only the two relays of the switches that are concerned with the operation of the busy position locator are shown. The details of the 12 code relays have been omitted, as their action is obvious, but their location in the circuit has been indicated schematically.

The interrupter, shown in Figure 6, has a motor, equipped with a governor, which drives a cam drum at one-quarter of the usual printer operating speed, so that four character signals in printer code are transmitted during each revolution of the drum. This device has twelve contacts, which operate in a definite sequence. One of these contacts sends a figure shift signal, followed by a hyphen, and the so-called "stop" impulse for two more character signals. Another contact known as the "pick-up" contact, operates the control relays in such a way as to insure

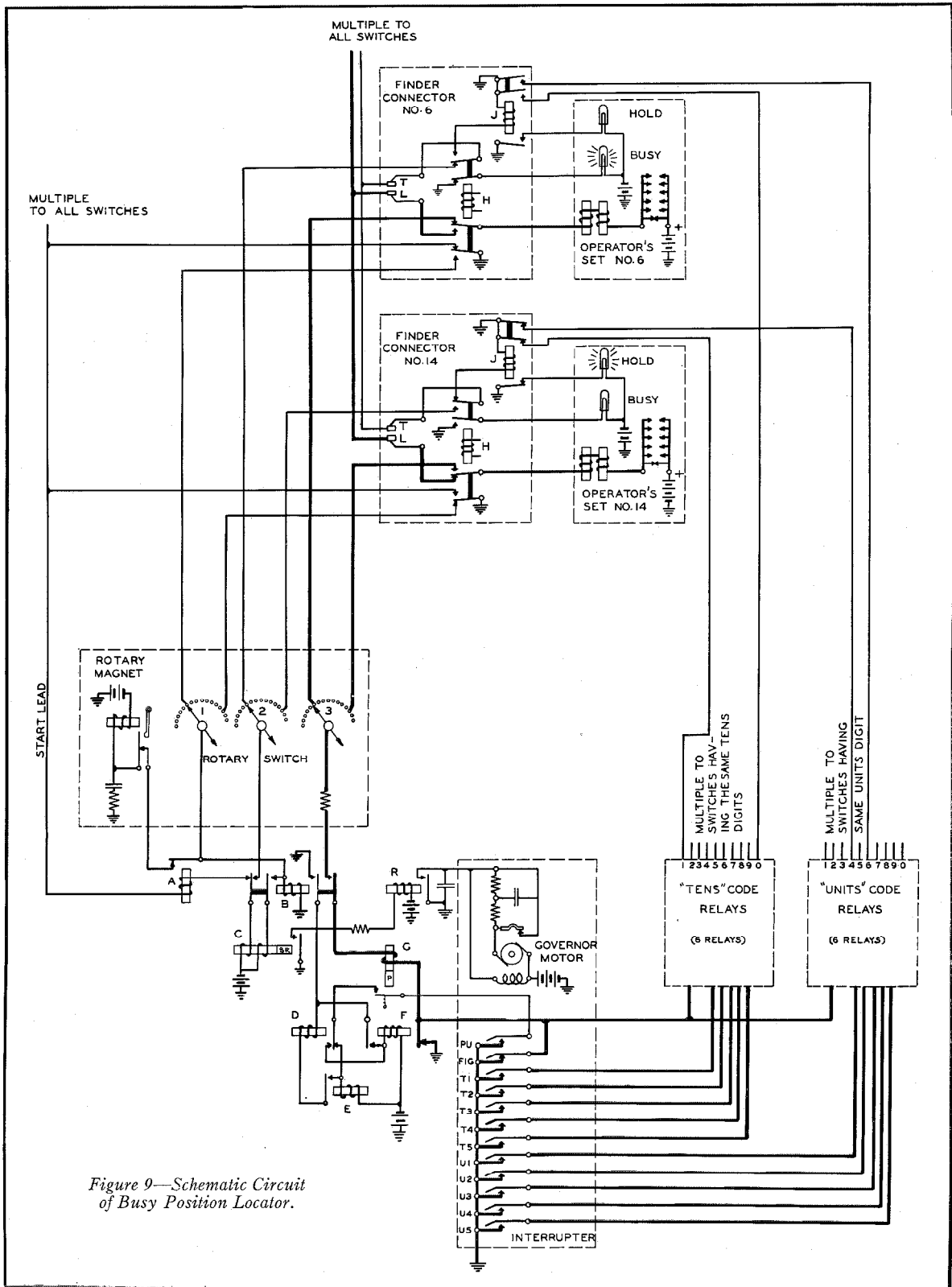

Figure 9—Schematic Circuit of Busy Position Locator.

that the transmitted signals always start with the figure shift signal. The other ten contacts send the individual selecting impulses of the two digits of the position number in the usual printer code. The circuits of these ten contacts are controlled by the tens and units code relays.

Assume that the operator at position 14 has obtained a connection with a certain branch station for either sending or receiving a message, and that the operator at position 6 subsequently dials the same station to send a message. Finder-connector switch No. 6 will advance to the terminals of the desired station, but, finding the line busy, will not close the line circuit through. Relay H of this switch will operate, as this relay is so connected that it always operates when the switch wipers rest on the terminals of a busy line. Relay H opens the sixth bank contact associated with the first wiper of the rotary switch and grounds the "start" lead, which operates relay A, and relay C. Relay C starts the interrupter motor and relay A causes the rotary magnet to operate intermittently and rotate the wipers until they reach the terminals associated with finder-connector No. 6. Relay B now operates in series with the rotary magnet. As relay B has a high resistance winding, the rotary magnet does not operate. Relay B locks itself through relay C, releases relay A, and closes the other two wiper circuits.

Battery from the left hand winding of relay C is now applied through wiper 2 of the rotary switch and the T wiper of finder-connector No. 6 to the bank wiring. As the wipers of finder-connector No. 14 are on the terminals of the same line, the J relay of that switch operates. This causes the "hold" lamp on position 14 to light, advising that operator to hold the connection for another message, and operates relays in the tens and units code groups to set up the printer code signals for "1" and "4" on interrupter contacts T1 to T5 and U1 to U5 respectively.

Relay B also closes the line circuit for operator's printer No. 6 through wiper 3 of the rotary switch and relay G to ground. Relay G operates and connects interrupter contact PU to relay E. The first time the PU contact closes, relay E operates and when the PU contact opens relay D operates in series with relay E. When the PU contact closes again (after a complete revo-

lution of the cam drum) relay F operates, locks itself and removes the shunt to ground from the interrupter contacts and code relays, so that the signals "Figures," "-", "1," "4" are sent into printer No. 6, causing it to shift and record "-14-14-14" etc., advising operator No. 6 that the desired station is connected to position No. 14.

After noting this position number on the message, operator No. 6 releases the connection, restoring finder-connector No. 6 to normal and releasing its H relay as well as the J relay of switch No. 14. The "hold" lamp at position No. 14 remains lighted under the control of a locking relay that is not shown in the drawing. Relay H short-circuits relay B to release it and this, in turn, releases relays C, D, E, F and G, restoring the circuit to normal. If another operator has dialed a busy line in the meantime, relay A will operate immediately and relay C will remain operated to keep the motor running. It should be noted also, that relays D and E prevent any signals from being sent by the interrupter until the cam drum has made at least one complete revolution to get up to normal speed.

Modifications

The system providing for not more than 100 lines has been described, as it is simpler and has substantially the same equipment and features as a larger system. A system for 1,000 or more lines has been developed which uses additional automatic switches and auxiliary equipment in a manner somewhat similar to the use of this apparatus in automatic telephone systems.

A system using dials at each branch station and additional switching equipment at the central office has also been developed, so that any branch station can dial any other branch station and obtain a direct telegraph circuit to it through an automatically connected single line repeater at the central office. One indication is given at the originating office if the connection is completed and another if the called line is busy. The dial system also naturally provides for obtaining a printer connection to the central telegraph office or to various departments of the central office, such as to the cable division for sending cablegrams, to the land line message service division, to the radio telegraph division, or to a toll board for connection to distant cities.

Direct Printing Over Long Non-Loaded Submarine Telegraph Cables*

By M. H. WOODWARD and A. F. CONNERY

Both of the International Communications Laboratories, Inc., New York

SYNOPSIS:—*This paper describes a method for the electrical conversion of the non-uniform length combinations of the cable Morse Code into a modified five unit code and the application of this method to the operation of printers on long non-loaded submarine telegraph cables.*

NOTWITHSTANDING the rapid progress that has been made in recent years in the application of automatic printers to landline operation, and the continued efforts to apply similar methods to the operation of long non-loaded submarine cables, the siphon recorder, which requires manual translation, is still used almost exclusively in the operation of such circuits. While the recently developed loaded type of submarine cable possesses characteristics which permit of its being operated with a modified form of landline multiplex printing system, the numerous attempts to develop and apply a satisfactory direct printing system to non-loaded cables have not met with complete success. It is the purpose of this paper to outline briefly the various factors which enter into this problem and to describe a new type of cable printer which has been developed and placed in successful operation in the Commercial and All America cable systems.

The printing systems found satisfactory for landline operation employ uniform length codes in which all characters are composed of an equal number of current impulses, usually five. Although these systems might be modified to give satisfactory printing on submarine cables, the line time would be used so inefficiently as to make this procedure impracticable, and, furthermore, the equal length codes have the disadvantage that failures of individual pulses are not detectable in code traffic.

The high cost of long non-loaded cables in comparison with the signalling frequency which they are capable of transmitting, makes it necessary to use the shortest practical code. Although several codes have been proposed

which are shorter than the cable Morse code as measured by the number of unit pulses of which they are formed, none requiring less average transmitting time per character than cable Morse code has been found entirely satisfactory.

In order to secure the advantage of direct printing without sacrificing cable capacity, it therefore appeared necessary to design either a new type of printer capable of operating on code combinations of varying length, or to devise an automatic means for converting signals received in cable Morse code into a uniform length code suitable for controlling printers of the type already developed for landline operation. The difficulties previously encountered in attempting to solve this problem by the former method were so serious as to discourage further efforts along these lines. The obvious means of solving the problem by the code transformation method, namely, designing a mechanical translator in which the received Morse code signals would select an element corresponding to each character, and this element in turn would set up the new code combinations for that character, was so cumbersome as to appear uninviting also.

The present solution of the problem resulted from the observation that when cable Morse code combinations of 1, 2, 3 or 4 units, each followed by a letter space of 1 zero unit, are expanded into five unit combinations by the addition of pulses opposite in polarity to the last pulse in the normal Morse combination, the 30 unequal length combinations of the Morse cable code are transformed into 30 distinct five unit combinations without duplications, thereby providing the basis for the use of five unit code printers. For example, the cable Morse combination for the letter "E" is one positive pulse followed by one zero pulse, which would be translated into one positive pulse followed by four negative pulses. The phrase "zero pulse" is here

*Presented at the Winter Convention of the American Institute of Electrical Engineers, New York, January, 1932.

Copyright, 1932, by International Communications Laboratories, Inc., New York N. Y.

used to denote the condition of zero current or polarity for a unit interval of time. The cable Morse letter "A" comprises one positive pulse and one negative pulse followed by one zero pulse which would be translated into one positive pulse and one negative pulse followed by three positive pulses. The other cable code combinations are similarly translated into the five unit combinations shown in Figure 1, in which both the upper and lower case characters are shown. It should be noted that in the case of the letter "T" and certain other characters, the fundamental law of translation is not applied in the exact manner stated above. These deviations from the law were made to simplify the equipment and to facilitate the carrying out of certain standard Morse practices on the printers.

This general law of transformation as above stated is so simple that it was possible to devise a means for operating directly upon the electrical pulses of the Morse signals to accomplish the code transformation without the aid of complicated mechanical devices. The 30 combinations referred to take care of the letters of the alphabet, with a few combinations to spare. However, as more than 30 separate combinations are required to represent the alphabet, figures, punctuation marks, etc., the cable Morse code necessarily includes, in addition, a number of combinations of five units and a letter space. It is obvious that all of these five unit combinations will be found duplicated in the new five unit code into which the 1, 2, 3 and 4 unit cable Morse code combinations were expanded.

By employing case shifts according to the usual practice followed in landline printer operation, one set of meanings was assigned to the five unit combinations derived from the shorter cable Morse code characters, and another set of meanings to the normal five unit combinations of the Morse code which undergo no expansion. The latter combinations are assigned to upper case characters of the printer, and the operation of the shifting mechanism is determined in such cases by the presence of the fifth pulse in the received signals. After being shifted into the upper case, the printer will remain there until a word space or special unshift combination is received.

Of course, it would have been possible to

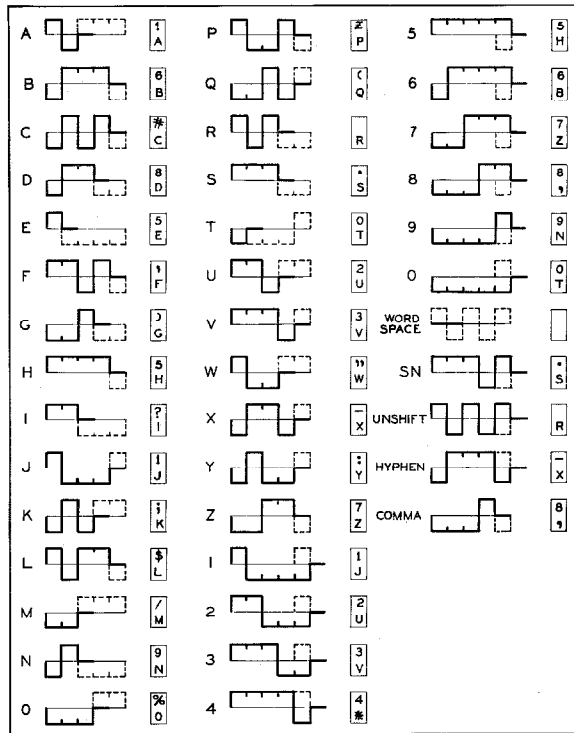

Figure 1

expand all of the Morse combinations, including the five unit combinations, into a new six unit code, thereby avoiding the need for assigning two sets of meanings to the five unit combinations. The former method was chosen because it conformed more nearly with present landline practice.

Continuation of the use of the cable Morse code, in addition to effecting economies in line time, has the advantage of requiring few, if any, changes in the relaying equipment now installed at repeater stations. It also permits the continuation of present operating and maintenance practices. For example, in order to economize line time, it is the practice, under certain conditions in sending figures, to use the so-called "short figures," i.e., A-1, U-2, E-5, D-8, N-9, T-0. A special arrangement of the translating mechanism makes it possible to continue this practice, providing the first figure in a figure group is transmitted as a long figure to cause the shift mechanism to operate.

When translating cable code signals from a siphon recorder slip, the operator can easily detect a dropped pulse at the beginning or at the end of a letter by the presence of an extra zero

interval. The translating and printing mechanisms are so arranged that this extra zero will cause an asterisk to be printed as an indication of the error. A dropped pulse within a letter will result in two wrong letters being printed in place of the proper letter. This type of error is easily detected in ten letter code traffic because the word then has eleven letters.

An added pulse in place of a zero pulse usually results in a combination having five or more pulses which shifts the printer into the upper case and the last part of the word, therefore, appears as various punctuations and figures, indicating the error.

Less frequently, an extra pulse between two short letters will result in one wrong letter being printed in place of the two proper letters. This also is readily detected in ten letter code traffic as a nine letter word results.

Application of this printer to existing cables requires no changes to be made in the apparatus at the transmitting or repeater stations, the signals being transmitted by existing transmitters from perforated tape prepared on standard keyboard cable perforators. At the receiving end, however, the siphon recorder is replaced by a cable relay which operates the code translating and printing apparatus, comprising a distributor, maintained in synchronism with the received signals, a group of relays which perform the translating operations, and a slightly modified five unit code multiplex printer.

The function of the distributor is to regenerate the received signals and to control the operation of the local circuits associated with the translating relays and printer. As the Morse code characters contain a variable number of pulses,

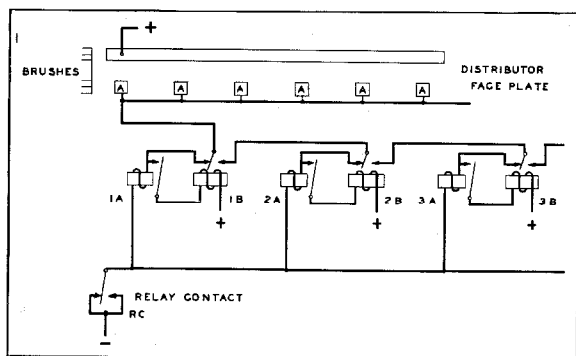

Figure 2

the first pulse of every character does not necessarily fall on a given segment of the distributor, as is the case when a uniform length code is used. It is therefore necessary to provide an auxiliary distributing device to direct the first and succeeding pulses of each character to the corresponding selector magnets of the printer.

This auxiliary distributing device consists of a chain of counting relays as shown in Figure 2, in which the segments marked A of the synchronous receiving distributor are spaced at intervals corresponding to the time spacing of individual incoming pulses. The counting relays are arranged in pairs so that the first relay of the first pair is operated when the distributor brush passes over a local segment and the second relay of that pair is operated when the brush leaves the segment. When the brush passes over the next local segment, the first relay of the second pair is operated and when the brush leaves that segment the second relay of the second pair is operated, and in this way the relays will operate and lock up progressively as the brushes pass over the local segments. It will be noticed that when the brush passes on any segment after the chain of relays has been unlocked, a path for the current will always be completed through the winding of relay 1A. When relay 1A operates, a circuit will be completed from the tongue of relay 1A through the winding of relay 1B to positive potential, but no locking current will flow through relay 1B because it is short-circuited through the low resistance of the brushes. As soon as the brushes leave the segment, however, locking current for relays 1B and 1A in series will flow, thus operating relay 1B, which transfers the circuit from the local segments into the winding of relay 2A, so that when the brush passes over the next local segment, relays 2A and 2B will be operated in a similar manner to relays 1A and 1B. Relays 1B, 2B, 3B, etc., are provided with additional contacts, not shown in this figure, which serve to distribute the various selecting pulses into the proper paths. All of the relays of the distributing bank will be unlocked and restored to normal when the release contact RC is opened. The chain relay bank is arranged so that it will step along whenever impulses representing either dots or dashes are being received or when

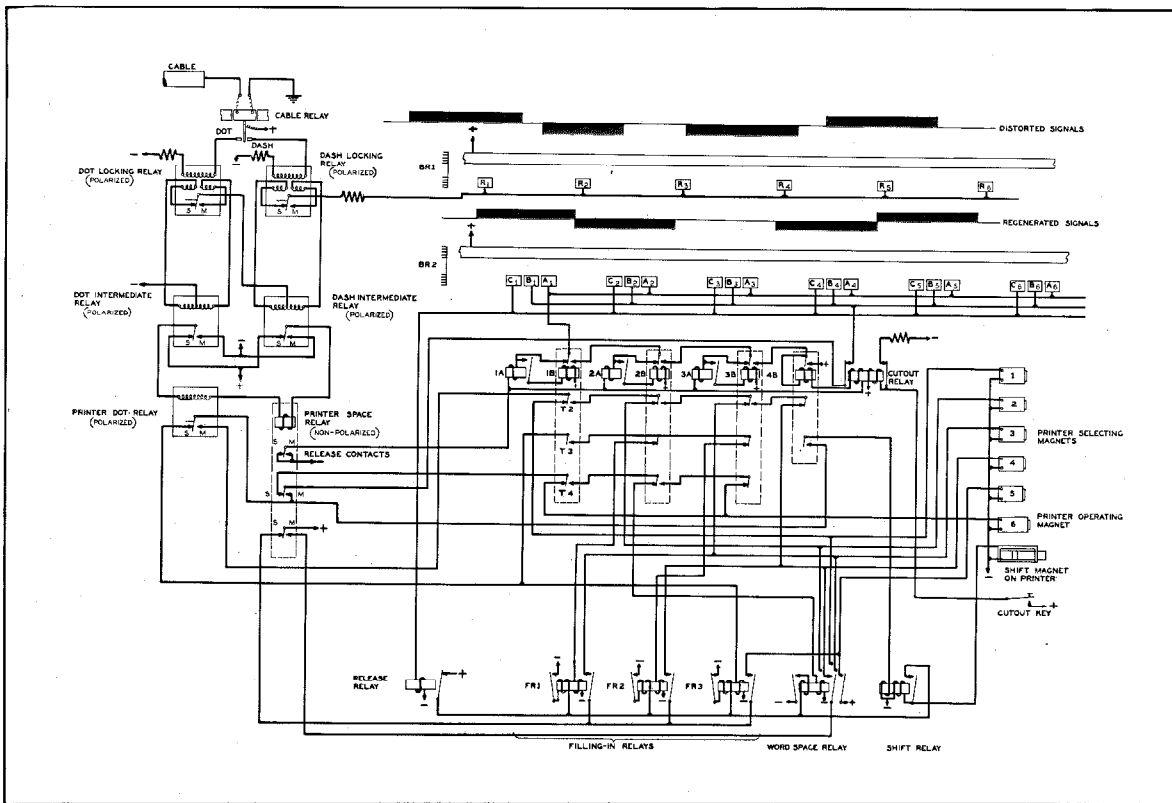

Figure 3

a group of zero pulses are being received, but it will be unlocked and re-set by the opening of the release contact RC whenever the incoming signal changes from a dot or dash to a zero pulse or from a zero pulse to a dot or a dash pulse.

The manner in which the counting relay chain is associated with the distributor and printer circuits to effect the translation and printing of cable code signals is shown in schematic form in Figure 3. The rotary distributor is provided with two segmented rings, one of which cooperates with the receiving relays to regenerate the incoming signals to their proper length. The other segmented ring serves to control the operation of the counting relay chain previously described, and the associated translating relays to effect the proper selection in the printer.

The pick-up segments R_1 , R_2 , etc., of the segmented ring, used for regeneration, are spaced at intervals corresponding to the length of the transmitted unit pulses, so that the time that the brush BR_1 takes to pass from one segment to a corresponding point on the next

segment is equal to the time of transmission of one unit pulse. Thus, the regenerated signal is always restored to its full time length as originally transmitted. The brush BR_1 is caused to pass onto the segments R_1 , R_2 , etc., at approximately the middle of each received pulse through a synchronising means not shown here.

The groups of segments of the second segmented ring marked C, B and A are spaced approximately midway between the R segments of the first segmented ring. Thus, while the brush BR_1 is passing from one R segment to the next, the brush BR_2 is passing over one group of three segments. The passage of this brush over a "C" segment releases any "filling-in" relays that may have been previously locked up, in a manner to be described later. The passage of the brush over a "B" segment causes a circuit to be completed into one of the printer selector magnets, or into certain of the "filling-in" relays. The circuits to the "filling-in" relays are arranged so that the more pulses that are received in any given code combination the

fewer will be the number of pulses to be filled in to the printer selecting magnets, the total of those received and those filled in being five.

The passage of the brush BR_2 over the "A" segments operates the counting relay chain as explained in connection with Figure 2.

The manner in which the regenerating and translating functions are carried out may best be understood from a detailed description of the successive operations involved in translating and printing a representative signal combination. The combination chosen, $+ - 0$, is the cable Morse code combination for the letter A. Referring to Figure 3, the regenerated pulses for the letter A are shown in their proper phase relations to the distributor segments.

The incoming signal is repeated in the normal manner by a standard cable relay into the operating winding of the dot locking or dash locking relay. The positions of the tongues of these two relays will be determined by position of the tongue of the cable relay when the brush BR_1 is *between* the pick-up segments R_1 , R_2 , etc. When the brush BR_1 passes onto any one of these segments, these locking relays are immediately locked and held in the positions they then occupy. Thus, in the reception of the combination $+ - 0$, the passage of brush BR_1 onto segment R_1 during the time the positive or dot pulse is being received locks the dot and dash locking relays in the positions corresponding to this pulse and moves the dot intermediate relay to the marking position. During the time that brush BR_1 is in contact with that segment, no movement of the locking relays can take place due to the greater strength of the locking current.

When the brush BR_1 passes off the segment R_1 , the circuit to the intermediate relays is broken and they, being polarized, remain in the position last placed. The polarity of the regenerated signal is, therefore, determined by the polarity of the received signal at the *moment* the brush BR_1 passes onto the pick-up segment.

While the brush BR_1 is passing from segment R_1 to segment R_2 and the locking relays are again under the control of the cable relay, the brush BR_2 is passing over the segments C_1 , B_1 , A_1 . During this interval, the intermediate relays are in the dot position and therefore the printer dot relay and printer space relay will both be

on their marking contacts. When the brush BR_2 passes over segment C_1 , the release relay will be operated and this in turn will release any of the filling-in relays which might have been in an operated position. All the relays of the counting bank will be in their unoperated position. When the brush BR_2 passes over segment B_1 , a circuit will be completed from that segment through the contacts of the cut-out relay, which is normally in an operated position, through a contact of the printer space relay, through the tongue and marking contact of the printer dot relay, and through the tongue T_2 of relay 1B into printer selector magnet 1. This will trip the first code bar of the printer. The brush BR_2 now passes over segment A_1 , and relays 1A and 1B of the counting bank will be operated and locked up in the manner previously described. During the time the brush BR_2 is passing between segments A_1 and C_2 , the regenerated signal on the intermediate relays will change from a dot to a dash, and therefore the printer dot relay will return to its spacing position, while the printer space relay will remain operated. Brush BR_2 will now pass over segment C_2 , thereby operating the release relay, but since all of the filling-in relays are in their unoperated position no change in the position of these relays will take place.

Brush BR_2 now passes over segment B_2 and the circuit is completed from segment B_2 via the cut-out relay contacts and the contacts of the printer space relay and printer dot relay through the operating winding of filling-in relay FR_3 . Parallel circuits will also exist through the contacts of counting relays 1B, 2B and 3B through the operating winding of filling-in relays FR_1 and FR_2 . All of the filling-in relays, therefore, are operated and lock up. Brush BR_2 now passes over the segment A_2 and relays 2A and 2B of the counting bank operate and lock up. During the time the brush BR_2 is passing between segments A_2 and C_3 , the regenerated signal on the intermediate relays changes to zero and both the printer dot relay and the printer space relay will return to their unoperated position. Immediately after the lower tongue of the printer space relay reaches its spacing contact, a circuit will be completed from positive battery through that tongue and spacing contact to the right hand tongues of filling-in relays FR_1 , FR_2 and

FR₃, and since these relays are all in an operated position, current will flow through printer selecting magnets 3, 4 and 5, thus completing the printer combination for the letter A, which, in the expanded five unit code, becomes + - + + +. The printer space relay in moving to its spacing position also unlocked all of the relays of the counting bank which may have been operated. When the brush BR₂ passes over segment C₃, the release relay operates, thereby unlocking all the filling-in relays. The brush BR₂ now passes over segment B₃ and a circuit via the cut-out relay is completed through the tongue and spacing contact of the printer space relay, through tongue T₄ and spacing contact of counting relay 1B, and into the printer operating magnet, thus initiating the printing of the letter A. The foregoing illustrates in a general way the printing of any of the letters of the alphabet. When figures or punctuations are received, which consist of five or more pulses, the counting relay bank will be stepped up to its limit, and when the brush BR₂ passes over the B segment corresponding to the fifth impulse of the figure, a circuit will be completed from the B segment via the cut-out relay through the tongue and marking contact of the printer space relay, through the lower tongue and contact of counting relay 4B and through the operating winding of the shift relay which will operate and lock up and energise the printer shift magnet which will move the printer platen into the figures position. The operation, therefore, takes place prior to the reception of the zero pulse at the end of the code combination. The zero pulse then initiates the printing of the upper case character corresponding to the code combination.

A word space in the cable Morse code consists of two zero pulses, which, in conjunction with the zero pulse at the end of the previous letter, make a group of three zero pulses. Assume that the letter A, the printing of which has just been described, is followed by a word space. The first zero signal initiates the printing of the letter A, as previously described. When the second zero pulse is received, relays 1A and 1B of the counting bank will have been operated, and a circuit will have been completed from segment B₄ via the cut-out relay contacts, through the tongue and spacing contact of the printer space relay,

through the tongue T₄ and marking contact of relay 1B, through the lower tongue and spacing contact of relay 2B, and through the operating winding of the word space relay. The word space relay will operate and lock up and trip printer selector magnets 1, 3 and 5, which is the printer combination for the word space. When the brush BR₂ passes over segment A₄, counting relays 2A and 2B will operate. When the brush reaches segment C₅, the release relay will be operated and this in turn will cut off the locking current from the word space relay which falls back and de-energises the printer selector magnets 1, 3 and 5. When the brush BR₂ passes over segment B₅, a circuit is completed via the cut-out relay through the tongue and spacing contact of the printer space relay, through the tongue T₄ and marking contacts of relay 1B, through the lower tongue and marking contact of relay 2B, through the lower tongue and spacing contact of relay 3B, and thence through the printer operating relay which initiates the word spacing functions of the printer. If the total zero interval received over the cable was only 2 units, it would be an indication of an error and the printer will, as previously explained, print a certain mark to indicate this. There being only 2 zero intervals, the regenerated signal on the intermediate relays will change from zero to a dot or dash while the word space relay is still in an operated position. The printer space relay will move to its marking contacts, thus completing a circuit from positive battery through the lower tongue and marking contact, through a tongue of the word space relay and through printer selector magnets 2 and 4. Printer selector magnets 1, 3 and 5 have already been tripped in anticipation of the word space, and the tripping in this manner of the rest of the printer selector magnets will result in the printing of an asterisk in place of the next letter, whatever it may be.

The purpose of the cut-out relay is to make it possible to prevent the operation of the printer during idle periods when synchronising pulses are being received. The type of signal chosen to keep the regenerative apparatus in synchronism during idle periods does not have sufficient spacing or marking pulses to step up the counting relay bank to its limit and therefore the cut-out relay, when once unlocked by short-circuiting

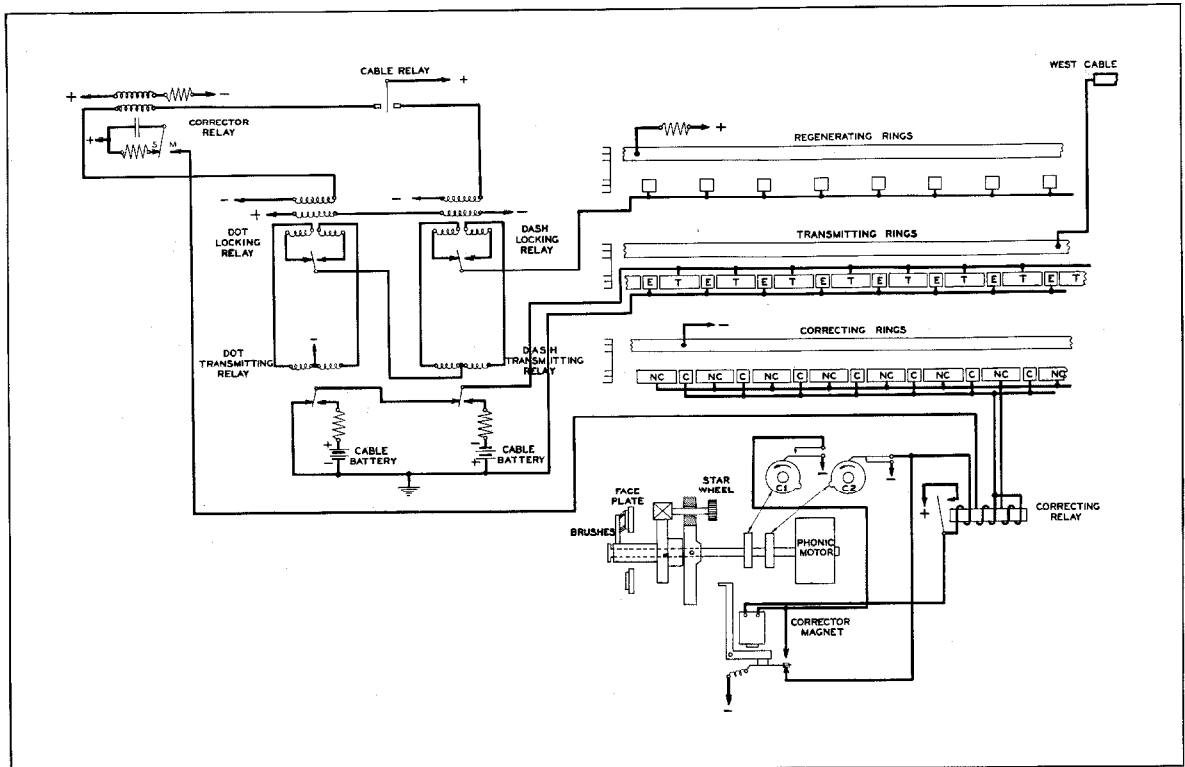

Figure 4

its winding through the depression of the cut-out key on the printer, will remain in its unoperated position until a long signal is received. The sending operator at the distant transmitter will precede the first message after a pause by a signal having five or more pulses in it, and this will automatically operate and lock up the cut-out relay again. During the time the cut-out relay is unlocked, the circuit from the B segments is open and therefore the printer will be unoperated.

Printers of this type have been placed in operation on two of the New York-London cable circuits of the Commercial Cable Company and on three of the All America Cable Company's cables to Central and South America. In the case of the installation made on the fastest Atlantic cable of the Commercial Cable Company, the speed of transmission was so much higher than the rate at which one operator could handle the received messages, that two channel operation was necessary. The terminal and regenerative repeater distributors were arranged for two channel operation, employing the method where-

in individual pulses from each channel are alternated on the cable in a manner similar to that previously employed in certain multiplex systems and in channelling systems for ocean cables.

The type of regenerative repeater used at the intermediate stations on the cable route between London and New York is shown diagrammatically in Figure 4. Referring to that figure, the signals received over the east cable operate the cable relay, and this in turn controls the dot and dash locking relays and the dot and dash transmitting relays in conjunction with the regenerating rings on the distributor, so as to produce a regenerated cable signal on the transmitting relays. The operation of this regenerating circuit is identical with that already described in connection with the printer circuits in Figure 3, the dot and dash transmitting relays on Figure 4 being equivalent to the dot and dash intermediate relays in the other diagram. The contacts of the transmitting relays do not actually make or break any current, this being done by the transmitting rings of the distributor. The

relationship between the brushes and the regenerating and transmitting rings is such that the transmitting relays will move only during the time the transmitting brush is making contact with an earthing segment "E." During the time the transmitting brush is on segments "T," the signals set up upon the transmitting relays are transmitted into the west cable. This arrangement eliminates any distortion of the outgoing signals which might be caused by the transmitting relays.

The correcting circuit which maintains the distributor in synchronism and phase with the received cable signals is also shown in Figure 4. The arrangement used is based on the Baudot system except that it has been modified to permit the correction to be generated from the cable signals instead of using line time for transmitting special correcting pulses.

The corrector relay will be actuated whenever the cable relay is on its dot contact. The condenser, which is connected to the tongue of the corrector relay, will be discharged when the corrector relay is on its spacing contact and will be charged when the tongue of the corrector relay moves over to its marking contact. The charge of this condenser will either operate or fail to operate the correcting relay depending upon whether the brush on the correcting rings is on a correcting segment marked "C" or on a non-correcting segment marked "NC." When the condenser charge occurs during the time the brush is on segment NC, the discharge passes through both windings of the correcting relay in such a direction that the currents through two windings are in opposition. The correcting relay when operated will lock itself up through its tongue and the contacts on cam C2 of the distributor. When cam C1 closes, the corrector magnet of the distributor will operate and lock up, and this will cause end A of the armature to engage with the starwheel on the distributor at a certain point in the revolution. Engagement of the armature with the starwheel will step back the brushes with respect to the motor approximately one degree. When cam C2 opens its contacts, the correcting relay will be unlocked and this relay in turn will de-energise the corrector

magnet of the distributor. The speed of the phonic motor which is controlled by an electrically driven tuning fork is set so that the speed without correction will be a trifle too fast and this stepping back of the brushes from time to time will make the brush speed correct. A novel feature of this correcting circuit is that there is no point in the revolution of this distributor during which the correcting relay will fail to lock up if a correction is needed. If the correcting relay should attempt to operate during the brief interval that the contacts of cam C2 are open, a parallel circuit will be found through the back contact of the corrector magnet armature. An important feature of this correcting system is that it is not possible to step the brushes back more than once per revolution and this has been found to be of advantage in maintaining synchronism when a group of badly distorted signals are received.

This correcting system is also used on the distributors of the terminal sets which control the regenerating and printing operations.

This cable circuit contains five repeaters and is normally operating at a speed of 262 letters per minute per channel. Experience on this and the other circuits equipped with printers has shown a marked increase in the accuracy of reception due to the elimination of practically all human errors at the receiving stations, and has resulted in material staff economies.

Bibliography

H. H. Harrison, "Printing Telegraph Systems and Mechanisms," *Longmans Green and Company*.

J. W. Milnor, "Submarine Cable Telegraphy," *Journal A. I. E. E.*, 1922, Vol. 41, p. 20.

Herbert Angel, "Printing Telegraphs on Non-Loaded Ocean Cables," *Journal A. I. E. E.*, 1927, Vol. 46, p. 884.

H. H. Harrison, "Regenerative Telegraph Repeaters," *Electrician*, 1927, Vol. 98, pp. 8, 28 and 54.

A. A. Clokey, "Automatic Printing Equipment for Long Loaded Submarine Telegraph Cables," *Bell System Tech. Journal*, July, 1927, p. 402.

R. Appleyard, "Modern Atlantic Cable Operation," *Elec. Review*, 1928, Vol. 102, p. 715.

I. S. Coggeshall, "Submarine Telegraphy in the Post-War Decade," *Journal A. I. E. E.*, 1930, Vol. 49, No. 2, p. 476.

Balancing Cables by Inductive Networks

By M. I. PUPIN

Honorary Member, American Institute of Electrical Engineers, Columbia University, New York, N. Y.

EDITOR'S NOTE:—*At the suggestion of the Commercial Cable Company, Professor Pupin, while retained in a consulting capacity by that Company, investigated the possibilities of increasing the transmission speed of its heavy cable between Canso, Nova Scotia, and the Azores. The results of this investigation, in which engineers of the Commercial Cable Company co-operated, and the artificial balancing networks which were designed in accordance with a theory developed for the purpose, are described in the following paper, reprinted from "Electrical Engineering," Volume 50, No. 12, December, 1931.*

ELECTRICAL BALANCING of submarine cables by a network of conductors for purposes of duplex telegraphy is an old art. As long as these cables had a fairly high resistance, as they did in earlier years, their signaling speed was necessarily low. Under these conditions a satisfactory balancing network, the well known artificial line, consisted of resistances connected in series, and capacitances connected from ground to each junction of two consecutive resistances. This network was the equivalent of a sectional conductor, each section having resistance and capacitance, but no inductance; electrical reactions of the network imitated the electrical reactions of the cable. At low signaling speed such a network gave satisfactory results when its sections were sufficiently small and when a sufficiently large number of sections was used.

In recent years long submarine telegraph cables of low resistance have been laid for the purpose of increasing the speed of signaling. The heavy cable laid eight years ago by the Commercial Cable Company between Canso, Nova Scotia, and the Azores has a resistance of only about one ohm per nautical mile; it was intended to transmit at the rate of 600 letters per minute. At this speed, however, the inductance reaction of the cable came into play and the old balancing network containing no inductance in its sections could not balance it. In duplex working this heavy cable had to be operated at a much lower speed to accommodate the non-inductive balancing network. The design of an efficient inductive network thus became a very important

problem in the operations of this long low-resistance cable.

Earlier Inductive Networks

Even a superficial study of this problem made obvious the fact that the old balancing artificial line had to be changed by introducing in its sections suitable inductive elements in place of the simple resistances. It was obvious also that within a certain frequency interval the effective inductance and resistance of these elements must vary with frequency, simulating the variations of effective inductance and resistance of the corresponding sections of submarine telegraph cable which was to be balanced. This seemed to introduce into the problem an insurmountable difficulty.

Breisig (*Electrotechnische Zeitschrift*, November 1899) and, twenty years later, Pernot (*Journal Franklin Institute*, September 1920; *British Patent Specification*, 1922) discovered that the effective inductance and resistance of a submarine cable section vary with frequency somewhat like the effective inductance and resistance of the primary of a transformer with its secondary short circuited. This discovery led to several attempts to imitate in the balancing network the electrical reactions of a cable by inserting in the sections of the old artificial line, transformers with short-circuited secondaries or their equivalent, that is, inductance short circuited by a non-inductive resistance or by another inductance. The most noteworthy among these attempts were those of Murihead Company and Davis (*British Patent Specification* 216,219,

March 24, 1924) and of Gilbert (*U. S. Patent*, 1,533,178, April 1925). No results ever have been published which show how these applications of the old ideas of Breisig and Pernot succeeded in practise. It will be shown presently, however, that these applications cannot lead to a satisfactory balancing network since each section in such a network must be free from external electromagnetic disturbances. This means that the network inductances must have no stray fields in order to avoid mutual induction with the inductances in adjacent sections and with other external circuits.

Murihead Company and Davis, as well as Gilbert and others, not only overlooked this important provision, but, moreover, they recommended inductances with stray fields; the theory which they followed is not applicable to their structures since they invariably employed inductive elements having mutual induction not only with external circuits but also between sections of their networks. No mathematical theory of such networks exists, and just what are the determining factors in their design, is not clear.

Inductive Network with No External Field

In the following paragraphs will be discussed inductive networks having in their sections inductance coils with no external magnetic fields. In such networks the sections have no mutual induction with each other nor with external circuits; they are, therefore, free from external electromagnetic disturbances.

In a submarine cable which already is laid, the only quantities that can be measured are its terminal reactance and resistance at various frequencies. These measurements were made on a typical cable and formed the foundation of the study discussed here.

Curves A and B of Figure 1 represent at various frequencies the effective terminal resistance a_f and the effective terminal reactance b_f of a cable as determined by wheatstone bridge measurements. The cable is one belonging to the Commercial Cable Company and connects Far Rockaway, Long Island, with Canso, Nova Scotia. Its constants are
 Length $l = 974.33$ nautical miles
 Average capacity $c = 0.384 \mu f$. per nautical mile

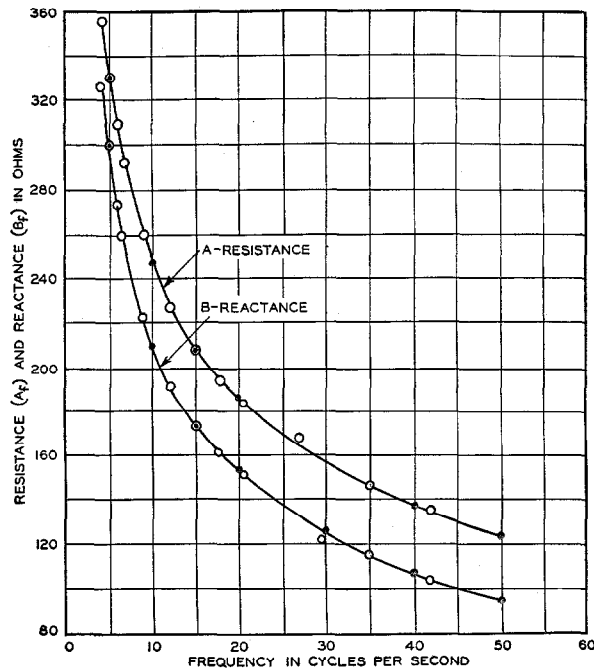

Figure 1—Effective Terminal Resistance (A) and Reactance (B) for a Typical Submarine Telegraph Cable (circles) and for the Inductive Network Designed to Balance it (dots).

Average copper resistance $r = 2.45$ ohms per nautical mile

Submarine cables are not of the same size at each point in their length; shore ends are much larger than deep sea parts, and hence the effective capacity and the effective inductance vary from point to point. The cable just referred to thus is not uniform, but a uniform cable which at all frequencies will have the same terminal reactance and resistance as this cable can be designated in theoretical studies; call it the *equivalent cable*. It can be specified as follows: Let C_f' , R_f' , and L_f' be the capacity, resistance, and inductance respectively per unit length of this equivalent cable at frequency f . Then if it is to have the same terminal reactances and resistances at various frequencies as those recorded in Figure 1

$$a_f - i b_f = \sqrt{\frac{L_f'}{C_f'} - \frac{i R_f'}{p C_f'}}$$

or
 $(a_f^2 - b_f^2) C_f' = L_f'; 2 p a_f b_f C_f' = R_f'$ (1)

where $p = 2 \pi f$
 Make C_f' independent of the frequency and equal

to 0.384 μ f., the same as the average capacity per unit length of the Far Rockaway-Canso cable. From eqs. 1 and curves *A* and *B* of Figure 1, the effective resistances R_f' and inductances L_f' of the equivalent cable were calculated. From these calculations curves *A* and *B* of Figure 2 were plotted for the frequency interval between 5 and 50 cycles per second.

An inductive network which can balance this equivalent cable obviously will balance also the original cable. Such a network will balance the equivalent cable at every frequency for which the effective inductance and resistance in its sections are the same as in the corresponding lengths of the cable. The aim of this study was to design a balancing network of this kind, employing in its sections inductance coils possessing no external fields. Several methods of construction were found to give very satisfactory results. The simplest of these is described here in some detail.

Network of Inductances in Series

The network discussed here employs in each of its sections two inductance coils connected in series as shown by coils 3 and 4 of Figure 3. Each coil is toroidal in shape and thus has no external magnetic field; one is shunted by a simple resistance R_1 . The unshunted coil has inductance l_0 and resistance r_0 . Let L be the inductance of coil 4 and R its resistance, without the shunting resistance R_1 . Then it can be shown that at frequency $10s$, and with coil 4 shunted by resistance R_1 , the effective inductance L_{10s} and the effective resistance R_{10s} of the two coils connected in series will be

$$L_{10s} = \frac{L(1-a)^2}{1+s^2 a_0^2} + l_0; \quad R_{10s} = \frac{(a+s^2 a_0^2) R_1}{1+s^2 a_0^2} + r_0 \quad (2)$$

$$\text{Where } a = \frac{R}{R+R_1} \text{ and } a_0 = \frac{2\pi \times 10 L}{R+R_1}$$

At frequencies $10s=20$ and $10s=30$

$$L_{20} = \frac{L(1-a)^2}{1+4a_0^2} + l_0; \quad R_{20} = \frac{(a+4a_0^2) R_1}{1+4a_0^2} + r_0$$

$$L_{30} = \frac{L(1-a)^2}{1+9a_0^2} + l_0; \quad R_{30} = \frac{(a+9a_0^2) R_1}{1+9a_0^2} + r_0$$

Hence

$$\frac{L_{20}-L_{30}}{R_{30}-R_{20}} = \frac{L(1-a)}{R_1} = \frac{L}{R+R_1} = \frac{a_0}{2\pi \times 10} \quad (3)$$

As may be seen later eq. 3 has proved very useful in the theory of the design of inductive balancing networks.

If curves are plotted for L_{10s} and R_{10s} , the inductance and resistance curves given by eq. 3, then for the frequency interval from $10s=5$ to $10s=50$ the inductive network will balance the equivalent cable to the extent, only, that these curves coincide during that interval with curves *A* and *B* of Figure 2. The problem of this study is, therefore, to adjust the physical constants of coils 3 and 4 (Figure 3) so that within this frequency interval the curves for L_{10s} and R_{10s} , as given by eqs. 2 coincide as nearly as possible with curves *A* and *B* of Figure 2. The frequency interval between 5 and 50 cycles per second is considered here because it is the important interval at the signalling speeds of the cable under consideration, that is, 600 letters per minute.

Assume that these curves coincide at frequencies 20 and 30, and that each section of the inductive network represents ten nautical miles of the equivalent cable; then

$$\left. \begin{aligned} 10 L_{20}' &= L_{20}; & 10 L_{30}' &= L_{30} \\ \text{and} & & & \\ 10 R_{20}' &= R_{20}; & 10 R_{30}' &= R_{30} \end{aligned} \right\} \quad (4)$$

Under what conditions will these coincidences occur? It will be shown presently that equation

$$\frac{L_{20}-L_{30}}{R_{30}-R_{20}} = \frac{L_{20}'-L_{30}'}{R_{30}'-R_{20}'} \quad (5)$$

determines these conditions completely, because (see eq. 3) it assigns definite values to all of the physical constants in eq. 2. These constants are: a_0 , l_0 , R_1 , R , r_0 , and $a=R/(R+R_1)$. The assumptions (eq. 4) leading to eq. 5 are, therefore, the foundation for the procedure of designing the inductive network considered here.

The right-hand member of eq. 5 has, according to Figure 2, a definite numerical value equal to 1/109 approximately. The left-hand member of

eq. 5 is equal to $a_0/(2\pi \times 10)$ according to eq. 3. Hence

$$a_0 = \frac{2\pi \times 10}{109} = 0.576$$

and
 $a_0^2 = 0.332$

This constant a_0 in the equations of the inductance and resistance curves of the network is therefore fixed by experiment. The other constants in eqs. 2 also are definitely fixed by experiment as follows:

$$\frac{L_{20} - l_0}{L_{30} - l_0} = \frac{10L_{20}' - l_0}{10L_{30}' - l_0} = \frac{1 + 9a_0^2}{1 + 4a_0^2}$$

Whence $l_0 = 18.30$ mh.
 Again from eq. 2

$$(1-a)^2 L' = \frac{(10L_{20}' - l_0)(1 + 4a_0^2)}{L} = 56.57 \text{ mh.}$$

Having selected a convenient value for L , the inductance of the shunted coil without R_1 , the constant $a = R/(R + R_1)$ also is fixed. It is 0.387 when $L = 0.15$ henrys. Since

$$1 - a = \frac{R_1}{R + R_1} = \frac{R_1 a_0}{2\pi \times 10 L} = 0.613$$

$$R_1 = \frac{2\pi \times 10 L \times 0.613}{a_0} = 10.0 \text{ ohms.}$$

$$R = \frac{a R_1}{1 - a} = 6.3 \text{ ohms}$$

$$r_0 = 10 R_{20}' - \frac{(a + 4a_0^2) R_1}{1 + 4a_0^2} = 20.0 \text{ ohms}$$

If therefore the physical constants of the two inductance coils in the sections of the inductive network have the values which have been calculated by means of eq. 5, then the inductance and resistance values will be as indicated in eqs. 4. The question now arises as to how the effective inductance and resistance curves of the two structures compare at other frequencies. This comparison is obtained easily by substituting successively different values of frequency from $10 \text{ s} = 5$ to $10 \text{ s} = 50$ in the following equations:

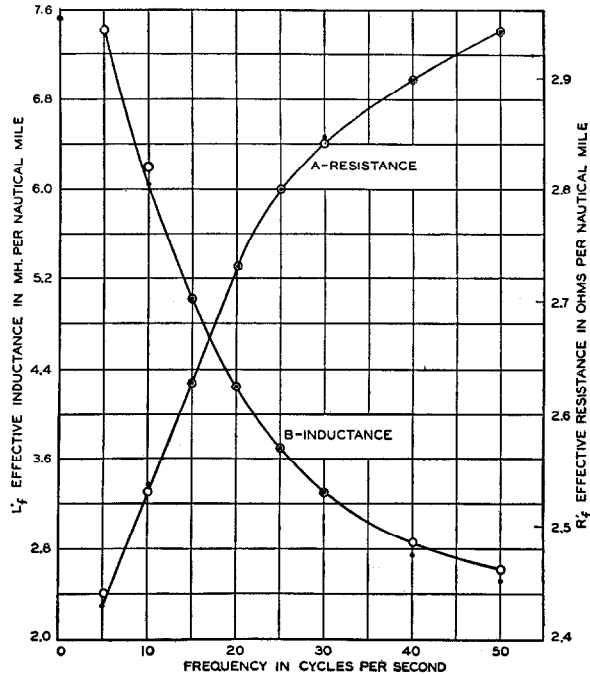

Figure 2—Effective Resistance (A) and Inductance (B) per Nautical Mile for "Equivalent" Cable (circles) and for the Network Designed to Balance it (dots).

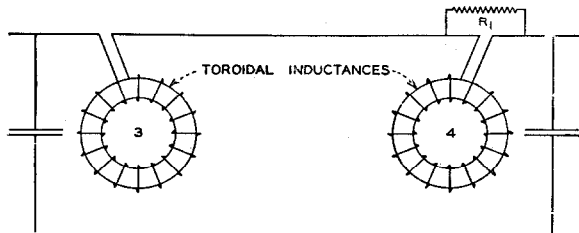

Figure 3—Schematic Diagram of a Section of Inductive Balancing Network With no External Magnetic Field.

$$\left. \begin{aligned} L_{10s} &= \frac{56.57}{1 + 0.332 s^2} + 18.3 \\ R_{10s} &= 20.0 + \frac{(0.386 + 0.332 s^2) 10}{1 + 0.332 s^2} \end{aligned} \right\} (6)$$

These equations are obtained by inserting in eqs. 2 the values of the constants just calculated. The values of inductance and resistance thus calculated from eqs. 6 were plotted by dots in the curves of Figure 2. The overlapping of the effective inductance and resistance curves of the equivalent cable with those of the inductive

network certainly is remarkable. However, the overlapping of the terminal reactance and resistance curves is even closer as is indicated by curves *A* and *B* of Figure 1. In these curves the small circles denote values determined by wheatstone bridge measurements on the cable and referred to previously, while the dots denote values calculated by eqs. 1 from L_{10s} recorded on curves *A* and *B* of Figure 2, and verified later experimentally by measurements on the inductive balancing network after this had been constructed.

Since the terminal impedance curves of the inductive network and of the equivalent cable coincide within the frequency interval between 5 and 50 cycles per second it follows that the network will balance the cable within that frequency interval. Practical operations are in complete agreement with this theoretical result. The same method of procedure was followed in the design and construction of inductive network balances of this type for other cable terminals, and in each case the result was just as satisfactory as in the case just described.

Modern Loading Equipment

By J. B. KAYE

International Standard Electric Corporation

EDITOR'S NOTE: *Conclusion of paper which appeared in the January, 1932, issue of Electrical Communication.*

Loading Coil Cases

THERE are four essential requirements for a loading coil case, namely, that access to the coils shall be solely electrical, that the coils shall be fully protected mechanically, that each circuit shall be isolated from every other and that there shall be an easy method of making connection between the coil conductors and the main cable conductors.

In addition to the above essentials, there are three desirable refinements; first, it should be possible to add more loading equipment at the same point without disturbing the existing loaded circuits; second, the equipment should be compact; third, there should be a reasonable degree of accessibility in the event of repairs becoming necessary.

The question of the best means of securing the above features is one which has received considerable attention and which at times has risen to controversy. Suggestions have ranged from encasing the coils in a form of entombed exchange-type repeating coil rack to inserting them under the main cable sheath during the application of the latter.

Experience has shown that the best manner of fulfilling all the requirements which have arisen or are likely to arise in Europe is to have available two types of loading case, one type intended for installation in a manhole and the other type for use directly in the ground. It is only in recent years that the last mentioned type of case has come to the fore since it was previously the almost invariable practice to install the case in some form of protected excavation, such as a suitable manhole, or even in a pipe full of sand.

The first type of case to be designed consisted of a cast iron container fitted with one or two auxiliary cables known as stub cables which provided the means of connection to the coils. Since this type of case was the forerunner of all

others, it will be described first. The other type of case intended for direct burial possesses a jointing chamber in place of the stub cable and is usually referred to as a stubless case.

Before entering into a detailed description of the cases it should be noted that the designs now available are those which have had the benefit of manufacturing and installation experience under a variety of conditions. One of the most essential requirements for successful design is close co-operation with the installation groups.

Loading Coil Cases Fitted with Stub Cables

The cases with stub cables, as already mentioned, were designed for use in underground manholes, and the method of encasing the coils still holds in principle at the present day. Owing to the fact that the description of coils has been limited to the commencement of the period when the phantom circuit coil of a given type has the same overall diameter as the associated side circuit coils of the same type, it is apparent that so far as this paper is concerned, encasing methods which apply to coils also apply to 3 coil units.

Prior to the period of phantom and side circuit coils having equal diameters, it was necessary to stack the coils for each type of circuit in independent columns, for which reason the most economical shape of case from the space standpoint was roughly cylindrical.

The type of coil which comprises the unit referred to as the large iron dust cored unit was the first type having equal diameter coils for both side and phantom circuits. Its introduction simplified the selection of case ranges and to some extent, the manufacturing assembly.

The following paragraphs outline the method of assembly which applies generally to all the

coils or units which have been under review.

The wound coils are first subjected to a drying and impregnating treatment in order to render them impervious to the agents which bring about insulation defects; they are then stacked coaxially upon rods made of wood or insulated metal known as dowels. Between each coil is placed an iron washer to isolate the coil both magnetically and electrostatically. This washer is particularly important in the case of units which are always stacked first with the phantom circuit coil followed by its pair of associated side circuit coils, then the phantom coil of the next unit and so on.

The dowelling process is carried out in a test room as distinct from carrying out tests in a factory operation room. Such a test room is shown in Figure 22, in which stacks of dowelled coils may be seen in the rack on the right, whilst coils in the process of selection lie on the bench to the left.

Interspersed with the dowelling operation is the fitting of the auxiliary cable forms used to make connection between the coils and the stub cable. These cable forms consist of identifiable insulated copper conductors laid up in a formation calculated to produce a minimum of interference between circuits. One or more such forms may be used depending upon the number of coils on the dowel.

Having built up a dowel with the necessary number of units or coils the complete stack is clamped firmly together by means of nuts at each end of the dowel rod. The completed dowel assembly is then subjected to further impregnation treatment and is inserted into a tubular iron canister, the free ends of the interconnecting quads projecting above the top of the canister which is then filled up with insulating compound.

The choice of a suitable insulating compound is not so simple as might be at first supposed since the requirements are somewhat comprehensive. It must have high insulating properties, it must not contract to any great extent upon cooling, it must not crack at the low temperatures encountered in ice covered ground, it must not become fluid at the temperatures met with in the tropics and, finally, it must not have any corrosive action upon the contents of the loading coil case. In spite of the stringency of the above requirements, it has been found possible to make

a compound which gives a satisfactory performance on all points and which has given no indication of failure through a long period of use.

The compound sealed canister is what might be termed the unit of manufacture—that is, all later processes are concerned more with mechanical operations than with electrical adjustments. Since the stage of the completed canister as distinct from coil manufacture is the most desirable point for preventing the inclusion of faulty coils in the case, very exhaustive electrical tests are carried out on it.

The advantages of completing the unit of manufacture at the earliest possible stage in manufacture are manifold since the coils themselves are now protected against injury from the handling which they must undergo during the later stages. Furthermore, there will be no impairment of the insulation during storage under factory conditions, a factor which is of primary importance in the securing of flexibility of operation.

The next question is the choice of a suitable shape for the case. The cylindrical shape as used for the large iron dust cored unit cases is unsuitable from the standpoint of flexibility in case ranges when it is desired to cover a large number of units in one case. This difficulty was not encountered on the type of equipment just mentioned because the case had become too unwieldy to handle before the increase in diameter of the case coincided with a very large increase in the quantity of units which could be encased.

The above may perhaps be stated more clearly by taking actual dowel layups in cylindrical cases. Thus, the first range would be a single dowel case, then three dowels, next seven dowels grouped as a central dowel with six surrounding dowels and, finally, a nineteen dowel case grouped as one central dowel, six dowels around the centre and then twelve dowels around them.

Assuming that the maximum stacking height of a dowel is five units, the corresponding maximum capacities for the ranges quoted are 5 units, 15 units, 35 units, and 95 units respectively. The equivalent position with regard to a range of cases of square cross section is a first range of one dowel which may, of course, be cylindrical, a second range of four dowels, a

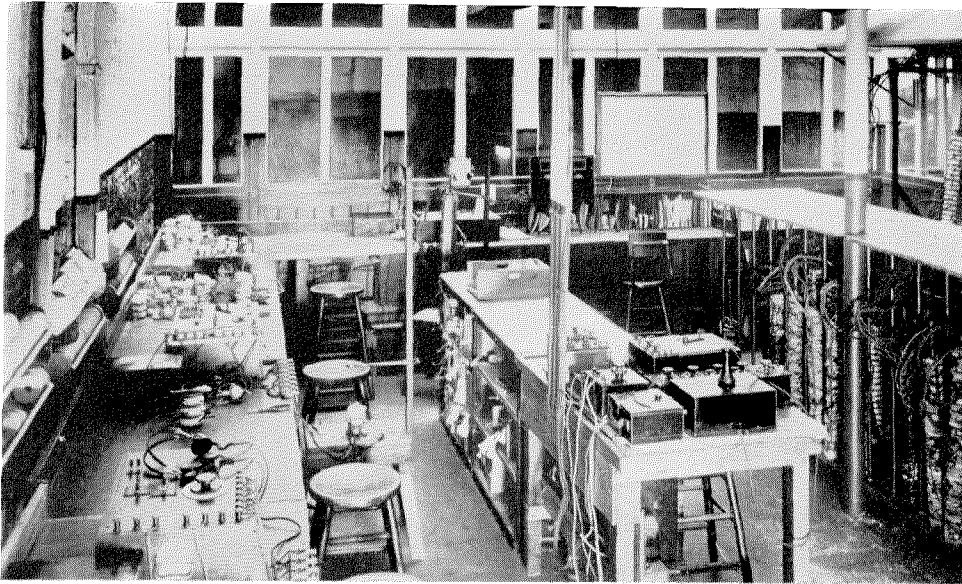

Figure 22—Dowel Assembly and Test Room.

third range of nine dowels and a final range of sixteen dowels, each case being set out in square formation.

Assuming again that the maximum height of case is five units, then the maximum capacities for each range are 5 units, 20 units, 45 units, and 80 units, respectively.

It will therefore be seen that the cases of square cross section give a better range distribution than those of cylindrical shape and this is most marked for cases containing more than twenty units, a condition which covers the majority of the cases required. Another point in favour of the use of the square cross section type of case is that the manhole space required for a case is the volume of the right prism of square cross section which will just contain the case. This volume is the same for a cylindrical case as for a square cross section case having a length of side equal to the diameter of the former.

For these reasons the inception of the small iron dust cored unit was accompanied by a change to the square cross section type of case, and since the maximum stacking height for the dowel was taken to be the height of 4 units, the maximum case content was 64 units, this being

considered the largest case which could be conveniently handled.

The reduction in case dimensions occasioned by the use of the permalloy dust cored unit (Stanelec) enables eight units to be stacked on one dowel, thus permitting the construction of a case containing 128 units and having a mass of approximately three quarters that of the case containing 64 small iron dust cored units.

The number of units which may be contained in one case of the stub cable pattern is now no longer limited by its dimensions but depends instead upon the conductor content of the stub cables which will be described later.

Before passing on to the next stage of manufacture, there is one point regarding the location of units on the dowels which should be noted and that is the question of units for 4-wire circuits. When a case contains units for loading only 2-wire circuits there is no need to adopt any dowelling scheme other than that of straightforward stacking; when, however, the case contains units for 4-wire circuits or for both 4-wire and 2-wire circuits, it is desirable to separate the units which load 4-wire circuits in one direc-

tion from the units which load the 4-wire circuits operating in the opposite direction.

The degree of segregation required is insufficient to warrant any modifications to the normal case design as the separation of individual units resulting from the use of metal separating discs on the dowels, together with the canister wall, is sufficient for the purpose. Wherever possible, advantage is taken of the presence of units for 2-wire circuits by locating them at the point between the two groups of 4-wire circuit units. The auxiliary cables from a dowel of units for 4-wire circuits are always screened by means of metal foil or a braided metal sheath.

There is no necessity to screen 4-wire circuits from 2-wire circuits since the transmission level of the latter is approximately a mean between the levels of the two opposite directions of the 4-wire circuits, and the difference of level between a 2-wire circuit and a 4-wire circuit is never so great as that between two of the latter circuits.

When coils for music circuit loading are included in a case it is usual to confine them to one dowel, to space them apart by a distance equal

to twice the axial height of a coil and to screen the auxiliary wiring.

Up to the present the cases have consisted simply of cast iron boxes having a case wall of from 13 to 23 millimetres in thickness depending upon the volume of the case, the iron being of a high quality with a very fine grain.

On the outside of the case, around the open end, there is a projecting flange through which holes are drilled for the fixing of the cover and the top surface of this flange is accurately machined to a smooth, level surface.

An air pressure test is carried out on the casting by clamping a temporary cover to the open end of the case, immersing the case in water and applying compressed air through a tube in the cover; the case has to withstand a pressure of 4.2 kilograms per square centimetre for a period of ten minutes. The case is then treated with a compound which makes it proof against any corrosive agent likely to be encountered after installation.

The next stage is the insertion of the canisters in the case after which it is filled with insulating compound until the tops of the canisters are

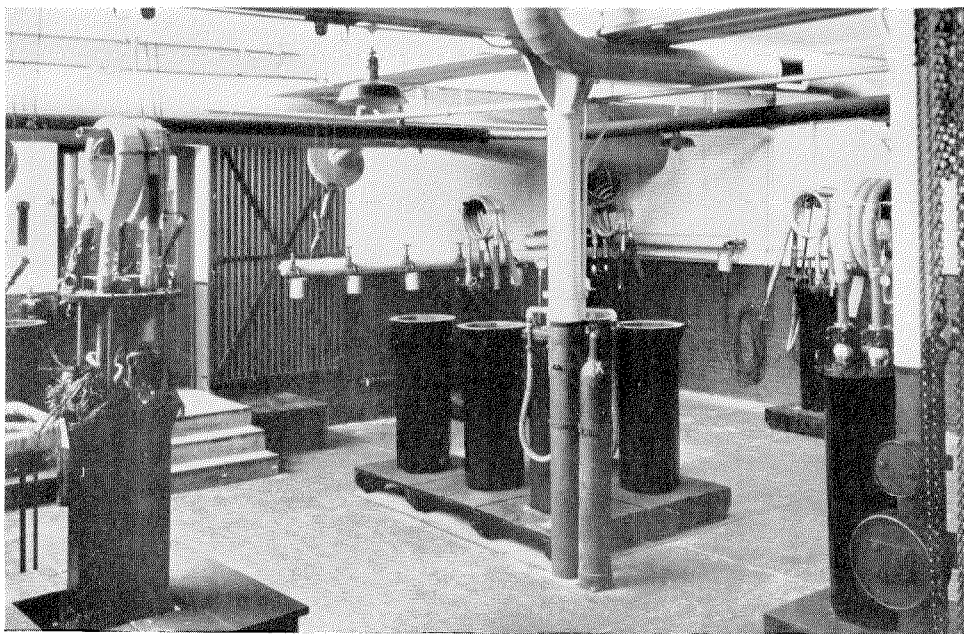

Figure 23—Case Assembly Room.

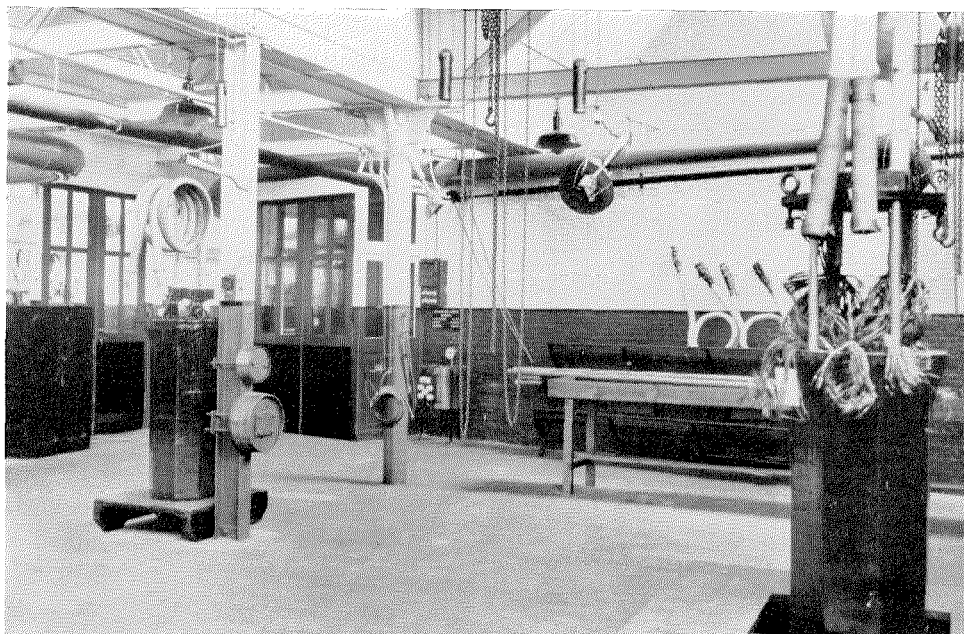

Figure 24—Case Assembly Room.

covered, the dowel cables being brought up through the surface of the compound.

After the preliminary filling the stub cable and cover are applied, the method used being to support the cover above the case flange at a height sufficient to give clearance for the jointing operation and then to pass the stub cable through a brass nipple which is screwed into the cover. A metal gasket is placed on the case flange for use in the sealing of the joint between case and cover.

The stub cable may be inserted before it is bent into position for packing or it may be bent prior to insertion.

Figures 23 and 24 show some special octagonal cases fitted with two stub cables in the course of construction; the metal drums on the ceiling supporting girders are for bending the stub cables whilst the large rosette shaped projections on the pipes near the roof are part of the air conditioning plant which maintains the temperature and humidity of the air in a suitable condition.

The armoured pipes suspended from the central column in Figure 23 are for applying compressed air to the case during pressure tests. Near the same column may be seen a gas cylinder containing nitrogen under pressure for use in drying the stub cables, from which it may be inferred that the equipment is not merely dry but is actually "tortured" to dryness. Against the wall in the background may be seen a number of taps attached to a steam heated pipe which is used for conveying the filling compound to the cases.

When the joints have been made the stub cable and wiring are pressed down inside the case and additional insulating material is applied at all points where contacts might occur.

More filling compound is then poured into the case to cover the joint and the end of the stub cable, whereupon the cover supports are removed and the cover is lowered down on the top of the case with the gasket intervening. The gasket has been previously coated with a sealing paste. The cover is then bolted down to the case flange by

bolts passing through coincident holes in the flange and cover and which either pass through holes in the gasket or just clear the external rim of the gasket.

A lead joint is made between the stub cable sheath and the brass nipple in the cover. This joint which requires considerable operative skill in the making is not truly a plumber's "wiped" joint, although it is usually referred to as such.

The stub cable is clamped just above the nipple joint by means of a bracket which is permanently fixed to the cover. Having completely sealed the case and also temporarily sealed the free end of the stub cable, another air pressure test is applied through a small hole in the cover and if the case passes this test a sealing compound of bituminous composition is forced into the case until the space between the top of the original sealing compound and the cover is entirely filled.

The cover is recessed on the under side above the level of the gasket seal so that even if the latter is penetrated by moisture it has also to penetrate both the bitumen compound and the resinous compound before reaching any electrically vulnerable points. The filling vents in the cover are sealed by means of screw plugs. Elec-

trical tests are carried out at various points during the course of the foregoing operations and when the cover has been finally sealed complete tests of all the electrical properties are carried out. Two views of a final test room are shown in Figures 25 and 26.

Finally, the stub cable end is closed by means of a lead seal and the cable is bound to a hoop type of support for protection during shipment.

The diagram, Figure 27, shows the construction of the type of case described above, whilst Figure 28 shows a case fitted with the temporary stub cable supports which are removed immediately prior to installation.

Since the stub cables are the part of the equipment which especially concerns the user from the viewpoint of handling, the following description may be of interest:

In the first place, it must be remembered that a stub cable has to withstand much more handling than the main cable with which it is to be associated since it not only has to be uncoiled from its packed position but it also may have to undergo considerable bending during installation or even after installation when it is desired to accommodate other cases in the same manhole. For these reasons the lead sheath is somewhat

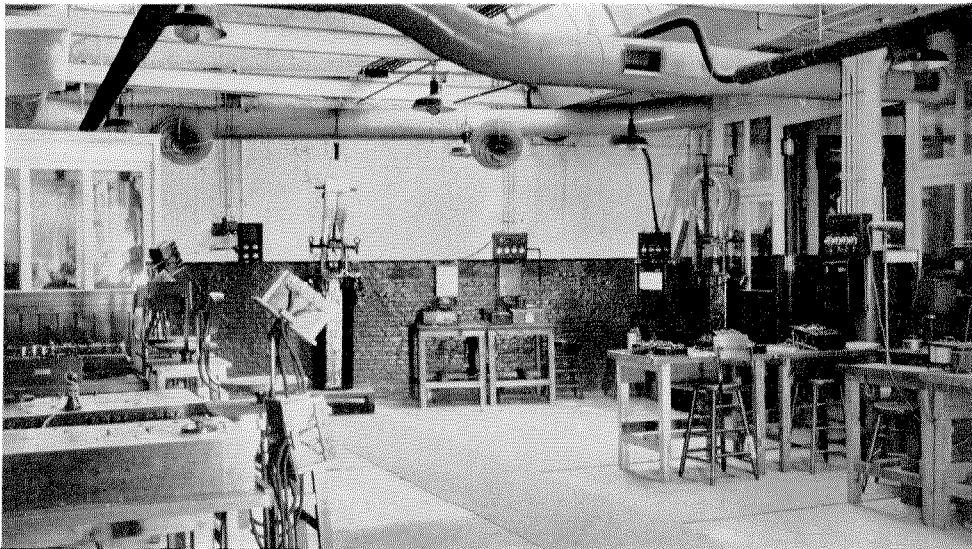

Figure 25—Final Test Room.

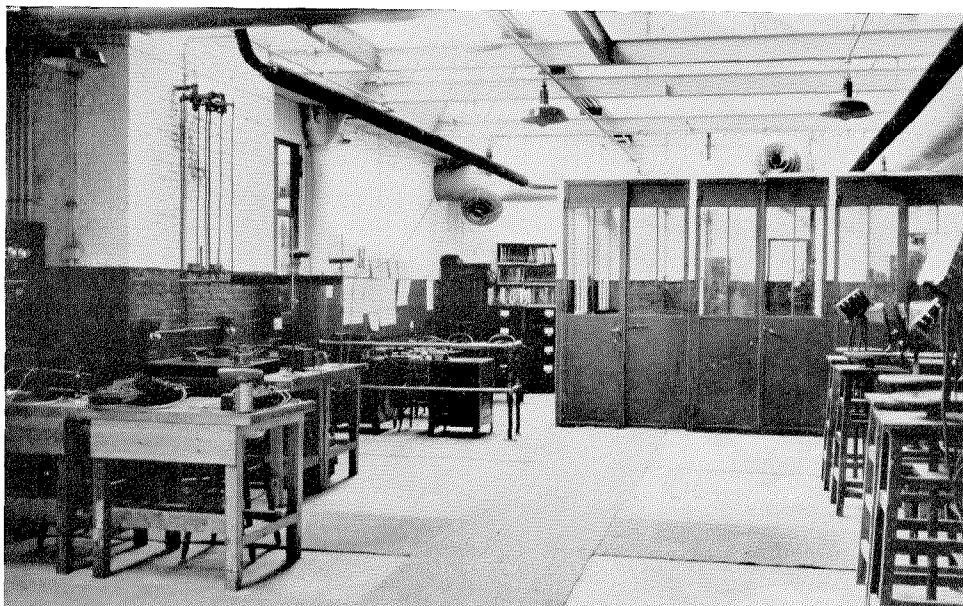

Figure 26—Final Test Room.

thicker than that of the main cable and is usually of the order of 3 millimetres. The best composition for the sheath has been found by experience to be an alloy of lead and antimony which is such as to give flexibility and at the same time maintain its inherent tensile properties in spite of being subjected to vibrations such as those due to nearby traffic.

The stub cables which are of the multiple-twin type have been standardised in lay-up and have the conductor contents given in Table I.

When the contents of the case do not exactly utilise all the conductors in the stub cable the unused quads are left isolated. If the case contains units for 4-wire circuits of opposite direction or if it contains music circuit coils, then a stub cable is selected such as will contain blank quads sufficient to provide segregation between the quads to the circuits in question and any other circuits which are considered prone to interference.

It will be seen above that the largest stub cable available contains 102 quads, a size which is considered the limit for a stub cable containing

0.9 millimetre diameter conductors. Any larger stub cable would be difficult to manipulate. By using 0.63 millimetre conductors it is possible to make a manageable stub cable containing 140 quads, but the difficulty of jointing such a conductor to the larger gauge conductor of the main cable has prevented the adoption of such a course.

It will be seen, therefore, that owing to the limitation in stub cable conductor content, the maximum number of units which may be encased in stub cable type cases are 51 units for a single stub case and 102 units for a double stub case, the corresponding figures for pair circuit coils being 102 coils and 204 coils, respectively. If the user of the equipment is willing to accept the 0.63 mm. conductors, it is of course possible to extend the above maxima to 70 and 140 units, or 140 and 280 coils in single and double stub cable cases, respectively.

Tables II and III give details of the various cases which have been standardised for the Stanelec units and coils for use on long distance cables.

TABLE I

Total Number of Quads in Stub Cable	Number of Quads in Centre	Number of Quads in 1st layer	Number of Quads in 2nd layer	Number of Quads in 3rd layer	Number of Quads in 4th layer	Number of Quads in 5th layer
7	1	6				
19	1	6	12			
24	2	8	14			
37	1	6	12	18		
44	2	8	14	20		
61	1	6	12	18	24	
80	4	10	16	22	28	
91	1	6	12	18	24	30
102	2	8	14	20	26	32

TABLE II
CASES WITH SQUARE HORIZONTAL CROSS SECTION

Code No. of Case	Code Letter		Maximum Capacity		Overall Dimensions Millimetres			Approximate weight with coils— Kilograms
	1 Stub	2 Stubs	Units	Coils	Height	Across Sides	Across Corners	
015	A	N	128	384	1240	540	620	684
015	B	O	112	336	1125	540	620	630
015	C	P	96	288	1010	540	620	576
015	D	Q	80	240	895	540	620	522
015	E	R	64	192	780	540	620	468
016	A	N	54	162	985	430	515	360
016	B	O	45	135	870	430	515	324
016	C	P	36	108	755	430	515	288
016	D	Q	27	81	640	430	515	252
017	A	N	16	48	715	340	390	162
017	B	O	12	36	600	340	390	144
017	C	P	8	24	485	340	390	126
017	D	Q	4	12	370	340	390	108

TABLE III
CYLINDRICAL CASES

Code No. of Case	Code Letter		Maximum Capacity		Overall Height millimetres	Overall Diameter millimetres	Approximate weight with coils— Kilograms
	1 Stub	2 Stubs	Units	Coils			
012	A	—	2	7	450	225	40
012	B	—	1	4	330	225	33

The design of cases for the small exchange area coils is essentially the same as that just described and is being extended to the use of a welded steel case as distinct from cast iron, but as the construction of the former is still in its initial stages the data on exchange area coil cases tabulated below is limited to cases constructed of cast iron.

As the exchange-area main cables are usually

composed of small gauge conductors it is possible to use stub cables with 0.63 mm. conductors without interfering with the normal jointing practices.

It will be noted that cylindrical cases are again in evidence, the reason for this being that the coils are so small that this type of case has had to be associated with the square cross section

type in order to extend the flexibility of the range.

For reasons already stated, the coils having inductance values in excess of 88 millihenrys have an increased axial height and two quantities are therefore quoted for each size of case. (Tables IV and V).

It should be remembered that the cases tabulated are standardised only because they have been found by experience to fulfill the usual loading requirements of main cables and that cases of special shape can be designed and constructed without unduly disturbing the normal manufacturing routine.

Instances arise occasionally where it is desirable to fit some form of protection to the stub cable and this is done by the use of flexible steel tubing which is slipped over the stub cable and fixed to the cover of the case by means of a flange which is bolted to a cylindrical box protecting the joint between the nipple and the stub cable. Such a construction is shown in Figure 29. Cases fitted with the above form of protection may be buried directly in the ground without

fear of damage due to corrosion or of accidents in the course of later excavations.

In concluding this description of the stub cable type cases an enumeration of their advantages may be of interest.

The chief merit is probably that of being able to locate a case irrespective of the position of the main cable as it is possible to bend the stub cable within the limits required to make a suitable connection with the main cable, an advantage which is also apparent if it is desired to move the case in the manhole without disturbing the joint.

Another advantage is that the joint between the stub and main cables is of the normal cable type and the operators require no special instructions.

It is admitted that the stub cable presents a vulnerable point for accidents of a mechanical nature but, even so, the fault is usually identified and remedied before moisture has penetrated to the interior of the case.

Up to the present, approximately 20,000 of

TABLE IV
CASES WITH SQUARE HORIZONTAL CROSS SECTION

Maximum Capacity of Case Coils		Height to top of cover. Millimetres	Overall Length of Side Millimetres	Overall width across Corners Millimetres	Approximate weight with coils. Kilograms
Inductance above 88 millihenrys	Inductance of 88 millihenrys or less				
256	288	790	460	560	350
224	256	725	460	560	325
192	224	650	460	560	300
160	192	580	460	560	270
128	160	510	460	560	245
96	112	440	460	560	215

TABLE V
CYLINDRICAL CASES

Maximum Capacity of Case Coils		Height to top of cover. Millimetres	Overall Diameter. Millimetres	Approximate weight with coils Kilograms
Inductance above 88 millihenrys	Inductance of 88 millihenrys or less			
84	98	700	375	177
70	84	620	375	160
56	70	535	375	143
42	49	455	375	126
28	35	370	375	109
18	21	425	285	78
9	12	340	285	68
6	6	295	285	64

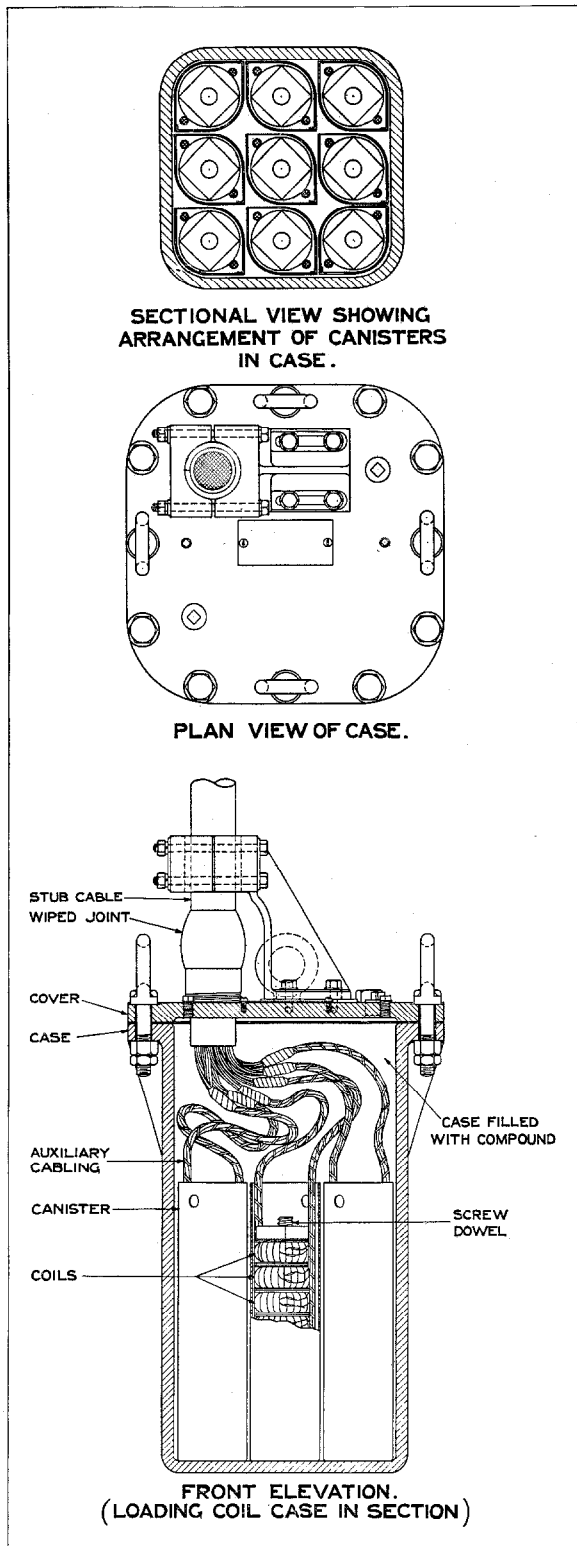

Figure 27—Stub Cable Type Loading Coil Case.

the above type cases have been installed in Europe, and approximately 0.1% of that number are returned each year for insulation or structural repairs.

Stubless Cases

Apart from a modification in the dowel cables the stubless case assembly is identical with that of the stub cable case up to the point where the cover is fitted.

The modification to the dowel cables consists of omitting any auxiliary conductors between the terminal wires of the coils and the conductors which are connected directly to the main cable; that is, the conductors which are connected to the coil terminal wires pass straight into the jointing chamber of the case. The method of connection eliminates any jointing in the case external to the canisters, thereby eliminating four conductor joints per coil and eight conductor joints per unit with a consequent saving of volume, time and vulnerable points.

In order to avoid a conglomeration of wires within the case, which would be detrimental from the crosstalk standpoint, the wiring is carried out by means of cables containing 18 quads which are laid up identically with the standardised stub cable of 19 quad capacity already mentioned except that there is a dummy centre and of course there is no metallic sheath. The case end of each cable is split into a number of sections equivalent to the number of dowels which can be accommodated by one complete cable. After the coils on the dowels have been wired to the cable the dowels are inserted in canisters and the latter filled with compound in the usual manner.

The groups of canisters with their associated cables are then placed in the cast iron case and each 18 quad cable is carried by means of an insulating framework to the centre at the top of the case after which the latter is filled with compound to within a short distance from the top.

The cover of the case is similar to that used for the stub type case except that the brass nipple is of a larger and heavier construction, having dimensions such as to accommodate all the 18 quad cables connected to the coils and having a thick flange midway between the top and the point where it enters the cast iron cover.

The cover is bolted down to the top of the case with the normal gasket seal at the point of contact with the flange, the cables being brought out through the nipple which is forced into the cover by means of a taper screw and sealed.

When the cover has been sealed the cables are arranged in a suitable formation and bituminous compound is forced into the case through holes in the cover until the compound emerges at the top of the nipple, great care being taken to prevent the formation of vesicles. The filling holes and gas vents are then sealed with gas plugs.

In order to protect the cables during storage and shipment they are put into a sealed metal case which is lightly soldered to the flange on the nipple.

The method of installation is to remove the metal can and replace it by a formed lead sleeve shaped like an inverted isosceles triangle so that one corner has a hole which can be placed over the nipple with the rim resting on the flange whilst the holes at each of the other corners are in alignment with the main cable. This sleeve is in two sections so that the conductors in the case cables may be joined to the main cable conductors in the normal manner of a T splice, after which the sections are soldered together and wiped joints are made between the sleeve and the main cable along with the usual soldered joint between the nipple and the sleeve. It will thus be seen that all joints between the main cable and the case are of the lead seal type which experience has shown to be the most efficient for the purpose.

When the joint has been completed a cast iron protection cover constructed in sections is bolted to the case cover and clamped to the main cable which, under the conditions necessitating the use of a stubless case, is generally of the armoured type as distinct from the unarmoured cable running in a duct.

The construction of such a case is shown in Figure 30, whilst Figure 31 shows a completed case with the joint protection cover in position.

The most suitable shape of case is that having a rectangular horizontal cross section since by placing the longer side parallel with the cable trench a minimum amount of excavation is required although in certain instances a large base

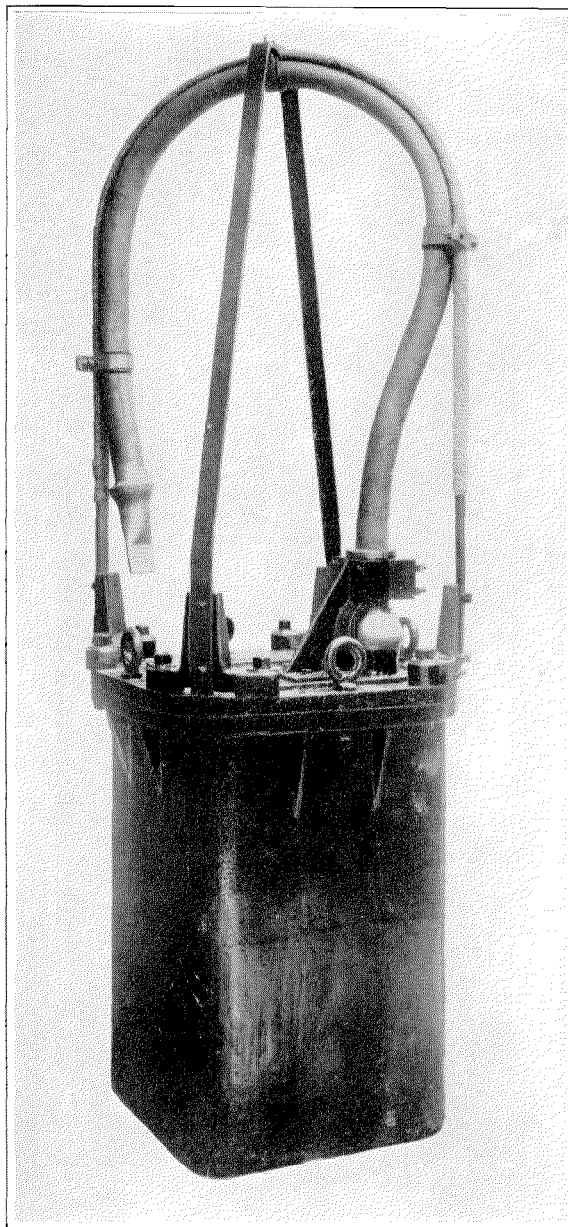

Figure 28—Stub Cable Type Loading Coil Case With Supports for Stub Cable During Shipment.

area may be desirable to counteract sinking or a shallow case may be required in order to avoid undue excavation in very hard ground.

Table VI gives details of the dimensions of the cases which have been standardised but for the reasons just stated every facility is maintained for the production of designs peculiar to special conditions.

The chief advantage of the stubless type of

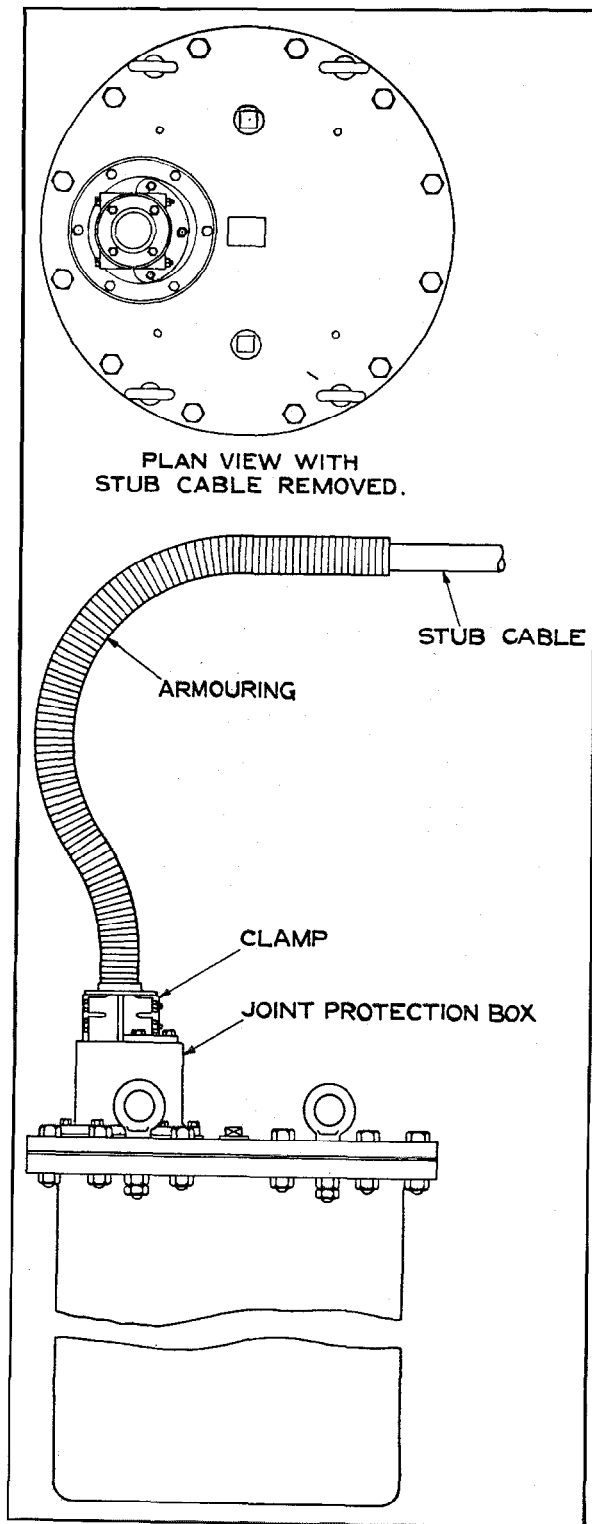

Figure 29—Method of Protecting a Stub Cable.

case is that it can be installed direct in the ground without any additional structure apart from the excavation required for its accommodation. The only limitation is that the case must be accurately located so that the jointing chamber is correctly aligned relative to the main cable.

The Installation of Loading Coils in Cable Splices

The size of the Stanelec long distance type of coil is such that it lends itself to the insertion of the coils in a cable splice, thus providing a means of installation which is very advantageous when only a few circuits are to be loaded.

There are two methods of installing the coils, one being to mount them on an insulating dowel rod and the other to box them in a metal canister. The first of these methods is shown in Figure 32 where four coils are mounted on the dowel rod which is then attached to ends of the main cable sheath and the structure sealed by means of a lead sleeve. With such a method of installation it is imperative that there should be no conducting material connected to the sheath and passing through the "eyes" of the coils, as this would form a closed loop with the lead sleeve and act similarly to a short circuiting winding around the coils. This method of installation is used for cables containing few conductors; approximately six coils can be accommodated without the joint becoming unwieldy.

The other method involving the use of a splice mounting canister is shown in Figures 33, 34, and 35, from which it will be seen that the coils are placed each in a separate compartment of a metal box which is filled with compound and sealed by soldered joints, connection to the coils being made by means of lead covered quads, the sheaths of which are lead sealed at the points where they enter the box. When in the splice the box is bound to the cable conductors which are protected by means of a textile wrapping. It is possible to encase up to five coils in each canister and two such canisters may be installed in one splice.

The cable splice canister method of installation is one which is applied when it is desired to load a few circuits in a large cable such as may occur when music or other special circuits have

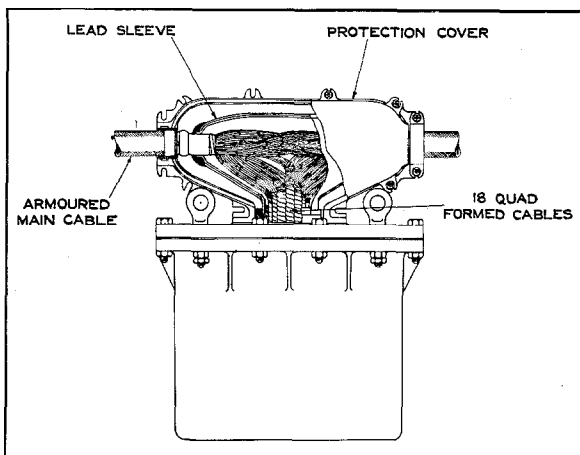

Figure 30—Method of Connecting a Stubless Case to the Main Cable.

to be loaded at points midway between the normal voice frequency loading points.

Both types of equipment will withstand the operations involved in making the joint although a certain amount of care is necessary to avoid undue heating when making the wiped joint between the lead sleeve and the cable sheath.

Loading Coil Installation in Exchange Buildings

It is occasionally necessary to install a number of loading coils inside an exchange or repeater station and under these circumstances the coils are treated exactly like repeating coils and installed in normal repeating coil cases which can

be mounted on the standard apparatus racks.

Conclusion

In preparing this paper one of the main ob-

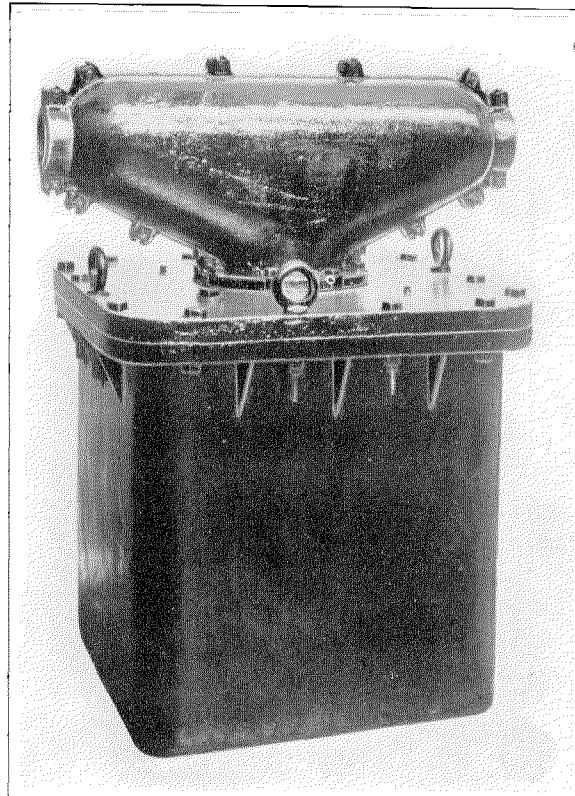

Figure 31—Stubless Loading Coil Case With Joint Protection Cover in Position.

TABLE VI

Code Number	Maximum Capacity of Case		Dimensions Millimetres						Approximate weight with coils Kilograms
	Units	Coils	Height to top of Cover	Height to Main Cable Centre	Total Height	Case Width	Case Length	Length of Protection Cover	
010-A	144	432	730	985	1145	755	755	880	1010
010-B	108	324	600	855	1015	755	755	880	860
010-C	72	216	475	695	850	755	755	745	710
010-D	36	108	345	565	720	755	755	745	540
011-A	72	216	730	950	1105	450	755	745	710
011-B	54	162	600	820	975	450	755	745	635
011-C	36	108	475	695	850	450	755	745	540
011-D	18	54	345	565	720	450	755	745	465
013-A	24	72	450	640	760	350	755	560	425
013-B	12	36	345	535	655	350	755	560	375

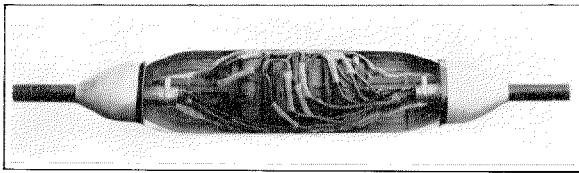

Figure 32—Dowel Method of Splice Installation.

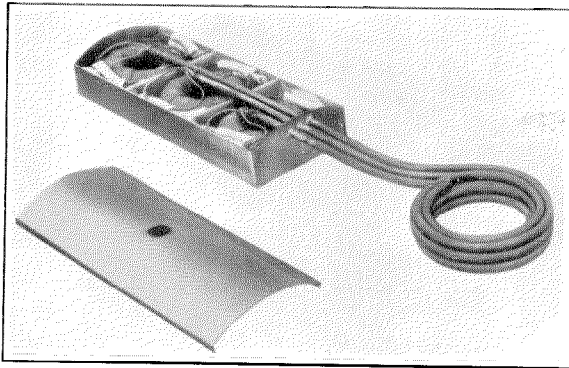

Figure 33—Cable Splice Canister—Open.

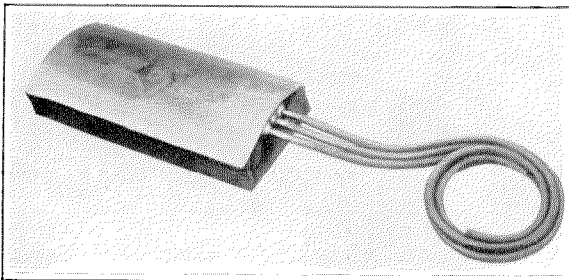

Figure 34—Cable Splice Canister—Sealed.

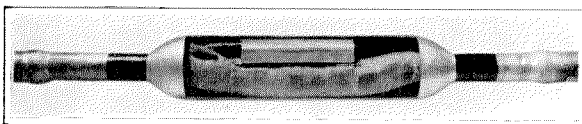

Figure 35—Cable Splice Canister—Installed.

jectives has been an attempt to counteract the divergence of viewpoint which has resulted from regarding the apparatus as a separate unit rather than as a part of the complete system. This divergence has been taking place gradually over a period of many years and has given rise to false evaluations.

It seems quite evident that past designs have merged successfully into a definite evolutionary line of progress which at each stage has provided a product adequate for its particular period.

Bibliography

T. Shaw and W. Fondiller, "Development and Application of Loading for Telephone Circuits," *Electrical Communication*, Vol. IV, No. 4, and Vol. V, No. 1.

W. Fondiller, "Commercial Loading of Telephone Cable," *Electrical Communication*, Vol. IV, No. 1.

H. Jordan, "Ferromagnetic Constants for Weak A. C. Fields," *Elektrische Nachrichten Technik*, Vol. I, No. 7.

W. Ehlers, "Loading Coils with Iron Dust Cores," *Elektrische Nachrichten Technik*, Vol. II, No. 5.

B. Speed and G. W. Elmen, "Magnetic Properties of Compressed Powdered Iron," *Proceedings A. I. E. E.*, June, 1924.

W. J. Shackleton and I. G. Barber, "Compressed Powdered Permalloy," *Proceedings A. I. E. E.*, April, 1928.

H. D. Arnold and G. W. Elmen, "Permalloy," *Journal of the Franklin Institute*, Vol. 195, No. 5.

G. W. Elmen, "Magnetic Alloys of Iron, Nickel and Cobalt," *Bell System Technical Journal*, Vol. VIII, No. 3.

W. Fondiller, "Developments in Communication Materials," *Bell System Technical Journal*, Vol. IX, No. 2.

W. Deutschmann, "Optimum Dimensions for Loading Coil Cores," *Telegraphen und Fernsprech Technik*, June, 1931.

W. Deutschmann, "Flutter Effect in Loading Coils," *Wissenschaftliche Veröffentlichungen aus dem Siemens-Konzern*, Vol. VIII, 1929.

Hongkong-Canton Toll Telephone Cable

By P. T. CAREY
China Electric Company

and R. E. BURNETT
International Standard Electric Corporation

A NEW era of rapid communication in China was inaugurated on September 1, 1931, when long distance telephone communication between Hongkong and Canton was officially opened by His Excellency Sir William Peel, K.B.E., K.C.M.G., Governor of Hongkong, calling His Excellency Lam Wan Koy, Chairman of the Kwangtung Provincial Government in the presence of a distinguished gathering of officials and business representatives of the Communities of Hongkong and Canton. Sir William proceeded:

"I am very glad to have this opportunity of speaking direct to you on the occasion of the inauguration of the long distance telephone from Hongkong to Canton. On behalf of those present here, who include members of Council and the Directors of the Telephone Company, I send

hearty greetings to you all. I am sure that you will join me in congratulating the Directors on having carried out this work so expeditiously, and on having provided yet one more bond of union between this Colony and Canton. We all wish the undertaking every success."

His Excellency Lam Wan Koy, replying to Sir William Peel, said:

"It gives me great pleasure to speak with you through direct means of communication which is now made possible by the inauguration of the long distance telephone. This new service not only marks a long stride in the improvement of commercial facilities, but above all will serve happily to strengthen the tie of friendship between Canton and Hongkong. Indeed it is most befitting for both of us to extend our best wishes for the success and prosperity of this new under-



Scene in Hongkong at Opening Ceremony of the Hongkong-Canton Toll Cable.



His Excellency Sir William Peel, K. B. E., K. C. M. G., Governor of Hongkong. (Photograph by Kobza, Hongkong).

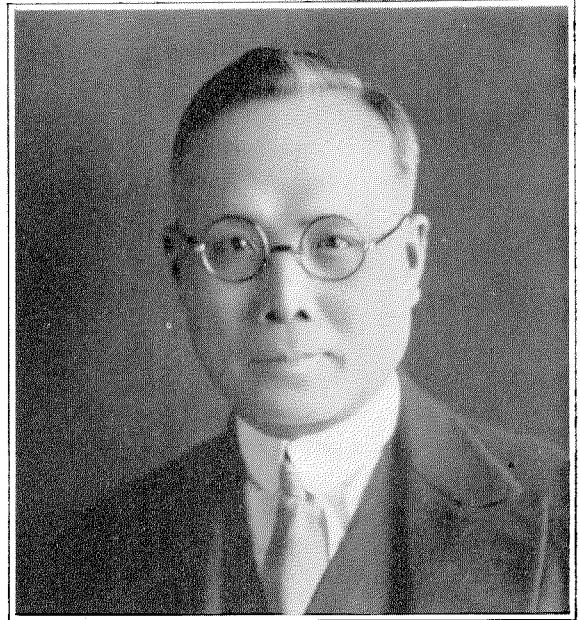

His Excellency Lam Wan Koy, Chairman of the Kwangtung-Provincial Government.

taking. May I also take this opportunity on behalf of those present here to send you and other friends in Hongkong our sincere greetings."

After the exchange of greetings, another important feature of the inauguration ceremony was the sending and receiving of photographs (Figure 1) and Chinese documents by means of picture transmission apparatus. The presence of Mr. M. Kobayashi of the Nippon Electric Company, one of the inventors of the system used, added interest to the occasion. The operation of Creed teleprinters, whereby messages were typed in Hongkong and simultaneously transmitted to and received in Canton, was also demonstrated.

The city of Canton is situated on the banks of the Pearl River about 100 miles from its mouth and is the largest and most important trading centre in Southern China. Capital of the province of Kwangtung, it is destined by its position to dominate the trade of the surrounding country, and under the leadership of its progressive and enlightened government exerts a tremendous influence both politically and economically throughout South China.

The Crown Colony of Hongkong is an island, with an area of 32 square miles, ceded to Great

Britain by China in 1841, in addition to the peninsula of Kowloon on the mainland making a total area of 390 square miles, with an estimated population of 900,000. The Colony is an important British Station of great strategic value, and is one of the greatest transshipment ports in the world.

Since Hongkong is situated at the mouth of the Pearl River, it may be called the gateway of South China. Through it, practically all trade to and from Canton passes so that the necessity of close co-operation between the two ports is evident.

Canton and Hongkong are connected by a railway, while several lines of river steamers provide an alternative route. Until recently, however, the only other form of communication was the telegraph.

It had long been felt that it was highly desirable to provide direct telephone communication between the two cities and this was made feasible when the China Electric Company to the order of the Canton Municipality installed an up-to-date automatic telephone system in that city. After prolonged negotiations between the Canton Municipality and the Hongkong Telephone Company, an agreement was reached

on September 2, 1930, jointly to order an up-to-date long distance telephone cable connecting the two cities.

General Description

The cable consists of 10 quads of 1.6 mm. wire, and was designed to have the low capacity of 0.0483 microfarads per mile, giving a loss of 0.1062 decibels per mile. Figure 2 shows the cross section of the cable. Its design is such that it was possible to avoid providing a repeater station halfway and thus obviate the objection of maintenance difficulties in the absence of a town located in a suitable position for a repeater station. All circuits are loaded; the side circuits with 253 millihenrys and the phantom circuits with 105 millihenrys on an average spacing of

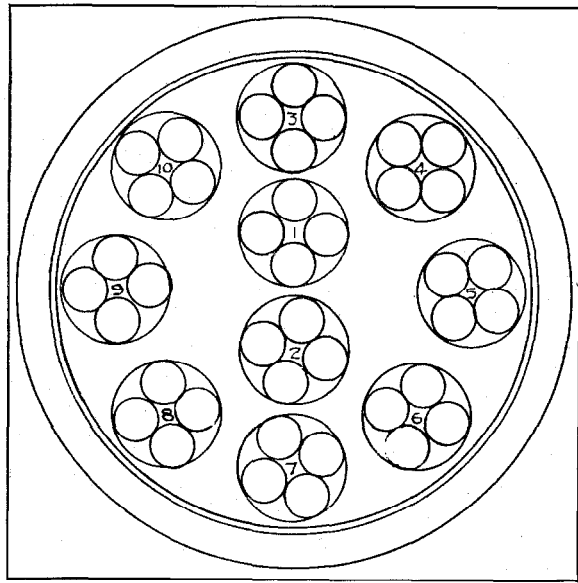

Figure 2—Cross Section of Hongkong-Canton Toll Cable.



Figure 1—Mrs. P. T. Carey. Transmitted Over the Hongkong-Canton Telephone Cable from Canton to Hongkong.

2,182 yards. The cable and loading coils were manufactured by Standard Telephones and Cables, Limited, London.

For the major part of its total length of 116 miles the cable lies along the right of way of the Canton Kowloon Railway. From the Exchange building in Canton, the route runs through the city streets for about three miles until it joins the railway on the outskirts of the city. This portion of the cable is laid directly in the footways at a depth of 2 feet, the cable being steel tape armoured (Figures 3 and 4). Bricks are laid over the cable as a warning to subsequent excavators. After joining the railway the cable follows it closely as far as a point about four miles south of the British frontier, where it leaves the railway owing to the difficult nature of the country, and follows the highway for a distance of about 12 miles. It then rejoins the railway which it follows until the outskirts of Kowloon are reached, where it enters the duct system of the Hongkong Telephone Company. A diversion is made into the Kowloon exchange of the Telephone Company whence it goes in duct to the harbour's edge. The harbour is crossed by a submarine cable (Figure 5) and then by duct line to the main Hongkong Telephone Exchange.

With the exception of the short sections in the Hongkong Telephone Company's duct, the

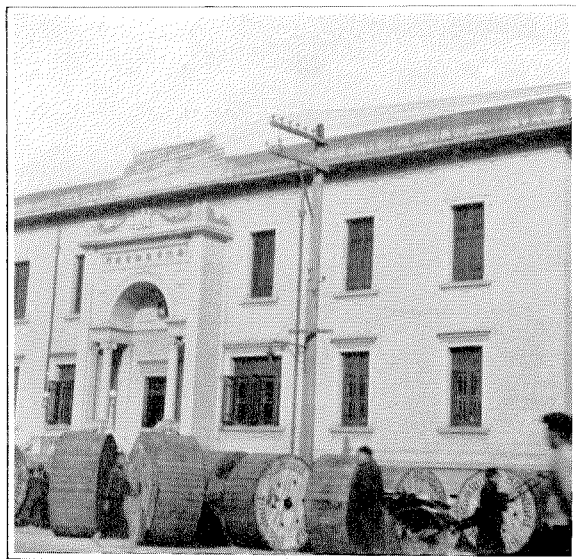

Figure 3—Canton Telephone Exchange Showing Toll Cable Drums.

cable is armoured and buried directly in the ground. In Chinese territory it was considered inadvisable to cross rivers or streams by means of the railway bridges owing to the possibility of their being demolished in times of unrest, and all rivers and streams of any size therefore were crossed by means of special water cable. The cable in these sections is provided with a steel wire armouring, the remainder of the cable being armoured with double steel tape. The depth of trench throughout is two feet except in certain sections of the highway where extensive rock was encountered. Here the depth of the trench was reduced to twelve inches and a protective layer of concrete six inches thick was placed over the cable.

Owing to the varied nature of the country, the survey had to be carried out with great care. Figure 6 shows a section of the route. For the first 50 miles from Canton the route runs through flat low-lying country which forms part of the basin of the East River. This district is subjected to heavy floods during the summer and the many streams which intersect it may become torrential in volume after heavy rain. As the cable was laid under the bed of these streams, considerable care had to be taken to ensure that no damage would occur in times of flood. At all the larger rivers the cable is not only anchored

in the river bed by means of heavy weights, but also on each bank by means of cross beams clamped to the armour and buried in concrete. Throughout this portion the cable route runs at the foot of the railway embankment. The latter section of the route in Chinese territory runs through hilly country, which considerably increased the difficulties of cable placing. In some places considerable deviations from the railway had to be made as the ground in its immediate vicinity was too steep and rocky to provide a suitable site for the cable trench.

In the British Section the cable route had to be very carefully chosen on account of storm damage to which this section is subject.

The terminating arrangements at each end are of the simplest. There being no repeaters at either end, the cable is terminated by a sealed cable terminal which provides a U link disconnecting point between the cable and the office wiring. From the cable terminal the circuits are wired to the repeating coils and thence direct to the toll board. The toll boards at each end are of similar design, that at Canton being manufactured by the Bell Telephone Manufacturing Company, Antwerp, and employing specially

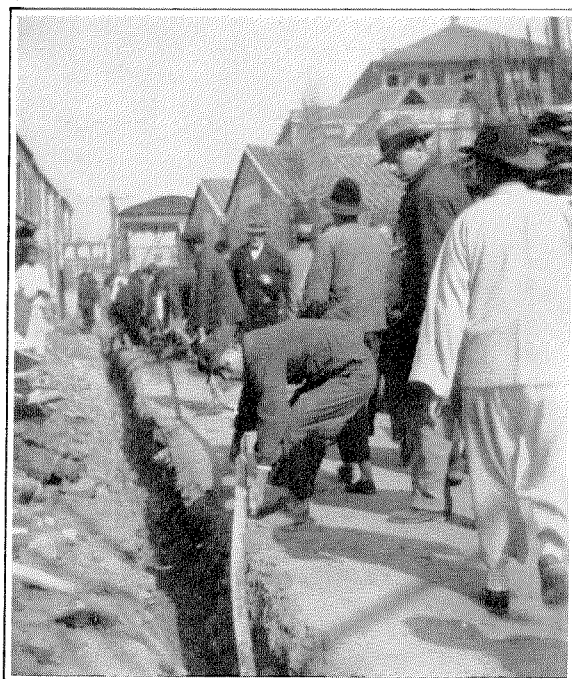

Figure 4—Placing the Cable in Canton.

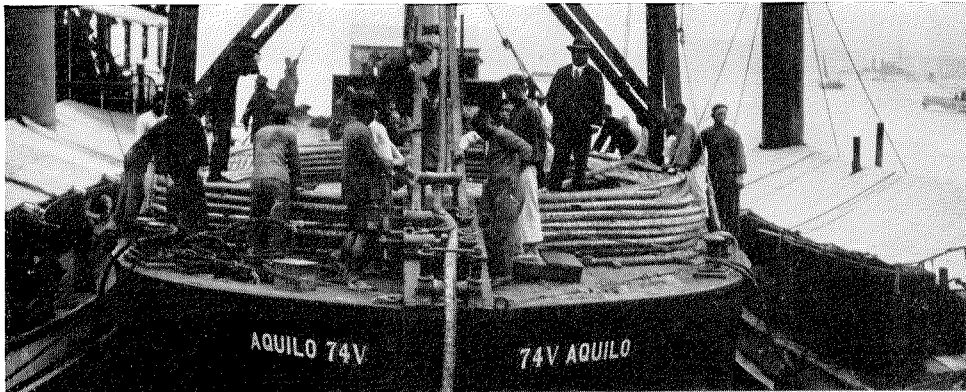

Figure 5—Submarine Cable on Lighter Ready to Start.

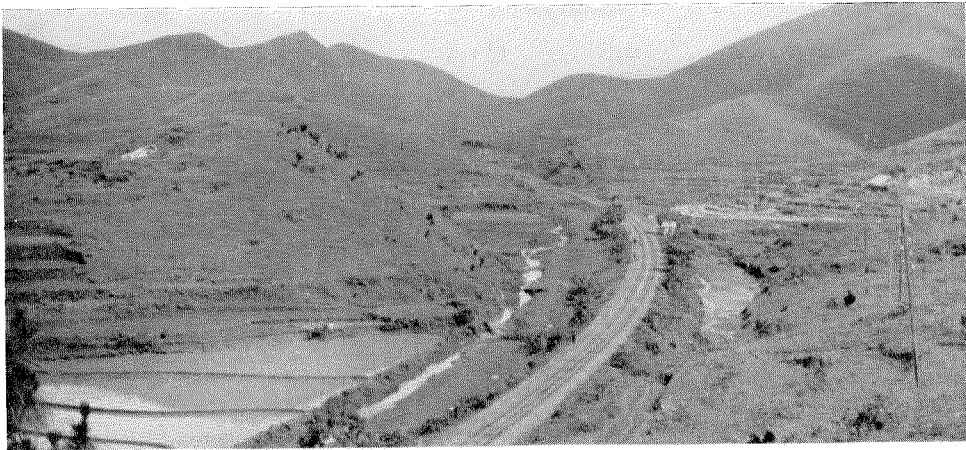

Figure 6—Typical Section of Cable Route Along the Railway in Chinese Territory.



Figure 7—Cable Train.



Figure 8—Distributing Drums Along Road in British Territory.

designed circuits to give a "no delay" service and to permit of connections being established with the automatic subscribers over the regular switches.

Submarine Cable

The submarine section across Hongkong harbour from Hongkong to Kowloon is of similar type to the normal land cables but is protected by brass tape and heavy steel wire armour. It was manufactured in one length of 2,200 yards and was balanced in the factory. The cable was laid as soon as possible after arrival. The laying of this section was carried out by the Hongkong Telephone Company. The length of the submarine cable as laid is 1975-1/3 yards.

Installation

In the railway sections the cable was laid direct from the railway, a series of flat cars having been fitted with trestles to take a maximum of 10 drums. Along the roadway both in Canton and in the British section, the cable had to be handled by means of rollers propelled by man power, since the roads were not sufficiently strong to take the combined weight of a cable drum and cable laying truck. About three miles from Kowloon the cable passes through a

railway tunnel about 1½ miles long and is supported on reinforced concrete bearers built into the tunnel wall. A loading point which occurs in the tunnel was formed by building a small recess in the wall of the tunnel just large enough to contain the loading coil case (Figures 7, 8 and 9).

The joints are buried in the ground and protected by cast iron protection boxes. The load-points in general consist of small brick or concrete jointing chambers with a pit sunk in the floor which contains the loading coil case.

The installation was carried out with English testers supplied by Standard Telephones and Cables, Limited, and Chinese jointers. As the number of trained Chinese jointers available was not sufficient to secure the progress required it was necessary to train some additional men who were given a short intensive course in a school, their training having been completed in the field under close supervision.

The greatest difficulty which had to be contended with was the absence of any rapid means

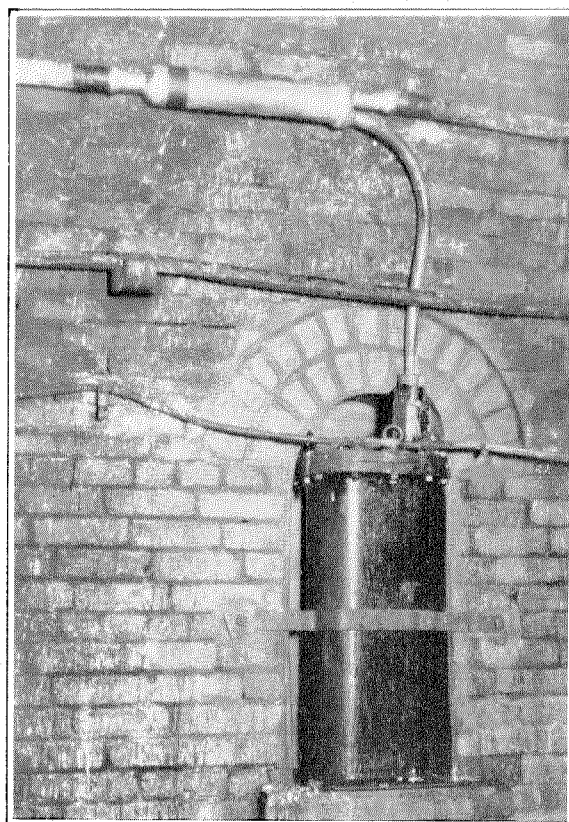

Figure 9—Loading Point in Tunnel.

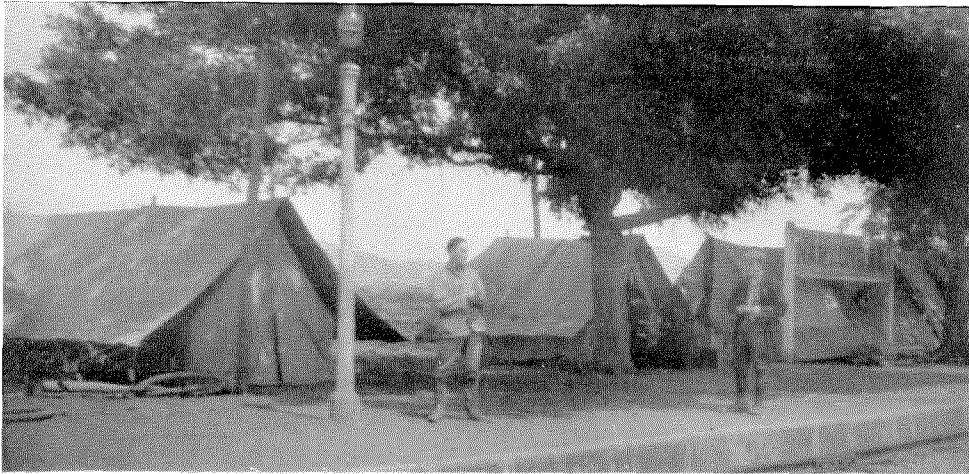

Figure 10-a—Splicers' Camp at Nam Kong.

of transport. The railway line is far from any roads and for the majority of stations there are at the most only two trains each way per day. It therefore became necessary for the testers and the splicing gangs to camp along the railway as near to the job as possible. A local station was always selected for the sites of these camps. Transport of materials from camp to work site was effected by means of gangs of coolies and push trolleys. Each camp also had a "pump trolley" for the use of the testers. Since the

country was more or less infested with bandits, a detachment of national guards was detailed to each camp for protection (Figures 10-a and 10-b). Actually only one case of banditry occurred, one squad having been relieved of their cash.

The cable is balanced in accordance with the well-known cross splicing method. Test splices were made in each loading section for capacity unbalance reduction, and the phantom and side circuit capacity deviations were reduced at the



Figure 10-b—Cable-laying Train. First Night Out Just Before Starting Laying.

TABLE NO. I

Crosstalk Summary Hongkong-Canton Cable—116 Miles

1.6 mm. H. 253—105		Near End				Far End			
		Average		Maximum		Average		Maximum	
		C. T. Units	Népers	C. T. Units	Népers	C. T. Units	Népers	C. T. Units	Népers
Crosstalk between circuits in the same quads	Ph-S	243	8.4	400	7.9	128	8.9	160	8.7
	S-S	109	9.1	200	8.4	80	9.4	120	9.0
Crosstalk between circuits in different quads	Ph-Ph	103	9.2	200	8.4	68	9.5	135	8.9
	Ph-Ph	158	8.6	300	8.1	96	9.2	160	8.7
	Ph-Ph	120	9.0	400	7.9	83	9.4	160	8.7

centre splice of each loading section. The usual direct current tests were made for resistance and insulation. Each loading section was pressure tested with compressed air for 24 hours before loading was carried out.

As stated previously, the cable is fully loaded. At the loading splices circuit capacity matching was carried out so as to provide the maximum capacity regularity possible.

The first length of cable was placed on January 17, 1931, and it was realized that rapid progress would have to be made in order to complete the section before the advent of the rainy season with consequent liability to flooding. It was estimated that to do this some 45

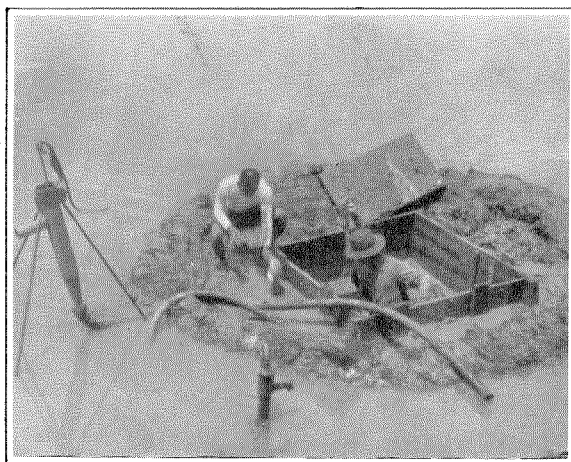

Figure 11—A Laying Point Protected by a Cofferd Dam From the Floods.

TABLE NO. II

Average attenuation constants Hongkong Canton Cable (Measurements at 800 c.p.s. and +15° C.)

Type of Circuit	db/mile	Népers/mile
Side.....	0.0823	0.00946
Phantom.....	0.0774	0.00890

loading sections would have to be completed by the end of April. Unfortunately very heavy rains were experienced early in April with the result that sections of the route were under four feet to ten feet of water. It was necessary to leave this section out temporarily and return to it when the flood level had dropped. Even then the splices in this section were made under very bad conditions (Figure 11). In spite of these and other delays due to bad weather, the cable was

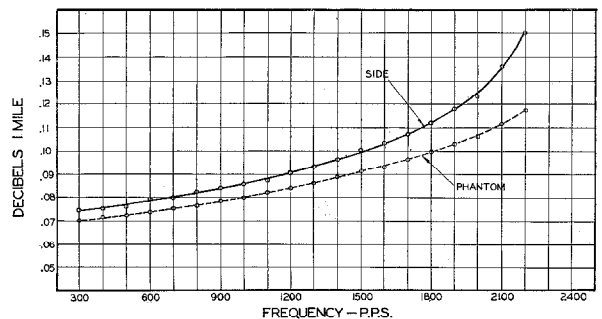

Figure 12—Hongkong-Canton Toll Cable. Attenuation Frequency Curve.

completed on time and successfully cut into service on September 1, 1931.

Measurements and Results

A series of measurements were made on the completed cable to ascertain that the cable and loading coils were satisfactory. These tests con-

sisted of measurements of insulation, crosstalk, attenuation, and impedance.

Crosstalk tests were made for near end crosstalk from each end of the cable and for far end crosstalk from one end only. Table I shows a summary of the results obtained.

Measurements of attenuation were made on

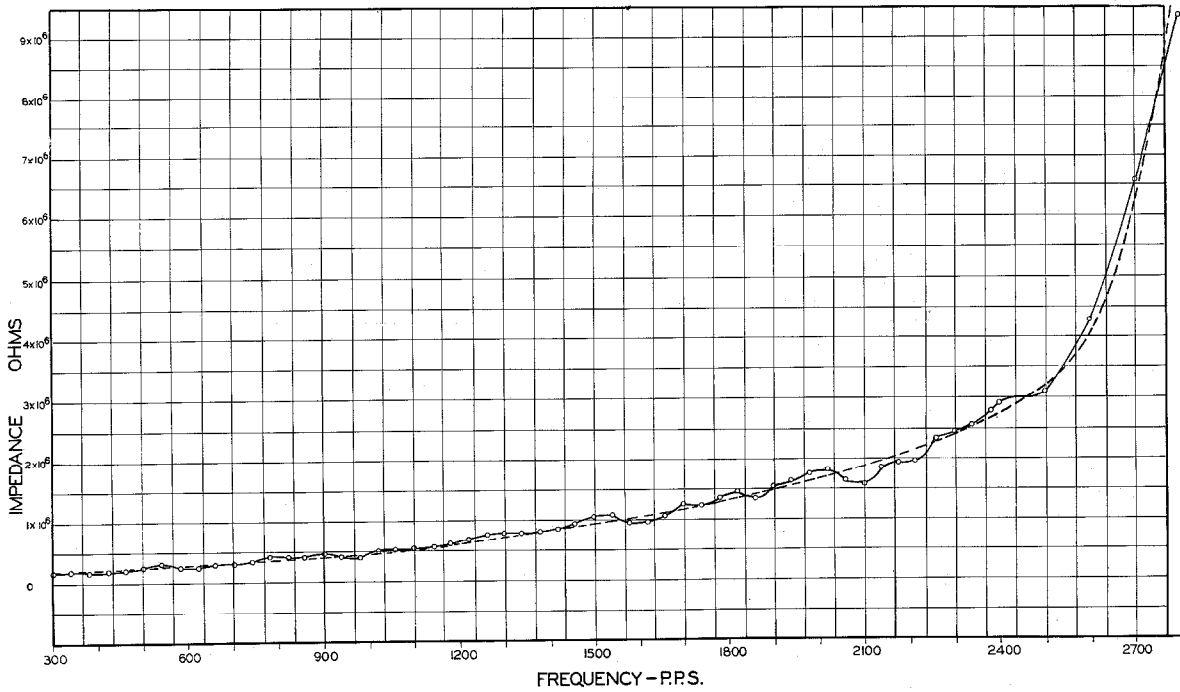

Figure 13—Hongkong-Canton Toll Cable. Impedance Frequency Curve, Side Circuit.

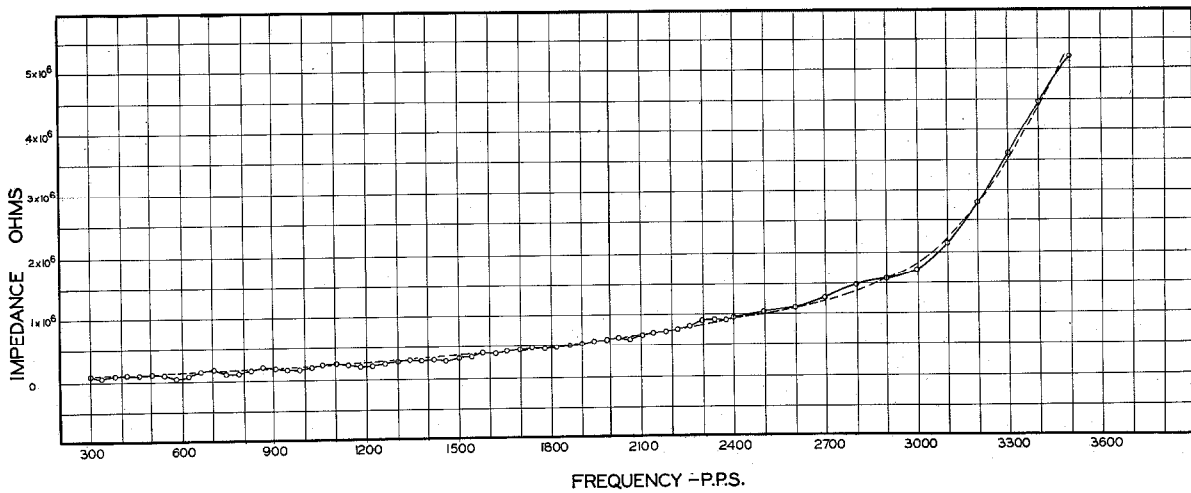

Figure 14—Hongkong-Canton Toll Cable. Impedance Frequency Curve, Phantom Circuit.

all circuits at 800 c.p.s. Table II gives a summary of the results.

Attenuation-frequency runs were made on representative circuits. A typical curve is given in Figure 12.

Impedance curves were taken on representative circuits. Typical examples are shown in Figures 13 and 14.

The above brief review gives the more important features of a cable which though in itself of small size, is destined to be of considerable importance in the telephone development of China by reason of its being the first long distance telephone cable to be installed in that country.

ERRATUM

Electrical Communication, Vol. X, No. 2, October, 1931.

Page 88, Table, column 2, "Outgoing to Tandem Circuits," substitute, left to right: 5, 74, 370, 76, 380.

The UNDERSEAS DIVISION of a Great Communication System



Two vast cable organizations form the underseas division of the International system . . . Commercial Cables and All America Cables.

Commercial Cables connect North America with the principal countries of Europe, Asia and The Orient through seven transatlantic cables and a transpacific system reaching the important Far Eastern commercial centers.

All America Cables connect the North American continent directly

with Central America, South America and the West Indies, through three cables and cable offices which it maintains in the principal cities of the Americas.

Working in perfect harmony with Postal Telegraph and Mackay Radio, these two great cable organizations help to establish the International System's achievement of coordinated world-wide record communications under a single management.

THE INTERNATIONAL SYSTEM

Commercial Cables All America Cables

Postal Telegraph



Mackay Radio

TELEGRAPH DISTORTION MEASURING SET (PORTABLE)

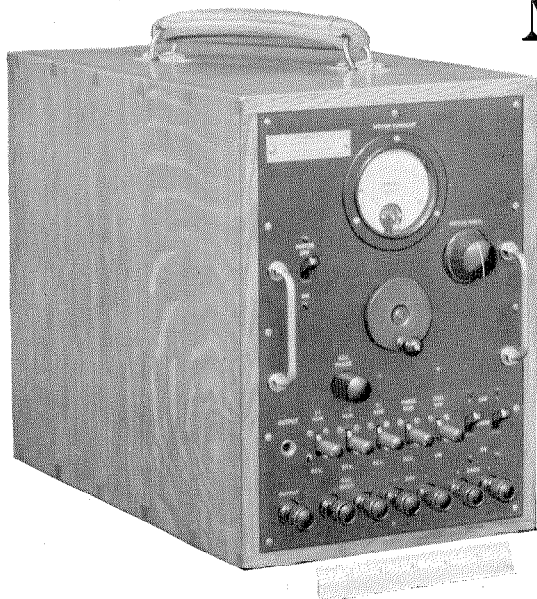

• *The Test Transmitter* produces distortion-free telegraph signals and provides a reference standard of measurements.

The Test Receiver, using a cathode ray oscillograph, produces light flashes on a scale marked directly in percentage distortion.

The operation of mechanical transmission systems is affected directly by the "time distortion" which causes signals to arrive too early or too late. It must be measured in order that faulty components can be corrected by a process of elimination.

Hence the STANDARD TELEGRAPH DISTORTION MEASURING SET.

It measures directly the difference in time between the earliest and the latest signals, indicating their arrival, with reference to perfect reception, on a clearly-readable scale.

Its use is indispensable to up-to-date telegraph operation in accordance with the highest modern standards.

• The Test Transmitter and the Test Receiver are each 16 in. by 9¼ in. by 13 in., the transmitter weighing 55 lb. and the receiver 35 lb.

Power for the transmitter may be drawn from the 240 or 160 volt telegraph battery and the regular 24 volt battery of the system. The receiver requires 240 or 160 volts supply in common with the transmitter, as well as a separate insulated 4-volt battery of from 20 to 40 ampere-hour capacity for the cathode ray.



Standard Telephones and Cables Limited

CONNAUGHT HOUSE, ALDWYCH, LONDON, W. C. 2

The Standard

ROTARY AUTOMATIC TELEPHONE SYSTEM

The rotary type of automatic telephone equipment is an original development of the International Standard Electric Corporation.

Approximately 1,300,000 lines are now in operation or on order in 26 countries.

More than eighty cities are now being served through Standard Rotary Automatic Telephone equipment. The following may be mentioned as the principal cities which have adopted this system:

Antwerp
Auckland
Barcelona
Basle
Bergen
Bologna
Brussels
Bucharest
Budapest

Cairo
Copenhagen
Dunedin
Durban
Geneva
Haarlem
Hull
Liege
Lima
Madrid

Mexico City
Oslo
Paris
Rio de Janeiro
Shanghai
The Hague
Vatican City
Wellington
Zurich

Rotary Automatic Telephone Systems are furnished by the International Standard Electric Corporation and Licensee Companies.

International Standard Electric Corporation

HEAD OFFICES

67 BROAD STREET, NEW YORK, N. Y., U. S. A.

EUROPEAN GENERAL OFFICES

Connaught House, Aldwych, London, W. C. 2, England

RADIO

DIRECTION FINDER

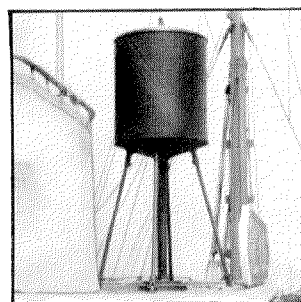

● The loop of the Kolster Radio Compass is mounted in a protective metal covering directly above the ship's navigating room.

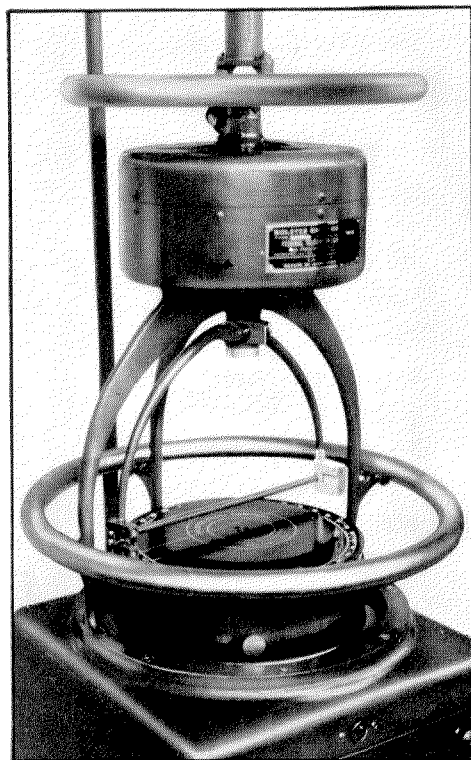

● The hand wheel which rotates the loop and sight wires above the compass card can be turned with the pressure of two fingers...in any weather.

The Radio Direction Finder today is one of the most important modern inventions for the protection of life and property at sea.

Radio Direction Finders may be relied upon to be accurate to within 1° of arc. Since they depend for their operation on radio bearings, their employment is completely independent of wind, weather, or visibility conditions. These advantages give them a unique position as compared with all other aids to navigation. In addition they have a greater range than any visible method of operation even in the finest weather and under the most favorable conditions of visibility.

The Kolster Radio Compass (Direction Finder) is manufactured and distributed by the Federal Telegraph Company, a subsidiary of the Mackay Radio and Telegraph Company which is the radio-telegraph division of the International Telephone and Telegraph System of world-wide telegraph communications.

The International Marine Radio Company, Limited, another associated company of the International Telephone and Telegraph Corporation, also has specialized in the supply of Radio Direction Finders. In developing its product it has co-operated with the designers of the Kolster Radio Compass and the Sperry Gyroscope Company.

International Marine Radio Company, Limited, London

Federal Telegraph Company, Newark, N. J.

Sales Agent for Mackay Radio and Telegraph Company

International Telephone and Telegraph Corporation, New York, N. Y.

INTERNATIONAL TELEPHONE AND TELEGRAPH CORPORATION

BOARD OF DIRECTORS

<p>FREDERIC W. ALLEN Lee, Higginson & Company</p> <p>ARTHUR M. ANDERSON J. P. Morgan & Co.</p> <p>HERNAND BEHN, President</p> <p>SOSTHENES BEHN, Chairman</p> <p>F. WILDER BELLAMY Dominick & Dominick</p> <p>EDWARD J. BERWIND Chairman, Berwind-White Coal Mining Company</p> <p>JOHN W. CUTLER Edward B. Smith & Co.</p> <p>R. FULTON CUTTING Financier</p> <p>GEORGE H. GARDINER Davis Polk Wardwell Gardner & Reed</p> <p>CONDE DE GÜELL President, Compañía Trasatlántica Española, Barcelona</p> <p>ALLEN G. HOYT Vice-President, The National City Bank of New York</p>	<p>RUSSELL C. LEFFINGWELL J. P. Morgan & Co.</p> <p>CLARENCE H. MACKAY Chairman of the Board, Postal Telegraph and Cable Corporation</p> <p>JOHN L. MERRILL President, All America Cables, Incorporated</p> <p>CHARLES E. MITCHELL Chairman, The National City Bank of New York</p> <p>WALTER E. OGLIVIE President, Havana Terminal Railroad Company</p> <p>HENRY B. ORDE, Vice-President</p> <p>BRADLEY W. PALMER Chairman of the Executive Committee, United Fruit Co., Boston</p> <p>GEORGE E. PINGREE President, International Standard Electric Corporation</p> <p>WOLCOTT H. PITKIN Vice-President and General Attorney</p> <p>LANSING P. REED Davis Polk Wardwell Gardner & Reed</p> <p>MARQUÉS DE URQUIJO President, Banco Urquijo, Madrid</p>
---	--

GEORGE H. GARDINER
General Counsel

OFFICERS

<i>Chairman</i> SOSTHENES BEHN	<i>President</i> HERNAND BEHN	
<i>Vice-Presidents</i>		
HENRY B. ORDE	PHILIP K. CONDUCT	WILLIAM F. REPP
LEWIS J. PROCTOR	JOHN L. MERRILL	FRANK GILL
GEORGE E. PINGREE	FRANK W. PHELAN	FRANK C. PAGE
<i>Vice-President and General Attorney</i> WOLCOTT H. PITKIN		<i>Vice-President and General Technical Director</i> JAMES L. McQUARRIE
<i>Comptroller</i> EDWIN F. CHINLUND	<i>Secretary</i> S. G. ORDWAY	<i>Treasurer</i> JAMES E. FULLAM

THE International Telephone and Telegraph Corporation was organized to cooperate and assist technically and financially in the general development of electrical communications in a broad international sense, and, with respect to the organization and development of national communications systems, it is the purpose of the International Telephone and Telegraph Corporation to develop truly national systems operated by the nationals of each country in which the International Corporation is or may become interested. The International Corporation was not organized with a single profit-making purpose to itself nor with the desire of imposing American practices in its foreign activities. There appeared to be a fruitful field of service to be ren-

dered in bringing together under one general organization electrical communications systems, and the extension by the International Corporation to the Associated Companies of the technical and financial facilities and direction that might be needed for their intensive and efficient development. The best American practices have been suggested but never imposed. On the contrary, the International Corporation has always been ready and quick to adjust American practices to local conditions and to adopt such local practices as were conducive to the successful development of the various entities. The combined and co-ordinated effort of the Associated Companies of the International System is today justifying the plans and purposes of the Corporation.

Licensee Companies

BELL TELEPHONE MANUFACTURING COMPANY.....	<i>Antwerp, Belgium</i>
<i>Branches: Berne, The Hague, Brussels.</i>	
STANDARD ELECTRIC DOMS A SPOLECNOST	<i>Prague, Czechoslovakia</i>
CHINA ELECTRIC COMPANY, LIMITED.....	<i>Shanghai, China</i>
<i>Branches: Canton, Hankow, Harbin, Mukden, Peiping, and Tientsin, China.</i>	
COMPAÑÍA STANDARD ELECTRIC ARGENTINA.....	<i>Buenos Aires, Argentina</i>
INTERNATIONAL STANDARD ELECTRIC CORPORATION, <i>Branch Office,</i>	<i>Rio de Janeiro, Brazil</i>
INTERNATIONAL STANDARD ELECTRIC CORPORATION OF MEXICO.....	<i>New York, N. Y.</i>
INTERNATIONAL TELEPHONE AND TELEGRAPH LABORATORIES, INCORPORATED	<i>Hendon, England</i>
LE MATÉRIEL TÉLÉPHONIQUE	<i>Paris, France</i>
NIPPON DENKI KABUSHIKI KAISHA	<i>Tokyo, Japan</i>
<i>Branches: Osaka, Dalny, Seoul, Taihoku.</i>	
FERDINAND SCHUCHHARDT, BERLINER FERNSPRECH-UND TELEGRAPHENWERK	
AKTIENGESELLSCHAFT.....	<i>Berlin, Germany</i>
STANDARD ELECTRIC AKTIESELSKAP.....	<i>Oslo, Norway</i>
AKTIESELSKABET SKANDINAVISKE KABEL- OG GUMMIFABRIKER.....	<i>Oslo, Norway</i>
STANDARD ELECTRIC AKTIESELSKAB.....	<i>Copenhagen, Denmark</i>
STANDARD ELECTRICA ROMANA S/A.....	<i>Bucharest, Rumania</i>
STANDARD ELÉCTRICA, S. A.....	<i>Madrid, Spain</i>
<i>Branches: Barcelona, Bilbao, Sevilla, Santander.</i>	
STANDARD ELETTRICA ITALIANA.....	<i>Milan, Italy</i>
<i>Branch: Rome.</i>	
STANDARD TELEPHONES AND CABLES, LIMITED.....	<i>London, England</i>
<i>Branches: Birmingham, Glasgow, Leeds, Manchester, Dublin, Cairo, Johannesburg, Calcutta, Singapore.</i>	
STANDARD TELEPHONES AND CABLES (AUSTRALASIA), LIMITED.....	<i>Sydney, Australia</i>
<i>Branches: Melbourne, Wellington.</i>	
STANDARD VILLAMOSSÁGI RÉSZVÉNY TÁRSASÁG.....	<i>Budapest, Hungary</i>
SUMITOMO ELECTRIC WIRE & CABLE WORKS, LIMITED.....	<i>Osaka, Japan</i>
VEREINIGTE TELEPHON-UND TELEGRAPHENFABRIKS AKTIENGESELLSCHAFT,	
CZEIJA, NISSL & CO.....	<i>Vienna, Austria</i>
<i>Branch: Tallinn.</i>	
STANDARD ELECTRIC COMPANY W POLSCE SP. z O. O.....	<i>Warsaw, Poland</i>

Sales Offices and Agencies Throughout the World
