

# ELECTRICAL COMMUNICATION

JANUARY

No. 3

1932

VOL. 10

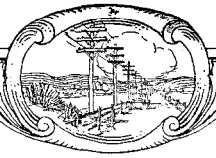

# ELECTRICAL COMMUNICATION

A Journal of Progress in the  
Telephone, Telegraph and Radio Art

H. T. KOHLHAAS, Editor

## EDITORIAL BOARD

J. L. McQuarrie    F. Gill    G. Deakin    P. E. Erikson    G. H. Nash    John W. Foard  
G. E. Pingree    P. K. Condict    E. A. Brofos    E. M. Clark    Frank C. Page

Published Quarterly by the

***International Standard Electric Corporation***

Head Offices

67 BROAD STREET, NEW YORK, N. Y., U. S. A.

European General Offices

CONNAUGHT HOUSE, ALDWYCH, LONDON, W. C. 2, ENGLAND

G. E. Pingree, President

S. G. Ordway, Secretary

James E. Fullam, Treasurer

Subscription \$3.00 per year; single copies 75 cents

Volume X

JANUARY, 1932

Number 3

## CONTENTS

	PAGE
ELECTRICAL COMMUNICATION IN 1931.....	101
THE PRAGUE HIGH-POWER BROADCASTING EQUIPMENT....	106
<i>By D. B. Mirk, B. Sc.</i>	
LINING UP BROADCASTING CIRCUITS.....	131
<i>By E. K. Sandeman</i>	
PNEUMATIC TICKET DISTRIBUTING SYSTEMS FOR TOLL BOARDS .....	134
<i>By Carl Beckman</i>	
A BRIEF BIOGRAPHY OF MR. KANKICHI YUKAWA.....	139
AN AUTOMATIC DEVICE FOR RECORDING, CORRECTING AND ANALYSING ARTICULATION RESULTS.....	140
<i>By John Collard, Ph. D.</i>	
MODERN LOADING EQUIPMENT.....	147
<i>By J. B. Kaye</i>	





INTERNATIONAL TELEPHONE BUILDING  
67 Broad Street, New York

# Electrical Communication in 1931

## *Radio Telephony*

**R**APID progress in extending international radio telephone services in 1930 was continued in 1931. New direct radio telephone services inaugurated include Argentina, Chile, and Uruguay on the one hand and Australia on the other, followed by extension of the Australian international service to the whole of that continent and to New Zealand. Chile was directly connected to Spain, and the Canary Islands and Mallorca Island were also linked to Spain and by existing land wire and radio systems to Europe and North and South America and Northern Africa. Radio telephone service was started between Colombia (South America) and Argentina, Chile, Uruguay, and all European points served by the *Compania Internacional de Radio* (Argentina); also between the United States and Bermuda and the Hawaiian Islands. In the latter case an inter-island radio telephone service was inaugurated.

So-called tandem circuits were established between North America and Java through intermediate stations at Amsterdam and Berlin and links were inaugurated between Java and Australia, Java and Sumatra, and Java and Siam.

Through utilisation of existing radio telephone circuits, many additional land line systems were connected with those of other countries during the year. Principal among them were the connection of the United Kingdom telephone network with Indo-China, Morocco, and New Zealand; North and South America with Rumania and Esthonia; Sweden with Indo-China, Siam, Java, and Australia; Finland with Java; Belgium with Siam; Germany with Indo-China; Latvia with Siam and Java; Czechoslovakia and Luxemburg with Siam and Indo-China; the Netherlands and Hungary with Indo-China; Austria with Indo-China and Siam; Switzerland with Morocco, Indo-China and Siam. Radio telephone connection was also established between Italy and Sardinia.

Through *Companhia Radio Internacional do Brasil*, an associated company of the International Telephone and Telegraph Corporation, the network of the Brazilian Telephone Com-

pany was connected with the networks in the United States, Canada, Mexico, Cuba, Argentina, Chile, Uruguay. Connection with Europe either will have taken place before this issue of *Electrical Communication* reaches the reader or will be effected shortly thereafter.

Stations under construction will provide for service between the United States and Japan. Arrangements are under way for telephone service between Great Britain and India, Africa, and Egypt.

On March 31, 1931, a demonstration of two way radio telephony, working on an 18 cm. wave length, was given between Dover, England, and Calais, France. Upward of 30 guests assembled on each side of the Channel and took part in conversations across the Straits of Dover. The system used, known as the *Micro Ray*, employs an antenna only 2 cms. in length. It has been found that waves of this length do not fade as do ordinary waves nor are they absorbed by rain or fog as are light waves. Other advantages of the system include the making available of nearly one-quarter of a million *Micro Ray* channels even if each transmitter were to differ in wave length to the same degree as is now necessary with ordinary transmitters.

During the years 1930-1931 the International Telephone and Telegraph Laboratories, Hendon, England, in conjunction with the Laboratories of *Le Materiel Telephonique*, Paris, France, carried out a series of tests on the single side band system of radio telephony applied to short wave lengths. The results show definitely that there has been evolved one system of single side band working applicable commercially to short wave links. A demonstration of this system was given on May 21, 1931, between Madrid and Trappes, near Paris. Over 70 guests listened for a period of approximately one hour to transmission of speech in English and French and of signals designed to show the degree of synchronisation between the suppressed carrier at Madrid and the re-supplied carrier at Trappes.

A spread side band system for use on short wave telephone links has been developed by means of which distortion effects due to selective



fading in particular can be reduced or eliminated. By an extension of the principles involved a number of side bands can be placed on one carrier in such relative positions to each other and to the carrier that "harmonic distortion" as well as crosstalk between the various communication channels is eliminated.

A tube having exceptionally small clearances between the electrodes, known as the Micro-mesh, was developed during the year. It has an extremely high gain and much better characteristics than tubes heretofore available.

In the field of mobile communications, existing telephone services available to ships at sea from most American and European telephone subscribers have been extended to the new Canadian Pacific Railway liner "Empress of Britain," and from American telephones to the Furness liner "Monarch of Bermuda." The S.S. "Belgenland" on its world tour made some striking records in transoceanic telephone contacts. The first was a nation-wide broadcast by Professor Einstein and others from New York Harbor. The next came from the Pacific Ocean off the coast of Central America. Other telephone connections established were from Chinese waters to the United States, Bombay to London, the Red Sea to the United States, and Alexandria, Egypt, to Washington.

### *Long Distance Telephony*

The European Toll Cable network is a vast framework of loaded cable and repeaters linking up practically all the important towns in Europe, running as far east as Warsaw and Budapest and extending further east by open wire line into the Baltic countries, Russia, Rumania, Yugoslavia, Bulgaria, etc. This great system has been an accomplished fact for some years, the long distance circuits being capable of extension to practically every corner of the countries throughout which it extends. As the national and international traffic over the circuits provided by the network increases from year to year, additional cables are laid, either paralleling existing cables or replacing outlying open wire sections or extensions. In some cases a cable network has been constructed in an outlying country temporarily linked to the main network by open wire lines, the open wire link to be replaced by cable as

soon as the traffic warrants. An important cable link of this nature was completed during 1931, which now extends the cable network to Warsaw. A similar cable link was inaugurated during 1931 in Italy where the network north and south of Rome has been connected to the North Italian network and thus to the main European network.

Some appreciation of the work involved in paralleling and extending the European network can be obtained from the fact that cable approaching 5,000 kms. in length and containing over one million kilometers of copper conductors, was added during 1931. Although this figure is lower than for 1930, the work done by the International Standard Electric Corporation's associated manufacturing and affiliated cable companies in providing cable, loading coils and repeaters was almost if not quite as great as for 1930. As an illustration, the loading coils supplied by associated factories in Europe may be mentioned. In 1930, the number of coils supplied was just under a quarter of a million, whilst for 1931 the figure had reached 215,000 early in November.

Outstanding events during the year include the completion of the London-Liverpool cable, where the early obsolete cable was withdrawn and replaced by a modern cable with a minimum of traffic dislocation; the inauguration of the Hongkong-Canton cable, when a demonstration of picture transmission and teleprinter operation, over the cable, was given and the above mentioned inauguration of the Italian State Cable completing the link with Rome, both to the north via the northern Italian system to Switzerland and to the east into Austria.

A special feature of the Long Distance Cable systems installed during 1931 is the inclusion in most cases of special circuits for the handling of broadcast transmission, these circuits being specially designed to meet these conditions and including very high grade repeaters capable of transmitting the necessary broad band of frequencies with negligible distortion of any kind.

An important development on the part of the International Telephone and Telegraph Laboratories, Hendon, England, in 1931, was a 4-wire voice frequency carrier telegraph system for use in telephone cable circuits operating on a band width of 120 cycles as against 170 cycles for the

earlier system. Through the contraction of the band width it has been possible to increase the number of channels from 12 to 18. The British Post Office plans to install this new equipment and other Administrations have expressed interest in it.

### *Repeater Equipment*

Considerable progress has been made towards reducing the space occupied by repeater equipment, a notable advance in this direction having been made by the International Telephone and Telegraph Laboratories' development of the new type small repeater equipment. In addition to improved performance, the space occupied is approximately half that required by previous types so that the capacity of a given floor area is practically doubled.

European Administrations are making very extensive use of repeaters over short lines rather than laying down heavy copper circuits. The developments of the International Telephone and Telegraph Laboratories have contributed in no small measure to these contracts by providing the so-called "junction repeaters."

### *Interference*

Rapid developments now taking place in power transmission lines and electrified railways, as well as in communication systems, are causing European and other Administrations to take increasing interest in the question of interference. To meet this growing demand a special department of the International Telephone and Telegraph Laboratories has been formed for the purpose of developing special technique for handling interference problems and for consultation both regarding the amount of interference to be expected under given conditions and the method of overcoming such difficulties.

### *Automatic Telephony*

New automatic exchanges were opened in many countries of the world including Mexico, Peru, Honduras, Argentina, England, France, Spain, Norway, Hungary, Switzerland, Czechoslovakia and Russia. In cities such as Istanbul, Cairo, and Shanghai where automatic installations were inaugurated, multi-lingual telephone

problems incident to a population speaking a number of languages were greatly alleviated. Many of the exchanges installed were of the rotary type built in factories forming the International Telephone group. Incidentally, during the year an accord was reached between the International Telephone and Telegraph Corporation and Telefonoaktiebolaget L. M. Ericsson of Sweden.

A new small automatic private branch exchange has been made available which permits free interconnection between the various local stations in business establishments and residences. Such connections are set up entirely automatically. In addition, any or all of the local stations may secure outside connections by appropriate dialing. Incoming calls are handled by an attendant who has facilities for transferring a call to any of the local stations.

### *Substation Equipment*

It has long been a problem to provide neat appearing telephone sets that will withstand the heat and moisture of the tropics. This problem has recently been solved by molding the entire outer casing of the telephone of phenol plastic, thus effectually removing for all time the possibility of finish troubles. A further improvement has been effected in substation equipment through the development of an anti-side tone circuit which permits the use of a more efficient transmitter and a lowering of the noise level resulting in the aggregate of a gain in overall efficiency and clarity.

### *Radio and Wire Telegraphy*

On December 1st there was placed in operation, in the International Telephone Building, 67 Broad Street, New York, one of the world's largest and most up-to-date cable and radio operating departments. It serves jointly the Commercial Cable Company, the Mackay Radio and Telegraph Company, and All America Cables. Circuits which link the United States with Europe, Central America, South America, and the Far East terminate therein, and connect 85,000 miles of undersea wires of International communications through 19 separate channels.

Greatly improved service and reduced operat-

ing costs in handling messages received in the main operating department from branch office printers has been obtained through the use of automatic printer concentrators. These concentrators serve as automatic switchboards which enable a branch office printer operator to obtain practically instantaneous connection with an idle printer in the main operating department. As a result of the speed with which connections are established, the efficiency of the main office operating staff is greatly increased.

Three of All America's cables to Central and South America, and two of the fastest New York-London cables of the Commercial Cable Company have been equipped with recently developed printer apparatus. These printers have greatly increased the accuracy of reception due to the elimination of human errors at the receiving stations and have effected substantial staff economies.

As a result of the development and application of rotary repeaters and special terminal apparatus, the speed of the fastest of the Commercial Cable Company's Atlantic cables was increased 30% and converted to two-channel operation.

Carrier current telegraph equipment, little used heretofore in purely telegraph plants, shows evidence of wider future application in this field of service. During the year the Postal Telegraph-Cable Company, for example, placed in service between New York and Washington a new 10-channel, 4-wire voice frequency system. Each of the ten channels carries a 2-channel multiplex circuit in each direction, thus adding 40 one-way telegraph circuits to the capacity of the lines on which the equipment is installed. The performance of the system has been so satisfactory that plans are being made for extending the use of this type of carrier operation.

The Postal Telegraph-Cable Company and the Western Union Telegraph Company announced on November 20th, the inauguration of Timed Wire Service which is available to every printer installed in the customers' offices of either Western Union or Postal Telegraph. As a result of this new service, the same instrument operated by the same operator who has been sending and receiving telegrams for the customer can be used also to send Timed Wire Service to any customer of either company who has a printer installed in

his office. The new service is charged for on a time rather than a word basis and messages are delivered over the lines of either of the telegraph companies to any addressee who has a teleprinter in any part of the United States. A directory of all telegraph printer customers of both companies has been published jointly by the two telegraph companies and shows the great scope and ramifications of this new service.

An automatic printer switching system has been developed with which it is proposed ultimately to place Timed Wire Service on an exchange basis similar to that of the automatic telephone exchange.

As a result of the general demand from European Administrations, the International Telephone and Telegraph Laboratories, Hendon, England, for the last several years has been working on systems which provide for special teleprinter exchanges or alternatively, switching at voice frequencies over ordinary subscriber's telephone lines. In line with this development the British Post Office have ordered from Creed & Company, Limited, 500 7-A teleprinters for the purpose of establishing, early in 1932, a printer switching service by means of the existing telephone exchange network to any telephone subscriber in Great Britain on payment of £65 per annum with the provision that a subscriber desiring this service must have a second telephone circuit in order that one will be available for telephone purposes while the teleprinter is in use.

In addition to the submarine cables terminating in the new cable operating department at 67 Broad Street, New York, the Mackay Radio and Telegraph Company has set up 24 radio positions providing direct contact with Europe, South America, the Far East, ships at sea and connecting the Atlantic with the Pacific by a direct transcontinental radio route.

New radio telegraph circuits from the United States to Cuba, Colombia, Austria, Czechoslovakia and China, were inaugurated in 1931, either by Mackay Radio and Telegraph Company or the R.C.A. Communications, Inc. Other important new circuits opened included Paris-Shanghai, Paris-Teheran, Berlin-Teheran, Buenos Aires-Brussels, Buenos Aires-Asuncion (Paraguay), Shanghai-Bangkok, Dairen-Osaka, and London-Nairobi (Kenya, East Africa).

The German Luft Hansa Company during the year offered to the air traveling public the first regular plane-to-station radio telegraph service.

In passing, it may be of interest to note that the automatic printer concentrator, the automatic printer exchange system, the cable printer, the rotary repeater and special terminal apparatus for increasing speed and providing 2-channel cable operation, and the carrier current telegraph equipment referred to above were all developed by the International Communications Laboratories, Inc., New York, a subsidiary of the International Telephone and Telegraph Corporation.

### *Broadcasting*

International and transoceanic radio broadcasts improved greatly in quality during the year and the increase in chain broadcasting by means of remote control radio circuits was notable. In addition to transatlantic nation-wide broadcasts over remote control circuits, similar broadcasts, for example, occurred from Buenos Aires, Rio de Janeiro, and the Hawaiian Islands. Outstanding individual broadcasts included the speech of the Prince of Wales from Buenos Aires during his visit to Argentina, and the United Press

broadcast from Tokyo to the United States. An interesting nation-wide program was broadcast from Havana where a submarine cable circuit of the Cuban American Telephone and Telegraph Company served as the connecting link between Cuba and the United States.

The Prague broadcasting station was completed in 1931. It is a 200 kw. station according to the latest C.C.I.R. rating and is the largest station now in operation in the world. It was supplied and installed by Standard Electric Doms a Spolecnost, Prague, in accordance with the designs of the International Telephone and Telegraph Laboratories, Inc.

During the year two installations were made of a new type of antenna for radio broadcasting. These antennae consist of a single fabricated tower with one set of guys at about the half way point. The whole tower rests on a single insulator and acts as a vertical antenna. The towers so far constructed have been designed to have a height about 0.6 of the operating wavelength. The intensity of the signal strength over a wide coverage is in the neighborhood of 40% greater than that of the standard type  $\frac{1}{4}$  wavelength antenna. Studies of the application of this type of antenna are being continued.

# The Prague High-Power Broadcasting Equipment

By D. B. MIRK, B.Sc.

*International Telephone and Telegraph Laboratories*

**T**HE Prague High Power Broadcasting Station lies some 35 kilometres east of Prague in the vicinity of the small town of Cesky-Brod. The surrounding country is practically flat with the exception of a few small hills three to four kilometres distant from the station.

The fundamental requirement governing the choice of site was of course the necessity of having a good field strength in Prague. Then, owing to the geographical shape of the country, it was desirable that the station should be east of Prague. Further requirements were a suitable power supply near the site and good transport facilities. A series of field strength measurements made by the engineers of the Czecho-Slovakian administration in collaboration with the engineers of the International Telephone and Telegraph Laboratories indicated that the Cesky-Brod site would give good crystal reception in Prague. Furthermore, this site had available a 15,000 volt, 3 phase, 50 cycle power supply actually passing over it, and good railroad transport was available. Figure 1 shows the site with the masts and the building erected.

The complete radio broadcasting equipment was supplied and installed by Standard Electric Doms a Spolecnost, Prague, to the designs of the International Telephone and Telegraph Laboratories, Inc. It is, according to the latest C.C.I.R. rating, a 200 kw. station and is probably the largest broadcaster now operating in Europe. The equipment is of the most modern design giving very high quality reproduction, with an overall power efficiency of the order of 22 per cent. It employs 40 kw. thermionic valves working on an anode tension of 20,000 volts, supplied from a mercury arc rectifier. The equipment is installed in a two-story building, and is laid out as shown in Figures 2 and 3, the radio transmitter being installed on the upper floor and the power equipment on the ground floor. The antenna is supported by two 150 metre insulated self-supporting masts spaced 250 metres apart.

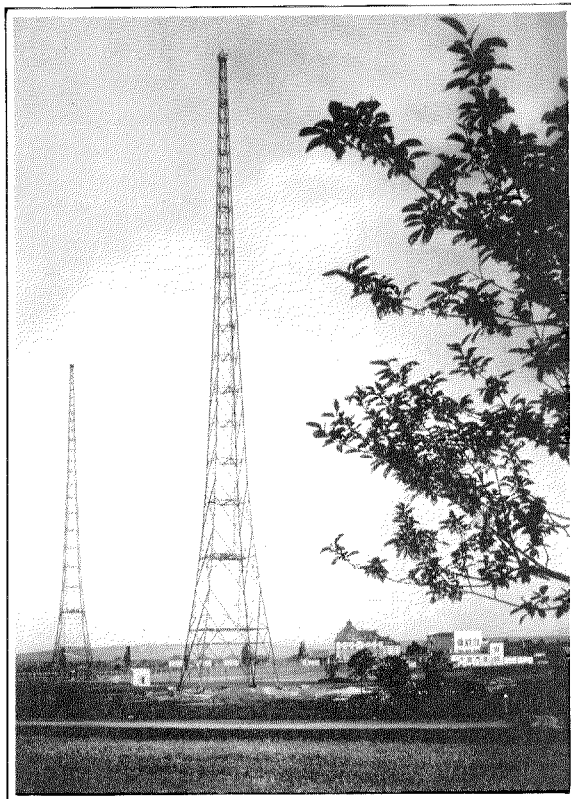

*Figure 1—Prague High-Power Broadcasting Radio Transmitter Site.*

Briefly, the requirements of a high power modern broadcasting equipment may be summarized under two headings: technical and economic. Technically, the system must give a programme of the highest quality. Economically, the running and maintenance costs must be low. The design of the broadcasting equipment for Prague has been influenced fundamentally by these two requirements.

The complete broadcasting system may be considered as comprising the speech input equipment (which is generally located in a studio at some distance from the radio transmitting equipment and is connected by telephone lines to the line amplifier equipment located at the radio transmitter), the radio transmitting equipment, and the antenna system.



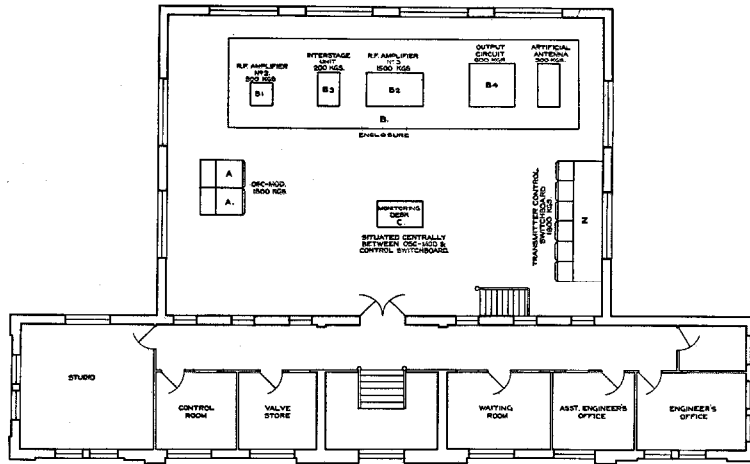

Figure 2—Layout of Building—Upper Floor.

All dimensions shown are in metres. Windows marked "a" to be fitted with bars.  
Doors marked "b" are locked by special safety keys.

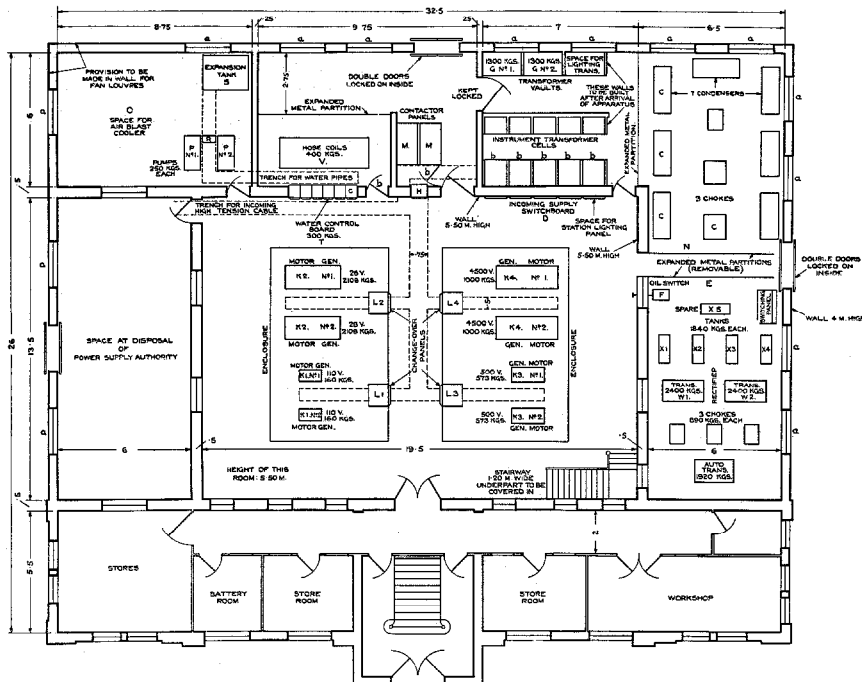

Figure 3—Layout of Building—Ground Floor.

### *The Speech Input and Line Amplifier Equipment*

The speech input equipment is designed to cater initially for two studios, with provision for extending up to ten studios by the addition of further studio equipment. It is designed to utilise two high quality condenser microphones and one carbon microphone in the first studio; and one condenser microphone and one carbon microphone in the second studio. It also provides the apparatus for a central announcer and controller with a possibility of adding a further small amount of apparatus to introduce echo effects. The controls provided give the possibility of "mixing" the outputs of the various microphones in the studio, in any desired proportion, and also of mixing the output of another studio or of the announcer microphone with the output of the studio microphones.

The signalling equipment enables the announcer in the control position to warn any of the studios that the microphone is to be switched on, and to switch on the warning lights inside and outside the studio from which the programme originates. Facilities are provided for taking a programme from a number of outside lines, and attenuation networks are fitted for obtaining the correct input level to the amplifier. The whole of the equipment, with the exception of the microphone batteries, is operated from the supply mains by means of dry metal rectifiers and smoothing circuits. For the microphone and the first microphone amplifiers, batteries charged by motor generator sets are employed.

In the control room the equipment is mounted on racks. One of these contains the microphone amplifiers and mixing panels. A second rack houses the main amplifier with the monitoring and gain control facilities. A third rack contains the radio receiver which is so installed that the quality of the transmission from the radio station may be checked up with the quality at the output of the microphone amplifier; it also contains power amplifiers for feeding a number of moving coil loud speakers installed at various waiting rooms and offices throughout the studio building. A further bay of racks carries the power supply equipment.

The total gain of the speech input equipment is 75 decibels. The frequency characteristic is

practically straight from 30 to 10,000 cycles. The equipment is capable of delivering an undistorted output of plus 16 decibels, into an output impedance of 500 ohms.

The radio transmitter is situated about 35 kilometres from the studio, and the connection between the two is made by underground cable. This arrangement causes considerable speech attenuation and in order to bring the speech back to a suitable level for modulating the radio transmitter, a line amplifier equipment is installed. This consists of a two-stage amplifier fitted with gain control and facilities for the use of a local microphone. An equaliser panel is supplied in order to equalise the line so as to have a characteristic as nearly flat as possible between 30 and 10,000 cycles. The amplifier is provided with a meter panel, a volume indicator, and a monitoring amplifier panel. The complete equipment is operated by rectifiers and from the mains, and includes all the switches and apparatus necessary for the use and control of this power plant. Included with the equipment is a moving coil loudspeaker and a carbon microphone. A microphone amplifier panel is also provided to bring the output of the microphone up to the same level as the output of the underground cable. A jack panel is provided so that the input of the line amplifier may be connected to any of a number of incoming lines. The whole of the apparatus is mounted on standard relay racks.

### *Description of Radio Transmitter*

As the advantages of 100 percent linear modulation are now well appreciated, they will not be enumerated here. It is sufficient to point out that modern broadcasting demands equipments capable of 100 percent modulation. Provided Heising or choke control modulation is used, it is well known that the technical difficulties in obtaining "straight line" or distortionless modulation are now practically limited by the power capacity of the valves in the last amplifier stage. With 100 percent modulation the peak power given by the valves is four times the normal carrier power. With modern technique the peak power capacity of the valves in the final stage of amplification, therefore, may be considered as the only factor limiting the power output of the radio transmitter.

The broadcaster is designed to be capable of 100 percent distortionless modulation when delivering 120 kilowatts of carrier power to the antenna, that is to say, the power which can be delivered by the valves in the final stage feeding the antenna is 480 kw. Within the limits imposed by the power supply equipment the carrier power can, of course, be raised at the expense of a reduction in the distortionless percentage modulation. Actually, the power supply equipment has been designed to be capable of giving a power of 150 kw. carrier with 80 percent distortionless modulation.

The radio transmitter has been designed to have a frequency characteristic such that the variation in transmission efficiency over the whole radio frequency range from 30 to 10,000 cycles does not exceed 3 decibels. Departures of this magnitude from a straight line characteristic cannot be detected by the ear.

For the purpose of this description the radio transmitter will be considered under three main sections: (1) The radio transmitting equipment, which comprises all of the apparatus associated with the generation of the radio carrier frequency, its modulation with the telephonic currents received from the line amplifier equipment, and the amplification of the resultant modulated wave to the required energy for delivery to the antenna system; (2) the power plant, which includes all the apparatus necessary for accepting a supply of commercial power from the incoming feeder, controlling this power and converting it into the special forms required to feed the radio transmitting equipment; (3) the water cooling system comprising the means for circulating the cooling water and dissipating the heat which it acquires from the valves.

#### THE RADIO TRANSMITTING EQUIPMENT

The system is one of modulation at low power with subsequent high frequency amplification. The carrier power is generated in a low power frequency controlled master oscillator, which provides the sole drive for a succession of non-regenerative amplifier stages. Modulation takes place at a slightly higher level than the master oscillator output. Special provision is made to prevent frequency modulation, with resulting distortion, as a result of any reaction on the master oscillator, through valve capacity or

otherwise, from the modulated amplifier or the radio frequency amplifiers.

The crystal controlled master oscillator drives a neutralised amplifier or first coupling stage. All the following amplifier stages are of the balanced push-pull type. The second coupling stage feeds the modulator amplifier, which is followed by three stages of radio frequency amplification. The use of balanced push-pull circuits throughout gives practically complete freedom from reaction, and thus avoids the possible distortion of the straight load characteristics of the amplifiers. It also enables the equipment to be adjusted and tuned very easily as each circuit is entirely independent from the point of view of tuning, and is consequently not affected by any changes made in the adjacent circuits. In order further to improve the stability, "anti-singing" resistances are provided in all plate and grid circuits. As is well known, the value of the grid filament impedance of a "3rd class amplifier" changes greatly, depending on the driving voltage applied. Consequently, it is necessary to "swamp" this varying impedance by another impedance of a value much lower than the minimum value of the grid filament impedance. This consists of a resistance which is connected across the filament grid circuit of the amplifier valves. Furthermore, to prevent the tendency to spurious oscillation, large values of capacity are connected directly across the grid and filament of each valve. Lastly, even in a perfectly balanced push-pull circuit trouble is often met, due to "parallel oscillations," i.e., oscillations which pass via the grid chokes through the two valves in parallel and return via the anode chokes to some point of a common high frequency potential. These oscillations are prevented by the incorporation of resistances in series with the grid and anode chokes and large by-pass condensers on each choke. By these means, therefore, an equipment has been produced which has no reaction, is absolutely stable and free from spurious oscillation, and whose carrier frequency is therefore determined solely by the frequency of the master oscillator.

As is well known, the anode current of a third class amplifier valve varies at audio frequency. Consequently it is necessary that the circuit supplying the anode current to these valves

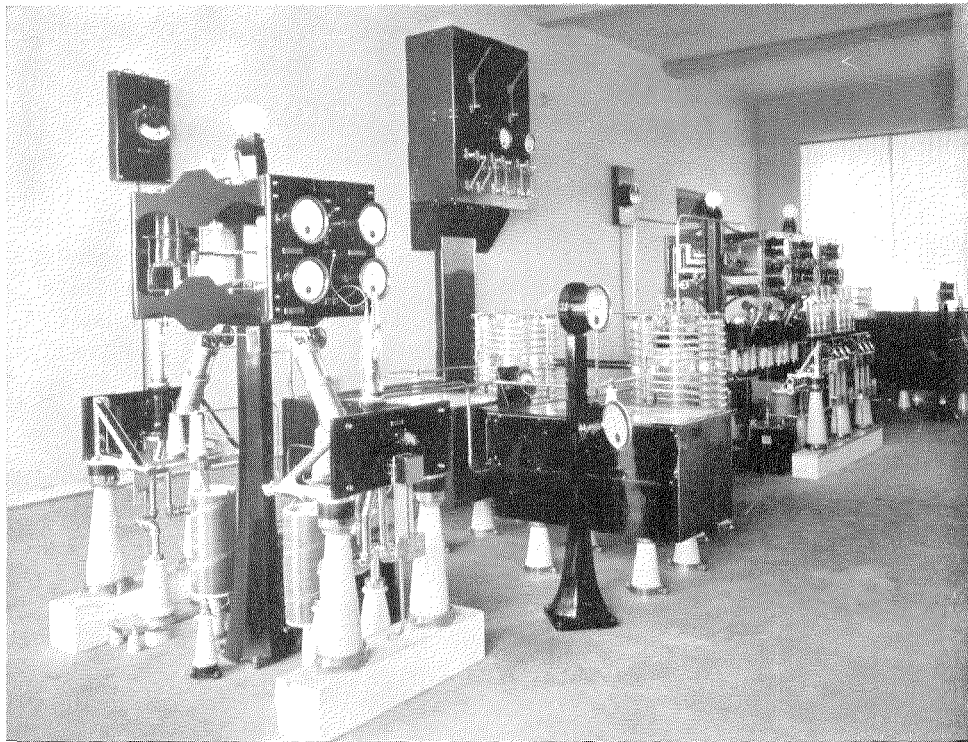

*Figure 4—Power Amplifier from the Front, Looking Right.*

should have a low impedance. All the anodes are therefore supplied through filter circuits which are terminated with a large value of smoothing capacity to prevent remodulation in the anode circuit at the lower frequencies, and consequent distortion.

Precautions have been taken to reduce carrier noise to the minimum possible value. The smoothing circuits of the plate and grid supplies have resonant frequencies well below the lowest modulation frequency, and very considerably lower than the lowest ripple frequencies delivered by the motor generator sets. The filament circuits are smoothed by audio frequency chokes and large banks of electrolytic condensers. Separate potentiometers are provided for the grid of each stage, and the output of each of these potentiometers passes through a separate smoothing circuit before going to the grid.

In order to obtain as nearly perfect reliability

as possible, very adequate factors of safety have been allowed on the electrical specifications of the individual components. Large clearances have been left for all components under tension, and sizes have been kept on the liberal side in order to avoid the cramping which so often occurs, especially in the low power circuits of broadcasters. Tuning of all the low power circuits is accomplished by means of variable condensers, and the tappings on the coils are made by soldered connections brought out to screwed terminals. The final amplifiers are tuned by means of a short-circuited turn rotating inside each coil. Throughout the equipment all contacts are made either by soldered or by screwed connections; no clip contacts are employed. By these means the possibility of trouble due to bad and intermittent connections is reduced to a minimum.

The design almost naturally divides itself into two main parts, namely, the oscillator-modulator

and the power amplifier. The power amplifier includes the radio frequency amplifiers Nos. 2 and 3, and the associated interstage and output circuits. The valves used in the power amplifier operate on a D.C. anode tension of 20,000 volts. It is exceedingly difficult to mount apparatus capable of withstanding this voltage in any form of enclosed framework. Attempts to do so generally result in mounting the apparatus as self supporting units with the framework serving as an enclosure only. The result is that very little is gained, and accessibility and simplicity of operation are invariably sacrificed. It may be thought that the appearance of the closed framework type of construction is better, since the apparatus is all enclosed and the surrounding framework can be well finished and fitted with front panels. However, it was considered that most of the apparatus for the power amplifier of such a large broadcaster would be of sensible dimensions, and consequently could be finished to present a pleasing appearance. It was realised that, from the point of view of manufacturing cost, this would undoubtedly result in a more expensive equipment. Nevertheless, the advantages from the point of view of simplicity of operation, accessibility and ease of maintenance,

are so marked that it was decided to adopt the "open-type" construction for the power amplifier enclosure. The arrangement of the apparatus is clearly seen in Figures 4 and 5 which show the power amplifier with the enclosing frame removed.

The oscillator-modulator contains all the audio and radio frequency circuits up to a power sufficient to drive the power amplifier. In other words it is a complete broadcaster in itself, with a carrier output of 250 watts, and capable of 100 percent distortionless modulation. The apparatus contained in the oscillator-modulator is naturally of small dimensions, and operates on comparatively low voltages. Since it is low power apparatus, which should be screened from the power amplifier, all this equipment was centralised and built into a unit and completely enclosed.

Figure 6 shows the oscillator-modulator unit. It contains all the apparatus associated with:

- (a) the generation of the radio frequency carrier wave at low power
- (b) the amplification of the audio frequency currents
- (c) the modulation of the radio frequency carrier wave by the audio frequency current—thus combining (a) and (b)
- (d) the amplification of the modulated energy from (c) to the requisite power level for application to the grids of the power amplifier

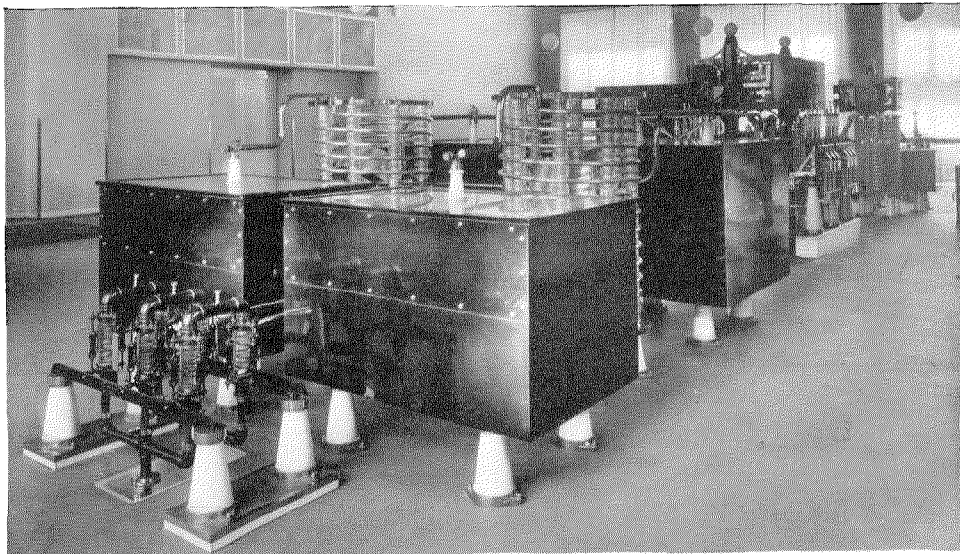

Figure 5—Power Amplifier from the Rear, Looking Left. The Artificial Antenna is on the Extreme Left.



The apparatus corresponding to each of these four divisions is built into a separate duralumin metal box (Figure 7) so as to be a self-contained unit, electrically screened from the other portions of the circuit. These boxes are referred to as:

- (a) the master oscillator and coupling stage box
- (b) the modulator and speech amplifier box
- (c) the modulated amplifier box
- (d) the first radio frequency amplifier box

As these boxes are located within the outer screening formed by the metallic enclosure of the unit, all of the apparatus, except the valves, is doubly shielded from the power amplifier stages. This complete screening, combined with the use of balanced push-pull circuits, ensures the complete suppression of undesirable regeneration or "feed-back." The boxes are mounted at the back of the slate panels forming the front of the unit; the meters and controls pass through holes in these panels. The valves are mounted outside on the back of the boxes, so as to be easily accessible for replacement. They can also be observed during operation through the perforated screens at the rear of the unit. Doors on the sides and rear of the boxes permit ready access to the apparatus inside.

Each of the boxes is mounted on slides and, in the event of any trouble, may be withdrawn bodily from the unit for inspection or replacement of any component. To withdraw a box, it is only necessary to undo the spring connections mounted on the side of the boxes and serving as conductors for the supply tensions. One marked advantage of this type of construction, is the circuit flexibility which results. If, at a later date, it is required to change or modify any particular circuit, it can be done without disturbing other circuits. For example, if it were desired to change the master oscillator and to employ one of a different type, or to derive the carrier frequency from a frequency transmitted from a distant point, then it would only be necessary to remove the box containing the present master oscillator, and to replace it with another box which would contain the new circuits. Similarly, changes can be made to any of the four boxes without interfering with the remainder of the equipment.

Apparatus associated with the filtering and adjustment of the grid anode and filament power

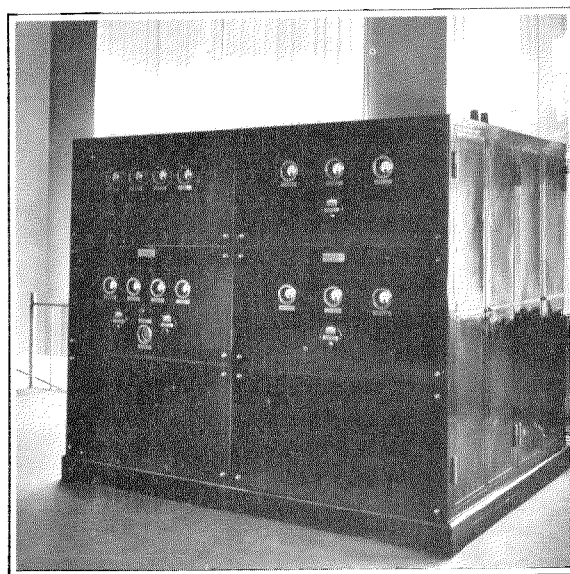

Figure 6—Oscillator-Modulator Unit.

supplied to the various valves is not included in the boxes, but is mounted on panels accommodated on two racks standing at the right and left of the free space, which is entered through doors at the back of the unit. These panels include separate grid bias filter panels for each stage, filament rheostat panels for all the valves, a filament filter panel (employing dry electrolytic condensers of 10,000 microfarads capacity), a separate filter panel, for each anode supply, and so on. The apparatus on each panel is enclosed by a separate can cover, and jacks are provided to permit reading of the grid and filament voltage on each valve on meters provided at the top of the rack. A radio frequency peak voltmeter panel is also mounted on one of these racks. This arrangement of mounting the low frequency power circuits on separate racks, and having a separate panel for each filter circuit has great advantages from a maintenance standpoint as compared with the practice of assembling all the low frequency filter circuits together with the radio circuits in a single unit. With the latter system it is often difficult for an operator, in case of a fault, to trace out any particular circuit. With this arrangement, however, each filter and associated potentiometer or voltage dropping resistance is concentrated on one panel, in an easily accessible position, and has just one pair of wires leading into it and a second pair

of wires leading away from it to the radio box concerned. It is therefore very easy, if trouble is suspected, to test the operation of the filter unit as a whole.

As it is obvious that the final characteristics of the equipment must in any case be inferior to the characteristics of the oscillator-modulator, this must be designed to possess the highest possible electrical performance. This performance may be conveniently examined from the point of view of circuit stability, frequency stability, linearity of modulation, frequency response curve and circuit flexibility.

As has been previously explained, in order to obtain perfect circuit stability, it was decided to adopt balanced push-pull circuits giving complete neutralization throughout the equipment. The whole equipment is screened, both between stages and from the power amplifier stages. By these means, an oscillator-modulator has been made which is absolutely stable and has no tendency towards spurious oscillation; the carrier frequency is therefore determined solely by the

resonant frequency of the quartz crystal. This crystal oscillator consists of a one watt valve coupled by a radio frequency choke to the first coupling stage, which consists of a neutralised 50 watt valve acting as an amplifier and working into a tuned circuit. This in turn drives an amplifier consisting of two 50 watt valves in push-pull, working into a resistance potentiometer the output of which drives the grids of the modulated amplifier valves. This avoids all possibility of reaction at audio frequency due to the variation in grid current of the modulated amplifiers during modulation.

The audio frequency input transformer has a Permalloy core with an almost flat characteristic between the frequencies of 30 and 10,000 cycles. To preserve the same frequency response curve through the modulator unit, two high quality speech amplifiers drive the valve which modulates the modulated amplifier, the system used being a modification of the "Heising" system. Each of the two speech amplifiers uses a 50 watt valve. The modulator valve is a 500 watt valve operating on 5,000 volts. The modulated amplifier uses two 50 watt valves in a balanced push-pull circuit. These valves work normally when unmodulated with an anode tension of 750 volts. In order, therefore, to obtain 100 percent linear modulation, it is necessary to vary this anode tension from zero voltage up to 1,500 volts at audio frequency. This audio frequency voltage variation is supplied by the modulator valve, which must therefore be capable of delivering a voltage swing of 1,500 volts into the load represented by the modulated amplifier without departing from the linear portion of its own characteristic. To meet these requirements a valve working on a plate tension of 5,000 volts is used for the modulator. As the output of the modulated amplifier is increased by 50 percent when it is modulated 100 percent, this increase of power can only be derived from the modulator valve. In this equipment the power taken by the modulated amplifier valves is approximately 80 watts; the power to be delivered by the modulator is therefore 40 watts. The actual valve employed is capable of delivering an undistorted audio frequency output of very considerably more than 40 watts. Therefore, from both the voltage and power considerations, the modulator

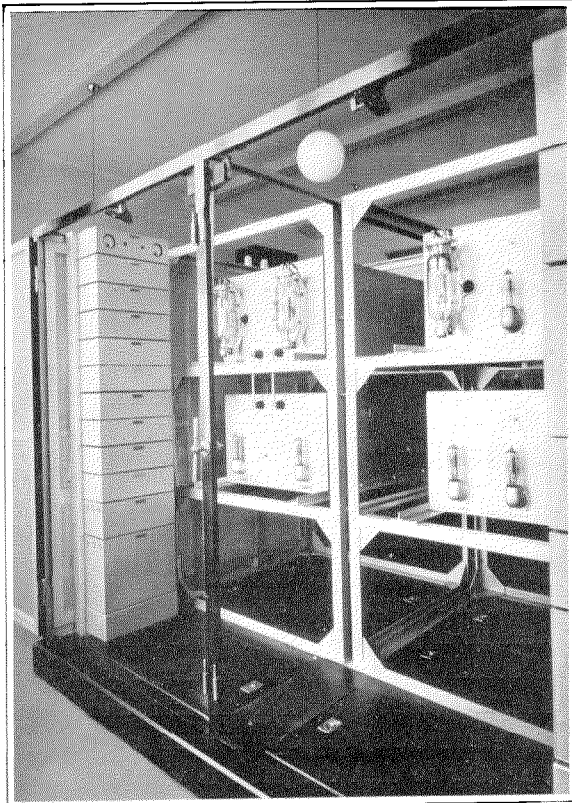

Figure 7—Oscillator-Modulator Unit—Rear View With Doors Open.

circuits are completely adequate to give the required 100 percent linear modulation.

When considered from the point of view of the load of the modulator valve, the output circuit of the modulated amplifier acts as a circuit in parallel with the effective impedance of the modulated amplifier valve itself. It is obvious, therefore, that as the output circuit is fed through a condenser, and itself consists of a capacity and inductance in parallel, the impedance of this shunt circuit will vary with frequency, and will decrease very much at high frequencies. This will affect the impedance into which the modulator valve is working, and will result in a loss at the higher frequencies. The anode stopping condenser is therefore replaced by a series resonant circuit consisting of a capacity and inductance in series, having a very small value of capacity, and tuned to the transmitting wavelength. This circuit has an almost zero impedance at the radio frequency, thus permitting the highest possible efficiency for the modulated amplifier. Owing to its small capacity it also presents a very high impedance to all audio frequencies, and thus permits the modulator valve to work into a constant impedance.

Radio frequency amplifier No. 1 consists of two 500 watt valves operated in a balanced push-pull circuit, and working on a D.C. anode potential of 5,000 volts. Every precaution has been taken to make this equipment as safe as possible for the operators, and naturally no components carrying tension are mounted on the front panels. The oscillator-modulator is surrounded completely by an enclosure; access to the interior is gained through a number of doors, each of which is fitted with electrical contacts which automatically remove all dangerous voltage when any door is opened. In order to provide against a possible failure of the automatic circuit it is necessary, before any door can be opened, to turn a handle fitted on the back of the equipment. Turning this handle removes the mechanical interlock from the doors, without which the doors cannot be opened, and at the same time operates a switch which first directly opens the supply circuits, and then puts a short-circuit on the condensers inside the unit. The operator is therefore prevented not only from touching any dangerous voltages but also from receiving a

shock from the discharges of a condenser.

The middle panel on the left of Figure 6 is the master-oscillator and coupling stage panel. The two control dials are for the master-oscillator and the amplifier. Above the master-oscillator is the modulator and speech amplifier panel. The middle panel on the right is the modulated amplifier. The top panel on the right is the first radio frequency amplifier.

The power amplifier is driven by the oscillator-modulator through a short transmission line, and its function is to amplify the output from the oscillator-modulator unit to the level required for delivery to the antenna system. It includes all the water-cooled valves and their associated apparatus. Two stages of power amplification are necessary to increase the level required for feeding the antenna. Fourteen water-cooled valves are used, each capable of delivering a peak power of 40 kw. at 20,000 volts. The stage I power amplifier (or radio frequency amplifier No. 2) has two valves arranged in a balanced push-pull circuit and the stage II power amplifier (or radio frequency amplifier No. 3) has twelve valves arranged in a balanced push-pull circuit. Stage II power amplifier receives its drive from stage I through the medium of the interstage circuit.

In radio frequency amplifier No. 2, each valve is provided with separate meters indicating the anode current and grid current, and there is an additional meter indicating the total anode current of the two valves. Each valve is, of course, provided with a separate high frequency choke and D.C. stopping condenser, and also with a separate overload relay which opens the circuit breaker should the anode current become excessive. These relays are fitted with counters which indicate the number of times the valve has operated the circuit breaker, so that the behaviour of each valve throughout its life can be recorded, and any valve tending to be unreliable in service can be eliminated. A filament voltmeter is provided to show the filament voltage actually delivered to the filament of each valve. The meters, filament rheostats and similar apparatus are assembled on a small panel carried on a pillar so that the panel is visible over the top of the enclosure. To indicate the radio frequency drive applied to the grids of the amplifier

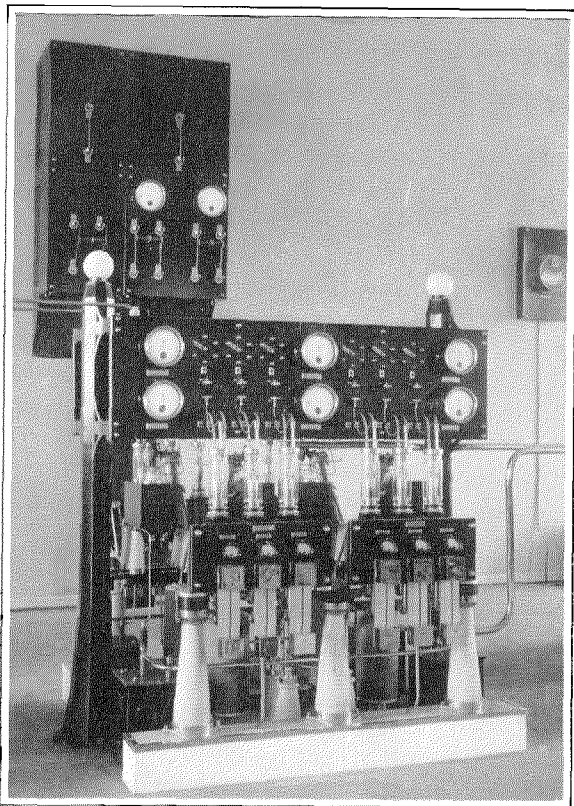

Figure 8—Radio Frequency Amplifier No. 3.

valves, a radio frequency peak voltmeter is built into the unit, the input being permanently connected across the grid circuit while the output is led away to a meter on the meter panel described above and to a second meter on the monitoring desk. The radio frequency amplifier No. 2 and the interstage circuit can be seen in Figure 4. The interstage tuned circuit which couples radio frequency amplifier No. 2 to radio frequency amplifier No. 3 is designed to meet both the output impedance requirements of radio frequency amplifier No. 2 and the input requirements of radio frequency amplifier No. 3. The coils consist of Pyrex formers on which are wound silver-plated copper tube. A short circuited turn rotates inside each coil. These short-circuited turns are coupled together and are operated by one turning handle.

Radio frequency amplifier No. 3 has six valves on each side of the push-pull circuit, and is assembled as shown in Figure 8. It is capable of delivering without overloading a maximum peak power of 480 kw. corresponding to 100 percent

modulation of a carrier power of 120 kw. The valves in this stage are divided into two groups of six valves each, each group comprising in effect a separate push-pull amplifier having three valves on each side of the push-pull circuit. Suitable switching arrangements are provided in this stage to enable the station to be worked at half power using one group (six valves) or at full power using both groups (twelve valves). These switching arrangements provide for the necessary changes in the impedance of the input and output circuits in order to meet the impedance requirements of the power amplifier when using either six or twelve valves. The change from half to full power or vice versa can be accomplished in less than five minutes. As in the case of radio frequency amplifier No. 2, each valve is provided with a separate anode current meter and an indicating overload relay. Meters are also provided to indicate the total anode current of each group of six valves. Four grid current meters indicate the grid currents of each three valves and a filament voltmeter gives readings of the voltage across the filament of each individual valve. A radio frequency peak voltmeter gives a permanent indication of the radio frequency drive applied to the grids of this stage.

The assembly of the apparatus of radio frequency amplifier No. 3 is similar to that of radio frequency amplifier No. 2, except that the instrument board, on account of its length, is supported by a pillar at each end. One of these pillars is surmounted by an orange warning light which indicates that the radio frequency drive is applied to the unit. The other is surmounted by a red warning light which shows when the high tension voltage is on.

The output circuit is designed for transmission line feed to the antenna. Radio frequency amplifier No. 3 works into a tuned output circuit which is capacitatively coupled to the transmission line. The output circuit is designed to operate at the correct value of impedance required for a straight dynamic characteristic of the valves in radio frequency amplifier No. 3. The use of capacitatively coupling reduces the harmonic radiation to a negligible value, as compared with inductive coupling, while retaining a very good bandwidth characteristic. Thermoammeters indicat-

ing the radio frequency currents in the various portions of the output circuit are mounted so that they can be seen over the top of the enclosure. For monitoring the output of the radio transmitter there is provided high tension peak voltmeter equipment which indicates the radio frequency voltage across the output circuit. The output from this equipment operates a meter directly connected therewith, as well as a second instrument on the monitoring desk.

Although the open type construction has been adopted for the power amplifier, the utmost protection has been provided for the operating personnel. The complete radio frequency amplifier equipment is surrounded by an enclosing railing about five feet high. This railing is of glass construction so that the apparatus can be seen through the enclosure. This enclosure surrounds the equipment on all sides so that it is possible to walk completely round the radio frequency amplifiers. Entry to the enclosure is by a gate controlled by a handwheel, and so arranged that it cannot be opened until the handwheel has been operated. The first movement of the handwheel operates the electrical safety system by opening the holding circuits of the contactors controlling the input to the main high tension transformer. It also opens the grid circuit. Further movement of the handwheel opens by mechanical coupling, the isolating switches which are located on the wall behind the radio frequency enclosure (in the view of the operator but out of his reach). These isolator switches break the grid and high tension connections of the apparatus in the enclosure and also short-circuit all the 20,000 volt circuits as well as the grid condenser. Finally, the handwheel unlocks the gate.

To enable the transmitter to be tested and adjusted without causing interference, an artificial antenna is provided. This permits accurate determination of the power output of the transmitter, which is a feature of great importance in tuning up the equipment. The artificial antenna, seen on the extreme left of Figure 5, is a non-radiating resistance in which the output of the transmitter can be dissipated instead of being delivered to the radiating antenna. The resistance is capable of dissipating some 200 kw. corresponding to the maximum output of the

transmitter with full modulation. The resistance elements are water cooled, and meters are provided to indicate the rate of flow of the cooling water and the temperature rise, thus permitting easy determination of the power dissipated. This artificial antenna resistance is connected in series in the output circuit, and is adjusted to have a resistance value approximately equal to the value of the "equivalent series resistance" of the output circuit. Thus, with the same input to the radio frequency amplifier No. 3, and the same setting of components in the output current, the value of circulating current should be the same with the real antenna and the artificial antenna. It is possible to measure the power in the artificial antenna by two methods. First, knowing the resistance of the artificial antenna by reading the circulating current; second, by measuring the water flow and the temperature rise through the artificial antenna. The latter is a very accurate method of checking the power.

The monitoring desk (Figure 9) is the position at which the operator normally sits to supervise the functioning of the transmitter when it has been put "on the air." In form, it consists of a desk with a flat writing top and drawers at each side. On the top and at the rear of the writing portion is a sloping instrument panel on which are mounted various meters and switches. The meters are divided into two groups, one to the right and one to the left of the operator, the centre portion of the panel being taken up with the keys and switches. The meters in the left-hand group indicate various low frequency voltages and currents, while those in the right-hand group indicate radio frequency voltages and currents. There are four meters in the left-hand group. Two of these indicate the voltage of the 15,000 volt, three phase 50 cycle incoming supply, and of the 20,000 volts D.C. anode supply, respectively. The other two meters are associated with the audio frequency currents in the equipment. The first of these is intended to be connected in series with a similar meter on the line amplifier equipment and indicates the amplitude of the audio frequency voltages delivered to the input terminals of the radio transmitter. The other meter is in series with the modulator grid current meter on the oscillator-modulator unit, and indicates the grid current of the modulator





Figure 9—Monitoring Desk.

valve. This meter should, of course, normally read zero, as the occurrence of grid current on the modulator valve marks the overloading of the transmitter. It may therefore be regarded as an over-modulation indicator for the equipment. There are six meters in the right-hand group. Three of these indicate the value of the radio frequency peak voltages applied to the grids of radio frequency amplifier Nos. 2 and 3, and to the output circuit respectively. The remaining three meters are direct current milliammeters working in conjunction with remote thermoelements; they indicate the radio frequency currents in each leg of the antenna transmission line and in the antenna respectively.

On the centre portion of the instrument panel are mounted a push-button for shutting down the transmitter in case of emergency, two knobs and two keys. One of the knobs operates a four point dial switch controlling the input of a built-in monitoring amplifier unit, enabling it to be

connected with the incoming line, or with the output of any of the monitoring rectifiers connected respectively at the inputs of radio frequency amplifiers No. 2 and 3 or the output circuit. Thus the speech or music can be followed through the various stages of the transmitter, and the quality compared at each point. The second knob controls the gain of the monitoring amplifier. One of the keys switches the monitoring connections either to a loud-speaker or to a headset, while the other key switches the output of the monitoring amplifier either to the loud-speaker or the oscillograph, thus enabling either visual or aural monitoring to be employed. The left-hand portion of the desk top is made to slide back to disclose a cathode ray oscillograph equipment mounted on a panel sunk below the shelf. This oscillograph panel is equipped with all the necessary controls, phasing condensers, etc., for observing and measuring the modulation of the transmitter.

**The Power Plant**

The power for the operation of the broadcasting equipment is obtained from a 15,000 volt, three phase 50 cycle high tension line. This power is brought into the building by underground cable terminating at a 15,000 volt incoming supply switchboard. There are actually three separate high tension lines feeding three separate underground cables which are all brought into the station building. Facilities are available in the station building for switching the three lines and so accepting the supply of power from any one of the three lines. There is therefore no danger of any serious interruption in the service due to failure of the main power supply.

*Power Supply System.* The 15,000 volt incoming supply board (Figure 10), energises the 380 volt machine supply transformer, the 380 volt

lighting transformer and the 20,000 volt rectifier transformer. From the 380 volt machine supply transformer the 380 volt three phase 50 cycle supply is taken to a distributing board where it is fed through a contactor and fuses to the motor generator sets, the water pumps and the mercury arc auxiliaries. This contactor, therefore, is the main 380 volt control. The feeders for the machines are each led to the change-over boards (each machine being supplied in duplicate) where they are each led through a contactor to the machines. The outputs of all the generators are taken to a contactor rack, on which are located the various feeder contactors for the generators, and thence via the filter circuit rack to the radio transmitter. With this system it has been possible to centralise respectively all the motor fuses, all the motor contactors, all the change-over switches, all the generator feeder

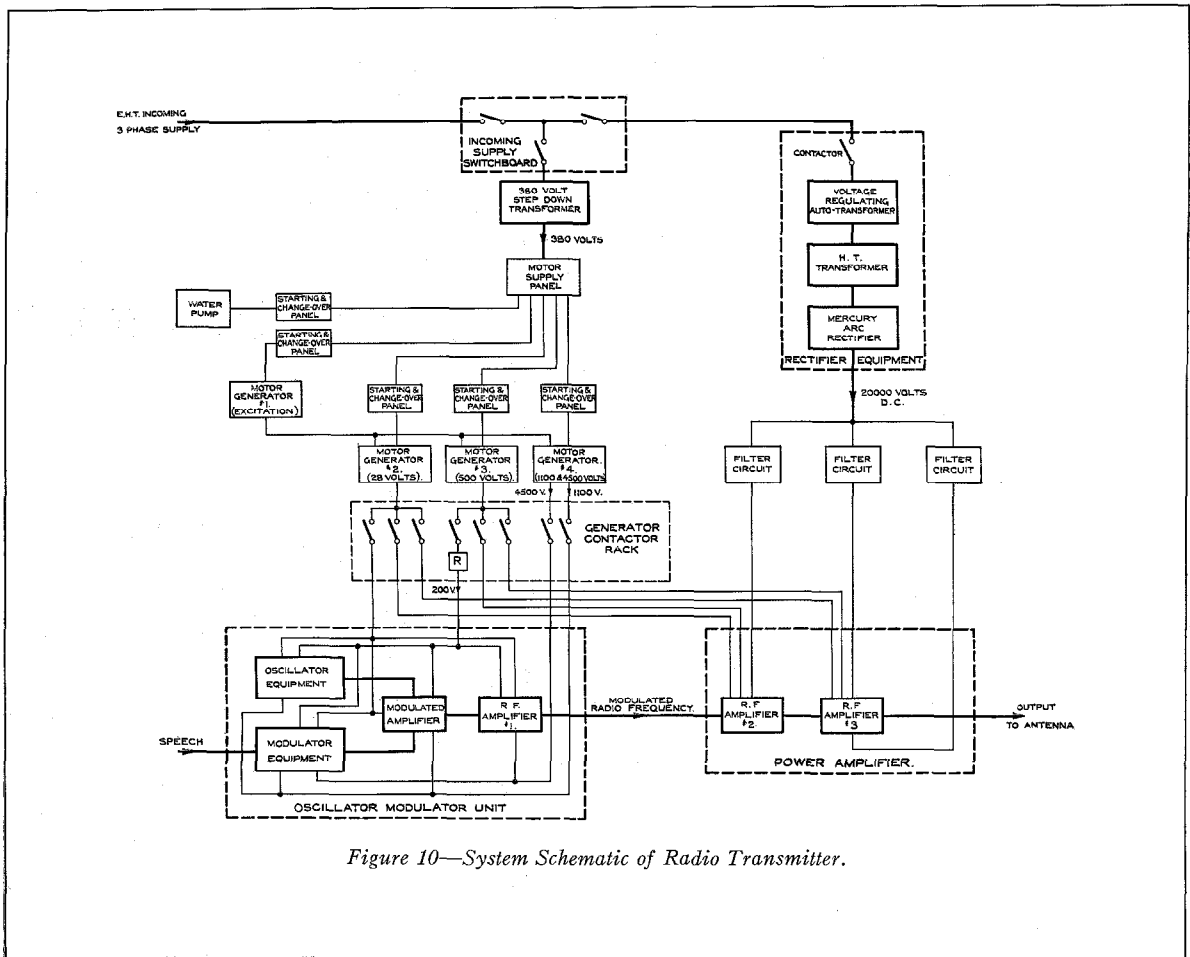

Figure 10—System Schematic of Radio Transmitter.

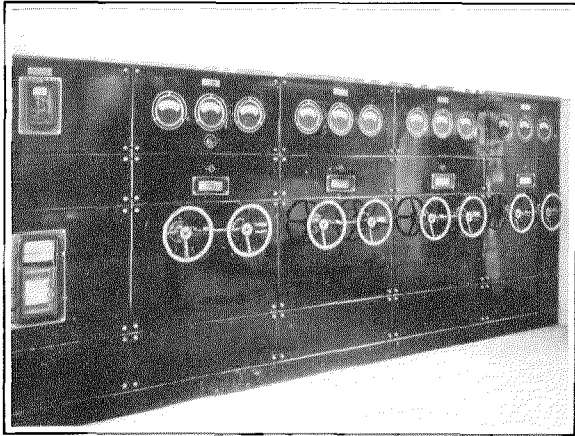

Figure 11—15,000 Volt Incoming Supply Panel.

contactors, and all the filter circuits. Further, this centralisation has been done in such a way that it is possible in a few seconds to follow any circuit through from the 380 volt main contactor to the exit from the filter circuit. From the operational standpoint this is a great asset. The feeder for the 20,000 volt transformer goes to the auto-transformer (for the tapping switch) and then through a contactor to the 15,000 volt primary. The secondary feeds the mercury arc rectifier direct.

*Incoming Supply Switchboard.* Figure 11 shows a front view of the 15,000 volt incoming supply switchboard. Here the main incoming supply power is metered, controlled, and distributed to the transformers. This board functions as the main position for applying or disconnecting the power from the station as a whole, and is not associated with the normal starting and stopping or adjustment of the radio transmitter. It contains the hand-operated main switchgear and main overload breakers, which are closed when the station is put into operation. No further operation of this switchboard is necessary during the running of the radio transmitter. The board also contains a number of instruments which give useful information regarding the incoming power supply, as for example, line voltmeters, line ammeters, frequency meters, watt meters, and kilowatt-hour meters. The switchboard is constructed on the cubicle system, the high tension apparatus, such as oil-break disconnect switches and air-break isolating switches, being located in a cubicle, the front of which is formed of

enamelled steel panels carrying the meters and handwheels for operating the switches. There are five such cubicles, the front panels of the five lining up in front to form one continuous power board.

Each panel, except the first, carries two handwheels, one of which operates the oil-break switch within the cubicle, while the other operates an air-break isolating switch mounted above the cubicle and out of reach when the latter is entered. The two handwheels are interlocked to prevent opening of the air-break switch until the oil switch is open. The handwheel operating the air-break isolating switch retains a special key which, when released, permits access to the cubicle by means of a door at the rear. In this way perfect security of the operating personnel is assured, while by the use of a different key for each cubicle it is possible to enter any cubicle without rendering the other cubicles inactive. A lamp on each front panel indicates when the corresponding oil switch is closed.

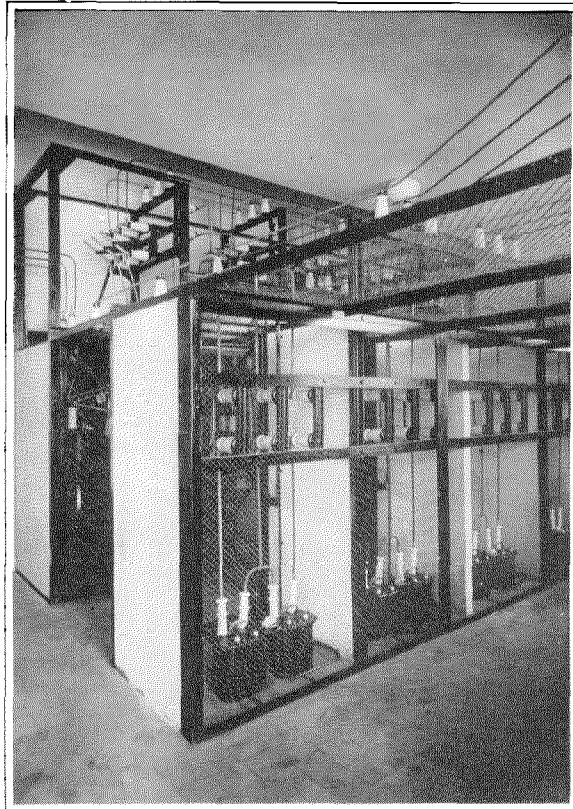

Figure 12—15,000 Volt Incoming Supply Panel—Rear View.

At the rear of the cubicles is another set of cubicles containing the instrument transformers, etc., as shown in Figure 12. These transformers are also completely enclosed by expanded metal screens. Between the instrument transformer cubicles and the main cubicles, there is a passage-way giving access for inspection, etc. To obtain access to the instrument transformer cubicles, however, it is necessary to obtain the key from the isolating handwheel located on the front panel associated with the instrument transformer. Behind the instrument cubicles are the 380 volt transformer vaults. These vaults contain three 15,000/380 volt step-down transformers, one for the machines, one for the lighting, etc., of the building, and one as a spare for the other two transformers. With this system of expanded metal screens and passages, it is possible to view all the equipment with absolute safety for the personnel.

The five cubicles of the incoming supply board, proceeding from left to right of Figure 11 are: the incoming voltage feeder cubicle, the main control cubicle, the lighting control cubicle, the 380 volt control panel, and the high tension rectifier control panel.

These panels are provided with a kilowatt-hour meter, frequency meter, voltmeter, ammeter and power factor meter for the total supply. Wattmeters and ammeters are provided on the 380 volt panel, the lighting panel and the high tension rectifier panel.

*The 380 Volt Distribution Panel* takes the 380 volts from the machine transformer and distributes it to the various circuits. It contains all the fuses necessary for each circuit, and also houses the main 380 volt contactor which closes the supply from the secondary of the 15,000/380 volt transformer. It is so arranged that the opening of the front panel gives access to all the fuses. This front panel is, of course, fitted with an automatic switch which cuts off the 380 volt supply from the panel, so that it is safe for the operator.

*Motor Generator Sets.* Four motor generator sets supply the filament current and the grid bias to all the valves used in the equipment, and the anode current to the valves used in the oscillator-modulator unit. The motors of these sets receive their power from the 380 volt dis-

tribution panel. From this panel the power is led to the four change-over panels, on each of which is a contactor which applies the power to the motor. These contactors are controlled by a push-button on the transmitter control switchboard, and an auxiliary contact on the first contactor energising the second contactor, which in turn operates the third, and so on, so that all the machines are started one after the other by pressing a single button. Centrifugal starters are incorporated on the various motors, so that these are started automatically when the appropriate contactor is closed. As already mentioned, the motor generators are installed in duplicate, and on each change-over panel are the necessary switches for changing-over the motor and the generator respectively, and also the fuses for each generator. The outputs of the generators are led via the generator contactor rack and the filter circuits to the various circuits concerned. These contactors are operated by push-buttons on the transmitter control switchboard. Motor Generator Set No. 1 is a two unit machine comprising a three phase 380 volt induction motor and a 110 volt 12 ampere direct current generator. This machine supplies current for excitation of the remainder of the generators used in the equipment. Motor Generator Set No. 2 is a two unit machine comprising a three phase 380 volt induction motor and a 28 volt 1,100 ampere direct current generator. This machine supplies filament current for all the valves in the equipment. An automatic D.C. voltage regulator associated with this generator keeps the output voltage constant within  $\pm 1$  percent. Motor Generator Set No. 3 is a two unit machine comprising a three phase 380 volt induction motor and an 800 volt 10 ampere direct current generator. This machine supplies grid bias for all the valves in the equipment, the voltage being broken down to the values required for the individual valves by means of potentiometers. Motor Generator Set No. 4 is a four unit machine comprising a three phase 380 volt induction motor, a 1,100 volt, 1 ampere direct current generator, and two 2,500 volt double commutator direct current generators. These two generators are connected in series to deliver 0.75 ampere at 5,000 volts. The 1,100 volt generator supplies anode current for the 50 watt air cooled valves used in the

oscillator-modulator, and the two 2,500 volt generators supply anode current for the 500 watt air cooled valves used in the same unit. All the generators have been specially built to give as small a voltage ripple as possible, so as to simplify the filter circuits and obtain noiseless carrier. The four change-over boards are located between the machines which they control. They are provided with doors at the back, through which access is obtained to the equipment. This door is, of course, provided with a mechanical switch which breaks the 380 volt supply to the board, and so enables the operator to work with safety.

#### *High Tension Anode Power Supply System.*

This system is capable of supplying a power of approximately 500 kw. at a D.C. voltage of 20,000 to the anodes of the valves in the radio frequency amplifiers Nos. 2 and 3. The equipment may be considered to comprise a high voltage rectifier, a contactor and voltage regulating equipment, and filter circuits. In view of the large power consumption involved, it was extremely important to employ a system having the highest possible electrical efficiency. Therefore, a mercury arc rectifier was used. The actual overall efficiency of the equipment, as measured from the high voltage incoming feeder to the output of the rectifier (including the power consumed by the rectifier auxiliaries) in 93 percent. A Hewitt type twelve-phase rectifier is used with glass rectifier bulbs enclosed in oil filled tanks. The rectifier system comprises in effect two identical but separate twelve phase rectifier equipments each delivering 250 kw. at 10,000 volts; the outputs are connected in series to give 500 kw. at 20,000 volts, so that, should one rectifier suffer a serious breakdown, it is possible to operate with voltages up to 12,000 volts with the remaining rectifier. Under these conditions, it would still be possible to obtain something like 50 kw. in the antenna. Thus something approximating duplication of the rectifier equipment is obtained.

The two H.T. transformers are of the self-cooling, oil-filled type, and are identical. Each has a three-phase primary winding and a twelve-phase secondary, the latter consisting of four separate three-phase star windings so arranged that the voltages in the stars are successively

displaced by a quarter of a period. The primaries of the transformers are operated from the 15,000 volt three-phase 50 cycle supply and each of the three-phase secondary windings has a voltage of 2,500 volts from phase to neutral. As, however, the secondary windings are, from a D.C. standpoint, connected in series, each is insulated for a working of 24,000 volts. The neutral point of each secondary star (except the first which forms the negative output terminal of the unit) is connected to the cathode of a rectifier bulb, the ends of the three-phase windings being connected to the three anodes of the following bulb. Each rectifier bulb is a three-phase unit, having three anodes, and delivers a rectified voltage of 2,500. The outputs of four bulbs are connected in series to give a D.C. voltage of 10,000 volts with a twelve-phase ripple. The bulbs are mounted in oil filled steel tanks; since each tank contains two bulbs it is in effect a 5,000 volt unit. Two of these tanks are associated with each transformer and are also connected in series, so that one transformer with two tanks comprises a complete 10,000 volt rectifier system. Two of these 10,000 volt rectifier units (i.e. two E.H.T. transformers and four tanks) make the complete 20,000 volt rectifier equipment. One tank complete with two bulbs is mounted as a spare, so that it can immediately be switched into service in place of the faulty tank, leaving the latter to be opened and the bulb replaced when opportunity permits. It is exceptional for a rectifier bulb to fail in service. In general, a failing bulb refuses to excite (especially after several hours rest) or excites in an irregular fashion, so that indication is given to the operator when he is starting up the equipment that one of the bulbs needs to be changed. The starting arrangement incorporated causes the arcs to be struck almost instantaneously and without the need of any mechanical manipulations, thus enabling the high tension voltage to be applied by push-button control, with the same degree of facility as in the case of a rectifier employing thermionic valves. Lamps on the outside of the tanks indicate that the arcs are functioning properly.

#### *Contactor and Voltage Regulating Equipment.*

The power supply to the rectifier equipment is taken through the high voltage contactor which is connected between the output from the in-



coming supply switchboard and the primary of the high tension transformer. This contactor, which is located in the H.T. rectifier enclosure, is operated by a push-button on the transmitter control board, and is the means of applying or removing the 20,000 volt supply from the power amplifier. The voltage regulating equipment permits the value of the D.C. voltage delivered by the rectifier to be adjusted over wide limits. It comprises a tapped auto-transformer which is connected before the primary of the H.T. transformer, thus controlling the voltage applied to the latter. The tappings on the auto-transformer are brought out to a tapping switch, which can be operated on load, and which gives a range of adjustment of  $\pm 20$  percent in 2 percent steps. The tapping switch is controlled from the transmitter control switchboard, thus enabling the D.C. anode voltages to be regulated from the radio room. The control is actually made by means of a small electric motor which is coupled to the shaft of the tapping switch. This motor can be run in either direction by means of a system of automatic contactors which are controlled from the radio room by means of two push-buttons. An arrangement is provided which automatically stops the motor when the tapping switch has arrived at either of its two extreme positions. In addition to this fine control, provision is made for changing the D.C. voltage in large steps for operating; for example, on reduced power when tuning or testing or making changes in the radio transmitter. This adjustment is, of course, not continuous, but gives certain definite steps of voltage. As previously stated, the rectifier consists of four 5,000 volt rectifier tanks connected in series, and high tension isolator switches are provided to enable the output from one, two, three, or four tanks to be used, as desired, thus giving nominal voltages of 5,000, 10,000, 15,000 and 20,000 volts. Three inductance coils are connected in the primary of the rectifier transformers to limit the short circuit current of the rectifier. Access is obtained to this rectifier assembly through a door which is so arranged that it cannot be opened until the key has been released from the main disconnect switch of the high tension rectifier control panel of the 15,000 volt incoming supply board. Furthermore, this door is so arranged that when it

opens, it automatically operates a switch which connects the high tension bus-bars to ground, and thus also discharges the smoothing condensers. Figure 13 shows the rectifier installation including tapping switch and contactor.

*Filter Circuits.* Three separate filter circuits are provided: one for radio frequency amplifier No. 2 and one for each side of the push-pull circuit of radio frequency amplifier No. 3. The use of separate filters prevents coupling between the stages due to common impedance in the anode circuit. It also has the advantage that, by splitting up the smoothing capacity, the amount of stored energy that can be instantaneously delivered into a fault is considerably reduced. Each filter comprises an oil immersed choke and a smoothing condenser. The filter for radio frequency amplifier No. 2 has an inductance of 12 henries and a capacity of 5 microfarads. Each of the filters for radio frequency amplifier No. 3 has an inductance of 10 henries and a capacity of 15 microfarads. The condensers are designed for normal working at 25,000 volts D.C. The amount of ripple remaining in the 20,000 volt D.C. supply, after filtering, is reduced to less than 0.03 percent.

*Transmitter Control Switchboard.* Located in the radio room, the transmitter control switchboard is the control position from which all the normal switching operations and adjustments of voltages are carried out. The motor-generator sets and pumps are started up, and the 20,000 volts D.C. is applied to the power amplifier by push-buttons on this board. The voltages of all the generators and of the 20,000 volts D.C. supply are adjusted by handwheels at this position. Meters on the switchboard indicate the values of all supply voltages used. Apart, therefore, from radio frequency circuit tuning, which does not normally require to be repeated once the station has been put into service, the whole equipment is controlled, started, and stopped from this position. The maximum voltage on this control switchboard is 110 volts.

The transmitter control switchboard is built in the form of six separate panels, fronted with highly polished black enamelled slate, and lined up to form one continuous switchboard. Each panel mounts all of the controls and instruments corresponding to one particular supply. Large

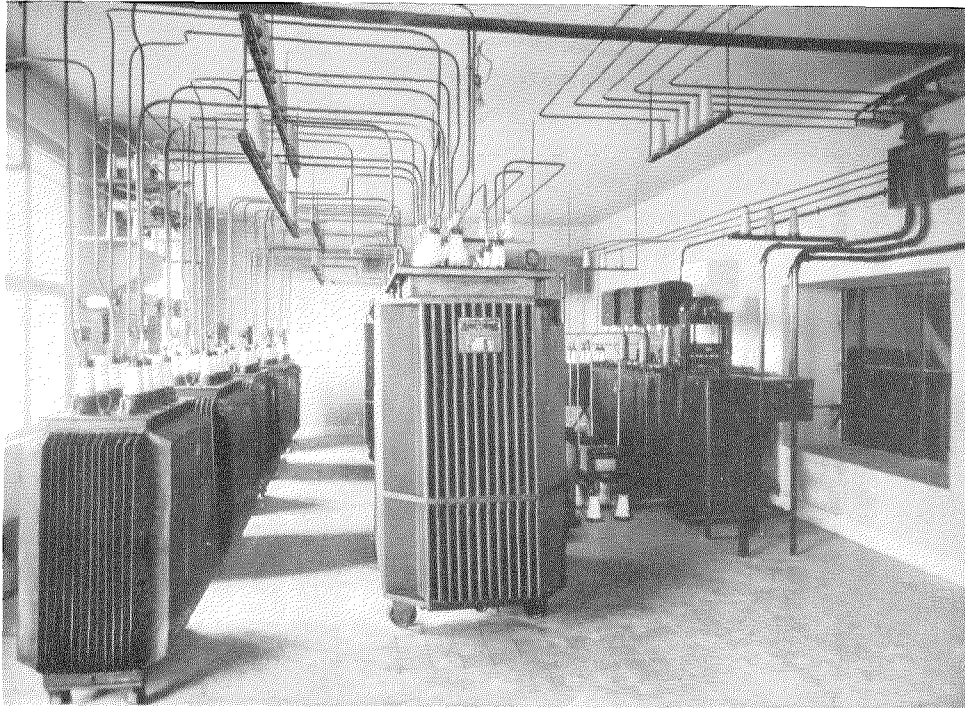

Figure 13—20,000 Volt Rectifier.

meters are supplied so that the operators can read them from any position in the room. Each of the slate front panels is divided into four sections. The upper section carries the meters, of which there are a voltmeter and ammeter for every supply voltage. The second section carries the push-button, above each of which is located a signal lamp which is lighted by an auxiliary contact on the associated contactor thus showing when the contactor is closed. The third section carries the voltage regulating control for the machines and the 20,000 volt rectifier, and also the overload and no volt relays. The lowest section is a blank panel. The six panels are arranged so that the transmitter is started up by successive operations, moving from the first panel to the sixth panel.

*380 Volt Supply Panel.* This panel controls the 380 volt supply from the step-down transformer, and puts into operation all the running machinery in the equipment, and a line ammeter. Four push-buttons are provided, the first of

which closes the contactor connected between the 380 volt transformer and the 380 volt distribution panel, and puts the 380 volt supply on the bus-bars of the latter. The second push-button starts up all the motor-generator sets, while the third push-button starts up the water circulating pump. The last push-button on this panel starts up the auxiliaries in the high tension rectifier equipment, thus putting the latter in a condition to be placed on load.

*Excitation Panel.* The panel controls the auxiliary voltages utilised in the control system. There are two such voltages: one of 110 volts D.C., used solely for excitation of the various generators, and one of 110 volts A.C., used for operating all contactors and signal lamps. The first of these supplies is obtained from motor-generator No. 1 and the second from a small step-down transformer connected across the output of the 380 volt supply transformer. The excitation panel has two push-buttons. One operates a contactor closing the field circuit of the 110 volt generator,

while the other operates a contactor which supplies the 110 volts A.C. to the bus-bars of the control circuit, thus rendering the latter operative.

*Filament Generator Panel.* This controls the 28-volt supply to the filaments of all valves in the radio equipment. Three push-buttons are provided for applying the 28-volt supply to the oscillator-modulator unit and to radio frequency amplifiers Nos. 2 and 3 respectively.

*Grid Generator Panel.* This panel controls the 800 volt supply from motor-generator No. 3, employed for providing negative bias for the grids of the valves. Three push-buttons operate contactors which apply grid voltages to the oscillator-modulator and the radio frequency amplifiers Nos. 2 and 3 respectively.

*H. T. Generator Panel.* This panel is associated with the control of motor-generator No. 4 supplying high tension current to the valves in the oscillator-modulator unit. There are two supplies to be controlled by this panel, the 1,100 volt supply and the 5,000 volt supply. Two push-buttons operate contactors connecting the generators with the oscillator-modulator unit.

*20,000 Volt Supply Panel.* This panel controls the supply of rectified high tension power for the power amplifiers. An "On-Off" push-button controls the application of this supply, by operating the contactor which applies the high voltage incoming supply to the primary of the rectifier transformer. Figure 14 shows the transmitter control switchboard.

*Control Circuits.* The control circuits are based on the fundamental principle that no voltage higher than 110 volts shall be led to the control switchboard. For this reason, the control circuits, including push-buttons, signal lamps and contactors are fed from a 110 volt three-phase A.C. supply obtained from a 380/110 volt transformer located behind the 380 volt distribution panel. Similarly, all the generators are excited from the 110 volt D.C. supply, which is reserved exclusively for this purpose. This has the advantage, so far as the 28 volt machine is concerned, of eliminating the uncertainty of "building up" which is not infrequently encountered in self-excited low voltage generators.

The 110 volt transformer is connected across one phase of the 380 volt incoming supply

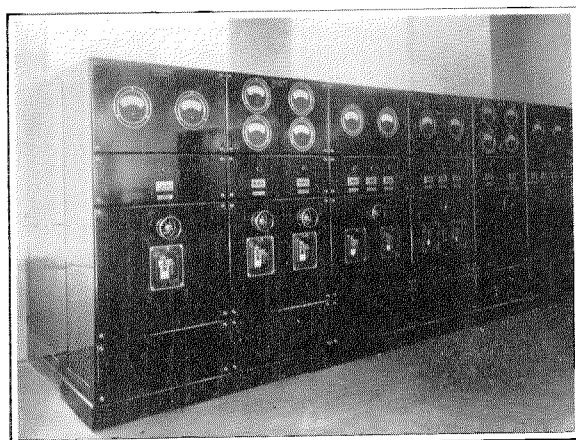

Figure 14—Transmitter Control Switchboard.

through a hand switch operated from the front of the 380 volt distribution panel; the transformer can thus be isolated so as to cut off the 110 volt A.C. supply entirely. This is, of course, not intended for use as a normal control, but permits work to be done on the control circuit without removing the whole 380 volt supply. The output from the 110 volt transformer divides into two portions, one portion going to the various motor starting contactors and other circuits controlled by the "starting" push-buttons on the 380 volt supply panel of the transmitter control board, while the other portion goes to a contactor which applies the 110 volts to a set of bus-bars on the generator contactor rack. This contactor is closed by the "control circuit" push-button on the transmitter control switchboard. The bus-bars energised by this contactor supply the generator contactors and other circuits of the security system. When this contactor is open the generator contactor rack is dead.

All the push-buttons are of the "momentary contact" type, returning to the unoperated position immediately after being depressed. The contactors which they control are locked up when operated, by means of auxiliary contacts, and are unlocked when once they are de-energised, either by operation of the security system or by depression of the "off" button. After the contactors have been opened, owing, for example, to a fault or the opening of one of the safety doors, it is impossible for the power to be re-applied in any manner except by pressing the appropriate "on" button.

The general principle of the security system is that each of the contactors applying power to the transmitter is energised by the 110 volt A.C. control circuit, and has in series with the operating coil the contacts of the security devices associated with that particular supply, so that in the event of the security device operating, the contactor is opened and the supply taken off. Furthermore, each security device is arranged only to take off the supply from those parts of the equipment which are affected by the fault with which it is associated. Thus, failure of the filament or grid bias supply de-energises the associated no-volt relays, which open the contactors applying anode voltage to all valves in the equipment. Failure of the water circulation operates the water flow security device, the contacts of which cause the opening of the rectifier contactor and the filament contactors for radio frequency amplifiers Nos. 2 and 3, thus taking anode voltage and filament current off all the water-cooled valves. Opening the door of the power amplifier and output circuit enclosure takes off the 20,000 volt supply and the grid bias supply from the radio frequency amplifiers. Opening the door of the oscillator-modulator unit removes the 1,100 volt and 5,000 volt supplies. The application of anode voltage to any unit before the corresponding grid and filament voltages are on is prevented by energising the high tension contactor through auxiliary contacts on the grid supply contactor for that unit, which in turn is controlled by auxiliary contacts on the corresponding filament contactor. In this way, damage to material or danger to personnel due to errors in operation or the occurrence of faults is absolutely prevented; at the same time difficulty and confusion resulting from unnecessarily removing the supplies from unaffected parts is avoided.

#### WATER COOLING SYSTEM

The water cooling system carries away the waste heat from the high power water-cooled valves, and is capable of dissipating some 400 kw. An explanatory schematic is shown in Figure 15. The circulating pump draws water from the expansion tank through a filter and forces it through the inlet hose coils to the various units of the power amplifier, returning through the outlet hose coils to the water cooler. Actually

there are twelve separate hose coils, one coil for the inlet and outlet of each valve in radio frequency amplifier No. 2, and a separate coil for the inlet and outlet of each group of three valves in radio frequency amplifier No. 3. From the water cooler, the cooled water is returned to the expansion tank. Between the pump and the hose coils, the water passes through the water control board, where are mounted the various stopcocks, meters, and water security devices. The radio units are at the highest point of the water system, so that the pressure there is a minimum. Consequently, to change a valve, it is only necessary to stop the water pump. The water in the thermionic valves will run back into the expansion tank through the outlet pipe. The water is held in the inlet pipe by means of a non-return valve (see Figure 15). Each water cooled valve is mounted in a water jacket in which the water is distributed in a thin sheet over the anode, moving at high velocity and with a stream-line flow. This design has been found particularly effective in preventing the formation of bubbles on the anode.

*Water Control Board.* On this board are mounted the indicating and alarm thermometers connected in the water return leads from radio frequency amplifiers Nos. 2 and 3. A fourth thermometer indicates the inlet temperature of the water delivered to the units. In the event of the water temperature approaching the safety limit, these alarm thermometers cause a bell to ring and a lamp to light. On this board are also mounted water flow relays which remove the power from the units in the event of a failure of the water flow. These relays are placed in the outputs from the radio frequency amplifiers. Each relay is in the form of a water flow meter, which indicates the flow, and causes the circuit breaker to open if the flow falls below normal. The water flow indicator consists of a "U" tube working on the differential pressure produced by a Venturi tube. The "U" tube contains mercury on which floats a nickel-plated steel ball. Outside the tube, which is of non-magnetic material, is a movable permanent magnet whose poles follow the movement of the ball as the mercury changes its level due to change of pressure or water flow. On the magnet is fixed a needle to indicate the flow in litres per minute,

and also a small contact maker which operates a relay and breaks the filament circuit when the water flow becomes too small for safe operation of the thermionic valves. In the event of the flow through any circuit failing, it is possible, therefore, to determine which of the units is giving trouble by observing these meters. In addition there is provided a master water flow meter which indicates the total water flow at

any time. The control handwheels for the water supply to the various units are mounted on the water control board.

Figure 16 shows the six panels of the water control board. The first panel is fitted with a gauge indicating the pressure of the water pump and a milliammeter which shows current leakage through the hose coils of radio frequency amplifier No. 3. The pressure gauge is fitted with a

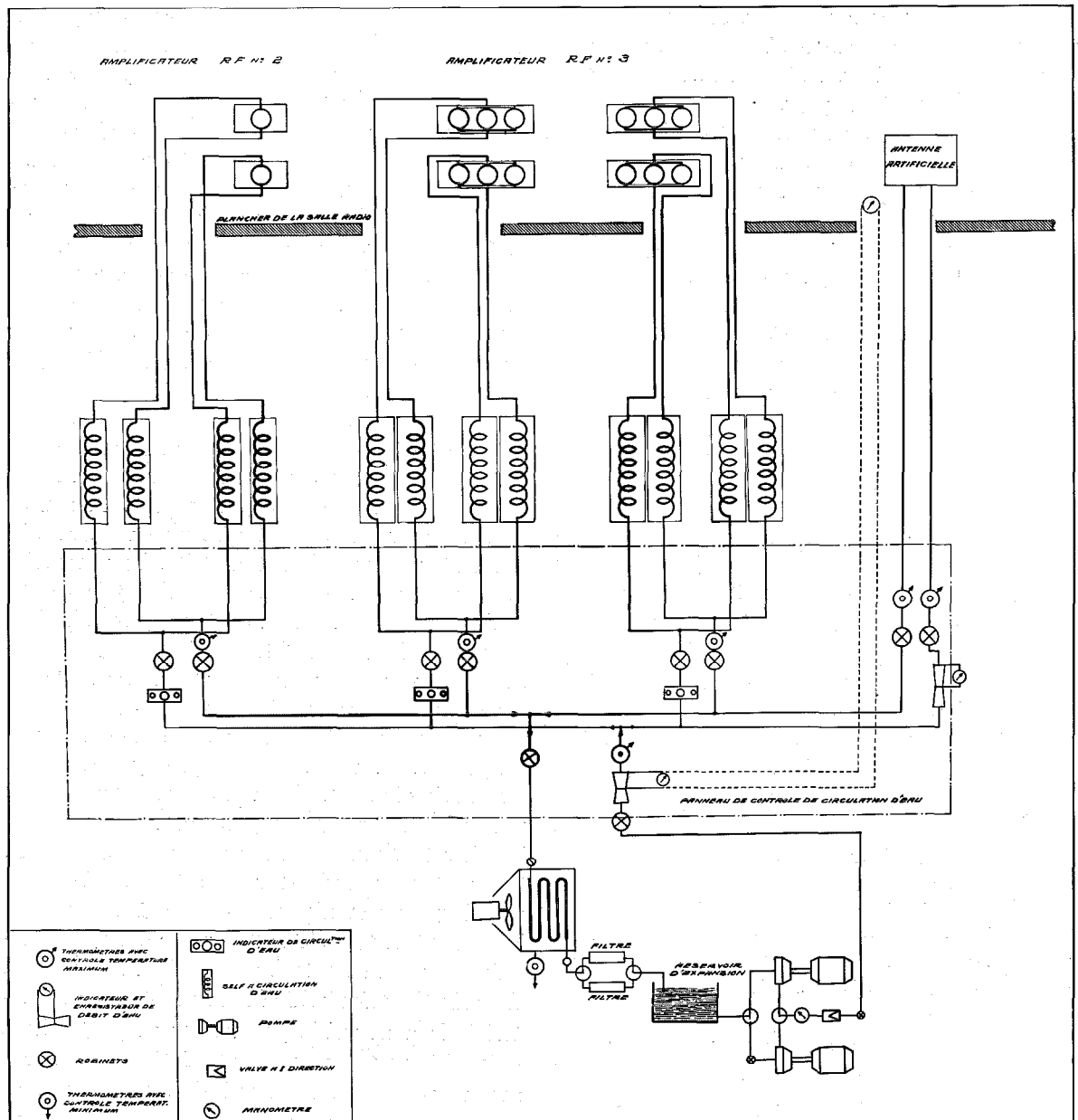

Figure 15—Schematic of Water System.

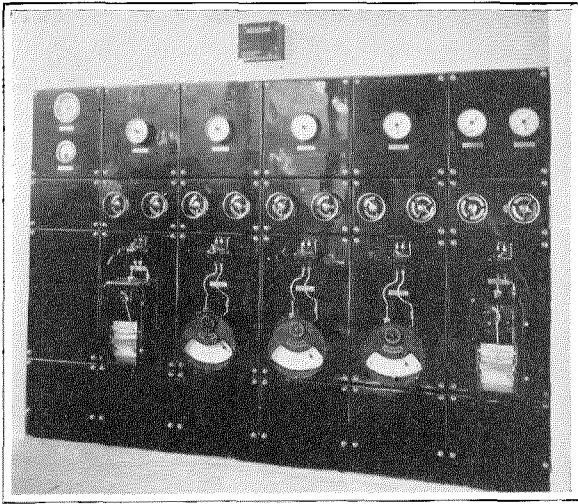

Figure 16—Water Control Board.

safety contact which causes a bell to ring in the machine room and the radio room when the pressure reaches too high a value. There is provided also a safety valve which lets out the water into a reservoir in the event of serious over pressure. On the second panel is mounted an inlet thermometer, a water flow register for recording on a paper drum, and two main control cocks, one in the inlet pipe and the other in the outlet pipe, so that the whole water system can be controlled from this panel. The third panel contains the apparatus for radio frequency amplifier No. 2, consisting of an outlet thermometer, two control cocks, and a water flow indicator. The fourth and fifth panels are for radio frequency amplifier No. 3, one panel for each set of six valves. They each contain the same apparatus as the third panel. The sixth panel is for the artificial antenna and consists of inlet and outlet thermometers with inlet and outlet control cocks and a water flow recorder. It is very easy, therefore, to measure the inlet and outlet temperatures and the water flow, so that the power which is dissipated in the artificial antenna can be arrived at instantaneously.

*The Water Pumps.* There is one working motor pump set and one spare. The centrifugal pump is capable of delivering 600 litres a minute against a head of 40 metres. There is one push-button (located on the transmitter control switchboard) in conjunction with an automatic starter for starting and stopping the motors of

the pumps, the starter being connected to either motor as required by a change-over switch. The same push-button serves to start up the fans. Signal lamps on a control board near the pump room indicate which of the pumps and fans are running. The water circuit contains a non-return valve which keeps the system full of water after the pump has been shut down.

*The Water Cooler.* This consists of a large honeycomb radiator through which cold air is drawn from outside the building by two motor driven fans (Figure 17). The air is expelled either through the roof or through a system of pipes for heating the building, the flow being regulated by vanes in the flues. One spare fan set is provided. The two working fans are started up by a delay action contactor which functions after the pump has been started. The choice between the three fan sets is made by means of isolating switches near each fan set. There is a thermometer at the bottom of the radiator with a low temperature alarm contact, inasmuch as the winter temperatures near Prague are very low and the cooler might freeze when the station is not working.

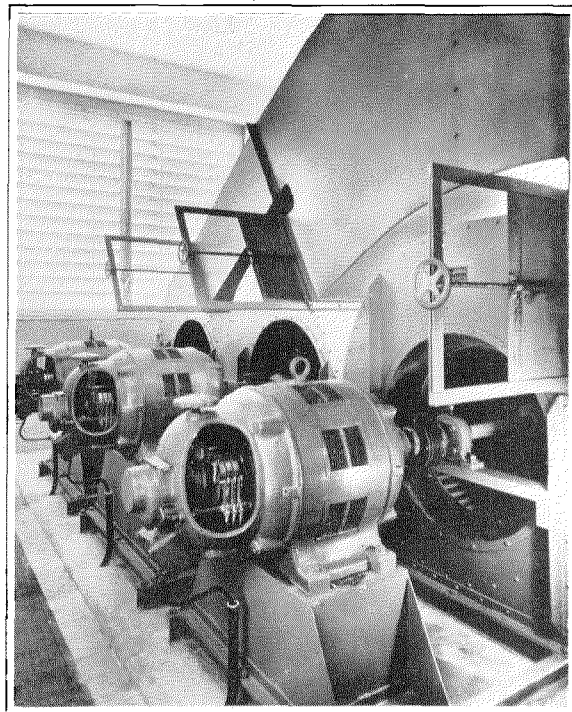

Figure 17—Motor Driven Fans for Air Blast Cooler.

*The Reservoir and Filters.* In order to even out the flow of water and to allow for slight evaporation, a copper reservoir of 2,500 litres capacity is provided in the hose-coil room, mounted slightly above the level of the pump. As it is essential that the water fed to the valve jackets should be as free from sediment as possible, two water filters are supplied—one in service and one spare. The hose coils and reservoir are housed in a room of which the water control board forms one wall. The door to this room has a safety switch for removing the high tension voltage should anyone try to enter during operation. In the neighbouring room are the pumps and cooler. The motor-driven fans suck air in through louvers in the outer wall of the building and blow it through the cooler. Brass piping is used throughout. The piping passes from the hose coils through the wall above the water control board, along the ceiling of the machine room (supported every five feet by insulated

supports) and then through large porcelain bushes supported on glass plates in the ceiling directly under the radio units. The whole group of pipes is surrounded by an earthed metal screen. Short lengths of rubber piping are inserted between the brass pipe and the radio units in order to keep the radio frequency and direct currents from reaching the hose coils except in so far as they are carried by the water.

### *Antenna and Earth System*

The fundamental requirement for the antenna was a strong radiation in a horizontal direction, which necessitates a high antenna. Consequently the towers are 492 feet high, insulated, and self-supported. They are spaced 820 feet apart. The antenna has been designed for transmission line feed, the transmission line terminating in the antenna hut in which is located all the necessary apparatus for feeding and tuning the antenna.

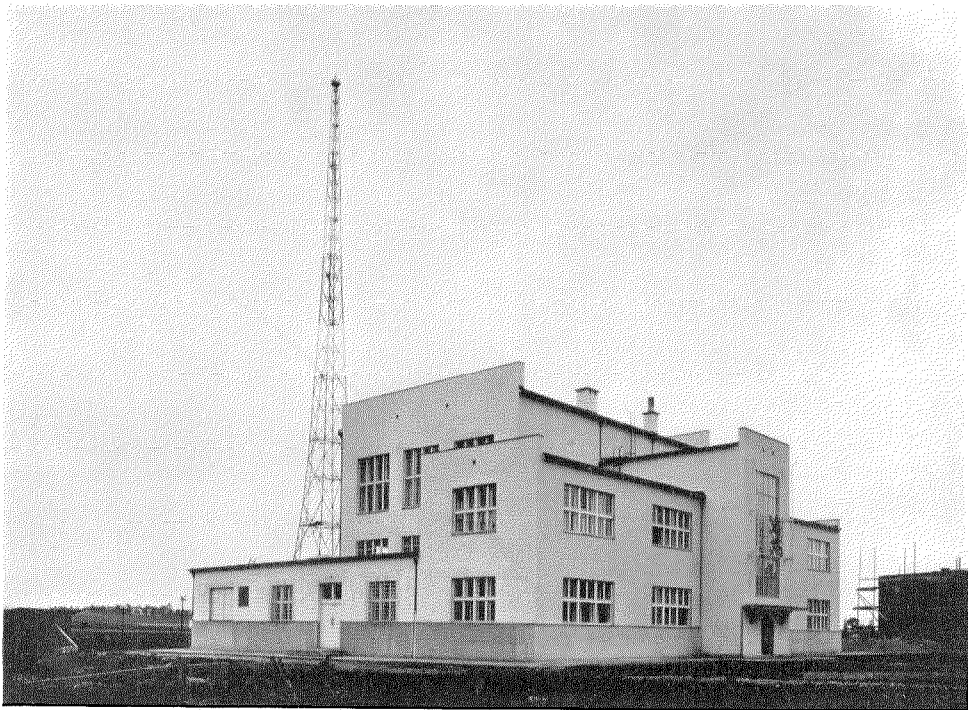

*Figure 18—Exterior of Radio Transmitter Building.*



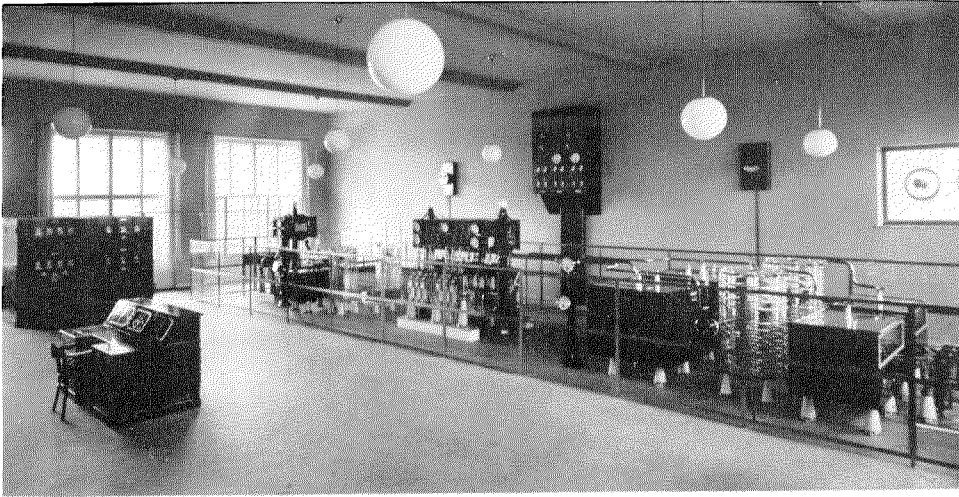

Figure 19—Radio Unit Enclosure.

### Radio Transmitter Building

The radio transmitter is housed in a two story building of very modern architecture (Figure 18). All the radio equipment is located on the upper floor and all the power equipment on the ground floor. The cabling between the two floors is arranged on cable boards so that every cable can be traced individually throughout its entire length. Figure 19 shows the arrangement of the first floor. There is one main room in which is located the radio transmitter proper (i.e., the oscillator-modulator, and the power amplifier), the monitoring desk, and the transmitter control switchboard; there is also a studio, a control room, a valve store room, a writing room, and engineer's and assistant engineer's offices. The studio is only for emergency use—the main studio, of course, being in Prague. In the control room the incoming telephone lines are terminated on the line amplifier equipment.

The building has a copper roof which is connected by copper bus-bars running down all four walls to the ground. There is also a copper mesh screen in the floor of the radio room so that all the radio apparatus is contained within a copper screen.

The ground floor also has one large room

exactly under the radio room, namely, the machine room. Surrounding the machine room on three of the sides are built low wings. The fourth side has offices, etc., which are located immediately under the offices on the upper floor. Figure 20 shows the layout of the ground floor. By arranging apparatus in the wings it has been possible to have all the switchboard controls, etc., located in one room, namely, the machine room. In the right hand wing are the 20,000 volt rectifier equipment and the 20,000 volt filter equipment, separated by an expanded metal corridor. This corridor permits the operators to see the rectifier and filter apparatus while it is under tension, without any danger. In the rear wing are located on the right, the 15,000 volt incoming supply switchboard, in the centre the 380 volt distribution board with the contactor and filter racks behind, and on the left the water control board with the hose coils behind. In the left wing are the water pump and water cooler rooms. In this wing there is also a switching station which controls the three 15,000 volt incoming lines. This equipment is not part of the broadcasting equipment but is actually a high tension switching station which has been located in the transmitter building in view of its appropriate geographical situation. The re-

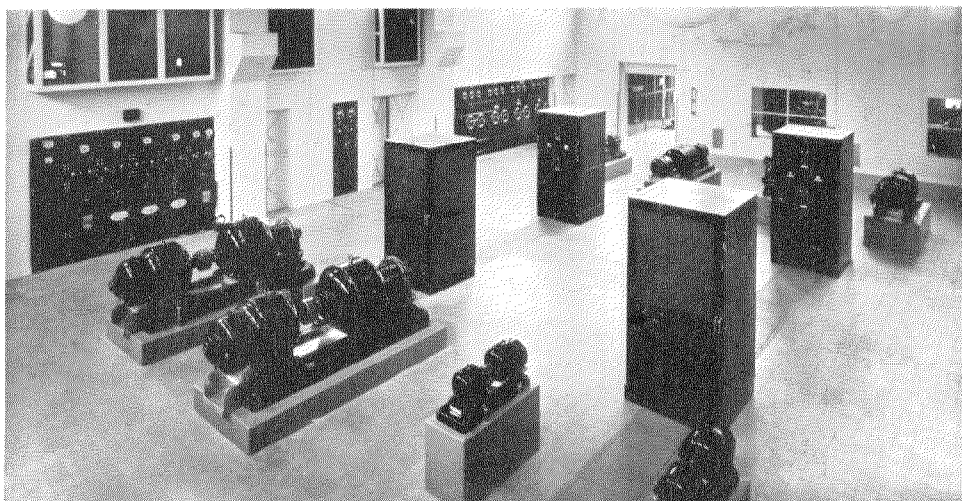

*Figure 20—Machine Room.*

maining rooms on the ground floor are the store rooms, the battery room, and the workshop.

The building follows the most modern practice not only as regards the general architecture of the fabric but also in the interior decoration and fittings. The main impression given in the interior of the building is the extremely high degree of natural lighting, brought about by the large number of windows, and greatly assisted by appropriate interior decoration.

The basement of the building contains a heating plant for the warm air heating system. This plant works in conjunction with the heated air which is discharged from the air blast cooler when the broadcaster is working. The hot air is circulated through the building by means of ducts built into the walls.

The equipment layout adopted gives the utmost simplicity of operation and ease of maintenance. It may be considered as consisting of the radio, control, and power equipment. Obviously, the control should be in the same room as the radio equipment, so that facilities are

given to the operators for full control of all power as well as radio equipment. The power equipment, however, should preferably be located in another room or rooms, and should not have any controls which need to be operated during normal running.

To start the complete broadcasting equipment the first operation is to close the switches on the 15,000 volt incoming supply board. When these switches have been closed the primaries of the 380 volt machine and lighting transformers and the 20,000 volt autotransformer (for the tapping switch) are all closed. Next the control cocks on the water control board are opened. This completes the operations on the ground floor (in the machine room) and no further operation is necessary on this floor until the complete station is closed down. All further adjusting and controlling is done at the transmitter control board in the radio room. After the complete equipment is in operation full indication of the performance of the station is given to the operator at the monitoring desk.

# Lining Up Broadcasting Circuits

By E. K. SANDEMAN

*International Telephone and Telegraph Laboratories, Inc.*

THE increased use of land lines for connecting up broadcasting stations and the advances in the requirements which broadcasting services impose on such land lines have introduced many new problems, one of which is a need for a rapid means of measuring line equivalents accurately and quickly. At their last plenary session, the C.C.I. decided on a method of measuring such equivalents and adjusting the levels, generally known as lining up, which seemed to be eminently suitable. Broadly this method consists in adjusting the transmission equivalent so that the voltage measured across the line at all frequencies in the range effectively transmitted is constant at a number of chosen points along the line. It is extremely simple in that it permits the use of automatic measurement of circuit equivalent; furthermore, suitable level measuring apparatus bridged across the line at each of the chosen points indicates immediately without additional adjustment whether the speech or music traversing the circuit at any moment is at the correct level.

In practice when the constant voltage method is adopted in order to ensure that measured equivalents shall add together to give a substantially true overall equivalent, the output impedances of all amplifiers must be reduced by an amount which results in lowering the effective power handling capacity of all output stage vacuum tubes. The reason for this will be explained later.

The C.C.I. recommendations regarding permissible deviations in overall equivalents have recently been tightened and it is now specified that the difference between the values of transmission equivalent measured at any two frequencies in the range of frequencies effectively transmitted shall not exceed 4.3 db (0.5 néper). Hence, there appears to be a demand for a precision method of lining up circuits which is universal in that it will not impose any special requirements on circuit components and therefore will permit the full power handling capacity of the amplifier to be realised.

A method of lining up circuits is discussed below which meets the above demand and has substantially all the advantages of the constant voltage method; this method is entirely consistent with present practice and fundamental principles of transmission and has the special advantage that each repeater section is made distortionless quite independently of any external link other than the impedance of the transmitting repeater which may have any value and is readily standardised. This is of special importance at switching points where a number of lines of different impedance may converge. In what follows the new method will first be outlined, and the constant voltage method will then be described in detail along with a brief discussion showing the special circuit means which the constant voltage method makes necessary.

## Definitions

Before taking up the special points involved it will simplify the discussion if the meanings of a few of the terms used are described explicitly.

*Constant voltage* is any a.c. voltage, varying in frequency over any required range of frequencies, which has the same value at all frequencies.

*Constant e.m.f.* is any a.c. e.m.f. varying in frequency over any required range of frequencies, which has the same value at all frequencies.

*Constant power* is any power contained in a single frequency varying over any required range of frequencies which has the same value at all frequencies.

*A distortionless amplifier* is one in which the input and output impedances are resistances of zero angle and which reproduces constant voltage applied across its input terminals as constant e.m.f. in its output circuit. (This does not give rise to constant voltage across its output circuit unless the impedance into which the amplifier operates is infinity or a resistance of zero angle.)

It may be helpful here to emphasise the difference between voltage and e.m.f. When a voltage

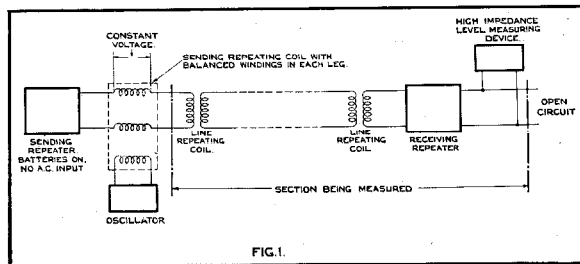

$v$  is applied between the grid and filament of a vacuum tube a voltage appears across any external circuit into which the output of the valve works

$$V = \mu v \frac{Z}{Z + R_0}$$

where  $Z$  is the impedance of the external circuit.

$R_0$  is the internal impedance of the vacuum tube and  $\mu$  is the amplification factor of the vacuum tube. The quantity  $\mu v$  is the e.m.f. in the output circuit of the tube, and when  $Z$  is made equal to infinity,  $V$ , the external voltage measured across the output terminal, is equal to the e.m.f. =  $\mu v$ . It is of course a well known fact that the open circuit voltage of any generator is equal to the internal e.m.f. In the present standard transmission measuring sets a constant voltage is applied to the line in series with a resistance representing the internal impedance of the apparatus to be connected to the line. In this way the voltage across the line varies with frequency in the same way as it does in practice for constant e.m.f. in the sending amplifier. In what follows, therefore, this method of applying constant voltage to the line has been called the constant e.m.f. method.

#### *Criterion of a distortionless land line system.*

Since all broadcasting lines operate between amplifiers any land line system can only be regarded as distortionless if when connected between distortionless amplifiers constant power entering the transmitting amplifier causes the receiving amplifier to deliver constant power to a zero angle resistance connected to its output.

Constant power in the input of the distortionless transmitting amplifier means constant volts across its input and so constant e.m.f. in its output circuit.

Similarly constant power delivered by the re-

ceiving amplifier into a pure resistance load postulates constant volts across its input.

Hence a land line system is distortionless if constant e.m.f. generated in a pure resistance (equal to the output impedance of the distortionless amplifier which is used for transmitting) bridged across the sending end of the system produces constant voltage across a resistance bridged across the receiving end of the system, this resistance being equal to the input impedance of the distortionless receiving amplifier.

### **Proposed Method of Lining Up Broadcasting Circuits**

1. Studio lines. Constant e.m.f. is sent from the studio (constant voltage in series with an impedance equal to the output impedance of the studio sending amplifier) and the circuit is equalised so that the open circuit voltage measured at the output of the first repeater (i.e., the e.m.f. in the output of the first repeater) is constant.

2. Repeater sections. Constant e.m.f. is sent from each repeater station (constant voltage in series with an impedance equal to the output impedance of the repeater) and the circuit is equalised so that the e.m.f. in the output of the next repeater is constant.

3. Transmitting station lines. Constant e.m.f. is sent from the last repeater station and the circuit is equalised so that constant voltage is produced across an impedance bridged across the receiving end of the circuit equal to the input impedance of the receiving amplifier.

It follows that constant e.m.f. in the output of the studio sending amplifier gives rise to constant e.m.f. in the output of every repeater and to constant voltage across the input of the receiving amplifier at the radio transmitter.

Figure 1 shows the proposed method of sending and receiving constant e.m.f. applied to a repeater section, the output of a repeater being used to give the necessary sending impedance.

From the point of view of ease of measurement there is no difference between the procedure proposed here and the procedure recommended by the C.C.I. For programme control, volume indicating means can be bridged across the repeater output in the same way as is done in the case of circuits lined up on a constant voltage basis. In practice this would undoubtedly prove entirely satisfactory but it is open to the academic objection that the quality of the speech or music applied as a voltage to the measuring gear differs from the true quality by an amount equal to the difference between the e.m.f. in the output

of the amplifier and the output voltage across the terminal of the amplifier when connected to the line, both expressed as a function of frequency. This difference is not negligible from the point of view of equalisation with steady frequencies but on speech or music it would be difficult and probably impossible to detect by a level measurement integrated over the frequency range. Level measuring apparatus may, however, be bridged across the output of an interstage branching amplifier specially provided for the purpose.

### C. C. I. Recommendations

#### 1. Studio Lines and transmitting station lines.

In answer to Question 23 (i) the following recommendations appear:

"La ligne reliant le studio à l'origine du circuit téléphonique à grande distance doit être établie de façon qu'une tension appliquée à l'origine de cette ligne et constante à toutes fréquences, engendre une tension également constante à l'origine du circuit utilisé pour les transmissions radiophoniques; de même, la ligne reliant le dernier répéteur à la station émettrice doit être établie de manière que, dans les mêmes conditions, la tension mesurée aux bornes d'une résistance de 600 ohms, substituée à la station émettrice, conserve, quelle que soit la fréquence, une valeur constante."

#### 2. Repeater sections.

"La 3ème Commission de Rapporteurs propose, en outre, à l'Assemblée Plénière de Paris 1931, de recommander aux Administrations et Compagnies Exploitantes d'organiser les réseaux de radio-diffusion et de régler les répéteurs placés sur les circuits de ces réseaux de manière que, lors de l'application d'une tension  $V$  à l'entrée d'une section de ligne quelconque, on obtienne la même tension  $V$  à l'entrée de toutes les sections suivantes pour toute la bande des fréquences effectivement transmises, quelle que soit l'impédance des différentes sections de ligne."

*From the above it is seen that the C.C.I. propose to line up circuits so that constant voltage at the input to the studio line produces constant voltage across the input to the receiving amplifier (assuming this to be 600 ohms in impedance).*

This is not a condition for overall distortionless transmission unless constant voltage at the transmitting end and constant e.m.f. at the transmitting end are identical or in constant ratio at all frequencies. Owing to the large variation with frequency in the impedance of non-loaded cables, such as normally constitute studio lines, if established methods of impedance match-

ing were adhered to, constant e.m.f. would give rise to voltages applied to the line differing several decibels within the range of frequencies effectively transmitted. These differences correspond to distortion in the overall system which is nowhere taken care of.

An obvious means of overcoming this difficulty is to drop the impedance of the transmitting amplifier to such a low value that the voltage applied to the line approximates sufficiently closely to the e.m.f.; in this case it makes no difference whether the circuit is lined up on a constant voltage or on a constant e.m.f. basis. In order to get a sufficiently close approximation it is necessary to drop the impedance to less than half the lowest impedance reached by the line in which case it becomes necessary to increase the power handling capacity of the vacuum tube.

A similar difficulty occurring at branching points can be overcome by the same means. The C.C.I. proposes to equalise circuits so that constant voltage applied to the input of a line results in constant voltage appearing at the output of the receiving repeater with the outgoing line connected. Where a branching repeater is used with a number of separate outputs working into lines of different impedance it is evidently not possible to make constant voltage at the transmitting end produce constant voltage in the output of every branching repeater without recourse to individual equalisation in each branching repeater. It is of course a simple matter with a single equaliser to make each repeater deliver constant e.m.f. Again, therefore, we are driven to low output impedances and tubes of higher power handling capacity.

While it may be the case that at any given stage in evolution the tube power handling capacity economically available may exceed requirements, there are many obvious ways in which that extra power handling capacity may be useful in the future, for instance in enabling smaller conductors to be used or in raising the general level of the system and reducing noise.

It is submitted that any method of lining up circuits which inherently demands a higher power handling capacity from the amplifiers than is warranted by the required circuit levels is wasteful.

# Pneumatic Ticket Distributing Systems for Toll Boards

By CARL BECKMAN

*Mix and Genest A. G., Berlin*

TOLL exchange engineers charged with the care of certain types of pneumatic tube systems for the distribution of toll tickets know what troubles can arise with such plants and what a large amount of work is required to keep installations in proper working condition. Among the prominent causes of troubles and losses are "jams" which are caused by stoppages of the tickets while in transit in the tubes and which occur particularly while traffic is heaviest. Many attempts were made to overcome this difficulty and finally Mix and Genest A. G., after years spent in studying the improvement and development of ticket distributing systems, successfully solved the problem. They found jams in the tubes were caused primarily by the method employed in folding the tickets. They found also that operation could be much improved by changes in the valves and in the cross sectional contour of the tubes.

This paper outlines the study made of the factors involved and the changes that were finally successfully adopted.

## *Folding of Tickets*

A widely used method of ticket folding is shown in Figure 1. According to this method the ticket is first bent at a position marked by a line and then is introduced into the tube with the bent flap head on. The result is that the driving air acting upon the ticket presses it against the inside wall of the tube, thus increasing friction. It will be apparent that with this method of folding the ticket, the danger of jams in the tubes is relatively great, particularly during times of heavy traffic, since the tickets tend to wedge into each other, thus further increasing the friction of the tickets against the tubes to such a degree that entire stoppage finally results (Figure 2). In such cases it has often been found necessary to cut the jammed tube section or burn out the tickets within the tube with resultant loss of the message



Figure 1

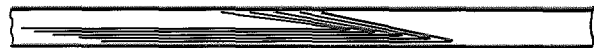

Figure 2



Figure 3



Figure 4

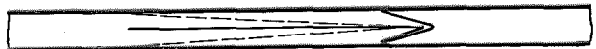

Figure 5

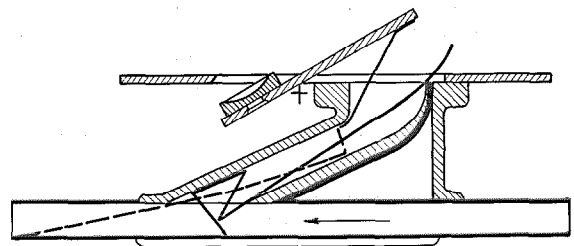

Figure 6



Figure 7

records. It should be noted that static electricity, due to the friction of the tickets pressed against the inner walls of the tube, also causes the tickets to stick tightly to the wall, especially when the air in the tubes is very dry. As a result the flap

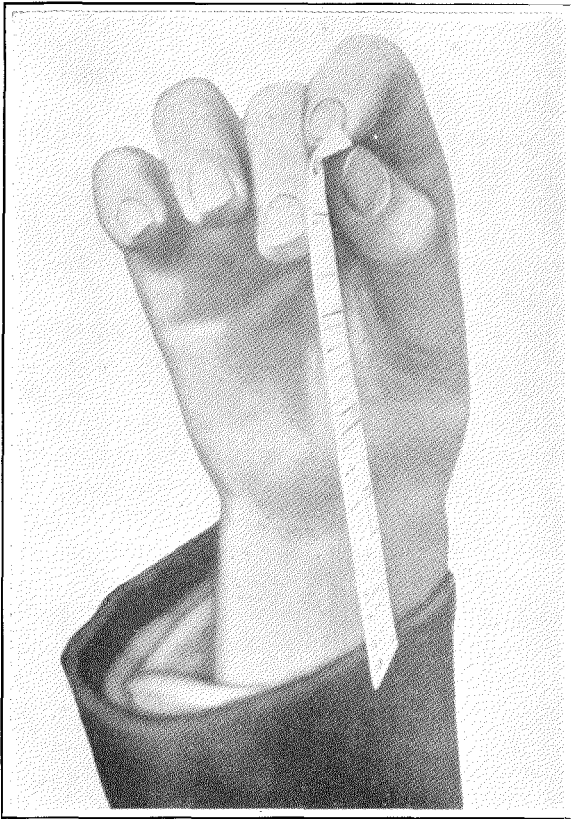

Figure 8

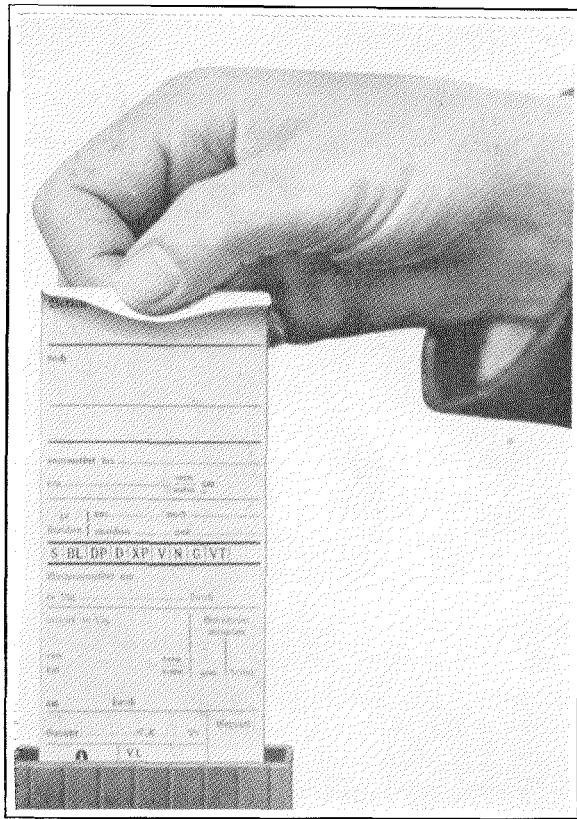

Figure 9

of the ticket often becomes opened enroute (Figure 3) and the ticket is stopped. To release the tickets, toll ticket officials use so-called "drivers," as indicated in Figure 4, but their use is objectionable inasmuch as they frequently cause further stoppage.

Another well-known method of folding tickets is indicated in Figure 5. According to it the ticket is first folded similar to the method indicated in Figure 1 after which another fold is made so that the head of the ticket becomes arrow shaped. The advantage of this double folding is that the ticket occupies the cross sectional area of the tube almost completely and rubs against the walls of the tube at the edges only with consequent reduction of jams due to static electricity. On the other hand, the double folding of the ticket causes increase of friction. Another drawback inherent in this method is that the edge of the flap is easily opened especially when the ticket is introduced in a vacuum transmitting valve (Figure 6). In this case on opening the flap

of the transmitting valve, the air enters the sending slot and is of course greater the nearer the transmitting valve is located to the receiving apparatus. Under these conditions when the front edge of the ticket is leaving the sending slot the entering air tends to open the fold of the ticket. This happens invariably if the operator holds the ticket a moment so that it is kept from starting at once. With this method also, stoppages in the tubes cannot be absolutely avoided particularly during hours of heavy toll traffic, when the tickets press against each other and against the inner walls of the tube. The fact that with this method of folding the front end of the ticket has four thicknesses of normal paper, makes this tendency more pronounced.

For more than eight years Mix and Genest have employed an improved method of ticket folding (Figure 7) which has practically eliminated all the above mentioned drawbacks. When printing the ticket a dotted line is impressed at a distance of eight millimeters from one end and



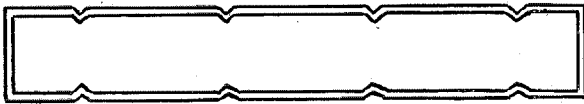

Figure 10

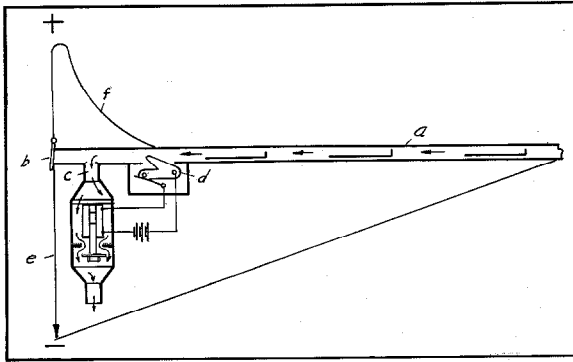

Figure 11

the ticket is folded at this point without any special appliance by pressing the ticket between the thumb and the forefinger as indicated in Figure 8. Figure 9 indicates the manner of inserting the ticket into the transmitting tube. The ticket travels in the tube with the folded flap in the rear and at right angles to the main portion of the ticket. Since the flap of the ticket almost fully occupies the sectional area of the tube, it of course acts as the driver of the ticket. Thus the air pressure is no longer divided into several components and the frictional resistance is not increased by pressure of the ticket against the inner wall of the tube. Moreover, with this method the air pressure is fully utilized for the conveyance of the ticket since it practically floats in the air stream, scarcely touching the tube walls.

In addition to the advantages derived from folding, improvement has been effected in the Mix and Genest transmitting tubes by fitting them with longitudinal inside ribs (Figure 10) and thus further minimizing frictional resistance. With longitudinal ribbed tubes the tickets merely touch the inner surfaces of the tubes along a few lines. With these tubes and the improved method of ticket folding the power consumption of the pneumatic ticket distributing systems is reduced by 30% or 40%. In other words a considerably reduced air pressure is adequate for driving the tickets.

### Vacuum Receiving Valves

Vacuum receiving valves formerly used, for example, the motor driven valves, as well as the automatic ejection valves, give considerable operating trouble. Mix and Genest have introduced an entirely new type of vacuum receiving valve for pneumatic ticket distributing systems by the use of which reliable ejection of the tickets is assured.

The general design of this valve is illustrated in Figure 11. The transmitting tube "a" terminates in the flap "b," the air pipe "c" leading to the blower being connected to the transmitting tube close to the receiving flap. An electrically controlled valve inside the tube serves to stop the air current passing through the tube. The magnet of the electrically operated valve functions by means of contact "d" over a relay chain, not shown in the drawing.

The air pressure in the tube is shown diagrammatically. The height "e" representing the low pressure decreases towards the open end of the tube and finally reaches the zero point. When a ticket touches contact "d" the vacuum in the valve is cut off but the air in the tube continues to move along the tube and generates high pressure towards the end as indicated in the curve "f." Thus the exterior high pressure on the valve is compensated for, the flap opens and the ticket is ejected without coming to rest in the receiving valve. It will be evident, therefore, that the efficiency of the Mix and Genest device is by far greater than that of the formerly used ejection apparatus.

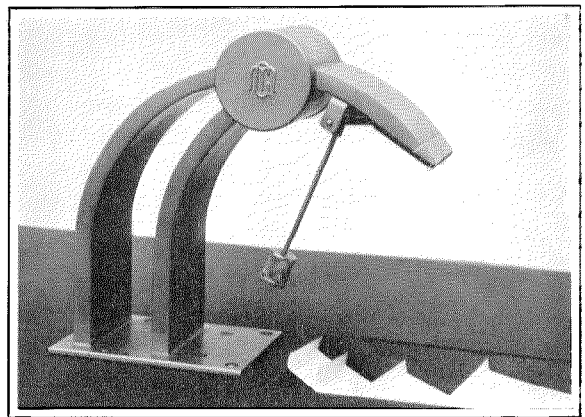

Figure 12

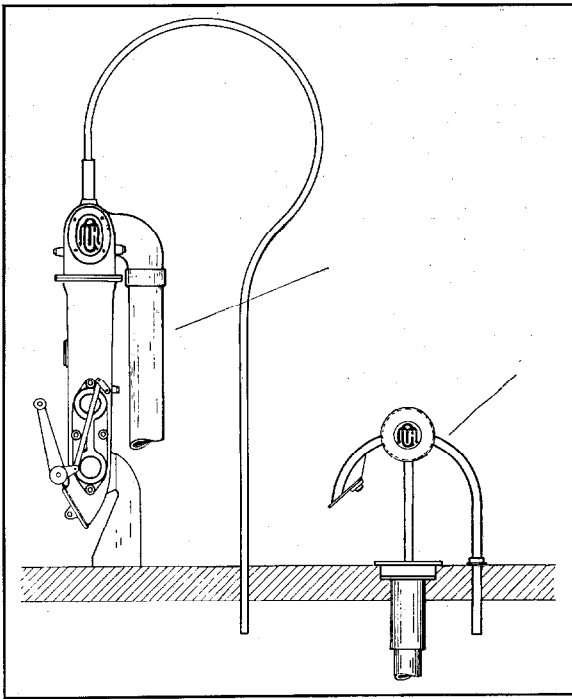

Figure 13

Stoppages in the receiving valve shown in Figure 12 are thus practically eliminated, and can only occur in case the electric control device should fail to operate. In case stoppages should occur, they are recognized by the buzzing sound emanating from the ticket in the tube, and are at once eliminated by a series of compressed air impulses following each other at intervals. The vacuum receiving valve used formerly is shown for comparison with the new valve in Figure 13. When it is required to install several valves, as is necessary in large installations, it is recommended that the ejected tickets be conveyed by a moving belt to a common receiving position. This may be done in a very simple way by arranging the receiving valves at an acute angle to the moving belt. Thus the tickets are piled up consecutively at the end of the belt and may be taken away according to the order of their arrival. The arrangement is shown in Figure 14.

**Results Achieved**

Experience under actual service conditions has shown that with tickets with the improved folding, stoppages have been entirely eliminated

even during periods of heavy traffic. As soon as the bent end of the ticket is introduced into the sending slot of the vacuum transmitting valve (Figure 6) the ticket is started on its way without difficulty by the entering air. The tickets follow each other through the tube in the manner indicated in Figure 15. Fifteen or twenty tickets may be dispatched immediately after one another or they may be transmitted in small parcels of six or eight. Incidentally, in the Mix and Genest method the ticket is folded at an unimportant point near the end so that with this exception the ticket remains entirely smooth, an advantage of great importance in view of the value of the records contained on the tickets.

The following toll exchanges have adopted the Mix and Genest method of ticket folding with results satisfactory to all concerned:

TOLL EXCHANGE		
IN		SINCE
Plauen i. V.	Germany.....	1925
Duesseldorf		1924
Koblenz		1927
Bielefeld	Norway.....	1927
Oslo.....		1924
St. Gallen	Switzerland....	1930
Geneva		1930
Turin		1931 (re-designed for M. & G. folding method)
Rome	Italy.....	1931 (re-designed for M. & G. folding method)
Genoa		(being built)
Olten.....	Switzerland....	(being built)

Other toll exchanges previously employing older methods of ticket folding are now adopting the Mix and Genest method. While there is a

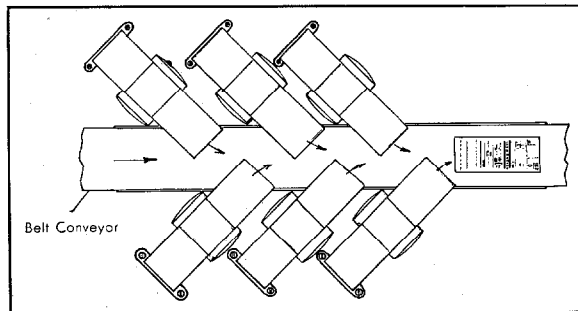

Figure 14



Figure 15

natural reluctance on the part of toll exchange officials to abandon a folding method which has been in use for many years and which is familiar to the operating personnel, the advantage in changing to the newer method is considered more than sufficient to compensate for any temporary inconvenience. Experience has shown that within about eight days the exchange personnel becomes fully conversant with the method of operating the new system. The fact that it is simple in operation and the tickets do not undergo any deformation in traveling through

the tubes of course facilitates its introduction.

A new Mix and Genest vacuum receiving valve has been working at the Toll Exchange at Bielefeld since December, 1930, to the entire satisfaction of the Postal authorities. The Toll Exchange at Genoa will be equipped with six receiving valves of this type. The advantages of this new valve are simplification in design, increased reliability in operation, reduced cost of installation and easier supervision inasmuch as the valves project only twenty-five centimeters (ten inches) above the table.

---

 IN MEMORIAM
 

---



---

 MR. KANKICHI YUKAWA
 

---

## A Brief Biography of Mr. Kankichi Yukawa

THE late Mr. Kankichi Yukawa was born on the 24th of May, 1868, in Shingu, a small country town in Wakayama Prefecture, Japan. ¶ In 1896 he was chosen as one of the Japanese delegates to the International Postal Conference held at Washington. On his way back he visited Europe, inspecting the industrial and commercial conditions there. ¶ On his return, he was appointed Director of the Tokyo Communications Bureau, and a Councillor to the Department of Communications and to the Department of Foreign Affairs. ¶ In 1898, he was made Principal of the Postal and Telegraph Officers' Training School, where he won the love and respect of his students. His efforts during his years of service there were fully repaid, for many of his students have become prominent figures in the telephone and telegraph field in Japan. ¶ In February, 1905, he retired from the Civil Service and joined the Sumitomo firm, where he began his new career as Manager of the parent company of all of the Sumitomo concerns. ¶ In 1910, he was nominated one of the Directors of the Sumitomo Goshi Kaisha. He was also appointed Manager of the Sumitomo Steel Tube and Copper Works. Under his supervision and management the Sumitomo Steel Tube and Copper Works enjoyed great prosperity and made great strides on the technical side. ¶ The wire plant which was started as one of the departments of the Sumitomo Steel Tube and Copper Works became a separate company at his initiation, and was established as an independent plant in August, 1911. ¶ In 1912, he was elected Director of the Sumitomo Bank, Limited, became its Managing Director in 1915,

and remained in that capacity till 1925. ¶ In the fall of 1918 he made his second trip to America. He availed himself of this opportunity to negotiate an agreement with the International Western Electric Company, Incorporated, (now the International Standard Electric Corporation). In February, 1919, he carried on various negotiations which resulted in a successful association with the Bell System and the International Western Electric Company, Incorporated, and the Nippon Electric Company, Limited. ¶ The Sumitomo Electric Wire and Cable Works was incorporated under the Japanese laws as a limited company with Western participation through the Nippon Electric Company. This participation was taken over by the International Standard Electric Corporation in 1925. ¶ In October, 1925, he succeeded the late Mr. K. Nakada as Director General of the Sumitomo Goshi Kaisha. He retired from this position, and was succeeded by Mr. M. Ogura, remaining as Adviser to the Company. ¶ Mr. Yukawa was a Member of the House of Peers, to which he was appointed by the Emperor in December, 1930. He was also a member of many associations and committees formed for the purpose of industrial and economic investigation and development in Japan. ¶ In his private life, Mr. Yukawa was known as the pioneer of golf in Japan, and was President of the Ibaraki Golf Club. He was highly esteemed for his sportsmanship and greatly admired by all who came in contact with him, for his many excellent qualities. ¶ Mr. Yukawa succumbed to pneumonia on August 23, 1931.

---

# An Automatic Device for Recording, Correcting and Analysing Articulation Results

By JOHN COLLARD, Ph.D.

*International Telephone and Telegraph Laboratories, Incorporated*

SINCE a telephone circuit is designed primarily to transmit speech from one place to another, the articulation test, which gives a measure of the success with which the circuit functions in this respect, is of considerable importance in the design and development of telephone apparatus and in fundamental studies of speech.

Unfortunately, the articulation test is lengthy and is particularly subject to errors due to the human element. In consequence, work has been in progress in the International Telephone and Telegraph Laboratories with a view to reducing the length of time required for a test and eliminating as far as possible the effect of the human element. One result of this work has been the development of an electro-mechanical device for recording, correcting, and analysing of articulation test results. This device, which has been called the articulation recorder, not only materially reduces the time required for correcting and analysing results, but also eliminates the errors which are so apt to occur when these operations are carried out by manual labour. In order to make clear the operation of this device and the benefits resulting from its use, a short description is first given of the way in which an articulation test would be carried out by manual labour only. The construction of the device is then described and finally a short account is given of its use together with a discussion of its advantages.

## *Articulation Technique*

When it is desired to measure the articulation of a given telephone circuit a crew is used which may consist of any number of testers from two upwards, although for accurate and reliable results at least nine testers are desirable. One of these is used as a caller at the transmitting end of the circuit while the remainder act as listeners at the receiving end of the circuit.

The ordinary speech sounds, vowels and con-

sonants, are taken and formed at random into pronounceable syllables. These syllables may be of various forms but the most common type is that consisting of an initial and final consonant with a vowel in between, e.g., *BIK*. Random syllables, rather than actual words or sentences, are used in order to avoid guessing on the part of the listeners.

The caller calls these syllables over the circuit one by one and the listeners write down what they think each syllable is. The list of syllables written out by each listener is then taken and corrected by comparison with the list actually called. In some cases, the articulation of the circuit is taken as the percentage number of syllables correctly received over the circuit. In other cases, the articulation is taken as the percentage number of individual speech sounds correctly received.

In one system used in the laboratories, packs consisting of 80 cards are used and each card has a different syllable typed on it. Half these cards have a syllable of the form consonant-vowel-consonant, one quarter of the form vowel-consonant and one quarter of the form consonant-vowel. Hence the total number of speech sounds used in forming these 80 syllables is  $40 \times 3 + 40 \times 2 = 200$ . Other systems employing only one type of syllable are also in use and the articulation recorder can be used equally well with any of these systems. In this description the application of the recorder to the system using different types of syllables has been dealt with.

In order to show the considerable amount of work involved in correcting and analysing the results of an articulation test, let us take the case of the packs mentioned above which contain 80 syllables composed of 200 speech sounds. Assume also that a crew of nine testers is being used and that a test consists of each tester calling in turn to the remaining eight. At the end of the test there will be  $80 \times 9 \times 8 = 5,760$  syllables and

$200 \times 9 \times 8 = 14,400$  sounds to be examined and corrected. Furthermore, for certain fundamental studies, it is desirable to know not merely the average sound articulation but the articulation for each individual speech sound. This means that, instead of obtaining only one value of articulation for each test, 37 different values must be worked out since 22 different consonants and 15 different vowels are used in the syllables.

These figures will give an idea of the very large amount of labour required in correcting articulation lists. Bad handwriting of the listeners often adds to the difficulty of this work. When this correction work is carried out by manual labour, it will be obvious that apart from the very considerable amount of time involved, there are many opportunities for errors to occur.

### *Description of Articulation Recorder*

This device has been designed to carry out the recording, checking, and analysing of the listeners' results mechanically with a minimum of effort on the part of the operators. Since in some respects the device replaces the conscious thought of the operators, it has some rather complicated operations to carry out. In this short description, therefore, it is impossible to go into all details, but sufficient information is given to explain the fundamental principles and to demonstrate the most interesting features.

### *Outline of Method of Operation*

Since several hundred packs of cards of the type mentioned in the previous section had

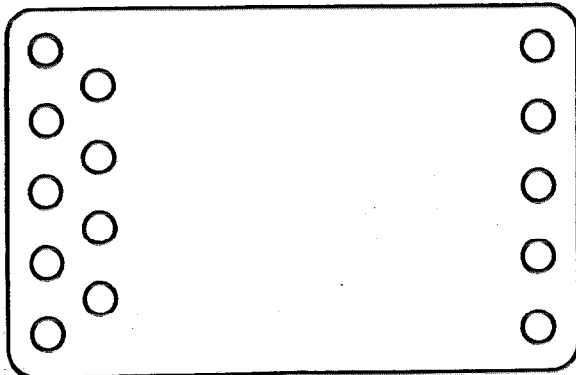

Figure 1—Card with Holes Punched According to a Definite Code.

already been prepared for use in articulation testing before the articulation recorder was developed, it was decided to make use of these same cards for the recorder.

The device is arranged to display the cards of a pack one by one to the caller at the correct rate so that he can call the syllables printed on them. At the same time, it is necessary to communicate to the recording device what each syllable is. This has been done by punching holes in each card according to a definite code. These holes are illustrated in Figure 1, which shows a card punched with three vertical rows of holes. The first row consists of five holes and corresponds to the first consonant of the syllable, the second row contains four holes and corresponds to the vowel, while the last row contains five holes and corresponds to the last consonant. In any given case, of course, only some of the holes in each row would be punched depending on the particular sounds composing the syllable. For syllables of the form consonant-vowel the last row of holes is not used at all, while for syllables of the form vowel-consonant the first row of holes is not used. The reason that only four holes are used for the vowels while five are required for the consonants is that only 15 different vowel sounds are employed in forming the syllables while 22 consonants are used.

The cards are passed through a device arranged so that as each card is displayed to the caller, 14 small contacts are pressed on to the card in positions corresponding to the 14 holes. If a hole has been punched in a card opposite to a given contact, the contact passes through the card and touches an earthed contact on the other side. If no hole has been punched opposite a given contact, the contact merely remains pressed against the card and is therefore insulated from earth.

The further action of the device is illustrated in very much simplified form in Figure 2. Here the card *C* is represented in cross section resting on an earthed plate *P*. Only three contacts are shown and of these the first and third have holes opposite them in the card, thus enabling them to pass through and touch the earthed plate. The second contact has no hole opposite it and therefore remains insulated.

Each contact is connected to the winding of

a relay and an earthed battery is connected in parallel to the other terminals of the relays. Consequently, when a contact is earthed, the relay to which it is connected operates. The first relay has one changeover contact as shown in Figure 2, the second has two, the third has four and, if there were other relays as in actual practice, each relay would have twice as many contacts as the one before. The contacts are connected in the way shown in Figure 2, the final contacts being connected to a series of message registers. The result of this connection is that by operating the appropriate relays it is possible to connect the earthed point *A* to any one of the message registers. In the case shown in Figure 2, in which only the first and third relays are operated, the point *A* is connected to the third message register. Each message register is connected to a corresponding key which, when closed, connects an earthed battery to the message register. These message registers are of the ordinary type used in exchanges for recording the number of subscribers' calls. It will be seen from the diagram that if the key connected to message register No. 3 is pressed, current will flow via the earthed point *A*. The message register will, therefore, pull up and register once. If any of the other keys are pressed, nothing happens since there is no complete circuit.

The operation of the device is as follows: Suppose that the particular punching illustrated in Figure 2 corresponds to the sound  $\bar{E}$ . Then message register No. 3 would also correspond to the sound  $\bar{E}$  and would be marked accordingly. Each of the other message registers would, of course, correspond to one of the other sounds and, in actual practice, there would be 37 message registers to correspond to the 37 sounds, 15 vowels and 22 consonants, employed. The keys are placed in front of the listener and each key is marked with the same sound as the message register to which it is connected. In our example, therefore, the third key is marked  $\bar{E}$ . The card would also have  $\bar{E}$  printed on it and the caller would thus call this sound over the circuit. If the listener receives the sound correctly, he presses the corresponding key, i.e., the third one, and, since by reason of the holes punched in the card the point *A* has been switched to the third message register, a current

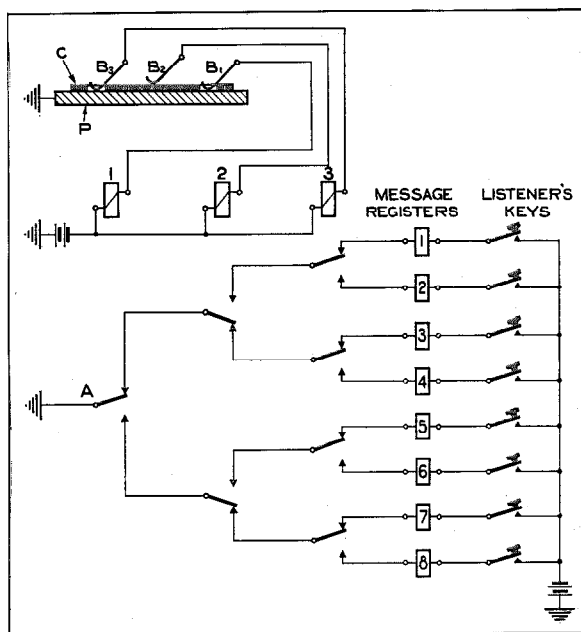

Figure 2—Simplified Schematic of Automatic Device for Recording, Correcting, and Analysing Articulation Results.

will flow and the message register will record once. If the listener mistook the sound  $\bar{E}$  for some other one, e.g.,  $\bar{I}$ , he would press the key corresponding to  $\bar{I}$  and nothing would happen. The result is, therefore, that every time the listener receives a sound correctly and presses the correct key, the fact is recorded on the corresponding message register. By noting the readings of all the message registers before and after a test, it is thus possible to determine how many times each sound has been correctly received. Then, by knowing how many times each sound occurs in the test pack, the percentage articulation can be worked out.

### Electrical Details

A general idea of the fundamental principles of the articulation recorder will have been obtained from the preceding description. In addition, a number of particulars in connection with the electrical part of the device are of interest.

In the actual recorder there are three separate banks of relays connected in accordance with the method illustrated in Figure 2 and corresponding respectively to the first consonant, vowel, and second consonant of the syllable. This is illustrated in diagrammatic form in



Figure 3 where the relays and their contacts are represented by triangles. Connected to each is shown one message register and one key for each of two listeners. This is merely to simplify the diagram; actually, of course, there would be 22 message registers and keys attached to the first bank of relays, 15 to the second and 22 to the third, and there would be this number for each of the listeners. The device is arranged to be extended to eight listeners.

From Figure 3 it will be seen that the message registers corresponding to the different listeners are all connected in parallel to the one set of relay banks, but it will be clear from the connections that the keys of a given listener can only cause his own message registers to operate.

A difficulty occurs in the case of the consonants due to the fact that each listener has only one message register and key for each of the 37 sounds. Since the first relay bank corresponds to the first consonant in the syllable and the third relay bank corresponds to the final consonant, both these banks have to be connected to the same set of message registers representing the 22 consonants. This is shown in Figure 3. Suppose that the points  $A_1$  and  $A_3$  are directly earthed as in Figure 2 and that the syllable *TAK* is called. This may very easily be mistaken for *KAT* by the listener, since *T* and *K* are very easily confused. Then the listener will first press

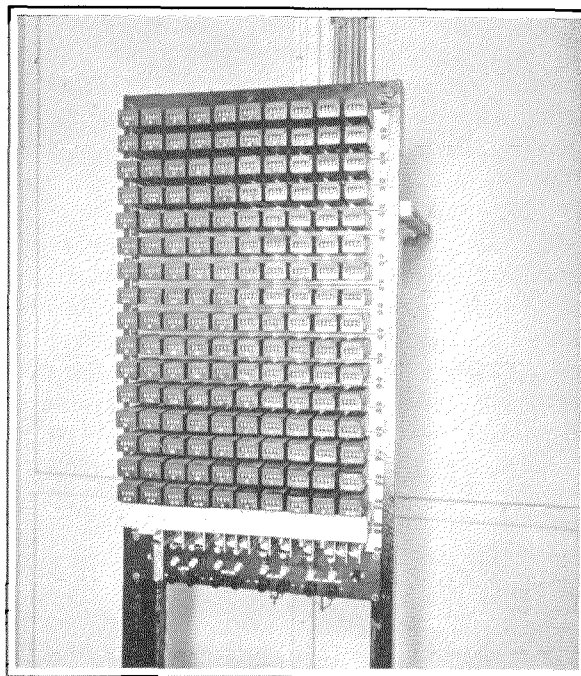

Figure 4—Bank of Message Registers.

his key *K*. There will be no path through his corresponding message register through the first relay bank since this will be set to *T*. But, since the first and third banks are in parallel and the third bank is set to *K*, there will be a path set up through the third bank which will cause the listener's *K* message register to operate. In a similar way, when the listener presses his *T* key for the final consonant this will set up a circuit through the first relay bank and cause his *T* message register to operate. The final result will be that both the *K* and *T* message registers will indicate a correct reception of these sounds although actually the listener got them both wrong.

To avoid this difficulty the points  $A_1$  and  $A_3$  in the relay banks are not connected directly to earth but are connected to earth via a changeover relay, shown as *COR* in Figure 3. This changeover relay normally puts earth on the first relay bank so that the first time the listener presses a consonant key it is checked only through the first bank, and not through the third which has no earth connection.

The syllables are of the form consonant-vowel-consonant so that, after pressing a consonant

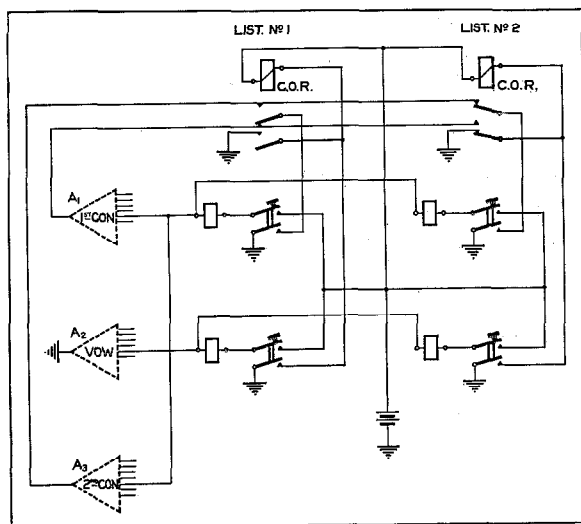

Figure 3—Recorder with Three Separate Banks of Relays Connected in Accordance with the Method Illustrated in Figure 2.

key the first time, the listener naturally presses a vowel key next before pressing a second consonant key. Now all the vowel keys of a given listener have a pair of contacts connected to the winding of that listener's changeover relay. Hence, as soon as the listener presses any vowel key his changeover relay operates and locks up in this operated position. This, therefore, takes the earth off the first relay bank and puts it on the third bank. The result is that the second time the listener presses a consonant key it is checked through the third relay bank, the first bank now providing no through circuit. Hence, although the first and third relay banks are in parallel, the use of the changeover relay operated from the vowel keys ensures that the listener's first consonant is checked with the first relay bank and his second consonant is checked with the third relay bank.

It will be seen from Figure 3 that the earth connections to the first and third relay banks are applied through contacts on the consonant keys. This is because, if the earth connection were applied directly by the changeover relay

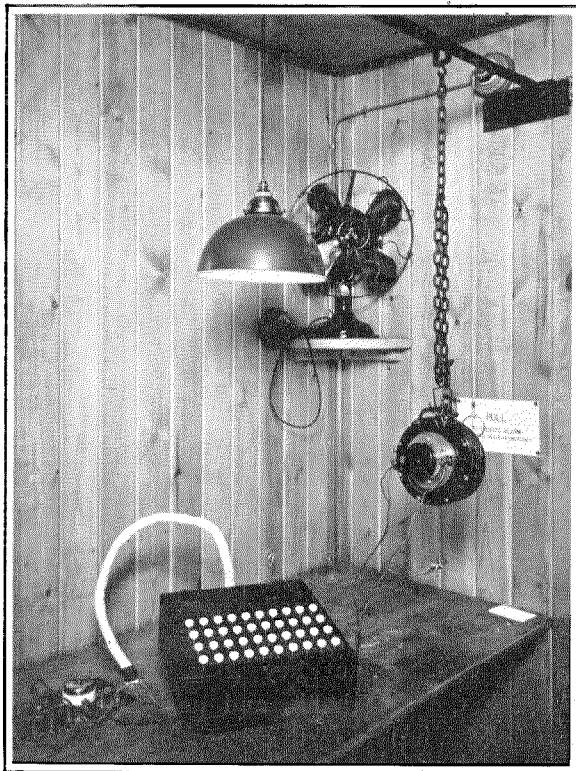

Figure 5—Keyboard Used by Listeners.

and one listener's relay was operated while another's was not, both the first and third banks would have earth connected to them as long as this condition lasted. It would thus be possible for a listener's key to be checked through the wrong relay bank via the earth connection applied by another listener's changeover relay.

In the case of syllables of the type vowel-consonant or consonant-vowel it often happens that, on a bad circuit, the listener thinks that a second consonant was called and thus makes the syllable into the type consonant-vowel-consonant. To record this type of error a message register marked + is connected to that contact in the consonant relay banks to which the point *A* is switched when all the relays are unoperated, i.e., message register No. 8 in Figure 2. If, therefore, a listener presses a consonant key when a consonant is not present in the called syllable, a circuit is set up through the + message register and the latter thus operates.

In order to obtain the average sound articulation for all speech sounds, a message register marked  $\Sigma$  is connected in the common battery lead to all other message registers. This message register, therefore, operates every time any other message register is operated and indicates the total number of correct sounds recorded plus the number of letters added in error by the listener and recorded on the + message register. The reading of the  $\Sigma$  message register minus the reading of the + message register thus gives the total number of sounds correctly received.

A photograph of the bank of message registers is shown in Figure 4. This bank includes the message registers for four listeners with the selecting and changeover relays underneath. In Figure 5 can be seen one of the keyboards used by the listeners.

### *Mechanical Device*

The external appearance of the mechanical device is shown on the left of Figure 6. The pack of cards is placed in a receptacle at the top of the device and the cards are pushed out one by one from the bottom by means of a thin ram and a gate which allows only one card at a time to pass. After being pushed through the gate,

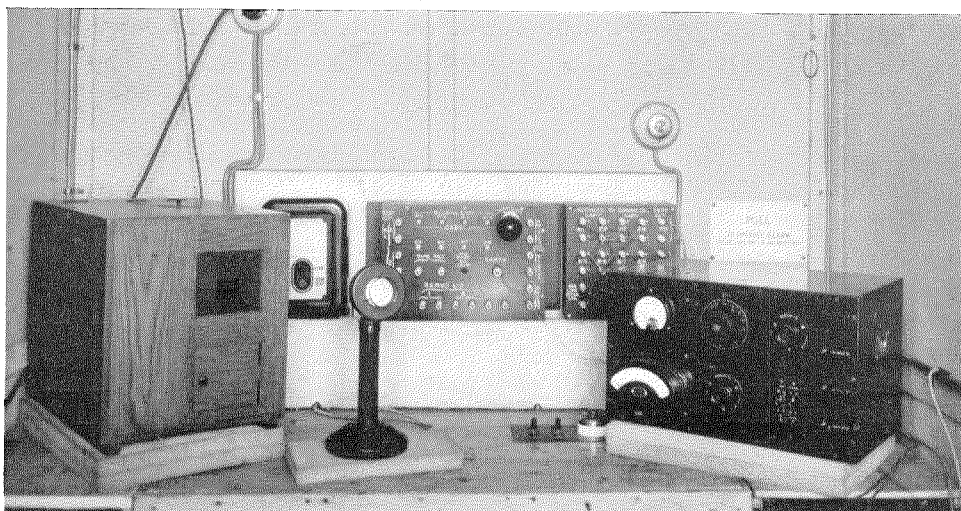

Figure 6—Card Handling Device (Shown at Left)

the card falls down an inclined chute until it reaches a stop. At the correct moment this stop is withdrawn and allows the card to slide further down until it reaches a second stop. While the card is resting on this stop, a plate carrying 14 movable contacts is pressed up against the card so that, where a hole has been punched in the card, the corresponding contact passes through and touches a second contact above the card. These upper contacts are connected to the relay windings of the three relay banks. While this is taking place, a second card has been pushed through the gate and has been held up by the first stop. After sufficient time has elapsed to enable the caller to call the syllable and for the listeners to press their keys, the second stop is removed and the card falls into a second receptacle. The second card then falls into position and the cycle of operations is repeated. The stops and movable contacts are operated by a rotating cam which is driven by the same electric motor that operates the ram. The card, while in position, is illuminated by a small electric lamp and is viewed through a window in the containing box. The box is padded with felt to prevent the sound of the mechanism from interfering with the test.

### *Operation of the Recorder*

The testing routine using the articulation recorder is very similar to that used in an ordinary articulation test. The card handling device is located in front of the caller so that he can see the cards as they appear and at the same time keep his mouth at the correct position with reference to the microphone. The speed of calling is, of course, controlled by the speed with which the cards are passing through the device and this in turn is controlled by varying the speed of the operating motor. The listener, on hearing the syllable transmitted over the circuit which is being tested, merely has to press the appropriate keys.

Before the test is begun the readings of the message registers are noted down and again after the test is finished. In order to save still further time, the message register bank can be photographed before and after the test in order to obtain a record of their readings. In order to check the correctness of the whole recorder operation a special test pack is put through at the beginning of each day. This pack contains all the sounds in a definite order known by the listeners, so that as each card of this pack passes through the card handling device, the listeners are able

to press the correct keys. If the device is operating correctly, there should be no mistakes indicated at the end of the check test. At first, of course, slightly more effort is required by the listeners when using the recorder since, instead of merely writing down the syllables, they have to look for the correct keys to press. In actual practice, however, it has been found that the listeners very soon become accustomed to the keyboard and very much prefer its use to the old method of writing down the results.

### ***Conclusions***

The use of this articulation recorder, by reducing the amount of effort required by the caller and listeners, enables them to carry out the test with less fatigue and, therefore, with greater accuracy. The really great advantage of

the device, however, lies in the fact that the moment each test is finished the results are produced completely corrected and analysed. It is estimated that to carry out this work by manual labour would require about 20 man-hours for each complete test with a crew of nine operators. This means that, in addition to the heavy cost of this work, there is always considerable delay in the production of the final results. By the use of the articulation recorder both this cost and the delay are avoided and, since both the correction and analysing are carried out entirely automatically, the errors which inevitably occur with manual labour are avoided. Thus, the recorder has been of very material assistance in enabling the laboratories to establish a satisfactory technique for the accurate measurement of articulation.

# Modern Loading Equipment

By J. B. KAYE

*International Standard Electric Corporation*

EDITOR'S NOTE: *Because of lack of space this paper is printed in part in this issue and will be concluded in the April issue of ELECTRICAL COMMUNICATION. The part now printed deals primarily with loading coils; the remaining part will deal with loading coil cases.*

THE object of this paper is to give a general description of the equipment being used for the loading of telephone cables in Europe, and to trace briefly the lines along which the present product has been developed as well as to indicate the relationship which it bears towards transmission problems.

The history, theory, and general principles of the subject are fully dealt with in the now classic paper<sup>1</sup> presented by T. Shaw and W. Fondiller at the A. I. E. E. convention in February, 1926. Other literature on the subject is given in the bibliography at the end of this article.

## Elementary Design

In order to follow the various stages of evolution resulting in present day equipment it is necessary to have some knowledge of the general principles of practical design, and the following paragraphs are intended to give briefly an indication of some of the salient features.

It is not possible to set down a rigid method of design since the line of attack to be followed in any case is dependent upon the form in which the final result must be delivered. Thus it may be necessary to produce a coil of fixed dimensions, a coil of defined electrical characteristics, or a coil having the most economical combination of both those factors, and in none of the three instances is it possible to follow the same design procedure. It should be remembered, therefore, that the following design features do not occur in any fixed order but must be looked upon as a group having complete mutual relationship in which the complete definition of any one member puts certain limitations on the other members.

As is well known, a loading coil consists of a toroidal shaped core of magnetic material upon

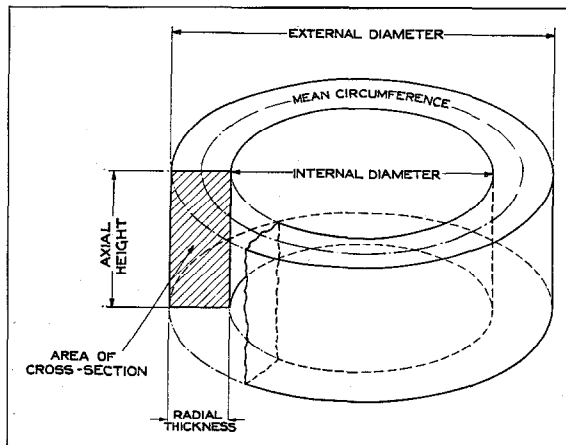

Figure 1—Loading Coil Core Dimensions

which the windings are placed in the necessary inductive relationship.

The effective permeability of the magnetic material of a core of given dimensions defines the number of turns of wire which are required to attain a given inductance value.

The iron losses occurring in the core when an alternating current is applied to the windings, increase both with increase of current and frequency.

Since the permeability and iron losses are intimately related, an increase in permeability generally being accompanied by an increase in the iron losses, it is necessary to ascertain the maximum iron losses permitted when the coil is in operation and then to use a material having the highest possible permeability under the required conditions.

If a suitable material of known permeability is available the next step is to choose convenient core dimensions only two of which have any influence over the electrical characteristics of the coil. These are the mean length of magnetic circuit which corresponds approximately to the mean circumference of the toroid and the area

<sup>1</sup> "Development and Application of Loading for Telephone Circuits," *Electrical Communication*, April, 1926.

or cross-section of magnetic material enclosed by a turn of winding. (See Figure 1).

Since the circumference is of fixed dimensions the only radical changes which can be made in the shape of a core are those of the perimeter enclosing the cross-section.

In order to enclose the maximum area with the shortest turn of wire around the core it is obvious that the best shape for the perimeter would be a circle, but practical considerations at times preclude the use of such a core; for example, if the core material gives its best performance when built up in laminated form the only feasible shape is rectangular or, if the external and internal diameters of the wound coil are limited owing to exigencies of horizontal space, it may be necessary to increase the length of core section in an axial direction.

One of the most useful assumptions which may be made regarding core dimensions is that, provided the ratio of mean circumference to area of cross-section is kept constant, the number of turns required to secure a given inductance remains constant no matter what volume of core

material is embodied in the core. Still more important, within certain practical limits, is that no change takes place in the direct current resistance of the complete winding. The reason for the latter occurrence is that although it may be necessary to reduce the wire gauge in order to accommodate the required number of turns of wire on a smaller core, the total length of wire required is also reduced and the effects on the direct current resistance approximately annul each other.

The limit of the above assumption of constant direct current resistance is reached when the ratio between the area of copper and of insulation which together comprise the total area of cross-section of the winding material, begins to vary by an appreciable amount.

From the preceding it would appear possible to construct coils of small dimensions limited only by the design of the winding machine and the ability to prepare wire having a sufficiently thin coating of insulation. Unfortunately such is not the case.

As the area of cross-section is reduced, the

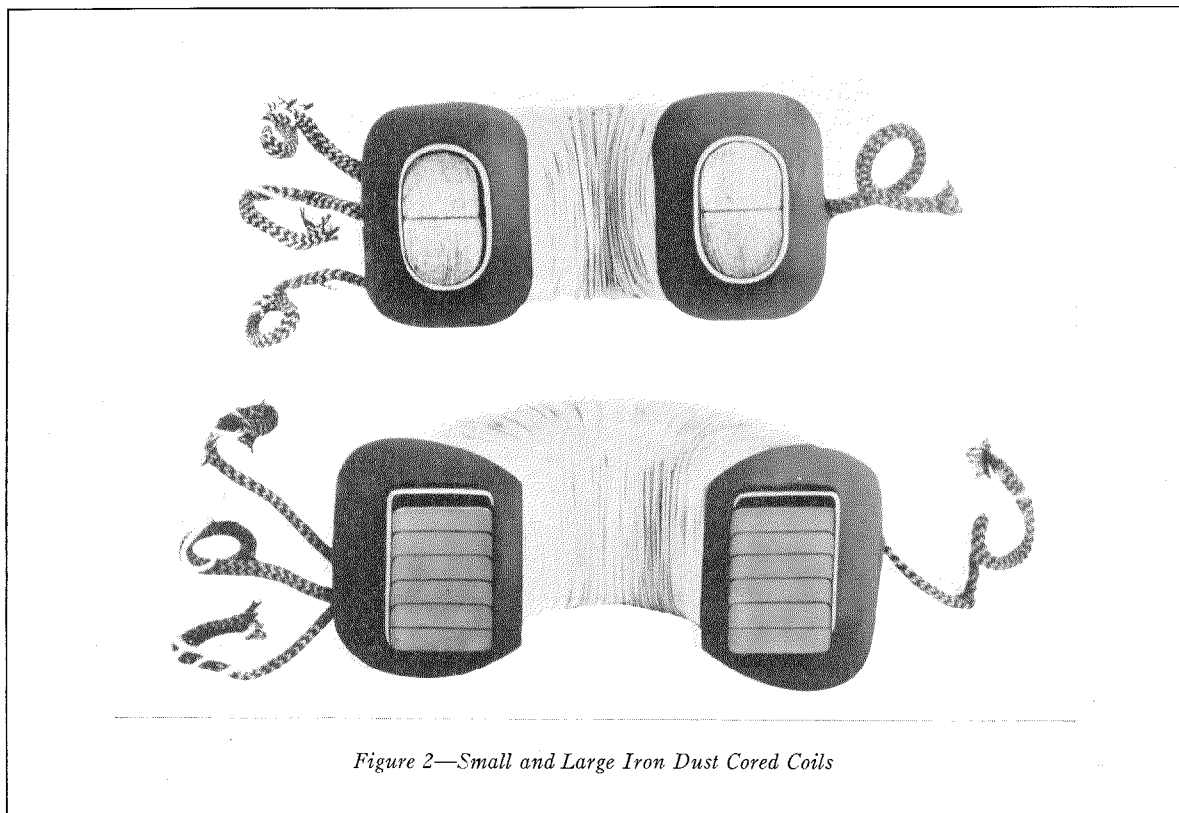

Figure 2—Small and Large Iron Dust Cored Coils

flux density in the core material increases and is accompanied by increased iron losses in the core. These losses are evidenced first by an increased rate of change of effective resistance with change of operating current and finally by a complete magnetic saturation of the material, thus rendering the coil inoperative. At the same time the rate of change of effective resistance with frequency increases.

### *The Evolution of Different Types of Coils*

Apart from the well-known German product, fully described elsewhere, the loading coils used in European cables up to the end of the year 1925 had been identical with those manufactured and used in the United States of America.

Towards the end of 1925 the British Post Office announced its intention of loading exchange area cables and, since no phantom circuits were to be used, the coils for the purpose were not required to have the same standard of electrical precision as those used for the side circuits of long-distance phantom circuits, whilst the lower grade of transmission required on the exchange area circuit enabled this depreciation in electrical quality to be still further extended.

There were, however, two very important factors to be secured on the coil: first, it had to be cheap in order to merge economically into the exchange area cable system and, second, it had to be small in order to permit the installation of a large number of coils in the restricted space available in city manholes.

The limitation of cost at once emphasised the difference existing between the European and American values for the ratio of cost of labour to cost of material. In other words, assuming that the coil dimensions had reached a stage such that any reduction therein required increased time of manufacture, then the most economical coil produced in Europe would have different dimensions from those of the equivalent coil produced in America.

As the result of preliminary cost study, an exhaustive study of coil design was undertaken with particular reference to European conditions. The limited time available for the completion of the coil did not permit extending the investigation into the field of core materials so that the

choice was limited to the materials already at hand and fully described in a paper<sup>2</sup> by B. Speed and G. W. Elmen.

After the survey of trial designs it was considered advisable not to deviate from the standard compressed iron dust material referred to in the above paper as the Grade "B" type and having a permeability of 32. With this material as a basis the final design gave a coil having a volume of approximately two-thirds of that of the normal side circuit coil in general use. A comparison of the two coils is seen in the sectional view of Figure 2.

This coil was put into operation and found very satisfactory with a tendency, if anything, to be more efficient than necessary. The latter point was investigated and found to be due to the fact that, notwithstanding an increase in flux density, the corresponding increase in the total iron losses per unit volume had been practically linear; furthermore, since the volume of magnetic material had been reduced, the total iron losses for the coil compared favourably with those obtained on the standard side circuit coil.

Now the main structural difference between the exchange area coil and the long distance side circuit coil was that the latter had the balanced windings essential to phantom group working but unnecessary for the purpose for which the smaller coil was intended. Full advantage had been taken of the increase brought about in the effective winding area by the use of a simple winding but it was believed that the technique of winding had not been extended to its limit and it might be practicable, therefore, to produce a coil identical in size with the exchange area coil but with balanced windings. It was found possible to construct such a coil without much difficulty and its properties were found to be very little different from the larger side circuit coil apart from the increased flux density under which it would have to operate.

The transmission characteristic which is most affected by the use of coils working normally at a high flux density is that of the sensitivity to interference from a superposed circuit. Hence, the possibility of using the small balanced coil

<sup>2</sup> "Magnetic Properties of Compressed Powdered Iron," *Proceedings A. I. E. E.*, June, 1924.



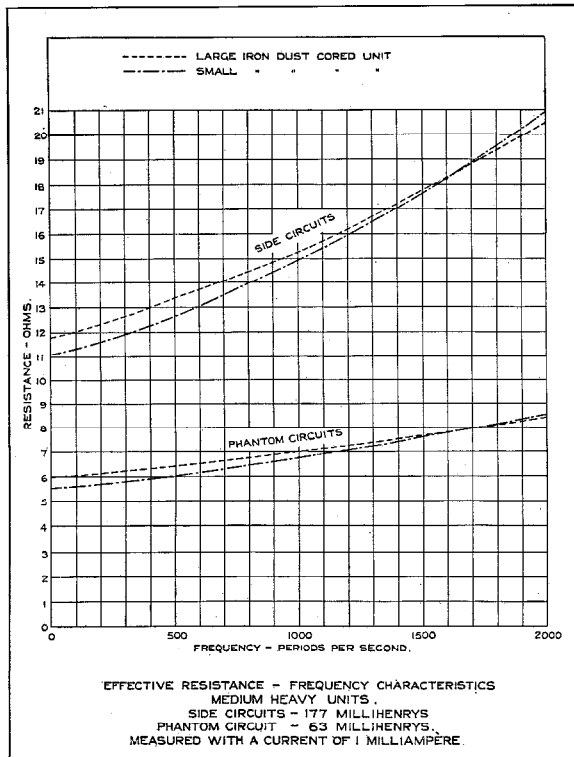

Figure 3—Effective Resistance—Frequency Characteristics Medium Heavy Units

under conditions of superposed currents was considered with a view to associating it with a phantom coil so as to provide a unit which would replace the large unit in use at the time.

The large unit had been designed not only when little was known about the methods of studying superposed current effects but also when the actual values of superposed currents in composite circuits could not be specified with any degree of certainty as to future requirements. Since composite circuits were certain to increase, any attempts at size reduction had to be sacrificed to the unknown, and the volume, which is approximately proportional to the inverse of the squared flux density, had therefore to be given a value such as would provide an ample factor of safety in this respect. However, at the time when the results on the smaller coil were indicating its unexpected efficiency, much more information was available both on the effects of superposed currents and their probable maximum values.

As a result of a study of these factors it was evident that the increase of flux density due to

the reduction in volume together with the increase due to the probable maximum superposed current would result in an operating flux density which was still insufficient to produce undesirable modulation effects.

A small phantom coil was designed to work along with the balanced side circuit coils which had been evolved from the exchange-area coil, and the resulting unit of one phantom and two side circuit coils had a volume approximately two-thirds that of the unit then being used for long distance cables. The two curves in Figure 3 show the characteristics of a medium-heavy unit of this type alongside those of the unit which it replaced whilst Figures 4 and 5 show the relative dimensions of the units and of cases containing equivalent quantities of units.

The small unit when in operation justified the faith which had been placed in its ability to replace the larger unit in every respect.

There is one point which is worthy of emphasis and that is that the sensitivity of a coil towards superposed currents is in no way directly connected with its ability to recover its initial condition after a sudden magnetic shock or some temporary abnormal magnetic conditions. Such recovery ability appears to be an inherent property of the material composing the core and has no connection with the mechanical dimensions of the core except in so far as a core of small volume naturally attains a condition of complete saturation sooner than a larger core. After the saturated condition has been reached the period of recovery is practically the same in either case.

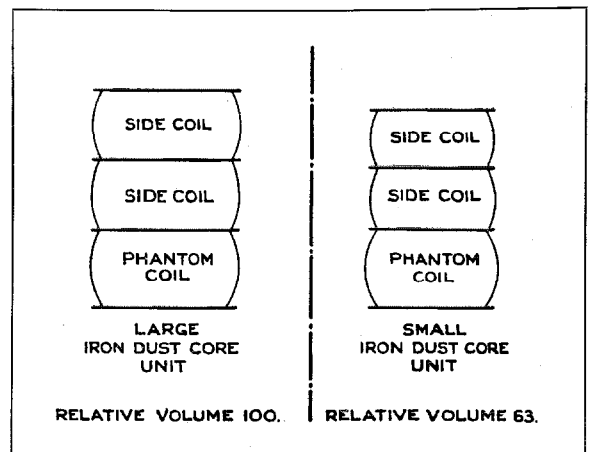

Figure 4—Comparative Sizes of Iron Dust-Cored Loading Units.

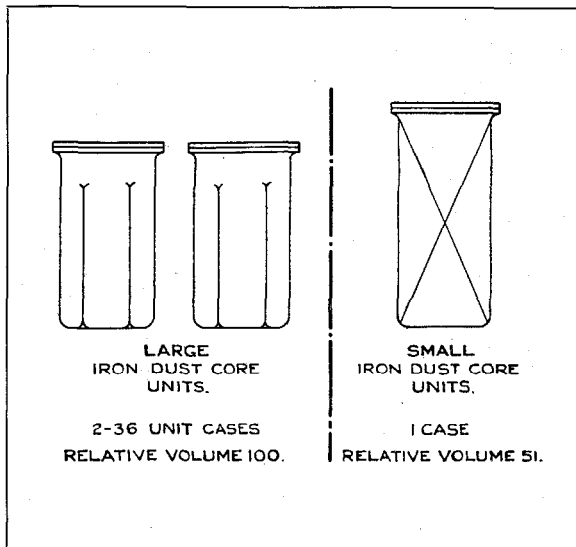

Figure 5—Comparative Sizes of Equipment for Encasing 72 Loading Units of Iron Dust Cored Types.

Thus, from a standpoint of magnetic stability, both the units referred to were identical. During the period existing between the inception of the new unit and that stage of development required for use in the field another problem connected with the loading unit was being attacked, namely, that of crosstalk, it having been felt for some time that the crosstalk added by the loading equipment to a complete system was excessive as compared with that added by the other units of the system. The method of attack was to isolate the individual sources of crosstalk, to investigate the most suitable means of measuring the crosstalk emanating from each source and finally to devise equipment and technique whereby the causes of crosstalk could be avoided or annulled by means of auxiliary equipment.

The sources of crosstalk may be divided into three distinct groups, namely, inductance unbalance, resistance unbalance, and capacity unbalance. The resultant crosstalk is eliminated as far as possible by winding construction, by selection, and by auxiliary apparatus.

The decrease in crosstalk resulting from the application of the new procedure was found to be considerably greater than had been anticipated, not only for near-end but also for far-end crosstalk, since the method of reduction was simultaneous in its application to both directions of interfering noise between circuits. A glance at

the following table will indicate the improvement attained.

AVERAGE VALUES OF CROSTALK FOR A NUMBER OF LOADING UNITS

	Medium-Heavy Units		Extra-Light Units	
	Old Method	New Method	Old Method	New Method
<i>Phantom to Side Crosstalk</i> within units.				
Near End....	27.9	11.1	24.5	8.9
Far End.....	56.0	12.0	49.0	9.2
<i>Side to Side Crosstalk</i> between all adjacent circuits.				
Near End....	11.2	4.0	9.7	3.4
Far End.....	....	3.8	....	3.6
<i>Phantom to Phantom Crosstalk.</i>				
Near End....	11.4	3.0	12.6	4.2
Far End.....	....	4.1	....	4.2

The medium-heavy units have inductance values of 177 millihenrys for the side circuits and 63 millihenrys for the phantom circuits, the corresponding values for the extra light units being 44 millihenrys and 25 millihenrys.

Unfortunately the information on far-end crosstalk for the older units is not complete but it may be assumed to be comparable in value with the near-end crosstalk for the same circuit.

The values in the table are given in terms of units of crosstalk, one unit being defined as one-millionth of the current flowing in the disturbing circuit. Assuming the impedances of the disturbing and disturbed circuits to be equal with four units of crosstalk between two correctly terminated circuits, the disturbing current in the disturbed circuit will be four-millionths of the total current in the disturbing circuit.

The above crosstalk values which cover sufficient measurements to produce reasonably average figures were obtained at a frequency of 800 p.p.s., with a current of 10 milliamperes flowing in the disturbing circuit. Not only do these values emphasise the improvement in the product itself but they are also indicative of the improvement which has taken place in the apparatus used for measuring the crosstalk in that product. Factory testing is now carried out to the nearest unit of crosstalk whereas in the past it was not possible to measure more accurately than to the nearest five units of crosstalk.

In addition to refinement of the apparatus used for the final measurements of crosstalk, it was necessary to evolve entirely new apparatus for the factory measurements of the electrical components causing crosstalk in order to enable their direct annulment without recourse to trial and error methods and consequent waste of time.

The new unit and the new method of crosstalk reduction were completed simultaneously thereby providing equipment which has the same general characteristics as that in immediate use but possessing the two advantages of reduced dimensions and lower crosstalk. It will therefore be seen that a stage had been reached in Europe at which, using existing materials, the most economic unit had been produced.

Only three things could occur to upset the economic equilibrium thus secured, these being, a change of considerable magnitude in labour conditions, a change in the requirements of the telephone system, and a change in the electrical properties of the materials from which the coils were constructed.

The first factor was unlikely to happen, the second gave no indication of change, and the only possibility of variation lay, therefore, with the third. Fortunately a change in the latter factor was forthcoming in the most fundamental feature of the coil, namely, the core.

### *Loading Coils with Permalloy Cores*

Experience in the use of pure iron dust as a core material over a period of twelve years had indicated that it was unlikely that any revolutionary changes in its permanent electrical properties could be secured either by treatment or mechanical mixture, but about the year 1921 it was discovered that one of the nickel-iron alloys possessed remarkable magnetic properties. The alloy in question known as "Permalloy" was found to have an exceptionally high permeability and small hysteresis losses at low magnetising forces such as prevail in telephone work.

While certain magnetic properties were emphasised, it was unfortunately found, as might have been expected, that the effects of external changes such as heat and mechanical stress were also very much in evidence so that the material as at first produced was unsuitable as a commercial substitute for magnetic iron.

As the result of research work in the Bell Telephone Laboratories, a technique was developed whereby it was found possible to use the new alloy for continuous or Krarup loading, which consists of wrapping a magnetic material around the copper conductor in a cable and thus increasing the magnetic field around the conductor. Owing to the fact that it is possible to add only a small value of inductance by means of continuous loading, such a practice is uneconomical except for submarine cables where it is impractical to use coils in cases at extreme ocean depths.

Up to 1924 magnetic iron had been the only suitable material available for continuous loading and owing to the very small inductive effect it had not proved a success economically. With the inception of permalloy, however, the situation was completely changed and it was found possible to construct cables capable of working at three times the telegraph speed attained in the past. The first permalloy loaded cable was laid in 1924 between New York and the Azores.

The next step was to investigate the application of permalloy to the cores of loading coils. It is of interest to note that this was practically the first instance in the evolution of loading coil development which was brought about by the occurrence of an external factor as distinct from a demand for development as a result of system requirements.

Compared with iron dust core material the homogeneous permalloy possessed two superior features and one disadvantage, namely, the hysteresis losses were lower and the permeability was greater but the ability to withstand permanent change as the result of magnetic shock was very much less. This last factor precluded the use of the straight metal.

In view of the degree of success obtained with compressed iron dust cores it was reasonable to suppose that compressed permalloy dust cores would offer a promising line of development and this supposition was fully realised.

Although a permalloy dust core, as in the case of an iron dust core, consists essentially of magnetic particles individually coated with an insulating covering, both the sources and the treatments of the two metals are widely divergent.

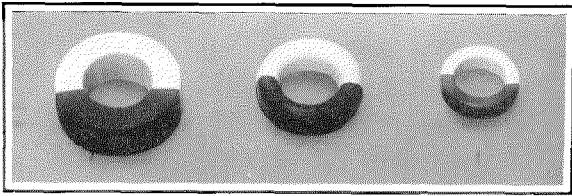

Figure 6—Comparative Sizes of Large Iron Dust Core, Small Iron Dust Core, and Permalloy Dust Core (Stanelec).

One of the major requirements for the comminution of a material is that it should be brittle. In the case of iron it was obtained in a brittle and pure condition by means of electrolysis but in the case of an alloy such a method is obviously impracticable. With permalloy it was found necessary to resort to pouring without deoxidising and to hot rolling in order to obtain the material in a suitable condition for attrition.

To produce a unit suited to European conditions, work was begun in England on the basis of the preliminary investigations on permalloy dust carried out in America. The permeability of the material was made as high as possible without increasing the iron losses beyond the limit set by the requirements of the system.

It was found possible to use a material having a permeability more than twice the value of that used for the iron dust cored coils although, as might be expected, the use of such a high permeability material called for a careful control of its manufacture and a close watch on the quality of the raw materials involved.

The unit was known as the "Stanelec" No. 1,

and in volume was approximately one-third of that of the smallest iron dust cored unit produced in Europe whilst its entire weight was approximately equal to that of the cores of the American permalloy dust cored unit.

Figure 6 shows the relative sizes of side circuit coil cores of the large iron dust type, the small iron dust type, and the permalloy dust type (Stanelec). The relative dimensions of the associated phantom coil cores are similar.

The electrical characteristics of the Stanelec unit are an improvement over those of any unit hitherto produced for use on the same transmission systems.

One of the most marked features has been the lack of susceptibility to magnetic shock, although the straight permalloy is much more sensitive to such treatment than is pure iron. Permalloy dust cores have a susceptibility approximately one-fifth that of the iron dust cores. The graph in Figure 7 shows a comparison of the behaviour of the two types of core when subjected to a complete magnetic cycle, the maximum current passed through the coil windings being approximately 3 amperes.

Figures 8 and 9 give comparisons of the effective resistance versus frequency characteristics for medium-heavy and extra-light units, respectively, for the three types of unit already discussed, namely, the large iron dust cored unit as used in both Europe and America, the small iron dust cored unit peculiar to Europe

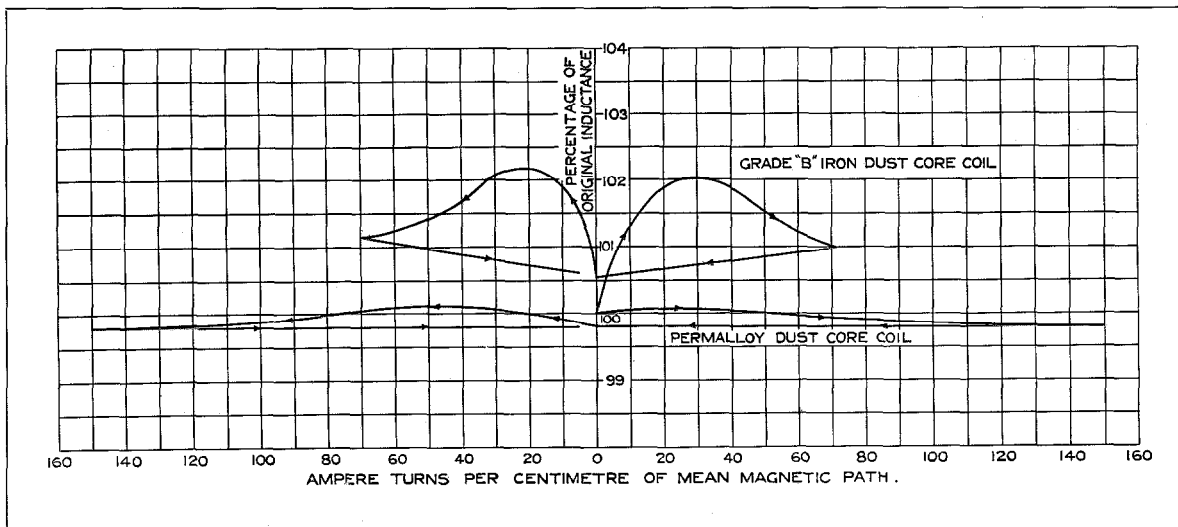

Figure 7—Residual Effect of Direct Current Magnetisation on Iron Dust and Permalloy Dust Core Loading Coils.

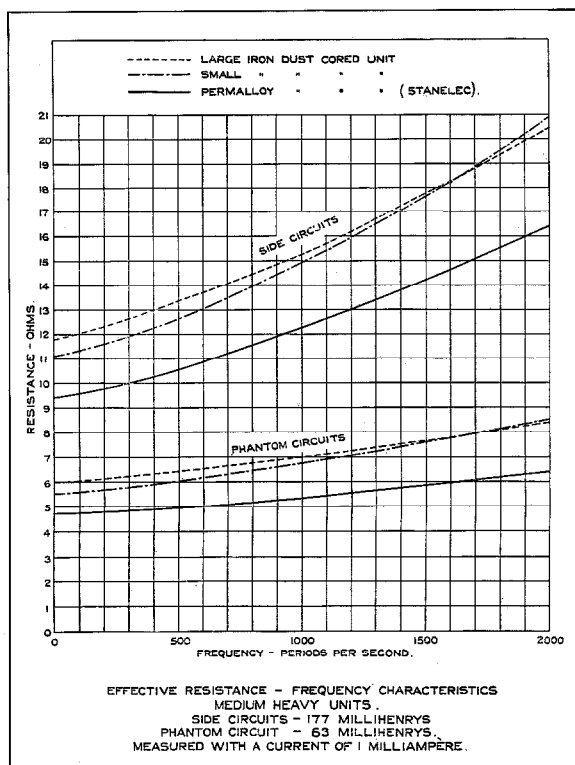

Figure 8—Effective Resistance—Frequency Characteristics Medium Heavy Units.

and the Stanelec permalloy dust cored unit for use in Europe. It will be seen that whilst the curves for the medium-heavy iron dust cored units are substantially coincident, that for the Stanelec unit indicates markedly lower values of resistance together with a somewhat less steep gradient.

It would, of course, have been possible to have reduced the size of the Stanelec medium-heavy unit still further thereby permitting the effective resistance characteristic to approach that for the iron dust cored units which it was replacing, but this would have necessitated the use of cores different from those intended for the Stanelec extra-light unit, a course presenting a great disadvantage when viewed from the standpoint of production on a large scale.

This difference in dimensions between the most economic type of unit for extra-light and medium-heavy circuits appears contradictory to the statements already made regarding the relationship between the inductance and resistance for toroidal coils, but it should not be forgotten

that those statements were qualified by reference to the limiting effects of the ratio between copper and insulation areas. It is such an effect which has now come into play owing to the small dimensions of the Stanelec coil. Figure 10 gives a comparison of the relative volumes of the units in question from which this point will be readily appreciated.

It would appear that in so far as long distance coils are concerned the reduction in coil size has reached a stage at which any further attempts at reduction would unduly emphasise production costs and probably necessitate winding machine re-design as distinct from a modification of existing machines.

It may be of interest here to note the effect of reduced coil dimensions on encasing facilities. Figure 11 gives a proportionate comparison of the equipment required to encase 72 units. The volume reduction is sufficiently evident to render further comment unnecessary. The actual details of the cases are given hereinafter. Figures 12 and 13 show the winding machines used for the coils together with the belt conveyor used for carrying the coils.

Returning to the electrical characteristics of the equipment one of the most important features of the permalloy dust cored coils from the manufacturing viewpoint is the manner in which the coil inductance behaves throughout the

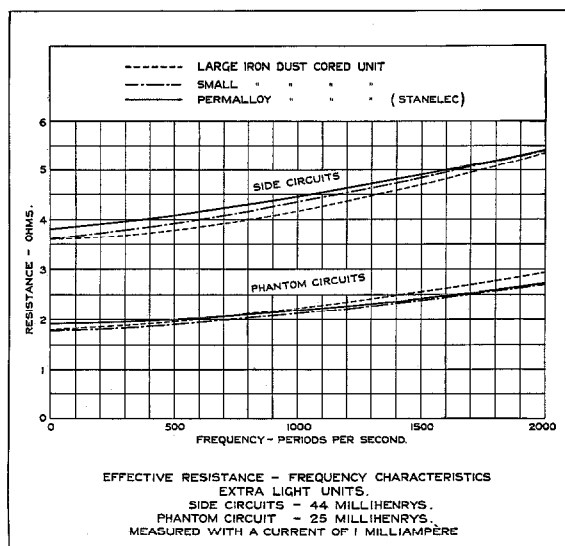

Figure 9—Effective Resistance—Frequency Characteristics Extra Light Units.

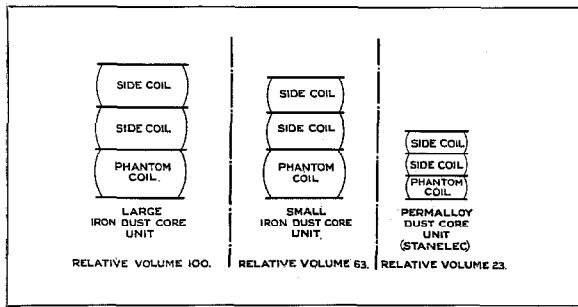

Figure 10—Comparative Sizes of Iron Dust and Permalloy Dust Core Units.

various stages of manufacture. During manufacture, particularly in the final stages, the coils are subjected to processes which may produce magnetic changes in the cores and give rise to a change in inductance. Such variations in the iron dust cores were not only fairly wide but to a certain extent were unpredictable in tendency.

In the case of permalloy dust cores the corresponding variations are very much smaller and may be predicted with accuracy thereby enabling the inductance of the coil in its final stage to be secured within very much closer limits than formerly, an advantage which was at once apparent in the singing point characteristics of the first cable to be loaded with these coils. Furthermore, after subjecting a permalloy dust cored coil to various temperature changes the inductance returns to its initial value along with the temperature, a feature rarely met with in the case of the iron dust cored coils. Similarly the change of effective resistance with temperature is less marked in the case of the permalloy dust cored coils, but since this characteristic is limited only by a maximum value it is not one of any great practical importance even if indicative of an improved product.

Another feature in which the Stanelec coils show an improvement is that of crosstalk. Two factors have been mainly responsible: first, the reduced dimensions of the coils give rise to less capacity unbalances between the associated circuits in the unit; second, the use of a core material of higher permeability restricts the boundary of the stray magnetic fields external to the coil.

In order that the reader may get a clearer view of the chief electrical characteristics desirable in loading equipment, it may be advantageous to enumerate them as in a typical

guarantee for a Stanelec loading unit, but before so doing the general aspect of guarantees will be discussed.

### Guarantees

In fixing the electrical guarantees for loading equipment there are three main controlling factors: first, the characteristics defined by the transmission system in which it is to be used; second, the competitive aspect; third, the standpoint of manufacture.

In the early days of loading the system requirements were confined almost entirely to the two most fundamental features, namely, the inductance of the coil and its effective resistance. Later, the introduction of the repeater emphasised certain other features which have become more important as the lines have been made longer and quality improved, until the present requirements make quite formidable reading when compared with those of the past.

Unfortunately of late years there has been a tendency for the loading equipment to be looked upon as a separate entity distinct from the associated apparatus of the system, a state of affairs which has probably been brought about by the commercial separation of the various groups of apparatus.

This outlook has resulted in the competitive emphasis of certain features in which an improvement may be quite valueless from the system aspect, thereby leading to a false evaluation of quality. From the factory standpoint any reduction of tolerance whatsoever is looked upon as an arduous infliction; nevertheless, the reaction is not without legitimate reason for it should be

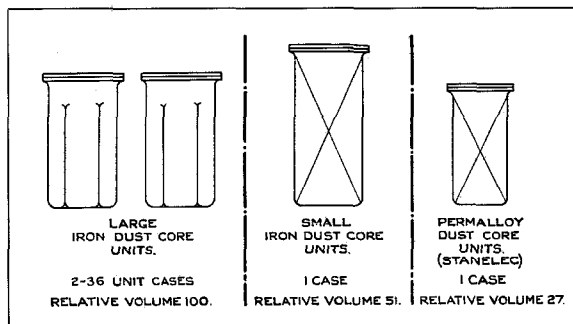

Figure 11—Comparative Sizes of Equipment for Encasing 72 Loading Units of Iron Dust and Permalloy Dust Core Types.



Figure 12—Coil Winding Room.

remembered that the factory deals with the product in vast quantities and the testing must be carried out with sufficient rapidity to maintain the output and with only sufficient accuracy to maintain a consistent quality by the rejection of abnormalities.

Furthermore, there should be sufficient latitude to allow for process modifications without the breaking of any stipulated limit. As an example, take the question of inductance balance between the two lines of the side circuit of a unit and between the two arms of the phantom circuit of a unit. The respective maximum limits for the two circuits are 0.1 percent and 0.25 percent of the total aiding inductance of the circuit under test. It would not be very difficult from the manufacturing standpoint to reduce those two values by a half in each instance, but it is found that such a reduction affects the crosstalk adjustment to the extent of increasing the crosstalk values by an amount sufficient to be apparent in the average crosstalk of all the circuits in the case but insufficient to come within appreciable distance of the maximum limit.

The two values already quoted for unbalance

maxima are such as to leave an ample margin as regards system requirements whilst any reduction in crosstalk is always a desirable feature, and it is evident that by permitting factory latitude on the unbalance there has been a resultant improvement in one of the most important features.

From the foregoing it will be seen that the most suitable guarantees are those which will enable the system requirements to be met with sufficient latitude to permit facility in factory testing and slight engineering or factory modifications, at the same time giving due regard to those features which have a direct bearing on the transmission results.

In dealing below with each individual item which forms the subject of a guarantee for loading units, comments are made both on the transmission aspect and method of attaining the stipulated value. The values quoted are intended to apply at a nominal temperature of 15° C.

(a) *Inductance.*

The inductance of any circuit will not deviate by more than  $\pm 1\frac{1}{2}\%$  from the nominal value when measured at one frequency, either 800



p.p.s. or 1,800 p.p.s., with a current of 1 milli-ampere.

It is, of course, desirable from the attenuation standpoint to maintain the inductance standard as close as possible to the International standard unit, but it is still more desirable to maintain the inductance of the coils as uniform as possible throughout a repeater section, in order to avoid impedance irregularities in the line.

The magnitude which the manufacture of coils has reached is such as would necessitate the maintenance of sub-standards to a prohibitive degree were any attempt made to work to an International standard unit having laboratory accuracy. Furthermore, any practical advantage accruing from such a practice would be appreciable only in the event of coils manufactured in separate non-co-operative factories being installed on the same repeater section, an occurrence rare enough to be neglected. However, even if it were the case, the effect upon attenuation due to departure from standard would be limited to the effect of the difference between the square roots of the two inductance values and not to the direct values.

The method of controlling accuracy in the factory is to have factory standards which are referred periodically to an International standard

and daily to the factory sub-standards; this method has been found to be reasonably accurate in practice, especially since careful watch is kept on corrections for temperature. Uniformity is obtained by a highly developed technique which controls the inductance at all stages of manufacture, the manufactured product always lying well within the guaranteed tolerance.

(b) *Inductance Balance.*

The difference of inductance between the two lines of a side circuit of a unit will not exceed 0.1% of the inductance of the complete circuit. Similarly, the difference of inductance between the two arms of the phantom circuit of a unit will not exceed 0.25% of the inductance of the complete circuit. The tests are made at the same time as the inductance and for convenience are carried out at the same frequency.

The effect of loading coil inductance unbalance on the system is to render it susceptible to interference from sources external to the system.

The values quoted above as maxima are considerably less than the limits which would prove undesirable in practice, whilst the values actually obtained as averages for the coils are approximately half those given as guarantees.

The balance is obtained in the factory by care in winding and by manipulation. Reference has

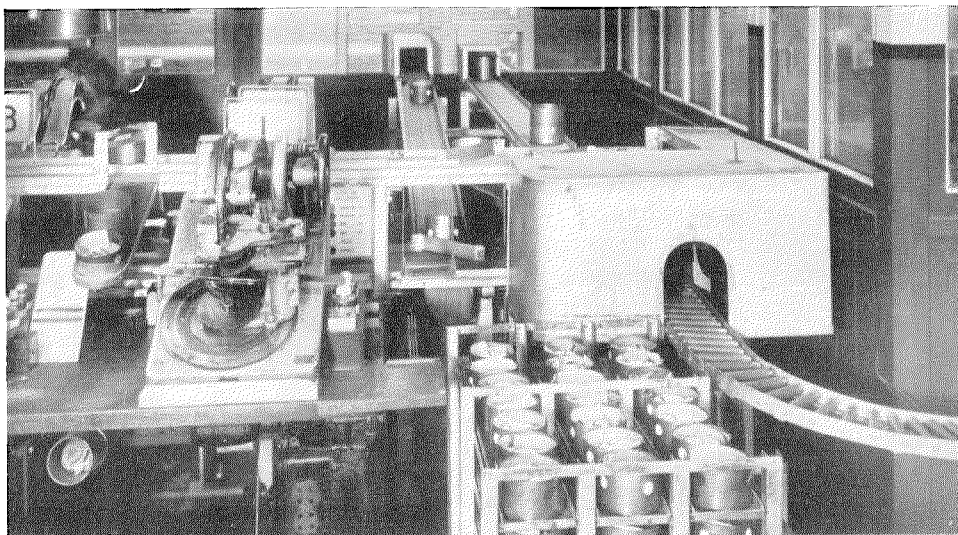

Figure 13—Coil Winding Machines and Belt Conveyor.

already been made to the reaction of inductance balance upon the crosstalk adjustments. The lay-out of a factory coil balancing room is shown in Figure 14.

(c) *Resistance.*

The values of resistance under the conditions indicated will not exceed the values given in the following table:

MEDIUM-HEAVY UNIT 177/63 MILLIHENRYS

	Side Circuit	Phantom Circuit
Maximum Direct Current Resistance.....	11.4 ohms	5.7 ohms
Maximum Effective Resistance at 800 p.p.s. and 1 milliamperere	15.0 ohms	6.5 ohms
Maximum Effective Resistance at 1800 p.p.s. and 1 milliamperere	20.5 ohms	8.0 ohms

(NB. On comparing the above figures with average values already shown graphically, it should be noted that the latter do not include any allowance for auxiliary wiring in the case.)

The values given above are defined by the attenuation permitted in the system and are secured in the fundamental design of the unit, as described at the beginning of this paper. Since the values depend upon the dimensions of the coils and upon the characteristics of the core material, abnormalities can only occur through the development of a distinctive fault and the factory control is one of rejection.

By quoting the direct current resistance maximum together with two maxima of effective resistance at two separate frequencies, the degree of attenuation is defined together with an approximate definition of the maximum variation of effective resistance with frequency, a factor which should be kept small in order to avoid frequency distortion in the loaded line.

The factory tests for direct current resistance and for effective resistance at one frequency are carried out on every circuit together with occasional tests at the other frequency. The frequency chosen for testing every circuit is that which is stipulated for the inductance measurement since the two tests are carried out at the same time. Complete tests at the other frequency are unnecessary since any fault which causes an effective resistance reading to exceed the maximum does so by a large margin and leaves no doubt as to the inability to fulfill tests at the other frequencies.

The frequency of 1,800 p.p.s. is preferable to a lower frequency owing to the fact that the higher pitched tone enables the operator to adjust the measuring set to a null point with greater accuracy and rapidity.

(d) *Direct Current Resistance Balance.*

The difference of direct current resistance between the two lines of a side circuit of a unit will not exceed 0.1 ohm.

The difference of direct current resistance between the two arms of the phantom circuit of a unit will not exceed 0.2 ohm.

The effect of the direct current resistance unbalance upon a line is to increase the phantom to side crosstalk.

The values guaranteed above are such as will give complete confidence regarding the crosstalk contributed by this source and there is no reason to decrease the tolerance.

The balance is obtained by careful winding and manipulation.

(e) *Magnetic Stability.*

If any one of the four lines in a loading unit (connected as under operating conditions) is traversed by any value of direct current between 0 and 2 amperes causing magnetisation, the inductance values of the sides or of the phantom circuit will not have changed by more than  $\pm 1\%$  from their initial values when the inductance is measured 5 minutes after the cessation of the magnetising current.

The question of magnetic stability has been discussed earlier in this paper but there is one point in connection with the definition of a guarantee which is worthy of note. It has been found that the degree of inductance deviation as measured five minutes after the magnetic shock varies in accordance with the speed at which the magnetising current builds up or decays. Since the variation may be as much as 0.3% of the total inductance it is desirable to carry out the test with a quick acting snap switch thereby providing conditions which may be repeated with a reasonable degree of uniformity.

For the above reason it is undesirable to give a guaranteed tolerance which is so close to the actual value measured that the above discrepancy may introduce controversy. Another reason favouring a desirable margin is that there is a

relationship between the magnetic stability and iron losses whereby a rigid intolerance on one might constrain development on the other.

(f) *Insulation Resistance.*

The insulation resistance between the windings and between each line winding and all other line windings connected to the containing case will not be less than 10,000 megohms when tested with a direct potential of 300 volts.

The value stipulated above is that which enables the fulfillment of the overall insulation tests on the loaded cable.

The required degree of insulation is secured in the factory by careful heating and drying treatment and sealing processes. The temperature and associated humidity conditions prevailing in the factory during manufacture and during the making of the test have an important bearing upon the results.

In one factory situated in a humid region an air conditioning plant has been installed and the results are highly satisfactory.

(g) *Crosstalk.*

The crosstalk expressed in Népers or units of crosstalk measured between the circuits indicated below with an alternating current of from 8 to 10 milliamperes at a frequency of 800 p.p.s., will not be worse than the following values:

WITHIN THE LOADING UNIT

	Side to Side		Phantom to Side	
	Népers	Units of Crosstalk	Népers	Units of Crosstalk
Worst Value.....	10.4	30	9.5	75
Worst Average per Case.....	11.1	15	10.3	35

BETWEEN CIRCUITS IN DIFFERENT UNITS

	Pair to Pair		Phantom to Pair		Phantom to Phantom	
	Népers	Units of Crosstalk	Népers	Units of Crosstalk	Népers	Units of Crosstalk
Worst Value.....	10.4	30	9.9	50	9.9	50
Worst Average per Case.....	11.1	15	10.8	20	10.8	20

In making the above tests the circuits are terminated with non-inductive resistances having values chosen so as to simulate operating conditions. The above figures apply both to near-end and far-end crosstalk measurements.

From the systems aspect it is desirable to keep the crosstalk always as low as possible with an ideal condition of Zero; there is, however, a

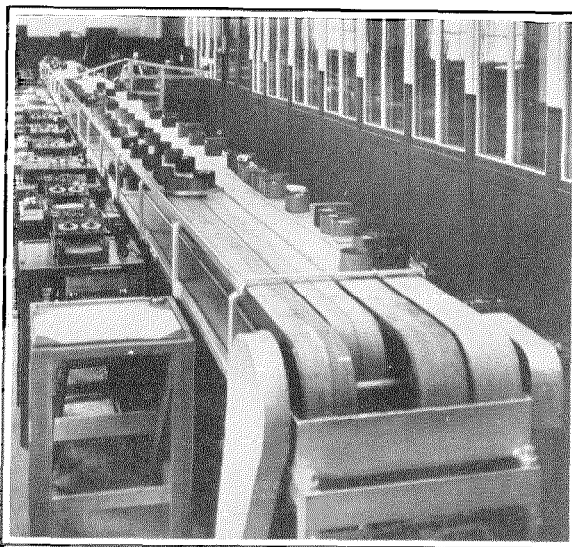

Figure 14—Coil Balancing Room.

practical limit lower than which it is not absolutely essential to proceed. This practical limit is set by the value of crosstalk contributed by the cable itself, and the limits quoted as maxima are those which not only fulfil the latter requirement but also permit further reduction on the part of the cable.

It may be of interest to observe that neglecting attenuation the crosstalk on a line is proportional to the square root of the sum of the squares of the crosstalk values contributed by the component parts.

(h) *Breakdown.*

The dielectric between all the windings together and the containing case will withstand an alternating potential of 2,000 volts (R.M.S. value) at a frequency of 25 p.p.s., applied for 2 minutes.

The dielectric between each winding and all other windings connected to the containing case will withstand an alternating potential of 500 volts at a frequency of 25 p.p.s., applied for 1 minute.

As in the case of insulation resistance, the dielectric strength is defined by the breakdown requirements in the line and the above values are representative of equipment for a normal cable. In certain instances such as when the cases are to be installed alongside an electrified railway it may be necessary to increase the limit for breakdown between windings.

The required objective is obtained in the factory by the choice of insulating materials and the degree of separation between conductors. There is no doubt about the above values being met with a wide margin.

It is not claimed that the guarantees given above are sufficient to define the unit as such, but it is believed that the information given is sufficient to cover the functions of the unit in the complete system. Thus, if loading units are to be supplied as a distinct item and without reference to systems guarantees, it may be desirable for the user to supplement the foregoing requirements with others which are peculiar to the project under consideration, and it is certainly helpful for the supplier of the coils to be informed of the general characteristics of the system in which they are to be employed.

Having now given an outline of the properties of the standardised unit for the loading of long distance cables, it is of interest to turn to the types of loading which are auxiliary to or specialised forms of a main long distance cable system.

#### **Loading Coils for Exchange Area Cables**

The loading of exchange area cables in Europe has not received the same amount of attention as the loading of long-distance cables and, apart from Great Britain, it has been practically neglected. There is, however, every indication that its use will become widespread and suitable coils have been developed with that end in view.

The general economic requirements for such coils have already been outlined in connection with the description of the evolution of the long-distance coils and those requirements still hold at the present time; that is to say, cheapness and size still override any question of transmission quality, or perhaps it would be more correct to say that the requirements of the system are in no way comparable in magnitude with the problem of cheapness and volume.

It is not within the scope of this article to go into the details connected with the transmission requirements for exchange-area cables but it may be noted that the permissible losses are defined by local factors and the circuit should have a standard of quality sufficient to enable its inclusion in the ultimate portion of a long-distance circuit without impairing the quality of the complete circuit.

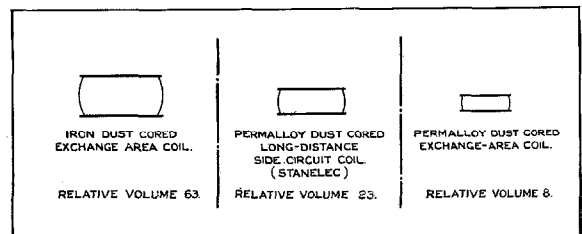

Figure 15—Comparative Sizes of Iron Dust and Permalloy Dust Cored Exchange-area Loading Coils.

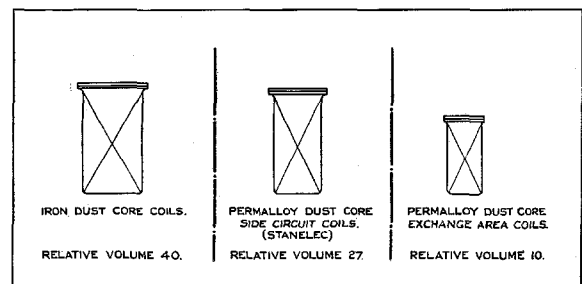

Figure 16—Comparative Sizes of Equipment for Encasing 220 Coils of the Iron Dust and Permalloy Dust Cored Types for Exchange-area Loading.

The type of cable generally used together with the most suitable spacing (2,740 metres) indicate that the loading coil inductance should be 88 millihenrys and this value has therefore been standardised for normal exchange-area loading.

The design of the core for exchange-area coils has been focused entirely on the 88 millihenry inductance value although the question of economically applying the core to coils having other inductance values has not been overlooked.

As in 1925 it has again been decided to use core material identical with that used for the long-distance coil cores, a decision strengthened by the intention to concentrate on the production of a coil having very small dimensions, thus creating only a very small demand for core material compared with the demand for material to be used for long-distance coil cores.

The problems associated with the construction of very small coils have already been discussed. It will be recalled that with the present winding machines the dimensions of the coil having interleaved windings are already a minimum and the only constructional advantage accruing on the exchange-area coil is the permissibility of simple, non-interleaved windings. Fortunately it has been found possible to modify the type of ma-

chine used for winding toroidal repeating coils, and the coil resulting from the application of this machine and from a design concentrated on reduced dimensions has a volume which is one-third that of the permalloy dust cored side circuit coil and approximately one-eighth that of the iron dust cored exchange area coil. The relative dimensions of the coils and cases are shown in Figures 15 and 16, respectively, the Stanelec side circuit coil being of interest not only from the development standpoint but also because it has been used to some extent for exchange-area loading during the transitional period elapsing between the completion of the Stanelec coil and the inception of the small coil under consideration.

With regard to the electrical characteristics, provided that the crosstalk requirements are limited to pair-to-pair crosstalk it may be said that the only features in which the exchange-area loading coil differs from the Stanelec side circuit coil are the increased resistance, the diminished accuracy of inductance and resistance balance, and the susceptibility to superposed currents or wide fluctuations in the operating currents.

The increased resistance, while precluding the use of the coil on long distance circuits, in no way approaches the maximum value set by the limitations of circuit attenuation. Assuming therefore that circuit requirements remain static there would be no objection to a further reduction in dimensions but the present limit is the practical one for constructional manipulation.

The graph in Figure 17 shows the resistance

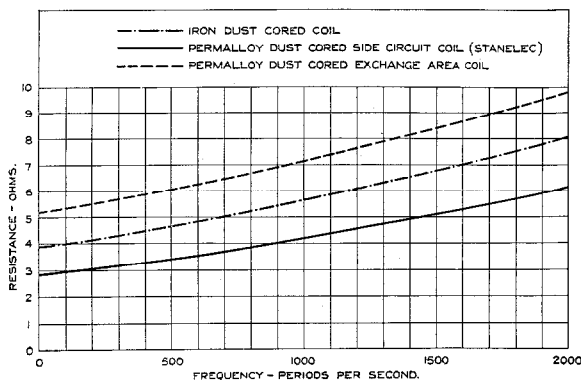

Figure 17—Effective Resistance—Frequency Characteristics of 88 Millihenry Coils as Used for Exchange-area Loading. Measured With a Current of 1 Milliampere.

characteristics of the three types of coil involved. The reader is referred back to the details regarding the reaction of the iron dust cored exchange-area coil upon long-distance loading coils, a reaction which has been studied in connection with the present situation and which indicates that a coil having the dimensions of the new exchange-area coil is unsuitable for long-distance circuits unless radical developments occur in core material.

It is not believed that any useful purpose would be served by enumerating guaranteed values and it is sufficient to state that the only essential clauses in such a specification are those defining inductance tolerance, inductance balance, direct current resistance balance, pair-to-pair crosstalk, and stability to magnetic shock.

Compared with the requirements for Stanelec side circuit coils, the exchange-area coils may normally be permitted twice the inductance tolerance, twice the inductance unbalance, twice the direct current resistance unbalance and an increase of approximately fifty percent on the pair-to-pair crosstalk. Since the same core material is used in both types of coil the stability to magnetic shock is practically the same.

Turning now to coils with inductance values other than 88 millihenrys, those with lower values would be on exactly the same core whilst those with higher inductance values require a larger core, the reason for the latter being that the gauge of wire used for the 88 millihenry coil is so small that any further reduction in diameter would introduce winding difficulties due to breakage of the wire. The core has therefore been increased in volume by increasing the axial height without altering the diameter so that the coil can be encased in the same cases as those used for the 88 millihenry coils, an obvious economy, the difference being that it is possible to stack vertically only 4 of the higher inductance coils as against 5 of the 88 millihenry coils.

### Loading Coils for Music Transmission Circuits

As a result of radio broadcast developments it has become necessary to provide cable circuits capable of serving as links in networks used for distributing programmes between the source and the various radio stations participating in the

broadcast. The extent of such networks is not limited to the area enclosed by a studio and its attendant national transmitting stations but also covers broadcasts of an international character.

It is obvious that the normal speech transmitting circuits will not fulfil the quality requirements since their frequency band covers a range only of from 300 to 2,500 p.p.s., whilst the frequency band required by the broadcast service is from 30 to 10,000 p.p.s., with particular reference to the low frequency part of the spectrum.

For economic reasons it is desirable to retain the normal loading spacing, and the inductance values for the standardised coils have been chosen so as to give a frequency cut-off of 10,000 p.p.s., with the standard spacing of 1,830 metres. Two types of circuit are in common use, one a pair circuit with 15.5 millihenry pair circuit coils and the other a phantom circuit with 9.0 millihenry phantom circuit coils. In the case of the latter, the side circuits are not used during the period of broadcast transmission and they may or may not be loaded according to the purpose for which they are required.

From the standpoint of loading coil engineering the present transmission requirements on the coils present no difficulties since no attempt is made to attain a highly economical circuit. The attenuation losses which govern the coil resistance are overcome by an increased degree of amplification on the repeaters, whilst the small number of turns of wire required to give the small inductance value mitigates the effects of the increased current due to that amplification.

It has not, therefore, been considered necessary to depart from the standardised type of permalloy dust core as used for the Stanelec speech frequency coils, a course which has been supported by practical results.

Although the manufacture of such coils presents no difficulties, the question of factory testing is another matter since the extension of the test frequency range from that normally used, 1,800 p.p.s., to 10,000 p.p.s., is not only costly but also takes up a period of time incompatible with the importance of the coil under test.

It is not sufficient to modify laboratory equipment to an extent which would suit it to factory

testing because the modification would probably introduce errors of an order of magnitude equal to the degree of deviation of a normal factory product.

In view of the foregoing, the factory testing is limited to the tests applied to coils used purely for speech frequency work, random samples being periodically tested in the laboratory. Experiments have shown that it is extremely unlikely that any fault could occur which although apparent at the higher frequencies would remain undetected by the usual tests. Thus a short-circuiting turn would be shown at once by a reduced inductance and increased effective resistance, whilst unusual core permeability would be indicated by an abnormal direct current resistance brought about by the number of turns required to obtain the given inductance.

Probably the only factor which could influence the higher frequency results and not be apparent at the lower frequencies would be an abnormal capacity between coil windings but this deviation could only be due to badly distributed windings which would show up as an increased direct current resistance due to the increased number of turns required by uneven distribution. It may therefore be safely assumed that with accurate testing at the lower frequencies there will be no misplacement of faith in the results at the higher frequencies.

Figures 18, 19, 20, and 21, show effective resistance and inductance versus frequency characteristics for a 15.5 millihenry pair circuit coil and a 9.0 millihenry phantom circuit coil with which are associated two Stanelec 177 millihenry

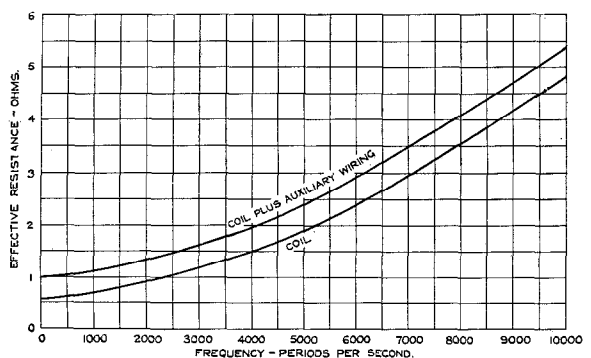

Figure 18—Effective Resistance—Frequency Characteristic of a 15.5 Millihenry Coil for Loading a Music Transmission Circuit. Measured With a Current of 1 Milliampere.

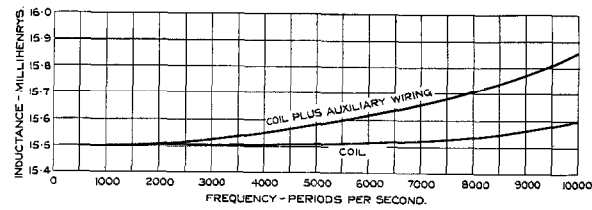

Figure 19—Inductance—Frequency Characteristic of a 15.5 Millihenry Coil for Loading a Music Transmission Circuit. Measured With a Current of 1 Milliampere.

side circuit coils. It will be seen that two curves are shown on each graph, one for the isolated coil or unit and one when it is connected with the auxiliary wiring required between the coil terminal wires and the point at which the main cable joint is made.

The measurements up to a frequency of 2,000 p.p.s., were made on the impedance type of bridge and above that frequency by the series resonance method.

It will be seen that so far as resistance is concerned, the parallelism of the two curves shows that the effect of the auxiliary wiring is simply one of adding direct current resistance. In this connection it should be noted that at a frequency of 800 p.p.s., approximately 40 percent of the apparent time constant  $\frac{(R)}{(L)}$  of the encased 15.5 millihenry coil is due to this additional resistance whilst in the case of the 9.0 millihenry phantom unit 7 percent is due to the auxiliary wiring and 75 percent to the direct current resistance of the 177 millihenry side circuit coils.

The above point should be borne in mind when using the time factor as a criterion of coil quality since it is customary to quote only the values measured at the ends of the auxiliary wiring conductors, these being the only points in the circuit which are accessible after the coil is encased.

Although the  $\frac{R}{L}$  values for the above reasons may appear to be very large, the actual effect on the attenuation is small, because the resistance added by the loading equipment is still very small in comparison with the line resistance.

With regard to the measured inductance versus frequency curves, the condition is more complex; it will be seen that for the coil alone the inductance is effectively constant at all fre-

quencies but, on adding the auxiliary wiring, there is an apparent increase commencing at a frequency of about 2,500 p.p.s. This increase is apparent in so far as it is neither the true inductance nor the inductance which is effective in the loaded circuit; the cause is the added capacity of the auxiliary wiring.

The capacity between the coil windings is of the order of 1,500 micromicrofarads but owing to the fact that it is distributed it does not tend to cause resonance. The capacity of the auxiliary wiring, however, although only approximately 100 micromicrofarads, is concentrated at the coils ends and has a very pronounced effect at the higher frequencies. In the normal method of testing and the one adopted for the measurements resulting in the graphs under discussion, the test set is connected directly on to one set of coil conductors whilst the other set of conductors is short circuited, the combination therefore being that of an inductance shunted by a condenser. Three effects may occur: the condenser may shunt some of the current which would otherwise flow through the coil, the re-

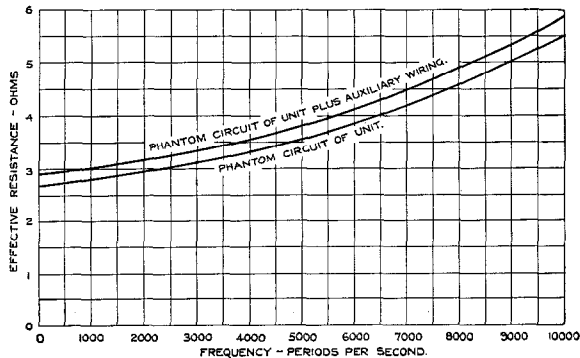

Figure 20—Effective Resistance—Frequency Characteristic of a 9.0 Millihenry Phantom Circuit Associated With Two 177 Millihenry Side Circuit Coils to Form a Unit. Measured With a Current of 1 Milliampere.

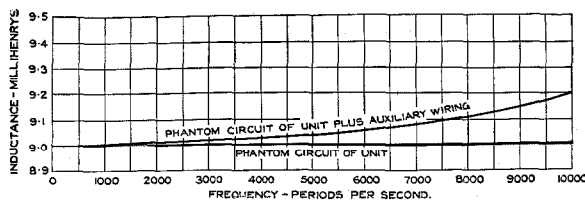

Figure 21—Inductance—Frequency Characteristic of a 9.0 Millihenry Phantom Circuit Associated With Two 177 Millihenry Side Circuit Coils to Form a Unit. Measured With a Current of 1 Milliampere.



duction of current through the latter tending to reduce the effective inductance; the effective permeability of the core material may tend to become smaller as the frequency is increased, again reducing the inductance; finally, the circuit may tend towards resonance, thereby producing an apparent increase in inductance. The two former effects are slight in any coil and particularly so in a coil of low inductance value, but the resonance effect as indicated by the curves is a conspicuous feature.

So far as the loading of the line is concerned the increase in apparent inductance of a coil under test conditions may be neglected, since it is the true inductance which is effective and not the unreal inductance brought about by a tendency to resonance.

If it were desirable to derive the true inductance from the bridge reading at a high frequency, it could be done by applying mathematical corrections. The fact that the apparent inductance curve and true inductance curve coincide at the lower frequencies shows that such a course is unnecessary, and provides a strong argument for restricting factory testing to those frequencies.

With regard to the permissible inductance tolerance, it is undesirable to work to a value of less than  $\pm 2\%$  of the nominal value owing to the smallness of the latter increasing the effect of turn adjustment.

Apart from inductance, the most important feature is that of crosstalk and immunity in this respect is obtained both by isolation of the coil in the case and the conductors in the auxiliary wiring. It is customary to guarantee that the crosstalk between the music circuit coil and any other coil within the case will not be worse than 12.2 népers (5 units of crosstalk) when measured under the same conditions as those applying to the normal speech frequency equipment.

### *The Loading of Open-Wire Lines*

The loading of open-wire lines was discontinued on the introduction of the repeater. Prior to that event it was carried out in Europe to a very limited extent.

Non-loaded open-wire lines may be constructed to give satisfactory results up to approximately 300 kilometres. Beyond that

distance it is more economical to install repeaters than to load the circuit.

It is obviously difficult to obtain a high grade of insulation on open-wire lines. Since loading increases the impedance of the circuit it also increases the irregularities due to the leakage losses, thus rendering it unsuitable for use with repeaters. Another objection is the increased maintenance difficulties brought about by the necessity for protection against damage by lightning.

In view of the foregoing not only is it no longer the practice to load open-wire lines but in some cases the coils have since been removed from lines previously loaded.

### *The Loading of Carrier Frequency Circuits*

It is not proposed in this paper to cover the field of loading coils for carrier frequency circuits since it is impossible to treat the subject as a supplement to voice frequency loading and any attempt in this direction would confuse the distinction between the problems associated with carrier frequency loading and those prevailing on voice-frequency and music frequency loading.

The following notes are therefore intended merely to indicate some of the salient features of the subject.

The carrier frequency portion of the spectrum ranges from 5,000 p.p.s. to 30,000 p.p.s., and the loading is applied only to the toll entrance or intermediate cables and office wiring and not to the open-wire lines. The carrier frequency circuits proper are on the side circuits only whilst the phantom circuits are used for telegraph or voice frequency working; it is, therefore, unnecessary to load the phantom circuits at every point at which the side circuit is loaded and phantom loading is applied at every second, third, or sixth loading point depending on the carrier system in use. The spacing between points is either 284 metres or 914 metres, again depending on the system.

The side circuit coils which are used at the 284 meter spacing have inductance values less than 5 millihenrys which together with the high frequency in use makes it undesirable and unnecessary to use metallic cored coils, first, because the inductance can be obtained with few winding turns and second, because the presence

of metal within the inductive field would create losses due to eddy currents.

The phantom circuit coils are of low inductance, of the order of 12 millihenrys, to match the impedance of the open wire line, but the working frequency is low and the normal type of permalloy dust core can be used.

In view of the fact that the nomenclature of carrier loading equipment is similar to but not coincident with voice-frequency loading equipment, the following details may assist in distinguishing the various apparatus involved.

There are four main items of loading equipment, namely, the side circuit coil, the phantom unit, the side circuit terminal unit, and the phantom circuit terminal unit.

As its name implies the side circuit coil is simply one coil and has no associated equipment.

The phantom unit is a combination of two side circuit coils along with one or two coils, according to the system for loading the phantom circuit.

The terminal units are used at the end of the circuit in order to secure a non-reactive impedance characteristic over the frequency range in use. The inductance added by a terminal unit to the circuit with which it is associated is a fixed fractional value of the loading on that circuit; this scheme is known as compensated loading.

The side circuit terminal unit consists of a fractional inductance side circuit coil across which is shunted a retardation coil in series with a condenser. It is used only for compensating the side circuits.

The phantom terminal unit is used for compensating both side and phantom circuits and consists of two fractional inductance side circuit coils, two retardation coils effective only on the side circuits, two fractional inductance coils which load the phantom circuit, two retardation coils effective only on the phantom circuit, and finally, four condensers in mesh formation between the side circuits.

It will be realised from the foregoing that with the small values of inductance and with the high frequencies involved the problems which arise call for an entirely different technique from that associated with voice frequency loading coils.

The use of a non-magnetic core material such as wood or bakelite simplifies the adjustment of inductance at the low inductance values involved but the problems of capacity, capacity unbalance, "skin" effect and eddy current effects inherent in the copper windings are such as to necessitate a high degree of control and manipulation in order to produce an efficient and uniform product.

As may be surmised from the testing problems associated with music circuit coils, the testing of carrier frequency coils requires special apparatus capable of indicating resistance losses of a character quite distinct from those encountered on the voice frequency coils.

In order to reduce interference to a minimum it is necessary to place each coil or unit inside a copper can and all auxiliary wiring must be fully screened.

The use of carrier frequency loading is not yet very widespread but unlike the loading of music circuits for broadcasting purposes there is no factor likely to limit the extent of its use. Although the present demand in Europe is small, it is necessary to keep in view the probability of production in quantity, thereby involving a slow advance in the preliminary stages of manufacture.

### *Special Voice Frequency Loading Coils*

The foregoing description of permalloy dust cored coils has been confined to a type designed with a view to its association in the economic unity of the system. If, however, the economic question is neglected and the designer is confronted only by electrical requirements, then the permalloy dust core material is conspicuous by the ease with which it is possible to produce coils unique in their low values of resistance and yet retaining dimensions capable of manipulation.

This increased flexibility in design has made it possible to supply coils for operation on special systems and of a size such as will not disturb existing installation facilities.

### *Future Possibilities*

In concluding this portion of the paper which so far has been confined almost entirely to the coils themselves, it will not be out of place to discuss briefly the possibility of future changes.

It is believed that the present product is not only satisfactory from the economic and electrical standpoints but that it covers those features to a degree sufficient to permit modifications in the other components of the systems.

At the present moment, therefore, the effects of any improvement would be experienced mainly by the designers of the coils as a pleasant consciousness of having available some property in excess of normal demands. Such a consciousness is usually short lived since the system engineers rarely fail to discover some significance of the new property which then becomes a specified feature.

Probably the most fruitful improvement which could occur would be the production of a coil capable of rigidly maintaining its initial inductance and resistance values despite the passage of large operating or superposed currents in the windings.

Another desirable advance would be the association of the above properties with a coil wound on a core of higher permeability, thus enabling either the resistance or the dimensions to be still further reduced. Any changes in the latter direction would, however, almost certainly involve either a new method of winding or a complete change in the construction of the coil.

# *Standard*

## **POWER CABLES**

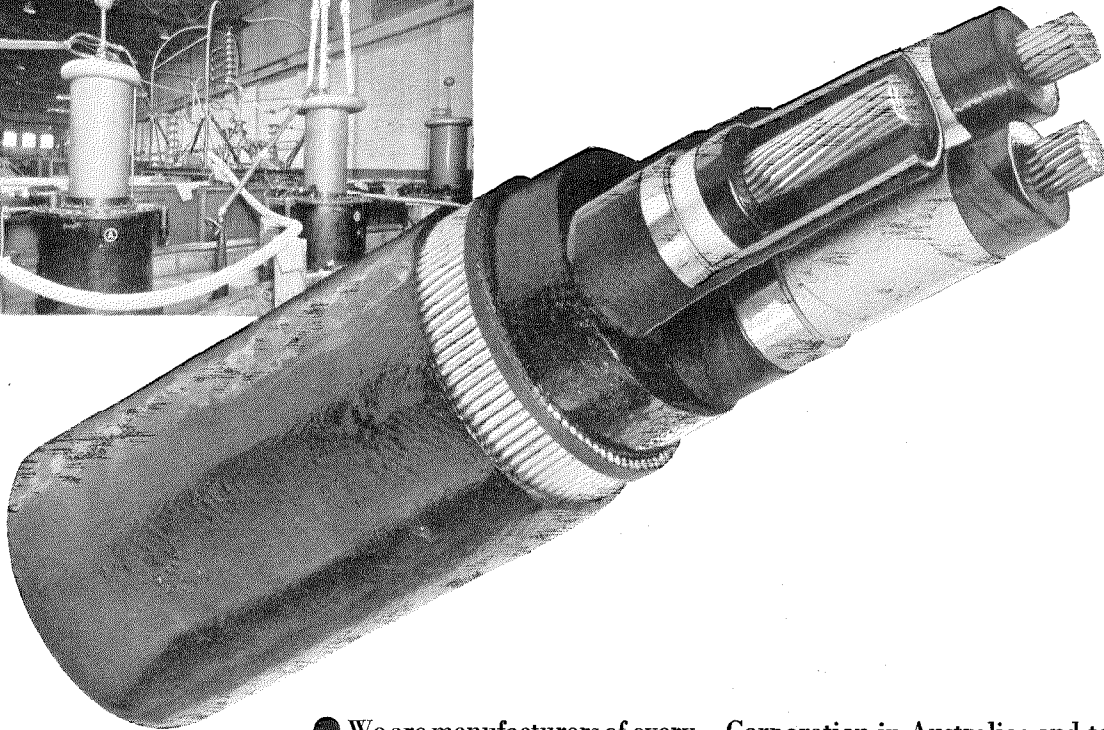
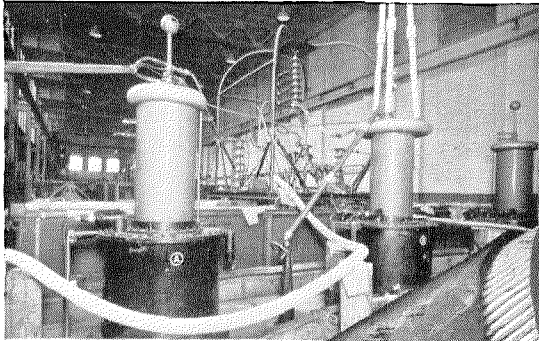

● We are manufacturers of every type of cable for power and lighting purposes, from rubber covered for house wiring to lead covered, taped, and armoured, super-tension cable, as supplied to the Central Electricity Board for working in connection with the overhead transmission lines all over England; to the Sydney Corporation in Australia; and to many other Municipalities and Power Companies throughout the world.

Our Power Cable Testing Plants—one of which is illustrated—are second to none, and assure the high quality of performance in our cables that is associated with all Standard products.

*Standard Telephones and Cables Limited*

**Columbia House, Aldwych, London, W. C. 2**

# MAKE THE MOST OF YOUR LINE

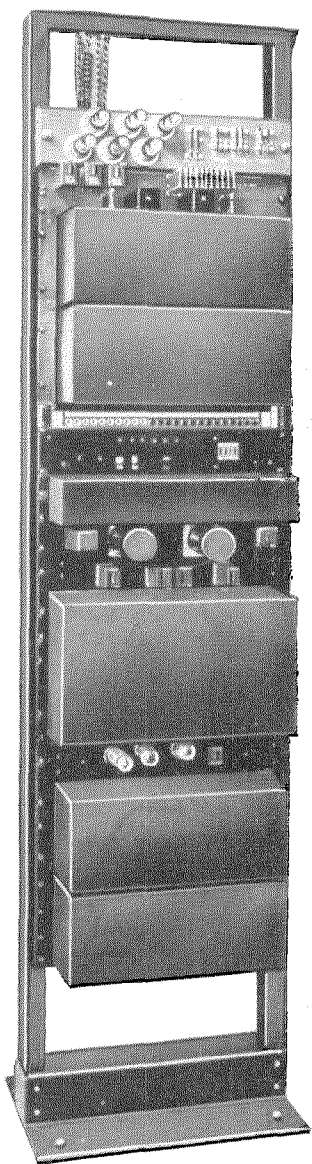

● When the traffic over a telephone line becomes too heavy for the existing circuits it is not always economical to add new wires. The extra demand may be only seasonal or due to some emergency, in which cases the expense of new circuits would not be justifiable.

The "Standard" Single Channel Carrier Telephone System (Type D.1) provides an extra channel of communication on open wire lines, additional to the existing circuits. No elaborate or bulky apparatus is required, only a rack, as shown, 7 ft. high and 1 ft. 8 in. wide, on which all the apparatus is mounted, connected to the switchboard at each terminal of the line. Maintenance and operation are extremely simple.

The complete apparatus, weighing less than 400 lb., is portable, and can therefore be moved easily from place to place, to cope with any sudden traffic demand.

This equipment can be used over a distance of from 135 to 200 miles, dependent upon the gauge of the conductors.

"Standard" Carrier Systems can be used by Government Administrations, Railway Companies and Corporations operating their own telephone services. Two hundred and eighty-eight of these equipments, manufactured by Standard Telephones & Cables Limited, have been installed in all parts of the world.

*Full particulars will be forwarded upon request*

## **Standard**

**CARRIER TELEPHONE SYSTEMS**

*Standard Telephones and Cables Limited*

**Columbia House, Aldwych, London, W.C.2**

---

# *The Standard*

## **ROTARY AUTOMATIC TELEPHONE SYSTEM**

The rotary type of automatic telephone equipment is an original development of the International Standard Electric Corporation.

Approximately 1,300,000 lines are now in operation or on order in 26 countries.

More than eighty cities are now being served through Standard Rotary Automatic Telephone equipment. The following may be mentioned as the principal cities which have adopted this system:

Antwerp	Cairo	Mexico City
Auckland	Copenhagen	Oslo
Barcelona	Dunedin	Paris
Basle	Geneva	Rio de Janeiro
Bergen	Haarlem	Shanghai
Bologna	Hull	The Hague
Brussels	Liege	Vatican City
Bucharest	Lima	Wellington
Budapest	Madrid	Zurich

Rotary Automatic Telephone Systems are furnished by the International Standard Electric Corporation and Licensee Companies.

*International Standard Electric Corporation*

HEAD OFFICES

**67 BROAD STREET, NEW YORK, N. Y., U. S. A.**

●  
EUROPEAN GENERAL OFFICES

Connaught House, Aldwych, London, W. C. 2, England

---

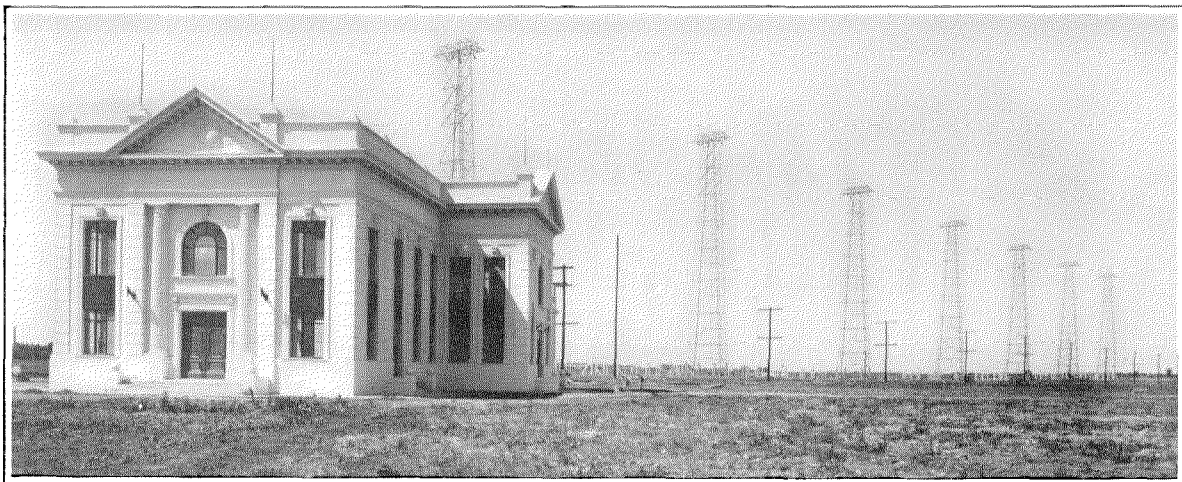

***South America linked with***  
**30,000,000 Telephones**  
***throughout the World***

The radio telephone station of the Companhia Radio Internacional do Brasil is now in operation. It links Rio de Janeiro with Buenos Aires and New York, and shortly will connect Brazil with Europe through the radio telephone station located at Madrid. It is the latest step in a program designed to give the countries of South America international telephony of a type comparable with the best obtainable anywhere in the world.

The Rio de Janeiro station—and other radio stations of the International Telephone and Telegraph group located at

Buenos Aires, Santiago, and Bogota—interconnect Argentina, Brazil, Chile, Uruguay, and Colombia telephonically.

South America, through these radio telephone stations, is in direct contact with the United States, Canada, Mexico, Cuba, Bermuda, the Hawaiian Islands, Europe, the Canary Islands, Mallorca Island, Northern Africa, Australia, and New Zealand.

Thus, South American subscribers can obtain quick and reliable telephone communication with some 30,000,000 telephones throughout the world or approximately 90% of the world's total.

---

**INTERNATIONAL TELEPHONE AND TELEGRAPH CORPORATION**

---



## INTERNATIONAL TELEPHONE AND TELEGRAPH CORPORATION

### BOARD OF DIRECTORS

<p>FREDERIC W. ALLEN Lee, Higginson &amp; Company</p> <p>ARTHUR M. ANDERSON J. P. Morgan &amp; Co.</p> <p>HERNAND BEHN, President</p> <p>SOSTHENES BEHN, Chairman</p> <p>F. WILDER BELLAMY Dominick &amp; Dominick</p> <p>EDWARD J. BERWIND Chairman, Berwind-White Coal Mining Company</p> <p>JOHN W. CUTLER Edward B. Smith &amp; Co.</p> <p>R. FULTON CUTTING Financier</p> <p>GEORGE H. GARDINER Davis Polk Wardwell Gardiner &amp; Reed</p> <p>CONDE DE GÜELL President, Compañía Trasatlántica Española, Barcelona</p> <p>ALLEN G. HOYT Vice-President, The National City Bank of New York</p> <p>IVAR KREUGER Chairman, Kreuger &amp; Toll Company, Stockholm</p>	<p>RUSSELL C. LEFFINGWELL J. P. Morgan &amp; Co.</p> <p>CLARENCE H. MACKAY Chairman of the Board, Postal Telegraph and Cable Corporation</p> <p>JOHN L. MERRILL President, All America Cables, Incorporated</p> <p>CHARLES E. MITCHELL Chairman, The National City Bank of New York</p> <p>WALTER E. OGLVIE President, Havana Terminal Railroad Company</p> <p>HENRY B. ORDE, Vice-President</p> <p>BRADLEY W. PALMER Chairman of the Executive Committee, United Fruit Co., Boston</p> <p>GEORGE E. PINGREE President, International Standard Electric Corporation</p> <p>WOLCOTT H. PITKIN Vice-President and General Attorney</p> <p>LANSING P. REED Davis Polk Wardwell Gardiner &amp; Reed</p> <p>MARQUÉS DE URQUIJO President, Banco Urquijo, Madrid</p>
--	--

GEORGE H. GARDINER  
General Counsel

### OFFICERS

<i>Chairman</i> SOSTHENES BEHN	<i>President</i> HERNAND BEHN	
<i>Vice-Presidents</i>		
HENRY B. ORDE LEWIS J. PROCTOR GEORGE E. PINGREE	PHILIP K. CONDUCT JOHN L. MERRILL FRANK W. PHELAN	WILLIAM F. REPP FRANK GILL FRANK C. PAGE
<i>Vice-President and General Attorney</i> WOLCOTT H. PITKIN		<i>Vice-President and General Technical Director</i> JAMES L. McQUARRIE
<i>Comptroller</i> EDWIN F. CHINLUND	<i>Secretary</i> S. G. ORDWAY	<i>Treasurer</i> JAMES E. FULLAM

**T**HE International Telephone and Telegraph Corporation was organized to cooperate and assist technically and financially in the general development of electrical communications in a broad international sense, and, with respect to the organization and development of national communications systems, it is the purpose of the International Telephone and Telegraph Corporation to develop truly national systems operated by the nationals of each country in which the International Corporation is or may become interested. The International Corporation was not organized with a single profit-making purpose to itself nor with the desire of imposing American practices in its foreign activities. There appeared to be a fruitful field of service to be ren-

dered in bringing together under one general organization electrical communications systems, and the extension by the International Corporation to the Associated Companies of the technical and financial facilities and direction that might be needed for their intensive and efficient development. The best American practices have been suggested but never imposed. On the contrary, the International Corporation has always been ready and quick to adjust American practices to local conditions and to adopt such local practices as were conducive to the successful development of the various entities. The combined and co-ordinated effort of the Associated Companies of the International System is today justifying the plans and purposes of the Corporation.

---

---

## *Licensee Companies*

- BELL TELEPHONE MANUFACTURING COMPANY.....*Antwerp, Belgium*  
*Branches: Berne, The Hague, Brussels.*
- STANDARD ELECTRIC DOMS A SPOLECNOST.....*Prague, Czechoslovakia*
- CHINA ELECTRIC COMPANY, LIMITED.....*Shanghai, China*  
*Branches: Canton, Hankow, Harbin, Mukden, Peiping, and Tientsin, China.*
- COMPAÑÍA STANDARD ELECTRIC ARGENTINA.....*Buenos Aires, Argentina*
- INTERNATIONAL STANDARD ELECTRIC CORPORATION, *Branch Office,*  
*Rio de Janeiro, Brazil*
- INTERNATIONAL STANDARD ELECTRIC CORPORATION OF MEXICO....*New York, N. Y.*
- INTERNATIONAL TELEPHONE AND TELEGRAPH LABORATORIES, INCORPORATED  
*Hendon, England*
- LE MATÉRIEL TÉLÉPHONIQUE.....*Paris, France*
- NIPPON DENKI KABUSHIKI KAISHA.....*Tokyo, Japan*  
*Branches: Osaka, Dalny, Seoul, Taihoku.*
- FERDINAND SCHUCHHARDT, BERLINER FERNSPRECH-UND TELEGRAPHENWERK  
AKTIENGESELLSCHAFT.....*Berlin, Germany*
- STANDARD ELECTRIC AKTIESELSKAP.....*Oslo, Norway*  
AKTIESELSKABET SKANDINAVISKE KABEL- OG GUMMIFABRIKER.....*Oslo, Norway*
- STANDARD ELECTRIC AKTIESELSKAB.....*Copenhagen, Denmark*
- STANDARD ELECTRICA ROMANA S/A.....*Bucharest, Rumania*
- STANDARD ELÉCTRICA, S. A.....*Madrid, Spain*  
*Branches: Barcelona, Bilbao, Sevilla, Santander.*
- STANDARD ELETTRICA ITALIANA.....*Milan, Italy*  
*Branch: Rome.*
- STANDARD TELEPHONES AND CABLES, LIMITED.....*London, England*  
*Branches: Birmingham, Glasgow, Leeds, Manchester, Dublin, Cairo, Johannes-*  
*burg, Calcutta, Singapore.*
- STANDARD TELEPHONES AND CABLES (AUSTRALASIA), LIMITED.....*Sydney, Australia*  
*Branches: Melbourne, Wellington.*
- STANDARD VILAMOSÁGI RÉSZVÉNY TÁRSASÁG.....*Budapest, Hungary*
- SUMITOMO ELECTRIC WIRE & CABLE WORKS, LIMITED.....*Osaka, Japan*
- VEREINIGTE TELEPHON-UND TELEGRAPHENFABRIKS AKTIENGESELLSCHAFT,  
CZEIJA, NISSL & CO.....*Vienna, Austria*  
*Branch: Tallinn.*
- STANDARD ELECTRIC COMPANY W POLSCE SP. Z O. O.....*Warsaw, Poland*

---

*Sales Offices and Agencies Throughout the World*

---

---