

ELECTRICAL COMMUNICATION

SUB. DIVN. 280 14 MAY 1931

RETURN TO
TECHNICAL FILE
DEPT. 280

APRIL

No. 4

1931

VOL. 9

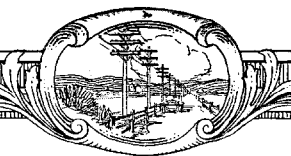

ELECTRICAL COMMUNICATION

A Journal of Progress in the
Telephone, Telegraph and Radio Art

H. T. KOHLHAAS, Editor

EDITORIAL BOARD

J. L. McQuarrie F. Gill G. Deakin P. E. Erikson G. H. Nash M. K. McGrath
G. E. Pingree P. K. Condict E. A. Brofos E. C. Richardson Frank C. Page

Published Quarterly by the

International Standard Electric Corporation

Head Offices

67 BROAD STREET, NEW YORK, N. Y., U. S. A.

European General Offices

CONNAUGHT HOUSE, ALDWYCH, LONDON, W. C. 2, ENGLAND

G. E. Pingree, President

S. G. Ordway, Secretary

James E. Fullam, Treasurer

Subscription \$3.00 per year; single copies 75 cents

Volume IX

APRIL, 1931

Number 4

CONTENTS

THE ITALIAN STATE TOLL CABLE SYSTEM	205
<i>By Professor G. di Pirro</i>	
SOME ECONOMIC FACTORS IN THE DESIGN OF SINGLE CORE SUBMARINE CABLES FOR CARRIER TELEPHONY	217
<i>By J. R. Vezey</i>	
THE TENERIFE-GRAN CANARIA AND ALGECIRAS-CEUTA CABLE SYSTEMS	222
<i>By Fred T. Caldwell</i>	
TENERIFE-GRAN CANARIA AND ALGECIRAS-CEUTA SUB- MARINE CABLES	226
<i>By K. E. Latimer and J. R. Vezey</i>	
THE NEW MADRID TOLL BOARD	236
<i>By W. H. Warren and J. J. Parsons</i>	
THE POSSIBLE APPLICATION OF COMMON CONTROL CIRCUITS TO THE STEP-BY-STEP SYSTEM	247
<i>By J. H. E. Baker and E. P. G. Wright</i>	
THE RÔLE OF RADIO IN THE GROWTH OF INTERNATIONAL COMMUNICATION	249
<i>By Harold H. Buttner</i>	

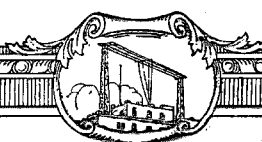



INTERNATIONAL TELEPHONE BUILDING
67 Broad Street, New York

The Italian State Toll Cable System

By PROFESSOR G. di PIRRO

Director General of the "Istitue Superiore" of the Italian Post, Telegraph and Telephone Administration

Introduction

THE year 1930 will undoubtedly be counted as one of great importance in the telephone history of Italy, for it has witnessed the completion of the main portion of the great national long distance cable project initiated in 1926 which gives Italy a system of underground cables extending from Naples (via Rome, Florence, and Bologna), to Milan, Turin, and Genoa, and (via the route of Chiasso) to the rest of Europe. Within a year the final section of the project from Bologna to Padova, Venice, and Trieste will also be completed, and at the same time communication will be established with Austria, Czecho-Slovakia, Hungary, and the rest of Eastern Europe by means of the cable from Udine to Tarvisio.

As far back as 1912 the Italian Administration decided to install a system of underground cables connecting all the more important industrial centres in Northern Italy, and in 1913 the Italian Parliament passed the necessary law authorising the Ministry of Posts and Telegraphs to proceed with the scheme, which was then estimated to cost about 56 millions of lire. Before any contract could be placed, however, the Great War intervened and the scheme had to be postponed.

Immediately after the War it was decided to go ahead with this project, which had then become of vital importance, as the existing facilities which were offered by the open wire lines were entirely inadequate, especially between the three important towns of Milan, Turin, and Genoa. The original pre-war scheme, however, was revised in accordance with the improvements which had since been introduced in the art of long distance telephony, especially as regards the development of the vacuum tube repeater and its application to loaded cables.

An additional factor of very great importance which had to be studied, was the question of inductive interference from electrified railroads and high tension power lines which are such a conspicuous feature of Northern Italy, where

these developments have been greater than in most other parts of Europe. In the summer of 1920 a special commission made a detailed study of the interference question in the region between Milan, Turin, and Genoa, and settled the route of the cable which was to link these three towns.

The order for the Milan-Turin-Genoa cable was placed by the Italian Administration in 1921; the contractor being the Societa Italiana Reti Telefoniche Interurbane, an Italian Company consisting of Pirelli and Tedeschi, cable manufacturers, and the International Western Electric (now International Standard Electric Corporation), who were the technical advisers for the system and who supplied loading coils and repeaters, instructed the factories in the making of the cable, and supervised the installation of all the equipment. This cable system, which was completed in 1924, has been described by Ing. G. Magagnini in "Telefoni e Telegrafi" (Anno IV No. 3 1923), and a translation of this article appeared in "Electrical Communication," Vol. II, No. 3, January, 1924.

That this cable has been a success is amply demonstrated by the following table, which shows the number of circuits provided and the total number of calls per day for the year 1924, before the cable was installed, and for the year 1928-29, which is the latest period for which official statistics have been published.

	No. of Circuits	Total number of calls per day (average)
Milan-Turin.....	1923-24 4	560
	1928-29 28	1493
Milan-Genoa.....	1923-24 5	555
	1928-29 34	1815
Turin-Genoa.....	1923-24 2	292
	1928-29 13	743

These figures demonstrate that before the cable was installed, the few open wire lines which existed were greatly overloaded, resulting in long delay and bad service. Today the number of circuits permits a good and speedy service at all hours of the day.

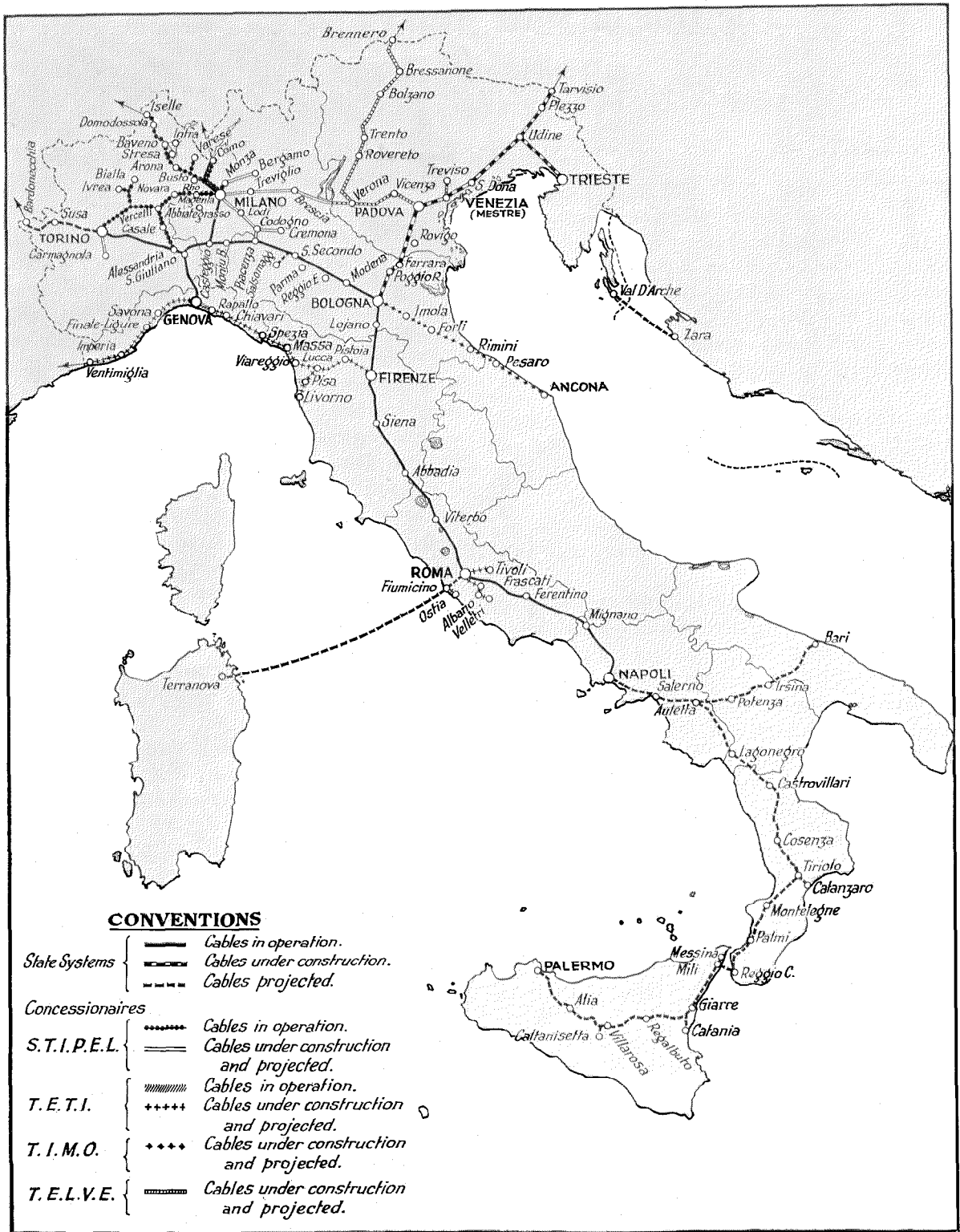

Map of Italian Toll Cable.

The traffic between these centres still continues to grow at an appreciable rate each year, so that further extensions in the number of circuits are already foreseen.

The National Long Distance Cable System

In planning the Milan-Turin-Genoa cable, provision was made for circuits which would later connect these three towns with the rest of Italy. Immediately after the completion of the first contract a study was made of a main cable system extending through the whole country, and also connecting to the rest of Europe via Switzerland and Austria. As a result of this study an order was placed with the Societa Italiana Reti Telefoniche Interurbane in July, 1926, for a complete system of loaded and repeatered cables extending from Chiasso and Tarvisio on the Swiss and Austrian borders of Italy, to Naples, via Bologna, Florence, and Rome, the value of this contract amounting to approximately 500 million lire.

The proportion of the circuits in the various sections of cable was designed for estimated traffic requirements in the year 1935. It was decided to equip one-half of the ultimate circuits at once, and to load the cables to the extent of 75% in order to provide for extension between the initial and ultimate stages. It is interesting to note that in making the study of the circuit requirements, two fundamental assumptions were made regarding the probable number of subscribers in 1935 and the toll calling rate per subscriber. The latest official statistics of the Administration show that both figures had practically been reached by the year 1929, and they will certainly be passed long before 1935.

In order that the Italian Administration might have available the latest German, as well as American, practices in the art of long distance telephony, it was arranged that Messrs. Siemens & Halske, of Berlin, should join the S. I. R. T. I., and the supply of loading and repeater equipment on the present contract has been divided between the I. S. E. C. and S. & H., in the proportion, roughly, of 66% and 33% respectively.

Type of Equipment Provided

The types of cable, loading coils, and repeaters employed in the present contract are of standard

construction, and have been described before. A novel feature is the use, for the first time in Europe, of 2-wire extra light loaded circuits. This type of circuit has been used for communications between Milan and Rome with excellent results, and it will certainly become widely used in the future for distances between 600 and 1200 km. Details of the cable and loading equipment are given in Table I.

Route of Cable

The accompanying map shows the route followed by the cable, and its relation to the existing Milan-Turin-Genoa cable and the long distance cables of the concessionaires of the various "zones" in Italy. It also shows the routes by which Italy will be connected with the rest of Europe via Ventimiglia, Modane, the Simplon tunnel, Chiasso, the Brenner Pass, and Tarvisio. The route was selected after a long study of the interference problem, based on the results of the previous researches made in connection with the Milan-Turin-Genoa cable.

Cable Laying and Jointing

With such an extensive project the route conditions varied widely, comprising, as they did, the plain of Lombardy, the mountain regions of the Apennines, the marshy country between Padova and Udine, and the rocky and hilly regions between Rome and Florence, Rome and Naples, and in the neighbourhood of Trieste.

While the methods adopted for laying the cable had to be modified from time to time to meet these conditions, it was also necessary to maintain a very rapid rate of progress in order to meet the contract dates for the completion of the various sections of cable. During the summer of 1929, when the work was at its peak, approximately 400 men were employed solely on digging the trench, laying the cable, and constructing the loading coil manholes. As many as 34 drums, each containing approximately 150 meters of 112 quad cable, were laid in one day, and an average of 20 drums per day was maintained for many weeks. As the ground was not suitable for the use of mechanical excavators, and owing to the cheapness of the labour available and the desire to provide employment for the country people along

TABLE I
ITALIAN STATE TOLL CABLE SYSTEM
Details of cable and loading equipment

Cable section	Length in km.	Cable size				No. of quads loaded initially
		1.3 mm. quads	0.9 mm. quads	Radio broadcast	Total	
Milan-Chiasso.....	51.1	10	41	—	51	51
Milan-Casteggio.....	65.0	19	24	—	43	43
Casteggio-S. Giuliano.....	40.0	21	30	—	51	51
S. Giuliano-Turin.....	113.1	15	21	—	36	36
S. Giuliano-Genoa.....	79.0	—	35	—	35	35
Casteggio-Bologna.....	220.4	26	86	—	112	91
Bologna-Florence.....	109.0	27	108	—	135	105
Florence-Rome.....	286.0	26	102	—	128	100
Rome-Naples.....	246.2	12	69	—	81	56
Bologna-Padova.....	133.2	10	41	—	51	51
Padova-Mestre.....	37.5	31	32	1 screened pair 1.3	63+1 pr.	63+1 pr.
Mestre-Udine-Trieste.....	194.3	11	42	do	53+1 pr.	53+1 pr.
Udine-Tarvisio.....	102.4	7	42	do	49+1 pr.	49+1 pr.
Total route length.....	1677.2 km.					

the route, the digging of the cable trench was carried out entirely by hand labour. The actual cable laying was very highly organised, fleets of tractors, special cable lorries, and trailers being employed; and, whilst work was proceeding in the more isolated regions between Rome and Naples and between Rome and Florence, a very complete system of caravans was used for housing the men on the route of the cable (Figures 1 and 2).

The jointing of the cable was carried out according to the "Standard" system, reducing the unbalance in the individual loading sections by

cross-splicing, and making special poling tests during the installation of the loading coils in order to reduce the crosstalk on the completed repeater sections of cable to satisfactory values.

This work had to be very carefully organised in order to maintain the required rate of progress, and at the same time to maintain the quality of the work at a very high level. A total of approximately 30 squads of jointers was employed for this work; the men were divided into two groups of 10 squads each for the normal jointing within the loading sections, and a third group of 10 jointing squads for the insertion of the loading coils.



Figure 1—Cable-laying Near Naples.

Transmission Tests on Completed Repeater Sections

As each repeater section of cable was jointed, the transmission engineers made complete tests from each end of the section in order to determine that the work had been carried out satisfactorily, and that the cable met all the various requirements for good service when connected together with repeaters to form complete circuits. The tests made were as follows:

1. Insulation resistance of all wires tested singly with all other conductors earthed.
2. Loop resistance of all pairs.
3. Resistance unbalance of all pairs.
4. Attenuation at 800 and 1900 p.p.s. of all side and phantom loaded circuits.
5. Attenuation frequency curves of typical circuits for each type of loading and gauge of conductor.
6. Singing point of all loaded circuits against standard balancing networks.
7. Impedance curves on typical circuits of each kind.
8. Crosstalk within all loaded quads.
9. Crosstalk between quads forming part of the same group of circuits.
10. Crosstalk between quads in different groups of circuits.

Tests 1-5 were made from one end only of each repeater section, while tests 6-10 were made from both ends of each repeater section.

The singing points were measured with one of the 2-wire repeaters mounted in the various stations. In general the results agree within 0.2-0.4 Néper with the calculated singing points from impedance curves.



Figure 2—Jointing Camp at Cassino (Rome-Naples Section).

Tests Nos. 8, 9, and 10 were made for both far end and near end crosstalk, the total number of readings amounting to more than 5000 for each repeater section.

Results of singing point tests are given in Table II and of crosstalk measurements in Tables III, IV, and V. Details of the repeater equipment are shown in Table VI.

Repeater Stations

Practically all of the repeater stations in the present contract are new buildings which were

TABLE II
RESULTS OF SINGING POINT TESTS
Abbadia-Siena Repeater Section
Measured With Singing Point Test Set

	Singing point in Néper					
	From Abbadia			From Siena		
	Max.	Av.	Min.	Max.	Av.	Min.
1.3 mm. H-177-63—Side.....	3.71	3.45	3.13	3.78	3.41	3.08
1.3 mm. H-177-63—Phantom.....	3.74	3.39	3.05	3.78	3.45	3.06
1.3 mm. H- 44-25—Side.....	>4.3	>4.3	4.14	>4.3	4.2	3.95
1.3 mm. H- 44-25—Phantom.....	4.28	4.23	4.17	4.12	4.0	3.85
0.9 mm. H-177-63—Side.....	4.12	3.69	3.3	4.12	3.84	3.45
0.9 mm. H-177-63—Phantom.....	4.22	3.88	3.61	3.95	3.86	3.75
0.9 mm. H- 44-25—Side.....	>4.3	>4.3	4.08	>4.3	4.27	4.14
0.9 mm. H- 44-25—Phantom.....	>4.3	>4.3	3.91	>4.3	4.3	3.95

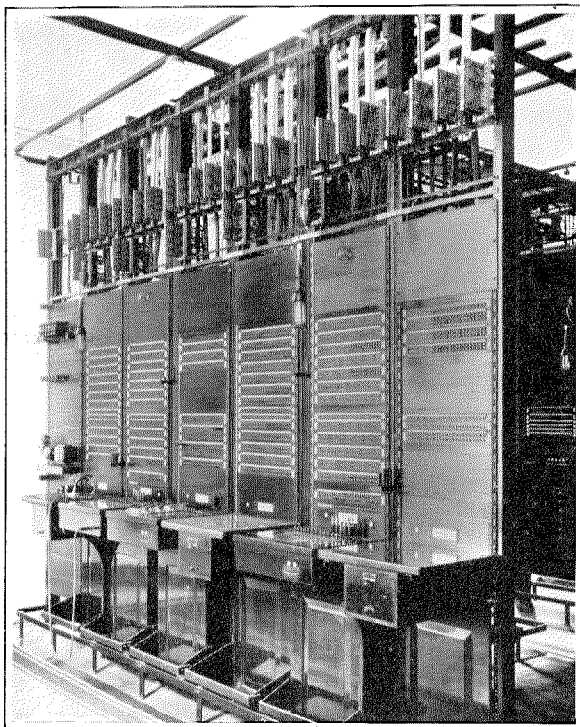

Figure 3—No. 5 Toll Test Board, Florence.

specially constructed by the S. I. R. T. I. The internal arrangements of the stations were similar throughout the route, as was the layout of the repeater equipment, power plant, and batteries, but the exterior appearance was modified from place to place in order to conform as much as possible with local architectural styles. Figures 3 to 9 inclusive show views of the equipment at Florence.

As the installation of each station was completed the following transmission tests were made on the repeater equipment before connecting it to the cable circuits:

1. Gain at 1000 cycles for all potentiometer settings, all repeaters.
2. Variation of gain with filament current, in order to check up vacuum tubes.
3. Gain frequency curves for all repeaters on at least one position of potentiometer. Several repeaters selected at random were tested for gain vs. frequency on all steps of potentiometer.
4. Singing point tests made on all 2-wire repeaters on the units, and including repeating coils and station cabling.
5. All balancing networks for 2-wire circuits adjusted against actual cable circuits.

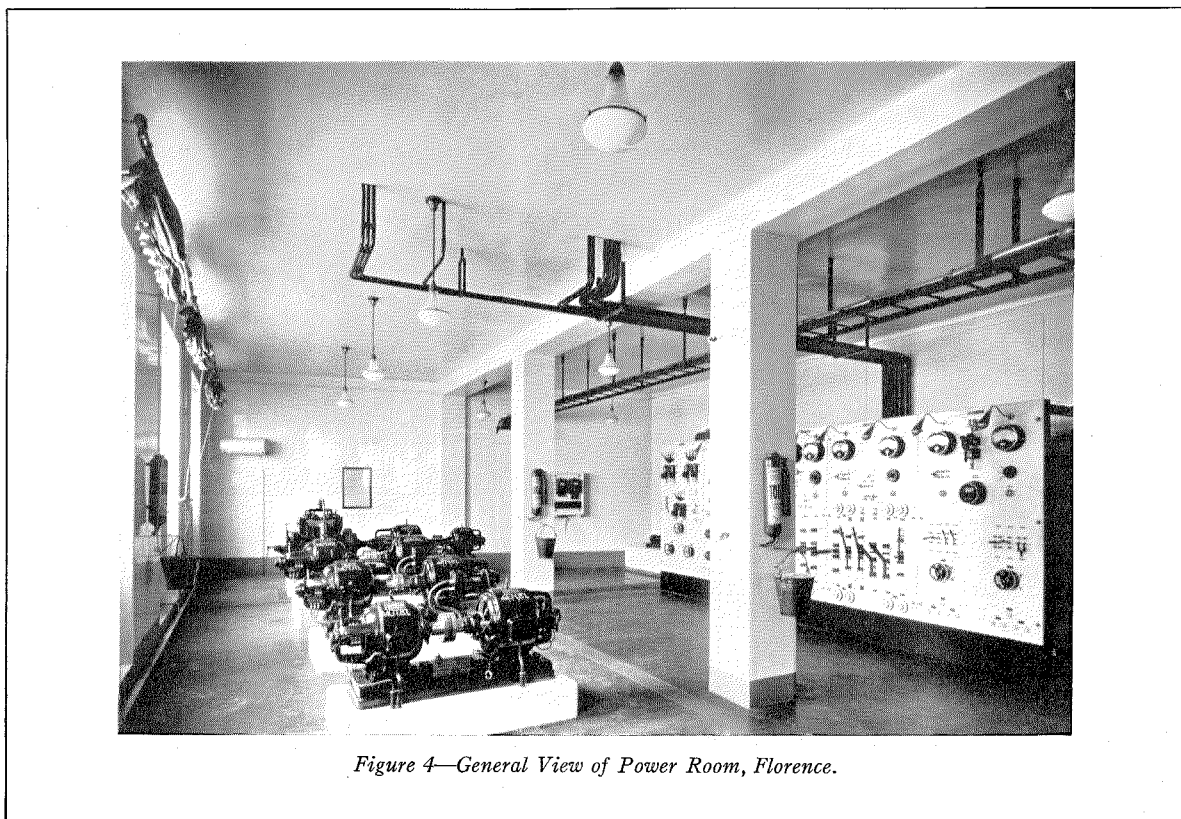

Figure 4—General View of Power Room, Florence.

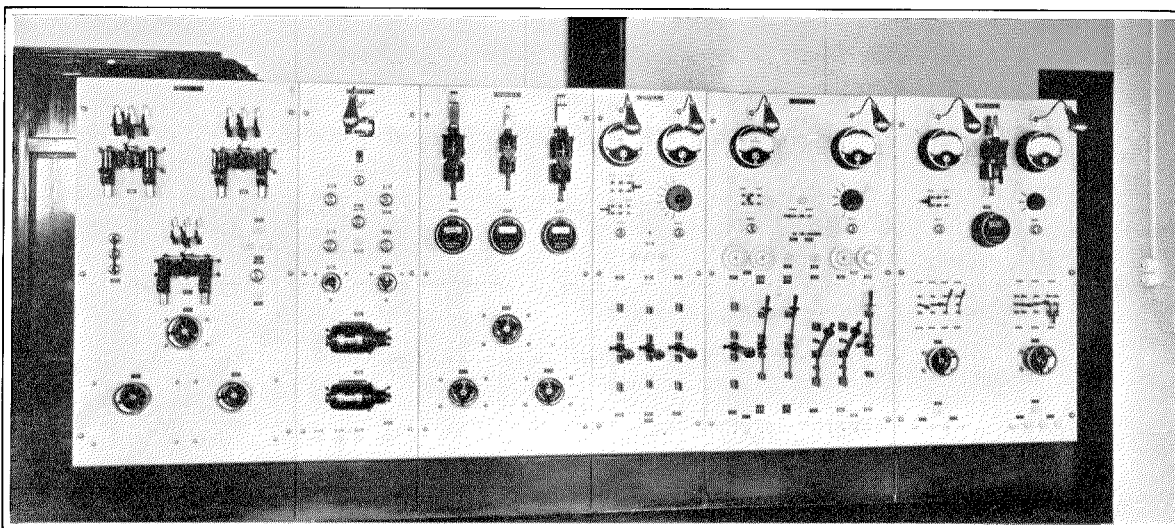

Figure 5—Power Board, Florence.

TABLE III
RESULTS OF CROSSTALK MEASUREMENTS
Rome-Viterbo Repeater Section (79.3 km.).

			Average Néper	Maximum Néper	Average Néper	Maximum Néper
Crosstalk between circuits in the same quad.	2-wire 1.3 mm. H-177-63	Ph-S S-S	8.8 9.15	8.1 8.75	9.05 9.6	8.45 9.15
	2-wire 1.3 mm. H-44-25	Ph-S S-S	9.2 10.0	8.95 9.7	9.8 11.2	9.3 10.8
	4-wire 0.9 mm. H-177-63	Ph-S S-S	8.8 9.2	8.1 8.5	9.7 10.45	8.3 9.2
	4-wire 0.9 mm. H-44-25	Ph-S S-S	9.45 10.1	8.75 9.55	11.25 12.2	10.2 11.25
Crosstalk between circuits in the same group.	2-wire 1.3 mm. H-177-63	Ph-Ph Ph-Pr Pr-Pr	9.45 9.45 9.3	8.75 8.1 8.5	9.5 9.5 9.55	8.9 8.9 8.6
	2-wire 1.3 mm. H-44-25	Ph-Ph Ph-Pr Pr-Pr	9.45 9.85 9.8	8.95 9.3 8.75	9.65 10.45 10.1	9.2 9.55 9.4
	4-wire 0.9 mm. H-177-63	Ph-Ph Ph-Pr Pr-Pr	9.15 9.1 9.0	8.3 8.2 8.0	10.0 9.8 9.95	8.9 9.2 9.0
	4-wire 0.9 mm. H-44-25	Ph-Ph Ph-Pr Pr-Pr	10.45 10.15 11.0	8.95 9.55 9.55	12.0 12.2 12.9	10.8 11.1 11.3
Crosstalk between circuits in different groups.	2-wire 1.3 mm. H-177-63 to 2-wire 1.3 mm. H-44-25	Ph-Ph Ph-Pr Pr-Pr	9.55 9.55 9.95	8.95 8.95 9.3		
	2-wire 1.3 mm. H-177-63 to 4-wire 0.9 mm. H-177-63	Ph-Ph Ph-Pr Pr-Pr	10.45 10.35 10.45	9.7 9.7 9.7		

All other combinations of crosstalk gave negligible results.

TABLE IV
RESULTS OF CROSSTALK MEASUREMENTS
Viterbo—Abbadia Repeater Section (74.0 km.)

			Near End		Far End	
			Average Néper	Maximum Néper	Average Néper	Maximum Néper
Crosstalk between circuits in the same quad.	2-wire 1.3 mm. H-177-63	Ph-S S-S	8.7 9.15	8.1 8.75	9.3 9.6	9.05 9.0
	2-wire 1.3 mm. H-44-25	Ph-S S-S	9.55 10.3	9.2 9.7	9.95 11.25	9.5 11.0
	4-wire 0.9 mm. H-177-63	Ph-S S-S	8.8 9.3	8.1 8.75	9.9 10.3	9.45 9.8
	4-wire 0.9 mm. H-44-25	Ph-S S-S	9.55 10.45	8.75 9.7	11.4 12.2	10.6 11.25
Crosstalk between circuits in the same group.	2-wire 1.3 mm. H-177-63	Ph-Ph Ph-Pr Pr-Pr	9.7 9.55 9.1	8.95 8.75 8.4	9.7 9.55 9.35	8.5 9.05 8.0
	2-wire 1.3 mm. H-44-25	Ph-Ph Ph-Pr Pr-Pr	9.75 9.6 9.8	8.95 8.75 9.1	9.6 9.9 10.05	8.9 9.0 9.0
	4-wire 0.9 mm. H-177-63	Ph-Ph Ph-Pr Pr-Pr	9.3 9.2 9.1	8.1 8.3 8.1	9.8 9.55 10.0	8.75 8.75 8.95
	4-wire 0.9 mm. H-44-25	Ph-Ph Ph-Pr Pr-Pr	10.55 10.65 11.0	9.4 9.4 9.9	11.7 11.85 12.5	10.45 10.45 11.25
Crosstalk between circuits in different groups.	2-wire 1.3 mm. H-177-63 to 2-wire 1.3 mm. H-44-25	Ph-Ph Ph-Pr Pr-Pr	9.8 9.55 9.8	8.8 8.75 8.95		
	2-wire 1.3 mm. H-177-63 to 4-wire 0.9 mm. H-177-63	Ph-Ph Ph-Pr Pr-Pr	10.65 10.35 10.55	10.1 9.55 10.1		

All other combinations of crosstalk gave negligible results.

6. Crosstalk tests between repeater units and also between complete circuits within the station, including repeating coils and all station cabling.

7. Operating tests on 20 p.p.s. and 500 p.p.s. ringer panels.

Setting Up Complete Circuits

As the various route sections of cable and repeater stations were completed, circuits within these sections were set up and handed over to the Italian Administration for service.

Transmission level diagrams were first prepared to show the gains of all repeaters along the

line, and after the repeaters had been set at these values, the attenuation of each circuit was measured at all frequencies and, if necessary, adjustments were made to the repeaters in order to make the overall characteristics of the circuit satisfactory. In lining up the XLL 2-wire circuits and all 4-wire circuits, level measurements were made at all intermediate stations in order to ensure that each repeater was adjusted correctly.

Crosstalk tests, both near end and far end, were made on the completed circuits, the voice frequency ringers were adjusted where neces-

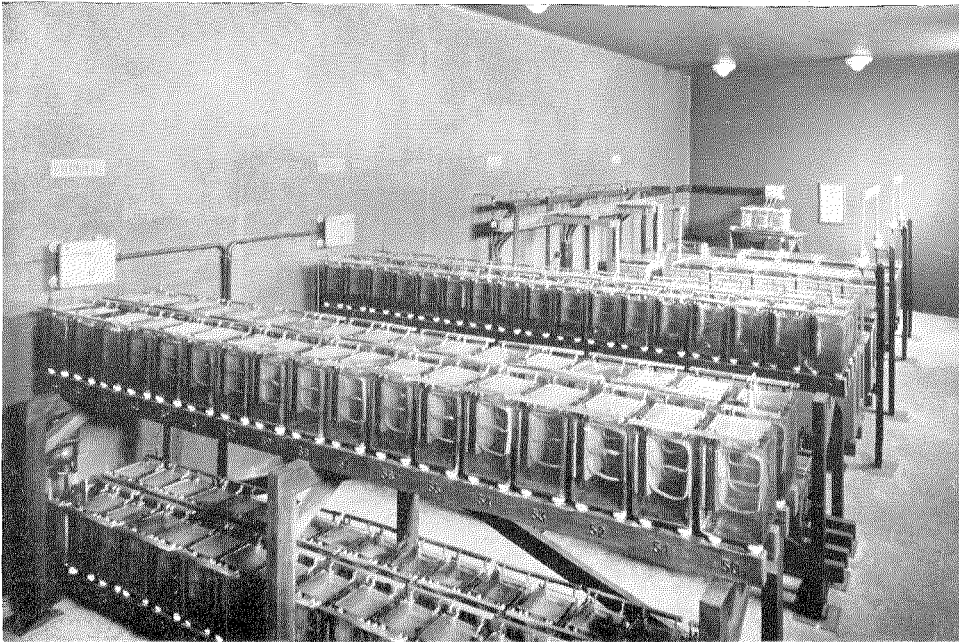

Figure 6—Battery Room, Florence.

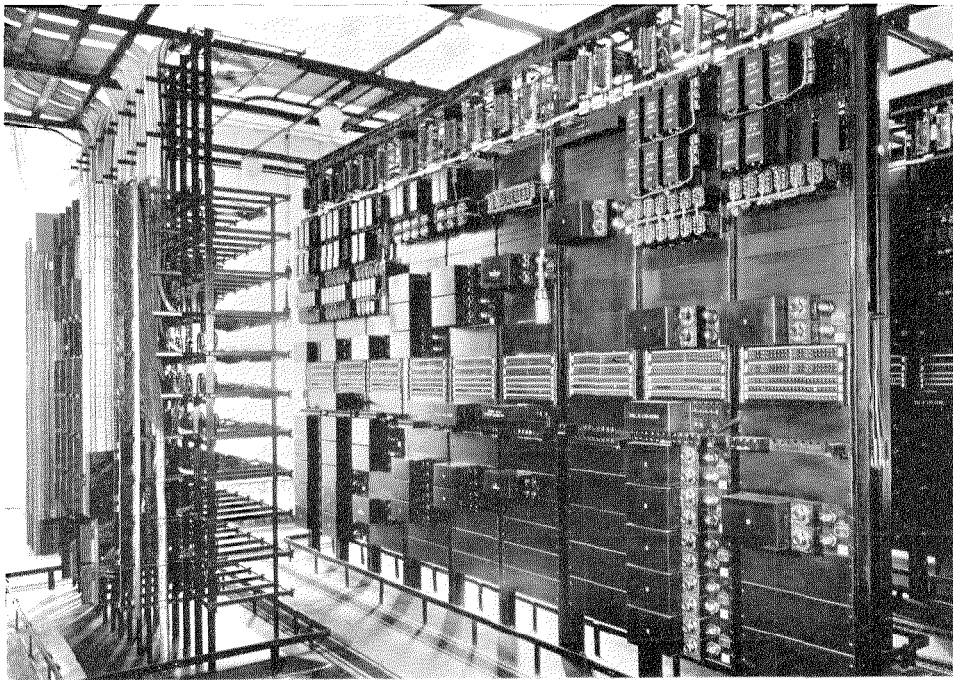

Figure 7—Combined Distributing Frame and Repeater Rack, Florence.

sary, talking tests were made to ensure that the quality of transmission was satisfactory, and the circuits were then ready to be handed over for service.

Maintenance and Operation

Under the present contract S. I. R. T. I. have to inform the Administration staff regarding the maintenance practices of the complete plant, both internal and external. Instructions have therefore been printed in Italian for the use of the maintenance staff regarding the testing and oper-

ation of the repeater and associated equipment; circuit and equipment drawings have been prepared, and complete schedules of tests on cables and repeater equipment have been sent to all repeater stations, together with all forms necessary for recording results, which are sent in weekly to the Milan office of S. I. R. T. I. Maintenance is proceeding smoothly in all stations, the overall attenuation of all working circuits being checked every week and the repeater levels being adjusted as required, in order to compensate for variation of attenuation of cable circuits

TABLE V
RESULTS OF CROSSTALK MEASUREMENTS
Abbadia—Siena Repeater Section (71.5 km.)

			Near End		Far End	
			Average Néper	Maximum Néper	Average Néper	Maximum Néper
Crosstalk between circuits in the same quad.	2-wire 1.3 mm. H-177-63	Ph-S S-S	8.8 9.05	8.3 8.4	9.25 9.8	8.8 9.25
	2-wire 1.3 mm. H-44-25	Ph-S	9.45 10.2	9.1 9.9	10.0 10.75	9.25 10.4
	4-wire 0.9 mm. H-177-63	Ph-S S-S	8.9 9.15	8.3 8.6	9.8 10.2	8.8 9.6
	4-wire 0.9 mm. H-44-25	Ph-S S-S	9.45 10.0	8.8 9.2	10.75 11.7	9.8 10.9
Crosstalk between circuits in the same group.	2-wire 1.3 mm. H-177-63	Ph-Ph Ph-Pr Pr-Pr	9.7 9.3 9.1	9.0 8.5 8.2	9.35 9.2 9.15	8.4 8.0 8.25
	2-wire 1.3 mm. H-44-25	Ph-Ph Ph-Pr Pr-Pr	9.6 9.5 9.85	9.0 8.95 9.0	10.0 10.0 10.7	8.9 8.75 9.45
	4-wire 0.9 mm. H-177-63	Ph-Ph Ph-Pr Pr-Pr	9.2 9.15 9.1	8.35 8.4 8.0	9.65 9.55 9.65	8.85 8.6 8.7
	4-wire 0.9 mm. H-44-25	Ph-Ph Ph-Pr Pr-Pr	10.55 10.7 10.7	9.45 9.45 9.3	11.85 12.0 12.2	10.65 11.05 11.1
Crosstalk between circuits in different groups.	2-wire 1.3 mm. H-177-63 to 2-wire 1.3 mm. H-44-25	Ph-Ph Ph-Pr Pr-Pr	9.6 9.5 9.7	9.0 9.2 9.2		
	2-wire 1.3 mm. H-177-63 to 4-wire 0.9 mm. H-177-63	Ph-Ph Ph-Pr Pr-Pr	10.35 10.25 9.9	9.2 9.7 9.1		

All other combinations of crosstalk gave negligible results.

TABLE VI
 ITALIAN STATE TOLL CABLE SYSTEM
 Details of Repeater Equipment

Station	No. of Repeaters in service				
	2-Wire		4-Wire		
	Initial	Ultimate	Initial	Ultimate	
Milan.....	17	31	47	110	Stations equipped with "Standard" apparatus
Turin.....	15	6	8	19	
Genoa.....	11	13	18	30	
San Giuliano.....	103	123	18	45	
Montu Beccaria.....	40	76	65	109	
San Secondo.....	32	62	52	93	
Modena.....	35	62	65	109	
Lojano.....	23	55	60	118	
Florence.....	25	47	74	141	
Siena.....	23	54	64	124	
Abbadia.....	27	51	66	125	
Viterbo.....	32	72	64	124	
Rome.....	15	39	66	139	
Ferentino.....	29	48	29	80	
Mignano.....	18	37	23	71	
Naples.....	8	17	29	80	
Poggio Renatico.....	20	29	32	32	
Padova.....	20	58	32	39	
San Dona.....	8	16	15	28	
Udine.....	17	40	26	41	
Trieste.....	24	46	
Plezzo.....	19	40	
Total.....	518	936	896	1743	

with temperature, or for any slight variations in repeater gain which may occur in practice.

Conclusion

It is hoped that this article will give a picture of the very important development work which the Italian Administration are carrying out in order to give a first class telephone service throughout the country. The various concessionaires, especially in the north of Italy, have also planned and are carrying out some very important toll cable systems within their various zones, which will connect to the State system as shown in the map.

The magnitude of these systems may be gauged from the following brief notes.

S. T. I. P. E. L. (Concessionaire for Piedmont and Lombardy).

This concessionaire has already completed the network of cables from Milan to the Simplon

Tunnel, feeding all the important towns on the Italian lakes of Como, Varese, and Maggiore, also the Milan-Vercelli-Turin cable, with branches to Alessandria, Biella, and Ivrea, and the cable from Monza to Bergamo. The total route length of these cables is approximately 570 km.

T. I. M. O. (Concessionaire for Emilia and Marche, Abruzzi and Molise).

This concessionaire has at present under construction the cable from Bologna to Ancona via Romini, having a total length of approximately 220 km.

T. E. T. I. (Concessionaire for Liguria, Toscana, Lazio, Marche, Sardegna).

This concessionaire has completed the cable from Genoa to Rapallo and Chiavari (length 45 km.) and has already planned to continue this cable on to Lucca, Florence, and Livorno.

All of the above cables have been installed by the *S. I. R. T. I.* during the last five years.

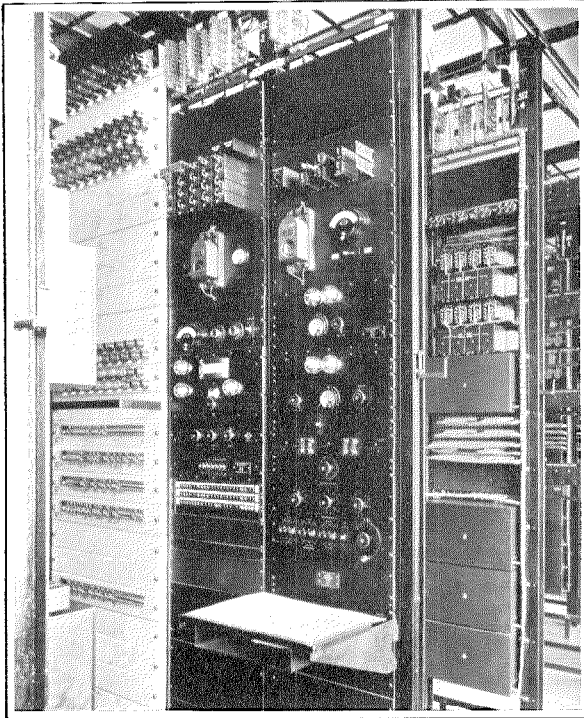

Figure 8—Transmission Testing Apparatus and Fuse and Lamp Panels, Florence.

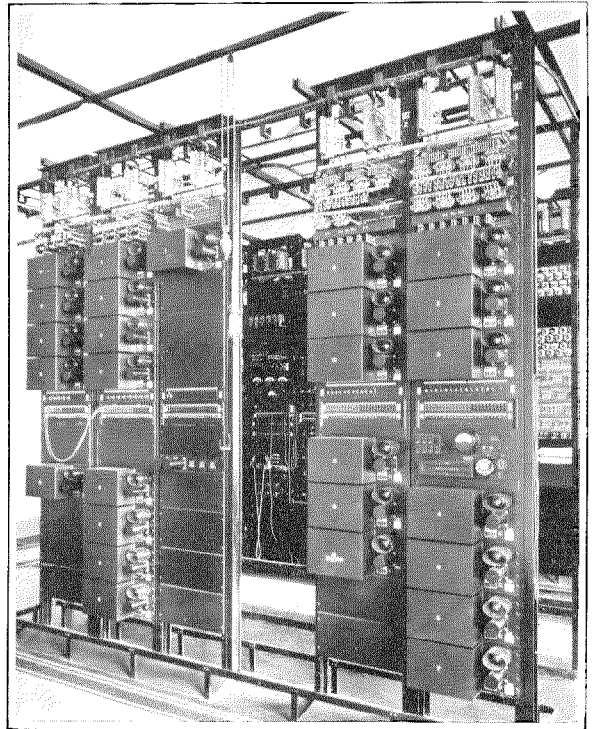

Figure 9—Voice Frequency Ringer Equipment, Florence Repeater Station.

Finally it may be mentioned that the Government have already decided to proceed as soon as possible with the extension of the State cable south of Naples to Foggia, Bari, and to Sicily, by

which time it will be possible to speak from one end of Italy to the other over repeated underground cable circuits of the most modern kind known to the art of telephony.

Some Economic Factors in the Design of Single Core Submarine Cables for Carrier Telephony

By J. R. VEZEY

European Technical Department, International Standard Electric Corporation

DEVELOPMENT work on radio telephone links connecting widely separated countries and continents has been proceeding rapidly. The question of the most economic method of connecting places not so very far apart but separated by the sea, however, has not received the same amount of study. In general, it can be said that the less the distance between any two places of equal size and importance, the greater the amount of telephone facilities required. The cases, therefore, where a multiplicity of channels is required will probably be over short distances, and the problem can generally be solved more easily by the use of a submarine cable than with a number of radio links.

Unfortunately, the paper insulated lead covered type of multi-core submarine cable is suitable only for depths not exceeding about one hundred fathoms, owing to the danger of the pressure of the water crushing the lead sheath. This type, moreover, is not suitable for use where the sea bottom conditions are severe due to possible injury to the lead sheath as a result of movements of the cable. The use of lead covered cables is therefore somewhat restricted, and in many cases it is possible to consider only cables insulated with gutta-percha or with some similar waterproof material. Furthermore, a multi-core gutta-percha insulated type of cable—the first type of submarine telephone cable in general use—cannot be used under all conditions, inasmuch as its size and weight prevent its employment at any great depth. Of the types of telephone cable used up to the present, there are only two alternatives suitable for any depth:

(a) Single conductor continuously loaded gutta-percha insulated type with a concentric earthed return. The Key West-Havana cables are representative of this type.

(b) Single conductor non-loaded gutta-percha insulated type with a concentric earthed return. The Tenerife-Gran Canaria cable is an example of this type.¹

Limitations of the loaded type of Cable

Owing to the rapid increase of attenuation with frequency and also to intermodulation troubles—both effects inherent in a continuously loaded cable—it is not possible to operate carrier telephone circuits over this type of cable, except for the very shortest distances. Generally speaking, it can be said that only one telephone channel, on a 2-wire voice frequency basis, is possible. In order to operate the cable on a balanced basis, it is essential that the singing point should be higher than the total attenuation of the cable itself over the entire frequency range in use. On the Key West-Havana Cables, the singing points obtained were of the order of 30 to 35 decibels over the voice frequency range. With modern improvements, by which the impedance irregularities are more effectively smoothed out, it is expected that a singing point of about 40 decibels could be obtained. This, therefore, is the upper limit for the attenuation to which any cable of this type can be designed to work on a balanced system. Employing loading and dielectric materials at present in general use, and assuming that cables in the future cannot be laid of much greater weight than in the past, the limiting distance for such a type of cable is about 200 nautical miles. For shallow water it would, of course, be possible to increase this distance somewhat.

Extended range of non-loaded carrier cables

With the non-loaded type of cable there are no such limitations to the number of channels, the rate of increase of attenuation with frequency being much more gradual and there being no intermodulation effects such as are introduced by loading. During the manufacture, and after

¹ See Mr. F. T. Caldwell's article "The Tenerife-Gran Canaria and Algeciras-Ceuta Cable Systems" in this issue of *Electrical Communication*.

laying, of the Tenerife-Gran Canaria cable, it was found possible to obtain a singing point of 50 decibels up to a frequency of 30 kilocycles. The attenuation at this frequency was also about 50 decibels. It is therefore possible to operate this cable on a 2-wire balanced basis up to that frequency, which is sufficient to allow the working of six carrier telephone channels in addition to one voice frequency channel. The length of this cable is 40 nautical miles. It is at once obvious that this type of cable, for short distances at least is far more economical than the loaded type owing to the greatly increased number of channels it provides.

It is possible by sacrificing one-half of the number of carrier facilities otherwise obtainable to extend considerably the range of working of this type of cable by operating the carrier circuits on a 4-wire basis, i.e., using different frequency bands for the "go" and "return" currents. The singing point requirements for 2-wire working are thus not necessary, and hence the attenuation can be considerably increased above that of 50 decibels. Suggestions have been made for operating cables of this type with attenuations of over 100 decibels.

Assumptions in Primary Constants for Cable

The previous remarks show the possibilities of this type of non-loaded carrier cable. In the actual design itself, there are three variables which have to be taken into account:

The weight of the central copper conductor.

The weight of the gutta-percha dielectric.

The weight of the return copper conductor.

In the economic study under review certain assumptions, detailed below, were necessary with regard to the primary constants.

(1) *Resistance.* The resistance can be divided up into three components, the D.C. resistance of the central conductor, the skin effect of the central conductor and the resistance of the return conductor. The main difficulty here was in estimating the skin effect. The method adopted was to calculate the skin effect from theoretical formulae² for solid conductors and to apply corrections, increasing with frequency,

² Alexander Russell, *Alternating Currents*, 1914, Vol. 1, p. 229.

which had been found necessary from actual tests on stranded conductors. A temperature of 60° F. was assumed throughout.

(2) *Inductance.* As the frequency increases, the closer the return path of the current converges towards the dielectric, with a consequent reduction in inductance. The problem of accurately computing the inductance from purely theoretical formulae is therefore somewhat complex. In this case, the method adopted was to calculate the inductance from the dimensions of the core, assuming that it consisted of a solid central conductor surrounded by a hollow copper cylinder insulated from it. The next step was to apply corrections for different frequencies based on actual tests on various sizes of core.

(3) *Capacity.* The capacity of gutta-percha cables at carrier frequencies, although considerably lower than the D.C. value, varies very little with frequency. A specific inductive capacity constant of 2.92 was assumed in all cases. This is a typical value for ordinary gutta-percha at carrier frequencies.

(4) *Leakance.* The leakance varies considerably with the temperature and pressure of the water and, of course, with the actual constitution of the dielectric used. The data assumed were taken from the following formula which gives values, over the range of frequency considered, for average sea bottom conditions for standard mixtures of gutta-percha:

$$\frac{G}{C} = 0.0105 f^{1.28}$$

where

G = leakance in micromhos per nautical mile.

C = capacity in microfarads per nautical mile.

F = frequency in cycles per second.

Determination of most economical weight of return conductor

As a preliminary in the study to find the most economic design of non-loaded carrier cable for any given case, it appeared desirable to obtain some idea of the most suitable weight of return conductor, leaving the question of the correct proportion of copper to gutta-percha till later. In the case of non-loaded telegraph cables, the most economical design for any given length and desired speed is that in which the ratio of

the weight of gutta-percha to the weight of copper is a minimum compatible with mechanical considerations, i.e., the weight of gutta-percha is fixed by the minimum wall thickness of dielectric considered essential. In Figure 1 are

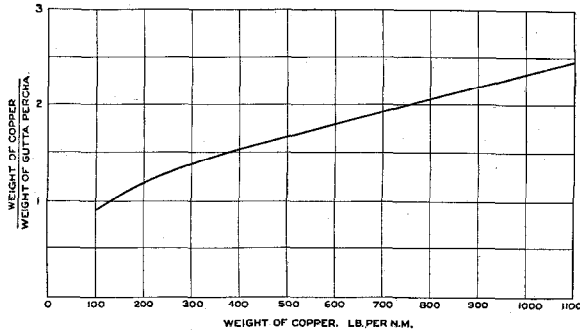

Figure 1—Ratios of Weight of Copper to Weight of Gutta-percha as Used in Present Day Telegraph Cable Practice.

the ratios of the weight of copper to the weight of gutta-percha for different sizes of conductor as used in telegraph cable practice. In the preliminary study to find the correct weight of return conductor, these ratios were assumed.

The attenuations were then worked out at various frequencies for cores with conductors of 300, 350, 400, 450, 500, and 550 lbs. per nautical mile, for each of which separate computations were made assuming return conductors (excluding the protective tape) of weights of 600, 700, 800, and 900 lbs. per nautical mile. The frequencies chosen for this study were 10, 20, and 30 kilocycles, which give approximately the frequency band necessary to allow the operation of 2, 4, and 6 carrier telephone channels respectively (i.e., on a 2-wire basis). Although a singing point of 50 decibels up to 30 kilocycles had been obtained on the Tenerife-Gran Canaria cable, thus allowing the operation of telephone channels on a 2-wire basis up to an attenuation of 50 decibels, it was decided for design purposes to allow a certain factor of safety for possible reduction in singing point due to subsequent repairs to the cable, and to choose 45 decibels as the maximum attenuation at any frequency. If, therefore, the figure for attenuation per unit length, calculated from any one design, is divided into 45, the result gives the maximum length over which that design is suitable for 2-wire operation for that particular frequency. This was

done for all the different designs enumerated above. The resulting lengths were plotted against the cost, as in Figure 2. The individual points were then joined up so that the small curves show the effect of varying the weight of return conductor while keeping the weight of the central conductor fixed. The points where the envelopes (shown as dotted lines) touch the small curves, indicate the most economical weight of return conductor. The reason for this is as follows: The lowest cost for any given length and desired frequency is given by drawing an ordinate through the desired length. The point where this ordinate intersects the envelope indicates the cheapest possible design. If an infinite number of the smaller curves be drawn for an infinite number of sizes of central conductor, the particular curve which is tangential to the envelope at the point of intersection, as above, gives the most economical weight of central conductor, and the point of intersection on the smaller curve gives the most economical weight of return conductor.

It is seen in Figure 2 that the small curves at 30 and 20 kilocycles all lie nearly parallel to their respective envelopes. This indicates that for these frequencies there is considerable latitude in the selection of the weight of the return

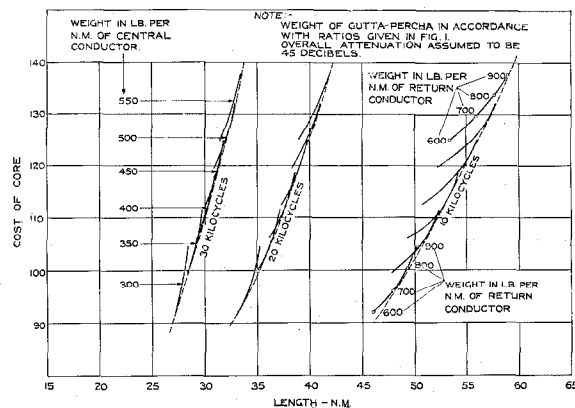

Figure 2—Curves Showing the Effect of Varying the Weight of the Return Conductor, While Keeping the Weights of the Central Conductor and Gutta-percha Fixed.

conductor. At 10 kilocycles the effect of varying the weight of the return conductor is more marked, but it can be said that, over the range of practical sizes of core, a return conductor

weighing 800 lbs. per nautical mile will not be far from the optimum weight.

Determination of the correct proportion of gutta-percha to copper

Having obtained some idea of the most suitable weight of return conductor, the main question in determining the most economical design—the correct proportion of gutta-percha to copper—was considered.

Cores with conductors of 300, 350, 400, and 450 lbs. per nautical mile were assumed. For each of these conductors attenuations were worked out with four different weights of gutta-percha, the first in accordance with the ratio given in Figure 1, and the others with increases in weight of gutta-percha of 25%, 50%, and 75%. In all cases, the return conductor was taken to weigh 800 lbs. per nautical mile. Similar assumptions as to attenuations were made as before, and the results were plotted in Figure 3. The individual points were joined up to show the effect of varying the weight of gutta-percha for any given weight of central conductor.

The striking feature brought out by these curves is that the actual ratio of the weight of gutta-percha to the weight of copper appears, over a wide range, almost immaterial, i.e., for any given length of cable and desired number of channels, the most economical design can be obtained either with a small conductor and large amount of insulation or with a relatively larger conductor and a relatively smaller amount of insulation.

This follows from the fact that an envelope for each particular frequency would very nearly coincide with the small curves over practically the whole of the range of weight of gutta-percha considered. In fact it can be said that any design having the ratio of the weight of gutta-percha to the weight of copper between those given in Figure 1 and ratios 50% greater, would be suitable.

Owing to the difficulty of separating the envelopes from the small curves, the envelopes are not shown in Figure 3.

In Figure 3, the cost of gutta-percha was taken to be five times that of copper. It seemed possible that these conclusions might be different if the relative proportion of the price of gutta-percha

to the price of copper were altered. Accordingly these figures were again plotted, taking the cost of gutta-percha to be eight times that of copper.

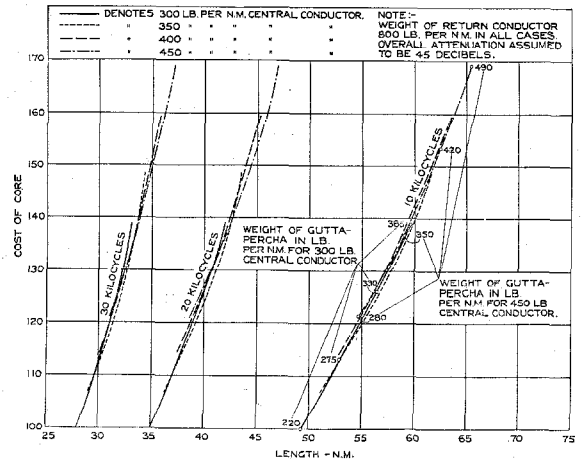

Figure 3—Curves Showing the Effect of Varying the Weight of Gutta-percha While Keeping the Weights of the Central and Return Conductors Fixed.

It was then found that the conclusions previously arrived at were in no way changed.

General Conclusions

It has been shown that having decided on the length, attenuation, and number of speech channels for any cable, the relative proportions of the weights of the central conductor, dielectric and return conductor to obtain the lowest cost can be varied over a wide range.

A further feature, brought out by this study, is that the maximum length of cable over which it is possible to work a fixed number of channels, varies relatively little within the limits of practical sizes of core. For example, taking the 30 kilocycle curve in Figure 3, and the smallest core considered, the maximum length over which it is possible to operate six carrier telephone channels on a 2-wire balanced basis is 28 nautical miles. With the largest core considered, it is possible to operate this number of channels over a distance of 37 nautical miles—an increase of length of merely 32%. The increase in cost over this range is 69%.

This leads to the conclusion that over any given length there is a more or less fixed number of channels capable of being economically oper-

ated, since any attempt to increase this number would involve such a large increase in weight of the core that it would probably be impractical on mechanical grounds, and the operation of a less number would mean that maximum use was not being made of the cable itself. The maximum size of core considered in this article, consisting of a 450,490,800 core, is itself somewhat heavier than any that have yet been laid; and owing chiefly to the difficulties involved in repair work, there is no prospect at the moment that cores much larger than this will be used in very deep water.

In Figures 2 and 3, the lengths given are those over which 2-wire operation with an attenuation at 45 decibels is possible. These results can easily be reproduced for considerably higher attenuations suitable for 4-wire working. In Figure 4 are given similar envelopes assuming the maximum attenuation as 100 decibels.

Finally, it must be stated that the results given in this article are based on the employ-

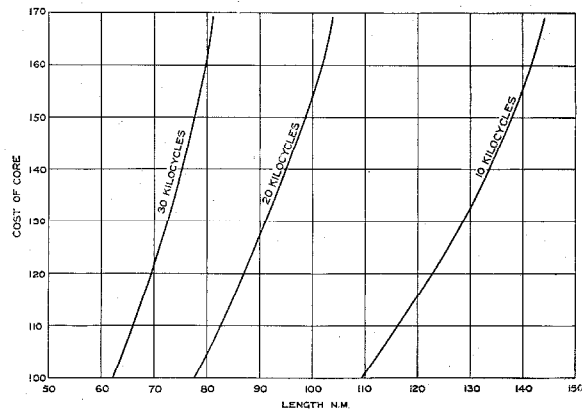

Figure 4—Curves Showing the Cost of the Most Economic Design of Core for any Length, Assuming an Attenuation of 100 Decibels at Each Particular Frequency.

ment of ordinary gutta-percha. If improved dielectrics, with lower capacity and leakance constants are introduced, the range, over which the type of cable can be used, will naturally be increased. It is unlikely, however, that the general conclusions arrived at will be materially altered.

The Tenerife-Gran Canaria and Algeciras-Ceuta Cable Systems

By FRED T. CALDWELL

*Chief Engineer, Compañía Telefónica Nacional de España, and
Vice President, International Telephone and Telegraph Corporation (España)*

IN the special February 1930 edition of *Electrical Communication* which was primarily concerned with the radio link connecting Spain and South America, telephone service from Spain to Spanish Morocco and to the Canary Islands was referred to as among the recent activities of the International Telephone and Telegraph Corporation (I. T. T. España). The Spain-Spanish Morocco service is furnished by means of the Algeciras-Ceuta submarine cable, 19.7 nautical miles in length; and the service between Tenerife and the Gran Canaria, Canary Islands, by means of the Santa Cruz-Sardina Bay cable, 39.7 nautical miles in length. A recently opened radio telephone link connects Tenerife with Spain. Both of the cables, especially the latter, contain features of technical interest which it is proposed to discuss in this paper from the transmission viewpoint, more particularly the singing point requirement.

The Compañía Telefónica Nacional de España (C. T. N. E.) has a concession to operate not only in Spain itself, but also in Ceuta, Africa, and the Canary Islands. One of the earliest actions of the C. T. N. E. was to establish in 1924, during the Riff War, telephone communication between Madrid and Tetuan (Morocco) using, for the purpose of this national emergency, one of the existing Government telegraph cables between Algeciras and Ceuta. Through line repeaters were installed in Algeciras. In December, 1924, the C. T. N. E. arranged for the laying of a non-loaded telephone cable between Algeciras and Ceuta, thus setting free the telegraph cables. Cord repeaters were subsequently substituted for the through line repeaters in Algeciras and this cable was then operated as an Algeciras-Ceuta circuit capable of being switched at Ceuta to Tetuan and at Algeciras to any town in Spain.

The principal centres of commerce in the Canary Islands are Las Palmas on the island of Gran Canaria, and Santa Cruz on the island of

Tenerife. These two towns are ports of call for a number of steamship lines between Europe, South America, and South Africa. The islands derive a considerable amount of revenue from fruit export trade, tourist traffic, and fuelling facilities.

The C. T. N. E. realised the advantages of linking these towns to the telephone network in Spain and studied the most advantageous way of achieving this object. The results indicated that a radio link should be provided from Santa Cruz to Spain and that the connection between Las Palmas and Santa Cruz should be made by means of land lines and a submarine cable similar to the Catalina Island Cable¹ and capable of providing six channels, i.e., four carrier telephone channels, one voice frequency telephone channel, and one composite telegraph channel.

For reasons of convenience it was decided to design the Algeciras-Ceuta and Tenerife-Gran Canaria Cable Systems simultaneously, and to use the same type of cable throughout—a desirable feature from the point of view of spare cable.

The preliminary planning of these systems was carried out by the I. T. T. (España) and International Standard Electric Corporation in collaboration, the former having been responsible for the construction of the repeater stations and land lines and for the equipment engineering, while the latter acted as consultant engineers in connection with the manufacture and laying of the cables, and arranged for the supply of all the special equipment items in accordance with the I. T. T. requirements.

Figure 1 illustrates the simple case of a submarine cable equipped with two carrier "terminals," each comprising a modulator, demodulator, amplifiers, and 4-wire terminating sets, the

¹H. W. Hitchcock, "Applications of Long Distance Telephony on the Pacific Coast," *Journal of A. I. E. E.*, 1923, Vol. 42, p. 1264.

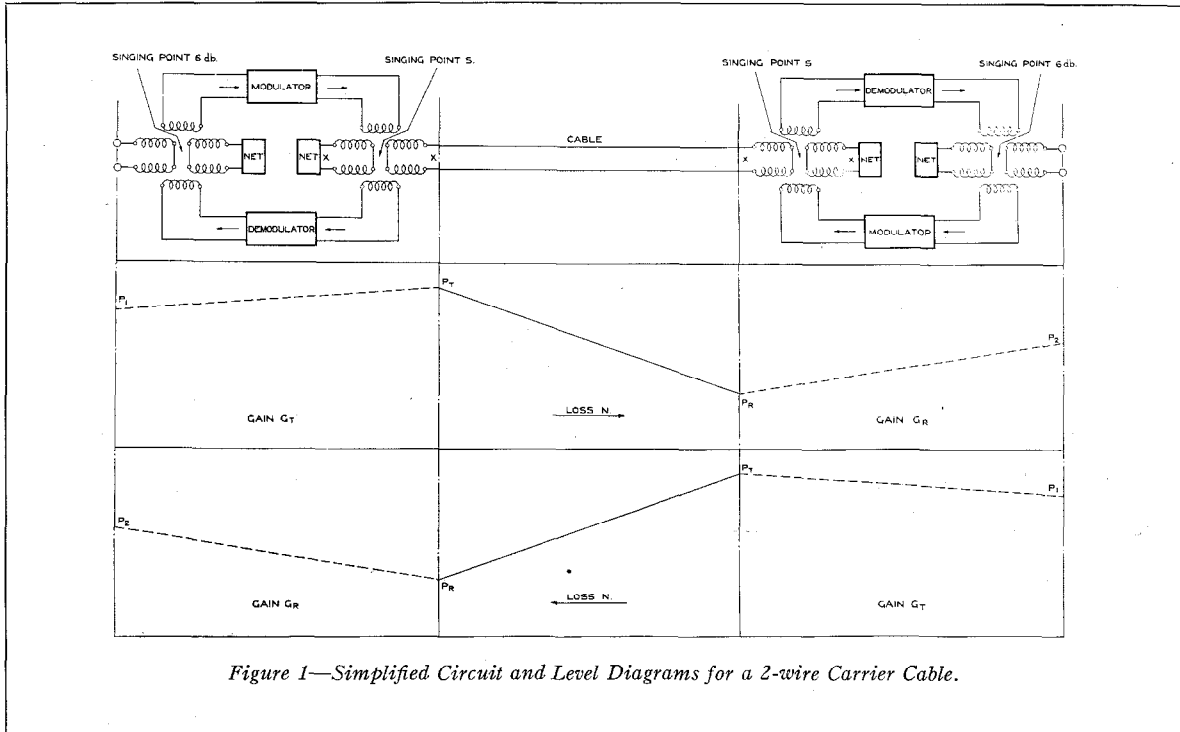

Figure 1—Simplified Circuit and Level Diagrams for a 2-wire Carrier Cable.

cable being assumed to be brought into the two repeater stations, which also form the toll offices. Suppose the loss of the cable at the carrier frequency considered is N decibels (db.), and that the overall loss from the voice frequency input at one end of the system to the voice frequency output at the other end is to be 10 db. Further, let the net transmitting gain of each carrier terminal be G_T and the net receiving gain G_R .

Let S be the singing point (assumed the same at both ends) of the cable, at carrier frequencies, against its balancing networks. The singing point of the subscriber's loops, against the compromise balancing networks, can be assumed to be 6 db. in each case. It is well known that a 22 type repeater will sing when the sum of the gains is equal to the sum of the singing points. Each carrier terminal may be regarded as a 2-wire repeater and therefore the condition for singing is that

$$G_T + G_R = S + 6$$

but in order that there may be a 10 db. overall loss,

$$G_T + G_R = N - 10,$$

where N is the total loss between terminals

$$\therefore S = N - 16.$$

If, therefore, S is made equal to N it is possible to increase both G_T and G_R by 8 db. before singing occurs. For satisfactory operation the necessary margin is obtained by making the singing point at least equal to the overall loss over the entire range of frequency in use—a margin of 8 db. being quite adequate.

The attenuation of a single-core, gutta-percha, submarine cable, at a frequency of 20,000 periods per second—the frequency band necessary for the operation of four carrier channels—can hardly be reduced below 1 db. per nautical mile without making the cable unwieldy. Hence, for the Tenerife-Gran Canaria cable (39.7 nautical miles) it was necessary to obtain a singing point of the order of 40 db. It was, therefore, obvious from the beginning that the singing point of the Tenerife-Gran Canaria Cable would have to be carefully watched during manufacture. The methods by which the singing point of the cable was controlled are described in another article in this issue of *Electrical Communication*.² These methods were such an improvement over previous

² K. E. Latimer and J. R. Vezey, "The Tenerife-Gran Canaria and Algeciras-Ceuta Submarine Cables."

practice that a singing point of 50 db. was obtained at frequencies up to 30,000 periods per second. The operation of six carrier telephone channels was thereby made possible instead of the four originally planned, since the attenuation at 30,000 cycles was 48 db. and the singing point

posite and composite balancing sets alone, all filters being restricted to the 4-wire portion of the circuit. The carrier 4-wire terminating sets were placed in the cable huts. The ultimate arrangement of the equipment is shown in Figure 3. It will be noted that while the repeater stations and cable huts are in separate locations, the circuit arrangement is essentially the same as in Figure 1 in consequence of the provision of interconnecting circuits on a 4-wire basis between them. The loss from Galdar to Las Palmas is not large enough to affect the problem appreciably from the echo standpoint.

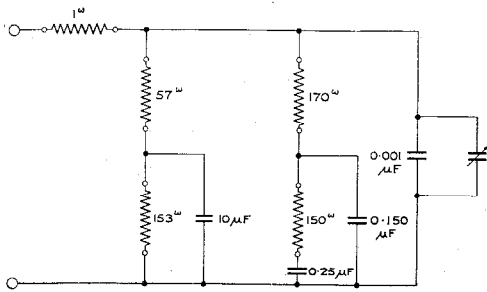

Figure 2—Carrier Network at Sardina Cable Hut.

Figure 4 shows the loss from the input winding of the 4-wire terminating set at Regla to the output winding of that at Sardina (i.e. the direct transmission loss); also the loss from the input winding of the set at Sardina to the output wind-

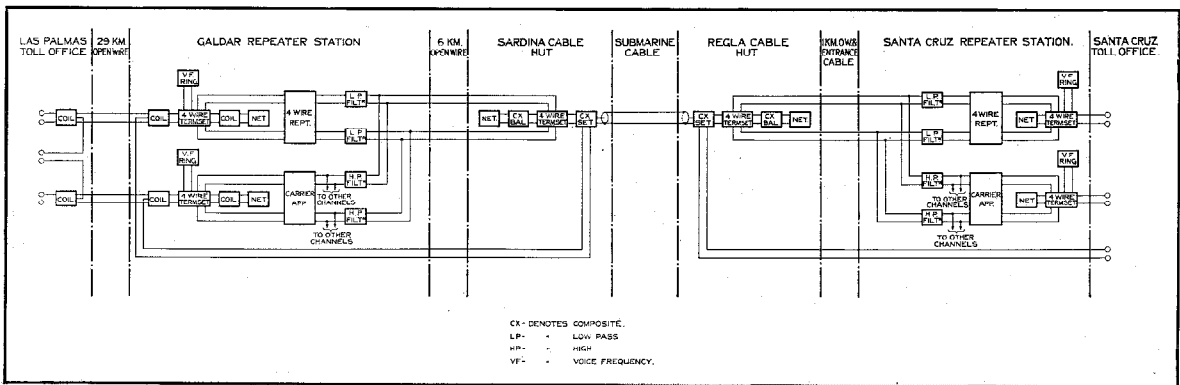

Figure 3—Ultimate Circuit Layout Diagram for the Tenerife-Gran Canaria Cable.

as just stated was not less than this figure, thus allowing a good singing margin.

Providing such a high-grade cable without devising equipment capable of utilizing the high singing point would of course be useless. For example, a network accurately simulating the cable impedance is required. Building it proved an exceedingly difficult task. The form and approximate values of the components of the Sardina network are given in Figure 2. The exact values were finally adjusted in accordance with impedance measurements. It was also necessary to use carefully balanced carrier 4-wire terminating sets and to ensure that the amount of wiring and apparatus in the parts of the circuit indicated by X in Figure 1, was reduced to a minimum. This extra apparatus was cut down to the com-

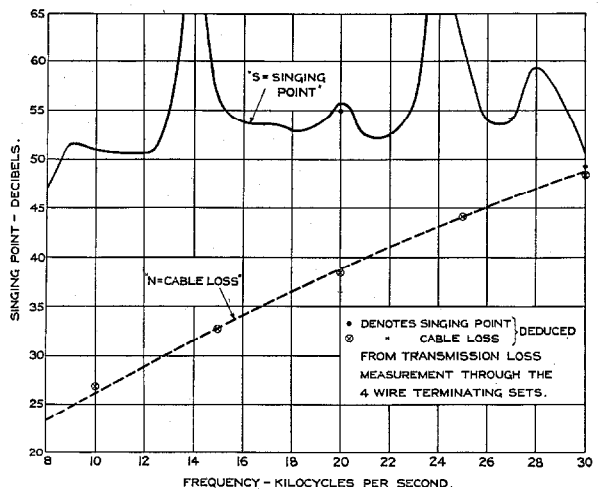

Figure 4—Singing Point and Overall Loss Measured Through Terminal Equipment.



Figure 5—Cable Hut, Santa Cruz, Tenerife.

ing of that set (i.e., the echo loss). In each case the known loss of the hybrid coil was deducted from the actual readings so that the points shown represent the quantities previously referred to as N and S. The smooth curves, which are reproduced from Figure 9 of the article which follows,³ show the singing point determined by impedance measurements and the loss determined by open and short circuit measurements. This indicates that the balance of the carrier 4-wire terminating set is at least as good as that of the cable.

Similar results were obtained at Regla, where, however, it was found necessary to use a small air cored inductance element in the network.

In order that the service might be opened with minimum delay, it was decided to operate only the voice frequency channel initially, and this temporarily on a 4-wire basis. The special hybrid coil in each hut was, therefore, cut out and replaced by an ordinary repeating coil connected to the repeater station by a single open wire circuit. The networks were transferred to the repeater stations. The ultimate circuit layout,

Figure 3, will be adopted when the carrier circuits are required.

The inauguration of the Tenerife-Gran Canaria service took place on the 24th of October, 1929, on which occasion the Military and Civil Governors of the islands and many other officials exchanged greetings. It soon became evident that it was fulfilling a public demand.

The Algeciras-Ceuta Cable is much shorter than the Tenerife-Gran Canaria Cable and has a singing point of about 40 db. It was placed in service on the 25th of July, 1929, only the voice frequency channel being equipped initially.

As a result of the opening of the Canary Islands cable service along with the inauguration on January 22nd of this year of the radio telephone service between Europe and the Canary Islands by the Compañía Telefónica Nacional de España, both Tenerife and Gran Canaria are in direct telephone contact with the European network. Likewise, Northern Africa, by means of the Algeciras-Ceuta cable and the network of the Compañía Telefónica Nacional de España, is in telephone contact with Europe, North and South America.

³ K. E. Latimer and J. R. Vezey, "The Tenerife-Gran Canaria and Algeciras-Ceuta Submarine Cables."

Tenerife-Gran Canaria and Algeciras-Ceuta Submarine Cables

By K. E. LATIMER and J. R. VEZEY

European Engineering Department, International Standard Electric Corporation

SYNOPSIS. This article refers to the design, manufacture, and laying of a submarine single-core multi-channel carrier telephone cable between Las Palmas and Santa Cruz, Tenerife. It also relates to the provision of a similar cable for the Algeciras-Ceuta route. The main feature of the work is the design of a special type of submarine telephone cable, the core of which is insulated with gutta-percha surrounded with copper wires to act as a sea-return conductor. In addition to this special type of core, an important feature of the work is the improvement in the methods adopted for the allocation of the lengths of core to obtain smooth impedance distribution, whereby a singing point of 50 decibels was obtained up to a frequency of 30 kilocycles. A further novelty is the method of measuring the attenuation, whereby tests were carried out up to 50 decibels by the "open and short" method.

IN 1927, the Compañía Telefónica Nacional de España of Madrid considered the desirability of linking up the islands of Gran Canaria and Tenerife by a submarine multi-channel carrier telephone cable, to provide circuits between Las Palmas on the island of Gran Canaria and Santa Cruz on Tenerife. It became necessary at the same time to lay a cable across the Straits of Gibraltar, in addition to the one laid in 1924, between Algeciras in Spain and Ceuta in Morocco. Although the length of this cable was only about half that of the Tenerife-Gran Canaria Cable, it was considered desirable that the two cables should be of the same construction. Accordingly, these two cables were considered as one project, although geographically they have no connection with one another. The location and the principal connecting circuits are shown in Figure 1.

The greater length of the Tenerife-Gran Canaria cable introduced difficulties which were unimportant on the Algeciras-Ceuta Cable. Consequently, in this article, only the former cable will, in general, be discussed; and the various tables and graphs refer, unless otherwise stated, only to that cable.

Type of Cable

The considerable depth, which attains a maximum of 1,500 fathoms between the islands

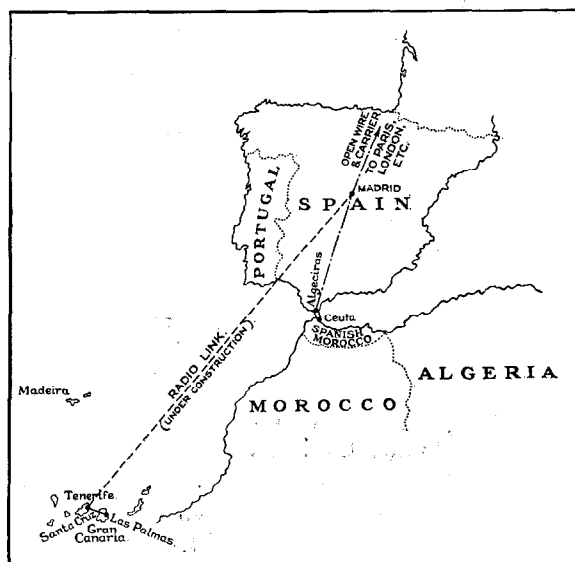

Figure 1—Map Showing Location of Tenerife-Gran Canaria and Algeciras-Ceuta Cables.

of Tenerife and Gran Canaria, and the desire to obtain as many carrier channels as possible, precluded the use of any type other than a single core gutta-percha cable with an earth return. The idea of this type of cable was developed by Devaux-Charbonnel,¹ in 1913, and the first telephone cable to be manufactured with a concentric external return conductor was made in 1914

¹ Devaux-Charbonnel, *Journal Telegraphique*, May 25, and June 25, 1913.

by the Nordeutsche Seekabel Werke, for the Adriatic, but was not laid until 1920.

Owing to the losses which would have been introduced by loading material at carrier frequencies, the Tenerife cable was, of course, non-loaded. The only comparable carrier telephone cables that had hitherto been laid were those between the island of Santa Catalina and the mainland of California. These were, however, rubber insulated, and their length was only slightly more than half that of the shortest distance between Tenerife and Gran Canaria.

In order to make the maximum possible use of the cable itself, it was decided to operate all the channels on a 2-wire balanced basis. In deciding the actual layout of the system, and the actual dimensions of the cable itself, the following were the main considerations:

1. The landing-place to be chosen to give minimum length of cable, i.e., minimum over-all attenuation, and therefore maximum number of channels.
2. The maximum permissible size of cable to be determined by the mechanical conditions corresponding to the depth and to the nature of the sea bottom.
3. A 2-wire balanced system necessitates the singing point being higher than the over-all attenuation of the cable for the entire range of frequency in use.

Concerning the first of the above points, the length of the cable depended considerably on the choice of landing place on Gran Canaria. The town of Las Palmas lies on the northeast corner of Gran Canaria and on the opposite side to Tenerife. The length of a cable connecting Tenerife and Las Palmas directly would have been about 55 nautical miles. The only place close to Las Palmas where it would have been at all reasonable to land the cable was already crowded with four telegraph cables, and was also admittedly a bad landing place. It was also realized that on such a length, and on the basis of previous experience, only two carrier channels would have been possible. It was, therefore, decided to land the cable in Sardina Bay on the northwest side of the island, an excellent landing place, thus shortening the route to about 40 nautical miles. Galdar, the nearest village to Sardina Bay of any importance, and about 6 km. distant, was chosen as the position for the repeater station. At Santa Cruz, a landing place about 1 km. from the existing office was chosen.

The layout of the stations, land lines, etc., of the Tenerife-Gran Canaria, also the Algeciras-Ceuta, cable systems is given in Figure 2.

With regard to the third problem mentioned

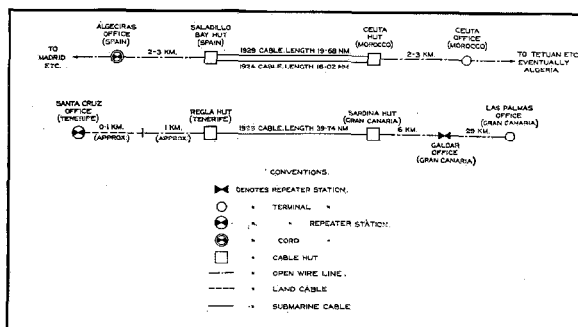

Figure 2—Layout of Cable Systems.

above, a design was finally chosen which satisfied mechanical consideration as to weight, and which was expected on the basis of previous experiences to give four carrier channels. But in consequence of novel methods adopted during manufacture to increase the high frequency singing point of the cable, described in detail later, it will be possible to obtain six carrier channels when the equipment is installed. At present only the voice frequency channel is being operated.

In order to utilize the expected high singing point of the cable, and thus provide more channels than would otherwise have been possible, a layout will ultimately be adopted with a 4-wire circuit between the repeater stations and cable huts, and with a special hybrid coil common to all the telephone channels

The particular feature of this arrangement is that the filters separating the voice and carrier channels are placed in the 4-wire portion of the circuit where the impedance is not of primary importance. Composite filters are, however, placed in the 2-wire portion of the circuit, but tests have shown that no difficulty is introduced by this arrangement.

With regard to the actual design of the cable itself, it is of interest to mention that the deep sea type is the heaviest that has ever been laid in 1,500 fathoms.

Cable Design

Core. The design of the core for telephone cables, particularly carrier cables, differs some-

what from that of a telegraph cable. With a telegraph cable, the most economical design for any given speed and length is that in which the ratio of the weight of copper to the weight of gutta-percha is a maximum compatible with the minimum permissible thickness of insulation—the reason being that gutta-percha is by far the most expensive item in the manufacture of submarine cables.

With a telephone cable, however, above a certain size of conductor, no very considerable reduction in attenuation can be made by increasing the core size and using ratios of the weight of copper to the weight of gutta-percha similar to those used in present day practice for telegraph cables. In Figure 3 these ratios are shown for different weights of copper. The reason for this can best be seen by considering the ordinary attenuation formula, which for high frequencies—the expression $\frac{\omega L}{R}$ being large—can be reduced by neglecting the leakance term, to the following simple expression:

$$\text{Attenuation} = \frac{R}{2} \sqrt{\frac{C}{L}}$$

when R = resistance

C = capacity

L = inductance

$\omega = 2\pi \times$ frequency per second.

The effect, on each of the above quantities, of increasing the core size in accordance with the ratios shown in Figure 3, is as follows:

Resistance. The decrease in resistance caused by an increase in conductor size is partly nullified by an increase in the skin effect. This effect becomes increasingly important the higher the frequency and the larger the conductor.

Capacity and Inductance. An increase in conductor size is accompanied by an increase in ratio of the weight of copper to the weight of gutta-percha, and hence, by an increase in capacity and decrease in inductance. Consequently, above a certain size of core, depending on the frequency, the decrease in attenuation caused by the slight decrease in resistance is nullified by the increase in capacity and decrease in inductance. The only method, therefore, of making any reduction in the attenuation of the

cable is by decreasing the ratio of the weight of copper to the weight of gutta-percha, and hence reducing the capacity and increasing the natural inductance.

The length of the Tenerife-Gran Canaria

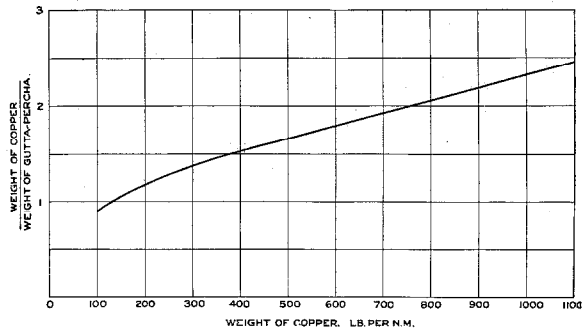

Figure 3—Ratios of Weight of Copper to Weight of Gutta-percha as Used in Present Day Telegraph Cable Practice.

Cable and the desired frequency of operation were such that in order to reduce the overall attenuation to reasonable limits, the ratio of the weight of copper to the weight of gutta-percha, as explained above, had to be considerably less than is customary in telegraph cable practice.

The following was the core size finally used:
Weight of

copper conductor = 405 lbs. per nautical mile

Weight of

gutta-percha = 450 lbs. per nautical mile.

As is usual with cores of such sizes, the conductor consisted of a central copper wire surrounded by five copper tapes. This method of construction has the advantage of taking up the least space of any type of stranded conductor, and hence for a given core size has the least capacity.

*Return Conductor.*² In order that the resistance of the sea return path should not be prohibitive at carrier frequencies, it is necessary to surround the core with a layer of some conducting material. For the Key West-Havana Cables, the core was first covered with a thin copper tape laid spirally over the dielectric with a short lay, the object being to protect the core against possible teredo damage. Over this protective tape were laid two heavy copper tapes, with a much longer lay, and applied in such a manner

² Martin, Anderegg & Kendall, *Journal A. I. E. E.*, March, 1922.

that the edges did not quite meet, in order to avoid making too stiff a core.

For the Tenerife-Gran Canaria Cable, it was decided to replace the two outer heavy tapes by a layer of round copper wires. The advantages of this method are that wires are easier to handle in manufacture and are also cheaper. A further advantage, not generally realised, is that a core with a wire return is considerably more flexible than a core with a tape return. Consequently, the thickness of the jute inner serving need not be as great, which results in some cases in a lesser number of armouring wires being necessary than with a core with a tape return.

The actual copper return consisted of a layer of thirty-four wires each of 0.035 inch diameter, not quite touching one another. The weight of the copper return, excluding the copper protective tape, was 750 lbs. per nautical mile. To make up the same weight with a layer of wires touching one another, would have necessitated a greater number of still smaller wires—which appeared undesirable. In fact, from experience gained during the manufacture and laying of this cable, the use of even fewer than thirty-four wires would have been preferable. As it is generally considered advisable to weld each wire

electrically, the time taken in making the joints is considerable, and it was found that this was the limiting factor in the speed of manufacture of the cable. It is, of course, always desirable to reduce the time taken to make joints and splices at sea.

For the short length of cable, in which the core was lead covered, at each of the shore ends, it was considered advisable to have a full layer of copper wires under the lead. The copper return for these portions therefore consisted of 45 wires each of 0.035 inch diameter. The object of lead covering the core at the shore end is to protect the core against the damaging effects of light, air, and the constant change of temperature encountered on the beach.

Armouring. The various types of armouring, cross sections of which are given in Figure 4, for both cables, were in accordance with general practice, but the following minor points are included as of possible interest. The landing places for both ends of the Tenerife-Gran Canaria Cable were rather exposed positions, particularly at Tenerife. It was, therefore, thought advisable to use a particularly heavy armouring for a short distance at each end. There are two methods at present in common use, both using a double armouring, but differing in the method of application of the outer armouring. In one method the outer layer is applied with long lays, as in the case of the inner layer. In the other method, the outer layer consists of a small number of wires applied in the form of a spiral with very short lay. The advantage of the latter method is that the finished cable is far more flexible than when using the long lays, but has the disadvantage that the galvanising tends to flake off during armouring, owing to the small diameter round which it is bent. For this cable, the former method with long lays was adopted.

In order to reduce the weight of the deep sea type of cable, each of the wires of the armouring was taped with a compounded cotton tape, thus reducing the number of wires necessary to surround the served core. This also has the advantage of making the cable more flexible and it forms a protection for the wires.

The outer serving of deep sea type cable commonly consists of two compounded Hessian tapes instead of servings of tarred jute as used

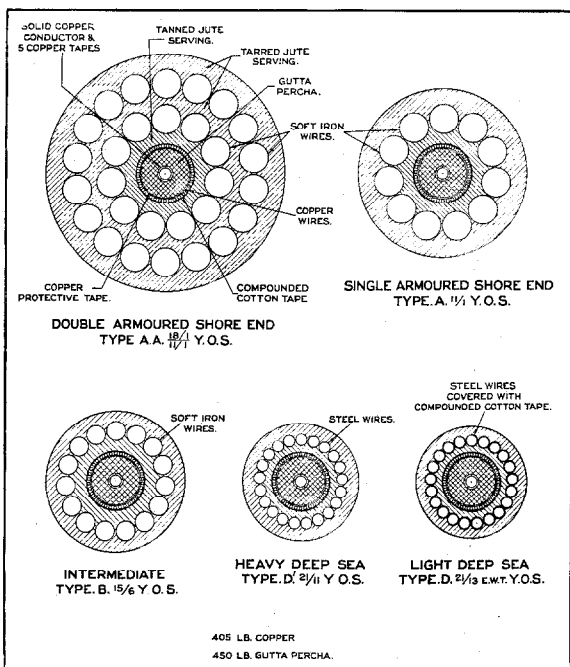

Figure 4—Cross Sections of the Different Types of Cable.

TABLE NO. I
DETAILS OF DIFFERENT TYPES OF ARMOURING

Type of Cable	Number and gauge of armouring wires	Diameter of armour wire.	Weight in air.	Weight in water.	Diameter over cable.
		Inches	Tons per naut. mile	Tons per naut. mile	Inches
Double armoured shore end, with lead covered core.	18 No. 1 over 11 No. 1	0.300	28.2	22.5	2.46
Double armoured shore end.....	18 No. 1 over 11 No. 1	0.300	25.8	20.3	2.46
Single armoured shore end with lead covered core..	11 No. 1	0.300	12.1	9.4	1.73
Single armoured shore end.....	11 No. 1	0.300	9.6	7.2	1.73
Intermediate.....	15 No. 6	0.200	6.3	4.6	1.43
Heavy deep sea.....	21 No. 11	0.120	3.8	2.6	1.20
Light deep sea.....	21 No. 13	0.095	3.0	1.9	1.14

on the heavier types. For the Tenerife-Gran Canaria Cable, owing to the bad bottom conditions at all depths, it was considered worth the extra expense of using jute servings. These form a better protection than Hessian tapes, owing to the comparative ease with which the latter strip off after the cable has been under stress.

In Table I are given details of the armouring of the various types used.

Electrical Tests During Manufacture

Direct Current Testing of Core. The normal procedure of D.C. testing at 75° F. for telegraph cables was adopted for this cable, with the exception that the tests were taken twenty-eight days after covering, instead of fourteen days. One of the reasons for this was that gutta-percha cables tend to increase slightly in capacity, and improve in insulation for some considerable time after manufacture. It was feared that if the rate and percentage change of capacity differed much for each of the coils, an allocation of the core made on tests only fourteen days after manufacture and then giving the very high singing point desired, might in time become unsatisfactory. From experience gained on this cable, this precaution seemed unnecessary. The core was manufactured in lengths of about 1.3 nautical miles and, for reasons explained later, each coil was separately covered with the copper protective tape and return wires, and finally, with a cotton tape. Before putting the core in water, the D.C. resistances of the central and return conductors were measured. Subsequently,

on taking the D.C. resistance of the central conductor at 75° F. under water, it was possible to estimate the true resistance at 75° F. of the return conductor. In Table II are given the

TABLE NO. II.

D.C. Constants of Core at 75°F. per nautical mile	
Resistance of central copper conductor	2.877 ohms
Resistance of return copper conductor	1.328 ohms.
Capacity.....	0.258 mfd.
Dielectric Resistance after one minute	3.340 megohms.

average values per nautical mile obtained at 75° F. of the D.C. constants of the core.

Impedance Tests and Allocation of Core. In order to ensure the efficient operation of carrier telephone systems on a balanced basis on a cable of the type under consideration, it is necessary that the singing point should be higher than the total attenuation of the cable itself over the entire frequency range in use. It was estimated that the attenuation loss on the Tenerife-Gran Canaria Cable at 20,000 c.p.s., would be about 40 decibels. It was also estimated that if the cable was allocated on the basis of D.C. capacity alone, only four carrier channels would be obtained with a very small margin of safety, whereas it seemed possible that six channels could be obtained by adopting special A.C. methods. This was borne out in practice, as the Algeciras-Ceuta cable, which was allocated on a D.C. basis alone, had a singing point up to 30,000 c.p.s., of merely 39 decibels. By adopting special A.C. methods for the longer cable, a

singing point of 50 decibels was obtained. Owing to the comparatively short length and overall loss of the Algeciras-Ceuta Cable, the singing point of 39 decibels is ample to allow the working of six carrier channels. It might have been possible to obtain as high a singing point as 50 decibels using the ordinary D.C. methods, by cutting the coils into shorter lengths. But this method would necessarily have increased the number of joints, and was therefore to be avoided.

The process by which the high singing point was actually obtained consisted in allocating for capacity, inductance, and non-uniformity of constants. This information was obtained by measuring the characteristic impedance of each coil from each end at carrier frequency, the particular frequency chosen being 20,000 cycles per second. It was in order to make these impedance tests possible that each coil had to be separately covered with the copper return.

The circuit of the bridge used for making these tests is shown in Figure 5. It may be seen

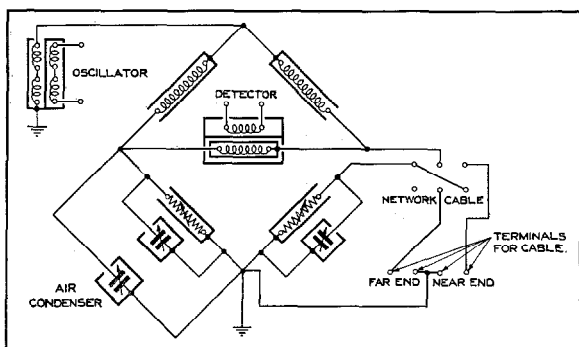

Figure 5—Circuit Diagram of Impedance Bridge.

that when the change-over switch is thrown to the position marked "cable," the coil is terminated by a network which is arranged to have the same impedance as the variable arm of the bridge. By manipulating the controls of the resistance boxes of the bridge and terminating network simultaneously and, similarly, those of the condenser boxes, a balance point is obtained giving the impedance of the coil of cable. Means were provided whereby the exact equality of bridge arm and terminating network could be obtained by adjustment of an air condenser and if necessary, by setting the resistance boxes to slightly different values.

Before commencing the regular tests, it was necessary to investigate the obvious possibilities of difficulties arising from inductance effects due to coiling the core on iron drums, or due to short circuiting the return by the bridge connections, or by the water in the tank. The effects were found to be negligible.

It was noticed that, on some of the coils, there was a marked difference between the impedances measured at opposite ends of a coil. That this difference was not due to inductive or other effects was established by rewinding a coil on an empty drum so that the inner end became the outer end, and vice versa. It was found in this way that the difference of impedance was a property of the core itself, and not of the way in which it was wound on the drum. The reason for this non-uniformity, which appeared to be generally although not invariably in one direction, is not known; but it was found that the degree and direction of the non-uniformity of capacity and inductance could be estimated from the difference of impedance observed. This was checked by cutting several experimental lengths in two, and by taking measurements on the halves.

The Tenerife Cable was first allocated on the basis of mean impedance measurements alone, and the coils were joined up in the core tanks in accordance with this allocation. An impedance run at carrier frequencies was then made from each end by the open and short circuit method. A singing point of 50 decibels was obtained for the Gran Canaria end, but somewhat less for the Tenerife end. This end was then re-allocated, making allowance for the non-uniformity of the actual coils and in one case altering the direction of a coil by turning it over. An impedance run was taken as before, and a singing point of 50 decibels was also obtained on the Tenerife end. The final allocation is shown in Figure 6, from which the actual method can clearly be seen. On joining up the coils before armouring, particular care was taken that the direction of each coil was the same as in the allocation. It was particularly gratifying that such a high singing point as 50 decibels was obtained without cutting any of the coils into shorter lengths. An impedance run was also taken from the Gran Canaria end with the expected spare length cut out, but

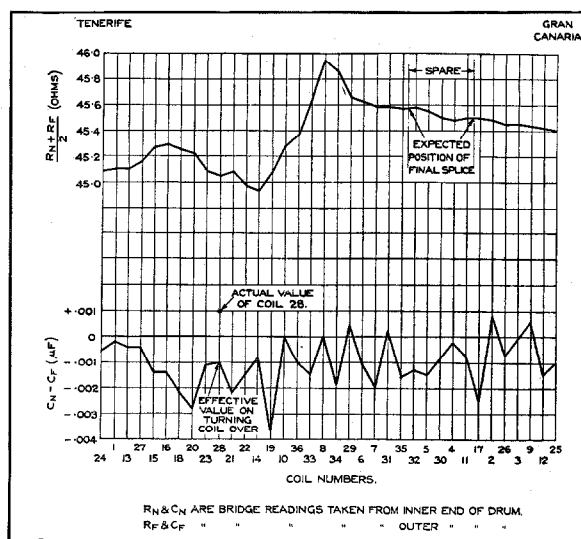

Figure 6—Final Distribution of Core-lengths, with Corresponding Impedance Measurements of Individual Lengths.

owing to the distance from the end, about eight nautical miles, where it had been decided to make the final splice, no appreciable difference was noticed from the previous impedance run.

Manufacture of Cable

As the manufacturing methods were slightly different for the two cables, the Algeciras Cable will be described first. In this case, in order to save time in manufacture, no impedance measurements were made on the individual core lengths, and the allocation was made on the basis of D.C. capacity alone. All the core was then joined up, and the copper wire return and jute inner serving were put on in one operation. This method avoids making splices in the copper return between each coil length. As the whole of the core had been joined up, splices between the different types of armoring were made in the machine. Impedance runs on the whole cable were taken from both ends after core serving, and again after armoring. Very little change was noticed, due to the application of armoring.

For the Tenerife-Gran Canaria Cable, in order to make impedance measurements on each core length, each length had to be separately sheathed with the copper return, the serving of the core being subsequently done as a separate operation. The lengths of served core were then joined up as required, and the armoring was done in four

machines. After completion of the manufacture of the cable, the four sections were temporarily joined up in the order of laying, and an impedance run was taken from each end. No great change was observed from the tests taken at the core stage.

Laying of the Algeciras-Ceuta Cable

As it was important to complete the Algeciras-Ceuta cable by the end of July, 1929, the laying of the cables was done in two separate expeditions by C. S. "Dominia." The ship first proceeded to Algeciras, arriving there on July 13, 1929, but owing to the size of the "Dominia" it was impossible to anchor off the cable house at Saladillo Bay, closer than 0.85 nautical miles. A certain amount of difficulty was experienced in getting the shore end ashore, owing to the heaving rope and cable fouling rocks with which the bay is strewn. This caused so much delay that paying out towards Ceuta, if started at once, would have taken place in the dark, which was considered inadvisable. Early next morning, paying out was commenced and proceeded without incident, and the cable was eventually buoyed about three nautical miles off Ceuta. The shore end at Ceuta was landed very easily the following morning, and paying out towards the buoyed end commenced immediately. The buoyed end was picked up, the Ceuta end cut, and the final joint and splice made.

Laying of the Tenerife-Gran Canaria Cable

The route over which the Tenerife-Gran Canaria Cable is laid is particularly bad for submarine cables—a condition to be expected owing to the very rugged outline of the islands. The descent from Tenerife is very steep, a depth of 600 fathoms being reached in less than two nautical miles, and at the opposite end of the route about seven nautical miles from Sardina Bay, the ground suddenly falls from 300 to 1,000 fathoms in less than three nautical miles. The maximum depth of the route is a little over 1,500 fathoms. From experience of other cable ships in the vicinity it is known that the whole of the district is extremely irregular, thus making successful repair work very difficult.

The shore end at Santa Cruz, Tenerife, was laid first, the cable being paid out and buoyed

some eight nautical miles from Sardina Bay on September 21, 1929, without incident. Next morning the shore end was successfully landed at Sardina Bay. The cable was then paid out towards the buoyed end, which was picked up. The final joint and splice was then commenced, but before the welding of the copper return wires was completed, the stress on the Tenerife end suddenly rose from the normal of about one ton to over ten tons. The depth was between 600 and 700 fathoms. After a time, the stress fell to its normal value, but it was feared that the cable had broken, which was confirmed by a wireless message received from the electrician at the cable hut at Santa Cruz. The splice was then cut, the Sardina Bay end re-buoyed, and the loose end picked up. For the last 100 fathoms of this piece, the serving had been stripped off, and the armouring was bright in places, indicating considerable chafing on rocks. A mark buoy was

put down, and a drag was made for the Tenerife end, which was picked up the first time. The spare cable in the ship was spliced on, and paying out was started towards the buoyed Sardina Bay end. On attempting to pick up this end, it was also found to be foul of rocks, and some time elapsed before it was possible to bring it on board. When the end was finally on board, it was found to be faulty. After picking up a length of cable, about equal to the depth, the fault came inboard, again evidently due to chafing on rocks. Both ends then tested satisfactorily, the final splice was made, and was slipped without further mishap. The lengths of the different types of cable actually expended on each cable are given in Table III.

Tests After Laying

On completion of the laying of each of the cables, the customary D.C. tests were immedi-

TABLE NO. III
LENGTHS OF VARIOUS TYPES IN EACH CABLE

Armouring	Length—Nautical Miles	
	Algeciras-Ceuta	Tenerife-Gran Canaria
	Algeciras end	Tenerife end
18 No. 1 over 11 No. 1.....	0.20*
11 No. 1.....	2.20*	0.20
15 No. 6.....	15.18	1.41
21 No. 11.....	5.00
21 No. 13.....	24.92
21 No. 11.....	2.00
15 No. 6.....	2.07
11 No. 1.....	2.30*	2.94
18 No. 1 over 11 No. 1.....	1.00*
Totals.....	19.68 Ceuta end	39.74 Gran Canaria end

*The shoreward end of each of these lengths of core was lead covered for 0.1 nautical miles.

TABLE NO. IV
D.C. TESTS ON CABLE AFTER LAYING PER NAUTICAL MILE

	Algeciras-Ceuta Cable	Tenerife-Gran Canaria Cable
Resistance of central conductor, ohms.....	2,784	2,693
Capacity, microfarads.....	0.263	0.263
Mean dielectric resistance in megohms, from readings taken at the end of each minute during the first five minutes' electrification—for both currents.....	16,300	35,000
Mean temperature of laid cable, calculated from the conductor resistance. Degrees Fahrenheit.....	59	45½

ately made, with satisfactory results; these, reduced to values per nautical mile, are given in Table IV.

Owing to the high overall loss of the cable, and the high frequencies involved, the measure-

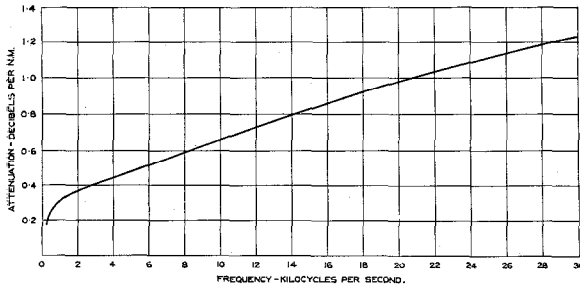

Figure 7—Attenuation-frequency Curve.

ment of the attenuation presented some difficulty. For short cables, the attenuation can be estimated from the open and short circuit impedances, but on the Tenerife-Gran Canaria cable, the difference between the two impedances only amounted to about 0.04 ohm at 20,000 c.p.s., and 0.005 ohm at 30,000 c.p.s. The bridge rheostat was adjustable only to the nearest hundredth of an ohm, and might give errors of a similar order, due to variation in the dial contact resistances, and in residual reactance of different resistance spools. It was therefore necessary to devise a means of reading accurately small differences of impedance. This was done by a vernier method. The bridge rheostat and condenser were left at the same value for both open and short circuit impedance readings, and the bridge was balanced by adjusting a high resistance (about 4,000 ohms) and a small precision condenser, both in parallel with the bridge arm. From the observed change in reading of the vernier resistance and condenser, the difference between open and short circuit impedance was calculated, and hence the overall loss. In this way, it was found possible to measure accurately losses up to 50 decibels, while the previous limit was commonly estimated at 15–20 decibels. Agreement between attenuation tests taken by the above method from both ends of the cable was within 0.2 decibels. Check tests for the attenuation were also made by measuring the sent and received currents by thermocouple methods. The attenuation frequency curve is shown in Figure 7.

As previously mentioned, a singing point of 50 decibels had been obtained in the factory on the completed cable. It had been considered possible, however, that the constants of the cable might be so affected by the different pressures due to increasing depths on the various types of cable, that the uniformity of the impedance frequency curve might be upset, and the singing point consequently reduced. This was not found to be the case, a singing point of 50 decibels up to 30,000 c.p.s. being obtained after laying from each end of the cable. In Figure 8 is shown the high frequency impedance curve taken from the Gran Canaria end, together with the network curve and the 50 decibel singing point limits. The singing points for the Gran Canaria end calculated from the line and network impedance curves are shown in Figure 9. The overall attenuation loss is plotted on the same graph. It should be noted that as long as the singing point is not less than the overall loss, there is a good margin of stability in the operation of the carrier repeaters, and hence, when the growth of traffic justifies the installation of the equipment, it will be possible to work six carrier telephone channels over the Tenerife-Gran Canaria cable as well as on the Algeciras-Ceuta cable.

Analysis of Constants

Making certain assumptions based on tests on the core, an analysis was made of the various

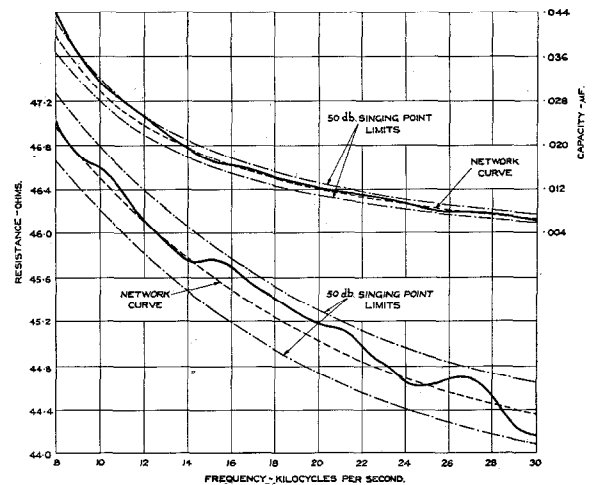

Figure 8—Impedance Curve of Cable and Network at the Gran Canaria End, Together with 50 Decibel Singing Point Limits.

TABLE NO. V
ELECTRICAL CONSTANTS OF CABLE PER NAUTICAL MILE DEDUCED FROM
ATTENUATION TESTS AFTER LAYING

Frequency, kilocycles per second.....	1	2	5	10	15	20	25	30
Resistance, ohms.....	3.8	4.2	5.0	6.3	7.5	8.5	9.2	9.8
Capacity, microfarads.....	0.252	0.251	0.251	0.250	0.250	0.250	0.250	0.250
Inductance, millihenries.....	0.56	0.55	0.54	0.53	0.52	0.51	0.50	0.50
Leakance, micromhos.....	—	—	150	350	575	850	1125	1400

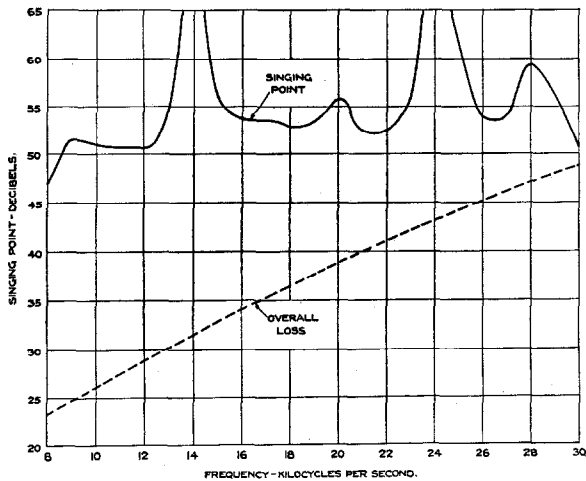

Figure 9—Calculated Singing Point at the Gran Canaria End and Overall Loss Curve.

constants contributing to the attenuation results actually obtained on the cable after laying. The results of this analysis are given in Table V.

A further analysis was then made from the values given in Table V of the various components making up the resistance at different frequencies. The total resistance is divided up into the three main components as follows: D.C. resistance of the central conductor, skin effect of the central conductor, and resistance of the sea return. Theoretically, a further division should be made for the skin effect of the sea return, but even at 30,000 c.p.s., this is practically negligible and has not been considered. Figure 10 shows the results of the analysis.

Conclusion

It is probable that the type of cable discussed in this paper, i.e., a single-core non-loaded, concentric-return type, with gutta-percha as the dielectric, will have a considerable field of appli-

cation in the future, especially where many circuits are needed and where a paper insulated cable is inappropriate. The number of circuits provided by this type will usually be in excess of that provided by any other type of gutta-percha cable. Moreover, for mechanical reasons, this single core type has marked advantages and may be adopted for all depths. In shallow water where, for mechanical reasons, lead-covered cable is unsatisfactory, such as in the case of rocky bottoms, or strong currents, this single-core type is also eminently suitable. In addition, the special methods of allocation introduced have increased the distance over which a given number of channels can be operated, and—for

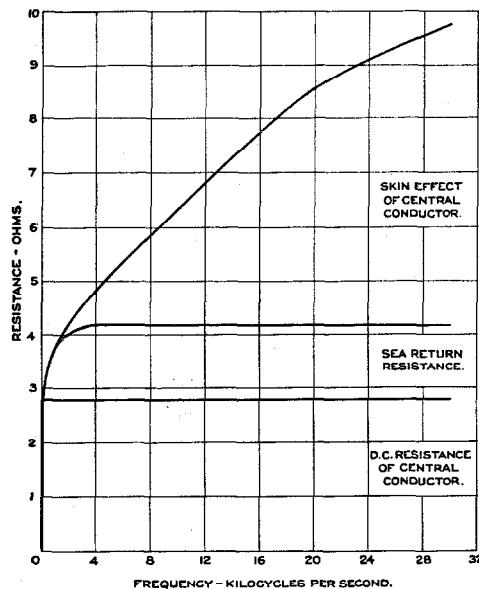

Figure 10—Analysis of Resistance Components.

a given length—have increased the number of channels.

The cables were manufactured and laid by the Telegraph Construction and Maintenance Company, Limited, London.

The New Madrid Toll Board

By W. H. WARREN, Acting Chief Engineer and J. J. PARSONS, Engineer

Compañía Telefónica Nacional de España

THE new Madrid toll exchange was cut-over in July, 1929, a date which should be considered as a milestone in the development of Continental toll switching methods, inasmuch as this exchange is the first in Europe to operate on the so-called "combined line and recording (C. L. R.) method." In other words, it is the first large toll exchange in Europe without any recording boards and without pneumatic ticket distribution, where every toll operator has access to all toll lines connected to the exchange, and where the calling subscriber may get any toll connection without hanging up his receiver first (non-hang-up type of C. L. R. operating method). Also, through the reduction of all terminating long distance circuits to an equivalent of 6 db., the use of cord repeaters on switched connections is eliminated.

The board is of the No. 2003 type and was manufactured by the Bell Telephone Manufacturing Company, Antwerp.

Equipment

The switchboard equipment in the toll operating room on the fifth floor is made up of the following:

43 two-position sections of No. 3 type switchboard for toll, pay station, and official P. B. X. service.

1 two-position section of No. 3 type switchboard for service observing.

12 Sections double sided two-position desk type switchboard for information service.

1 Double sided two-position chief operator's desk.

1 Single sided information supervisor's desk.

The Telefonema Operating Room contains 20 two-position sections of Telefonema switchboard, a single sided chief operator's desk, and 6 positions of flat topped desks for despatching, checking, filing, etc.

In anticipation of a very large increase of toll traffic the toll switchboard was laid out in five lines. This increase is now being realized. The 100 line is composed of 11 sections, the positions being numbered from right to left from 101 to 122. Positions 101 to 110 inclusive are arranged

for inward service, the toll line multiple being equipped with lamps in these positions. The first two sections of this board are arranged for night concentration, and contain a complete appearance of all multiple including the recording trunk multiples. The lamps on the latter are controlled by a master transfer key which is arranged so that the signal does not appear at the night positions except when required for full night concentration.

Positions 111 to 114 inclusive are equipped for out-going suburban service to certain small offices in the immediate vicinity of Madrid. These positions are provided with a two-number recording trunk multiple, as well as a complete appearance of toll line multiple. The key shelves are equipped with 10 pairs of toll cords per position.

Positions 115 and 116 are unequipped for the time being.

Positions 117 to 120 inclusive are equipped with answering jacks for prepayment pay station lines. Positions 121 and 122 are equipped with incoming trunks to the Telephone Company's official P. B. X. and a multiple of the final terminals of the automatic P. B. X. is provided so that incoming calls to the Telephone Company may be completed to the proper station.

Positions 117 to 122 inclusive are equipped with 16 pairs of local cords per position, and the cord circuits of positions 117 to 121 are equipped with coin control to operate in connection with the pay station lines.

The 200 line board grows from left to right, and is at present composed of 12 sections, the positions being numbered from 201 to 224. This line of board is equipped for outward C. L. R. operation, with the recording trunks multiplied throughout on a 10 panel basis. Twenty answering jacks per position are provided for inter-position trunks and toll circuits. The toll circuits are cross connected in such a way that on an inward call the signal appears on the multiple at the inward positions on the 100 line. In case of



Gran Via Building in Which the New Madrid Toll Board is Housed.

a delayed call, the inward operator may cause the signal to be transferred to the answering jack by operating the master transfer-key referred to above. Each of positions 201 to 224 are equipped with 6 pairs of toll cords.

The 500 line faces and is symmetrical with the 200 line on the opposite side of the room. The growth is right to left; the present equipment consists of 12 sections, positions numbered 501 to 524. This line of board is also arranged for outward C. L. R. service with the same general equipment arrangement as the 200 line, except that answering jacks are provided on the basis of 10 per position instead of 20. Toll circuits assigned to answering jacks on the 500 line are also assigned to secondary answering jacks on the 200 line. During busy hours when both lines are covered, a transfer from the inward board for one of these toll circuits brings in the signal at the 500 line, but during hours of light load, the 500 line board is not covered, and the locking transfer keys associated with the answering jacks

are operated, so that a call transferred from the inward board will come in at the secondary answering jack on the 200 line. It is this arrangement which makes it necessary to provide twice as many answering jacks on the 200 line as on the 500.

The 300 line grows from right to left down the centre of the room; present equipment consists of 4 sections, positions numbered 301 to 308. This board is equipped in general in the same way as the 200 and 500 lines, with the exception that no recording trunk multiple is provided. Answering jacks are 10 per position, and key-shelf equipment consists of 6 pairs of toll cords per position. This line of board is used for international service to points outside of Spain, both in Europe and in America. Subscribers desiring calls outside of Spain dial "09," the same as for ordinary toll service, and the C. L. R. operator answering the call at the 200 or 500 line, transfers it to the 300 line over one of a group of interposition trunks which are connected to the miscellaneous outgoing trunk multiple and multiplied on answering jacks in the 300 line board.

The 400 line is back to back and parallel to the 300 line. The growth is from left to right, present equipment consisting of 4 sections, the positions being numbered 401 to 408. This line of board is intended for future two-number service. It is equipped with a special recording trunk multiple, and the key-shelf equipment consists of 10 pairs of toll cords per position. At present this line of board is being used for such special services as the Stock Exchange, and the more important attended pay stations. Lines from the Stock Exchange and from the attended pay stations are cross connected to this special recording trunk multiple which is entirely independent of the toll and two-number recording trunk multiples mentioned above.

This toll office works in conjunction with a multi-office 7-A rotary automatic local plant. Individual toll switching trunks are provided from each position of the toll switchboard, and connections to local subscribers are set up over these trunks by means of a number key-set. The individual toll switching trunks from the toll positions terminate on the arcs of trunk finders. A trunk finder together with its associated first group selector and register chooser forms a con-

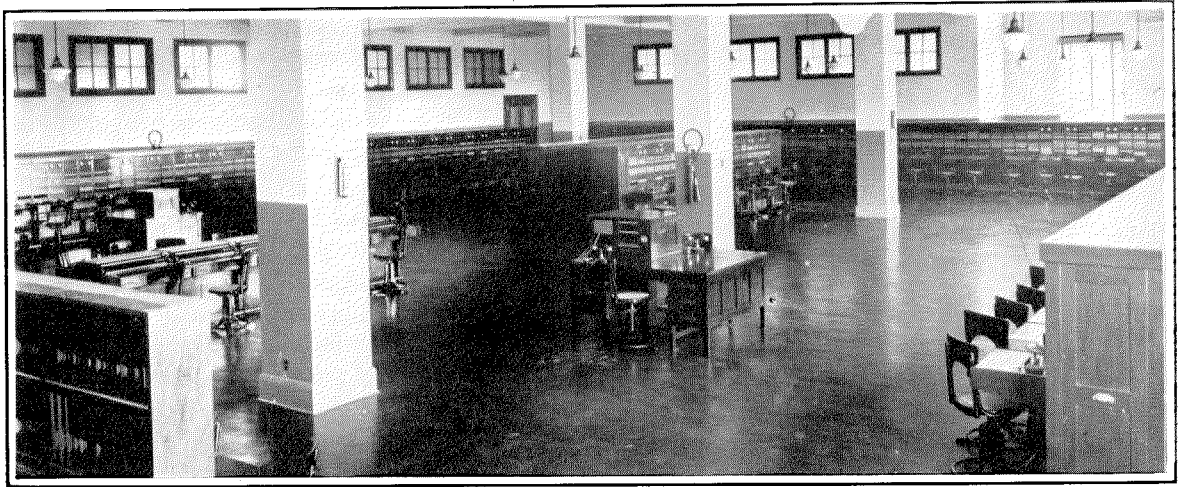

General View of Toll Operating Room.

nection circuit which is exactly similar in function to the connection circuits for local automatic service. The trunks outgoing from the arcs of the toll first group selectors lead to second group selectors in the respective local exchanges, the arcs of these toll second group selectors being multiplied with the arcs of the other second group selectors in the office. The toll operator sets up all digits of the wanted number, and selection is fully automatic. This arrangement has the advantage of economy and flexibility, since the number of trunks required in each position is determined merely by the average number of simultaneous calls which an operator can handle, and is independent of the number of offices in the local area. Similarly, the equipment in the automatic offices is kept at a minimum, since the third group selectors and finals handle the combined local and toll traffic instead of being calculated as two separate groups. If in an exceptional case, a toll operator has all of the toll switching trunks from her position in use, and has occasion to set up another connection, she can use a trunk on an adjacent position, while the probability of three contiguous positions having all trunks in use simultaneously is practically nil.

All multiples are arranged on a 5-panel basis, with the exception of the recording trunk multiple, which is arranged on a 10-panel basis.

The regular toll line multiple consists of 300 jacks and appears in full in all five lines of the switchboard. Forty additional toll line multiple

are provided in sections 1 to 7 of the 100 line, and throughout the 400 line. The circuit groups to the two-number points are split, most of these circuits being reserved for terminal traffic, and connected to the 40 jacks referred to, the remainder being connected to jacks in the regular toll line multiple, so as to be available to all positions for through connections. The toll line multiple is equipped with visual busy signals throughout, and is also equipped with lamps in the inward positions, sections 1 to 5 inclusive of the 100 line.

One hundred and forty miscellaneous outgoing trunk multiple are provided throughout all the lines of board. This multiple is used for trunks to the telefonema section, trunks to chief operator, toll information, international recording, etc. Cord test, supervisor, and other miscellaneous circuits are also connected to this multiple.

One hundred and twenty toll subscribers' multiple are provided in sections 1 to 5 of the 100 line, and throughout the 200 and 300 lines. Lamps are provided in connection with this multiple in the first five sections of the 200 line with transfer for night concentration to section 1 of the 100 line. It was not considered necessary to extend this multiple to the other lines of board, since the service for toll subscribers is effectively handled in the following manner: Calls originated by toll subscribers are answered, recorded, and completed at the 200 line. Incoming calls for toll subscribers are normally completed at the inward positions on the 100 line. In case of a delayed

call involving a toll circuit group assigned to answering jacks in the 500 line, the inward operator effects the transfer over an interposition trunk to the 200 line where the toll subscribers' multiple is available, instead of using the master transfer which would bring in the signal at the 500 line, where the toll subscribers' multiple is omitted. It was necessary to extend the toll subscribers' multiple through the 300 board in order to take care of inward and outward international calls for subscribers.

The toll recording trunk multiple referred to in connection with the foregoing description of the different lines of board, consists of 100 jacks, and appears on a 10-panel basis throughout the 200 and 500 lines, and for night concentration in the first two sections of the 100 line.

A two-number recording trunk multiple of 40 jacks is provided on a 5-panel basis in sections 6 and 7 of the 100 line, and also for night concentration in sections 1 and 2 of the same line. The 400 line is equipped with a special recording trunk multiple of 100 jacks appearing in full in the first section, and on a 10-panel basis in sections 2 to 4. As explained above, this multiple is at present being used for lines to the Stock Exchange and other attended pay stations, but ultimately it will probably be used as a two-number recording trunk multiple when growth on the inward positions, and in the two-number service makes it necessary to remove the latter from the 100 line.

One hundred interposition trunk multiple is

provided at the inward positions, sections 1 to 5 of the 100 line. In this multiple are connected trunks to each of the outward C. L. R. positions for use in effecting transfers on inward calls which are to be handled at a position other than that to which the toll circuit is normally assigned for delayed service.

The toll and international information board consists of three sections of double sided information type switchboard. Book racks and a ticket filing cabinet are provided along the centre of this board. Key ended trunks provide for incoming and outgoing communication with the toll switchboard. Rate quoting, routing, and directory work in connection with ordinary toll calls and international service is handled at this board, which is also used during light hours for ticket filing.

A double sided chief operator's desk of the 5360 type with a 15-T turret is provided for the toll chief operator, and the assistant chief operator. This desk calls for no special comment; it is equipped with incoming and outgoing trunks to the toll switchboard, toll test board, etc., and with monitoring taps to all toll positions.

The centralised local information switchboard is also located in the same room. It consists of 9 sections of double sided type, and a single sided desk, 5260 type, with 14-T turret provided for the information supervisor. This equipment is similar to that installed in Barcelona.¹

¹F. T. Caldwell, B. A. Turkhud, and J. J. Parsons, "The New Telephone Plant in Barcelona, Spain," *Electrical Communication*, October, 1930.

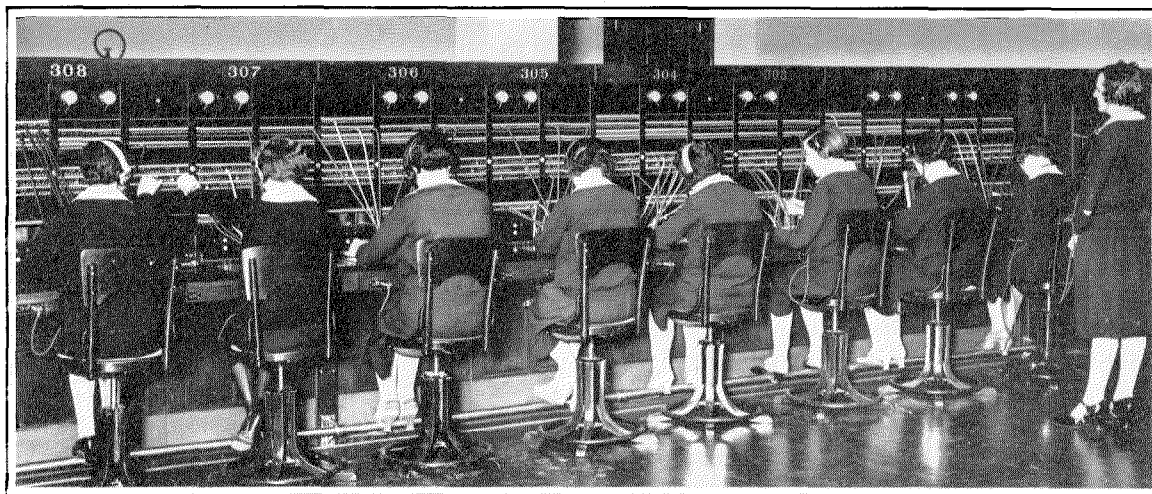

8-Position Switchboard for International Service.



General View of Telefonema Room.

Circuits

Toll circuits terminating in Madrid total 257. They may be classified as follows:

- 1 Transatlantic radio circuit to Buenos Aires.
- 7 International circuits to Lisbon, London, and Paris.
- 205 Circuits to toll exchanges in all parts of Spain.
- 44 Two-number toll circuits to points in the immediate vicinity of Madrid.

Of the 44 two-number toll circuits 25 are to Carabanchel, a suburb only about 8 kilometres from Madrid, and are carried entirely in local trunk cable. The other two-number circuits are open wire physical circuits, some being brought in on local trunk cable pairs, and others in the toll entrance cable.

The 213 toll circuits (including international) may be classified as follows:

- 1 Radio circuit.
- 109 Physical circuits on open wire leads.
- 49 Phantom circuits formed by the above physicals.
- 54 Carrier channels.

All these circuits are brought in to the central office in three cables, namely, the North and South entrance cables each of 50 quads, and the East cable which is made up of 58 quads of 16 gauge, 40 quads of 19 gauge, and 3 special pairs. This cable at present extends out of Madrid a distance of 11 kms. on the Zaragoza main toll route, and will ultimately form a part of the projected toll cable network extending from Madrid to Zaragoza, and from Zaragoza to Barcelona, and Zaragoza to Irun.

All circuits entering Madrid which have a

natural transmission equivalent in excess of 6 decibels are equipped with terminal repeaters in Madrid, adjusted so that the overall equivalent of the circuit will not exceed this limit. There are 35 circuits equipped in this manner.

The proportion of long haul circuits to the total is apparent when one considers that 126 out of the 213 toll circuits have a length in excess of 300 kms. Many of the circuits have a considerably greater length, for instance, 21 circuits to Barcelona, a distance of 639 kms., 4 circuits to Vigo, 744 kms., etc., not to mention the international circuits.

Madrid has direct toll circuits to 4 foreign capitals, 66 toll points in Spain, and 7 two-number points, making a total of 77 different circuit groups.

The largest single group is the group of two-number toll circuits to Carabanchel, which has 25 circuits.

The largest long haul toll circuit group is to Barcelona. This group consists of 10 physical circuits, 5 phantoms, and 6 carrier channels, or a total of 21 circuits. There are 13 toll points within 100 kms. or less of Madrid, which are each served by a single circuit. There are also 8 more distant exchanges which have a single toll circuit to Madrid. The remaining 45 toll exchanges in Spain to which Madrid has direct circuits are served by groups of 2 or more circuits, the average size of the groups being about 4 circuits.

Alternate routes are available to practically every point to which Madrid has direct circuits. The toll network of Spain has the general shape

of a wheel with Madrid as the hub. The most important toll offices outside Madrid are located around the periphery of this wheel and connected by direct circuit groups to Madrid. They are also linked to each other by a main toll lead following the Atlantic and Mediterranean coasts. It is therefore apparent that in case of an interruption to service on one of the radial leads, communication can always be maintained by switching along the coastal lead to one of the other radials.

None of the toll circuit groups are split, that is, all circuits are operated both ways. No time is lost in testing for a free circuit, since the toll line multiple is equipped with visual busy signals, and the operation, as a single group, is more flexible and efficient than where an attempt is made to segregate traffic in the two directions.

Handling of Traffic

All toll lines are accessible to all toll operators, the only restriction being in connection with international service which it is necessary to handle exclusively at the 300 line board owing to language difficulties and special methods of operation required by existing agreements with foreign administrations. International service is

handled on the old-fashioned point-to-point basis by the two-ticket method, each operator at the 300 line board being responsible exclusively for one or more specified circuits.

The international circuits are connected to jacks in the toll line multiple, and to answering jacks on the 300 line switchboard, but they are cross connected in such a way that on an incoming call, the signal appears at the answering jack instead of appearing on the toll line multiple at the inward positions, as in the case of ordinary toll circuits.

The Buenos Aires service is also handled at this line of board by a system similar to the despatch method.

The method of handling two-number traffic is described in full below.

The following statements refer to the handling of ordinary service, which makes up the bulk of the business handled in the Madrid office.

Through connections are in general completed by the inward operator directly in the toll line multiple, as explained hereinafter. International through connections are, of course, completed by the point-to-point international operator at the 300 line board.

While the international traffic is handled separately, the Madrid subscriber dials the same

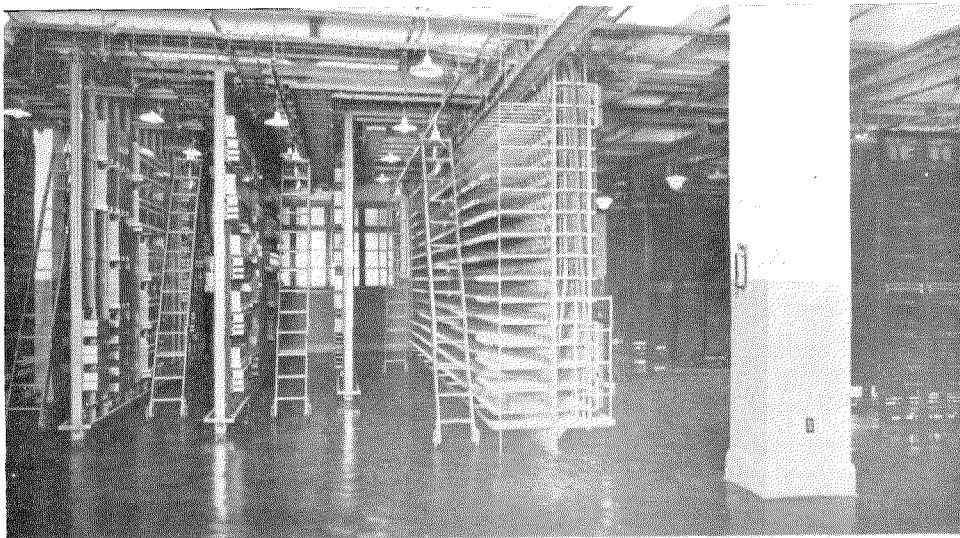

Partial View of Toll Terminal Room.

code (09) as for ordinary toll service. The C. L. R. operator answering such a call transfers it to the 300 line. This is done in order that international calls may be recorded by operators who are specially trained in this work, who are familiar with the names of foreign cities, etc., and who speak French.

No "urgent call" service is provided, and no "toll offering," or "breakdown" is provided, since these features become unnecessary when sufficient toll facilities are provided to assure a good grade of service throughout the system.

According to the policy of the C. T. N. E. every toll call is "urgent" and the average delay in completing toll connections is already less than 5 minutes, and is rapidly being reduced.

In systems having inadequate toll circuit and switchboard facilities, making it necessary for a toll call to wait anywhere from half an hour to several hours before reaching its turn on a circuit group, it is obviously desirable to provide some form of toll breakdown so that the toll call may not be further delayed by meeting a busy condition at the subscriber's telephone. This condition, however, does not exist in Spain. If an operator attempts to complete a call and finds the subscriber's line busy, she merely gives the corresponding report to the calling subscriber, and the call is attempted again within a few minutes. It is felt that the expense of the toll offering and breakdown equipment, and the annoyance caused to subscribers by having their local conversations broken into, far outweigh the additional delay involved in completing the comparatively few toll calls which are delayed on the first attempt through encountering a subscriber's line busy.

Elimination of Cord Repeaters at Madrid

Experience with cord repeaters in Spain had borne out the general experience of other countries that such a method of operation was open to two major objections:

(a) Loss of circuit and operating time even when a large number of cord repeaters are available at each switching point.

(b) In spite of the strictest supervision, a large number of calls will be put up without the repeater, resulting in connections with an excessive overall transmission loss.

When, therefore, plans were being prepared

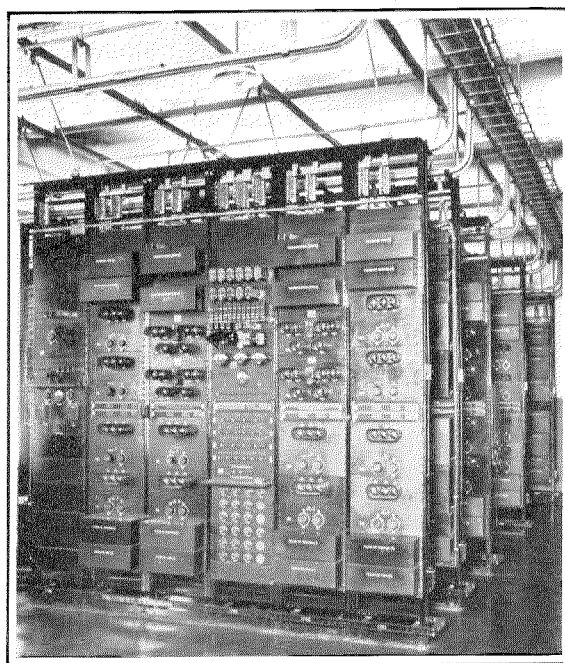

Carrier Terminal Equipment.

for the Madrid toll office, various possible ways of overcoming the above difficulties were studied. The most promising method seemed to be the total elimination of cord repeaters at Madrid.

The Engineering Department, in preparing a general Toll Fundamental Plan for Spain, demonstrated the desirability of reducing all major toll circuits to 6 db. Under such a scheme, cord repeaters would be required only when more than two such circuits were switched together. As an additional requirement to be met if possible, viz., the elimination of cord repeaters at Madrid, the following general conditions were found to be true:

(a) The reduction of all major toll circuits to 6 db. permitted the elimination of cord repeaters at all but seven toll centres in the country.

(b) Once having accepted the 6 db. plan of distribution, the most feasible and economical distribution of cord repeater points is one in which, by placing cord repeaters only at certain secondary switching centres (the seven mentioned in "a" above), every major toll centre is available from Madrid at 6 db. This results automatically in the elimination of cord repeaters in Madrid.

(c) The saving in circuit time at Madrid alone is sufficient to cover the costs of reducing to 6 db. all major toll lines in Spain.

The only disadvantage, and this is more

theoretical than real, in this method of procedure, is that a large portion of the calls terminating in Madrid will receive better transmission than the standard for the country. With toll switching and subscriber's loop plant designed in accordance with standard transmission limits, this means a connection of 20 db. rather than 26. The difference in intelligibility over this range, and the effect on the subscriber of the difference in level, does not, we feel, warrant the expense necessary in padding out circuits on terminal connections.

Service Features

At present the toll service in Spain is limited to station-to-station and appointment calls. Rates are based on air line distance with a three minute initial period, and three minute overtime periods. The calling subscriber is notified on the expiration of the initial period if he so requests, and as a matter of fact, most calls are handled in this manner.

It is planned to introduce shortly a complete

classified service, including person-to-person calls, and to charge for time in excess of the three minute initial period on the basis of one minute overtime periods instead of by three minute periods. It is felt that these changes will make the service more attractive from the subscriber's standpoint, and it will also represent a saving in operation by eliminating the necessity of "calling time" at the end of the initial three minutes.

Outward Service C.L.R. (Non-delayed)

A subscriber desiring a toll call dials "09," thereby causing a lamp to light at each appearance of the recording trunk multiple. The call is answered by the first idle operator at either the 200 or 500 line board, who challenges and records the call in the usual way. As soon as she has ascertained the exchange wanted, she takes up a toll circuit and rings, at the same time advising the calling subscriber to "Hold the line." When the distant operator answers, the outward operator merely asks for the desired num-

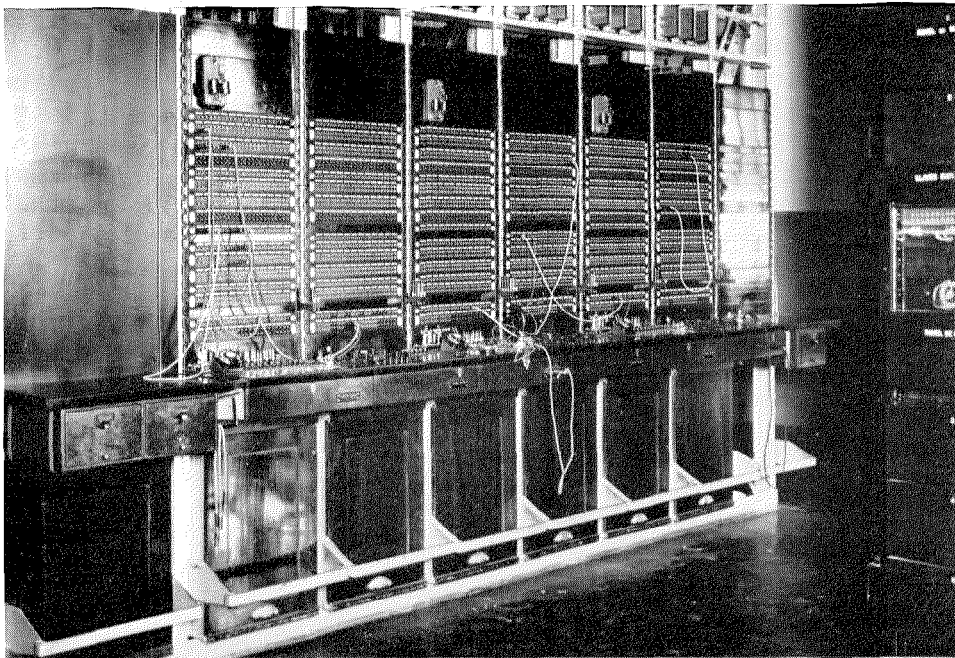

Toll Test Board.

ber and waits while the distant operator establishes the connection and rings the called station.

Called Station answers. Outward operator gives the announcement to the called subscriber and stamps the ticket in the calculagraph.

Called Station does not answer. If necessary, the distant operator rings the called station repeatedly for one minute and then reports to the calling operator that the telephone has not yet answered. The outward operator passes the preliminary report to the calling subscriber, but she continues to hold the toll line. At the end of another minute, if called station still does not answer, the distant operator passes a second report. The outward operator says "Right," releases the toll circuit, gives the report to the calling station, and releases the calling subscriber. The ticket is sent to the "delay position," after noting on it the time at which a second attempt should be made, twenty minutes later, by the "delay" operator. If this second attempt is not successful, the delay operator passes a "call order" to the distant exchange.

All reports received in attempting to complete a call are entered, in code, on the back of the ticket.

Called station busy. The distant operator, as soon as she knows that the called station is busy, passes this report to the outward operator, who gives it to the calling subscriber. The toll line and the calling subscriber are released. The operator tries again to complete the call six minutes later. If in this second attempt the called station is still busy, the operator writes on the back of the ticket the time at which a third attempt is to be made and sends the ticket to the outward delay position.

If the third attempt is not successful, the outward delay operator passes a "call order" to the distant exchange.

Inward Service

All station-to-station calls are handled by the single ticket method, that is, no ticket is made by the inward operator, except in some cases of "don't answer" or "busy," as previously explained under outward delay service when a "call order" is left.

An inward call is answered in the toll line multiple at the inward positions (101 to 110) by any one of the operators at these positions. The

distant operator passes the number wanted, the inward operator gives acknowledgment, takes up a toll switching trunk with the mate of the cord on which the toll circuit is held, operates the dial key, and sets up the wanted number on the number key set. This operation, including the setting up of a five-digit number, takes not more than eight seconds.

The trunk cord supervisory lamp flashes rapidly while the call is going through the automatic plant, and burns steadily when selection is completed, unless the called line is busy. On observing the steady glow, the inward operator rings the called station until the supervisory lamp goes out, indicating that the station has answered.

Called line busy. The trunk cord supervisory lamp flashes slowly; the inward operator gives the "busy" report to the distant exchange and releases the toll circuit and the toll switching trunk.

Transfer calls. Transfer from the inward position to a delay position is made when requested by the distant operator by merely operating the transfer key. As soon as this is done, the inward operator releases the toll line.

In some cases when a "call order" has previously been left, and the distant operator asks for a certain position by number, the transfer is made over the corresponding trunk in the interposition trunk multiple, the inward operator announcing to the delay operator the number of the toll circuit on which she is being called.

Through Calls

A through call is in general completed directly by the same inward operator who answers the line signal of the calling exchange. No relay ticket is made except in the case of a "no circuit" condition on the group to the called exchange. If the calling operator, on receiving a "no circuit" reply, passes a "call order," it is recorded by the inward operator and sent to the delay position.

Two-Number Service, Outgoing from Madrid

Under this method of operation are grouped certain small magneto offices located in the immediate vicinity of Madrid.

A subscriber desiring a call to any of the towns listed in the Directory under this heading, dials

"08," bringing in a signal on the two-number recording trunk multiple at positions 111 to 114.

Any one of the operators at these positions answers the call, records the calling and called numbers on a small ticket, takes up a circuit to the called exchange, rings and passes the called number to the distant operator.

The outward two-number service operation in Madrid is similar in part to the toll operation by the C. L. R. method, but it differs principally from that service in that only station-to-station calls are accepted, that the timing of conversation is simpler, and that only terminal service, not built-up circuit operation, is completed by this method.

Outgoing from Suburban Magneto Local Service Offices

Subscribers' calls are answered by the operators at these boards in the regular way. When the calling subscriber calls for a Madrid number, the operator makes out a two-number ticket, takes up a circuit to Madrid with the mate of the cord on which the subscriber's line is held, plugs the dial cord into the associated jack, and dials the Madrid number directly. After dialling, the dial cord is removed.

International

Subscribers desiring an international call, dial the same code (09) as for ordinary toll calls.

Any outward operator at the 200 or 500 line of board who answers the trunk signal, upon ascertaining that an international call is wanted, notifies the calling subscriber that his call will be recorded by an international operator, and by plugging the mate of the cord in one of the miscellaneous multiple trunk jacks marked "International Recording," she makes the transfer to the 300 line board.

Recording trunk lamps at the international service positions (300 line board) appear in multiple through the board. As no C. L. R. service is given on international calls, the subscriber is notified to hang up as soon as the details of the call have been recorded.

Point to Point Operation

The method of operating "point to point" and

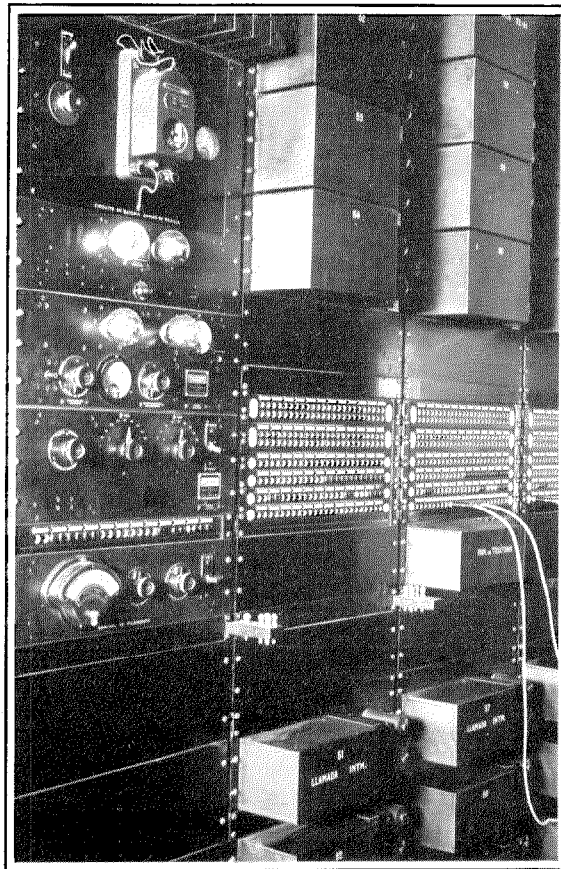

Voice Frequency Terminal Repeater Equipment.

completion of such calls according to their *filing time* is applied only to very few points in Spain to which insufficient circuit groups are available, and for which the overloaded conditions justify such methods of operation as a temporary measure until facilities now under construction become available for traffic.

The Toll subscriber's multiple is provided with lamps at sections 1 to 5 of the 200 line board which permits the benefit of the C. L. R. service to be extended to these subscribers the same as to any other automatic subscriber.

Incoming calls for toll subscribers are normally completed at the inward position on the 100 line board.

Pay Stations

Equipment for automatic coin-box pay stations is being installed, and all pay stations will be operated on this basis in the future.

Adjustment of Operating Force

The arrangements for partial and full concentration make it possible to adjust the operating force on duty at any period of the day to the requirements of the service with a maximum of efficiency.

Toll and International Information Service Routine and Rates

Subscribers desiring any toll or international information dial code "09" as for any ordinary toll call. The transfer is made to the particular information position wanted over a trunk in the outgoing trunk multiple.

Toll routing and rate instructions are listed by codes under the glass plate of the keyshelf at each position. Any supplementary information required by an operator at any position on the different lines of board is obtained over a trunk to the toll information positions.

Toll Service Observing

To determine the quality of toll service at any time of the day, both from the subscriber's standpoint, and as regards the technical operation, regular observations are carried out under a strict, systematic observing routine.

The service observing operators are independent and separated from the traffic operating force.

Service observing equipment consists of a two-position section installed in a separate room,

with an entrance independent of the toll operating room.

Provision is made for observation of recording, outward, inward, and auxiliary services.

Calls handled by the C. L. R. operating method are observed from the appearance of the calling signal on the recording trunk multiple and through to the completion of the call and disconnecting signal, or to the preliminary or definite report to the calling subscriber in the case where a call is not completed on the first attempt.

Conclusion

It may be of interest to note some of the service results which are being obtained with this equipment which is handling approximately 3,300 outward, 4,500 inward, and 1,500 through toll calls a day exclusive of the two-number toll calls. Seventy percent of all offered calls are completed while the patron remains at the telephone. The average completion time of these calls is but 1.65 minutes while the average completion time of calls not completed on the first attempt is 9.56 minutes. The majority of the calls not completed on the first attempt are due to a few heavily loaded circuit groups for which additional facilities are being installed.

During the busy hour each outward operator establishes 13.1 connections on the average and each inward operator 52.9 connections.

In addition to toll calls, there are being handled daily 3,000 each of outward, inward, and through telefonema messages.

The Possible Application of Common Control Circuits to the Step-by-Step System

By J. H. E. BAKER and E. P. G. WRIGHT

IN connection with developments relating to a new type of step-by-step system, certain features have been perfected that are capable of being applied to existing Strowger Systems which may in consequence be both simplified and cheapened.

It is well known that in the standard Group Selector of the Strowger System, one relay is used for 98% of the holding time of the switch. The remainder are used only for the time required for positioning the switch, representing about 2% of the holding time, but as they are permanently associated with the switch their use is very inefficient. New circuits have been designed showing how the selector proper with only its holding relay can be divorced from the positioning relays which may be made common to a group of selectors. This arrangement obviously uses the apparatus more efficiently, particularly in the case of special selectors such as absorbing and switching, since the majority of the special discriminating apparatus can be concentrated in the common circuit.

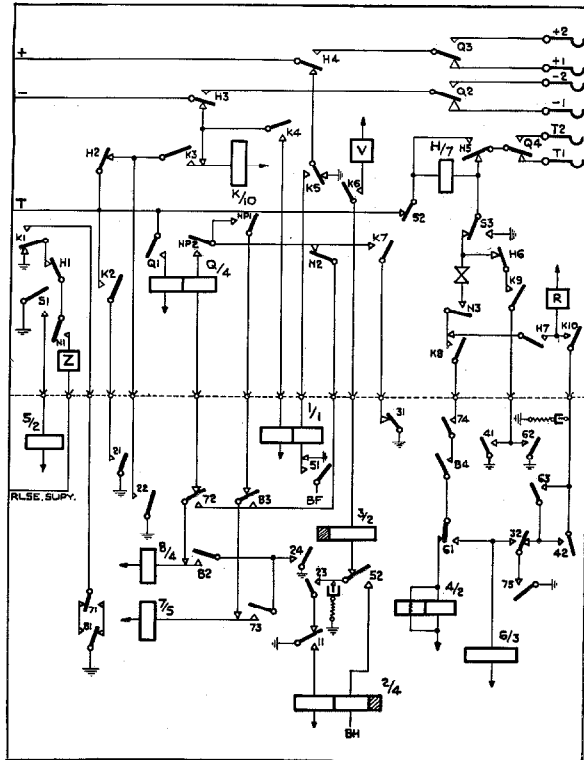

Figure 2. Switching and Absorbing Selector

a switching and absorbing selector and Figure 3 illustrating a final selector. Similar arrangements may be made for the 200-pt. Line Finder Circuits.

Experience will show whether it will be satisfactory to rely on ground testing for common control circuits or whether it will be necessary to use marginal battery testing. Although the occupancy of the common circuits will not be unusually high, the frequency of testing may be severe in view of the short holding time. If ground testing is acceptable, the new circuit may be introduced into an existing exchange without affecting the preceding or succeeding apparatus, and could, therefore, be used on extensions.

The new principles in their simplest form cannot be applied to incoming 2-wire selectors in view of the necessity for passing a signal back

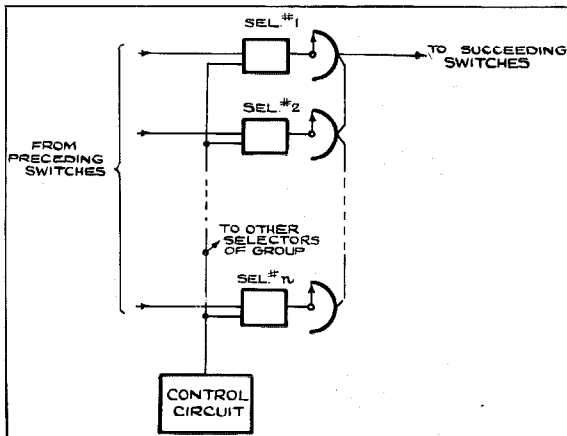

Figure 1. Common Control Working

A general idea of common control working is given in Figure 1, while the application of these principles can be seen from Figure 2 illustrating

to the outgoing end whilst the common circuit is occupied.

Some slight increase must be made in the number of switches in view of the fact that a number of the selectors are artificially busied whilst the common circuit is in use. This increase will depend upon the occupancy of the selectors and the number of switches served by each common control circuit. Where the quantity of selectors is high, a ratio of 20 to 1 might be employed. In smaller quantities a ratio of 10 to 1 is likely to be preferable.

The application of these principles should show a saving of 3% to 4% on the automatic portion of the cost of an exchange. It should also be possible to make a similar saving in floor space.

Common control circuits may be introduced in a similar way for special final selectors such as those used for rural party lines with coded ringing, and there are also other interesting possibilities such as the useful employment of spare levels or outlets to augment heavily loaded groups. Since the apparatus necessary to obtain these results is located in the common control circuit it represents a very small additional cost to each selector.

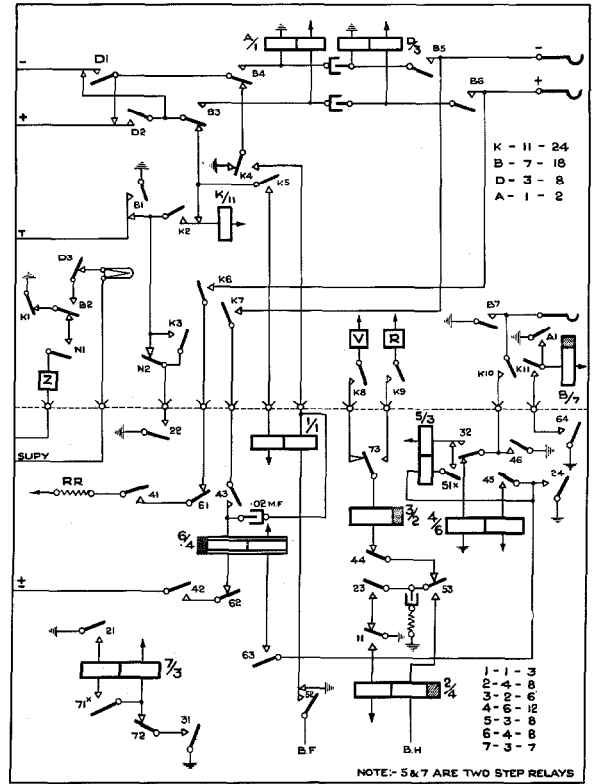

Figure 3. Final Selector.

The Rôle of Radio in the Growth of International Communication¹

By HAROLD H. BUTTNER

Assistant Vice-President, International Telephone and Telegraph Corporation

INTERNATIONAL communication in some form has existed since the beginning of civilization, while the development of rapid communication as we know it today has occurred wholly within the last hundred years, an interval of time exceedingly small compared with the age of civilization. The development of radio has been even more rapid than that of other forms of communication, and the greatest progress of radio may be said to have occurred since the beginning of the World War.

The development of communication in its international aspects may be considered closely allied to the development of communication itself. That radio is no respecter of national boundaries is only too well known. The phenomenal growth of radio communication has given rise to considerable misgiving in the minds of many as to the rôle which radio is to play in the future of communication. Radio has come to be a byword well known to millions through the development of radio broadcasting. In the popular imagination, it is felt that it is only a question of time until radio will become the universal medium for communication, and that wires and cables, becoming obsolete, will be abandoned. On the other hand, there are those who believe that the future of radio is exceedingly limited, and will be confined largely to broadcasting and communication with and between mobile stations, where of course the use of wires would be impossible. It is believed by some that radio will be displaced eventually from the broadcast field for local areas by the use of wire broadcast systems. There are even those who believe that the wire interests are making a concerted effort to gain control of radio in order

to stifle its growth and to overcome the menace of radio to the wire communication systems of the world. To communication engineers, however, it is quite evident that these extremely divergent views are neither founded upon logic nor upon a clear understanding of the technical and economic problems involved in communication in general.

A little consideration will show that in the future development of international communication there will be a very definite and logical use for both wire and radio communication. We might mention briefly some of the principal factors which govern this situation. It is well known that short wave radio stations for long distance communication, at least with a volume of traffic not too great, require a smaller investment than the corresponding cable or wire systems. This is particularly noteworthy in the case of long distance transoceanic communications. On the other hand, between important widely separated centers where the traffic density is great, or where there is important way traffic to be picked up, it is probably true that wire systems can operate more economically than radio systems, and that the cost per unit of communication is lower than corresponding radio costs. The development of both wire and radio for transoceanic telegraph work has proceeded to a point where one may estimate with considerable exactness the cost of each facility and thus determine in advance the relative advantages of each for given conditions and traffic load. As radio circuits are subject to interruptions from time to time from atmospheric interference or magnetic storms, continuity of service over a full 24-hour period is not always assured. While radio circuits do suffer interruptions of relatively short duration intermittently, it is also known that important cable circuits have been interrupted by natural causes and remained inoperative over considerable periods of time. Radio possesses the distinct

¹ This paper was read by the author at the 1930 Convention of the Institute of Radio Engineers held at Toronto, Ontario, Canada, and was published in the January, 1931, issue of the Institute *Proceedings*. It is presented in this issue of *Electrical Communication* with the kind permission of the Institute of Radio Engineers in somewhat amplified form and with minor changes to take care of the more recent developments in international communication.

advantage of being able to transmit to several places at once, or to widely separated localities at different hours, while cable traffic must be confined to the cable route and its corresponding lines. The use of radio avoids the difficulty inherent in connecting the shore end of a cable with interior points, and also the objection voiced by certain inland countries when their international communications pass through the facilities of another country, subject at times to censorship. The inherent secrecy of cable communication is of particular importance in time of war, while radio communication does not possess in itself the same degree of secrecy as the cables, and may be subjected to artificial interference by the enemy. On the other hand, cables can and have been cut by military agencies and have remained inoperative during the entire period of a war. It seems evident from the obvious advantages and corresponding disadvantages of each, that neither will displace the other, and that we must look in the future toward a coordination of the radio and cable systems where each will take a predominating position in the particular economic field which it is best suited to serve. Radio and cable services are essentially complementary.

The fact, not universally recognized, that the number of radio channels available, particularly those for use over long distances, is limited, will serve to confine the use of radio more and more in the future to those services for which it is best adapted. Those services where radio is essential, such as broadcasting, transoceanic telephony, marine and aeronautical communication and direction finding services, television and meteorological service, must not be deprived of adequate radio channels in order to build up nonessential radio circuits but, rather, should be allowed to obtain their fullest development by freely allocating to them the radio channels essential to their progress in the future. The extension of wire and cable communication systems to localities not formerly served on account of economic factors will from time to time release valuable radio channels for the development and pioneering of new services where the use of radio is essential.

In certain circles, an erroneous impression prevails that the recent spectacular development of radio has brought about an extraordinary

competitive situation between wire and radio services, particularly in the international field. If one surveys the great opportunity throughout the world for the improvement of existing communication facilities and the necessity for building up facilities where they do not exist at present, one finds unlimited opportunity for the expansion both of wire and radio systems. It is obvious that the development of either radio or wire traffic in new areas must add to the business handled by its complementary facility. Authorities agree that there exists a very real need in many fields for further advancing and increasing international communications.

After a study of the pressing telegraph communication problem confronting Great Britain and the British Dominions through the uneconomic parallel competitive construction of radio and cable facilities, each without due regard for the other, it was found necessary to provide a means for their coordinated operation and harmonious development in order to safeguard the future of electrical communications of the British Empire.

The International Telephone and Telegraph Corporation early appreciated the advantages of such coordinated communication, and is developing its wire line, cable, and radio facilities in such a way that the various services supplement each other. Emergency radio telegraph channels have been established between New York and various points in South America to supplement the All America Cable system in times of cable failure, and a similar project is being carried out in the Pacific by Mackay Radio to supplement the Commercial Pacific Cables. Short radio telegraph links have been established between the various points in South America as feeders for the cable system and to provide communication for territory which is not yet sufficiently developed to make the construction of land lines economical.

In the same way the various telephone properties of the International System have been or will be joined by long distance toll lines where this is the most economical method, and by radio telephone links where other methods of intercommunication are not practical.

It seems evident that any agency or company engaged in communication upon an international scale must employ both wire and radio in order

to take advantage of the varying conditions which must be met in order to render a complete service. It is not by means of unnatural competition that the public will receive the improvements in communications and lower rates in the future, but on the other hand, it is only by the closest coordination between wire and radio systems that satisfactory results will be achieved.

The phenomenal progress and growth in international communications in recent years has been due in no small degree to the systematic manner in which research and engineering study has been organized and carried out by the communication interests. Progress in the future may be assured only by continuation of the broad-minded policies which have proved so successful in the past.

In order to justify these policies, the communication interests must have reasonable assurance that they will be permitted to work out international communication problems along economic lines, free from artificial restrictions which foster wasteful competition with its attendant losses in revenue and ultimate deterioration of the communication services themselves.

The development of telephony upon an international scale has been somewhat slower than the growth of international telegraphy, due to the language difficulty involved, not to mention the difficult technical problem involved in the coordination of telephone systems operated by different agencies and administrations. The obvious advantages inherent in unity of administration and language made possible the early development of long distance telephony in the United States. The progress made toward the solution of the technical problems of long distance telephony in the United States, and the ensuing rapid expansion of long distance telephone circuits, indicated to the European nations that the means for telephone communication on a truly international scale were already at hand. Splendid progress having been made in recent years by the various European administrations and agencies in building up a network of international telephone lines, it was only a further step in this rapidly moving development to seek means of overcoming the natural barriers preventing intercommunication between the telephone networks of the new and old world. The difficulties to be overcome in bridging the ocean

gap were many, but fortunately the development of radio had reached a point where successful communication on a commercial scale between Europe and America was accomplished after a period of intensive study and research. The faith of the officials of the American Telephone and Telegraph Company and the British Post Office who sponsored the work of pioneering telephone communication paths across the Atlantic was justified almost immediately by the rapid growth of traffic from less than ten messages per day in 1927 to nearly fifty per day in 1929.

The marked success of the transatlantic radio telephone circuit connecting Europe and America was followed by intense activity in the construction of other radio circuits between important telephone areas of the world. The second important step toward the ultimate accomplishment of international telephony on a world-wide basis was the construction by the International System of a radio telephone circuit connecting the telephone system of Spain with the wire networks of Argentina, Chile, and Uruguay. This was followed by the construction of a radio telephone circuit under the joint auspices of the International System and the American Telephone and Telegraph Company, linking North America and the three above mentioned South American countries. Following this, the International System, with the co-operation of various European Administrations, opened circuits from Buenos Aires to Paris, Berlin, and London. Thus, the telephone systems of Argentina, Chile, and Uruguay were linked not only with France, Germany, Great Britain, and Spain but also by means of combined radio and land line connections with most of the other countries of Europe, with Spanish Morocco, and with the Canary Islands.

In the meantime, radio telephone channels have been developed by European nations to bring their colonies or dominions into closer contact with them. Over 100,000 circuit miles of radio telephone channels are now in operation while over 178,000 miles will be in operation in the not remote future.¹

¹ The diagrammatic frontispiece in the January, 1931, issue of *Electrical Communication*, "International Telephone Connections Available Through Radio Telephone Circuits" may be of interest in connection with the present paper.

The relative importance of these various channels, however, differs considerably, since in many cases connection is made only to one or more booths at each terminal of the circuit. Under the theory of co-ordinated communications herein outlined, a radio telephone channel only achieves its greatest utility when it takes the place of an ordinary toll line by connecting the telephones of individual subscribers of the telephone networks located at each terminal. Roughly, 50,000 miles of such true radio links are now in operation.

It is interesting to note that the various radio telephone circuits have been developed almost to an equal extent by private enterprise and by government administrations. Of the total circuit miles now in operation, approximately 47% are controlled by private companies, and 53% are controlled or will be controlled by government

administrations. The addition of the various projected circuits will change this ratio only to a minor extent.

The leading position of the International System in this interconnection of telephone systems by means of radio is shown by the fact that out of the circuit miles controlled by private agencies, or shortly to be so controlled, 37% have been built under the auspices of the International System, while upon completion of all the circuits listed in Table I as under construction and projected, about 45% of the privately controlled circuit miles will be operated by associated companies of the International Telephone and Telegraph Corporation (see Table II).

The technical developments in the art of electrical communication have already proceeded to the point where it is theoretically

TABLE I
RADIO TELEPHONE CIRCUITS
March, 1931

RADIO TELEPHONE CIRCUITS IN OPERATION	RADIO TELEPHONE CIRCUITS UNDER CONSTRUCTION	RADIO TELEPHONE CIRCUITS PROJECTED
Distance in Nautical Miles	Distance in Nautical Miles	Distance in Nautical Miles
New York-London (4 circuits)..... 12,000	London-Capetown..... 5,200	London-Canada..... 2,850
New York-Buenos Aires..... 4,600	Rio de Janeiro-Buenos Aires..... 1,050	London-Cairo..... 1,900
Buenos Aires-Madrid (2 circuits)..... 10,540	Rio de Janeiro-Madrid..... 4,300	London-Calcutta..... 4,300
Buenos Aires-Paris (2 circuits)..... 11,700	Rio de Janeiro-New York..... 4,150	London-Tokyo..... 5,100
Buenos Aires-Berlin (2 circuits)..... 12,600	Santiago-Madrid..... 5,700	San Francisco-Tokyo..... 4,450
Buenos Aires-London..... 6,100	Santiago-Paris..... 6,200	San Francisco-Manila..... 6,000
Rio de Janeiro-Berlin..... 5,270	Sydney-Wellington..... 1,000	San Francisco-Sydney..... 6,200
Rio de Janeiro-Paris..... 4,800	San Francisco-Honolulu..... 2,100	London-Hongkong..... 5,200
Rio de Janeiro-Madrid..... 4,300	New York-Bermuda..... 690	Belgium-Belgian Congo..... 5,150
Rio de Janeiro-Buenos Aires..... 1,050	Madrid-Mallorca..... 316	Lima-New York..... 3,100
London-Sydney..... 9,200		Lima-Buenos Aires..... 1,750
Paris-Indo China..... 5,470		Lima-Santiago..... 1,388
Paris-Algiers..... 725		Bogota-Santiago..... 2,300
Holland-Dutch East Indies..... 6,340		New York-Bogota..... 2,133
Berlin-Bangkok..... 4,650		
Madrid-Canary Islands..... 1,000		
100,345	30,706	51,821

TABLE II
SUMMARY OF RADIO TELEPHONE CHANNELS BY OPERATING AGENCIES

	In Operation	Under Construction	Projected	Total	Per cent.
Int. Tel. & Tel.....	17,695	16,541	8,055	42,291	23.1
British Post Office.....	18,250	6,200	15,375	39,825	21.7
Trans-Radio.....	32,990			32,990	18.0
A. T. T.....	8,300	3,470	10,941	22,711	12.4
French Govt.....	14,445	3,100		17,545	9.5
Dutch Govt.....	6,340			6,340	3.4
Belgian Govt.....			5,150	5,150	2.8
Japanese Govt.....			4,775	4,775	2.6
Philippine Tel. Co.....			3,000	3,000	1.6
Siamese Govt.....	2,325			2,325	1.2
Marconi.....		345	1,425	1,770	0.9
R. C. A.....		1,050		1,050	0.5
Operator not yet selected.....			3,100	3,100	1.7
	100,345	30,706	51,821	182,872	

possible for any individual situated at any place on the globe to communicate by telephone with any other individual at any other place by means of a combination of wire and radio circuits. The

a further demand arose for telephone communication with large passenger ships plying between the principal world ports.

The International System early started experiments on ship-to-shore telephony, and, after several months of tests, the first formal demonstration of ship-to-shore telephony was carried out on July 18, 1929, between the S.S. Berengaria, and the radio station at Trappes, France, of the International Telephone and Telegraph Laboratories. After further research was completed, commercial radio telephone installations were made on the S.S. Majestic and S.S. Olympic by the International System, and at the present time these two British liners, as well as one American and one other British steamship provide telephone service for their passengers to both sides of the Atlantic while the ships are at sea. The International System also equipped the S.S. Belgenland with a radio telephone from which the longest recorded commercial call from a ship was made from a position in the Pacific near Hongkong, and London, 7,000 miles distant.

Radio is destined to play an important part in the development of new international trans-

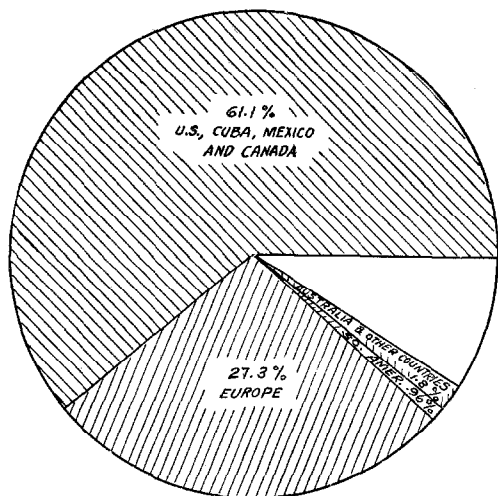

Figure 1—Interconnecting Telephones, 1930. The Shaded Area Represents the Intercommunicating Telephones of the World—91 per cent of the Total—Consisting of Intercommunicating Groups Connected Into One Large Group by Radio Links.

relative extent to which these technical possibilities have already been reached in a commercial sense is indicated in Figure 1, which shows graphically the fact that out of a total world development of 35,000,000 telephones, over 30,000,000 may be interconnected by virtue of the various continental land wire networks and their interconnecting radio links. For comparative purposes there is indicated in Figure 2 the greatest extent of interconnected telephone development prior to the advent of radiotelephony on an international scale. The greatest use of radio by the maximum number for the purpose of direct person-to-person communication by means of the spoken word as well as by the use of record communication can of course be developed only by a thorough co-ordination of existing and future wire systems.

It is agreed that the development of communication fosters a community of interest and a community of interest in turn requires further development of communications, and so on, in an ever widening expanse. In the light of the above, it is not remarkable that radiotelephone communication between Europe and the Americas having reached a position of commercial importance,

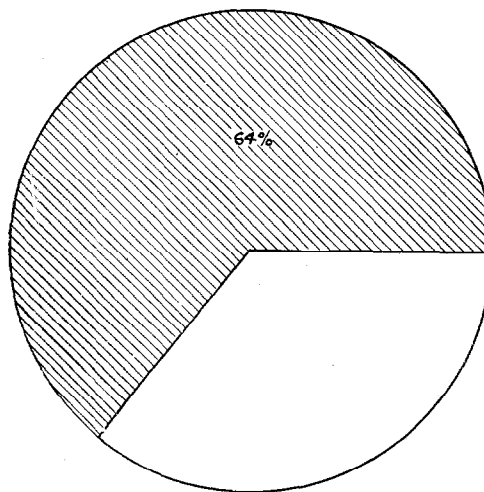

Figure 2—Interconnecting Telephones, 1926, Showing the Greatest Extent of Interconnected Telephone Development Prior to the Advent of Radio Telephony on an International Scale. The Shaded Area Represents the Telephones in the United States, Canada, and Cuba Which Were Intercommunicating in 1926—64 per cent of the World's Telephones.

portation systems by its aid to the safety of navigation of airplanes and airships in transoceanic and transcontinental flights. Radio already has contributed in no small measure to

the success achieved by this new means of travel. The accomplishment of the only wholly successful transatlantic flight from east to west was attributed in a large degree to the invaluable assistance of radio during the flight.

It is to radio that we must look in the future for the greatest development of television upon a commercial scale, as the wide frequency bands required for television that is worthy of the name can only be made available economically in the lower range of the short wave spectrum.

Prior to the War, the international aspect of radio communication was of comparatively negligible importance, international interest being chiefly concerned with the use of radio for the safeguarding of life at sea. International rules and regulations governing the use of radio were quite simple in character, and agreement was readily obtained. However, in recent years, the use of radio internationally has become more and more important, and it was recognized that its development would be seriously hampered unless wise provisions governing the use of radio could be formulated and agreed upon universally. The International Radio Conference called at Washington in 1927, largely attended by representatives of the principal nations of the world, did important work in formulating rules tending towards the most efficient use of radio and the prevention of international interference. It was recognized before the Washington Conference was called, that the task confronting the delegates was so great and of such importance that it would be impossible to hope for its accomplishment within a reasonable time. It was also felt that the art of short wave radio was so new that it would be dangerously restrictive to attempt to formulate other than the most basic rules for the use of the frequencies in the high frequency region of the radio spectrum until further experience had been gained internationally in their use. Moreover, the advent of short

wave radio had brought the international aspect of radio to the fore to such an important degree that it would be very desirable in order to foster the uninterrupted development of radio, to provide for an international consulting body to study important technical aspects of short wave radio. It was agreed that the success of wire telephony upon an international scale in Europe was due in no small measure to the fine co-operation and intensive effort of the Comité Consultatif International (Telephone) and that a similar international body could profitably be constituted to study and recommend to the nations important technical aspects of radio. This committee, the Comité Consultatif International de Radio, met in 1929 at The Hague, where a number of problems of importance to the future growth of radio were studied. Much work yet remains to be done. It has been found necessary to convene the Comité Consultatif International de Radio in May, 1931, at Copenhagen, in order to prepare the way for the next International Radio Conference which is scheduled to meet in 1932 in Madrid.

The future growth of radio is largely dependent upon the formulation of wise technical and administrative rules governing its use. The spirit manifested in the International Radio Conferences has been one of unlimited confidence in the future of Radio in international communication. This bright future can only be realized if a minimum of restrictions be placed upon the use of radio and only such legislation should be formulated that has proved by the test of time to be constructive and not tending toward restriction in any sense of the word. While it is of the greatest importance that radio be allowed to develop unhampered by technical restrictions, it is equally vital that communications in general be free from artificial restrictions in order to attain their fullest development in accordance with economic law.

INTERNATIONAL TELEPHONE AND TELEGRAPH CORPORATION

BOARD OF DIRECTORS

<p>ARTHUR M. ANDERSON J. P. Morgan & Co.</p> <p>HERNAND BEHN, President</p> <p>SOSTHENES BEHN, Chairman</p> <p>F. WILDER BELLAMY Dominick & Dominick</p> <p>EDWARD J. BERWIND Chairman, Berwind-White Coal Mining Company</p> <p>JOHN W. CUTLER Edward B. Smith & Co.</p> <p>R. FULTON CUTTING Chairman of the Board, All America Cables, Incorporated</p> <p>GEORGE H. GARDINER Davis Polk Wardwell Gardiner & Reed</p> <p>CONDE DE GÜELL President, Compañía Trasatlántica Española, Barcelona</p> <p>ALLEN G. HOYT Vice-President, The National City Bank of New York</p> <p>RUSSELL C. LEFFINGWELL J. P. Morgan & Co.</p> <p>CLARENCE H. MACKAY Chairman of the Board, Postal Telegraph and Cable Corporation</p>	<p>JOHN L. MERRILL President, All America Cables, Incorporated</p> <p>CHARLES E. MITCHELL Chairman, The National City Bank of New York</p> <p>WALTER E. OGLVIE President, Havana Terminal Railroad Company</p> <p>HENRY B. ORDE, Vice-President</p> <p>BRADLEY W. PALMER Chairman of the Executive Committee, United Fruit Co., Boston</p> <p>GEORGE E. PINGREE President, International Standard Electric Corporation</p> <p>WOLCOTT H. PITKIN Vice-President and General Attorney</p> <p>LANSING P. REED Davis Polk Wardwell Gardiner & Reed</p> <p>LOGAN N. ROCK Secretary</p> <p>MARQUÉS DE URQUIJO President, Banco Urquijo, Madrid</p> <p>GEORGE H. GARDINER General Counsel</p>
---	--

OFFICERS

<i>Chairman</i> SOSTHENES BEHN	<i>President</i> HERNAND BEHN	
<i>Vice-Presidents</i>		
HENRY B. ORDE LEWIS J. PROCTOR GEORGE E. PINGREE	PHILIP K. CONDUCT JOHN L. MERRILL FRANK GILL	FRANK W. PHELAN WILLIAM F. REFF A. H. GRISWOLD
<i>Vice-President and Chief Engineer</i> JAMES L. McQUARRIE	<i>Vice-President and General Attorney</i> WOLCOTT H. PITKIN	
<i>Comptroller</i> EDWIN F. CHINLUND	<i>Secretary</i> S. G. ORDWAY	<i>Treasurer</i> JAMES E. FULLAM

THE International Telephone and Telegraph Corporation was organized to cooperate and assist technically and financially in the general development of electrical communications in a broad international sense, as well as to develop truly national systems operated by the nationals of each country in which the International Corporation is or may become interested. The International Corporation was not organized with a single profit-making purpose to itself nor with the desire of imposing American practices in its foreign activities. There appeared to be a fruitful field of service to be rendered in bringing together under one general organization electrical communications systems, and the extension by the Interna-

tional Corporation to the Associated Companies of the technical and financial facilities and direction that might be needed for their intensive and efficient development. The best American practices have been suggested but never imposed. On the contrary, the International Corporation has always been ready and quick to adjust American practices to local conditions and to adopt such local practices as were conducive to the successful development of the various entities. The combined and co-ordinated effort of the Associated Companies of the International System is today justifying the plans and purposes of the founders of the Corporation.

International Standard Electric Corporation

Head Offices
NEW YORK, U. S. A.

European General Offices
LONDON, ENGLAND

Licensee Companies

- BELL TELEPHONE MANUFACTURING COMPANY.....*Antwerp, Belgium*
Branches: Berne, The Hague, Brussels.
- STANDARD ELECTRIC DOMS A SPOLECNOST.....*Prague, Czechoslovakia*
- CHINA ELECTRIC COMPANY, LIMITED.....*Shanghai, China*
Branches: Canton, Hankow, Harbin, Mukden, Peiping, and Tientsin, China.
- COMPAÑÍA STANDARD ELECTRIC ARGENTINA.....*Buenos Aires, Argentina*
- INTERNATIONAL STANDARD ELECTRIC CORPORATION, *Branch Office,*
Rio de Janeiro, Brazil
- INTERNATIONAL STANDARD ELECTRIC CORPORATION OF MEXICO....*New York, N. Y.*
- INTERNATIONAL TELEPHONE AND TELEGRAPH LABORATORIES, INCORPORATED
Hendon, England
- LE MATERIEL TELEPHONIQUE.....*Paris, France*
- NIPPON DENKI KABUSHIKI KAISHA.....*Tokyo, Japan*
Branches: Osaka, Dalny, Seoul, Taihoku.
- FERDINAND SCHUCHHARDT, BERLINER FERNSPRECH-UND TELEGRAPHENWERK
AKTIENGESELLSCHAFT.....*Berlin, Germany*
- STANDARD ELECTRIC AKTIESELSKAP.....*Oslo, Norway*
AKTIESELSKABET SKANDINAVISKE KABEL- OG GUMMIFABRIKER.....*Oslo, Norway*
- STANDARD ELECTRIC AKTIESELSKAB.....*Copenhagen, Denmark*
- STANDARD ELECTRICA ROMANA S/A.....*Bucharest, Rumania*
- STANDARD ELÉCTRICA, S. A.....*Madrid, Spain*
Branches: Barcelona, Bilbao, Sevilla, Santander.
- STANDARD ELETTRICA ITALIANA.....*Milan, Italy*
Branch: Rome.
- STANDARD TELEPHONES AND CABLES, LIMITED.....*London, England*
Branches: Birmingham, Glasgow, Leeds, Liverpool, Manchester, Dublin, Cairo,
Johannesburg, Calcutta, Singapore.
- STANDARD TELEPHONES AND CABLES (AUSTRALASIA), LIMITED.....*Sydney, Australia*
Branches: Melbourne, Wellington.
- STANDARD VILAMOSÁGI RÉSZVÉNY TÁRSASÁG.....*Budapest, Hungary*
- SUMITOMO ELECTRIC WIRE & CABLE WORKS, LIMITED.....*Osaka, Japan*
- VEREINIGTE TELEPHON-UND TELEGRAPHENFABRIKS AKTIENGESELLSCHAFT,
CZEIJA, NISL & CO.....*Vienna, Austria*
Branch: Tallinn.
- STANDARD ELECTRIC COMPANY W POLSCE SP. Z O. O.....*Warsaw, Poland*

Sales Offices and Agencies Throughout the World
