



ELECTRICAL COMMUNICATION

OCTOBER

No. 2

1930

VOL. 9

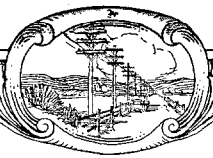

ELECTRICAL COMMUNICATION

A Journal of Progress in the
Telephone, Telegraph and Radio Art

H. T. KOHLHAAS, Editor

EDITORIAL BOARD

J. L. McQuarrie F. Gill G. Deakin P. E. Erikson G. H. Nash M. K. McGrath
G. E. Pingree P. K. Condict E. A. Brofos E. C. Richardson Frank C. Page

Published Quarterly by the

International Standard Electric Corporation

Head Offices

67 BROAD STREET, NEW YORK, N. Y., U. S. A.

European General Offices

CONNAUGHT HOUSE, ALDWYCH, LONDON, W. C. 2, ENGLAND

G. E. Pingree, President

L. N. Rock, Secretary

James E. Fullam, Treasurer

Subscription \$3.00 per year; single copies 75 cents

Volume IX

OCTOBER, 1930

Number 2

CONTENTS

- THE NEW TELEPHONE PLANT IN BARCELONA, SPAIN..... 79
By F. T. Caldwell, B. A. Turkhud, and J. J. Parsons
- TRAINING OF EGYPTIAN STAFF FOR ROTARY AUTOMATIC
TELEPHONE EXCHANGES..... 101
By E. A. Elliman
- PUBLIC ADDRESS SYSTEMS IN CINEMAS..... 107
By L. Dunbar
- TELEGRAPH AND TELEPHONE IN JAPAN..... 114
By Sannosuke Inada
- IN MEMORIAM—NAT FIELDING ROBERTS..... 138
- SOME MICROPHONE MEASUREMENTS AND SOME SUGGESTIONS
WITH REGARD TO MICROPHONE ARRANGEMENTS..... 139
By Siffer Lemoine

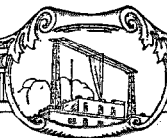



Cataluna Exchange, Barcelona, of the Compañía Telefonica Nacional de España.

The New Telephone Plant in Barcelona, Spain

By F. T. CALDWELL, B. A. TURKHUD, and J. J. PARSONS

BARCELONA, the most important seaport and the largest commercial and industrial centre of the Iberian Peninsula, is cosmopolitan in character and has a population of nearly a million inhabitants. Telephonically, Barcelona enjoys the distinction of having inaugurated the first installation in Spain when, on December 16, 1877, a circuit was established between the fortress of Montjuich and the Cuidadela, a fort on the harbour.

A few years later, a small local exchange was inaugurated with about twenty-five subscribers. Additional facilities were provided from time to time, until in 1928 the local telephone plant comprised six manual exchanges with a total of 14,200 working lines. In 1924, when the Cia. Telefonica Nacional de España took over the Barcelona plant, it was in every way inadequate to the demands placed upon it. Facilities for connecting new subscribers were lacking, inter-office trunks were insufficient for the traffic, many of the switchboards were of antiquated types, and owing to the unfavourable operating conditions, the service was far from satisfactory. Equipment for the most part was old and worn out, and the outside plant consisted entirely of cables and open wires strung over the housetops like a gigantic spiderweb covering the city. Spans of two hundred feet or more were not uncommon, and access to the supporting structures was difficult.

In regard to toll equipment and service, the situation was almost as bad. Only eight positions were available for handling this class of service, and these were of antiquated type. The lack of trunking facilities and the defective condition of the local plant also reacted on the toll service, the result being that calls were handled with considerable delay and transmission was often unsatisfactory.

In conformity with its established policy of providing the best and most modern type of telephone service throughout Spain, the Compañia Telefonica Nacional de España, on taking over the service in 1924, immediately laid plans for a complete new telephone plant in Barcelona,

and at the same time took energetic measures to provide relief and to improve the service as much as possible during the interval necessary for the construction and installation of the new plant. Worn-out cables were replaced, additional temporary cable facilities provided, local switchboards repaired and rearranged so as to increase their capacity, and trunking facilities increased. Considerable improvement in the local service was effected, and it was even possible to increase the number of subscribers' lines in service by about 1,600 (14%) between August, 1924, and September, 1928. The old toll switchboard was increased to 18 positions, and a toll line multiple was provided in order to eliminate interposition trunking. The improvement in service, both local and toll, was immediately noticeable; but, even with all the emergency additions and improvements, it was manifest that the old plant was entirely inadequate for the telephone needs of such a city as Barcelona and plans for the new plant were completed and executed with all possible speed.

On the 16th of September, 1928, the new toll and local telephone exchanges of the Compañia Telefonica Nacional de España were brought into public service. On that day, automatic offices with equipment for 26,000 lines were simultaneously cut into service, together with the toll board composed of 40 line and 10 recording positions, the Telefonema¹ switchboard of 16 positions, and other boards for special services. This cut-over is unique in Europe by virtue of its magnitude.

The automatic equipment is of the well-known 7-A Rotary machine switching type described in previous issues² of *Electrical Communication*. The new toll board is of the No. 2003 type, which up to the present has not been installed in Europe, except in Spain.

¹The Telefonema is a message filed with the Telephone Company and is transmitted by a telephone operator to the distant office, where it is typed on a message blank and delivered as an ordinary telegram.

²G. Pocholle, "La Transformation du Réseau Téléphonique de Paris en Automatique," Vol. VI, p. 141, 1928.

G. Deakin, "The Rotary Automatic Telephone Introduced into Paris," Vol. VII, p. 95, 1928.

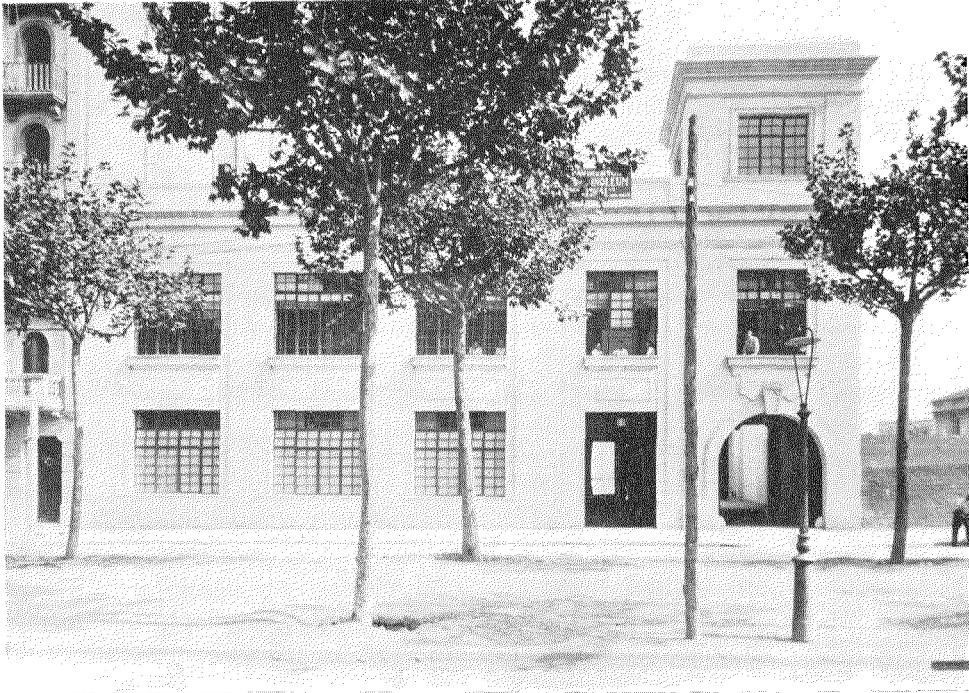

Figure 1—Clot Sub-central Exchange Building.

The Barcelona subscribers are distributed over four exchanges, Cataluna, Travesera, Arenas, and Clot. These four exchanges were equipped initially with 10,000, 6,000, 5,000, and 5,000 lines, respectively, thus giving a total of 26,000 lines. This initial capacity has since been increased by the addition of 6,000 lines in Cataluna, 4,000 in Travesera, and 1,000 each in Arenas and Clot, thus bringing the total installed capacity of the area to 38,000 lines.

The Cataluna building is shown in the frontispiece, and one of the other buildings is illustrated in Fig. 1.

Traffic Calculations

Records of local traffic under manual operation indicated an average calling rate of 0.98 calls per line in the busy hour, and an average holding time of 90 seconds, or the equivalent of about 0.75 equated 2 minute calls. To provide a safe margin to cover the expected increase in

traffic under automatic operation, the initial equipment was engineered on the basis of a 1.7 equated busy hour calling rate. Although this relatively high calling rate has been reduced to 1.4 for the extensions, the prudence of designing to the higher rate for the initial installation was amply indicated at the cut-over. On the day following the introduction of the new equipment, it was found that the traffic handled was 400% higher than when manually operated. This abnormal calling rate rapidly decreased, and within two days the traffic became stabilized at an average calling rate for the city equal to approximately 1.5 equated two minute calls per line in the busy hour.

The estimated traffic and the number of switches provided for inter-office and special service calls are shown in Fig. 2, which also indicates the maximum call-carrying capacity of the switches provided for a probability of $P=0.01$. The accompanying key gives the basis

on which it has been compiled. The relative locations of the four offices are indicated in the skeleton plan of Barcelona, Fig. 3.

The difference between the number of lines and the number of terminals at each office is due to the existence of 2-party line subscribers, provision being made for 1,000 at Cataluna, 600 in Travesera, and 600 in Clot and Arenas, respectively. The calling rate for each 2-party line has been assumed equal to that of one main line.

The first line finder switches have been calculated for $P=0.001$ and 14 switches having a call carrying efficiency of 174 E.B.H.C. have been furnished. The total number of first line finders divided by 100—the number of terminals on the second line finder arc—fixes the number of groups of connection circuits. The number of circuits in the group is obtained by evaluating the proportion of originating calls and applying the curve for $P=0.001$. In the case of Cataluna, 14 groups of connection circuits are necessary, each group being provided with 59 switches

having a call-carrying capacity of 1,167 E.B.H.C. In practice, the first line finders are distributed over 3 or 5 groups of connection circuits, thus increasing the availability of the latter.

The first group selectors and the register choosers are an integral part of the connection circuits and their number is, therefore, the same as that of the second line finders. The registers are calculated for $P=0.001$ and a holding time of 15 seconds is allowed.

The number of second group selectors both local and incoming is shown in Fig. 2. The third group selectors give access to 2,000 lines from every level and their number is determined by dividing the total traffic directed towards these switches proportionally to the equipped levels and dividing the quotient so obtained per numerical group by 19.33, the individual trunk efficiency for $P=0.01$ of a 30 point arc. In the case of Cataluna, 210 switches per 2,000 numerical group have been provided, and are capable of handling 4,101 E.B.H.C.

| TO | | | | FROM | | | | | | | | | | | | Total incoming except toll and special services | | Total originating traffic composited | | |
|--|--------------------|------|-----------------------|----------------------|-------|--------------|---------------------|-------|--------------|-------------|---------------------|-------|--------------|-------------|---------------------|---|--------------|--------------------------------------|-------|--------|
| | | | | CATALUNA | | | TRAVESERA | | | CLOT | | | ARENAS | | | | | | | |
| OFFICE | Numbered terminals | % | L CR EBHC | 9500 1.7 16150 | 48% | 7750 | 5700 1.7 9690 | 42.5% | 4130 | 1.08 | 4700 1.7 7990 | 41.5% | 3310 | 1.03 | 4700 1.7 7990 | 39.5% | 3160 | 595 | 10600 | 18,330 |
| Cataluna | 10,000 | 38.5 | A B C D E | 1.25 435 | 48% | 7750 8410 | 1.10 225 | 42.5% | 4130 4350 | 1.08 190 | 4700 7990 | 41.5% | 3310 3670 | 1.03 180 | 4700 7990 | 39.5% | 3160 3480 | 595 | 10600 | 18,330 |
| Travesera | 6,000 | 23.1 | A B C D E | 0.52 120 | 12% | 1940 2320 | 0.71 90 | 16.5% | 1610 1740 | 0.52 60 | 4700 7990 | 12% | 930 1160 | 0.52 60 | 4700 7990 | 12% | 980 1160 | 240 | 3370 | 5,480 |
| Clot | 5,000 | 19.2 | A B C D E | 0.81 150 | 15.5% | 2530 2900 | 0.89 90 | 17% | 1640 1740 | 1.28 120 | 4700 7990 | 24.5% | 1970 2320 | 0.83 75 | 4700 7990 | 16% | 1270 1450 | 315 | 5440 | 7,410 |
| Arenas | 5,000 | 19.2 | A B C D E | 0.81 150 | 15.5% | 2530 2900 | 0.91 100 | 17.5% | 1690 1930 | 0.76 75 | 4700 7990 | 14.5% | 1170 1450 | 1.30 120 | 4700 7990 | 25% | 1990 2320 | 325 | 5390 | 7,380 |
| Special services | — | — | A B C D E | — 80 | 9% | 1400 1550 | — 40 | 6.5% | 620 770 | — 40 | 4700 7990 | 7.5% | 590 770 | — 40 | 4700 7990 | 7.5% | 590 770 | — | — | 3,200 |
| All Offices total originating traffic. | 26,000 | 100% | A B C D E | — — | 100% | 16150 — | — — | 100% | 9690 — | — — | 4700 7990 | 100% | 7990 — | — — | 4700 7990 | 100% | 7990 — | — | — | 41,820 |

KEY
 L = Lines (calling equipments).
 CR = Calling rate.
 EBHC = Equated busy hour calls—120 seconds holding time.
 A = Community factor.
 B = Percent of originated calls = community factor (A) x % of total numbered terminals.
 C = Traffic in EBHC.
 D = Number of switches provided.
 E = Maximum call carrying capacity of switches provided.
 Trunk efficiency ($p=0.01$) is $19.33 = D \times 19.33$.

Figure 2—Estimated Traffic and Number of Switches.

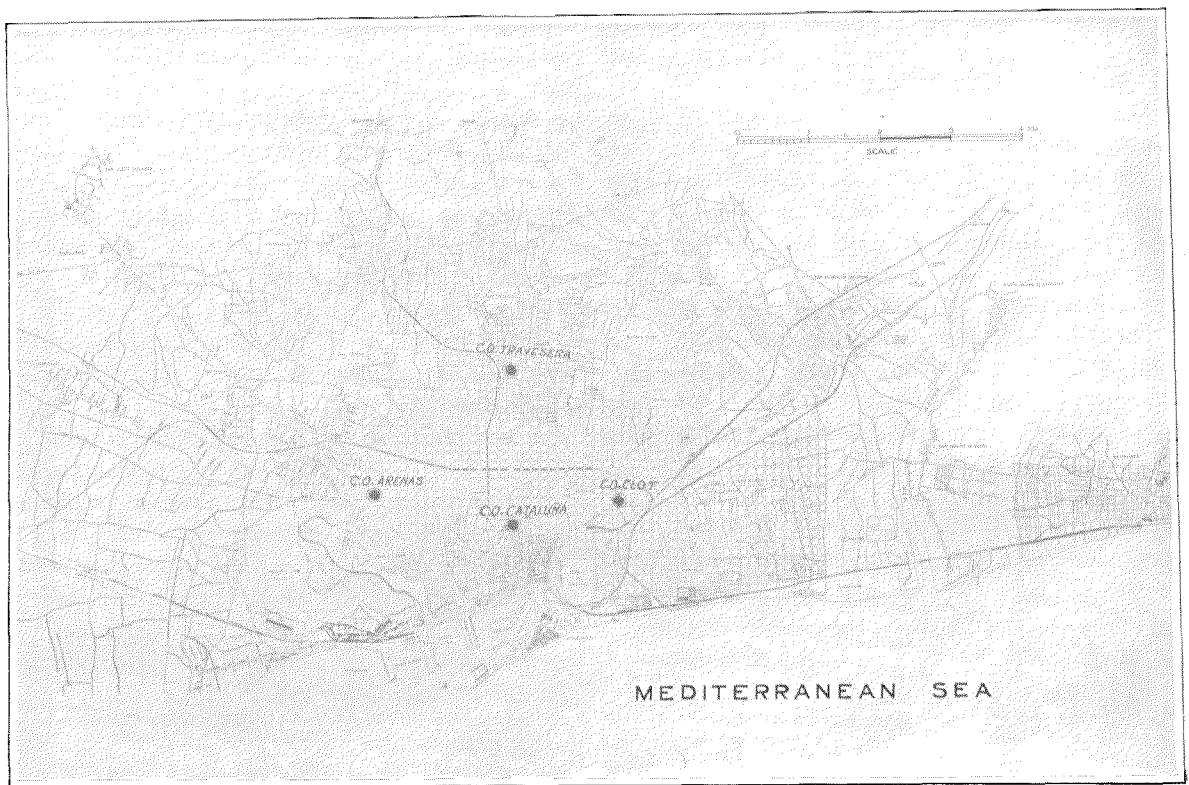

Figure 3—Plan of Barcelona.

Since the traffic per 2,000 numerical group is in excess of the call-carrying capacity of 30 trunks working in one group, it is necessary to provide a number of traffic splits.

The final arc serves 200 subscriber lines, and the number of switches required is computed from the traffic incoming to such groups (using the curves $P=0.01$). Additional switches are provided in groups serving P.B.X. lines to cover a heavier incoming traffic to such subscribers. Taking the Cataluna office as an example, it will be seen that the 45 groups of main line subscribers are provided with 20 final selectors per 200 lines, and that the 5 groups of P.B.X. lines are furnished with 30 switches per 200 lines. The call-carrying capacities of these switch groups are 355 and 586 E.B.H.C., respectively.

These notes on the traffic calculations are illustrated on the junction diagram shown in Fig. 4 for the Cataluna office.

Capacity of Area

Although 5-digit dialling will suffice for some time to come, it was thought advisable to make provision for 6 digit numbers. The trunking

scheme allows for 9 units of 20,000 lines without the need for additional racks of switches. The register bays are furnished with plates on which the extra counting relays required for 6-digit dialling can be mounted.

The numbering of the area is shown in Fig. 5.

Building Layouts

The Arenas building is constructed for an ultimate capacity of 30,000 lines of 7-A Rotary machine switching equipment. One floor of this building is at present being used for offices. The Clot and Travesera buildings were constructed for a capacity of 20,000 lines each, but, by the addition of another floor, which is provided for in the design, the capacity of each may be increased to 30,000 lines.

The Cataluna exchange, which has an ultimate capacity of 20,000 lines, serves the "downtown" and port area, which includes the most important commercial and financial establishments, docks, warehouses, hotels, and places of amusement. It is located in a nine-story building surmounted by a tower and prominently situated on the

beautiful Plaza de Cataluna—the centre of Barcelona’s business and social life.

A visit to this building, which houses the Commercial offices of the Telephone Company and the toll switchboard and equipment, as well as the 7-A Rotary exchange, reveals from floor to floor practically every phase of telephony as typified by the most modern equipment and operating arrangements for assuring a rapid and efficient communication service, both local and long distance.

The basement contains the cable entrance, boilers for the heating system, storage space, the waiting room for messenger boys, and two 300 KVA transformers for power service. Separate cables supply current at 6,000 volts to each transformer, and switching arrangements are provided so that either one may be used. The low side is at 220 volts.

The ground floor is taken up by a spacious public hall in which is located the Commercial section and a large attended pay station for local, toll and telefonema service. A pneumatic tube runs from the telefonema counter to the operating room on the eighth floor.

The first and second floors are given over to offices of the administrative and operating departments of the Telephone Company.

The third floor contains the local main distributing frame, laid out for a capacity of 20,000 lines, the battery room, charging and auxiliary machines, power control boards, and a local test board (Wire Chief’s Desk) of 8 positions. All testing on the Barcelona outside plant is centralised at this board, which is connected by trunks to the other central offices so that any trunk or subscriber’s line may be picked up for test. The Wire Chief trunks (01 code) also terminate on

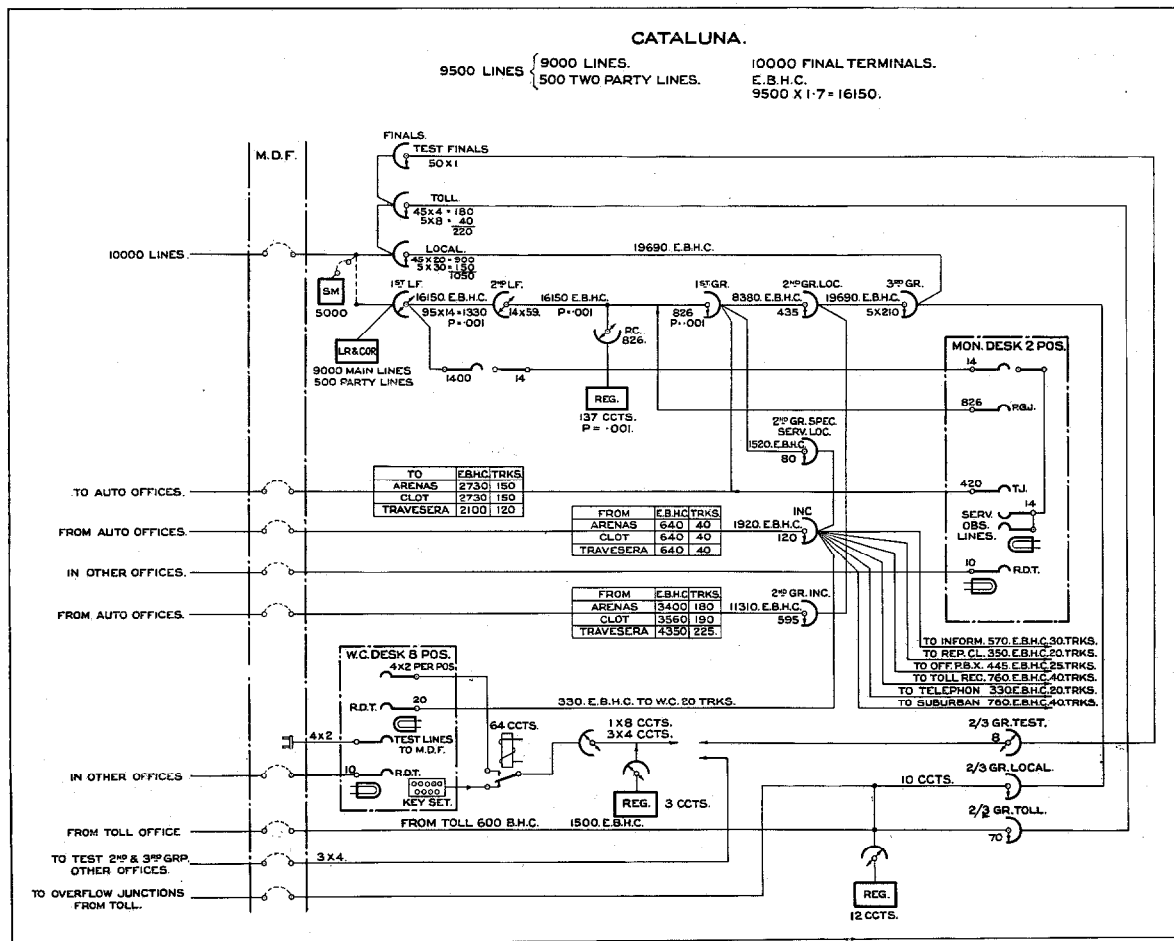

Figure 4—Junction Diagram for Cataluna Exchange.

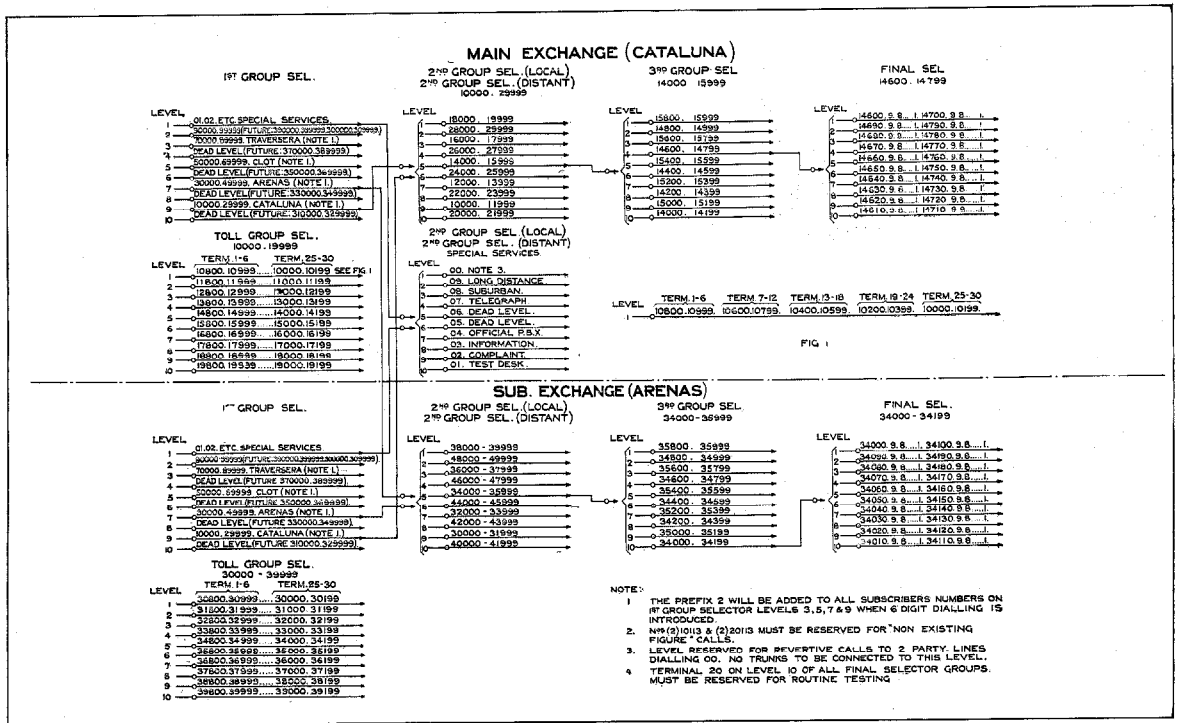

Figure 5-7-A Machine Switching System. Level Numbering Diagram.

this board, so that outside men engaged in making subscribers' installations, or in clearing faults, may call in for test and to receive new instructions. On this floor is also located the 6-position "Repair Clerk" desk, illustrated in Fig. 6, on which the trunks from the 02 code are terminated. The operators at these positions record complaints from subscribers, and the tickets which they make out are passed to the Test Board so that the lines reported in trouble may be tested and cleared without delay. The layout of the power room and battery room are shown in detail in Fig. 7.

On the fourth floor, Fig. 8, the greater part of the automatic equipment is located. The layout calls for very little comment since it follows standard practice. Rows 1-6 and 17-22 accommodate the connection circuits and register choosers; rows 15, 16, 31 and 32 are reserved for registers. Parts of rows 31 and 32 are used for 2nd group local selectors and miscellaneous interrupters, etc. On rows 33 and 34 the 15 groups of second line finders are mounted. Rows 35 and 36 accommodate the main fuse panel,

lamp panel and the monitoring desks. Finally, rows 23-30 accommodate the 3rd and 2nd group local selectors.

The fifth floor is laid out for an additional capacity of 10,000 lines, of which equipment for the 6,000 lines, previously mentioned, was placed in service during April, 1929.

On the sixth floor is located the machine switching equipment for inter-office trunks, toll switching trunks, and the special services. The latter include the 01 and 02 codes mentioned above, and the 03, 04, 07, 08 and 09 codes which are described in detail further on. This floor also contains the toll distributing frame, relay racks in connection with the toll switchboard, cord circuit repeater equipment, terminal equipment for physical, phantom, and carrier telephone circuits entering the office, and a No. 2005 toll test board of six positions. In a separate room on this floor there is a two-position toll service observing board which contains a complete appearance of all multiple on the toll switchboard as well as monitoring taps to all positions, thus permitting detailed and efficient inspection and check of the service.

The entire seventh floor is occupied by the toll operating room, described in detail below, while the eighth floor contains the Telefonema operating room, and the operators' quarters, which include a locker-room, restroom, dining-room and kitchen, and a small infirmary. The Telefonema board consists of 16 positions mounted in two groups of 8 positions each. Each position has a typewriter well. Two adjacent positions constitute a section and each section is provided with a turret containing equipment for key-ended trunks. Incoming trunks from the 07 level are multiplied on these turrets, so that subscribers may file messages by telephone. Outgoing trunks to the 7-A Rotary plant are provided so that incoming messages for subscribers may be delivered to them by telephone, and two-way trunks to the toll switchboard permit the establishment of direct connections to distant offices for the work of transmitting and receiving messages. The pneumatic carrier from the ground floor terminates in the Telefonema operating room, so that messages filed at the counter are transmitted without delay, and incoming messages are immediately despatched by messenger in all cases when they cannot be delivered by telephone.

Special Services

All special service positions are centralised in the Cataluna office. Sixteen positions are provided for centralised information service; the

first six of these positions are equipped also for the reception of calls directed to dead levels, dead lines and changed numbers. Calls in any one of these categories are directed to arcs of line finders in each of the offices, and are thence extended to key answering equipment located on the first six positions of the information desk. One dead level call finder is furnished for each office; for dead lines, four finders are provided in Cataluna and two in each of the two other offices, and similar provision is made for changed numbers.

The information operator is reached by dialling 03, and the call is routed over the first level of the first group selector and the eighth level of the second group selectors provided for special services. Automatic distribution of calls to these positions forms a feature of the equipment. The information trunks from the second group selector levels are terminated on the brushes of finder type switches, which are used as position finders. When a trunk is picked up, its associated finder hunts for a free position among the sixteen information positions, and the subscriber is thus connected directly to the operator's head-set.

Ten positions were provided initially for toll recording, the distribution of calls to these positions being similar to the arrangement described above for the information board. This separate recording board was provided because when the installation was planned it was expected that some time would elapse before toll circuit facili-



Figure 6—The Repair Clerk's Desk.

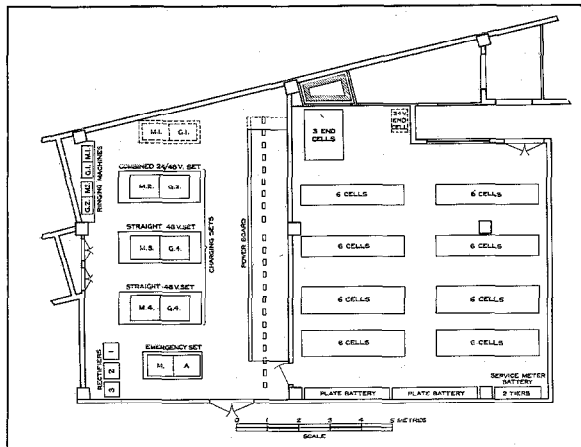

Figure 7—Floor Plan of Battery and Machine Rooms for Cataluna.

ties and the efficiency of the operating force would permit of the introduction of the combined line and recording (C.L.R.) method of operation. The front equipment of the toll switchboard was, however, arranged in such a way that a recording trunk multiple could easily be added, and it is planned to introduce this modification in the near future with a view to establishing C.L.R. operation and eliminating the present recording board.

Miscellaneous Services

Service observations, monitoring and daily tests on junctions are carried out in the switch-room itself. The necessary equipment is mounted on the bay type units illustrated in Fig. 9. The position on the left is for service observations of subscribers' lines. Here also the quality of the service is checked by means of observation circuits, which can be associated in turn with all the groups of first line finders. By means of these line finder observation circuits, the call can be timed from start to finish, and the number of effective, busy, no-reply calls, etc., can be determined. In addition, the actual impulses sent in by the subscriber can be recorded on a tape, thus fixing the responsibility for wrong number calls. The tape recorder can be seen mounted in the first panel. Traffic-overflows are also recorded at this position.

The middle position is furnished with lamp equipment, which indicates false calls or permanent glows. If a subscriber's line is looped and no dial impulses are received within a predeter-

mined time, the register circuit is released, and the cord circuit sequence switch is rotated to the permanent glow position, and a lamp is lit on this position. The operator then endeavours to gain the attention of the subscriber. Preliminary tests by means of a voltmeter can also be carried out. If the operator cannot obtain any answer, the line is turned over to the wire chief, who applies the howler, and if this is unsuccessful the line is plugged out.

The right-hand position is arranged for testing the out trunks to the distant automatic offices. Each trunk is furnished with a test jack and busy key. A simple voltmeter circuit permits rapid routine tests to be made. These are usually carried out early in the morning. Defective trunks are put out of service by means of an associated make-busy key.

Wire Chief's Desk

The general appearance of the wire chief's desk, known as the 2012 type, is illustrated in Fig. 10. The initial installation in the Cataluna office comprised eight positions. It is a single position section with the equipment suitable for centralised and non-centralised testing. It is equipped with a volt milliammeter for testing

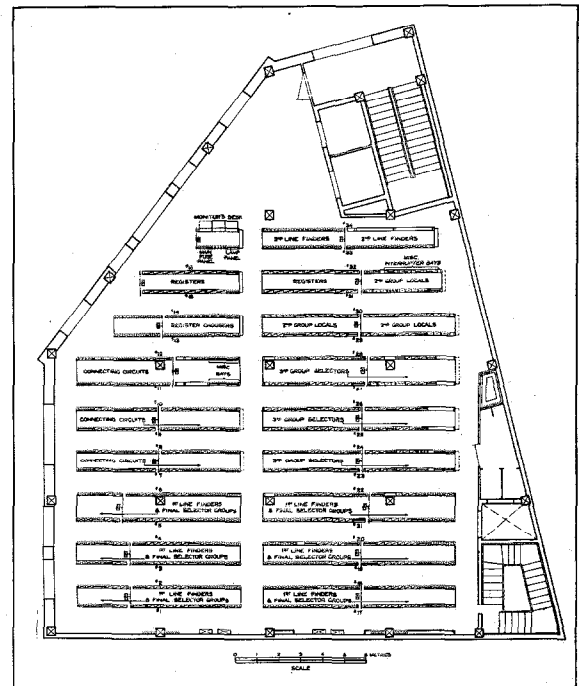

Figure 8—Layout of Automatic Equipment, Fourth Floor.

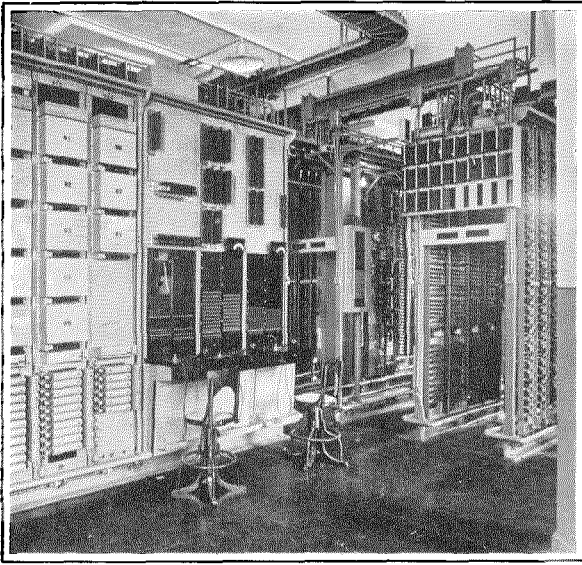

Figure 9—Local Service Observing and Monitoring Positions, Cataluna.

with 100 volts, and is also arranged for 48-volt operation. It contains the following equipment: test lines to main frame, lines to main frame for picking up spare cable pairs, plugging up circuits for subscriber lines, test circuit with operator's head-set, outgoing trunks to automatic, ringdown trunks to other desks, connecting cord circuit, incoming trunks from automatic exchange. When required, a loudspeaker circuit to the main frame, and also a Wheatstone bridge, can be accommodated.

The loud speaking telephone system has been developed to meet a case where the conditions in the terminal rooms are such as to make it impracticable to communicate with the attendants at the main frame by means of the human voice unaided. For rapid testing, the wire chief should be able to communicate with the main frame attendant at any time, regardless of the latter's position and without the necessity of having to wait for this attendant to answer before giving him the necessary instructions. This facility is obtained by means of loudspeakers located at intervals along the main frame. Conversely, the attendant at the main frame should be able to get into communication with the wire chief from any position at the frame. This is secured by the transmitters associated with loud-speaker equipment, which give direct access to the wire chief's receiver. The equipment is

brought into operation by the depression of a key on the wire chief's desk. The circuit operates both ways, the attendant at the frame obtaining communication with the wire chief's desk by depressing a push button which causes a signal to be displayed at the desk. Three pairs of wires are required for each group of loudspeakers and transmitters, one pair for signalling and two pairs for receiving and transmitting.

The volt milliammeter mentioned above has a range from 0-120 volts with 100,000 ohms resistance, 0-24 volts with 20,000 ohms and 1,000 ohms. It can be used for measuring currents up to 0.048 amperes. The testing pressure applied is 80 volts or 20 volts. The first three scales are arranged to read in volts, whilst the fourth is marked in milliamperes.

The test-desk also permits transmission tests to be made with an artificial line in circuit. This artificial line increases the transmission equivalent to about 30 miles of standard cable (27.7 TU). A rheostat is provided, which allows the wire chief to regulate the current over the subscriber loop to a definite and predetermined value corresponding to, say, 500 ohms.

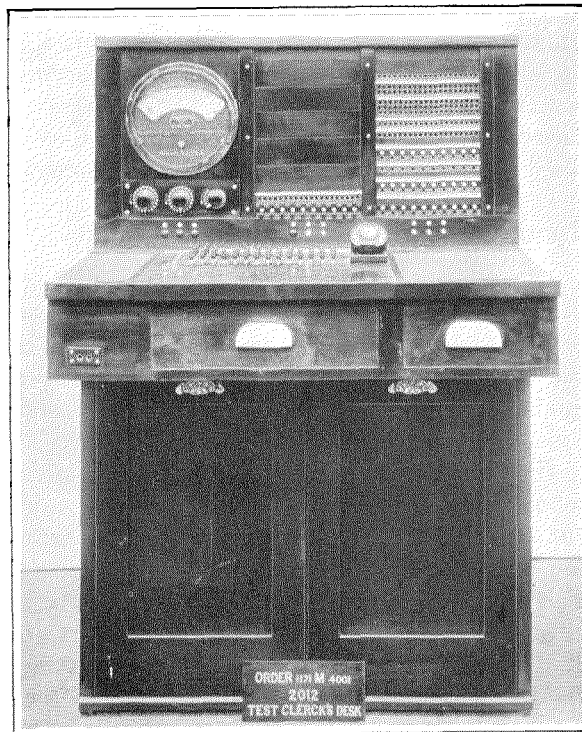

Figure 10—Wire Chief's Desk.

The selection of lines in all offices is effected by means of a 10-button key-set associated with the trunks. Each position is provided with two individual trunks for each of the four offices in the area, which trunks terminate on the arcs of trunk finders for each direction. These trunk finders and their associated combined 2nd and 3rd selectors are known as link circuits. The trunk finders are located in Cataluna, but the selectors are located in their respective offices. Three register circuits are provided and connected temporarily to the link circuits over link finders, which are individual to each register. The trunks from the selector arcs terminate in test finals, one such final being provided for each group of 200 subscriber terminals. The switching scheme is shown in Fig. 4, and the numbering of the combined selectors, which give access to 10,000 numbers, in Fig. 5. Calls incoming to the centralised desk of the wire chief are routed over first group selectors and the second group selectors provided for special services. For emergency testing only, a one position wire chief's desk is provided in the Clot, Travesera and Arenas offices. This emergency equipment makes use of the same switching equipment used for centralised testing. The trunks from the centralised desk pass through the emergency desk, busy lamps safeguarding the circuits from interference. The emergency wire chiefs in the distant offices are reached over ringdown trunks from the centralised equipment.

Routine Testing of First Line Finders

The scheme of routine testing furnished at Barcelona has proved its value. By means of this equipment complete and repeated tests of the regular equipment can be made with a minimum of delay and without loss of time, thus ensuring a high grade service. The routine testing of the first line finder circuits is designed to prove that the switch under test will start out in search of a calling line and will stop on the desired set of arc terminals. Another condition that must also be satisfied is the correctness of the test relay adjustment. The object of this relay is to guard against the simultaneous connection of two line finders to one and the same line, consequent on simultaneous testing of that line by two switches. Test equip-

ment is mounted on each line finder bay. It comprises a 2-position push button type of key, together with a jack, lamp and relays, which are common per bay. The keys, jack and lamp are located on a panel above the line finders. Two sets of the 102 groups of terminals on the arc are set apart for routine testing purposes. A short-circuit plug is placed in the test jack, the common busy key is depressed and the condition of the switch whether free or busy is determined by the busy lamp. If the switch is free, the test key is pushed into position 1. If everything is in order, all the free line finders will rotate until the one under test comes to rest on the test terminals; the common test pilot lamp will then glow. The relative positions of the brushes and terminals can then be verified, thus checking the mechanical correctness of the switch. To check the test relay adjustment, the routine test key is momentarily pushed further forward to its second position; the line finder should then move away from the test terminals and come to rest on the second group of test terminals, the routine test key meanwhile having been returned to position 1.

Routine Testing of Connection Circuits

This routine test circuit checks the operation of the second line finder, the register chooser and the first group selector, referred to collectively as the connection or cord circuit. The complete test is carried out in four cycles. The first cycle checks the performance of a circuit on a normal call. The second cycle omits some of the tests of the first cycle and in place thereof introduces an opposite limit test for the operation of the trip spindle of the first group selector, and also reproduces a condition corresponding to that brought about if a subscriber abandons the call when the circuit is in the ringing position. Such calls are not to be metered, and the circuit is checked for this property. The third cycle verifies the correct operation of the circuit for the condition when a call is abandoned before the full selection has been effected. Finally, the fourth cycle proves the operation of the circuit on permanent glows (false calls). Under this condition, the requirements call for the release of the register and the advance of the connection circuit to a predetermined

position, where the lamp signal is displayed.

All four cycles are carried out automatically in succession without the intervention of an attendant. If an abridged test only is required, the last three cycles may be omitted. In addition, the circuit is so arranged that any connection circuit may be subjected to repeated tests of one or four cycles, repeated automatically as many times as required, without any action on the part of the attendant. This is of considerable value when checking the correct operation of readjusted circuits.

The routine test circuit also effects further economy of time in that it is arranged to step automatically from one connection circuit to the next free connection circuit in a group of 45 circuits. This is accomplished by the use of a 9-brush line finder, the arcs of which are connected to the 45 connection circuits in the group, and the brushes of which are associated with the routine test equipment.

Two routine test circuits are furnished and are so arranged as to allow both to be used simultaneously to test different groups of circuits. Should either circuit become faulty, the other circuit can be switched over to test the circuits normally tested by the routine test circuit out of order.

Faults are indicated by the stopping of the routine test circuit and an associated alarm, which operates after an interval of time. The correct completion of a cycle or cycles is indicated by a lamp signal.

One set of terminals, the test terminals, on the second line finders, are driven to and stopped on these terminals when a particular switch is being subjected to a routine test. For the register choosers, two sets of terminals on the arc are reserved for routine test purposes.

The routine test equipment consists of five keys, two sequence switches, one line finder and onetime alarm, together with the necessary relays. This equipment comprises the routine test circuit proper. The connection circuit itself is also provided with a routine test jack. If it is necessary to test a particular circuit, a wooden peg is inserted into the routine test jack of that circuit. The routine test circuit will now be directed to this particular circuit, after which a full or partial test can be applied.

Routine Testing of Registers

The routine testing of registers is effected by the aid of three sequence switches and a group of relays, controlled by a number of master keys. The test consists in sending in impulses for nine different number combinations. Of these nine, seven are five-digit numbers, one represents a partially dialled number as in a premature release, and the remaining one corresponds to a special call. The actual sending in of the impulses is effected by means of a sequence switch, which is so designed as to give impulses corresponding to either a fast dial running at 14 impulses per second, or to a slow dial giving 8 impulses per second. This sequence switch makes a complete rotation for every digit sent in or taken out. In order to reproduce the worst conditions likely to be met with in practice, line resistance of 0 and 1,000 ohms are used with both the fast and the slow dials. In addition, when working with a "O" ohm line (zero loop), a leakage of 20,000 ohms is introduced. In a like manner, when taking out impulses from the register, the limiting conditions for the trip spindle short-circuiting contact are reproduced. This is also done by means of the sequence switch, and conditions corresponding to a maximum short-circuit impulse and to a minimum short-circuit impulse are reproduced. When working with minimum resistance a leak of 20,000 ohms is introduced in order to make the test more stringent. A trunk resistance of 900 ohms is taken throughout the tests.

The second sequence switch is a controlling sequence switch, which makes the necessary circuit combinations for testing the register in all its functions. This switch makes one revolution for every cycle. The third sequence switch provides the necessary number combinations corresponding to the nine cycles, and introduces the limiting line and trunk resistance, leakage, etc. This sequence switch makes one step after every cycle. By the term "cycle" is meant the tests made to check the correct operation of the register for each number combination.

The register is tested for the proper adjustment of the apparatus and for correct wiring. The first test checks the test potential furnished by a free register; if this is available, the register is taken into use and a particular combination

of digits is then sent in on the instepping circuit under conditions more severe than those met with in practice. The complementary impulses corresponding to the first digit are then taken out from the register under conditions corresponding to those normally presented by the first group selector. If this test is satisfactory, the impulses corresponding to the second digit are taken out and checked. In a similar manner, the impulses corresponding to the remaining digits are checked, after which the register is released. In addition to the above test, the register is checked to see that the proper conditions are available during the time when it waits for a free trunk to be picked up at any one of the group selectors.

The complete test of a register consists of the nine number combinations referred to previously, and is carried out automatically from start to finish without stop, provided that there is no fault in the circuit. The necessary operation for the maintenance man is simple and consists merely in throwing a routine test key, which connects one of the two routine test circuits and a start key, which starts off the test.

In addition to the above facilities, arrangements can be made to connect a particular register to the routine test circuit and to test it for all combinations or for an abridged test of seven cycles. These tests can be made once or repeated automatically for as long as may be thought advisable. To do this, the routine test key is thrown, thus connecting up one or other of the routine test circuits, after which a plug is inserted in the routine test jack of the register circuit under test, and finally the bay master key and one of the control keys are thrown. The register is now subjected to a test for all cycles, and on the completion of the test, a lamp lights, if everything is in order. If, on the other hand, it is necessary to have a repeated test of all cycles, the control key is left normal. Finally, if it is only necessary to repeat one cycle, a different control key is thrown in addition to the bay master key.

A very valuable feature of this routine testing arrangement consists in the means provided for automatically testing all free register circuits for the complete test of all cycles. This is done as follows: One of the routine test circuits is

connected up by means of the routine test key. The first free register is then taken up by the routine test finder and is completely tested for all cycles, after which it is released, and the routine test finder hunts for the next free register, which is then subjected to the test. This procedure continues until all of the free registers have been subjected to test.

Routine Test of Group Selectors

The testing of all free selector circuits can be accomplished automatically. A selector circuit can either be tested for two cycles, or an abridged test can be applied to it for one cycle only; or again, repeated tests of both cycles or of one cycle can be carried out. The testing circuit checks the sequence switch contacts and the relays for continuity and for the absence of foreign potentials in the subsequent stage of selection. It also checks the test relay in the selector for correct operation on a double test; further, it checks the trip spindle and the rotation of the brush carriage, and it verifies the fundamental circuit.

For the routine testing of particular group selectors, a jack is furnished in the group selector circuit. The first line on the tenth level is used for routine testing and the insertion of a peg in the routine test jack causes the third wire to be disconnected from the arc multiple on the group selectors and connected to the routine test. The routine test circuit is now directed to this particular circuit, which can then be tested completely or partially.

Routine Testing of Finals

In like manner, a routine test circuit is provided for checking the final selectors. In this case, line No. 20 on the tenth level is used for routine test purposes and is connected directly to the routine test circuit. The complete test itself consists of two cycles, but an abridged test of one cycle only can be applied. The complete test during the first cycle checks the third wire; the trip spindle impulses, the brush carriage impulses, verifies the intermediate ringing and the interrupted ringing, and tests the continuity of the talking circuit. The second cycle introduces tests for the busy condition and a number



Figure 11—New Toll Switchboards, Barcelona.

of other subsidiary tests, such as P.B.X. hunting, correct operation when the last line of P.B.X. groups is busy.

It is not possible in the limited space available to enter into complete details regarding the conditions imposed by these routine test circuits, or to indicate satisfactorily the very numerous tests for apparatus and wiring applied to the circuit by means of the routine test equipment. Practice has shown that such circuits are a very valuable feature of the rotary equipment. The simplicity of their operation insures their use by unskilled labour and so places a very useful and economical tool in the hands of the maintenance engineer. If the programme of routine testing is drawn up in a manner that insures that the circuits are not abused, exceptionally high grade service at economical cost can be guaranteed.

The rotary equipment was in use for a number of years before these routine test circuits were designed, and records from the old exchanges show that a very high grade of service has been given to the subscribers. Some of the testing had, however, to be carried on outside the regu-

lar hours. The purpose of introducing a system of automatic routine testing was to furnish more economical means for the maintenance staff to check the equipment, and in addition to allow complete testing to be done during the regular hours.

By means of these routine test circuits, the equipment can be more frequently checked than was possible with the individual tests formerly applied. As a consequence, the possibility of reaction on the service of faulty equipment has been greatly reduced, because such faulty equipment only remains undetected for a short period.

Toll Equipment

The toll requirements which led to the design of the toll board, together with its salient features, have already been described³ by Mr. J. Davidson. These features are embodied in the No. 2003 toll board. The primary purpose of the design, namely reduction of equipment, im-

³*Bell System Technical Journal*, January, 1927, and *Electrical Communication*, April, 1927, p. 255.

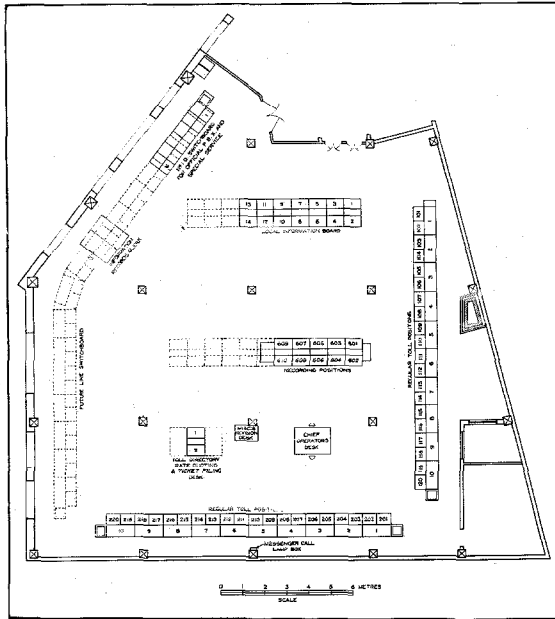

Figure 12—Seventh Floor Plant Equipment.

proved maintenance and great flexibility, was achieved by locating the supervisory apparatus in the toll line circuits, and the controlling equipment in the positional circuit, instead of locating both in the cord circuits as is done in the No. 1 toll circuits. It became necessary, therefore, to give the toll line relay a dual function. This relay in the first instance responds to a ringing call signal and causes the answering lamp to be displayed. After the call is answered, this relay acts as a supervisory relay and controls the cord supervisory lamp over the sleeve conductor.

The toll line relay, which responds to the frequency of the ringing current applied at the distant end, is cross connected into the line circuit so that it is possible to interchange it easily, in case the calling frequency is changed.

The toll line circuits are also arranged in such a way that it is possible to ring over them with different frequencies; this may be done with the same cord circuit ringing key. For this purpose the ringing key controls a ringing relay in the toll line circuit. By applying direct current to the tip conductor of the plug, this relay, when operated, applies current of the required periodicity to the line.

This arrangement does away with the need

for changing frequencies and gives rise to appreciable economy as the amount of composite working increases.

Another important feature of the No. 2003 toll board is the simplicity of the cord circuit. There are only two double-throw keys (ringing, listening and monitoring) and one relay required for every cord—in addition, of course, to the two plugs and cords and the two supervisory lamps. All other equipment is common to the position. This arrangement keeps the keyshelf free for writing and makes it possible to employ new operating methods with only slight changes to the equipment.

The toll equipment at Barcelona (Fig. 11) is designed to handle inward, outward, through and suburban calls. Cord circuit repeaters are provided for long distance through connections. The ultimate equipment will consist of five rows of regular toll positions of 10, 10, 16, 8 and 8 two position sections. These five rows of boards are designated 100, 200, 300, 400 and 500, respectively. This equipment, together with ten double-sided local information desks, chief operator's desk, ticket filing desk, etc., will all

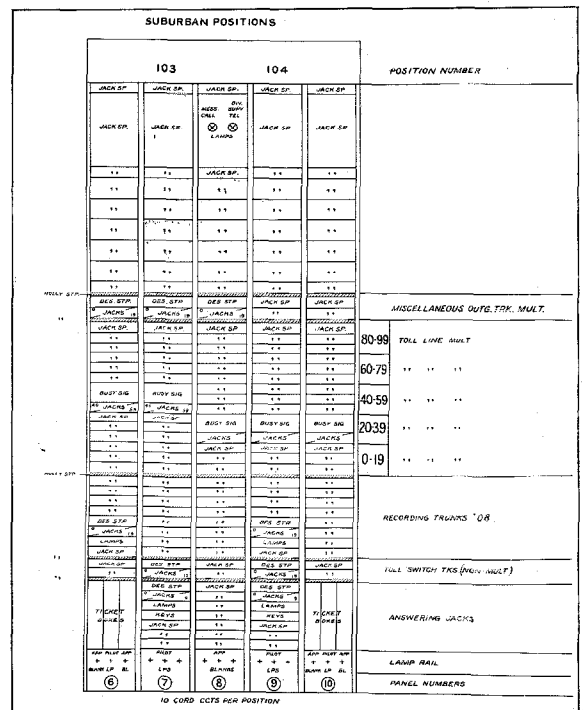

Figure 13—Typical Face Equipment, Suburban.

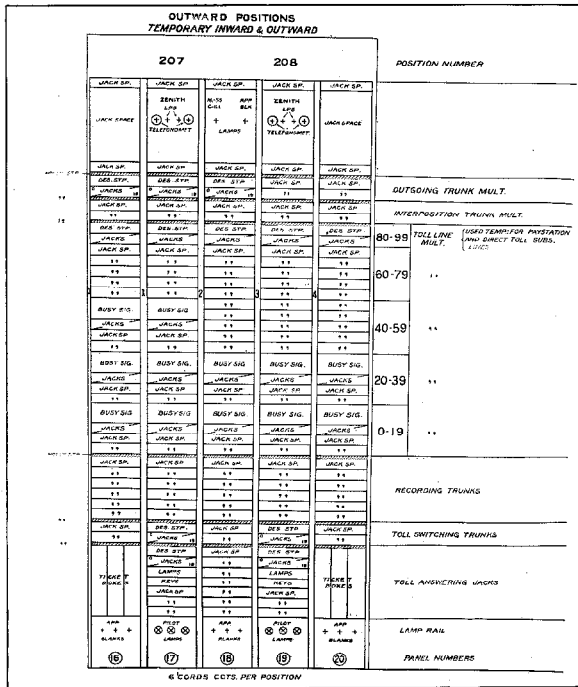

Figure 14—Typical Face Equipment, Outward.

ording trunk multiple will be extended throughout these 12 positions, which will then become C.L.R. positions. A typical face equipment of a suburban section is shown in Fig. 13 and of an outward section in Fig. 14. It will be noticed that the principal difference between these two lies in the fact that the latter section is equipped with the full toll line multiple, whereas the former only furnishes access to 100 toll lines.

The "200" line of boards (consisting of 20 positions) also grows from left to right. The first twelve positions of this line are equipped and used in the same way as the last twelve positions of the "100" line. They will later become C.L.R. positions. The next four positions are arranged for inward operation (Fig. 15), with 14 cord circuits each. The last four positions provide for combined inward and repeater operation and are equipped with 8 regular cord circuits apiece, with two twin plug repeater cord circuits in the two middle positions and one in the left-hand position. A typical face equipment of the night concentration and repeater position is shown in Fig. 16.

The method of handling calls in these three categories is briefly as follows:

be located on the seventh floor of the building, arranged as on the floor plan (Fig. 12).

For the present, 40 positions for the "100" and "200" lines of boards, 10 positions of recording board, and 16 positions of local information desk are installed—together with the necessary desks—and 6 positions of No. 2001-D switchboard for pay stations and for the official P.B.X. The "100" and "200" lines of board have a capacity for 500 toll line multiple with a present equipment of 240.

In general, outward positions handle the toll calls originating in the area served by the toll office. Inward positions complete calls from distant offices to subscribers in the terminating toll office, as well as the through toll calls. The suburban positions provide for the originating suburban traffic (positions 101 to 108).

The "100" line of boards composed of 20 positions grows from left to right. The 8 positions arranged for outward suburban service are equipped with 10 cord circuits per position. The remaining 12 positions give outward toll service and are furnished with 6 cord circuits per position. Delayed inward toll traffic is also handled at these positions. When the combined line and recording method is introduced, the toll re-

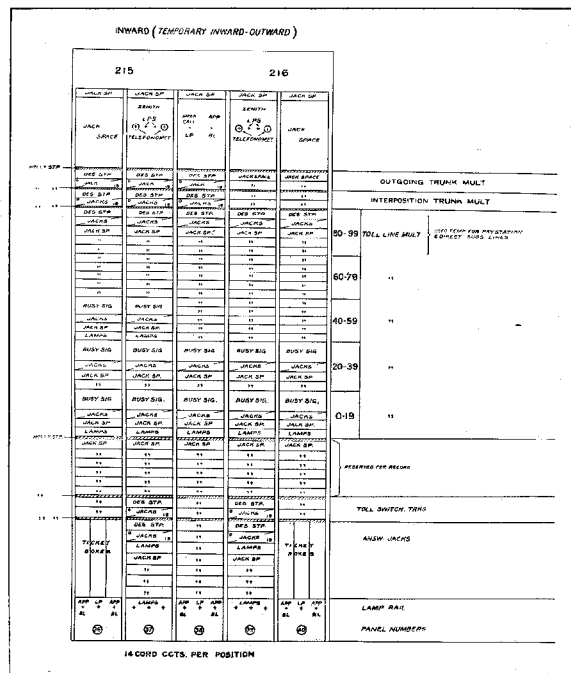

Figure 15—Typical Face Equipment, Inward.

Outward. A Barcelona subscriber requiring a toll connection dials the digits "09" and is directed to a free recording position where particulars of the call are taken. The subscriber is told that he will be called later and is instructed to hang up his receiver. The ticket is then placed on the belt conveyor, collected by messengers and taken to the Directory desk (if necessary), and ultimately to an outward line operator. This operator obtains the calling line over a toll switching trunk and then completes the toll line connection.

Inward. Toll calls incoming for subscribers in the Barcelona network are answered at the inward positions in the toll line multiple—which is provided with lamps in these sections—and are completed over toll switching trunks. In case the called subscriber's line is busy or does not answer, the inward operator gives the corresponding report to the distant exchange, and another attempt is made a few minutes later. If it is still impossible to complete the call on the second attempt, it is transferred by the inward operator to a delayed position, and a report ticket is made out. The delayed operator is then responsible for obtaining the wanted line and for calling back the distant exchange.

Transit Calls. In general, these calls are completed by the inward operator directly in the toll line multiple. In the case of a through call from a small tributary office to a point involving the use of a long-haul toll circuit, the call is transferred by the inward operator to the delayed operator, who makes out a ticket, obtains the wanted number at the distant exchange, and calls back the tributary office. A similar procedure is followed during hours of heavy traffic for transit calls to heavily loaded circuit groups.

The transfers mentioned above are effected by the inward operator by means of a positional transfer key which causes the lamp to light at the answering jack on the outward position to which the particular line is assigned for delayed traffic.

Suburban service. A Barcelona subscriber requiring a suburban or short-haul connection dials the digits "08" and the call is automatically directed to the suburban toll positions where it is displayed in a recording trunk multiple.

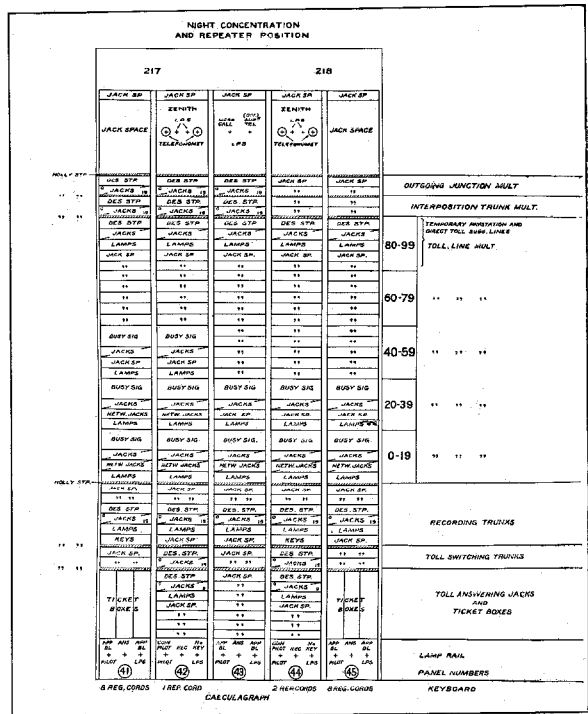

Figure 16—Typical Face Equipment, Night Concentration

A free operator answers the call, records the necessary particulars on a ticket and advises the subscriber to wait on the line. She then inserts the calling plug of the cord circuit selected into a toll line to the distant point, and completes the connection with the help of the distant operator. Switchhook supervision is provided, that is to say, the subscriber is able to flash the operator by moving his switchhook up and down. In other words, the outward suburban or short-haul toll traffic is handled on the so-called non-hang-up or rapid toll basis, with ringdown signalling.

The inward suburban or short-haul traffic is handled over the same (two-way) suburban trunks. These trunks are arranged in such a way that the suburban operator may dial directly any Barcelona automatic subscriber. This means that the inward suburban service is handled on the non-hang-up (or rapid toll) basis, with direct toll dialling.

A two-position toll service observation board is furnished. The observation circuit is equipped with monitoring amplifiers and is arranged to observe any calls handled on the toll switchboard.

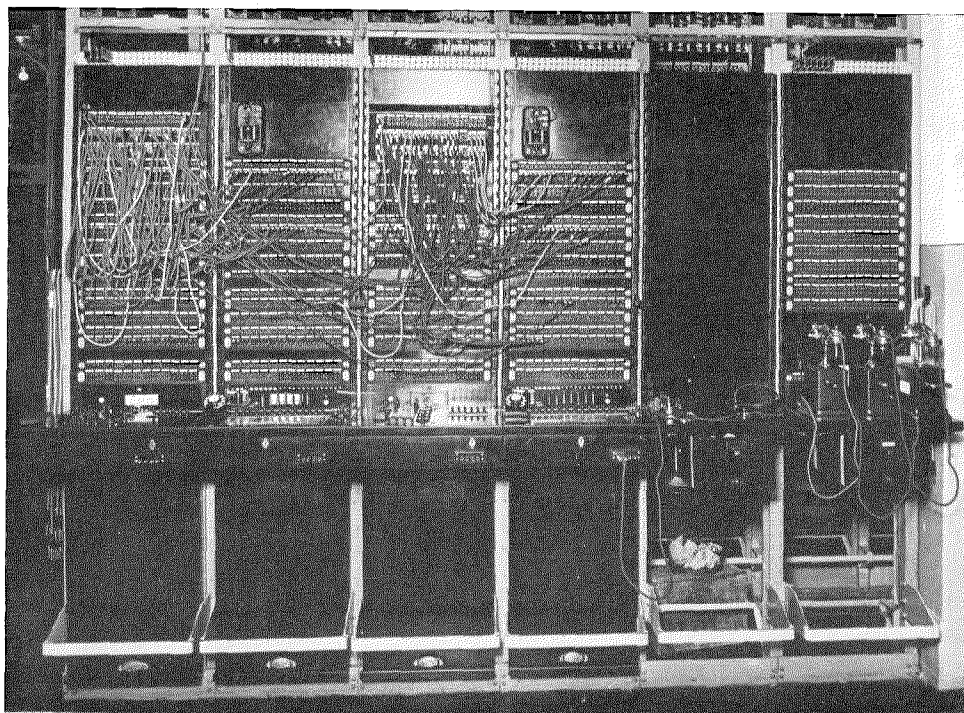

Figure 17—Toll Test Board.

Portable test sets provide means for testing and readjusting the signalling equipment, the toll line circuits, cord circuits, positional circuits and the high speed keysets. The cord circuit test furnishes means for indicating unbalance limits and noisy cords.

Introduction of C.L.R. Service. As already stated, it is intended to introduce the C.L.R. method of operation in Barcelona. This will in no way affect the existing methods of operation on inward and transit calls. It will modify the operation on outward calls only to the extent that the same operator, instead of two operators, will record a call and complete it to the distant exchange. The only equipment modification will consist in extending the toll recording trunk multiple throughout the outward positions, and in removing the existing separate recording board. At the same time sufficient additional outward positions will be installed to provide for expected growth in the toll traffic.

Toll Test Board

The test desk, described above, is used solely for the local service. The testing of toll lines is carried out at the No. 2005 toll test board. This toll test board consists of a number of bays each composed of an upper unit and a lower unit. The upper unit comprises a skeleton frame on which are mounted jacks cabled to terminal strips located above the unit. This skeleton frame is then attached to a standard relay rack drilled for $1\frac{3}{4}$ " mounting plates.

The lower unit contains the testing equipment and is designed in the form of a desk. The two units are completely wired and tested in the factory, after which they are shipped separately.

Cables are provided between the terminal strips at the top of the bays and the toll distributing frame. The various line equipments, such as repeating coils, toll line relay and ringing

circuits, as well as the toll lines and switchboard line circuits, are also cabled to the toll distributing frame and are cross connected to the various testboard jack circuits as required.

Lower units can be arranged for voltmeter testing, Wheatstone bridge testing, and telegraph testing. If the lower unit is not equipped, its place is taken by a writing shelf.

Since the secret of good maintenance is to detect and remedy trouble before it becomes serious enough to affect the service, it is essential that means should be provided to allow quick and frequent testing of the toll circuits and associated equipment. Speed and ease in testing are prominent features of the No. 2005 toll testboard, inasmuch as a 6-, 10- or 14-jack circuit is provided for each toll line, at which point the line, switchboard, or associated line equipment can be picked up and tested by merely inserting a testing plug into the jack associated with the circuit to be tested.

The voltmeter unit permits tests for the following: continuity, earths, approximate measurements of resistance, tests for insulation and leakage, crosses, foreign and earth potentials. Signalling currents of 20, 135 or 1,000 cycles, an interrupted trouble tone, a talking circuit to attendants at distant stations or to trouble men, and battery supply for trouble men furnished with CB handsets are provided. By means of the connecting cords, two trunks may be connected together, or a trunk may be connected to a toll line.

The Wheatstone bridge unit permits the measurement of loop, single wire or insulation resistance to be carried out. In addition, the Varley and Murray loop tests can be made, together with the open location test.

It will be seen from the above that this toll test board is a very valuable aid to the maintenance staff.

In the Barcelona office, six units of the No. 2005 toll test board are installed, consisting of two voltmeter units, two Wheatstone bridge units, and two units furnished with writing shelves. This board is illustrated in Fig. 17. The patching cords were used prior to the cut-over for patching the cables through to the old toll office, a feature which is more fully dealt with hereinafter. The equipment consists of:

- 96—10 jack toll line circuits, wired for 14 jacks per line.
- 48—10 jack phantom toll line circuits.
- 48— 6 jack toll line circuits.
- 12— interposition trunk circuits.
- 10— Local trunks.
- 2— Test line to toll distributing frame.
- 12—12 jack network circuits.
- 60— 8 jack network circuits.

The toll test board was cut into service ahead of the toll board and played a very useful and important part during the cutting into service of the new toll equipment. The means by which this cut was effected proves the value of this toll test board in securing a smooth cut-over with the minimum of annoyance to the subscriber.

The old toll office at Barcelona was located in another building situated some distance from the new office. The toll cables to the old office were intercepted at a convenient place and spliced to two cables which were terminated on the distributing frame of the new office. The old-office end of the cable was cross-connected to temporary jacks located over the line jack field in the toll test board. The line end of the cable was cross-connected to its permanent position in the test board and, through repeating coils, toll line relay and ringing circuits, to the new toll switchboard.

The circuit was then patched from the drop or switchboard side of the repeating coil to the old office. In order to test each line straight through to its permanent position in the new office, it was only necessary to remove the patching cord (see Fig. 17). As this was done during light-load hours, it was possible to make a complete test of all terminal equipment and cross connections prior to the actual cut-over.

The actual cut-over consisted merely in removing the patching cords. The circuits were brought into service at midnight and the smoothness of the cut was perfect. Subscribers who applied for toll connections after 11.50 p.m. were asked to apply again after midnight; calls in progress were broken into and subscribers advised that the connection would be temporarily broken at midnight. Those who asked for the connection to be restored after midnight were recorded, and the particulars were passed over order wires to the new toll board.

Power Plant

The power plant consists of the following:

- (a) 2-33 KW. 46/70 Volt, 550/440 Amperes, 970 RPM motor generator charging sets.
- (b) 1-33 KW. combined 22/35 and 46/70 Volt, 550/440 Amperes, 970 RPM motor generator set.
- (c) 3-Mercury arc rectifiers 22/70 Volt, 50 Amperes.
- (d) 1-Tungar rectifier, 75 Volts, 12 Amperes.
- (e) 2-12 cell batteries, 1A, 1B, with tank capacity for 5036 Ampere hours at $7\frac{1}{2}$ hours discharge rate and plates for 3445 Ampere hours.
- (f) 2-12 cell batteries, 2A, 2B, with tank capacity for 3710 Ampere hours at $7\frac{1}{2}$ hours discharge rate and plates for 2904 Ampere hours.
- (g) 3-Emergency cells with tank capacity for 7421 Ampere hours and plates for 5301 Ampere hours.
- (h) 4-15 cell batteries of 12 Ampere hours at 8 hour rate.
- (i) 4-33 cell batteries of 24 Ampere hours at 8 hour rate.

The motor generator sets (a) are provided with hyper-compound generators.

The combined machine (b) is hyper-compound for 48 volts output, but is only shunt wound for 24-volt-service.

The two 12 cell batteries (e) are operated in parallel and furnish the reserve required for the 24-volt toll and repeater equipment and for the 48-volt automatic.

The two 12 cell batteries (f) are connected in parallel and in conjunction with the 1A and 1B batteries (e), furnish the reserve for the 48-volt automatic equipment.

The three emergency cells each have a capacity equal to the combined capacity of the 2A and 2B cells. These emergency cells are required when the office load is taken by the battery in the event of a failure of the service mains.

The mercury arc rectifiers (c) are used for carrying the office load during night and hours of light traffic.

The 4-15 cell battery (h) is used for supplying the booster potential required for metering purposes and also serves the keysets on the toll board. These four groups of cells are connected in series parallel to furnish 60 and 90 volts. They are charged in groups by means of the 48-volt battery.

Finally, the 130-volt battery (i) is used for supplying the plate potential for the repeater

equipment. These batteries are worked on a charge-discharge basis and are charged by means of the Tungar rectifier (d). The cells are arranged for charging in two groups of 33 cells in parallel and for discharging in two groups of 33 cells in series.

The full float method of operation is provided. Under this scheme, the office load is taken by the charging generators or rectifiers with the batteries floating across the terminals of the generating units. The battery is fully charged and remains in this condition unless there is a failure in the service mains, when the battery takes the office load. The regulation of the generator voltage is effected by means of a series field, which is excited by the office load, determined by the potential difference across a shunt placed in the discharge circuit. A great deal of care has been exercised in the design and manufacture of these hyper-compound generators, and the voltage fluctuation across the equipment busbars from no load to full load is kept within the specified limits.

The splitting of the batteries into two groups, each of which has half the total capacity, reduces the size of tanks to reasonable proportions and has the advantage of great flexibility. Both halves of the battery can be removed in turn from the circuit and receive an overcharge periodically. It has been found from practical experience extending over a number of years, that this full float method of operation prolongs the life of the cells.

The layout of the power plant at Cataluna is shown in Fig. 7. A photograph of the machines and power board is given in Fig. 18.

Cutover

The new telephone plant was officially inaugurated on the afternoon of September 16, 1928. The second floor of the Cataluna building was decorated and seats were provided at long tables. Watchcase receivers were installed so that all the guests, of whom there were about 150, could listen to the toll demonstration which formed a part of the programme. Speeches were delivered by the Premier, General Primo de Rivera, and by other Government officials and representatives of the Telephone Company. The toll demonstration was conducted personally by

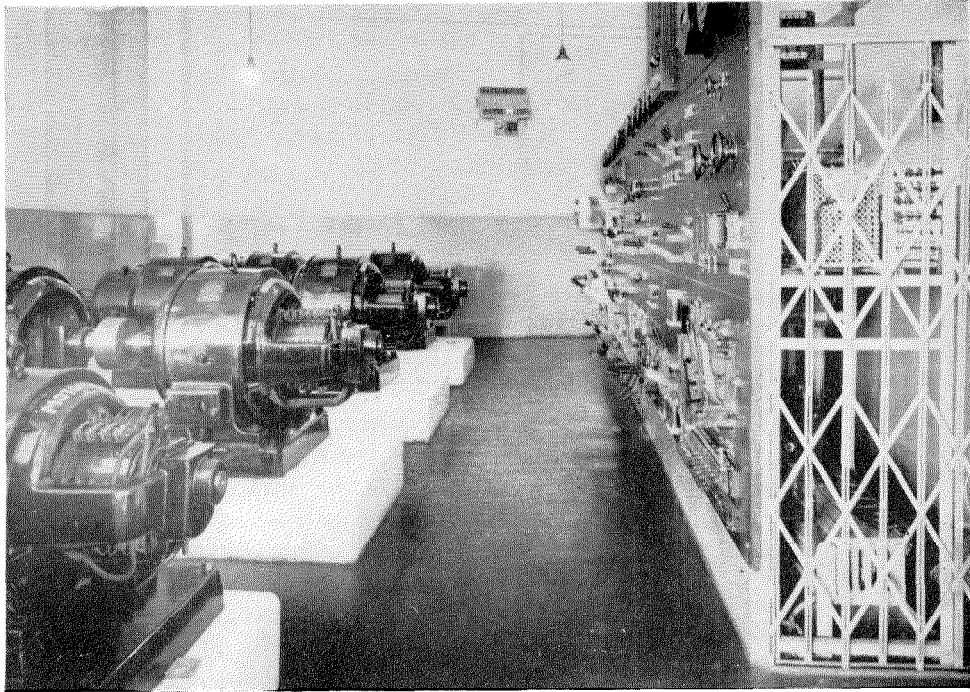

Figure 18—Power Equipment.

General Primo de Rivera, who spoke in turn with Government officials and other persons in all the principal cities of Spain, and in the city of Ceuta in Spanish Morocco. Small maps on two large wall maps indicated the progress of the demonstration, as the different cities were placed in communication with Barcelona.

The actual cutover was made at midnight of the same day. In spite of complications inherent in an operation of this kind, involving as it did four widely separated central offices and an extensive toll installation, the cutover was executed with clockwork precision, and was entirely completed within three minutes from the moment the starting signal was given. This is the largest simultaneous cutover, from the standpoint of the quantity of equipment involved, ever made in Europe, and great credit is due to the Compañía Telefonica Nacional de España for the perfection with which every detail of the operation was planned and executed.

On the following morning, the overload was

on the whole less than had been anticipated and service was not seriously delayed. Within forty-eight hours the traffic had assumed practically normal proportions, and all calls went through without difficulty or delay.

Service Statistics

That the 7-A Rotary machine switching service is appreciated by the public of Barcelona can best be seen in the following comparative statistics of subscriber usage. Before the cutover, calling rates were as follows:

| Office | Calls per line | |
|-------------------|----------------|-----------|
| | Per day | Busy hour |
| Avino..... | 9.70 | 1.21 |
| Gracia..... | 7.59 | 0.84 |
| San Pedro..... | 7.54 | 0.91 |
| Hostafranchs..... | 6.98 | 0.81 |
| San Martin..... | 6.98 | 0.92 |
| Galvany..... | 4.55 | 0.49 |

For the 7-A Rotary exchanges the figures are the following:

| Office | Calls per line | |
|-----------------|----------------|-----------|
| | Per day | Busy hour |
| Cataluna..... | 16.8 | 1.97 |
| Travesera | 16.0 | 1.84 |
| Arenas..... | 13.3 | 1.57 |
| Clot..... | 15.3 | 1.83 |

Taking the average figures for the entire plant an actual calling rate of 15.7 calls per line per day is found, and 1.85 calls per line in the busy hour on the 7-A Rotary Plant, as compared with 8.12 calls per line per day, and 0.98 calls per line in the busy hour on the old manual plant, or an increase of approximately 90% in the local traffic.

The growth in toll service resulting from the improved facilities is equally striking. The toll traffic of Barcelona (including Two Number service) showed an increase of 53% for the six months following the cutover, as compared with the preceding six months. The figures are as follows:

| | Average daily calls completed | | Increase |
|---------------|-------------------------------|----------------------|----------|
| | Six months before cut | Six months after cut | |
| Outgoing..... | 1,969 | 3,049 | 55% |
| Incoming..... | 2,183 | 3,308 | 51% |
| Total..... | 4,152 | 6,357 | 53% |

The above figures indicate conclusively that the subscribers and public of Barcelona find the 7-A Rotary service satisfactory, and are taking

advantage of the facilities which it affords them.

Finally, it is instructive to examine the situation from the standpoint of comparative personnel requirements under manual and machine switching operation. Obviously, the introduction of machine switching equipment reduces the requirement for operators to the number needed for special services, such as information and official P.B.X. On the other hand, owing to the greater quantity and complexity of machine switching equipment as compared with manual, a larger maintenance force is required. In the case of 7-A Rotary plants, however, this increase is not nearly so great as one might expect, since the robust design of the Rotary equipment makes for an extremely low proportion of machine troubles and the unusually complete routine testing provisions, which form a part of the equipment, greatly facilitate and expedite the work of routine inspection and adjustment, making it possible to discover and remedy most of the minor troubles which inevitably develop before any machine failure occurs.

The figures given in the table at the foot of this page, better than any words, tell what the 7-A Rotary has done in Barcelona from the standpoint of maintenance and operating costs.

It should be noted in connection with the above figures that the staff provided at the inauguration of the Rotary service was calculated to cover the requirements of a 38,000-line plant, rather than the initial capacity of 26,000. It is therefore the last set of figures in the Table that must be considered as truly representative of the personnel requirements for Rotary operation as compared with manual.

| | Capacity of Plant Lines | Central Office Equipment Maintenance | | Operation | |
|---------------------------------|-------------------------|--------------------------------------|----------------------------------|-----------|----------------------------------|
| | | Employees | Employee hours per line per year | Operators | Operator hours per line per year |
| Manual operation, 1928..... | 14,500 | 29 | 5.00 | 370 | 63.6 |
| 7-A Rotary Operation, 1928..... | 26,000 | 93 | 6.93 | 60 | 5.76 |
| 7-A Rotary Operation, 1930..... | 38,000 | 93 | 6.11 | 60 | 3.94 |



King Fuad of Egypt.

Training of Egyptian Staff for Rotary Automatic Telephone Exchanges

By E. A. ELLIMAN

Standard Telephones and Cables Limited, London

CAIRO, the capital of Egypt, situated at the head of the Delta of the Nile, controls routes up the Nile Valley and eastward across the desert to the Isthmus of Suez, Syria, and Mesopotamia. Queen of Eastern cities, Cairo is always attractive, and the view from its lofty citadel at an elevation of about 250 feet above the level of the city is one of the most impressive in all the East—every object in the singularly pure atmosphere being distinctly defined. Breaking the monotony of the brown flat expanse, spacious and verdant gardens are seen together with gorgeous palaces, beautiful public fountains and tombs of the mighty dead, whilst most characteristic of all, 400 mosques rise high with swelling domes and tall, white, airy minarets. At a distance of five miles are the ancient pyramids with the time-worn sphinx all distinctly traceable with the naked eye, and in the background can be discerned the outline of the Libyan mountains stretching away in the illimitable desert.

One hundred miles from Cairo on the Mediterranean coast stands Alexandria with the island of Pharos, whereon in ancient times stood a beacon which was among the wonders of the world. Egypt, with its enchanting links with ancient history, and its rich memorials, is now engaged in improving its living communications and establishing links in the chain that is rapidly bringing nations together. The silence of the vast desert has been broken by the installation of wireless receiving stations, the most notable of which is at Luxor. A new air route for transport has been opened between Cairo and Karachi, by means of which this once formidable journey can be accomplished in three days, the waterless sandy desert of Sinai being traversed in an hour. An Air Force School has just been opened at Cairo to provide instruction for civilians in service and maintenance of airplanes. This school was instituted by the order of King Fuad of Egypt.

Cairo, which is the nucleus of the network of Egyptian railways, is also the headquarters of the administrative body which controls them—The Egyptian State Railways, Telegraphs & Telephones. This Administration, in the exercise of its control of telephonic communications in Egypt, has placed orders with Standard Telephones & Cables Limited, London, for rotary automatic exchanges for the Cairo and Alexandria areas. Considerable excitement prevailed among the artisans of the Administration when it became known that, consequent upon the placing of the Cairo contract, several artisan students were about to be selected for an educational mission in Europe. A few months later on a dull November morning, fifteen enthusiastic young Egyptians assembled in a classroom within the contractor's works at Hendon, England. Of these, three only could speak English fluently, these having been in England for three years on a previous mission. Obviously the first duty of the contractor lay in the careful attention to the welfare of the oriental visitors, and the students soon realised that their characteristic tastes and customs had been studied and that every provision had been made for their convenience and comfort. A welfare supervisor with experience in Egypt and some knowledge of Arabic had been appointed to take charge of the party. The classroom had been heated to a degree which the eastern students find suitable for a sedentary occupation. A special canteen had been provided where the particular diet of the Egyptians could be procured. Comfortable accommodation had been secured for the students with private families resident in the neighbourhood, which is a rural suburb of London.

In spite of the severe wintry conditions to which the students were abruptly introduced, the general health was maintained at a particularly high level, thanks to the attentions of the Medical Department attached to the Works

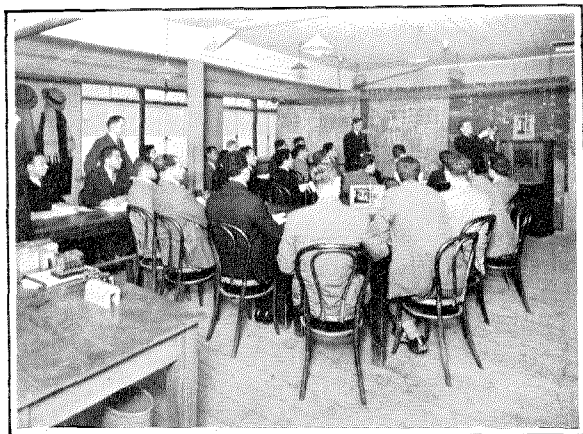

Interior of the Classroom During a Lecture. The Interpreter is Seen Standing by the Blackboard Ready to Communicate the Demonstrator's Remarks to the Students, in Arabic.

and the occasional services of the local doctor. The students responded well to the care and consideration expended on their behalf and settled down to the educational course arranged for them with a determination to learn. The task was by no means easy, either for the students or for their instructors, on account of the language difficulty. A brief glossary was issued to facilitate the supervision of the party and for use in the Medical Department. By means of this, a student could be interrogated in Arabic when an interpreter was not available. A few of the terms appearing in this glossary may be of interest.

| <i>English Phrase</i> | <i>Arabic Equivalent</i> |
|-----------------------|--------------------------|
| What do you want? | Awes eh? |
| What is your name? | Ma esmek? |
| How are you? | Kaifa halek? |
| Are you sick? | Hal enta marid? |
| Where have you pain? | Fimu tashor balmared? |
| Come here. | Ta ala hena. |
| Take this. | Koz die. |
| Drink it slowly. | Eshrat Bebottaa. |
| Sit down. | Egliss. |
| Come again. | Ta ala tani. |

For class instruction, however, it was essential to make use of one of the English-speaking Egyptians as an interpreter for the rest of the party, and for several weeks the instruction was consequently laborious and slow, each sentence having to be translated and explained. Every encouragement was given meanwhile to induce the students to learn English, the advantages

of which were rapidly realised. During this period it was a common occurrence to enter the classroom between lectures and find groups of students practising writing English letters and figures on the blackboard and working out problems in simple English arithmetic. Such opportunities would also be seized eagerly by the men to engage in conversation with their English instructors.

The first task of the teachers was to test the students' knowledge of the fundamental principles of telephony and this revealed the necessity of commencing the course at the lowest elementary stage. A series of instruction papers on fundamental principles of telephony was prepared and issued periodically to the students in the progress of the course. The series consisted of twelve papers as follows:

- No. 1—Elementary Principles of Direct Current.
- No. 2—Elementary Principles of Magnetism.
- No. 3—Elementary Principles of Magnetism, continued.
- No. 4—Elementary Principles of Magnetism, concluded.
- No. 5—Elementary Principles of Alternating Current.
- No. 6—Elementary Principles of Alternating Current, continued.
- No. 7—Elementary Principles of Alternating Current, concluded.
- No. 8—Principles of the Telephone.
- No. 9—Principles of the Telephone, continued.
- No. 10—Principles of the Telephone, concluded.
- No. 11—Transmission Features.
- No. 12—Transmission Features, concluded.

These papers were explained in the classroom



The Wiring Shop at Hendon, Showing the Wiring of Rotary Equipment. The Girls on the Front Benches are Preparing Ribbon Cables for Soldering.

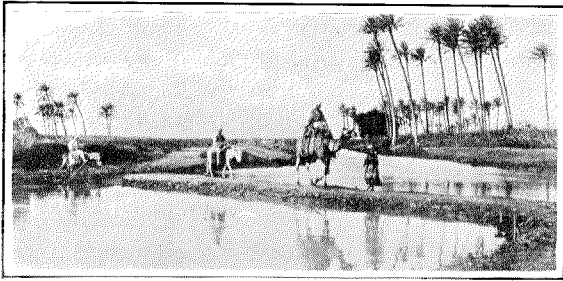

Types of Transport in Egypt.

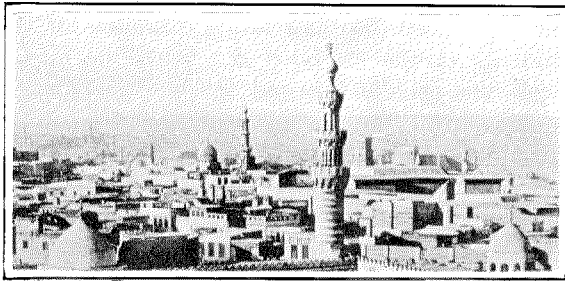

Cairo—Queen of Eastern Cities.



Ancient Landmarks in the Outskirts of Cairo.



Lake Timsah—Egypt.



Public Gardens—Ismailia.

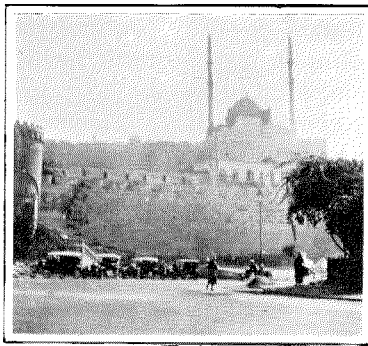

*The Citadel—
Cairo, Built by the Famous Saladin.*



Sweet Water Canal Near Ismailia.

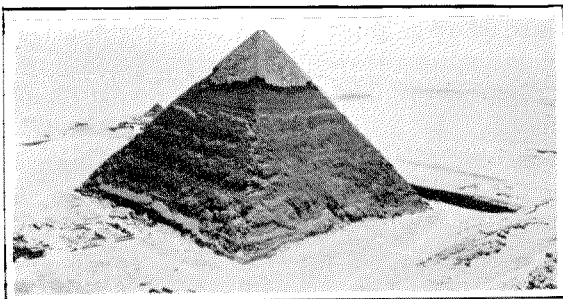

The Second Pyramid of Kefrun.

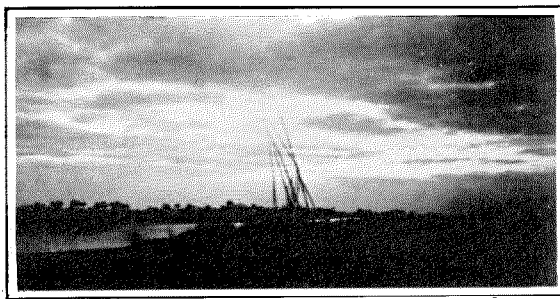

The Shades of Night. A Study Near Ismailia.

and were used also as reading exercises for the students in the study of English. One day a week was usually devoted to these instruction papers during the first six weeks of the course, during which period the students spent the whole time in the classroom. The rest of the time during this period was occupied in explanations and demonstrations of the apparatus used in the rotary automatic equipment, and a simple description of the operation of the system and circuits. After each lecture, notes were dictated to the students for copying later into foolscap notebooks, illustrations in some cases being supplied in blue-print form for insertion in these books. The notebooks were periodically examined and corrected. It was found that this method greatly assisted the students to retain the knowledge imparted in the course of the lectures and, at the same time, to improve their grasp of the English language. In imparting information on the automatic system the functions were compared with the manual telephone equipments with which all the students were more or less familiar. The circuits for the manual equipment and for the corresponding stages in the automatic system were drawn on the board and copied by the students for inclusion in their notebooks. When the fundamental principles had thus been grasped, the circuits were studied in detail. For this purpose a typed copy of the circuit description and a blue print of the diagram were furnished to each student, and the tracing of the operation of a circuit from the diagram whilst the circuit description was being read, proved to be one of the greatest fascinations in the course. It was surprising to find to what extent every student could memorise the detailed operation of a circuit when once the starting point had been determined. At the end of each week an examination was held to test the progress of the men. The results of this examination, showing the percentage of marks gained and the order of merit, were published in the classroom to encourage the spirit of competition amongst the students. A copy of the results was furnished with a report to the Administration in Egypt, so that the progress of each individual student could be followed.

At the end of the six weeks' theoretical training the party was considered ready for practical

instruction in construction, wiring, assembly, adjustment and testing of the rotary automatic equipment. This instruction was carried out in accordance with a definite schedule.

During the progress of this practical course the Wednesday of each week was set aside for class instruction, and the Saturday morning for an examination. Occasional visits were made by the instructors to the students in the shops to interrogate them on their practical work in hand and by this means the interest of the students was maintained.

The students took up their practical experience with considerable enthusiasm and soon gave evidence of skill.

It became possible at this juncture to differentiate between the several abilities of the students, and the class was divided into three groups for specialising in the particular work in which the men would be primarily engaged on their return to Cairo. Class A consisted of men considered more suitable for construction work, Class B of men with marked aptitude for wiring, while Class C comprised those men who gave evidence of testing qualities. The shop work was continued therefore under this classification until the students were ready for their installation course.

The nearest exchange available for this instruction happened to be located in Brussels, Belgium, and by the courtesy of the Belgian Administration, arrangements were made to send the students in parties of five to spend one month each on actual installation work at St. Gilles Exchange. This was a new equipment consisting of 10,000 lines located in a new building.

Early in May, 1929, the first party arrived in Brussels in charge of their Welfare Supervisor, who was able to secure comfortable accommodation for the men in a boarding-house near the exchange. The students were distributed amongst the installation staff so as to receive individual practical tuition in carrying out the work assigned to them. Opportunities were also given for class instruction, one of the installers being available on these occasions to elucidate any difficulties encountered by the students in the course of their work.

All three groups visiting Brussels were en-

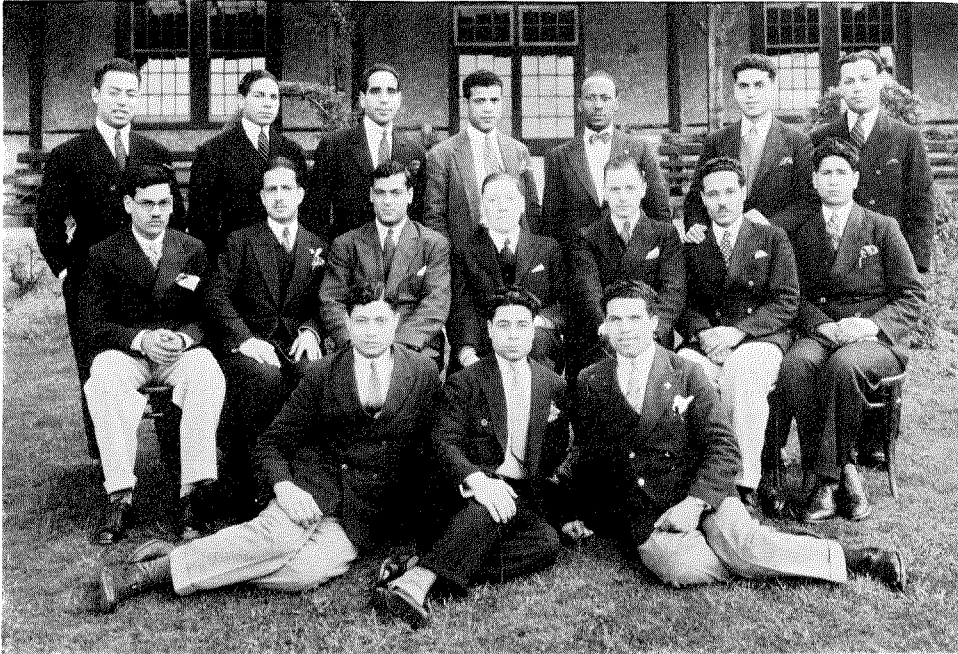

*The Cairo Group and Their Supervisors at the Termination
of the Course. Photographed in the Grounds
of the Hendon Works.*

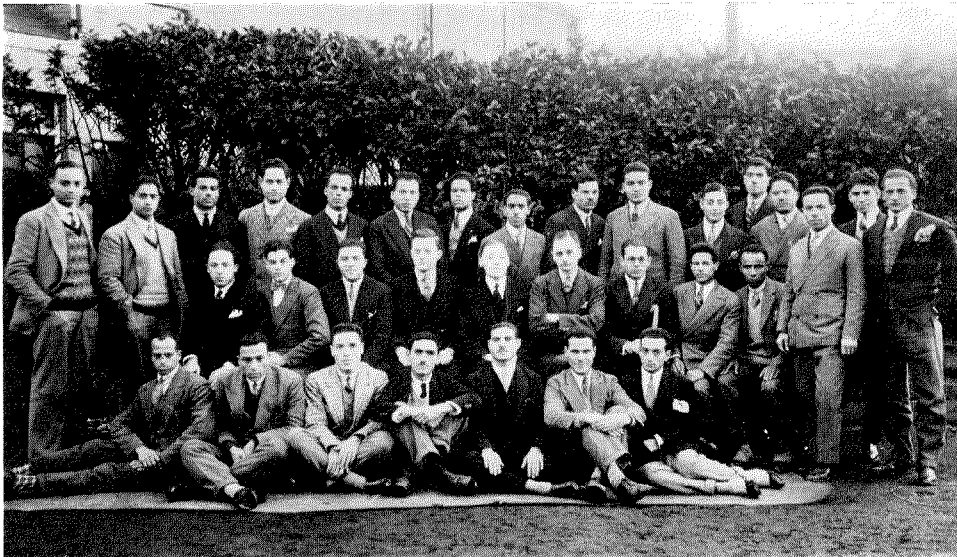

*Students of the Alexandria Mission With Egyptian Engineers
and the Contractor's Training Staff on
Arrival at Hendon.*

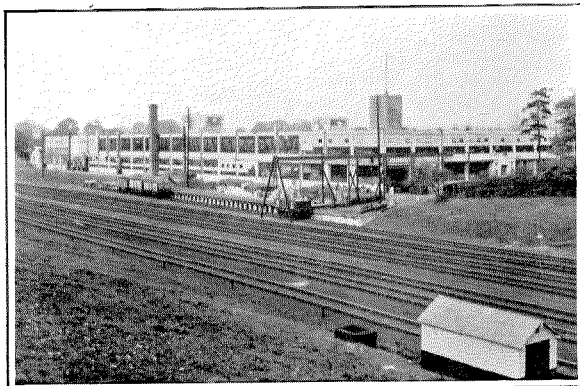

The Contractor's Works at New Southgate, Where the Cairo Students Were Instructed in Assembly and Adjustment of Rotary Apparatus.

abled to participate in the installation testing in progress, but as the Call Through test coincided with the visit of the third group (Class C) the men specialising in testing had the benefit of this additional experience.

On their return to England the students spent a short time in the Circuit Laboratory to learn to locate faults. A working model of the rotary system was utilised for this purpose.

The remaining three weeks of the course were devoted to recapitulation of the theoretical work. By this time the students had been instructed in the theoretical working of all the circuits designed for the Cairo equipment, and the automatic routine testing had been explained in detail.

The examination questions set were of a nature to ensure that the student was familiar with the operation of all circuits. Before leaving the London House, a final examination was set covering in a general way the work of the whole course. The results of this examination, together with a report on the performance of each student, were sent to the Egyptian Administration. Each student also was given a copy of the final examination result and a chart showing his performance throughout the whole course. This chart showed the percentage of marks received at each examination and the order of merit of the student in the class. Apart from the notebook prepared by himself, each student was furnished with a permanent record of the technical in-

struction received in the form of six folders as follows:

- Folder No. 1. Instruction Papers 1 to 12.
- Folder No. 2. Circuit descriptions of the Rotary Exchange for Cairo.
- Folder No. 3. Information on Routiners.
- Folder No. 4. Wiring diagrams of the Rotary circuits.
- Folder No. 5. Cabling information.
- Folder No. 6. Miscellaneous desks for Cairo. Diagrams and Descriptions.

Happy times were spent by the men during their mission in Europe. The party left England in the month of August to take their part in the installation of the new Rotary Exchange in Cairo.

A few months later the order for equipment of the same type for Alexandria was received, in consequence of which a further educational mission in Europe, comprising twenty-seven artisans and two engineers, was arranged.

Acknowledgment. The author is indebted to the courtesy of Shukry Effendi Abaza for the publication of certain of the photographs of Egyptian scenery, and also to Mr. F. Fryer, the Welfare Supervisor, for notes on Egypt.

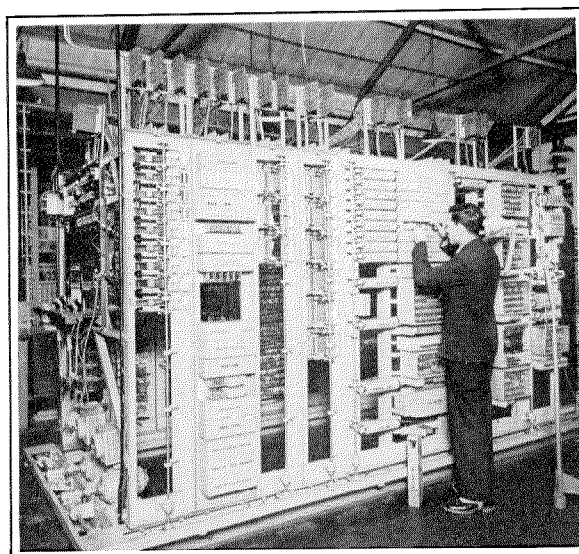

Osman Ali Badr in the Circuit Laboratory at Hendon. This Shows a Model of the Rotary Equipment Upon Which the Students were Instructed in the Location of Faults.

Public Address Systems in Cinemas

By L. DUNBAR

Engineering Division, Standard Telephones and Cables, Limited

IN this article it is proposed to describe the Public Address System installed at the "Regal" cinema, Marble Arch, London, in November, 1928. Since that time similar systems have been installed in two further cinemas of the same type, *i.e.*, the "Metropole," Victoria, opened in December, 1929, and the "Regal," West Norwood, opened in January, 1930.

It may be thought that with the advent of talking pictures there is no need for any music amplifying system apart from that actually used in the production of talking pictures. This, however, is not the case, for the Public Address System as an entirely separate feature is proving itself to be something that must be taken into account in any new or up-to-date cinema, particularly of the larger type. The arrangements within the actual auditorium need not here be considered, as they are entirely provided for by the apparatus producing the sound effects for the pictures. It is in the various subsidiary rooms, such as Tea Rooms and Lounges, of the average large cinema, that the Public Address System comes into its own.

The system used is essentially a standard No. 4002 Public Address System, as manufactured by Standard Telephones & Cables Ltd., Hendon. Certain new features have, however, been incorporated, including the elimination of high tension and low tension batteries, and the addition of an equaliser and a microphone mixer, this being the first occasion in this country upon which such a mixer has been used successfully. The main purpose of the system is to enable music from both the organ and the orchestra in the auditorium to be reproduced in the tea rooms and lounges.

General Description of System

The complete system consists of most of the apparatus shown in Fig. 1, together with a number of microphones, projectors, and, of course, the necessary wiring. The apparatus on

the two shelves to the right of Fig. 1 forms part of an entirely separate system, which will be described later.

The apparatus on the two racks to the left of Fig. 1 is all mounted on steel panels, the various panels—reading from top to bottom of the racks—being:

| <i>Left-Hand Rack.</i> | <i>Right-Hand Rack.</i> |
|------------------------|---------------------------|
| Power Amplifier Panel. | Volume Control Panel. |
| Input Amplifier Panel. | Meter Panel. |
| Filter Panel. | Equaliser Panel. |
| Power Switching Panel. | Microphone Control Panel. |
| | Mixer Panel. |

In the right-hand corner is the Motor Generator Set, the Control Board for which is seen on the wall immediately behind the right-hand top corner of the racks. Directly below is the projector field switchboard.

For descriptive purposes, it is desirable to separate the complete system into four sections, as follows:

- A. Power Supply and Filter.
- B. Microphones and Their Controls.
- C. Amplifiers and Their Controls.
- D. Projectors and Their Controls.

A. Power Supply

Motor Generator Set

With the exception of a 28-volt battery for supplying grid potential to the Amplifier, the whole of the power supply is obtained from a double current motor-generator set supplied by Messrs. Mortly Sprague & Co., Tunbridge Wells. The motor operates from 240 volts A.C., and the generator has a single armature wound for two different outputs, *i.e.*, 100 milliamperes at 350 volts for supplying the plates of the amplifying valves, and 10 amperes at 12 volts for the filaments of the valves, the microphones, and the field coils of the projectors. The specific low tension output for which arrangements should be made depends upon the actual number of moving coil projectors installed.

Motor Generator Control Board

The output leads from the Generator are connected to the Control Board, which carries high tension and low tension meters, and the requisite control for adjusting the output voltages.

Projector Field Switchboard

This consists simply of three single-pole tumbler switches, inserted in circuit between the low tension terminals on the Generator Control Board and the leads to the Projector field coils, one switch controlling each group of projectors.

Power Switching Panel

Apart from the low tension supply to the projector field coils, the whole of the output from the Generator Control Board is fed to the Power Switching Panel, which carries three two-pole knife switches for 12 volts, 130 volts and 350 volts, respectively. (In the actual equipment described, the 130-volt switch is not in use.)

The adoption of separate switches for L.T. & H.T. enables the L.T. switch to be closed first, thus allowing the valves to become warmed up before the 350-volt circuit is closed, thereby obviating damage to the valves.

On the output side of the switches, the 12-volt terminals are connected direct to the corresponding terminals on the amplifier panels (for filament supply) and on the mixer panel (for microphone supply). Before being fed to the amplifiers, however, the 350-volt supply is passed through a filter.

Filter Panel

The panel comprises an arrangement of condensers and iron-cored chokes, designed to eliminate as far as possible the voltage ripple produced by the generator. This, combined with the special grid-filament filter circuits incorporated in the circuit of the input amplifier, reduces the effects of generator noise to a minimum, and renders the reproduction at the projectors free from obnoxious background. As an additional precaution, an electrolytic condenser is connected across the 12-volt terminals of the Power Switching Panel.

B. Microphones and Their Controls

Microphones

These are of the double button "push-pull" high quality carbon type, the diaphragm being stretched so that its natural frequency is higher than the highest frequency normally encountered in the sound to be transmitted. This arrangement secures faithful reproduction over a very wide range of frequencies.

Two of the microphones are mounted in light drum-shaped metal cages supported on pedestal bases, and one is placed towards either end of the orchestra. A third microphone is suspended (free from its cage) from the roof of the auditorium so that it hangs in front of, but well away from, the organ at the right-hand side of the stage. The three microphones are each connected by means of three-conductor shielded cable to the control room, where the ends of the three cables are led to separate sets of terminals on the mixer panel.

A general view of part of the auditorium taken during a rehearsal of the orchestra is shown in Fig. 2. Immediately behind the orchestra may be seen a large framework, upon which are mounted a number of projectors. These form a part of the Western Electric Movietone

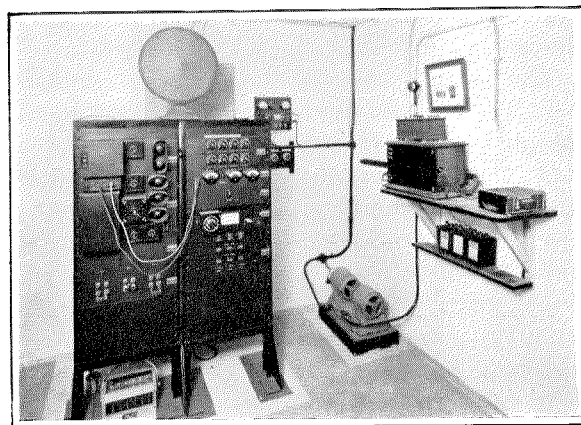

Figure 1—Public Address System Control Room.

System, and are in no way associated with the Systems described in this article.

As particular care was taken during installation to ensure that the microphones, particularly the one in front of the organ, should not

be too obvious to the audience, it is practically impossible to determine their positions from the photograph. The Christie Unit Organ, the largest and most complete Unit Organ ever constructed, is contained in two chambers, built side by side to the right of the Proscenium Arch, immediately above the exit doors shown to the right of Fig. 2.

Mixer Panel

The Mixer Panel has three separate microphone channels, each provided with a key for switching the 12-volt supply on or off, two jacks for measuring the button currents, a potentiometer connected across the output terminals for controlling the volume from the microphones, and a rheostat for adjusting the button currents, which should be from 25 to 40 milliamperes per button. The outputs from the three channels are all connected in parallel, the combined output being connected to one set of terminals on the microphone control panel.

The volume from each microphone can thus be controlled individually, the combined outputs then being mixed together and fed to the input of the first amplifier in the same way as the output from a single microphone. This eliminates the possibility of "blasting" from one microphone when another microphone may still not be contributing its requisite quota. With one or more mixer panels, almost perfect tonal balance may be obtained between the various sounds it is required to reproduce simultaneously.

Microphone Control Panel

Upon the microphone Control Panel is mounted a rotary switch which, when fully equipped, enables the operator to switch rapidly to any one of eight different microphone positions. In this connection it must be remembered that the combined output from the mixer panel is treated as a single position. A key is provided on the panel for short-circuiting the output of the power amplifier when switching from one microphone position to another.

Equaliser Panel

The Equaliser Panel has two entirely distinct circuits. One is merely a single microphone channel similar to those on the mixer panel but without the controls. Two jacks for measuring the button currents are, however, provided, and

the output of the channel is connected to a separate set of input terminals on the microphone control panel. This separate microphone may be used as a standby or for making an-

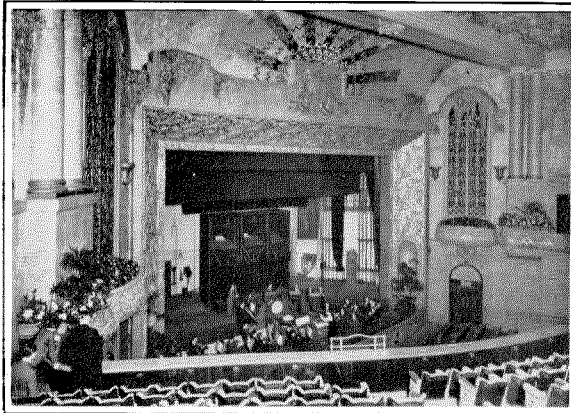

Figure 2—The Auditorium.

nouncements, or for any other special purpose as may be required.

The output from the mixer panel is passed through the equaliser panel before being connected to the input amplifier, and the equaliser may be switched in or out as required. It is used in order that the gain frequency characteristic of the entire system may be as far as possible a straight line over the whole range of frequencies normally encountered. When used with a gramophone pick-up, for example, instead of microphones, it may be found that better results are obtained with the equaliser out of circuit.

C. Amplifiers and Their Controls

Input Amplifier Panel

The Input Amplifier has three stages using a No. 4102-D Valve in each of the first two stages, and a No. 4205-D Valve in the last stage. The circuit is specially adapted for use with a motor-generator set, grid-filament filter circuits being inserted in each of the first two (high amplification) stages. This, combined with the high tension filter panel, ensures that the signal output is free from generator hum. The filaments of the first two valves are in series, and the current is controlled by means of a single rheo-

stat, a second rheostat being provided for controlling the filament of the third valve.

While the No. 4205-D Valve normally operates with 350 volts on its plate, the No. 4102-D

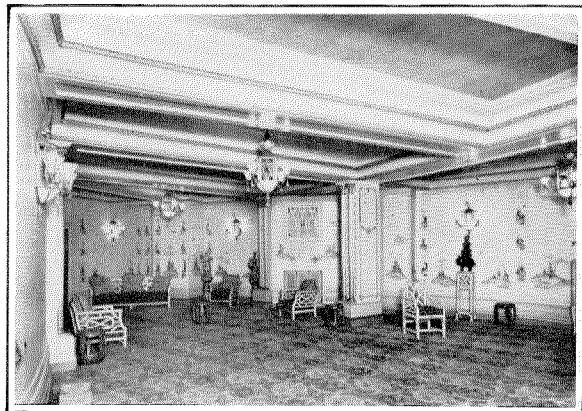

Figure 3—Stalls Lounge.

valves only require 130 volts, the reduction to this voltage being obtained from a potentiometer connected across the 350-volt terminals.

The grid potentials to the first two valves are supplied by means of the potential drops in small resistances, but a separate battery of from 22 to 28 volts is required to supply the grid bias to the third valve. This battery is shown at the bottom of the racks, Fig. 1.

The "gain," *i.e.*, the ratio of energy output to energy input, is controlled as follows: The input to the first stage can be varied by operating the key marked "HIGH—LOW," which connects the grid of the first valve to one of two taps taken off a resistance shunted across the secondary winding of the input transformer. The final adjustment is made by means of the large potentiometer mounted in the centre of the panel, which is in circuit between the first and second stages. The potentiometer dial has thirteen steps, the difference in gain between adjacent steps being approximately three decibels. When it is on the zero step, the input to the amplifier is short-circuited.

The panel is equipped with a set of meter jacks for the purpose of checking plate and filament currents.

Power Amplifier Panel

The Power Amplifier consists of a single push-

pull stage using two No. 4205-D Valves operating with 350 volts on their plates. The filaments of the valves are connected in parallel, the combined current being regulated by means of a rheostat. The negative grid terminal is connected to the corresponding terminal on the input amplifier, so that a common grid battery may be used. A set of meter jacks is provided for the purpose of checking plate and filament currents.

The output terminals of the Power Amplifier are connected to the input terminals of the Volume Control Panel.

Meter Panel

Upon this panel are mounted three meters, as follows:

Milliammeter, 0-100 m.a., for measuring microphone currents and plate currents of the No. 4205-D Valves.

Milliammeter, 0-5 m.a., for measuring plate currents of the No. 4102-D Valves.

Ammeter, 0-4 amps., for measuring filament currents.

D. Projectors and Their Controls

The Projectors are distributed in three groups:

- Group 1—Stalls Lounge.....1 Projector.
- Group 2—Circle Lounge.....1 Projector.
- Group 3—Tea Rooms (Dance Hall) 2 Projectors.

All projectors are of the moving coil, baffle

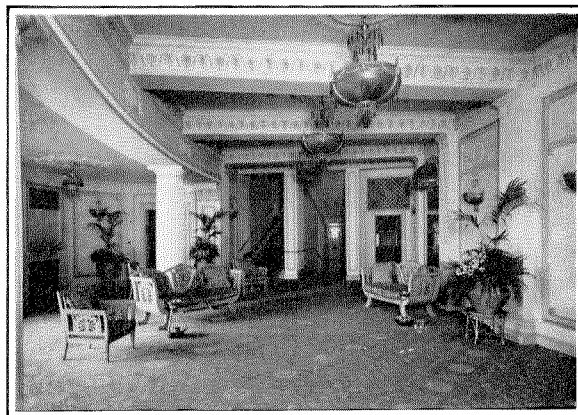

Figure 4—Circle Lounge.

board type, the unit being mounted in the centre of a thick ply-wood board, about three feet in diameter, the complete projector being mounted in a recess in the wall, and covered by an artistic wooden grille. The recesses were specially

made during the building of the cinema, and are accessible from the rear.

Figs. 3, 4 and 5 are general views of portions of the Stalls Lounge, Circle Lounge, and Tea Rooms, respectively. The latter is arranged for dancing.

In Fig. 3, the projector grille may be seen near the centre, immediately above the radiator, while in Fig. 4 the grille is above the settee to the right. In Fig. 5 the grille is above the lift doors at the far end of the room.

Volume Control Panel

This panel contains eight dial switches connected in multiple to an auto-transformer, which is connected across the output of the power amplifier. A key is associated with each switch, and one master key is provided for cutting out all projectors simultaneously.

In the installation here described, only three of the dial switches are actually in use. During installation, the relative volumes of sound from the various groups of projectors are adjusted by means of the respective dial switches, the difference in the volume obtained between one stud position and the next being approximately two decibels. When the relative volumes are judged to be satisfactory, all the dial switches in use are rotated in the same direction, by the same amount, either clockwise or anti-clockwise as the case may be, until the correct impedance matching is obtained between the amplifier output and the projector load. When these adjustments have been made, the dial switches can remain permanently in these positions, all volume control on the system as a whole being performed by means of the gain control potentiometer on the input amplifier.

Monitoring

A No. 4007-A "Kone" projector, shown on top of the racks in Fig. 1, is used for "monitoring," to enable the operator to maintain the requisite volume and quality.

Operation

The operation of the system is extremely simple, and may be performed by any one used to the handling of electrical apparatus. The adjustments to the volume control panel, as

indicated above, will have been made during installation, and the correct settings of the mixer panel controls will normally be obtained during rehearsal, as will the required normal setting

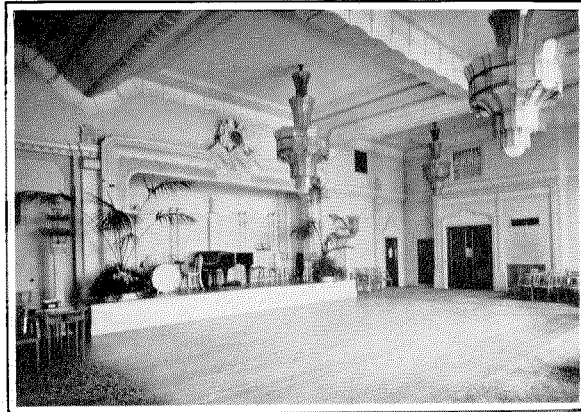

Figure 5—Tea Rooms.

for the gain control potentiometer on the input amplifier.

The normal sequence of events when switching on will then be:

1. Switch on A.C. supply to Motor Generator.
2. Switch on L.T. at Power Switching Panel and Projector Field Switchboard.
3. Allow valves to warm up and switch on H.T. at Power Switching Panel.
4. Adjust Generator output, if necessary.
5. Check filament, plate, and microphone currents.
6. Switch in Projectors.
7. Adjust gain potentiometer as required.

The latter adjustment will normally be the only control required during actual operation, apart from switching in or out the various microphones and projector groups, or adjusting the balance on the mixer panel for different items.

Additional Uses of System

It is, of course, possible to make extensive use of the system, according to the requirements of the management concerned. For example, it would be possible to install a gramophone with electrical reproducer attachment, and to switch this on direct to the input amplifier, cutting out the equaliser and mixer panels, during such time as talking films are being

shown; in which case the orchestra and organ will not normally be in operation.

Further uses are discussed in connection with the smaller subsidiary system, a description of which follows. Where the number of projectors is large, and a high volume level is required, a system similar to the one just described, or of even larger power-handling capacity, may be required.

Subsidiary System

The apparatus shown on the two shelves to the right in Fig. 1 is a small additional Public Address System entirely distinct from the Main System. In the present case, it is installed as a control system for the benefit of the stage manager, or producer, during rehearsals of "turns."

The System comprises two microphone positions, four "Kone" projectors, and the amplifying apparatus.

Microphones

Two microphone jacks are provided, one in front of the stalls, and one in front of the circle, so that a microphone may be plugged into either position, according to the most convenient point of control.

Amplifying apparatus

The microphones are connected to the small single-stage microphone amplifier shown resting on the larger amplifier in Fig. 1. This amplifier is operated from the batteries to the right of the top shelf and on the lower shelf, respectively, a 120-volt dry cell battery being required for supplying H.T., and a 6-volt accumulator for L.T. The output of the microphone amplifier is connected to the input of the Power Amplifier immediately below it. The Power Amplifier is operated entirely from 240-volt A.C. Mains, the valve rectifier for supplying 350 volts high tension forming a component part of the amplifier, and the filaments being supplied with alternating current via a suitable step-down transformer. Mains "hum" is eliminated by a special arrangement of the grid-filament circuit, and by suitable filters incorporated in the amplifier.

The valves used are:

| | |
|-----------------------|--------------------------------|
| Microphone Amplifier. | 1 No. 235-DX. |
| Power Amplifier. | 1 No. 4215-A (peanut). |
| | 2 No. 4205-D (1 as rectifier). |

The current is extremely small, being only about 5 to 7 milliamperes at 120 volts, and 0.25 amperes at 6 volts, for the microphone amplifier, and approximately 0.145 amperes at 240 volts for the power amplifier.

Projectors

Four No. 4007-A "Kone" projectors are installed:

- (a) Flood Light Gallery.
- (b) Projector Room.
- (c) Stage.
- (d) Conductor of Orchestra.

Operation

To put the system into operation, it is merely necessary to turn on two switches, one on the microphone amplifier, and one in the A.C. supply lead. The gain may be controlled either by a 10-point switch on the microphone amplifier, or a 5-point switch on the power amplifier, the control on the battery being rather coarser than on the former.

The stage manager, or producer, can then take up his stand in front of the microphone at either of the microphone positions, and give directions to the stage, orchestra, flood light gallery, etc., as required. There will thus be no necessity for him to move about, or shout to make himself heard.

Additional uses

It is easy to see that such a system can be extended considerably, and many other uses can be imagined. For instance, the stage manager could be supplied with a small switchboard for switching in any one or more of the loudspeakers as required, in order not to distract the attention of those unconcerned with his immediate instructions. Again, a similar system, with one microphone in the box office, and one microphone in each separate portion of the auditorium, would form a useful two-way communication service for indicating the state of crowding, or otherwise, in the various priced seats.

From the author's experience, such a system

would be of undoubted use during the building period of a modern super cinema, in order to locate representatives of any of the hundred-odd different contractors, from one central point, with the least possible delay.

“Loudspeaker” versus “Projector”

It will be noticed that the term “Loudspeaker” is conspicuously absent from this article, and for want of a better term the word “projector” is used.

The reason for this is that, in the author's opinion, the term “Loudspeaker” has itself led to considerable abuse of this class of apparatus. In the ideal case, the amount of ampli-

fication should be such that the sound from the projectors appears to the listener to be equal in volume to what it would be if the listener were within normal hearing distance of the speaker, and under good conditions this objective can be attained in a manner such that in some cases, if suitable concealment is provided, it is almost impossible to tell that a “projector” is in use.

Acknowledgments

The author would like to take this opportunity of thanking the management of the Regal Cinema, Marble Arch, for permission to take the photographs for the illustrations accompanying this article.

Telegraph and Telephone in Japan

By SANNOSUKE INADA

Director General of Telegraph and Telephone Engineering, Department of Communications, Japan

EDITOR'S NOTE:—This paper together with a chapter on Wireless Communication was presented by Mr. Inada at the World Engineering Congress, Tokyo, Section VI, October 30, 1929. The Editor greatly regrets that space limitations necessitated some omissions.

Introduction

TELEGRAPH and telephone communication has recently made rapid progress in Japan, and many new installations have been adopted. Some of the most important installations are, for instance, the Japanese character printing telegraph, carrier current telegraph and telephone, automatic telephone exchanges, long distance telephone cables, short wave radio and broadcasting.

There are many other subjects which I would like to describe; but space will permit only a general description of the more interesting or important projects.

CHAPTER I. TELEGRAPH

General

Japan went into her telegraph enterprise in 1869, when the first telegraphic communication was completed between Tokyo and Yokohama.

During the early thirty years telegraph service in Japan made comparatively remarkable progress, and it was only a few years after the Sino-Japanese and Russo-Japanese wars that the public utilization of the telegraph grew rapidly.

In 1917 telegraph messages increased suddenly (See Figure 1) and showed a peak-load in 1919. This prosperous condition, however, was followed by a stagnant state. Meanwhile the telegraph wires and offices increased a certain amount year after year as shown on the curves in the annexed diagram, and telegraph apparatus and installations also expanded correspondingly.

In September, 1923, the Tokyo Central Office and many other offices in Tokyo and Yokohama cities were all destroyed and burnt out by the big earthquake. Thenceforth the people strove for restoration, with the result that the buildings

and all the telegraph equipment became completely transformed.

By the statistics at the end of 1927 the general state of telegraphs in Japan is shown as the following:

| | |
|--------------------------------------|-------------|
| Number of offices..... | 7,157 |
| Length of land telegraph routes..... | 35,893 km. |
| Length of telegraph wires..... | 307,120 km. |
| underground cables..... | 45,809 km. |
| submarine cables..... | 9,796 km. |
| Number of telegraph circuits..... | 4,027 |
| Number of messages..... | 68,989,144 |

Telegraph lines comprising overhead cable and open wire lines, are composed mostly of 4.5 mm. iron wire and 2.9 mm. copper wire. The first long underground line has been planned for construction between Nagoya and Kobe with an 80 pair special telegraph lead-covered paper cable (quadded type and containing two kinds of cores, 0.9 mm. and 1.3 mm.), which is expected to be accomplished before long.

The length of submarine cable occupies five per cent of the total telegraph lines. Most of the submarine cables run across the principal inland channels and connect islands with mainland, while others are stretched to the colonies and foreign countries.

Recently, five-unit code printers for messages of foreign language and six-unit code printers for Japanese character messages were adopted on certain important circuits. By automatic working of the latter, extremely high efficiency is attained. The Japanese telegraph engineers have hitherto developed a number of improvements, such as duplex among three offices on the same circuit, quadruplex by D.C. and A.C., simultaneous D.C. and A.C. duplex, semi-bridge cable duplex; and improved the method of submarine cable working with thermionic valves. The number of present telegraph systems and

instruments in Japan is given in the following table:

Table 1
Telegraph Apparatus in Japan
(End of March, 1928)

| | | |
|---|------------------------------------|-------|
| Morse Instrument | Simplex..... | 186 |
| | Duplex..... | 3 |
| Sounders | Simplex..... | 5,250 |
| | Duplex..... | 471 |
| Combined Simplex and Duplex..... | | 155 |
| Simultaneous D.C. & A.C. Duplex..... | | 45 |
| Quadruplex (D.C. & A.C.)..... | | 117 |
| High Frequency Duplex..... | | 4 |
| * Wheatstone Automatic Duplex..... | | 139 |
| † Printers | Japanese Letters..... | 30 |
| | Foreign Letters..... | 5 |
| ** Submarine Cable Recorders Simplex..... | | 4 |
| ** Submarine Cable Recorders Duplex..... | | 11 |
| ‡ Automatic repeater | { Simplex..... | 2 |
| | { Duplex..... | 127 |
| | { Duplex with vibrating relay..... | 10 |
| Automatic Telegraph Switch Board..... | | 1 |
| 60 Wires Telegraph Switch Board..... | | 2 |
| Telephone Switch Board..... | | 3 |
| Telephones..... | | 3,336 |
| Automatic Time Switches..... | | 67 |

Note.

| | | |
|----------------------------------|-------|--------------------|
| * Automatic Transmitters..... | 429 | } including spares |
| * Automatic Receivers..... | 393 | |
| Kleinschmidt Keyboard | | |
| Perforators..... | 202 | |
| Creed Receiving Perforators..... | 2 | } |
| Wheatstone Perforators..... | 1,200 | |
| † Duplex (Japanese Letters)..... | 65 | } including spares |
| Teletype..... | 4 | |
| Baudot..... | 4 | |
| W. E. Start-Stop..... | 8 | |
| W. E. Double Duplex..... | 2 | |
| W. E. Quadruple Duplex..... | 4 | |
| W. E. Extension Set..... | 4 | |
| Morkrum Double Duplex..... | 4 | } including spares |
| ** Automatic Transmitters..... | 44 | |
| ** Automatic Recorders..... | 42 | |
| Kleinschmidt Keyboard | | |
| Perforators..... | 17 | } |
| Wheatstone Perforators..... | 206 | |
| ‡ Gill Selectors..... | 267 | } including spares |

The Tokyo and Osaka Central Telegraph Offices

The Tokyo and Osaka Central Telegraph Offices, both comprising wireless stations, are the centres of the Imperial telegraph networks in the east and the west respectively, connecting the inland principal cities. The messages daily digested amount approximately to one hundred and fifty thousand in Tokyo and one hundred and thirty thousand in Osaka. As important

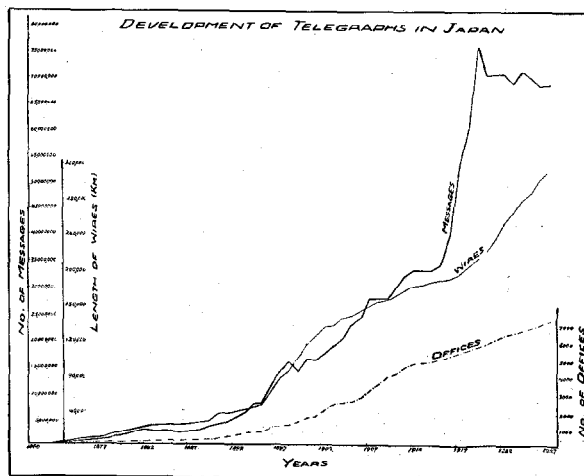

Figure 1

traffic concerned with politics, diplomacy, industry, commerce, and all other human affairs is accumulated, the activity of these telegraph centres may greatly affect good communication throughout the whole country. Both offices are accommodated with up-to-date arrangements for efficient operation.

The new building of the Tokyo Central Office was scheduled for construction in August, 1922, and the big earthquake occurred in the course of its construction in the next year. However, the programme of construction went on again and the removal to the new office took place on the 18th July, 1926.

The new building of the Osaka Central Office was started in March, 1925, and it was in October, 1928, that the removal was completed. In both buildings the two central offices are installed with the latest accommodations, especially ventilation, hot air heating, fire protection by water curtain, and semi-indirect illumination.

The installations in both offices are developed from long experience and study of telegraphic problems in order to attain the most efficient service. The automatic telegraph exchange system which serves city and suburbs communication and which was devised by the engineers in Japan, deserves particular mention.

By adopting a movable sounder resonator the reception of telegrams is done conveniently by typewriting.

Printing telegraph instruments for foreign language and Japanese "Kana," specially de-

signed distributing boards and automatic time switches are used effectively.

As to the instrument tables, a minor belt conveyor is equipped between two tables, and operators at each table are seated face to face with the main belt running along the window-side. One operator's seat occupies one metre width, 0.5 metre depth and 0.67 metre height. These belt conveyers are employed for carrying messages to the sorting table, while the Lamson pick-up carrier distributes messages to each table.

The pneumatic routes are composed of 57 mm. and 76 mm. tubes and the sending and receiving apparatus consist of double slide switches which are pneumatically operated by auxiliary mechanism. As the prime movers for pneumatic tubes, five turbo-blowers with 150 H.P. induction motors are installed in Tokyo, three of which are for pressure and two for vacuum. In Osaka three vertical double cylinder double acting air pumps and two containers are installed. The number of telegraph instruments installed in both Tokyo and Osaka central stations is shown in Table 2:

Table 2.
Telegraph instruments

| | Tokyo | Osaka |
|---|-------|-------|
| Telegraph printer for foreign language.. | 2 | 3 |
| Telegraph printer for Japanese "Kana" | 10 | 8 |
| Submarine Cable duplex..... | 1 | — |
| Wheatstone duplex..... | 33 | 24 |
| D.C.A.C. quadruplex (Morse sounder).. | 16 | 18 |
| D.C.A.C. Simultaneous duplex (Morse sounder)..... | 2 | 2 |
| Duplex (Morse sounder)..... | 69 | 68 |
| Combined duplex and simplex (Morse sounder)..... | 7 | 7 |
| Simplex (Morse sounder)..... | 188 | 97 |
| Telephone..... | 23 | 12 |
| High frequency carrier current duplex.. | — | 1 |
| Automatic telegraph switching system.. | 1 | 1 |
| Telephone switchboard..... | 1 | 1 |
| Pneumatic tube..... | 44 | 4 |

Improvement of Long Distance Automatic

In consequence of industrial and commercial development, the relation between the inland and colonies has become closer and closer, so that several direct telegraph circuits have been inaugurated in succession, namely Tokyo-Dairen, Tokyo-Keijo, Osaka-Mukden, Shimonoseki-Mukden, etc. The Tokyo-Dairen line was com-

pleted in 1919, nearly 3,200 km. in length and contains six automatic repeaters, i.e. Osaka, Shimonoseki, Fusan, Keijo, Antung-Ken and Mukden. There are installed repeaters with vibrating relay at Shimonoseki and Fusan, situated at both ends of 120 n.ms. submarine cable (across the Chosen strait), by which the traffic efficiency is considerably increased.

Improvement of Telegraph Systems

(a) *Automatic Telegraphy.* In order to improve the efficiency in Wheatstone automatic, both types of Kleinschmidt Keyboard Perforators for Japanese and foreign letters have been adopted for punching simultaneously holes corresponding to a letter by a single touch on the keyboard. It has resulted in great saving of both time and labour.

Further, by employing motor driven transmitters and receivers instead of weight driven, it has been made possible to get rid of the nuisance of winding up the weight and inconsistency of speed.

In Nagasaki Office, there are installed Creed receiving perforators and translators, which result in automatic perforating of reversal signals as well as Morse signals from Osaka, thus remarkably saving labor for retransmission.

(b) *A.C. & D.C. Quadruplex and Simultaneous A.C. & D.C. Duplex.* In hand manipulation quadruplex there were inevitable kicks of the non-polarized relay at the instant the double-current key was depressed or off, and it was hardly possible to attain good results. But in 1915, this was straightened out by application of A.C. and D.C. quadruplex, invented by Y. Fuseno, whereby A.C. duplex by the current supplied from lighting circuit was superposed on differential duplex, viz., the polarized relay acts on D.C., and the non-polarized relay on A.C., so far as they introduce no distortion on each other by employing a suitable resonance circuit composed of capacity and inductance. In Japan 55 circuits are equipped with this system out of 4,025 circuits in total.

On the other hand, the same principle has been applied to the simultaneous A.C.&D.C. duplex on one circuit. The system has also been extended to practical use on 14 circuits, all showing satisfactory results.

(c) *Semi-bridge Cable Duplex.* The semi-bridge cable duplex system was invented by the late J. Kajiura, a Japanese engineer.

Since this system was first applied on Sasebo-Dairen Cable in 1909, it has been adopted on many other lines, and brought out a remarkable saving of artificial cables, i.e. able to reduce them into half length, thereby extremely economical in the first cost of duplex installation. It is a noteworthy point of this system that the further length of artificial cable is replaced by some additional condensers, inductances and resistances to the latter part of the total length.

(d) *Improvement of Cable Telegraphy by means of Vacuum Tubes.* The first consideration of this improved cable duplex system was to get rid of higher harmonics and earth current from the received current in order to obtain the perfect duplex balance easily, as well as amplifying the received current. For this purpose a band pass filter and an amplifier containing 2 or 3 vacuum tubes are connected in the receiving circuit.

This amplifier was first applied at the Nagasaki Office on Nagasaki Shanghai line in 1927, and this system is now in successful operation by the speed of 280 letters (220 letters in case of operating without amplifier) with good wave forms. Further, the amplifier with the band pass filter has been under experiment with good result at Nagasaki on the Nagasaki-Tansui line.

(e) *Voice Frequency Carrier Current Multiplex.* This system is constituted of 16 channels by two metallic circuits consisting of four cores in the submarine cable between Aomori and Hakodate (about 60 n.ms.). The carrier frequencies selected are from 450 to 1,700 cycles.

In order to keep frequencies constant, oscillator circuit is designed to give no variation of impedance when the sending keys are depressed or off. A simple tuning circuit is employed on each channel in order to shut off the higher harmonics. The sending current, after passing through this circuit, is amplified by an amplifier common to each channel, and sent out through the line.

The receiving current, after being amplified in the mixed up condition, is separated on each channel by band pass filters, and rectified to be able to operate the receiving relay.

This method has been used since May, 1928.

The Automatic Telegraph Exchange

For the purpose of improving the efficiency of municipal direct communications, the Automatic Telegraph Exchange was first equipped in the new Tokyo Central Telegraph Office upon restoration after the big earthquake disaster, and was opened for traffic in June, 1927, replacing the old type of lamp system telegraph switchboard with the new system.

From the standpoint of modification and maintenance for the telegraph purpose, we adopted the "Relay Automatic" system, 32 volt type P.A.X. with slight changes in order to meet the requirements. Every subscribing office is accommodated with a dial for calling another office.

Later on, Osaka Central Telegraph Office was also equipped with Relay Automatic in October, 1928. The remarkable difference between these two offices lies in the fact that the metallic circuit system in Tokyo is adaptable for both telegraph and telephone apparatus, while in Osaka the single circuit system only for telegraph apparatus. Two hundred subscriber lines were initially installed in Tokyo and 150 lines in Osaka, both being schemed for 300 lines as the final capacity. Instead of 10% trunk as is usual, 20% trunk has been provided for, because the holding time is a little longer and the traffic a little heavier in a telegraph exchange than in a telephone exchange.

The function of the automatic exchange is as follows: a call is made first by dialling and after the connection is completed, the traffic is handled by either telephone or telegraph. The line resistance is permissibly about 500 ohms, not including the sub-office instrument, both for metallic and single lines.

Since the date of actual service, both systems have been working very satisfactorily. The following table shows some data of utilization in both cities concerned:

Table 3.
Some Data of Utilization of Automatic
Telegraph Exchange

| | Tokyo | Osaka |
|---------------------------------|-------|-------|
| Number of Sub-Offices..... | 95 | 86 |
| Number of Lines..... | 176 | 108 |
| Messages per day (average)..... | 3,500 | 3,100 |

Development of Japanese Character Printing Telegraph

Much development of Japanese "Kana" character printing telegraph has been recently achieved in the department, owing to the satisfactory results manifested during some periods for experiments. We have made many improvements in the machine in order to suit the special requirements for the actual traffic management, involving types of characters, lighting position of margin lamp, height of paper knife edge, etc. Also we are investigating from time to time the improvement of the signal current transmitted and received by the printing system. At the present time 89 machines of Japanese-character printers are employed in 18 circuits connecting 12 cities, namely Tokyo, Nagoya, Kyoto, Osaka, Sannomiya, Kobe, Nagasaki, Sendai, Sapporo, Hiroshima, Shimonoseki and Hakodate. In spite of hand operating, Tokyo-Sapporo circuit, one of the longest lines, is handling over 2,000 messages a day or thereabout. As to the automatic machines, we have installed them in Tokyo and Kyoto during the last year's Enthronement Ceremony with excellent results. Now the automatic machines are being utilized every day in Tokyo-Osaka No. 2 Circuit also with satisfactory results.

Phototelegraph Service

When the Enthronement Ceremony was held in Kyoto last year the licence for the private phototelegraph service was for the first time granted to Asahishinbun, Mainichi-shinbun and Nippon-Denpo Tsushinsha between big cities, such as Tokyo, Osaka, Fukuoka, etc., for the purpose of publication in newspapers through their own private telephone toll lines. It was really the first trial in Japan and the fact that some of the historical scenes concerning the grand ceremony were at once put in electrical transmission greatly attracted public attention. In this fiscal year the Department is going to start the phototelegraph service for the public between Tokyo and Osaka. The systems in practical use in the world are Belin, A.T.T., Telefunken, and Nippon Electric systems, the latter being invented in Japan recently.

Telegraphic Connections with Foreign Countries

There are several routes in the telegraphic communication from Japan to the foreign countries. We have only one submarine cable connecting with U.S.A. on the Pacific Ocean, namely Tokyo-Guam line which is the longest one in Japan, and is now equipped with Heurtley magnifier. The landing place of this line in Tokyo will be changed to Kamakura where we are to install the repeater station in this fiscal year. By this arrangement the duplex balancing will be greatly improved in consequence of the fact that the frequent changes in balancing owing to the disturbances due to the external causes and water temperature variation in Tokyo Bay will have been avoided.

From Nagasaki, the western end of the Empire, many submarine cables radiate, i.e., one Japanese Government cable to Shanghai, two Great Northern cables to Shanghai, two Great Northern cables to Vladivostock. Thus China, India, and Europe are connected to our country. As to the Southern communication, we have the Naha-Yap line starting from Riukiu. Besides these, there are the Keijo-Vladivostock line between Korea and Siberia; the Sasebo-Tsingtau line between Kiushiu and China; the Taihoku-Sharp-peak line between Formosa and China and the Toyohara-Alexandrowski line between South and North Karafuto.

Underground Cable

The telegraph underground cable, 12 km. long, was first laid in Tokyo City in 1903. Most cities and towns have grown year after year, so that bare wires in a bustling street could be no more allowed and were replaced by the underground cable. But the major part of long telegraph lines remaining bared could not keep the service safe and perfect, owing to extraneous induction disturbances, storms, etc. Accordingly, 80-pair and 144-pair special telegraph lead-covered paper cable (quadded type and containing two kinds of cores, 0.9 mm. and 1.3 mm.) was designed and the cable of the former type was laid between Tokyo and Yokohama, 36 km. long, in 1926. Between Nagoya and Kobe, the laying of 246 km. in length,

80-pair cable has been set on foot since 1924 and is now under construction. With these cables the metallic system is to be adopted and at Nagoya and Osaka suitable repeaters are required for direct communication.

CHAPTER II. TELEPHONE

General

Our telephone exchange offices were first opened in 1890 at Tokyo and Yokohama with toll service between these two cities. In the beginning, the subscribers were no more than

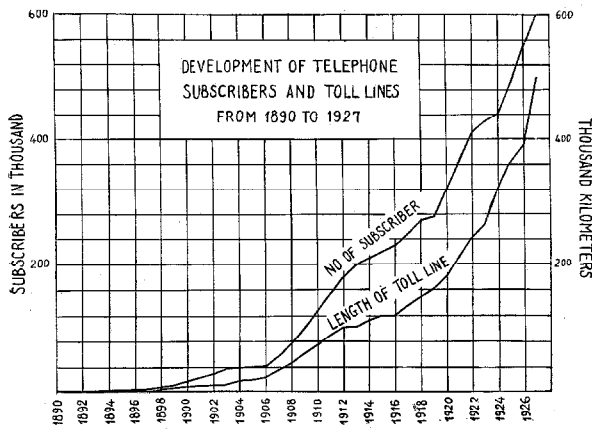

Figure 2

a few hundred, which number, however, increased at a great stride in course of the social development. On the other hand, as conveniences of the telephone came to be known, the demand for telephones showed consequently a tremendous increase. Thereafter, the Government's Extension Budgets were found failing to take care of this increased demand. The new installation has been, therefore, accepted and undertaken on payment of its cost by subscribers. The development of the last thirty years, in respect of subscribers and toll line extension, is given in Figure 2. In March, 1928, the number of exchange offices reached 2,525, subscribers, 609,146 (556,420 manual and 25,726 automatic exchange subscribers); total length of toll line 2,205,552 km., and the numbers of manual switchboards are shown in Table 4. The total investment is 434,529,243 yen.

The extension under contemplation, which resulted from recent revision of the Government's third telephone extension scheme, covers 12 years, including 646,000 subscribers, and 247,000 km. of the toll line at the approximate expenses of 627,354,000 yen.

As it would be very difficult to mention here all our telephone installations, I will describe only the toll telephone line and the automatic telephone exchange system, both of which are among the most striking of the many improvements recently made.

TABLE 4.
Numbers of Manual Telephone Switchboards
(March 1928)

| | |
|--|-------|
| C.B. subscriber's multiple switchboard | 935 |
| Magneto subscriber's multiple switchboard | 32 |
| Magneto series switchboard | 357 |
| Single position magneto switchboard | 4,284 |
| Common battery B switchboard | 437 |
| Magneto B switchboard | 11 |
| Cordless B switchboard | 11 |
| Two position toll switchboard | 765 |
| Single position toll switchboard | 1,446 |
| Recording board..... | 65 |

Part I—Toll Telephone Lines

Toll Cable Lines

Toll telephone circuits in Japan heretofore were mostly of bare overhead wire construction. The maintenance of bare overhead wire is, however, extremely difficult and can not be secured absolutely against storms or various troubles arising from many other causes. Moreover, the development of commerce and industry, the resulting transportation and traffic congestion, caused a great demand for telephone service between cities and towns. The demand could not be met with perfect smoothness even with additions made year after year to the toll lines which then existed. Consequently, it was found necessary to supersede aerial bare wire lines by some other form of construction.

Prior to the time when telephone repeaters and loading coils were not developed fully, use of cable line was limited to a few kilometers as speech transmission through long cables was very poor. Improvements of vacuum tube repeaters and loading coils, however, have made the transmission of speech through cable possible for a distance up to several thousands of kilometers. Thus, installation of cables in many

TABLE 5.
Main Telephone Cables

| Sections | Year Completed | Length (km.) | Under-ground or Aerial | No. of Pair of Cable | Loading Space (km.) | Inductance of Coil (mh.) | |
|-----------------------|----------------|--------------|-------------------------|----------------------|---------------------|--------------------------|----------|
| | | | | | | Side | Ph. |
| Osaka-Kobe..... | 1922 | 37.2 | under-ground | 102 | 1.83 | 174 | 106 |
| Tokyo-Yokohama..... | 1923 | 33.6 | " | 102 | 1.83 | 174 | 106 |
| Kyoto-Osaka..... | 1924 | 56.0 | " | 98 (armored) | 2.00 | 200 & 190 | 70 |
| Tokyo-Hino..... | 1927 | 40.0 | under-ground and aerial | 186, 114 & 54 | 1.83 | 174 | 106 |
| Tokyo-Kobe..... | 1928 | 604.4 | " | 184 & 204 | 1.83 | *174 | 106 & 63 |
| Tokyo-Utsunomiya..... | 1929 | 118.4 | " | 204 & 108 | 1.83 | 174 | 106 |
| Fukuoka-Kurume..... | 1929 | 43.8 | " | 108 | 1.83 | 174 | 106 |
| Moji-Fukuoka..... | 1929 | 100.6 | " | 160 & 108 | 1.83 | 174 | 106 |
| Niigata-Nagaoka..... | 1929 | 71.3 | " | 114, 78 & 54 | 1.83 | 174 | 106 |
| Sapporo-Otaru..... | 1929 | 37.8 | " | 78 | 1.83 | 174 | 106 |

* Loading type H-44-25 is intended to apply in near future.

TABLE 6_a.
Guaranteed Electrical Constants of the Cable at 20° C.

| Dia. of Wire (mm.) | No. of Quads | Conductor Resistance ohm/km. | | Mutual Capacity μ F/km. | | Leakance μ mho/km. | | Insulation Resistance Megohm/km. | Notes |
|--------------------|--------------|------------------------------|---------|-----------------------------|---------|------------------------|---------|---|------------------------|
| | | Side | Phantom | Side | Phantom | Side | Phantom | | |
| 0.9 | 28 | 57.6 | 28.8 | 0.035 | 0.037 | 1.0 | 1.5 | Should be above 800, when all wires and lead cover are connected to the earth | A.C. ω =5000 |
| 1.4 | 20 | 23.8 | 11.9 | 0.06 | 0.064 | 1.0 | 1.5 | | |

important toll trunks was decided when the third telephone extension project was proposed in 1920.

The first loaded cable was installed between Osaka and Kobe in 1922, and then followed the completions of Tokyo-Yokohama and Kyoto-Osaka cables in 1923 and 1924, respectively.

The installation of Tokyo-Kobe cable (about 600 km.) was begun in 1922. The course of this work had been progressing in a satisfactory way, although somewhat altered owing to the great earthquake in 1923, and two-wire cable circuits between Osaka and Nagoya were first completed with a repeater station at Kameyama in 1925. The work was continued further and four-wire circuits from Tokyo and Yokohama reach-

ing over to Kyoto, Osaka, and Kobe were opened for service on the 1st of November, 1928. The further extension of this cable is now going on. Table 5 shows the general feature of construction of main lines.

(a) *Kyoto-Osaka Cable Line.* Armoured cables and loading coil pots with compensation condenser cases were all buried in the earth, the coil distance being 2 km. except terminal sections of 800 meters.

The cables were of 98 pair standard type. The guaranteed electrical constants of cables and loading coils are shown in Tables 6_a and 6_b, and their measured results are as shown in Tables 7 and 8.

After finishing the whole section we made satisfactory results that are shown in Table 9. various electrical measurements, which gave the

TABLE 6.
Guaranteed Electrical Constants of the Coil

| Dia. of Wire of the Cable to which the Coil is inserted (mm.) | Inductance (h.) | | Conductor Resistance (ohm) | | Effective Resistance (ohm) | | Insulation Resistance (megohm) | Notes |
|---|-----------------|---------|----------------------------|---------|----------------------------|---------|--------------------------------|---------------------------|
| | Side | Phantom | Side | Phantom | Side | Phantom | | |
| 0.9 | 0.2±2% | 0.07±2% | 12.2 | 6.1 | 18.2 | 8.5 | Not less than 1000 " | A.C. ω =5000 |
| 1.4 | 0.19±2% | 0.07±2% | 6.7 | 3.35 | 13.2 | 5.75 | | |

TABLE 7.
Measured Electrical Constants of the Cable

| | Conductor Resistance ohm/km. at 20°C. | | Insulation Resistance megohm/km. | Mutual Capacity (μ F/km. 1000 a.c.) | | Damping Constant (G/K 1000~) | | Capacity Unbalance (μ μ F.) | | |
|------|---------------------------------------|------------------------|----------------------------------|--|---------|------------------------------|---------|--------------------------------------|-----|-----|
| | Dia. of Wire 0.9 (mm.) | Dia. of Wire 1.4 (mm.) | | Side | Phantom | Side | Phantom | P-S | S-S | P-P |
| Max. | 26.9 | 11.4 | 92,000 | 0.0348 | 0.0599 | 24.3 | 25.1 | 364 | 423 | 154 |
| Min. | 26.1 | 11.0 | 33,000 | 0.0335 | 0.0577 | 10.5 | 16.5 | — | — | — |
| Mean | 26.5 | 11.1 | 60,000 | 0.0345 | 0.0588 | 19.0 | 20.5 | 108 | 83 | 36 |

TABLE 8.
Measured Electrical Constants of the Coil

| Dia. of Wire of the Cable (mm.) | Inductance (mh.) | | Conductor Resistance (ohm) | Effective Resistance (ohm) | | Insulation Resistance (megohm) | Crosstalk (Crosstalk unit) | |
|---------------------------------|------------------|-----------|----------------------------|----------------------------|----------|--------------------------------|----------------------------|----------|
| | Side | Phantom | | Side | Phantom | | S-S | P-S |
| 0.9 | 199.7-205.7 | 69.5-71.6 | 15.26-18.48 | 17.6-24.4 | 8.7-12.9 | not less than 1000 " | 0-80 | 40-300 |
| 1.4 | 188.2-194.1 | 69.7-71.2 | 9.52-11.5 | 11.6-16.1 | 5.7-6.9 | | mean 20 | mean 120 |

TABLE 9.
Results of Final Test
Cable length 54.5 km.

| | Crosstalk (β l 800~a.c.) | | | Characteristic Impedance (ohm 800~a.c.) | | Insulation Resistance (megohm/km.) 75 volt d.c. |
|------|---------------------------------|-----|-----|---|---------|---|
| | S-S | P-S | P-P | Side | Phantom | |
| Min. | 8.5 | 8.5 | 9.6 | — | — | 6500 |
| Mean | — | — | — | 1830 | 830 | 9700 |

(b) *Tokyo-Kobe cable line.* This is the longest and most important cable line now in Japan. It passes through the mainland transversely and connects Tokyo, Yokohama, Nagoya, Kyoto, Osaka, and Kobe. Aerial cable system was adopted, but in the neighbourhood of cities or in places where aerial cable line could not be built, underground construction was used.

Except a short section between Osaka and Nagoya, the cables used in this line were manufactured in Japan, as our cable manufacturers had become able to supply very superior products. In the Tokyo-Osaka section so-called 184 pair quadded cable was used, which contains 66 quads of 0.9 mm. and 27 quads (one quad

is for spare use) of 1.3 mm. copper conductors, but in the Osaka-Kobe section we used 204 pair cable consisting of 52 and 50 quads of 0.9 mm. and 1.3 mm. conductors respectively. Table 10 shows some specified values for those cables, and some typical measured results of manufactured cables are shown in Table 11 for the comparison of specified values.

The loading type is high cut off medium heavy loading. The specified and actual electrical constants of loading coils are shown in Tables 12 and 13 respectively. Most of the loading coils were of foreign manufacture, but some home-made ones were used in lately installed sections.

TABLE 10.
Specified Electrical Constants of the Cable

| | Conductor Resistance (ohm/km.) 20°C | | Mutual Capacity (μ F/km.) 20°C | | Insulation Resistance megohm/km. 20°C | Damping Resistance 20°C | Capacity Unbalance ($\mu\mu$ F/150 m.) | | |
|------|--|-------|--|---------|--|-------------------------------|--|-----|-----|
| | Dia. of Wire (mm.) 0.9 1.3 | | Side | Phantom | | | P-S | S-S | P-P |
| Max. | 27.65 | 12.25 | — | — | — | 9 | 200 | 100 | 200 |
| Mean | — | — | 0.042 | 0.070 | 5,000 | — | 30 | 20 | 30 |

TABLE 11.
Measured Electrical Constants of the Cable

| | Conductor Resistance (ohm/km.) 68°F | | Mutual Capacity (μ F/km.) 900 a.c. | | | | Insulation Resistance megohm/km. 20°C | Damping Constant at 900 \sim | Capacity Unbalance ($\mu\mu$ F/152 m.) | | |
|------|---|---------|--|---------|---------|---------|--|--------------------------------------|---|------|------|
| | Dia. of Wire (mm.) 0.9 1.3 | | Dia. of Wire | | | | | | P-S | S-S | P-P |
| | | | 0.9 mm. | | 1.3 mm. | | | | | | |
| | Side | Phantom | Side | Phantom | Side | Phantom | | | | | |
| Max. | 26.4 | 13.2 | 0.0426 | 0.0668 | 0.0432 | 0.068 | — | — | 275 | 102 | 165 |
| Mean | — | — | 0.0375 | 0.0604 | 0.0391 | 0.0623 | min. 40.65 | 6.75 | 21.5 | 13.2 | 20.1 |

TABLE 12.
Specified Electrical Constants of the Coil

| For use of | Inductance mh. 1800~2m.a. | | Max. Effective Resistance ohm 1800~2m.a. | | Cross-talk (cross-talk unit) | | | | Insulation Resistance (megohm 20°C) |
|----------------|------------------------------|---------|--|---------|------------------------------|---------------------|----------------------|---------------------|--|
| | Side | Phantom | Side | Phantom | S-S | | P-S | | |
| | | | | | Max. | Mean | Max. | Mean | |
| 2-Wire Circuit | 178 | 108 | 27.4 | 13.4 | not more than 100 | not more than 40 | not more than 200 | not more than 80 | not less than 1000 |
| 4-Wire Circuit | 178 | 64 | 27.4 | 10.4 | " | " | " | " | |

TABLE 13.
Measured Electrical Constants

| | Inductance mh. (h) | | Effective Resistance (ohm) | | Cross-talk (cross-talk unit) | | Insulation Resistance (500 volt 70°F) |
|------|--------------------|---------|----------------------------|---------|------------------------------|------|---------------------------------------|
| | Side | Phantom | Side | Phantom | P-S | S-S | |
| Max. | 0.1819 | 0.1084 | 20.9 | 8.7 | 35 | 35 | not less than 1000 megohm |
| Min. | 0.1784 | 0.1072 | 19.2 | 7.8 | 5 | 4 | " |
| Mean | 0.180 | 0.1074 | 20.0 | 8.4 | 13.6 | 15.9 | " |

The cables were connected after making capacity unbalance tests at 3 points in each loading section, and the maximum values of capacity unbalance of one loading section were reduced within the values shown in Table 14. This not only minimized the capacity unbalances between circuits within each quad, but those between quads were also made as small as possible.

TABLE 14.
Permissible Capacity Unbalances in One Loading Section

| | Mean Values of one Loading Section ($\mu\mu\text{F.}$) | Max. Values of one Loading Section ($\mu\mu\text{F.}$) |
|-----------------|--|--|
| Phantom to Side | 15 | 50 |
| Side to Side | 25 | 80 |

TABLE 15.
Cross-talk (Cable length 67.7 km.)

| | Cross-talk (cross-talk unit) | | | Notes |
|------|------------------------------|-----|-----|--------------------|
| | S-S | P-S | P-P | |
| Max. | 120 | 160 | 160 | Source 1000 ~ a.c. |
| Mean | 75 | 125 | 80 | |

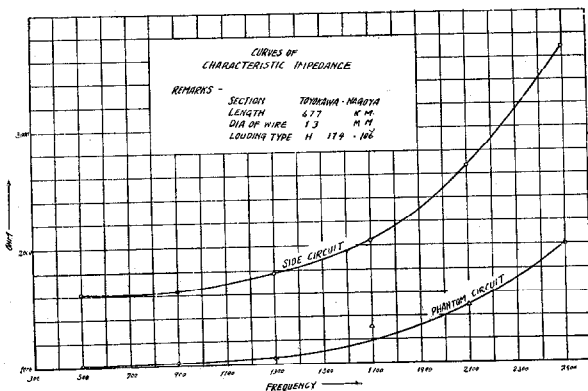

Figure 3

After completing the laying of cable by the above-mentioned ways, the final tests were made to each repeater section. Table 15 and

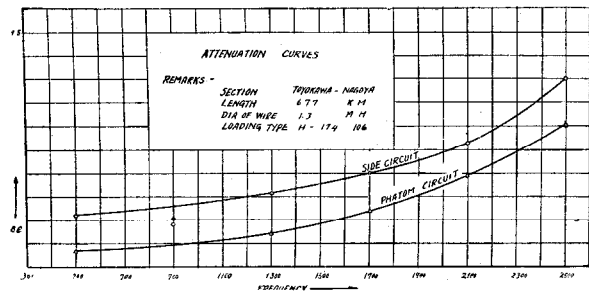

Figure 4

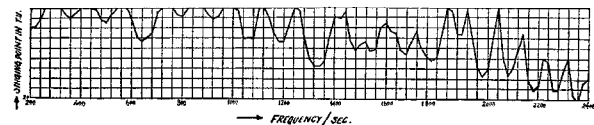

Figure 5

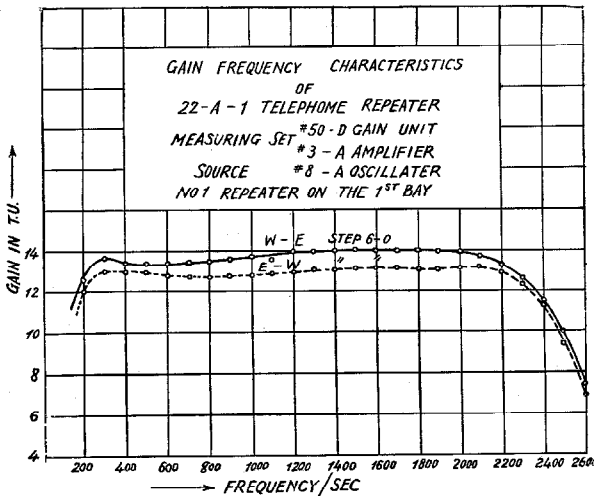

Figure 6

Figures 3 and 4 show some results obtained from final tests in the section Toyokawa-Nagoya.

The location, spacing and actual number of telephone repeaters introduced to this cable line are shown in Table 16, and each repeater station has enough capacity for all circuits of the cable already finished and the second cable which is to be laid in the near future.

For circuits up to 400 km. length the 2-wire type was adopted, and for those over 400 km. length the 4-wire type was used. Repeaters used in each repeater station were of A.T. and T. type.

As an example of 2-wire repeaters, we describe here those at Ashigara station. The frequency characteristics of balancing networks and cables with 1600 ohm terminating resistance at the far ends were very closely coincident, and Figure 5 shows the variation of singing point with frequency of one of these circuits. The gain frequency characteristics of the repeater were also very smooth within voice frequency range as shown in Figure 6. Table 17 illustrates some results obtained from cross-talk tests of repeater bays only.

TABLE 16.
Repeater Stations and Repeaters (Nov. 1928)

| Name of Repeater Station | Distance from Preceding Station (km.) | No. of Repeaters Actually Installed | | |
|--------------------------|---------------------------------------|-------------------------------------|--------|-------|
| | | 2-Wire | 4-Wire | Total |
| Tokyo..... | | — | 46 | 46 |
| Yokohama..... | 34 | 49 | — | 49 |
| Ashigara..... | 56 | 25 | 44 | 69 |
| Ejiri..... | 92.2 | 26 | 44 | 70 |
| Toyokawa..... | 123.4 | 50 | 44 | 94 |
| Kameyama..... | 131.2 | 11 | 45 | 56 |
| Osaka..... | 140.1 | | | |
| Total..... | 576.9 | 161 | 223 | 384 |

TABLE 17.
Cross-talk in the Bay of the 2-Wire Repeater. (Cross-talk unit)

| Disturbing Repeater | Disturbed Repeater | Cross-talk Affected by E-W Side | | Cross-talk Affected by W-E Side | |
|---------------------|--------------------|---------------------------------|------------|---------------------------------|------------|
| | | Test end W | Test end E | Test end W | Test end E |
| 1st bay | 1st bay | | | | |
| 1 | 2 | 40 | 40 | 30 | 50 |
| 2 | 1 | 70 | 70 | 50 | 50 |
| 1 | 3 | 30 | 30 | 50 | 50 |
| 3 | 1 | 10 | 20 | 30 | 10 |

TABLE 18.
Near End Cross-talk (Tokyo—Osaka Line)

| | | S ₁ -S ₂ | S ₂ -S ₁ | P-S ₁ | S ₁ -P | P-S ₂ | S ₂ -P | Notes |
|-----------------|------|--------------------------------|--------------------------------|------------------|-------------------|------------------|-------------------|-----------------------------------|
| Tested at Tokyo | Max. | 100 | 120 | 100 | 100 | 200 | 260 | Source 20-C |
| | Mean | 90 | 100 | 90 | 90 | 110 | 150 | Test set 50-B |
| Tested at Osaka | Max. | 200 | 200 | 200 | 150 | 200 | 160 | These Values are Means of 3 Quads |
| | Mean | 170 | 170 | 160 | 150 | 160 | 130 | |

The characteristics of 4-wire repeaters at Osaka station will be described as an example. In Figure 7, the gain frequency characteristics of a 4-wire repeater are shown, although these vary with the attenuation characteristic of the line itself.

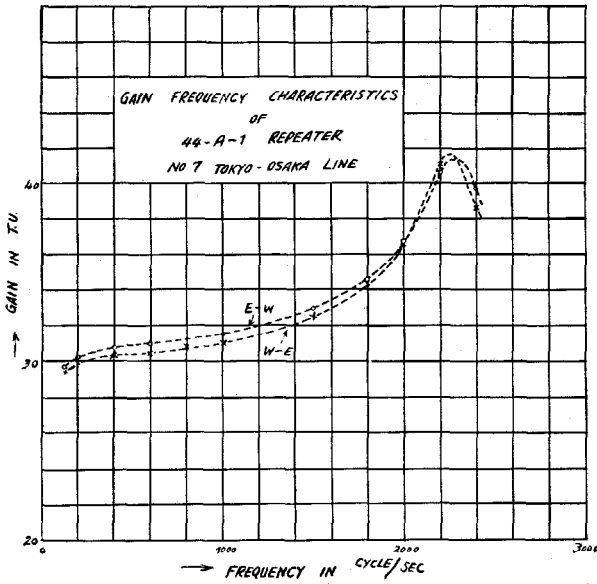

Figure 7

In the final tests with through circuits from Tokyo to Osaka, etc., near end cross-talk in all 4-wire circuits was exceedingly small, for sending sides were segregated from receiving sides very carefully; but far end cross-talk was pretty large, due to the amplification by repeaters. Tables 18 and 19 show some of these results.

The net transmission equivalent of Tokyo-Osaka 4-wire circuit was 8 TU at 800 cycle as shown by level diagram in Figure 8, and the loss frequency characteristics are shown in Figure 9.

(c) Proposed Cable Lines. There are many aerial bare wire lines to be changed into cable lines, and Figure 10 shows the cable routes already completed and proposed.

Submarine Cable Lines

All submarine telephone cables except very

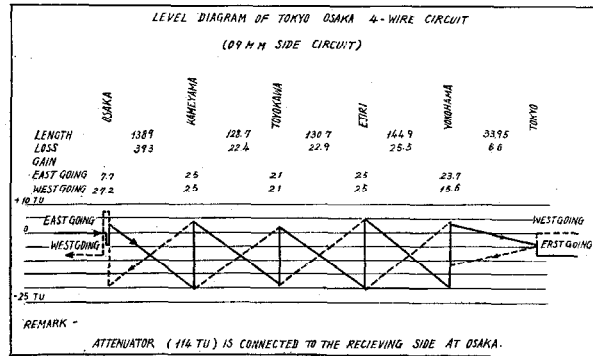

Figure 8

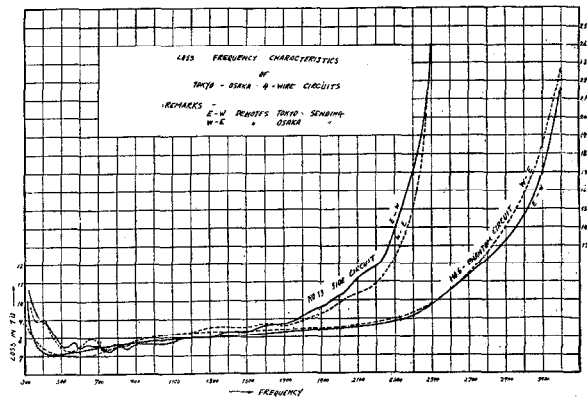

Figure 9

short ones are, of course, loaded. The type of loading is all continuous loading except one coil-loaded cable (about 35 km.) which is to be laid between two islands of Oki at the end of

TABLE 19. Far End Cross-talk (Tokyo—Osaka Line)

| | | S ₁ -S ₂ | S ₂ -S ₁ | P-S ₁ | S ₁ -P | P-S ₂ | S ₂ -P | Notes |
|-----------------|------|--------------------------------|--------------------------------|------------------|-------------------|------------------|-------------------|-----------------------------------|
| Tested at Tokyo | Max. | 1100 | 1350 | 1260 | 1700 | 1500 | 1550 | 20-C as Source |
| | Mean | 820 | 770 | 1050 | 1400 | 1220 | 1290 | 50-B Test Set |
| Tested at Osaka | Max. | 1680 | 1500 | 1350 | 1350 | 2000 | 1750 | These Values are Means of 4 Quads |
| | Mean | 1380 | 1210 | 1180 | 1260 | 1530 | 1340 | |

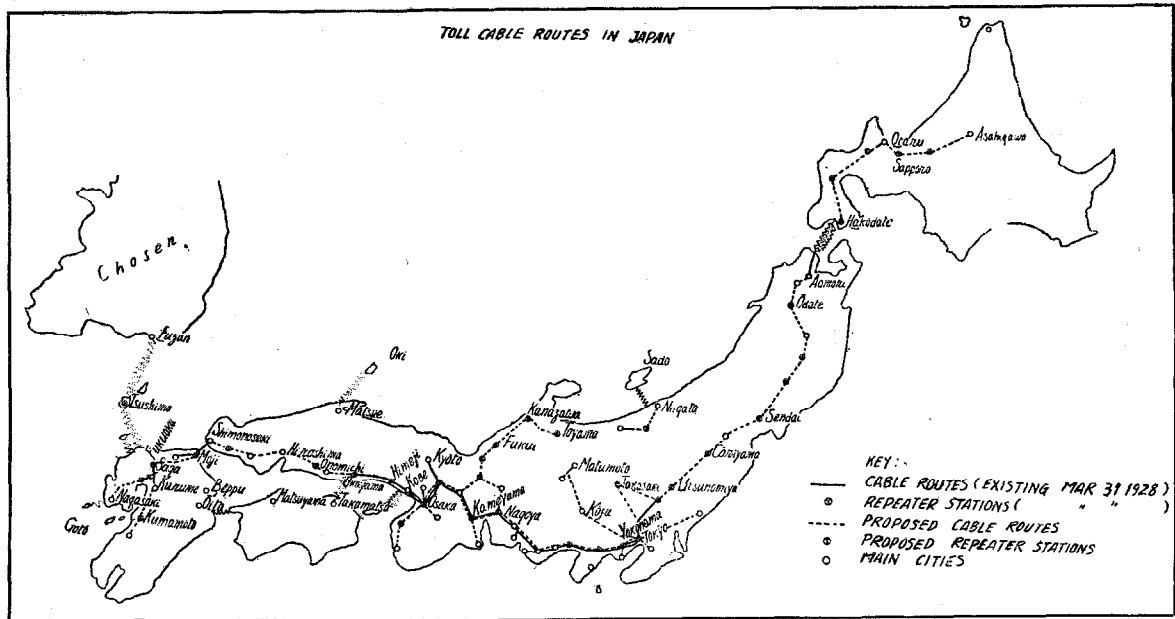

Figure 10

this year. Two kinds of cable, lead covered paper insulated and G.P. or balata insulated, were used according to the state of sea bottom and tide. Most of lead covered paper insulated cables are of home manufacture, and this kind of cable will mostly be used in future. Tables 20 and 21 show the general features of construction

and some electrical constants of main submarine cables already laid. The uniform loaded cable in Tsugaru strait connects Aomori and Hakodate with land cable at both ends, i.e. about 27.3 km. of 14 pairs at the Hakodate side, and about 45.7 km. of 8 pairs at the Aomori side, and these cables are medium

TABLE 20.
Principal Continuous Loaded Submarine Telephone Cables

| | Year | Length km. | Kind of Cable | No. of Conductors | Dia. of Conductor mm. | Dia. and No. of Layers of Landing Wire |
|-----------------------|------|------------|-------------------------------|-------------------|-----------------------|--|
| Bisan Strait..... | 1922 | 10.8 | Lead covered, paper insulated | 16 | 1.85 | 0.2×2 |
| Tsugaru Strait (I)... | 1926 | 65.6 | Balata insulated | 4 | 2.47* | 0.3×2 |
| Geiyo Strait..... | 1927 | 34 | Lead covered, paper insulated | 8 | 1.8 | 0.3×1 |
| Bungo Strait..... | 1927 | 48 | G. P. insulated | 4 | 1.85 | 0.3×2 |
| Akashi Strait..... | 1928 | 22 | Lead covered, paper insulated | 28 | 1.3 | 0.3×1 |
| Naruto Strait..... | 1928 | 15 | Lead covered, paper insulated | 28 | 1.3 | 0.3×1 |
| Essa Strait..... | 1928 | 38.8 | Balata insulated | 4 | 2.49* | 0.3×2 |
| Tsugaru Strait (II) | 1928 | 64.4 | Balata insulated | 4 | 2.49* | 0.3×2 |
| Fukuoka-Iki..... | 1928 | 33 | Lead covered, paper insulated | 2 | 1.3 | 0.3×1 |
| Fukuoka-Tsushima | 1929 | 115 | G. P. insulated | 4 | 2.5 | 0.3×1 |

Note.—Mark * made up of a 2.0 mm. copper round wire and 3 copper strips.

TABLE 21.
General Electrical Constants of the Principal Submarine Telephone Cables

| Locations of Cable | D. C. Test | | | A. C. Test | | | | | |
|--------------------|--------------------------------|-------------------------|--------------------------------|----------------------------------|------------------------------|------------------------------|--------------------------------|------------------------------|------------------------------|
| | Conductor Resistance (ohm/km.) | Capacity (μ F/km.) | Insulation Resistance (mg/km.) | Side Circuit | | | Phantom Circuit | | |
| | | | | Characteristic Impedance (ohm) | Attenuation Const. (per km.) | Wave Length Const. (per km.) | Characteristic Impedance (ohm) | Attenuation Const. (per km.) | Wave length Const. (per km.) |
| Bisan Strait | 6.52 (60°F) | 0.0514 | 13.400 | $f = 800$ $469\sqrt[6]{31}$ | 0.0153 | 0.1192 | $271.5\sqrt[6]{25}$ | 0.0132 | 0.1079 |
| Tsugaru Strait (1) | 3.67 (15°C) | 0.203 | 5.120 | $f = 900$ $380\sqrt[2]{51}$ | 0.0138 | 0.222 | $185.2\sqrt[2]{22}$ | 0.0134 | 0.2187 |
| Bungo Strait | 3.72 | 0.196 | 9.300 | $f = 800$ $379\sqrt[0]{45}$ | 0.01345 | 0.182 | $179\sqrt[0]{21}$ | 0.0135 | 0.171 |
| Geiyo Strait | 6.2 | 0.078 | 105.000 | $f = 900$ $483.8\sqrt[7]{11}$ | 0.0151 | 0.132 | $267\sqrt[6]{9}$ | 0.0139 | 0.1203 |
| Tsugaru Strait | 3.51 | 0.204 | 7.500 | $f = 1000$ $371\sqrt[1]{56}$ | 0.0135 | 0.230 | $182\sqrt[2]{21}$ | 0.0132 | 0.226 |
| Essa Strait | 3.46 | 0.198 | 16.820 | $f = 900$ $359\sqrt[3]{20}$ | 0.0125 | 0.207 | $186\sqrt[0]{41}$ | 0.0125 | 0.203 |

Table 21 shows the electrical properties of some of the main cables shown in Table 20.

TABLE 22.
General Features of the Carrier Current Telephone Equipment

| Section | System | Frequency of Carrier Current | | Construction of Line | Repeater |
|--------------------|----------------------|------------------------------|------------------------|---|-----------|
| | | E-W | W-E | | |
| Tokyo-Osaka | Telefunken 2-Channel | 12800 17800 | 28000 30950 | Carrier system is only applied between Tokyo and Nagoya of 0.4 mm. open wire circuit, and Nagoya-Osaka section is ordinary voice frequency cable circuit. | No |
| | Western 3-Channel | 16100 19750 23400 | 7700 10700 14000 | Carrier system is only applied between Aomori and Urawa of 0.35 mm. open wire circuit, and Urawa-Tokyo section is ordinary voice frequency cable circuit. | At Sendai |
| Kumamoto-Kagoshima | Lorenz 3-Channel | 30900 28000 23000 | 17850 12820 5000 | 3.5 mm. open wire line | No |

heavy loaded. The repeaters are installed at Aomori and Hakodate. The Fukuoka-Tsushima cable is to be prolonged to Fusan for use as a part of an international telephone line.

Carrier Wave Telephony and Trunk Lines for Broadcasting

(a) *Carrier Wave Telephony for Public Use.* Carrier wave telephone communications now existing in Japan are in three sections, Tokyo-Osaka, Tokyo-Aomori and Kumamoto-Kagoshima, and their general features are shown in Table 22.

Each circuit is so constructed that its net transmission equivalents between distributing boards at both end offices are about 10 TU.

The loss-frequency characteristics measured

with carrier circuit of Telefunken type between Tokyo and Nagoya are shown in Figure 11.

(b) *Carrier Current System for Power Lines.* Hydraulic power is abundant, and many high power generating stations supplying electricity to the principal cities are located deep in the mountains, whereas the method of connecting these stations to switching or transformer stations is very important, especially on the occasions of some faults in power lines in bad weather. The Electric Research Laboratory has carried out a great deal of investigation of the carrier current telephone system which is used in most of the important power lines. Table 23 shows the list of generating stations using the carrier current telephone system.

(c) *Trunk Lines for Broadcasting.* The lines connecting broadcasting station and studio are underground cable type, and those connecting broadcasting stations are open wire type except in some special districts. For the trunk circuits between Tokyo and Osaka extra light loaded (H-44-25) 4-wire type was used, which was constructed with 0.9 mm. conductors in the cable laid in that section as described in the preceding section, and those between Kyoto and Osaka were also constructed with conductors of the same cable, the type being 2-wire extra light loaded.

Underground cables connecting broadcasting station and studio were of paper insulated lead covered armoured type containing 13, 7 or 4 pairs of 1.3 mm. copper conductors, each pair being shielded by lead-tin alloy tape of 0.05 mm.-0.1 mm. thickness. These cables were loaded with coils having inductance of 25 mh. at intervals of 1 km. to obtain the cut off frequency of about 10,000 cycles. Table 24 shows a part of electrical characteristics of the loading coils.

The open wire lines were so constructed that two circuits on the ends of a 6-pin arm were used without pole pair to diminish cross-talk, and 3.5 mm. and 2.9 mm. hard drawn copper conductors were used for circuits between broadcasting stations and between broadcasting station and studio respectively.

Table 25 shows the 5,000 cycle losses and compositions of some trunk circuits.

Equalizers are inserted in the sections between Tokyo-Sendai and Fukuoka Kumamoto only, the others having been adjusted for attenuation differences by the amplifiers themselves within the limit of ± 2 TU.

Part II. Automatic Telephony

General

The semi-tropical climate was a serious problem for the adoption of the automatic switching system in Japan. After thorough investigation a P.A.X. equipment was installed in the Communication Department in October, 1922. It was a Strowger automatic switching equipment for 300 lines with Keith line switches. On April 1, 1923, the first public automatic exchange was opened at Dairen, South Manchuria, for 5,800 lines (ultimate capacity is for 10,000 lines)

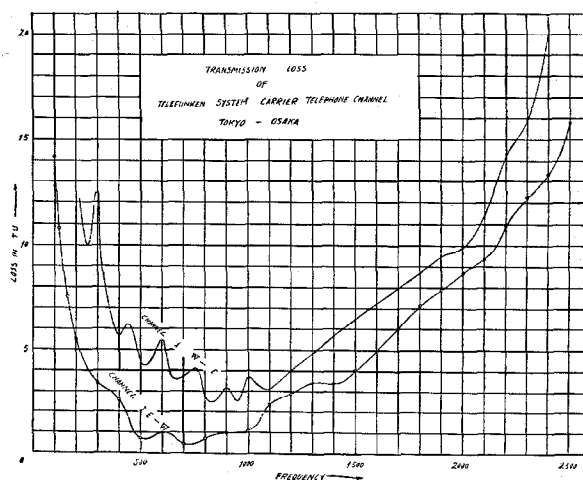

Figure 11

with the same type of equipment using rotary line switches. From these experiences the automatic switching system was going to be adopted in the home land of Japan. By the great earthquake in September of 1923 most parts of the telephone plants in Tokyo and Yokohama were destroyed. For its reconstruction we decided to adopt the "step-by-step" automatic switching equipment with the exception of four manual exchanges in Tokyo. Kyobashi office, the first automatic exchange in Tokyo, was opened in January of 1926 with 3,000 lines. Other exchanges were opened one by one in Tokyo within one and a half years, that is, in July, 1927, the tenth automatic exchange "Shiba" was opened.

At that time the total number of automatic subscriber lines in Tokyo were 36,000 out of 86,000 in total. After that the automatic switching systems were adopted in many other cities.

At the end of March, 1929, the total equipped line terminals were 102,100 and the actual automatic subscriber lines became 84,517, which corresponds to 12.7% of the total number of subscriber lines of the whole country. The details are shown in Table 26. Many private branch exchanges are also automatized. At the end of March, 1929, the number of P.A.X. was 160, and the equipped number of lines was 12,182.

For the future development of telephone plants in large cities and also even in other smaller cities, the automatic switching equipment will be adopted if the circumstances are favorable.

The automatic equipments, all of which are

TABLE 23.
Carrier Current Telephone on P. L.

| | Name of Station | Power | kc/s | Distance |
|---------------------|---|-------|-------|----------|
| Tokyo Dento | Nakatsugawa No. 2. General Station..... | 25W | 36.1 | 214 |
| | Kamedo Transmitting Substation..... | 25W | 25.8 | |
| Nippon Denryoku | Sasatsu Transmitting Substation..... | 125 | 1 | 194 |
| | Kanidera General Station..... | 125 | | |
| | Nagoya No. 1 Transmitting Substation..... | 125 | | |
| | Seto Generating Station..... | 125 | | |
| | Gifu Transmitting Substation..... | 125 | | |
| | Osaka Transmitting Substation..... | 125 | | |
| Ujigawa Denki | Uji Generating Station..... | 25 | 176.4 | |
| | Noe Transmitting Substation..... | 25 | 333 | |
| Kinugawa Suiden | Tokyo Transmitting Substation..... | 125 | 31.6 | 125 |
| | Shimotaki Generating Station..... | 125 | 40.0 | |
| | Teishakugawa Generating Station..... | 250 | 51.3 | |
| Sanyochuo Suiden | Okayama Transmitting Substation..... | 250 | 33.3 | 60 |
| | Shikama No. 2 Generating Station..... | 250 | 33.3 | |
| Toho Denryoku | Nashima Generating Station..... | 125 | 40.0 | 28 |
| | Kawakamigawa Generating Station..... | 125 | 32.6 | |
| Nihon Denryoku | Tokyo Transmitting Substation..... | 50 | | 299 |
| | Ome Switching Station..... | 50 | | |
| | Saku Switching Station..... | 50 | | |
| | Aun Switching Station..... | 50 | | |
| | Yanagigawara Receiving Station..... | 50 | | |
| Tokyo Dento | Yodohashi Transmitting Substation..... | 10 | 120 | 62 |
| | Yatsuzawa Generating Station..... | 10 | 100 | |
| Daido Denryoku | Yomokaki Generating Station..... | 15 | 109.1 | 220 |
| | Osaka Transmitting Substation..... | 15 | 138 | |

TABLE 24.
Some Electrical Constants of the Loading Coil used for Broadcasting Trunk Cable

| Inductance | Standard Permissible | $25 \text{ mh.} \pm \frac{4}{100}$ (standard) | 1800 ~ 2 ma. |
|------------|----------------------|--|----------------------|
| Cross-talk | Maximum | Less than 50 Cross-talk unit | Measured 900 ~ 2 ma. |
| | Mean | Less than 20 Cross-talk unit | |

TABLE 25.
Construction and Line-Loss of Some Broadcasting Trunk Lines

| Section | Loss in TU at 5000 ~ | Line Construction (length in km.) | | | |
|------------------------|-------------------------|-----------------------------------|-----------------|--------------|--------------------------------------|
| | | Non-loaded cable | Loaded cable | Open line | Submarine continuous loaded cable |
| Tokyo—Sendai..... | 24.6 | 6.0 | 29.0 | 364.0 | — |
| Osaka—Hiroshima..... | 20.5 | — | 52.5 | 324.0 | — |
| Hiroshima—Fukuoka..... | 19 | 4.0 | 14.0 | 300.0 | 3.7 |

TABLE 26.
Number of Automatic Subscribers according to their Locations and Types of Equipments in 1928

| Name of Cities | Office Name | Equipped No. of Lines at the end of 1928 | No. of Subs. Lines actually equipped at the end of 1928 | Opened at the year of |
|---------------------------|-------------|--|---|-----------------------|
| Tokyo, 6 digits..... | Kyobashi | 7,300 | 6,017 | 1925 |
| Tokyo, 6 digits..... | Honjo | 6,400 | 5,643 | 1925 |
| Tokyo, 6 digits..... | Shitaya | 7,700 | 6,850 | 1925 |
| Tokyo, 6 digits..... | Kanda | 4,200 | 3,061 | 1925 |
| Tokyo, 6 digits..... | Kayabacho | 3,400 | 2,346 | 1925 |
| Tokyo, 6 digits..... | Kudan | 3,600 | 3,300 | 1926 |
| Tokyo, 6 digits..... | Otsuka | 2,900 | 2,627 | 1926 |
| Tokyo, 6 digits..... | Marunouchi | 4,100 | 3,641 | 1927 |
| Tokyo, 6 digits..... | Nihonbashi | 4,000 | 3,136 | 1927 |
| Tokyo, 6 digits..... | Shiba | 4,000 | 2,671 | 1927 |
| Tokyo, 6 digits..... | Mita | — | 842 | 1928 |
| Tokyo, 6 digits..... | Asakusa | 8,000 | — | in installation |
| Tokyo, 6 digits..... | Akasaka | 2,000 | — | in installation |
| Nagoya, 5 digits..... | Honkyoku | 5,000 | 2,719 | 1928 |
| Nagoya, 5 digits..... | Naka | 4,000 | 2,756 | 1928 |
| Kyoto, 5 digits..... | Honkyoku | 7,000 | 5,123 | 1928 |
| Kyoto, 5 digits..... | Gion | 4,800 | 3,618 | 1928 |
| Near Tokyo, 4 digits..... | Nakano | 2,800 | — | in installation |
| Near Tokyo, 4 digits..... | Kawasaki | 1,800 | — | in installation |
| Near Tokyo, 4 digits..... | Ebara | 1,600 | — | in installation |
| Near Tokyo, 4 digits..... | Senju | 1,400 | — | in installation |
| Yokohama, 5 digits..... | Honkyoku | 6,000 | 5,149 | 1925 |
| Yokohama, 5 digits..... | Chojamachi | 6,000 | 5,381 | 1925 |
| Osaka, 6 digits..... | Horikawa | 2,000 | 1,527 | 1927 |
| Osaka, 6 digits..... | Tennoji | 2,500 | 2,193 | 1927 |
| Osaka, 6 digits..... | Fukushima | 1,600 | — | in installation |
| Kobe, 5 digits..... | Minatogawa | 5,000 | 4,513 | 1927 |
| Kobe, 5 digits..... | Suma | 1,700 | — | in installation |
| Near Osaka, 4 digits..... | Tengachaya | 2,300 | 1,694 | 1928 |
| Near Osaka, 4 digits..... | Sumiyoshi | 1,600 | 1,257 | 1928 |
| Near Kobe, 4 digits..... | Mikage | 3,600 | — | in installation |
| Near Kobe, 4 digits..... | Ashiya | 2,000 | — | in installation |
| Kantung, 4 digits..... | Dairen | 6,500 | 6,223 | 1923 |
| Kantung, 4 digits..... | Sakako | 1,000 | 611 | 1927 |
| Kantung, 4 digits..... | Bujun | 800 | 625 | 1928 |
| Kantung, 4 digits..... | Mukden | 4,000 | — | in installation |

of the step-by-step type, were hitherto supplied from abroad, but recently the home production has become available.

The general engineering principles of automating are described in the following:

Numbering

(a) *Office Number.* There are at present in Tokyo 11 automatic and 9 manual exchanges as shown in Figure 12. The whole Tokyo telephone area is divided into 7 districts. Two digits were assigned to each office, the first figure being for district code and the second figure for office code. Districts are numbered from 2 to 8, 9 being reserved for future. All exchanges are designed for 10,000 line capacity and have no branch office.

The telephone area of Osaka having 2 automatic and 11 manual exchanges is divided into 8 districts and a 6 figure system was applied.

Total Number of Automatic Subscribers in 1928 and 1929

| Number of offices opened | | No. of Lines equipped | | No. of Subscriber Lines actually equipped |
|--------------------------|------|-----------------------|---------|---|
| 1928 | 1929 | 1928 | 1929 | 1928 |
| 25 | 36 | 102,100 | 132,600 | 84,514 |

The telephone plants in Nagoya, Kyoto, Kobe and Yokohama are arranged for 5 figure system.

We have studied director equipment. Although this is complicated in itself, it has advantages in connection with dialing and has flexibility for inter-office trunking. In the case of Japanese alphabets, however, as they consist of 48 letters and some sonant marks, it is quite impossible to put all those letters in the 10 finger holes of the dial. If we intend forcibly to apply Japanese

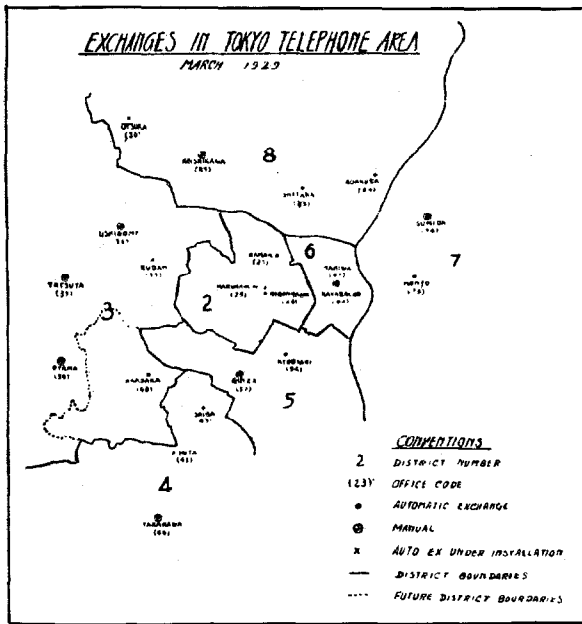

Figure 12

alphabets, the number of letters should be limited, and as the result of limitation the difficulties in choosing office names will be encountered. It is for these reasons that the director system was not adopted.

(b) *Subscriber's Number.* In the automatic exchange there are two kinds of subscriber, that

is, individual and party line with two parties and no coin box. In the telephone area which has more than 5,000 subscriber lines the message registering system is applied. As the numbering of party line subscribers employs the jack per station system, all subscriber's numbers are given by 4 figures.

Trunking

(a) *Connection from manual or toll office to automatic office.* In Tokyo, Nagoya, Kyoto and Yokohama (no manual offices in Yokohama) the dialing device is equipped at every "A" position or toll position and the connection from manual or toll to automatic subscribers is completed by 4 digits dialing through the dialing relay group equipped at the outgoing end of the junction line. In Osaka and Kobe cordless B boards with impulse sending machines are equipped between automatic office and manual or toll office. In this case the connection comes from A board to B board by order wire and then connection to automatic office is completed by depressing the digit key at B board.

It is also expensive to equip the machine switching equipments for toll connection to the specially busy subscriber group with toll traffic. It is sometimes economical to make the connection manually in special toll incoming B posi-

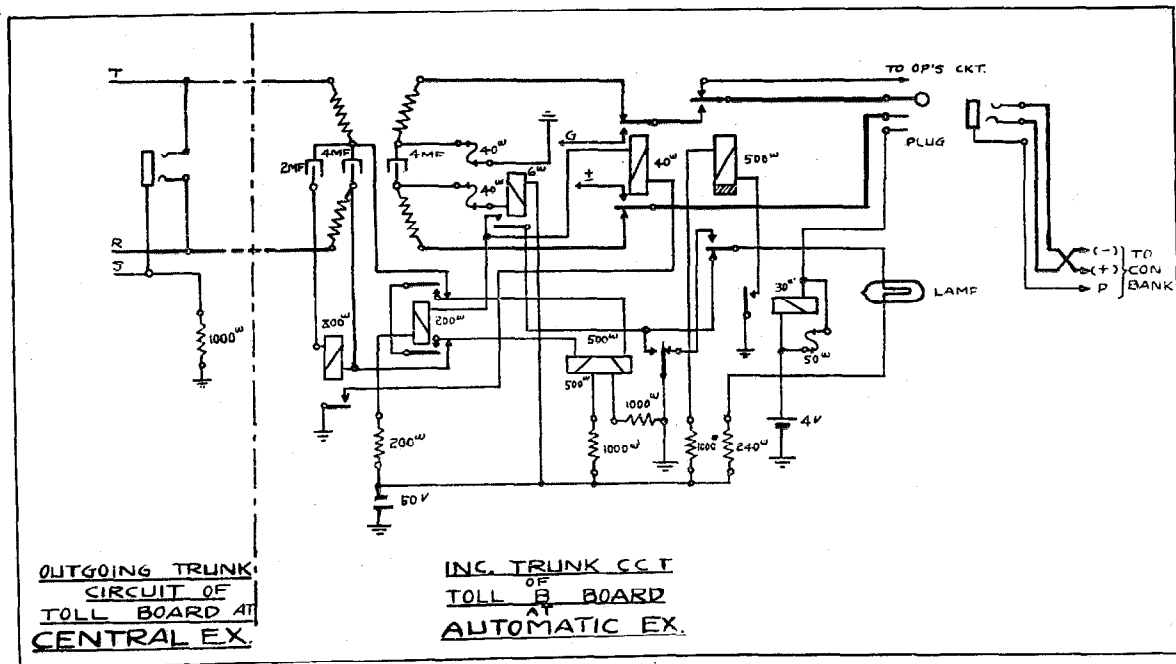

Figure 13

tions at automatic office by order wire system. In Kayabacho office, Tokyo, the toll traffic is so heavy as to require 200 toll incoming junction lines for 2,300 subscribers. Figure 13 shows the cord circuit used in the toll incoming B board at Kayabacho. The multiple jacks in the incoming B board are wired in multiple to connector bank contacts.

(b) *Connection from automatic office to manual office.* The calls from automatic to manual are handled manually at the call indicator position which is installed in the respective manual office. The number dialed by automatic subscribers is indicated at lamp field on B board, and the connection is completed by the operator through multiple jack.

Number of call indicator positions equipped is shown in Table 27. The construction as well as operating features are different according to the manufacturers. Table 28 shows the main different points of three systems. A. E. I. and S. H. type equipments were modified to meet with our requirements. The points of modification and the reasons are shown in Table 29. Cord

circuit of call indicator is arranged for 2-wire incoming line, and 40 junctions can be equipped in one position.

(c) *Trunking from automatic to automatic or manual.* Trunking diagram from automatic office to automatic or manual office in Tokyo at the end of 1928 is shown in Figure 14. In normal Strowger equipments there is no automatic device to make busy the inter-office trunks from incoming side in case of testing or trouble on the incoming switch and it is possible to make busy only from the outgoing side. It is very troublesome and unreliable to request the outgoing office to make the junction line busy to avoid lost calls in the case of trouble and testing of incoming switch. In manual practice, the trunks are always ordered to the originating office from the incoming office; in automatic, however, it is just the reverse. We made special arrangements in repeater and incoming selector or call indicator trunk to avoid these troubles, as shown in Figure 15.

With this arrangement in the case of testing or taking off the switch, the earth will be con-

TABLE 27.
Number of Call Indicator Equipments in 1928

| Type of Equipments..... | Tokyo | Osaka | Kobe | Kyoto | | Nagoya | Total |
|-------------------------------|-----------|-------|-------|-----------|----------|----------|-------|
| | W. E. Co. | S. H. | S. H. | W. E. Co. | A. E. I. | A. E. I. | |
| Call Indicator Positions..... | 109 | 26 | 10 | 4 | 8 | 17 | 174 |
| Call Indicator Trunks..... | 2,955 | 676 | 260 | 110 | 269 | 630 | 4,900 |

TABLE 28.
Comparisons of the Functions of Different Call Indicator Equipments Used

| No. | | A. E. I. Type | W. E. Type | S. H. Type |
|-----|-----------------------------------|---|---|--|
| 1 | Battery voltage. | 24 volts. | 24 & 48 volts. | 24 & 60 volts. |
| 2 | Relay mounting. | Switch type with jack. | Same arrangement as used in manual practice. | Same arrangement as used in manual practice |
| 3 | Recorder finder. | Preselecting type with 25 points rotary switch. | Preselecting type with 22 points rotary switch. | Post selecting type with relay sets. |
| 4 | Bank multiple of recorder finder. | Straight multiple for 20 finder switches. | Terminal strips are equipped to make reverse wiring with every 5 finder switches. | 4 testing relays are equipped in each trunk. Up to 4 recorders can be selected from one trunk. |
| 5 | Arrangements for team work. | none | Team work is possible to the adjacent positions. | none |

Table 28. Continued.

| No. | | A. E. I. Type | W. E. Type | S. H. Type |
|-----|--|---|--|--|
| 6 | Mode of indication of the number of called subscriber. | Called subscriber's number is indicated automatically under the control of display control switch. | Display key is equipped for team work. Called subscriber's number is indicated by depressing this key. | Called subscriber's number is indicated automatically under the control of display control relay set. |
| 7 | Make busy devices of C. I. trunk. | Call indicator trunk can be made busy individually by putting ground on the (+) line at incoming end. | Make busy devices equipped for each group of 5-10 trunks through a trunk between auto. and manual. | Call indicator trunk can be made busy individually by disconnecting b line at the incoming end. |
| 8 | Assignment lamp. | Assignment lamp lights until plug in to the multiple jack. | Lights after completion of 4 digits dialing and flashes until plug in after display. | Lamp for displayed line flashes until plug in. |
| 9 | Recorder busy lamp. | Lights during recorder busy. | Lights dark when recorder is seized and flashes from display to plug in. | Same as W. E. type. |
| 10 | Number of recorders in one position. | Capacity 7. Actually equipped 7. | ditto | ditto Remark: No. of recorders available from one trunk is 4. |
| 11 | Talking current supply voltage. | 24 volts. | 24 volts. | 24 volts. |
| 12 | In the case of all recorders busy | All trunks in that position become busy at the outgoing end. | Recorder finder will stop on resting point and call will be handled manually as in term. no. 13. | ditto with A. E. I. |
| 13 | If the recorder finder fails to find the idle recorder or the impulses are sent in before the impulse circuit of recorder is closed. | Busy tone will be sent out to calling side. | Lights the disconnect lamp and handled manually. | No devices for these cases; these cases happen very seldom due to the short hunting time of idle recorder. |
| 14 | Called subscriber is busy. | Busy tone is sent out to calling side by depressing busy key momentarily and recorder becomes free. | Busy tone is sent out thru busy back jack. | ditto to A. E. I. |
| 15 | Disconnection during conversation. | Flash the disconnection lamp to call the attention of operator. | Light the disconnect lamp to call the attention of operator. | Flash the disconnect lamp to call the attention of operator. |
| 16 | Display lamp. | 2 sets in one position. | One set in one position. | One set in one position. |
| 17 | Delayed disconnection of calling subscriber after finishing the conversation. | No signal appears. | Lights the delay disconnect lamp after certain interval, and calls the operator's attention. | No signal appears. |
| 18 | Incomplete dialing. | If more than one min. elapsed between impulses, only the nos. dialed will be displayed. | Recorder busy lamp lights for long time. When the operator depresses the flashing key the assignment lamp will indicate that trunk by flash. | Busy tone is sent out to calling side and assignment lamp lights for 1-3 min. after the last impulse. |
| 19 | Availability of using as the call circuits between manual offices. | none | Arrangements are made easy to change over. | none |
| 20 | Type of digit switch. | Rotary switch is used. | Same as A. E. I. | Combination of relays. |

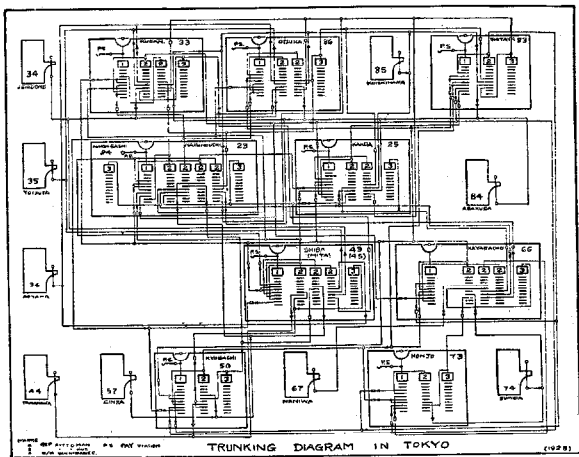

Figure 14

nected to the minus line of the junction to operate relay C in repeater and relay C will give earth to the corresponding private line. We considered also to use jack instead of relay on the incoming selector, but there is no available space to mount jack on the selector.

“Adsole” Equipment

In Japan, the months of June and July are the rainy season. The humidity is the highest in this season as shown in Figure 16, and Figure 17 is the temperature curve. As we have already had bitter experience with high humidity in the common battery manual system, it was considered almost impossible to adopt the automatic switching equipments to which high voltage, such as 48 volts, is always applied, without using any humidity adjusting device. Fortunately, an air drying device was practised by utilizing the adsole, which is the special moisture absorbing reagent invented by Chemical Research Institute, and this device was applied to automatic offices to adjust the humidity.

Adsole is manufactured from acid earth, a natural product in the Echigo district of Japan.

It strongly absorbs the moisture of air at an ordinary temperature without any change in itself and can be used permanently. At 120°C, or above, it expels the absorbed moisture, and when cooled it becomes capable of absorbing the moisture again. Acid earth is composed chiefly of silicic acid and aluminum and the absorbing power of adsole is over 15% of its

own weight. Completely dried air can be obtained by sending the moistened air through a tank containing adsole. When the dried air is moistened by spray, the air becomes cool through evaporation. This process enables us to obtain refreshed cool air in summer.

Two adsole tanks are provided in one plant.

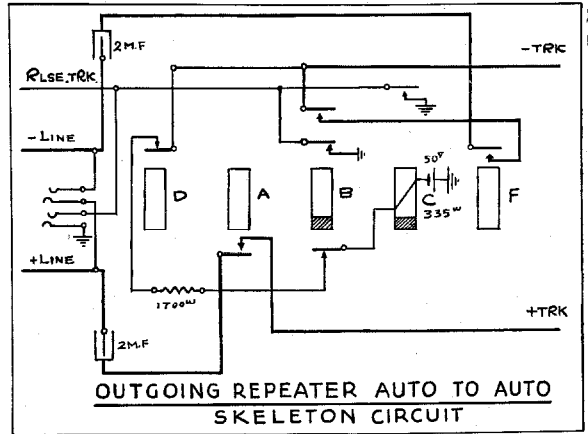

Figure 15a

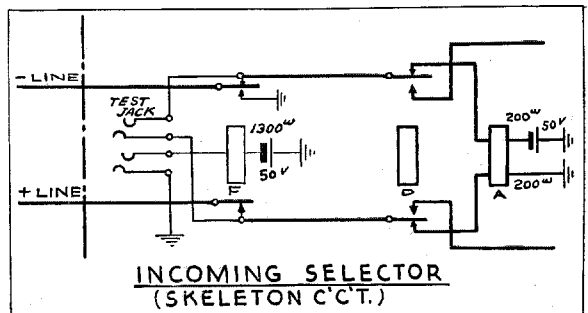

Figure 15b

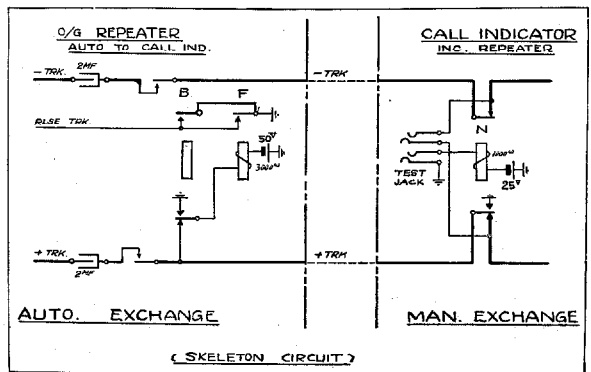

Figure 15c

One is used for drying the air and the other will go under recovery of adsole by using the hot air steam with 200°C temperature. The heating device for drying the wetted adsole is used also for heating in winter time. So, with adsole equipment, it is also possible to get cool in summer and warm in winter in addition to drying air.

TABLE 29. (1)
Modification of A. E. I. Call Indicator

| No. | Before Modification | After Modification | Reasons for Modifications |
|-----|--|--|---|
| 1 | Ringling current is sent out when any trunk circuit is plugged in. | Ringling current is sent out only when assigned trunk line is plugged in. | It is not practicable to send ringling current by the error in choosing plug. |
| 2 | The trunk is made busy during the hunting of idle recorder by recorder finder. | The trunk is free during this period and busy back tone will be sent out to calling side if the impulse comes from calling side during the hunting period. | To increase the efficiency of trunk line. |
| 3 | One recorder is used for spare. The rest of the recorders are available for connection in ordinary cases. If all these recorders are used, all incoming trunks for this position become busy. In this case the spare recorder is used for the trunk which is in hunting for idle recorder. | All recorders are available for connection and all trunks become busy in case of all recorders busy. | To increase the availability of recorder equipment. |
| 4 | Disconnect lamp lights momentarily when the plug of assigned trunk is plugged in. | This phenomenon is eliminated. | To eliminate this unnecessary phenomenon. |

TABLE 29. (2)
Modification of S. H. Call Indicator Equipments

| No. | Before Modification | After Modification | Reasons for Modifications |
|-----|---|--|--|
| 1 | Voltage of battery for talking current supply is 60 volts. | Changed from 60 volts to 24 volts. | To use ordinary C. B. telephone sets for manual subscribers. |
| 2 | Busy test for called party is made automatically by plugging into the multiple jack. At this time the sleeve circuit is opened momentarily. | Busy test is made by click test. | To avoid double connection which may occur in case the sleeve circuit is opened. |
| 3 | The plug is plugged into busy back jack if the called party is busy. | Busy key is equipped. | To get easy handling of operator. |
| 4 | One lamp is used both for assignment and disconnection signals. | Assignment lamp and disconnect lamp are equipped separately. | To distinguish the various incomplete calls. |
| 5 | Plug switch is used. | No plug switch. | Plug switch is inconvenient for maintenance. |
| 6 | If called subscriber hangs up the receiver before calling party clears, busy back tone is sent out to calling party and light disconnect lamp at B board. | Arranged for calling party release systems. | The connection will be cut out at B position and it is not the standard practice in manual or automatic to send busy back tone in such a case. |

Miscellaneous

(a) *Reverting Call.* In Strowger area the reverting call shall be completed through reverting call relay group by dialing special number 115. It is undesirable to hold all switches which are used in that connection during the whole conversation time. It is especially uneconomical in the case of long holding time. In Kayabacho office there are about 50 party lines and sometimes the holding time of a few reverting calls is more than one hour. All party line switches in this office were grouped in one special group from which the first selector modified, as shown in Figure 18, will be trunked. If the connection is finished to reverting call relay group (Figure 19), the ringing current will be sent for both parties as in ordinary practice, and if the called party answers, all switches except the first selector will release.

The reverting call switch in the S. H. system

is specially designed for Japan, for there are no party lines in Germany. A and B parties on one party line will be assigned with the same figures for tens and units, differing only in the hundreds. The reverting call connector is equipped for this hundred group and the reverting call can be completed by first choosing the reverting call connector with the special number, then by dialing the tens and units figures of the called party. If the number of party lines becomes too large for one party line group, a second party line group is arranged having a different number in the hundreds figure. In this case one more stage of group selectors is arranged to choose this hundred, and to make the reverting call it is necessary to dial the hundreds, tens, and units figures of the called party besides the special number. If the calling subscriber hangs up his receiver after finishing the dialing, all switches except the reverting call connector

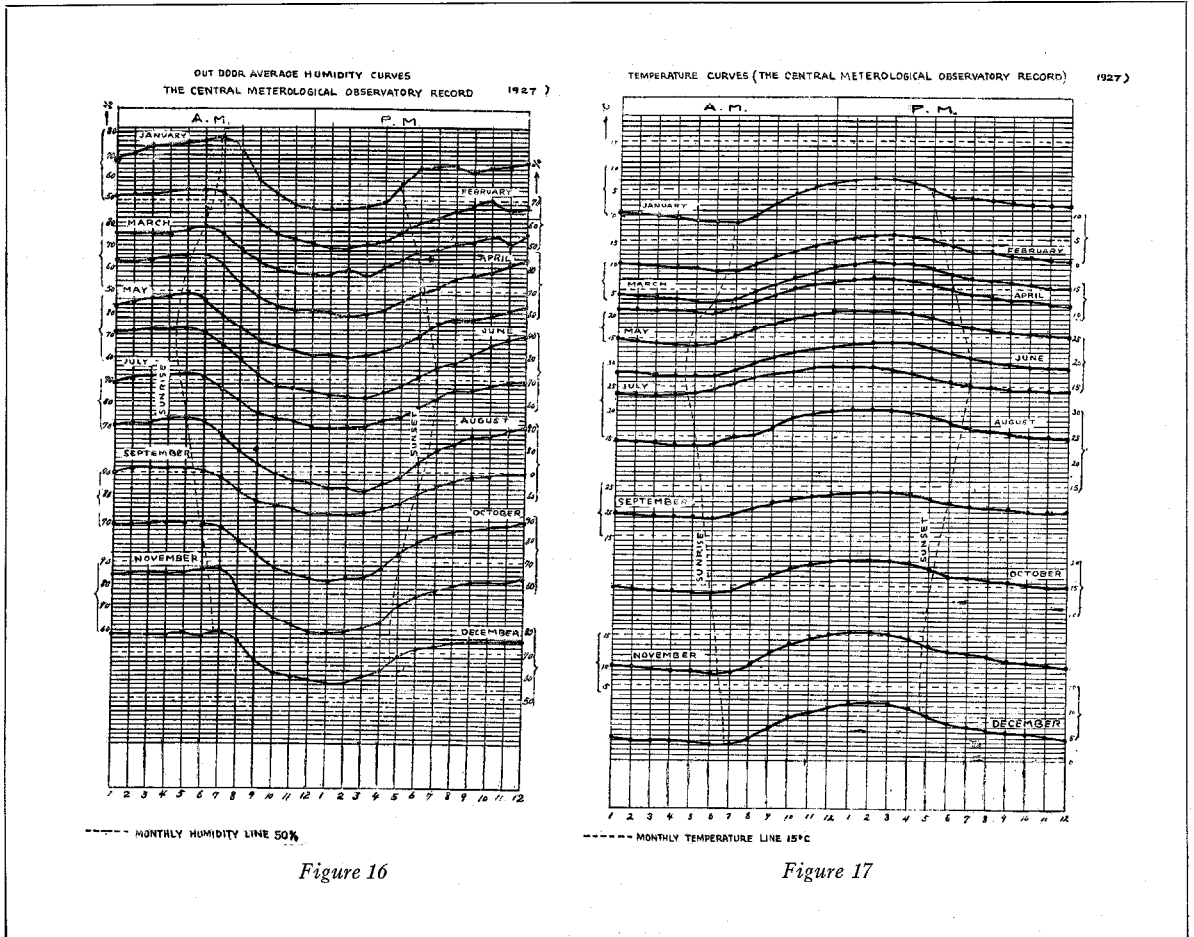

Figure 16

Figure 17

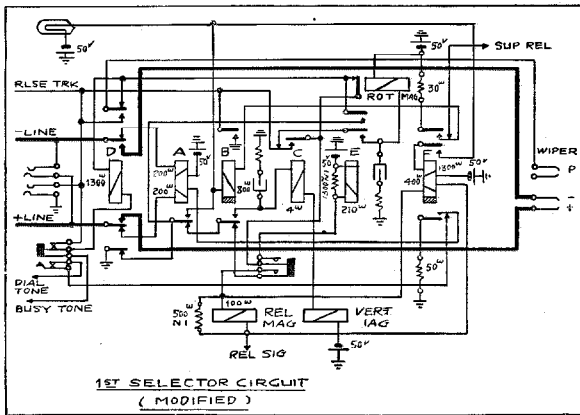

Figure 18

will return to normal and the ringing current will be sent to both parties. The ringing current will cease upon the answer of the called party and the talking current will be supplied from reverting call connector for both parties.

(b) Telephone Sets and Dial. The same transmitter and receiver as used by C.B. manual subscribers are also used in the automatic subscriber.

The normal speed of dial impulse is 10 per second and impulse ratio is 2 open to 1 make (allowable limits are from 1.7 to 2.3 open to 1

make). The minimum pause is more than 0.65 second for B. P. O. No. 10 dial and 0.35 second for No. 24 dial.

(c) Arrangements Against Earthquakes. Not only the arrangements against earthquakes and fire were made for the buildings but also for the equipments in the automatic office. All switchboards are specially designed against earthquakes and all boards and racks are tied together with angle iron to resist the vibrations due to earthquakes. The same care is taken for battery equipment. The buildings are of double window construction and the switching rooms have double doors to make them dust proof.

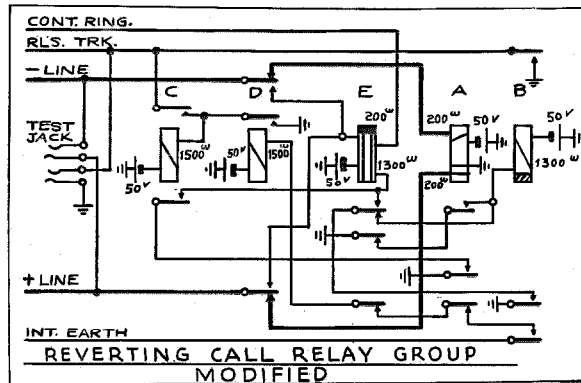
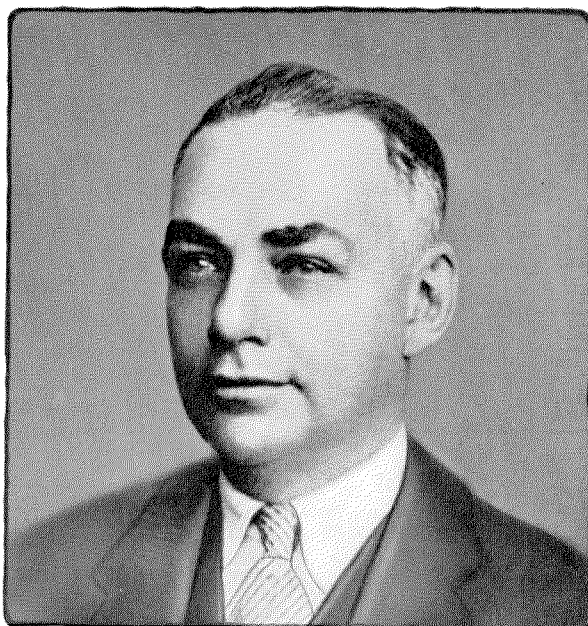

Figure 19



I N M E M O R I A M

IT is with sincere regret that *Electrical Communication* records the death, on July 21, 1930, of Mr. Nat F. Roberts, former Technical Director of the Bell Telephone Manufacturing Company of Antwerp. ¶ Mr. Roberts suffered a stroke of apoplexy on December 19, 1929, resulting in partial paralysis of the left side, while engaged in important work in Milan and remained in the hospital there until May 1st. He was partially recovered and later was taken to Paris and to Baden-Baden where he showed marked improvement. He was returning to America for convalescence and set sail from Antwerp on July 18th; it was while on the return voyage he suffered another severe stroke which caused his death. ¶ Mr. Roberts was a man of pleasing personality and had made many friends in Europe and Asia during his six years abroad. He was born April 28, 1880, in Big Rapids, Michigan, the son of Walter and Lucy Simons Roberts. In early life the family moved to Kendallville, Indiana, where Mr. Roberts was graduated from high school and from which he went to Purdue University, graduating in

1902 in the Electrical Engineering course. All of his business life has been identified with telephone work. He was first employed in the Engineering Department of the Western Electric Company at Chicago and was then transferred to Pittsburgh, Pennsylvania, where he spent five years, later going with the American Telephone and Telegraph Company in New York as Assistant Equipment Engineer. In 1924, he became affiliated with the International Western Electric Company, later the International Standard Electric Corporation, and was sent to Tokyo, Japan, for three years as Acting Chief Engineer of the Nippon Electric Company. In 1927, he became Chief Engineer of the Bell Telephone Manufacturing Company at Antwerp, and Assistant European Chief Engineer, in which capacity he was in charge of the Paris Laboratories of the International Telephone and Telegraph Corporation. ¶ In 1929, he was made Technical Director of the Bell Telephone Manufacturing Company of Antwerp, which position he occupied at the time of his last illness.

His death was a great loss to the Company in which he filled an important place and to the host of friends he had made in the United States, Europe, and Asia.

Some Microphone Measurements and Some Suggestions with Regard to Microphone Arrangements¹

By SIFFER LEMOINE

Chief Engineer of the Swedish Telegraph Administration, Stockholm.

1. Introduction.

AMONG the first requirements for securing high quality radio broadcasting are convenient studio localities and perfect microphones, amplifiers and other associated apparatus.

Apart from the acoustic properties of the studio, and the capability of the microphone to pick up sound waves of different intensity, pitch and timbre, and to transform them into the corresponding electric current impulses for modulating the energy radiated from the transmitting station, there is another requirement, no less important, for attaining a satisfactory result, *i.e.*, the correct disposition of the microphone in relation to those performing in the studio and to the musical instruments used therein.

Even with access to excellent microphones and other associated technical equipment, the quality of the emission may be more or less a failure unless due attention is paid to the right handling of the microphone or microphones.

So far as is known to the author, the problem of microphone disposition has not hitherto been treated in literature, nor has it formed the subject of any close theoretical studies. It has instead been a rule, in practice, to find out by experimental tests in each individual case the microphone position proving audibly most convenient for the moment, and this procedure has been accepted as sufficient.

In connection with the broadcasting activity of the Swedish Telegraph Administration in Stockholm in 1923, certain investigations into this matter were begun. These investigations were partly of a practical nature, and partly they constituted an attempt to attack the mathematical side of the problem.

The viewpoints of which the following is

intended to give a summary account, do not pretend to be more than some suggestions for a solution, and this description is not in itself to be considered as in any way exhaustive or definite.

The results arrived at by applying the principles in question have, however, proved to be of a certain guiding value in practice for the choice of a suitable microphone disposition either in localities outside the studio or when musical entertainment is broadcast from the studio itself, where greater facilities exist with regard to the placing of the microphone.

2. Deduction of Fundamental Formula.

First suppose that a free and parallel incoming wave motion, as shown in Fig. 1, strikes at right angles the microphone diaphragm *A*, likewise freely placed and consisting of a plane surface. Then the sound wave will exercise a certain effect *k* on each and every part of the diaphragm surface *da*.

The total effect on the diaphragm, at each moment, of the wave motion can consequently be written

$$K = \sum k \cdot da \dots \dots \dots (1)$$

If the body emitting the sound is situated, as in Fig. 2, at a finite distance from the microphone diaphragm, it is possible, provided the wave attenuation is neglected, to apply approximately the law of radiation of light, *i.e.*, that the intensity decreases in inverse proportion to the square of the distance.

Since, further, it may be considered that the surface of the diaphragm is so small compared with the distance, that the wave motion strikes all the elementary surfaces of the diaphragm at

¹ Editor's Note: This article is reprinted by kind permission of *Teknisk Tidskrift*.

practically the same angle of incidence, the magnitude of the effect on the diaphragm f can be written

$$f = \frac{c}{d^2} \int k \cdot da \dots \dots \dots (2)$$

Finally, in the case where the diaphragm is turned at an arbitrary angle α (less than 90°) to the direction of the incoming wave motion (Fig. 3), the factor k per surface element of the diaphragm will, because of the oblique position

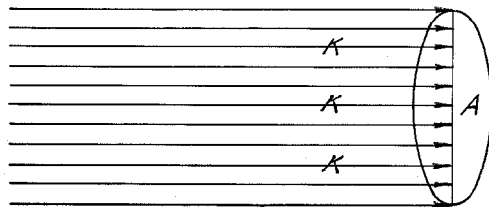

Figure 1

of the surface, be reduced by the factor $\cos \alpha$ to $k \cdot \cos \alpha$. At the same time, the effective diaphragm surface itself is reduced by the same factor, so that the total effect becomes

$$f = \frac{c}{d^2} \cos^2 \alpha \int k \cdot da \dots \dots \dots (3)$$

It may be observed with regard to the factor k that although this is certainly a force operating upon the various surface elements of the diaphragm, the microphone effect it produces may, nevertheless, be different at different

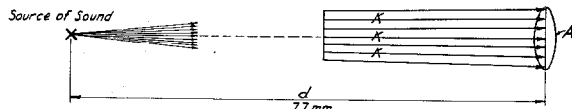

Figure 2

points of the diaphragm—for instance, at its centre and at its periphery.

However, when viewing the matter in that way, it is not necessary to be acquainted with the function underlying the variation of the diaphragm effect, since, for one and the same microphone, it constitutes one and the same characteristic curve.

If for completeness there is introduced into equation (3) instead of k the expression $f(k)$

to designate the characteristic of the diaphragm, the equation assumes after integration the general form

$$f = c \cdot f(K) A \frac{\cos^2 \alpha}{d^2} \dots \dots \dots (4)$$

where c is a constant and A the surface of the diaphragm.

By transcribing, the equation can be simplified as follows:

$$f = B \frac{\cos^2 \alpha}{d^2} \dots \dots \dots (5)$$

where B is a constant.

The fundamental novelty of this is that due regard is paid as well to the varying effect of the sound waves on the diaphragm, in the case of a variable angle of incidence, as to the distance of the microphone from the source of sound.

Before entering further into the conclusions to be drawn from this mode of investigation, it is proposed to give an account of certain

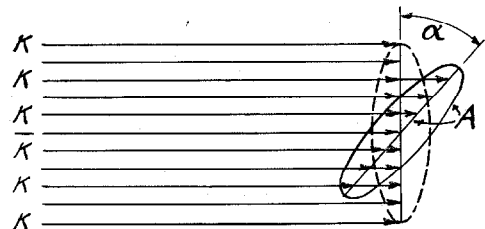

Figure 3

researches to ascertain whether and to what extent the formula, deduced in a purely theoretical way, can be expected to correspond with practical conditions.

3. Account of measurements concerning the magnitude of diaphragm effect when the angle of incidence is variable.

(a) First series of measurements.

These investigations concerned in the first place the variations of the diaphragm effect due to different angles of incidence of incoming wave motions from a source of sound of constant intensity. To this end, the arrangement shown in Fig. 4 was employed.

A denotes the source of sound consisting, on the various occasions of measurements, of an

electrical tuning fork, a motor-driven organ pipe, or a sounder placed in front of a cardboard tube B, 150 cm. long, and having an internal diameter of 8.5 cm. Across the studio was suspended a fairly thick woollen drapery, covering all the space between floor and ceiling, and through this drapery the cardboard tube was moved, fitting closely to the cloth. In front of the second mouth of the tube was placed the microphone, together with devices for continuous rotation and for angle measurements. The effect of the sound waves on the diaphragm was read on a sensitive galvanometer connected

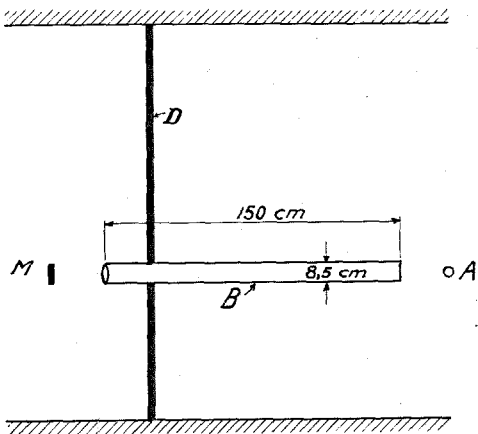

Figure 4

in series with the detector of an amplifier inserted behind the microphone. Microphone current and amplification were maintained constant during the measurements.

In the course of the operations, the microphone was gradually turned from 0 (at right angles to the direction of the incoming wave motion) to 90 degrees, and simultaneously the galvanometer deflections were read. To verify the influence of waves from the source of sound coming in through the drapery or by other paths, the magnitude of this correction was examined at the beginning of each series of measurements with the front mouth of the tube closed, and with various angular positions of the microphone. Before every experiment, the intensity of the background noise at the frequency applied in the individual case was likewise measured.* For all these experiments, the Western Electric carbon microphone, with stretched diaphragm, was utilized.

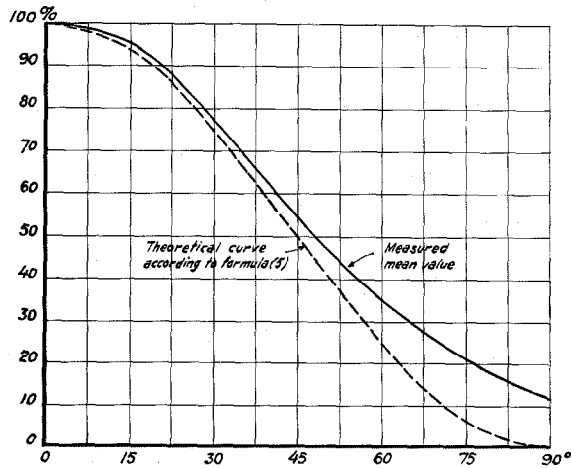

Figure 5

In every series, a great number of measurements were carried out, the microphone being successively turned from 0 to 90 degrees and then back again to the initial position. As a rule, repeated measurements have given but slightly diverging results, and for this reason only a few series, characteristic of various kinds of sources of sound and frequencies, have been included in the Tables 1-3.

As is obvious from the Tables, the drapery has not perfectly shielded the source of sound from the microphone, but has let through part of the sound, the correction for which is highest for the organ pipe with its primarily greatest volume of sound, less for the tuning fork, and least for the sounder. On the contrary, in pro-

TABLE 1.

Source of sound: tuning fork. Frequency $n=50$.
Correction for leakage of sound 3.5, for background noise 1.5 scale divisions.

| Microphone angle α° | Galvanometer reading, in scale divisions | Corrected galvanometer reading | | Value calculated according to formula (5) in per cent |
|---------------------------------|--|--------------------------------|-------------|---|
| | | In scale divisions | In per cent | |
| 0 | 58 | 53 | 100 | 100 |
| 15 | 57 | 52 | 98.2 | 93.3 |
| 30 | 47 | 42 | 79.3 | 75 |
| 45 | 36 | 31 | 58.5 | 50 |
| 60 | 27 | 22 | 41.5 | 25 |
| 75 | 19 | 14 | 26.4 | 6.7 |
| 90 | 12 | 7 | 13.2 | 0 |

*In all cases where a Western Electric microphone is referred to, it should be noted that this is an equivalent of Standard Electric No. 4010.

TABLE 2.
Source of sound: organ pipe. Frequency $n=800$.
Correction for leakage of sound 7.5, for background noise 0.5 scale divisions.

| Microphone angle α° | Galvanometer reading in scale divisions | | | Corrected galvanometer reading in scale divisions | | | Average value in per cent | Value calculated according to formula (5) in per cent |
|---------------------------------|---|------|------|---|------|------|---------------------------|---|
| | Number of measurement | | | Number of measurement | | | | |
| | 1 | 2 | 3 | 1 | 2 | 3 | | |
| 0 | 62.5 | 59.5 | 72.5 | 54.5 | 51.5 | 64.5 | 100 | 100 |
| 15 | 60.0 | 54.5 | 69.0 | 52.0 | 46.5 | 61.0 | 93.4 | 93.3 |
| 30 | 49.5 | 51.5 | 61.0 | 41.5 | 43.5 | 53.0 | 81.0 | 75.0 |
| 45 | 40.5 | 38.5 | 45.5 | 32.5 | 30.5 | 37.5 | 59.1 | 50.0 |
| 60 | 30.5 | 30.0 | 34.5 | 22.5 | 22.0 | 26.5 | 41.7 | 25.0 |
| 75 | 23.0 | 19.5 | 23.0 | 15.0 | 11.5 | 15.0 | 24.4 | 6.7 |
| 90 | 16.0 | 15.5 | 17.5 | 8.0 | 7.5 | 9.5 | 14.6 | 0 |

portion as the intensity of the source of sound has diminished, increase of amplification has been required, thus involving relative increase of background noise.

The results of the measurements are indicated in the Tables both in scale divisions read off,

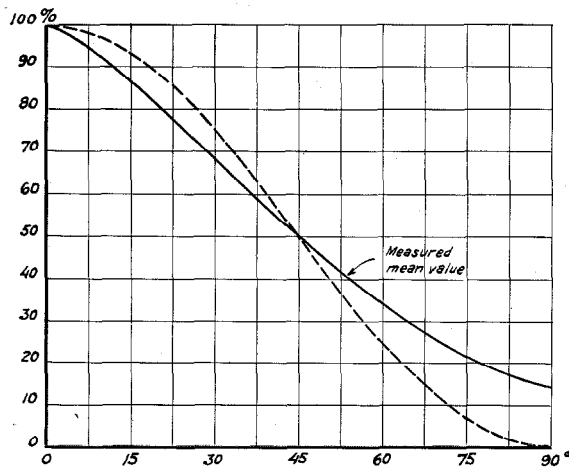

Figure 6

and in percentage values. The results obtained for the organ pipe and the tuning fork show almost complete coincidence, whereas the sounder measurements give altogether lower values. In Fig. 5 has been drawn a curve corresponding to the average value of the three series measured as well as a theoretical curve calculated according to formula (5).

If the two curves are compared, it is found that the former lies higher throughout, a fact due to the properties of the studio where the measurements were made. On the wall was pro-

vided only one single layer of thin curtain cloth. This was not sufficiently damping, and has permitted a certain amount of reflexion. This circumstance accounts for the comparatively great divergence of the curve measured from the theoretical zero value in the 90° position, and also for the better coincidence arrived at in the case of measurements with smaller sound volume.

(b) *Measurements without shielding*

The experiments described above are without doubt of certain interest in themselves, and could, if repeated in a more adequately damped room with more effective shielding facilities, be arranged to give results approaching more nearly

TABLE 3.
(a) Source of sound: sounder. Frequency $n=500$.
Correction for leakage of sound 1, for background noise 9 scale divisions.

(b) Source of sound: sounder. Frequency $n=1200$.
Correction for leakage of sound 1, for background noise 17 scale divisions.

| Microphone angle α° | Galvanometer reading in scale divisions | | Corrected galvanometer reading in scale divisions | | Average value in per cent | Value calculated according to formula (5) in per cent |
|---------------------------------|---|----|---|----|---------------------------|---|
| | a | b | a | b | | |
| 0 | 64 | 72 | 54 | 54 | 100 | 100 |
| 15 | 63 | 69 | 53 | 51 | 96.3 | 93.3 |
| 30 | 46 | 57 | 36 | 39 | 69.4 | 75.0 |
| 45 | 37 | 44 | 27 | 26 | 49.1 | 50.0 |
| 60 | 23 | 30 | 13 | 12 | 23.1 | 25.0 |
| 75 | 19 | 24 | 9 | 6 | 13.9 | 6.7 |
| 90 | 15 | 22 | 5 | 4 | 8.3 | 0 |

to the theoretical curve than is here the case. Since, however, such measurements yield comparatively little evidence upon the question whether the formula justifies its practical application, no further experiments of this kind have been performed.

The next phase of the investigations had, instead, for its aim, the determination of the variations of diaphragm effects in the same studio, with the drapery removed from between the source of the sound and the microphone, *i.e.*, with the sound waves striking directly the microphone diaphragm.

A great number of measurements were carried out in this case, but for considerations of space only a few have been included in Tables 4 and 5. The results were obtained in the same way as before, partly with successive rotation of the microphone from 0 to 90 degrees and back again to the zero point, partly by varying the distance between the source of sound and the microphone. Each series of measurements comprises a number of observations made without changing the microphone position. The average value of these observations has then been computed. The column to the right in the Tables contains the averages in per cent of all the series of measurements, and all these values are also plotted in Fig. 6, as a function of the angle of rotation. Correction for background noise has been neglected.

With a view to ascertaining whether more or less damping in the studio would affect the results, draperies were put up, both single and double, to reduce the reflexion from the wall behind the source of sound. A perceptible,

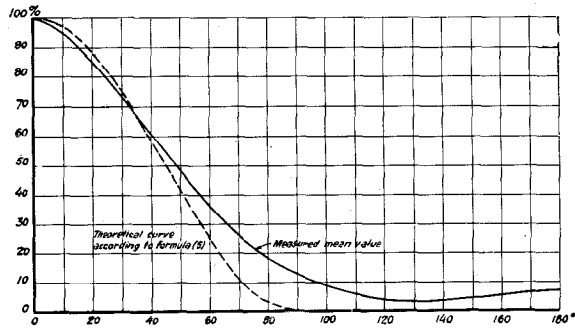

Figure 7

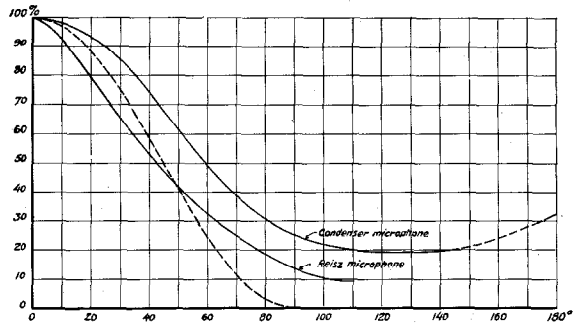

Figure 8

though not very important, difference was thereby noticed.

Further, a number of measurements were carried out where the microphone was turned successively from 0 to 180 degrees. The results of these are brought together in Table 5 and Fig. 7.

It is obvious from these that the diaphragm effect decreases continuously up to 135 degrees, after which a slight increase appears—most probably due to the influence of increased reflexion.

TABLE 4.

Microphone: Western Electric carbon microphone.
Source of sound: Organ pipe, frequency $n=800$; d in centimeters.

| Microphone angle α° | Galvanometer reading: (a) in scale divisions, (b) in per cent | | | | | | | | | | | | Average value in per cent |
|---------------------------------|---|------|------|------|-------|------|-------|------|-------|------|-------|------|---------------------------|
| | d=35 | | d=50 | | d=106 | | d=191 | | d=259 | | d=285 | | |
| | a | b | a | b | a | b | a | b | a | b | a | b | |
| 0 | 64.4 | 100 | 60.9 | 100 | 54.5 | 100 | 46.2 | 100 | 61.8 | 100 | 54.4 | 100 | 100 |
| 15 | 55.2 | 85.7 | 51.6 | 84.7 | 48.5 | 89.0 | 39.5 | 85.5 | 52.2 | 84.5 | 47.2 | 86.8 | 86.0 |
| 30 | 41.4 | 64.3 | 39.0 | 64.0 | 39.3 | 72.1 | 34.4 | 74.5 | 39.2 | 63.4 | 41.0 | 75.4 | 69.0 |
| 45 | 27.7 | 43.0 | 26.0 | 42.7 | 28.6 | 52.5 | 22.9 | 49.6 | 30.6 | 49.6 | 31.1 | 59.0 | 49.4 |
| 60 | 18.0 | 28.0 | 16.8 | 27.6 | 20.8 | 38.2 | 16.3 | 35.3 | 22.6 | 36.6 | 23.0 | 42.3 | 34.7 |
| 75 | 11.2 | 17.4 | 11.1 | 18.2 | 13.4 | 24.6 | 10.8 | 23.4 | 13.8 | 22.3 | 13.7 | 25.2 | 21.8 |
| 90 | 8.1 | 12.6 | 9.0 | 14.8 | 7.9 | 14.5 | 7.2 | 14.9 | 9.0 | 14.6 | 7.9 | 14.5 | 14.3 |

TABLE 5.
Microphone: Western Electric carbon microphone.
Source of sound: Organ pipe, frequency $n=800$; d in centimeters.

| Microphone angle α° | Galvanometer reading: (a) in scale divisions, (b) in per cent | | | | | | | | Average value in per cent |
|---------------------------------|---|------|-------|-------|-------|------|-------|------|---------------------------|
| | d=256 | | d=260 | | d=413 | | d=413 | | |
| | a | b | a | b | a | b | a | b | |
| 0 | 52 | 100 | 49 | 100 | 34 | 100 | 64 | 100 | 100 |
| 15 | 44 | 84.6 | 43 | 87.8 | 31 | 91.2 | 57 | 89.1 | 88.2 |
| 30 | 38 | 73.1 | 37 | 75.5 | 25 | 73.5 | 47 | 73.4 | 73.9 |
| 45 | 27 | 51.9 | 27 | 55.1 | 19 | 55.9 | 33 | 51.6 | 53.6 |
| 60 | 20 | 38.5 | 17 | 34.7 | 13 | 38.2 | 22 | 34.4 | 36.4 |
| 75 | 10 | 19.2 | 10 | 20.4 | 8 | 23.5 | 15 | 23.4 | 21.6 |
| 90 | 6 | 11.5 | 7 | 14.3 | 4.5 | 13.2 | 9 | 14.1 | 13.3 |
| 105 | .. | .. | .. | .. | 2.5 | 7.4 | 4.5 | 7.0 | 7.2 |
| 120 | 3 | 5.8 | 7.5 | 15.3* | 1.0 | 2.9 | 2.0 | 3.1 | 3.6 |
| 135 | .. | .. | .. | .. | 1.2 | 3.5 | 2.2 | 3.4 | 3.5 |
| 150 | .. | .. | .. | .. | 1.5 | 4.4 | 2.6 | 4.1 | 4.3 |
| 165 | .. | .. | .. | .. | 1.6 | 4.7 | 2.8 | 4.4 | 4.6 |
| 180 | 4 | 7.7 | 16 | 32.7* | 2.2 | 6.5 | 3.4 | 5.3 | 6.5 |

*Not included in the average value.

(c) *Angle measurements for various types of microphones.*

All the measurements described in the foregoing have been made by means of carbon microphones with stretched diaphragm of Western Electric manufacture.

To investigate also the properties of other types of microphones in this respect, experiments were performed, under conditions otherwise identical, with a condenser microphone, and later (in 1928) with a Reisz microphone. The measured values thus obtained are to be found in Tables 6 and 7, and graphically, in Fig. 8.

As regards the results, it may be stated that the condenser microphone, as was to be expected, gives a curve which, owing to the greater sensitiveness of this microphone, lies altogether higher than that resulting from the carbon microphones.

(d) *Measurements in different studio localities.*

With the exception of the measurements on the Reisz microphone represented in Table 7, all the tests were carried out in the studio constructed in 1923, in the Telegraph College, Stockholm.

In order to ascertain whether studio rooms of different construction and different damping (different reverberation time) would exercise any effect on the results of the measurements,

similar experiments were arranged in the new studio rooms of the Swedish Radio Service in Stockholm. The measurements represented in Table 7 were made in the small studio on those premises, those represented in Table 8 in the large studio. The average values of the last mentioned measurements comprising distances of up to 3.5 metres are given in Fig. 9.

(e) *Summary.*

Examination of Figs. 6-9 shows that there is comparatively close agreement between the curves measured and those theoretically calculated. Owing to the acoustic conditions, it was

TABLE 6.
Microphone: Western Electric condenser microphone.
Source of sound: Organ pipe, frequency $n=800$; d in centimeters.

| Microphone angle α° | Galvanometer reading | | | | Average value in per cent |
|---------------------------------|----------------------|-------------|--------------------|-------------|---------------------------|
| | d=44.5 | | d=47. | | |
| | in scale divisions | in per cent | in scale divisions | in per cent | |
| 0 | 55 | 100 | 62.8 | 100 | 100 |
| 15 | 53.1 | 96.5 | 58.8 | 93.6 | 95.0 |
| 30 | 47.6 | 86.5 | 54.4 | 86.6 | 86.5 |
| 45 | 37.6 | 68.4 | 42.0 | 66.9 | 67.6 |
| 60 | 25.3 | 46.0 | 31.8 | 50.6 | 48.3 |
| 75 | 18.9 | 34.4 | 21.9 | 34.9 | 34.6 |
| 90 | 14.9 | 27.1 | 14.3 | 22.8 | 25.0 |
| 120 | 13.1 | 23.8 | 9.6 | 15.3 | 19.5 |
| 180 | 21.3 | 38.7 | 16.8 | 26.8 | 32.7 |

TABLE 7.
Microphone: Reisz carbon microphone.
Source of sound: Organ pipe, frequency $n=1,000$; d in centimeters.

| Microphone angle α° | Galvanometer reading: (a) in scale divisions, (b) in per cent | | | | | | Average value in per cent | | | | | | |
|---------------------------------|---|------|-------|------|-------|------|---------------------------|-------|------|-------|------|-------|------|
| | d=230 | | d=254 | | d=300 | | | d=400 | | d=450 | | d=502 | |
| | a | b | a | b | a | b | | a | b | a | b | a | b |
| 0 | 75 | 100 | 55.2 | 100 | 54.0 | 100 | 60.7 | 100 | 59.6 | 100 | 72.0 | 100 | 100 |
| 15 | 52.5 | 70.0 | 43.7 | 79.2 | 43.3 | 83.3 | 47.3 | 78.0 | 47.4 | 79.6 | 60.3 | 83.7 | 79.0 |
| 30 | 38.8 | 51.7 | 35.0 | 63.4 | 32.6 | 60.3 | 39.6 | 65.2 | 33.0 | 55.3 | 55.0 | 76.3 | 62.0 |
| 45 | 30.1 | 40.2 | 26.0 | 47.2 | 21.0 | 38.9 | 31.2 | 51.4 | 23.9 | 40.2 | 45.2 | 62.8 | 46.8 |
| 60 | 24.0 | 32.0 | 17.7 | 32.1 | 14.2 | 26.3 | 21.5 | 35.4 | 14.0 | 23.5 | 30.6 | 42.5 | 32.0 |
| 75 | 17.0 | 22.7 | 13.2 | 23.9 | 10.2 | 18.9 | 15.7 | 25.8 | 9.4 | 15.8 | 19.7 | 27.3 | 22.4 |
| 90 | 11.6 | 15.5 | 8.7 | 15.7 | 7.3 | 13.5 | 8.0 | 13.2 | 6.6 | 11.1 | 9.7 | 13.4 | 13.7 |
| 105 | 6.6 | 8.8 | 4.0 | 7.2 | 6.5 | 12.0 | 5.0 | 8.2 | 7.6 | 12.7 | 6.5 | 9.0 | 9.6 |

TABLE 8.
Microphone: Reisz carbon microphone.
Source of sound: Organ pipe, frequency $n=1,600$; d in centimeters.

| Microphone angle α° | Galvanometer reading (a) in scale divisions, (b) in per cent | | | | | | Average value in per cent | | | | | | |
|---------------------------------|--|------|-------|------|-------|------|---------------------------|-------|-----|-------|-----|-------|------|
| | d=225 | | d=250 | | d=270 | | | d=285 | | d=290 | | d=340 | |
| | a | b | a | b | a | b | | a | b | a | b | a | b |
| 0 | 85 | 100 | 127 | 100 | 110 | 100 | 140 | 100 | 188 | 100 | 128 | 100 | 100 |
| 15 | 75 | 88.2 | 110 | 86.6 | .. | .. | 121 | 86.4 | 154 | 81.9 | 112 | 87.5 | 86.1 |
| 30 | 54 | 63.5 | 88 | 69.3 | 81 | 73.6 | 83 | 59.3 | 115 | 61.2 | 88 | 68.7 | 65.9 |
| 45 | 41 | 48.2 | 70 | 55.1 | 57 | 51.8 | 50 | 35.7 | 79 | 42.0 | 68 | 53.1 | 47.7 |
| 60 | 26 | 30.6 | 50 | 39.4 | 40.5 | 36.8 | 31 | 22.1 | 48 | 25.5 | 44 | 34.4 | 31.5 |
| 75 | 18 | 21.2 | 36 | 28.3 | 29 | 26.3 | 24 | 17.1 | 35 | 18.6 | 27 | 21.1 | 22.1 |
| 90 | 15 | 17.7 | 20 | 15.8 | 16 | 14.5 | 20 | 14.3 | 26 | 13.8 | 19 | 14.8 | 15.1 |
| 105 | 12 | 14.1 | 12 | 9.5 | ... | ... | 17 | 12.1 | 22 | 11.7 | 22 | 17.2 | 12.9 |
| 120 | 13 | 15.3 | 15.5 | 12.2 | ... | ... | 12 | 8.6 | 28 | 14.9 | ... | ... | 12.7 |

not to be expected that curves absolutely coinciding with each other would be obtained. Because of reflexion from ceiling and walls, the microphone diaphragm is affected not only by the direct sound waves, but also by the reflected waves, and this holds especially in the case of a big angle of incidence.

Within the range 0-60 degrees, where the microphones usually are placed, the differences are small enough to permit the assumption of full applicability of the formula (5). Differentiation of sound intensity from instruments of an orchestra can of course not be done with greater exactitude than that mentioned here, nor is the human ear sufficiently sensitive to apprehend differences of this order of magnitude.

The conclusions to be drawn from the above-mentioned measurements are consequently, in the first place, that the angular position of the microphone with regard to a certain source of

sound is a factor not to be neglected when radio programmes are being picked up, and that an approximate expression for the magnitude of the diaphragm effect can be derived, involving the square of the cosine of the angle of incidence of the sound waves. The further applications of this formula to practical cases will be treated in what follows.

4. Measurements concerning the magnitude of the diaphragm effect at varying distances.

The next step in the investigation comprised a number of measurements with a view to ascertaining the variations of the diaphragm effect at varying distances between the microphone and the source of sound. All the tests were carried out in the large studio of the Radio Service in Stockholm.

During the measurements, the microphone (which in cases 2 and 5 in Table 9 was the source of sound) was moved, and simultaneously a galvanometer connected to the amplifier circuit was read off. Double observations, of which only the averages are included in the Tables below, were made in the case of moving the microphone in the direction towards and from the source of sound.

If Table 9, with the curves appertaining thereto, is first examined, it is found that comparatively close—for measurement number 7 almost complete—agreement is obtained between theoretical and measured values. But here, and still more in the case of the latter series, there appears a tendency for the measured values to become—when the distance between microphone and source of sound has reached a certain limit—nearly constant and

TABLE 9.
Microphone measurements at variable distance.
Microphone: Reisz carbon microphone.
Source of sound: Organ pipe, frequency = 1,600.

| Dis- tance d cm. | Galvanometer reading | | | | | | | |
|------------------------|----------------------|------|------|------|-------|------|------|-------|
| | nr 1 | nr 2 | nr 3 | nr 4 | nr 5 | nr 6 | nr 7 | nr 8 |
| 25 | 54 | 65 | 88 | 97.3 | 137.5 | 150 | 169 | |
| 30 | 42 | 60 | 76 | 81.3 | 117.5 | 126 | 149 | |
| 35 | 30 | 37.5 | 46 | 53.3 | 73 | 84 | 104 | |
| 40 | 21 | 27 | 29 | 31.3 | 63.5 | 44 | 87 | 182 |
| 45 | 12 | 22 | 19 | 22.0 | 45 | 35 | 62 | 153 |
| 50 | 11 | 14 | 17.9 | 22.3 | 35.5 | 38 | 44 | 135.5 |
| 55 | 7 | 12.5 | 10.2 | 12.9 | 32.5 | 21.6 | 48 | 101.5 |
| 60 | 5.7 | 6.8 | 11.9 | 11.6 | 18.0 | 17.2 | 31 | 107 |
| 65 | 5.4 | 7.7 | 10.2 | 10.1 | 18.0 | 14.7 | 26 | 91 |
| 70 | 5.3 | 8.8 | 7.7 | 7.8 | 19.0 | 10.4 | 27 | 79.5 |
| 75 | 3.9 | 7.4 | 8.2 | 8.5 | 17.2 | 13.4 | 24 | 75.5 |
| 80 | 3.4 | 5.0 | 5.7 | 6.8 | 11.1 | 11.4 | 15.7 | 69 |
| 85 | 4.9 | 4.8 | 5.2 | 5.8 | 9.7 | 7.3 | 15.1 | 66.5 |
| 90 | 2.4 | 5.4 | 3.1 | 3.8 | 13.1 | 5.9 | 15.4 | 51 |
| 95 | 2.6 | 5.7 | 3.8 | 4.6 | 15.8 | 7.5 | 18.0 | 50 |
| 100 | 2.4 | 5.6 | 2.6 | 4.6 | 15.4 | 8.8 | 21.2 | 40.5 |

to assume higher values than those obtained from formula (5). Likewise the measured values become more irregular compared with the theoretical curves than was the case for the angle measurements. These two circumstances are without doubt to be attributed to the acoustic properties of the studio, and are due to reflexion or to influence from standing wave motions.

For the first series of measurements, the source of sound was an organ pipe, with a frequency of about 1,600 cycles. The values measured on

this occasion are grouped in Table 9, and are represented graphically in Fig. 10, where, for comparison, also have been inserted some curves calculated from formula (5), and giving values inversely proportional to the square of distance.

In order to obtain higher intensity of sound when measurements were carried out at greater distances, the organ pipe was in the second series replaced by a vacuum tube oscillator, and an electrodynamic loudspeaker. These measurements were made at distances of up to 3 metres, and are recorded in Table 10 and Fig. 11.

TABLE 10.
Microphone measurements at varying distance.
Microphone: Reisz carbon microphone.
Source of sound: Loudspeaker, frequency = 270.

| Dis- tance d cm. | Galvano- meter reading | | Dis- tance d cm. | Galvano- meter reading | | Dis- tance d cm. | Galvano- meter reading | |
|------------------------|------------------------------|------|------------------------|------------------------------|------|------------------------|------------------------------|------|
| | nr 1 | nr 2 | | nr 1 | nr 2 | | nr 1 | nr 2 |
| 15 | ... | 137 | 115 | 16.7 | 2.8 | 215 | ... | 1.8 |
| 20 | ... | 102 | 120 | 16.3 | 2.6 | 220 | ... | 2.0 |
| 25 | ... | 77 | 125 | 15.2 | 2.4 | 225 | ... | 2.1 |
| 30 | 158.5 | 54 | 130 | 15.0 | 2.3 | 230 | ... | 2.1 |
| 35 | 143.5 | 40 | 135 | 13.0 | 2.2 | 235 | ... | 2.0 |
| 40 | 128 | 31 | 140 | 9.4 | 2.4 | 240 | ... | 2.0 |
| 45 | 97.5 | 25 | 145 | 7.1 | 2.5 | 245 | ... | 1.8 |
| 50 | 74.5 | 18.7 | 150 | 5.6 | 2.7 | 250 | ... | 1.7 |
| 55 | 69 | 13.7 | 155 | 4.8 | 2.9 | 255 | ... | 1.5 |
| 60 | 65 | 12.3 | 160 | 4.2 | 2.9 | 260 | ... | 1.2 |
| 65 | 53.5 | 12.1 | 165 | 3.7 | 2.7 | 265 | ... | 1.1 |
| 70 | 43.5 | 11.9 | 170 | 3.3 | 2.6 | 270 | ... | 1.0 |
| 75 | 34.8 | 10.0 | 175 | 2.8 | 2.3 | 275 | ... | 0.9 |
| 80 | 27.0 | 9.6 | 180 | 2.8 | 1.8 | 280 | ... | 0.8 |
| 85 | 20.5 | 9.4 | 185 | 2.8 | 1.5 | 285 | ... | 0.7 |
| 90 | 17.6 | 8.4 | 190 | 2.5 | 1.4 | 290 | ... | 0.6 |
| 95 | 16.0 | 6.6 | 195 | 2.7 | 1.3 | 295 | ... | 0.6 |
| 100 | 14.0 | 5.3 | 200 | 2.6 | 1.4 | 300 | ... | 0.6 |
| 105 | 14.1 | 4.5 | 205 | ... | 1.4 | ... | ... | ... |
| 110 | 15.2 | 3.6 | 210 | ... | 1.5 | ... | ... | ... |

Researches concerning the diaphragm effect as a function of the distance have not been carried out to such an extent as might have been desirable. To get a more complete picture of the conditions discussed, the author intends to pursue the investigations by serial measurements at different frequencies and localities, with different damping.

Although it is possible that by additional measurements a factor may be deduced indicating something other than the quadratic func-

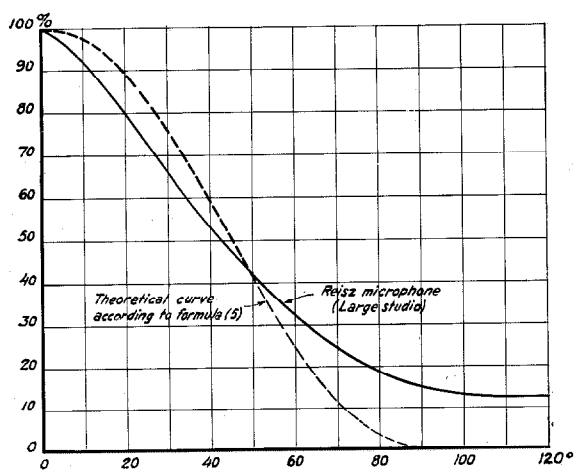

Figure 9

tion from which the author started, it may already be shown that there are some practical applications of formula (5).

5. Some applications of formula (5).

The problem of microphone placing, in general, consists in securing such a position in front of an arbitrary number of simultaneously sounding instruments, for instance an orchestra, that

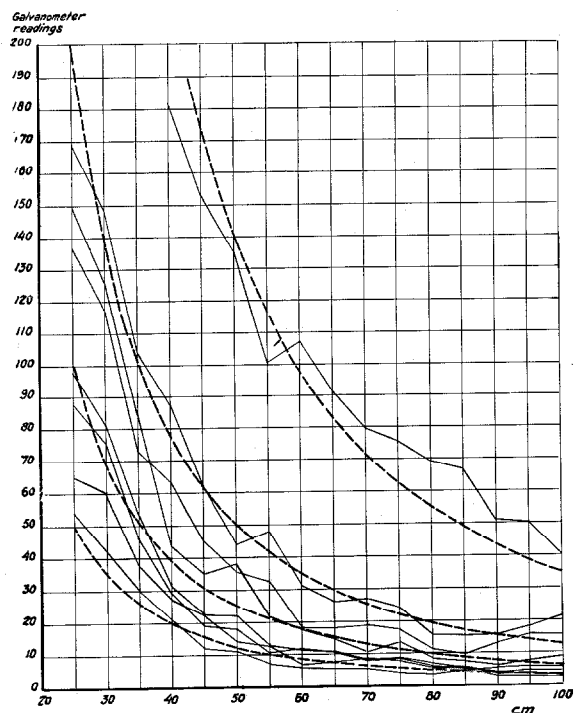

Figure 10

every instrument affects the microphone diaphragm with proportionally the same intensity as that with which the instrument itself sounds,* *i.e.*, that the microphone should be so placed as to take up and reproduce, on a certain reduced scale, an acoustically exact copy of the wave motions emanating from all the instruments. When this is treated mathematically, it implies the simple assumption that any one instrument arbitrarily placed, when sounding with the same intensity, should produce the same diaphragm effect.

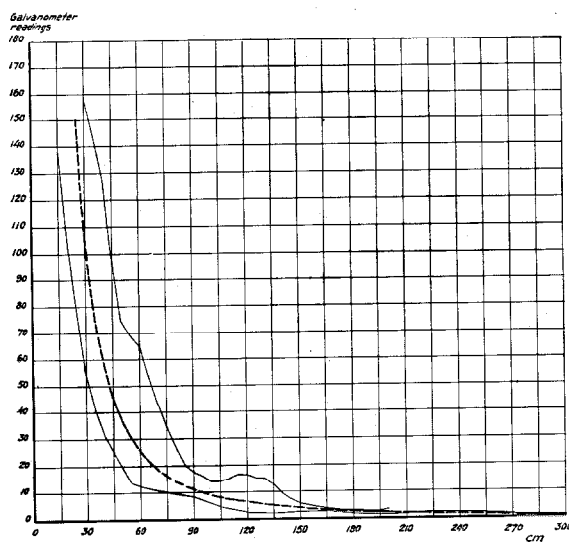

Figure 11

To exemplify this, a few simple applications may be noted.

(a) *Instruments placed along the circumference of a circle with the microphone at its centre.*

Suppose that a number of instruments as indicated in Fig. 12 are placed on the circumference of a circle of radius R , with the microphone at its centre on a level with all the instruments. By applying formula (5) the diaphragm effect of the respective instruments can be calculated. Thereby is obtained the curve A (full line) indicated in the same figure in polar co-ordinates with M taken as the origin, and in which vectors drawn from M represent

*It is, of course, not necessary to assume the instrumental effect to be proportionally the same, but generally only to be in a certain manner mutually balanced. This, however, does not fundamentally alter anything in the present way of viewing the matter.

linearly the relationship between the diaphragm effect of the various instruments.

It is clear, that, from a musical viewpoint, a microphone and an orchestra arranged in this way would reproduce in an extremely distorted manner the music performed by the orchestra.

Conversely, the problem can be formulated thus: Where are the instruments to be placed in order that the effect of each and every one of them shall be proportional to their actual sound intensity. On considering an arbitrary point in the plane situated at the angle α and at the distance r from the origin, there is obtained by application of formula (5) the solution in a simple manner from the condition equation.

$$K \frac{\cos^2 \alpha}{r^2} = K \frac{1}{R^2}$$

$$r = R \cos \alpha \dots \dots (6)$$

Expressed in words, this equation signifies, as is known, a circle of radius $R/2$, and this

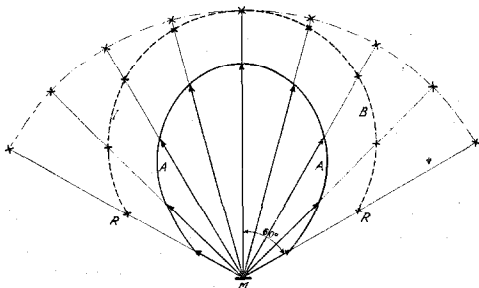

Figure 12

circle is thus the focus of the instrument position required to fulfill the condition of uniform diaphragm effect. The curve is represented in the figure as the dotted line B.

(b) Instruments placed along two axes perpendicular to one another.

In the example of the preceding case, the instrument location may be expressed as a function of the distance R to the microphone independently of the magnitude of the absolute value of the distance. This, on the contrary, cannot generally be done with the arrangement schematically indicated in Fig. 13. For simplicity, there may therefore be chosen a length $2a$ of the two axes $A-B$ and $C-D$ equal to the distance from their point of intersection O to the microphone M .

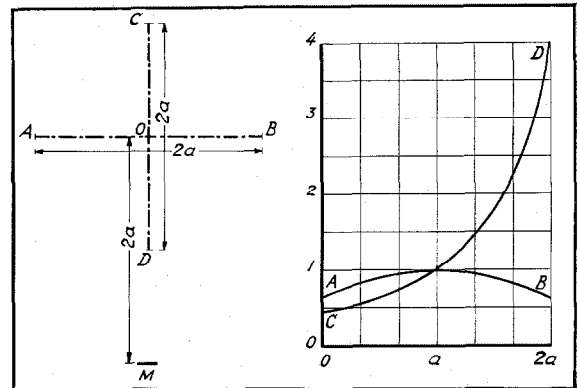

Figure 13

If, assuming the same instrument and microphone level, there is first calculated the diaphragm effect along the axes, and this is put equal to unity for an instrument at the centre point O , the curves represented in the lower part of Fig. 13 are obtained. Along the axis $A-B$ the curve is symmetrically decreasing on each side of the centre point down to a minimum value of 0.64, whereas the diaphragm effect along $C-D$ is continuously increasing from the far end to the near end with initial and final values of 0.44 and 4.0, respectively.

From this it will be obvious that in the case of a location thus assumed, there will inevitably arise a certain distortion of what the microphone takes up and reproduces with regard to intensity and mutual balance of the instruments.

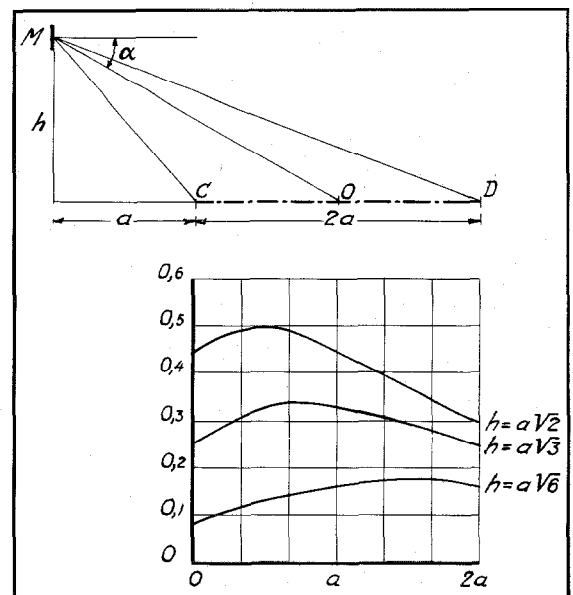

Figure 14

Further, it follows from the preceding case that it is not sufficient merely to put the question how the instruments should be arranged, but the problem includes rather the question how to place the microphone in order that all the instruments should give the same diaphragm effect.

With regard to the axis *A-B* the answer is approximately obtained by applying equation (6). The variations are in this case due to the angle of incidence varying on lateral movement, which can be compensated for by a corresponding reduction of the distance (*vide* Fig. 15).

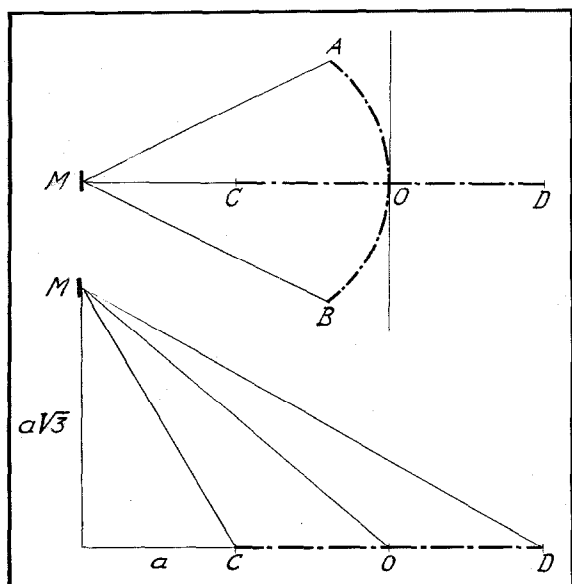

Figure 15

The divergences of the curve along the axis *C-D* are entirely due to the fact that the distances to the microphone alter when an instrument is moved along the axis. This, as will be shown, can be partly compensated for by changing the angle of incidence.

The easiest way of bringing about angular compensation is by vertical dislocation of the microphone. Such dislocation involves, within certain limits, a greater alteration of the angle of incidence in relation to the nearer instruments than to the further ones, and entails corresponding reduction of the magnitude of the diaphragm effect.

In Fig. 14 the microphone is supposed to be placed at a certain height *h* above the level of

the instruments with its horizontal distance to the axis *C-D* remaining unchanged. The requirements for attaining equal diaphragm effect at, say, the points *C, O* and *D* can, according to what has been stated above, be expressed by means of the conditional equations:

$$\text{for } C \text{ and } O: K \frac{a^2}{(a^2+h^2)^2} = K \frac{4a^2}{(4a^2+h^2)^2} \dots (7a)$$

$$\text{for } C \text{ and } D: K \frac{a^2}{(a^2+h^2)^2} = K \frac{9a^2}{(9a^2+h^2)^2} \dots (7b)$$

$$\text{for } O \text{ and } D: K \frac{4a^2}{(4a^2+h^2)^2} = K \frac{9a^2}{(9a^2+h^2)^2} \dots (7c)$$

which, solved with respect to the height *h* of the microphones, give the following values:

$$\text{for } C \text{ and } O: h = a \sqrt{2} \dots (8a)$$

$$\text{for } C \text{ and } D: h = a \sqrt{3} \dots (8b)$$

$$\text{for } O \text{ and } D: h = a \sqrt{6} \dots (8c)$$

Calculated curves indicating the magnitude of the diaphragm effect for the three values of the microphone height obtained from equations (8a)-(8c) are represented in Fig. 14.

Comparison of the curves with each other shows, firstly, that the microphone elevation—at the same time that a reduction throughout of the diaphragm effect of the totality of instruments has taken place—has resulted in considerable equalization. The ratio between the maximum and the minimum values amounts for the planary position to about 9.0, whereas for the last-mentioned position, with equivalence of the points *C* and *D*, the ratio is only 1.3—secondly, that the middle curve represents the relatively smoothest course with the above-mentioned ratio 1.3, compared to the two other ratios, 1.67 and 2.02, respectively.

Further, it results from the solution of the condition equations that it is not possible to attain, by merely vertical dislocation of the microphone, an equal diaphragm effect for all the instruments. This will also not be required in practice. When the acoustic properties of the studio, the capability of the microphone, the approximate validity of the formulæ, and,

still more, the practical difficulty of precise setting or playing the instruments, are considered, the slight difference to be observed here may be left entirely out of account.

The results of the calculations concerning instrument placing along the axis *A-B* and the most favourable microphone position for the axis *C-D* are, as regards the present case, represented in Fig. 15.

(c) General investigations

The microphone location, discussed in (b), constitutes a special case, chosen with a view to show that by elevating the microphone it is possible to effect a change of incoming wave motions, and thus obtain more favourable results than otherwise. On generalizing this problem—a rather complicated matter, owing to such variables as the length of the axes, the elevation of the microphone and its distance to the nearest instrument (microphone distance)—two cases, partly independent of one another, can be distinguished, *viz.*, lateral location of the instruments, along the axis *A-B* or parallel to it, and along *C-D*.

If, in accordance with Fig. 16, the microphone is supposed to be placed at the height *h* above the plane of the instruments, and at the horizontal distance *l*, and if, in a general manner, the question where the instruments should be placed in the plane in order to give equal diaphragm effect is examined, the following condition equation is obtained:

$$\frac{r^2 \cos^2 \nu}{(r^2 + h^2)^2} = \frac{l^2}{(l^2 + h^2)^2}$$

which gives after solution with respect to *r*

$$r = \frac{h}{2} \left[\frac{1}{h} + \frac{h}{1} \right] \left[\cos \nu = \cos^2 \nu - \left(\frac{1}{h} + \frac{h}{1} \right)^2 \dots \dots (9) \right]$$

Examination of this equation shows that the focus of an equivalent location of the instruments for various values of *h/l* is a circle of radius

$$R = \pm \frac{h}{2} \left(\frac{h}{1} - \frac{1}{h} \right) \dots \dots \dots (10)$$

where the sign + applies to values of *h/l* greater

than 1 and the sign - to values less than 1. The centres of the circular lines are situated at the distance $1 \pm R$ for $h/l >$ and $h/l < 1$, respectively.

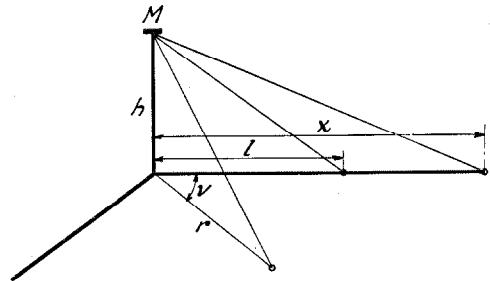

Figure 16

With regard to the root expression of the equation, it may be observed that the condition determined therefrom for obtaining rational values of *r* (the sign - applies when $\nu > 180^\circ$)

$$\frac{1}{h} + \frac{h}{1} > \frac{2}{\cos \nu}$$

constitutes the points where *r* is the tangent to the respective circles.

In Fig. 17 are represented some curves corresponding to different values of *r*. From these it is to be seen that where the microphone elevation is *h=l* there are no more points in

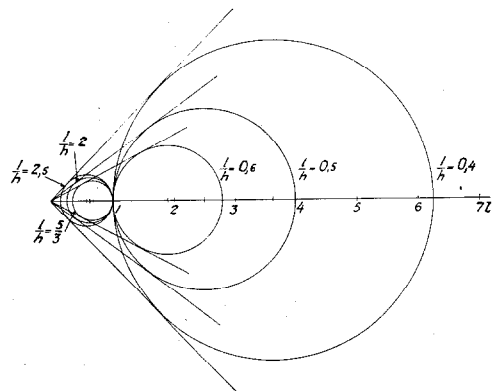

Figure 17

the plane where equal diaphragm effect can be attained. It is seen also that for remaining values of *l/h* this condition is fulfilled only in the case of linear placing laterally.

As regards placing the microphone along the axis *C-D*, it should further be noted, firstly,

that this problem is a special case of the preceding for $\nu=0$; secondly, that equal diaphragm effect can be obtained only at two points situated on the axis.

If $\nu=0$ is inserted in equation (9), and if in accordance with Fig. 16 the designation r is exchanged for x , a solution gives the roots

$$X_1 = \frac{h^2}{1}$$

$$X_2 = 1$$

Transcribing the former root into the form $h^2 = xl \dots \dots \dots (11)$ it is found from this equation, which represents a parabola, that the microphone elevation can easily be calculated at a given value of the microphone distance and of the depth of the orchestra $x-l$.

Of particular interest is an investigation of the variations of the diaphragm effect along the axis. From the general equation it is possible first to determine the point where the diaphragm effect is a maximum, *i.e.*, for $x=h$.

There might be an inclination to assume that the expression for the most favourable microphone elevation would be obtained as the average value of h after integration of equation (11) with respect to the extension of the orchestra. However, this is not the case, and it can be shown that the minimum value of the quotient of maximum and minimum diaphragm effect is obtained in the case of equivalence between the nearest and the furthest instrument, that is at $h = \sqrt{x.l}$. A curve indicating the numerical amount of this minimum value for various depths of the orchestra, expressed as a function of l , is represented in Fig. 18.

(d) *Further calculations concerning the arrangement of orchestras.*

As the preceding investigations show, it is in fact not possible to find, generally, such a position of the microphone, in relation to an orchestra arranged in the same plane, as would give the same diaphragm effect from all the instruments. For correctly chosen arrangements, however, the maximum difference is not greater than to be, within certain limits, negligible in practice.

To illustrate the calculations, a simple case may be taken. Suppose an orchestra, the depth

of which is 8 metres, where the microphone distance to the foremost instrument is $l=2$ metres, then from equation (11) the microphone elevation h may be determined to be about 4.5 metres. According to equation (10), the locus of the instrument position is a circle of radius $r=4$ metres (Fig. 19). If, further, the diaphragm effect along the axes $A-B$ and $C-D$ is calculated, the curves represented in the lower part of the same figure are obtained, with the greatest difference between maximum and minimum amounting to 80 per cent, a value which might still be considered tolerable.

It thus results from the calculations that the instruments may be arbitrarily placed within the circle $ABCD$ without any greater percentage difference arising than is mentioned above.

For practical reasons, not a circular, but rather a quadrilateral position may perhaps be preferred; for instance, within the square figure $FGHI$, whereby at the same time a better average is obtained, as can be seen from the curves.

Finally it may be observed that in the above example, the angle of incidence for the foremost instrument would become, in the case of a circular arrangement, about 66° , whereas the applicability of formula (5) has been previously stated to lie within the range $0-60$ degrees. If the instruments are placed quadrilaterally, this condition is fulfilled. On the other hand, it should be noticed that the diaphragm effect for angles of incidence $>60^\circ$ is higher than the

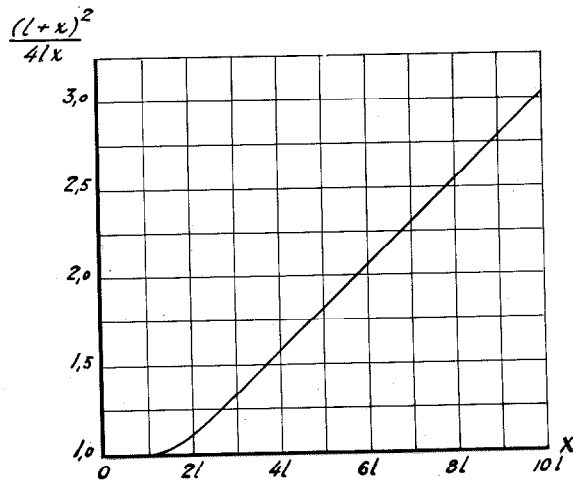

Figure 18

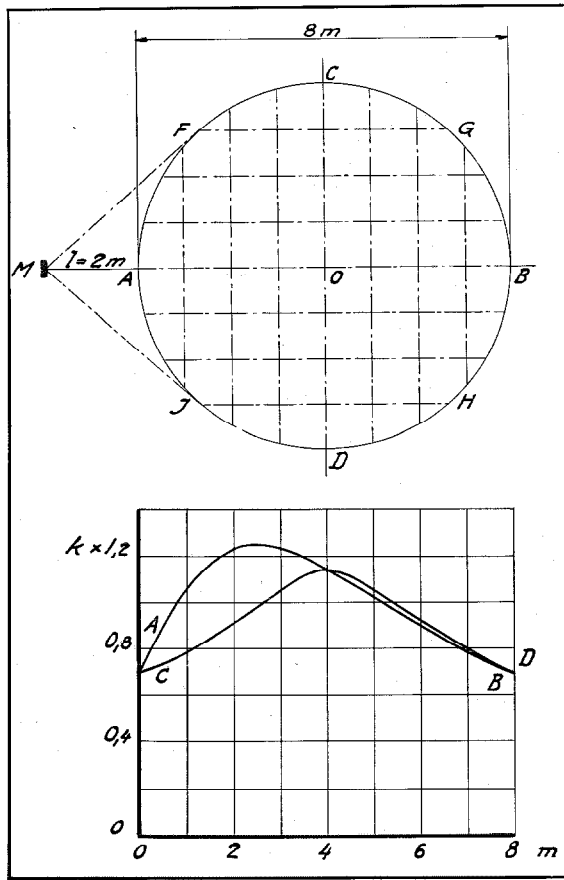

Figure 19

theoretical value, and this constitutes, under certain conditions, the compensation required.

(e) Instruments placed on different height levels.

There is one more method which may be discussed here, viz., the vertical arrangement of the instruments. If, as previously, the question is asked, in a general manner, where the instruments can be placed, there is obtained, with the designations used in Fig. 20, the following condition equation:

$$\frac{(r \cos \nu)^2}{(r^2)^2} = \frac{l^2}{(l^2+h^2)^2}$$

$$r = \frac{l^2+h^2}{l} \cos \nu \dots\dots\dots(12)$$

which signifies a circle of radius R equal to $\frac{1}{2} \frac{l^2+h^2}{l}$ and with its centre on the dotted line

MA. In the special case where $h=1$, $R=h$, and the circle is tangential to the x -axis. For $h > 1$, $R > h$. In this latter case, the circle will cut the x -axis at two points, the inner one at the distance l for $h/l > 1$, and the outer one for $h/l < 1$.

As regards the depth of the orchestra, which may be expressed as $x-l=d$, the expression for the microphone elevation h is obtained from the equation

$$\frac{l^2+h^2}{l} - l = d$$

$$h = \sqrt{ld} \dots\dots\dots(13)$$

Compared with (11), this equation signifies that the microphone elevation corresponds here to the mean proportional between the distance to the foremost instrument and the depth of the orchestra. In the previous case it was between l and $l+d$.

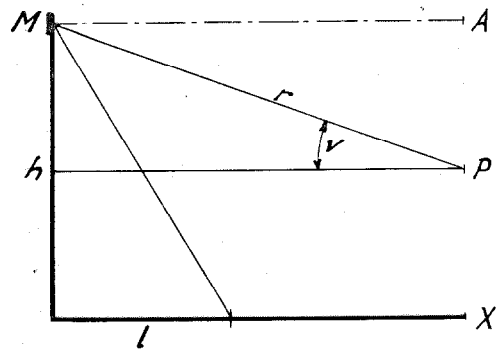

Figure 20

Fig. 21 represents an application of what has been stated in the preceding case (d).

Assuming a depth of orchestra of 8 metres, and a microphone distance of 2 metres, there is obtained by calculation from the formulæ the microphone elevation h equal to 4 metres and the radius R of the circle equal to 5 metres. The condition for the same diaphragm effect in the vertical plane would be a placing of the instruments along the dotted line, but this is, for practical reasons, inconvenient. There has instead been inserted, inside the boundary lines, FJ and GH of the quadrilateral disposition, a steplike elevation with steps of 0.5 metres each.

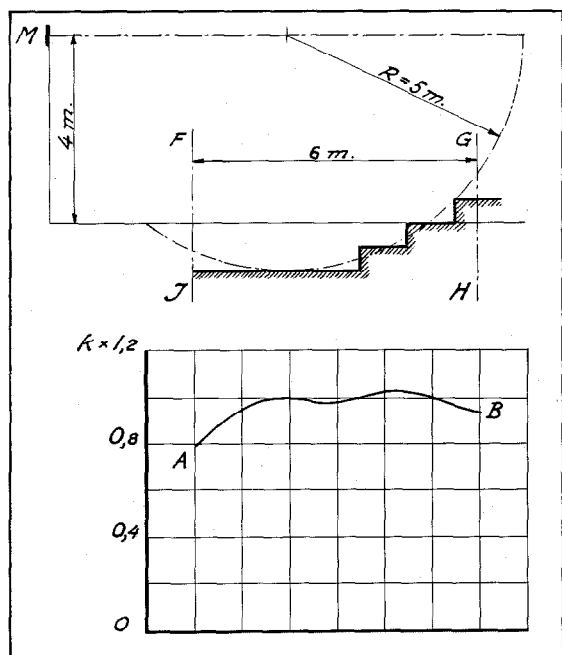

Figure 21

If the diaphragm effect with this arrangement is calculated the curve at the bottom of the same figure is obtained with a ratio between maximum and minimum of about 1.32.

It is obvious that cases still more favourable might be built up, which will, however, not be necessary in this connection. The above example has been worked out in the first place just to give an idea of the applications and the import of the calculations.

6. Summary

Suggestions concerning microphone arrangement are here put forward in which calculations are based on the variations of the diaphragm effect (i) with the angle of incidence, and (ii) with the distance between the microphone and the source of sound. The mathematical expression deduced for (i) is considered by the author to yield results within certain limits verified in practice; with regard to (ii) the highly varying influence of local acoustic conditions comes into the calculation. Concerning the applicability of formula (5), the author therefore desires to point out that this fully applies only where the conditions for its deduction are met with, *i.e.*, where the wall surfaces of the room are constructed of highly damping (non-reflecting) ma-

terial. When picking up music performed in the open air, where the damping can be regarded as absolute, and the reflection as equal to zero, the best conceivable conditions for the calculations exist.

In studio rooms, and as a rule still more in ordinary concert halls, ideal conditions very seldom prevail. According to experience even at a very early stage of broadcasting (1924), the formulæ have, however, in the author's opinion, a certain guiding value as to the arrangement of microphone and orchestra in relation to one another. Two entirely different cases can be distinguished, *viz.*, microphone disposition in relation to small and large assemblies, respectively. In the former case, the matter is comparatively simple: the microphone position is chosen essentially with regard to the microphone angle (in the case of chamber-music, soloists with accompaniment, etc.) in order to obtain the right balance. In the case of large orchestras, the problem becomes more complicated. By applying one or other of the formulæ (11) and (13) it is found that, in order to obtain microphone arrangements in accordance with the calculations, more vertical space is required than is usually available in the studios. To comply with these requirements, it would be necessary to construct the studios about 6 to 8 metres high, which means that they would involve at least two stories. However, this matter can generally be approximately arranged for by means of a fictitious subdivision of the orchestra into small units, and by using two or more microphones in parallel.

A condition for the mechanical handling of the microphone, whether before a large or a small assembly, is evidently that it should be possible to move the microphone vertically, *i.e.*, the microphone supports should be adjustable—a device which, so far as is known to the author, was in its time (1923) introduced with good results into the experimental station of the Telegraph Administration in Stockholm.

Finally might be mentioned an opinion that "the microphone reacts differently against different musical instruments and notes of different pitch." The best microphones used at present for broadcasting purposes have an almost rectilinear characteristic up to a pitch of about

8,000 cycles. That a pickup is sometimes distorted when reproduced is consequently not due to the microphone, as such, but can often be traced to lack of care with regard to the microphone arrangement. The microphone is an instrument having properties and characteristics with which it is a fundamental requirement that the radio stage-manager and announcer should be intimately acquainted in order to be able to handle it in the right way, and to attain a perfectly satisfactory result.

The suggestions expressed above concerning microphone arrangements in studio rooms can be, to a certain extent, applied also to the conditions prevailing in ordinary concert halls. The microphone in such halls is replaced by the human ear, which happily is considerably less

sensitive and more accommodating than any mechanical instrument. The problem is then partly (A) to determine the most suitable arrangement of the orchestra, and partly (B) to give—under the conditions prevailing in each individual case—to the auditorium such a form as will permit music to be heard without distortion in any part of the hall. As is well known, this is generally far from what happens, and is hardly to be expected. Amphitheatrical construction (like the tiers in theatres) has for its aim not only to provide for distinct seeing, but also for distinct hearing. Deficiencies in respect to hearing are generally due to both of the above-mentioned factors (A) and (B), and can, therefore, within certain limits, be obviated by taking suitable precautions.

International Standard Electric Corporation

Head Offices
NEW YORK, U. S. A.

European General Offices
LONDON, ENGLAND

Associated or Affiliated Companies

- Standard Telephones and Cables, Limited.....*London, England*
Branches: Birmingham, Glasgow, Leeds, Liverpool, Manchester,
Dublin, Cairo, Johannesburg, Calcutta, Singapore.
- Le Materiel Telephonique.....*Paris, France*
- Bell Telephone Manufacturing Company.....*Antwerp, Belgium*
Branches: Berne, The Hague, Brussels.
- Ferdinand Schuchhardt Berliner Fernsprech-und Telegraphenwerk,
Aktien-Gesellschaft.....*Berlin, Germany*
- Standard Electric Aktieselskap.....*Oslo, Norway*
Branch: Copenhagen.
- Standard Electric w. Polsee.....*Warsaw, Poland*
- Standard Electric Doms a Spolecnost.....*Prague, Czecho-Slovakia*
- United Telephone and Telegraph Works, Ltd.....*Vienna, Austria*
Branch: Tallinn.
- Standard Villamossagi R/T.....*Budapest, Hungary*
- Standard Elettrica Italiana.....*Milan, Italy*
Branch: Rome.
- Standard Electrica, S. A.....*Madrid, Spain*
Branches: Barcelona, Bilbao, Sevilla, Santander.
- Nippon Electric Company, Limited.....*Tokyo, Japan*
Branches: Osaka, Dalny, Seoul, Taihoku.
- Sumitomo Electric Wire & Cable Works, Limited.....*Osaka, Japan*
- China Electric Company, Limited.....*Shanghai, China*
Branches: Canton, Hankow, Harbin, Mukden, Peiping, and
Tientsin, China.
- Standard Telephones and Cables (Australasia), Ltd.....*Sydney, Australia*
Branches: Melbourne, Wellington.
- Compañia Standard Electric Argentina.....*Buenos Aires, Argentina*
- International Standard Electric Corporation, Branch Office.
Rio de Janeiro, Brazil
- International Standard Electric Corporation of Mexico...*New York, N. Y.*
- International Telephone and Telegraph Laboratories,
Incorporated.....*Hendon, England*
- Laboratoire International de Telephonie et Telegraphie....*Paris, France*
Sales Offices and Agencies Throughout the World
-
-