



ELECTRICAL COMMUNICATION

JULY

1928

No. 1

VOL. 7

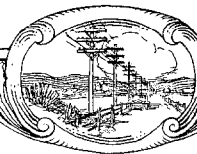

ELECTRICAL COMMUNICATION

A Journal of Progress in the
Telephone, Telegraph and Radio Art

EDITORIAL BOARD

J. L. McQuarrie	F. Gill	G. Deakin	P. E. Erikson	G. H. Nash
G. E. Pingree	P. K. Condict	E. A. Brofos	E. C. Richardson	F. A. Hubbard

H. T. Kohlhaas, Editor

Published Quarterly by the

International Standard Electric Corporation

Head Offices

67 BROAD STREET, NEW YORK, N. Y., U. S. A.

European General Offices

CONNAUGHT HOUSE, ALDWYCH, LONDON, W. C. 2, ENGLAND

75, AVENUE DES CHAMPS-ELYSEES, PARIS (8e), FRANCE

G. E. Pingree, President

L. N. Rock, Secretary

H. B. Orde, Treasurer

Subscription \$3.00 per year; single copies 75 cents

Volume VII

JULY, 1928

Number 1

CONTENTS

PIONEERS OF ELECTRICAL COMMUNICATION: GEORG SIMON OHM—VII	3
<i>By Rollo Appleyard</i>	
BROADCASTING IN SWEDEN, NORWAY AND DENMARK	18
<i>By A. Taranger</i>	
KALUNDBORG RADIO	24
<i>By Kay Christiansen</i>	
CONTROLLING "QUALITY" IN A BROADCASTING SYSTEM....	33
<i>By E. K. Sandeman</i>	
RADIO RECEPTION AND THE BROADCASTING SYSTEM	39
<i>By B. W. L. McPherson</i>	
ELECTRICAL COMMUNICATION AND PROGRESS IN THE IRISH FREE STATE	56
<i>By L. J. Keogh</i>	
AUSTRALIA FIRST TO USE TYPE C-2-F CARRIER SYSTEM....	62
<i>By J. S. Jammer</i>	
A FAMOUS LODESTONE	68



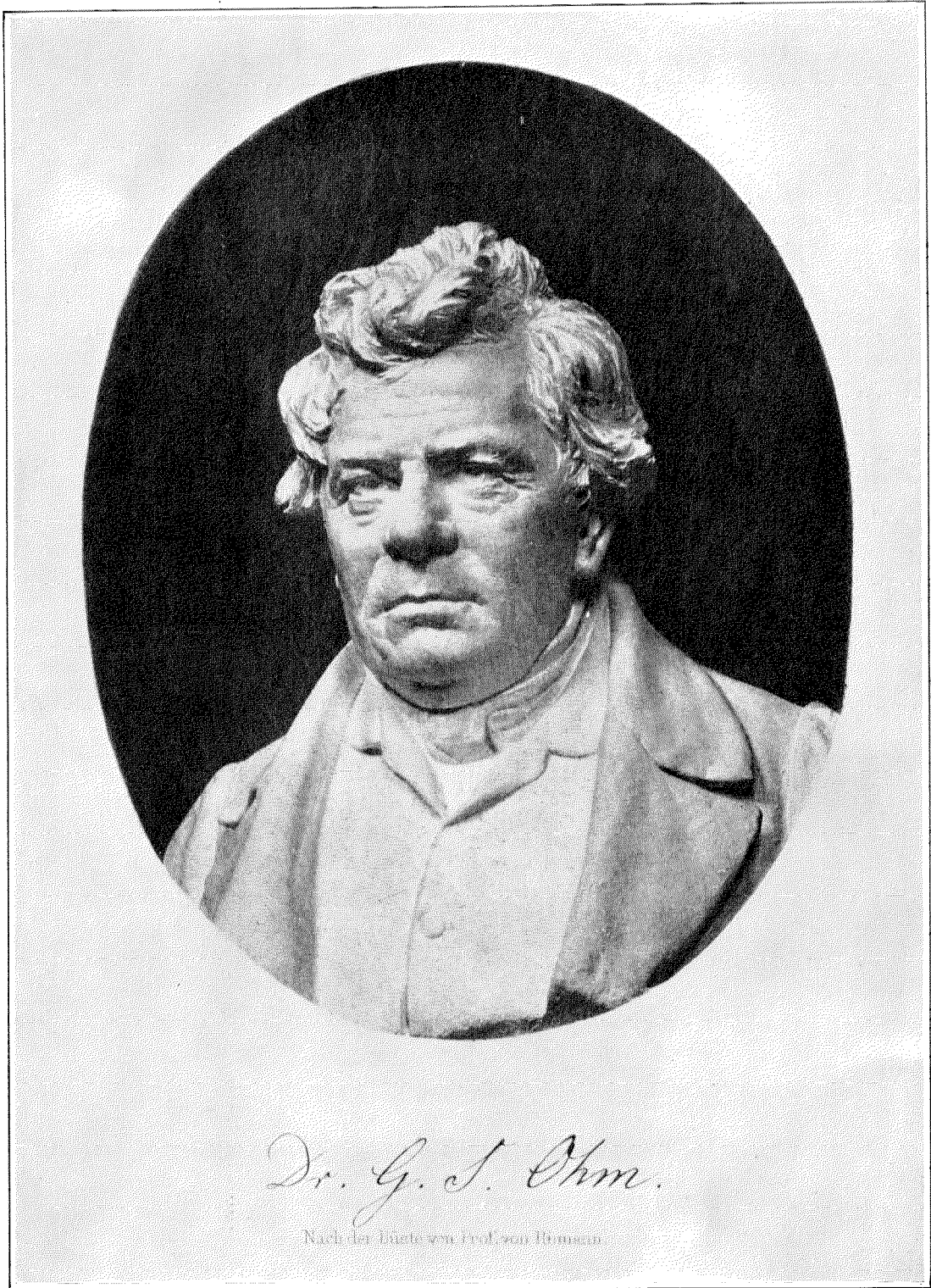

Portrait of G. S. Ohm, from a Bust by Rümmer

Pioneers of Electrical Communication

Georg Simon Ohm—VII

By ROLLO APPLEYARD

European Engineering Department, International Standard Electric Corporation

A CENTURY ago, the science and practice of electrical measurement, and the principles of design for electrical instruments scarcely existed. With a few exceptions, ill-defined expressions relating to quantity and intensity, combined with immature ideas of conductivity and derived circuits, retarded the progress of quantitative electrical investigations. Yet, amidst this confusion, a discovery had been made that was destined to create order out of chaos, to convert electrical measurement into the most precise of all physical operations, and to aid almost every other branch of quantitative research. This discovery resulted from the arduous labours of Georg Simon Ohm.

So completely has his work now merged into general knowledge, that his life is lost sight of in a law, and his name in a unit. Writings, all too brief, of his friends Bauernfeind and Mann enable some of the scattered details of his personal history to be ascertained. Relics of his laboratory apparatus, few as they are, give hints of the circumstances in which he carried out his researches. Fortunately, however, in contrast with the broken narrative that tells of his career, there exist his published scientific memoirs, collected with such care and comprehension by Eugene Lommel, that Ohm's achievements are established more firmly than they might have been if every detail of the sombre history of his honourable life had run the gauntlet of the cyclopaedias. To these memoirs must be added the volume of reprints of certain of his letters and other documents which, thanks to the industry and zeal of Ludwig Hartmann of Munich, were collected and printed as a tribute to Ohm on the occasion, in 1927, of the centenary of the publication of the immortal treatise on the electric circuit.

Ohm belonged to a German burgher family, from father to son, locksmiths. His great grandfather was Wilhelm Ohm, of Westerholt, near Münster, in Westphalia. His grandfather was Johann Vincentius Ohm, a journeyman

locksmith, who settled first at Cadolzburg; there he married, but in 1764 he made his home in the university town of Erlangen, Bavaria, where he obtained citizen rights. Johann Vincentius had two sons. The elder, Johann Wolfgang, born in 1752, was apprenticed as a locksmith in 1776, and after ten years of wandering as a journeyman he returned to Erlangen, where, in 1785, he became a master locksmith. On January 24, 1786, this Johann Wolfgang Ohm married Fraulein Beck, or Beckin, the daughter of a tailor. They had seven children. The first child of this marriage was Georg Simon Ohm who, according to the most trustworthy authorities, was born on March 16, 1789. A second son, Martin (junior) was born in 1792. In the late summer of 1799, when Georg was but ten years old, their mother died. Of the children, only three grew up; these were Georg Simon, Martin (junior) and Elizabeth Barbara. Martin (junior), it must suffice here to observe, became a distinguished mathematician, and a Professor of Mathematics at the Military College, Berlin.

The younger son of Johann Vincentius Ohm was Martin (senior), born in 1763, i.e., a year before the settlement of Johann Vincentius in Erlangen. This Martin (senior) similarly became a locksmith in Erlangen; he married on February 23, 1789, at the Neustädter Church at Erlangen, Elizabeth Sabina Krug, the daughter of a peasant from the Uehlfeld district. They had five children, none of whom survived infancy. The death of his wife soon followed. On June 23, 1800, he married Sabina Katharina Frasz, a hosier's daughter, and on February 16, 1801, a daughter was born. Martin (senior) Ohm survived the birth of this daughter only a few weeks. He died on April 5, 1801, at the age of 37 years, 7 months and 23 days. He was godfather to his nephew Martin (junior) the son of Johann Wolfgang Ohm.

These details help to dispel doubts concerning the birthplace and the dates appertaining to

Georg. It is remarkable that the records of one who devoted his whole life to precision should call for so much hesitancy in acceptance, but the tablet upon the house where he is alleged to have been born, and the inscription upon his tombstone, are discordant with his history. Moreover, he could scarcely call his name his own. The date and place of birth have recently been investigated by Dr. Deuerlein of Erlangen. His account of the matter was published in a supplement to the "Erlanger Neueste Nachrichten" of June 25, 1927. He

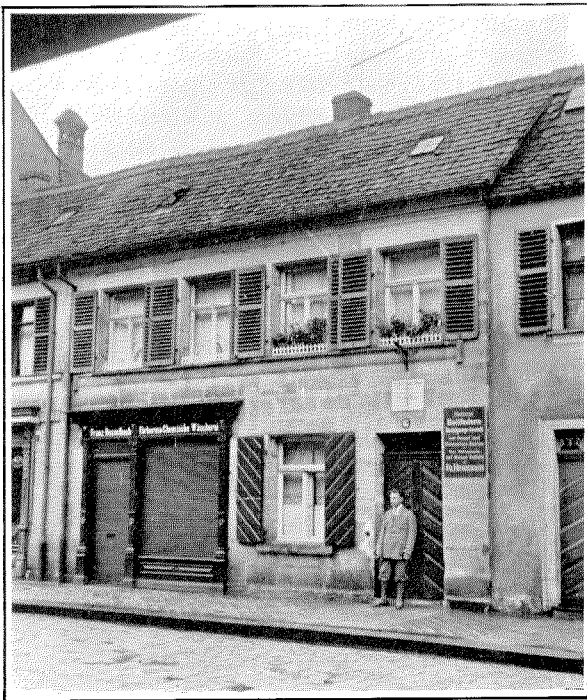

Figure 1—No. 6 Fahrstrasse, Erlangen.

found, in the Register of the Evangelical Lutheran Church of Erlangen, Neustadt, the entry of baptism:

"1789 Martius den 18 t. (wurde getauft) Johann Simon, Mstrs. Johann Wolfgang Ohms, Bürgers und Schlossers dahier, und seiner Ehefrau Maria Elisabetha geb. Beckin von hier Söhn. geb. den 16. Abends um 3 Uhr. Gev. war Mstr. Johann Simon Beck, Bürger und Schneider dahier, der kindbeterin Bruder."

[1789 March 18th (was christened) Johann Simon—son of Johann Wolfgang Ohm—citizen and locksmith of this district—and of his wedded wife Maria Elizabetha, formerly Beckin of this district. The child was born on the 16th at 3 o'clock in the

afternoon. Godfather was Mr. Johann Simon Beck, citizen and tailor of this district, brother of the child's mother.]

This leaves no doubt that the date of birth was March 16, 1789, and that the boy was christened Johann Simon. The name by which he was subsequently known was Georg Simon—possibly to avoid its being mistaken in the family for that of his father, Johann.

The house in Erlangen upon which the memorial tablet is placed is No. 6, Fahrstrasse (Figure 1). From the town records it is known that this house was built in 1733. Its first occupant was the builder of it, Joh. Gg. Held, who sold it to the hatter, Leonard Hofmann. From October, 1754 it was owned by the tobacconist, Andreas Wölckel. He died and left a widow who on March 1, 1779, transferred it to Elias Reinhard, a hosier, from whom it passed by inheritance on June 18, 1782, to Johann Georg Bauer, a locksmith. Two years later it was sold to Johann Friedrich Schwarz, a master white-washer. On March 31, 1791, it was sold to Johann Melchior Günther, a furniture maker, and the Günthers retained it into the nineteenth century. Consequently, No. 6 Fahrstrasse was never possessed by the family of Ohm. There is no evidence that they ever entered it.

The investigation next turns to No. 11 Fahrstrasse (Figure 2), and to No. 20 Friedrichstrasse. No. 11 Fahrstrasse was built in 1724. It passed into possession of Link, the hosier, and it was sold by him on September 7, 1790, to Johann Wolfgang Ohm who there resided and established a locksmith's workshop. No. 20 Friedrichstrasse was built in 1719, and in the middle of the eighteenth century it was owned by Leonard Heinrich Kühn, a tailor. In 1799 it was owned by the master locksmith Johann Vincentius Ohm. On May 3, 1801, after his death, it was taken over by his son Johann Wolfgang—the father of Georg and Martin (junior). As Martin (junior) was born on May 6, 1792, it must be concluded that his birth took place at No. 11 Fahrstrasse—not at No. 6 Fahrstrasse.

Georg Simon was born on March 16, 1789—where, nobody knows, for the residence of his parents before September 7, 1790, has not been traced. His sister, Elizabeth Barbara, born on

July 24, 1794, married on June 7, 1824, the locksmith Konrad Fichtbauer (or Füchtbauer). This worthy man appears to have entered wholeheartedly into the matrimonial contract; for with Elizabeth Barbara he took over the Ohm locksmith workshop, and the two Ohm houses—No. 11 Fahrstrasse, and No. 20 Friedrichstrasse. They had a son who inherited scientific propensities. He became Dr. Füchtbauer, chief member of the educational council and Rector of the Nuremberg Industrial College. By the courtesy of the Director of the Deutsches Museum, Munich, relics of some of the original apparatus of Georg Simon Ohm are here illustrated, Figures 3 to 7 inclusive; and it is to be remarked that these relics were acquired by the Museum from the Füchtbauer family of Nuremberg, in October, 1904.

In view of these investigations, the words on the stone tablet above the portal of No. 6 Fahrstrasse (Figure 1), may require amendment. They read:

Georg Simon Ohm
Physiker
Hier geb. 16. III. 1789.
Martin Ohm
Mathematiker
geb. 6. V. 1792

[George Simon Ohm
Physicist
Born here. 16. III. 1789.
Martin Ohm
Mathematician
born 6. V. 1792]

The house also bears a notice explaining that upon the premises feather beds are cleaned by steam and by electrically driven machinery. This association of the house with the great electrician constitutes the whole of the evidence.

The father of Georg and Martin was a man of exceptional ability. In his wanderings as a locksmith, he had studied philosophy and mathematics. This had brought him into touch with

Professor Langsdorff of Heidelberg who had gone there from Erlangen. Under their father's guidance, the motherless lads made progress, and the attention of Langsdorff was directed to their aptitude. He predicted that history would repeat itself in them as a pair of brothers Bernoulli. Subsequent events accorded with his prophecy. Stimulated by this encouragement, the father decided to give them University education, upon the understanding that they must apply themselves also to become skilled locksmiths.

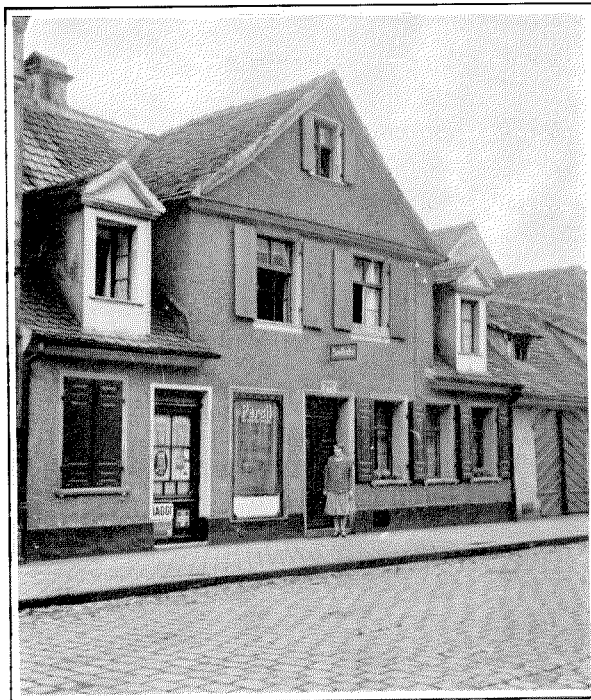

Figure 2—No. 11 Fahrstrasse, Erlangen.

For one year Georg attended the Gymnasium of Erlangen. At Easter, 1805, he entered Erlangen University (Figure 8); on May 3, 1805, he matriculated in Philosophy. His studies were immediately directed to mathematics and physics. Unfortunately, lack of means limited him to but three Terms at the University. At the end of September, 1806, by the services of the bookseller Walther, he obtained a post as a mathematical tutor at a school kept by Zehender, a clergyman in Gottstadt, Switzerland. Soon afterwards, the master of the school wrote to Walther:

“Ich habe beim ersten Anblick des achtzehnjährigen kleinen und schwächtigen Junglings nicht glauben können, dass dieser der empfohlene Lehrer sei, aber mich bald von dieser Tüchtigkeit und Brauchbarkeit überzeugt.”

[When I first looked at the eighteen year old small and delicate youth, I was unable to believe that he was the teacher recommended, but I was soon convinced of his proficiency and usefulness.]

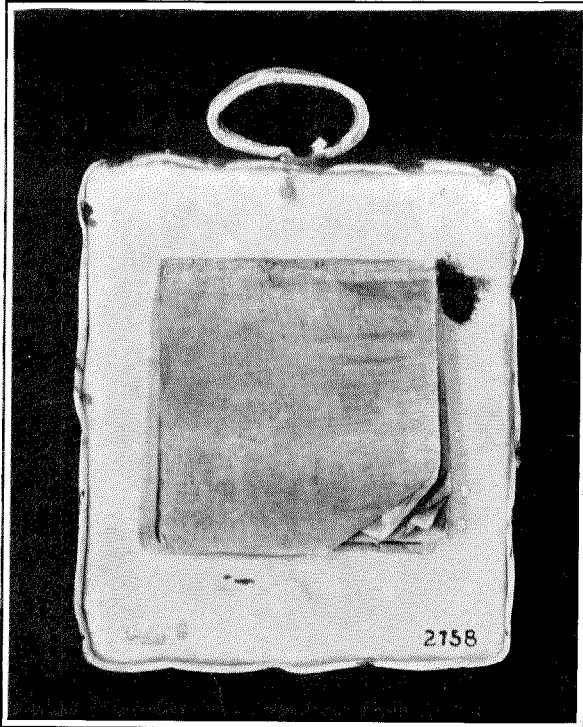

Figure 3—Relic of Ohm's Apparatus. A leather pad upon which he cut gold-leaf for his electroscopes. A book of gold-leaf.

In other words, at first sight he could not believe that this small and weakly youth of 18 could be the teacher recommended, but he soon became convinced of his thoroughness and usefulness. After the third half-year at Gottstadt, Georg went to Neuchatel with the object of taking private lessons in mathematics and conversational French. It was at this period that, upon the advice of his old friend, Professor Langsdorf, he studied the works of Euler and Lacroix. At Easter, 1811, however, he returned to Erlangen and on October 25th of that year he obtained there the degree of Doctor of Philosophy. His inclination was still towards physics, and his special subjects were now

mechanics, light, and particularly colour. For three terms he read mathematics, but for reasons of economy he had again to shoulder what to him was the irksome yoke of a teacher.

He was aware that Professor J. S. Schweigger, of Erlangen, had held an appointment at Bayreuth and had since been called to the chair of Mathematics and Physics at Nuremberg. In November, 1811, he accordingly wrote to the authorities at Bayreuth to offer his services, but the result was discouraging. He remained at Erlangen, and on July 28, 1812, addressed a letter to the King of Bavaria praying for employment as a teacher. In consequence, on December 16, 1812, Ohm became a tutor at the Realstudienanstalt at Bamberg. There he remained, impoverished and miserable. From the depths of despair he wrote repeatedly to the King and to the authorities, but from the uncongenial conditions there was no escape.

It must be remembered that the year 1813, critical in the history of Europe, brought Germany to the storm-centre of the struggle against Napoleon. Upon Erlangen's 8,000 inhabitants, 33,685 troops were in that year billeted. In addition to the threat from without, there was anxiety lest civil war should arise in Bavaria in favour of Prussian rule. Georg was then 24, of military age, but either upon the grounds of philosophy, physical unfitness, or natural reluctance, he stood aside from military service.

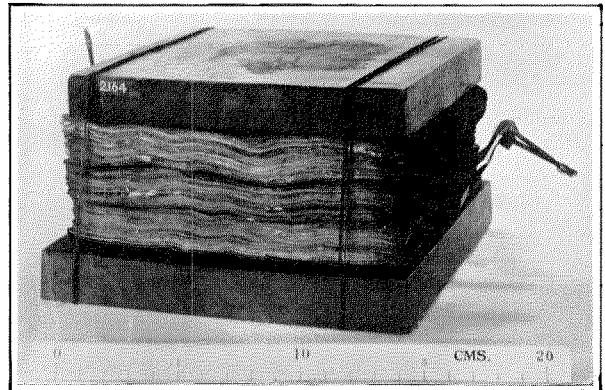

Figure 4—Relic of Ohm's Apparatus. A dry-pile battery, probably of Zamboni type.

In the Spring of 1817, he published his first book. He dedicated it to the memory of his father and gave to it the impressive title,

"Grundlinien zu einer zweckmässigen Behandlung der Geometrie als höheren Bildungsmittels an vorbereitenden Lehranstalten," and he sent a copy to the King of Bavaria, beseeching him to grant amelioration of circumstances. The royal reply was as carefully calculated, but more tactful: there was no appointment vacant, but the book had been placed in the library.

Copies of the "Grundlinien" were sent to other reigning monarchs, and amongst them, fortunately, to King Friedrich Wilhelm III of Prussia, who looked with favour upon the application. Ohm therefore left the land of his birth, Bavaria, and in the Autumn of 1817 took up his quarters in Cologne as Oberlehrer in Mathematics and Physics at the Royal Kon-sistorium. There he found friends and apparatus, a library, and above all, greater freedom, response, and appreciation. The physical apparatus at the Jesuit Gymnasium of Cologne enabled him to proceed with the investigation of the galvanic circuit. He applied himself with complete devotion to his duties, and it is pleasant to record that, in addition to his normal remuneration, he received in October, 1822, a "gratifikation" of 100 Thalers in recognition of his special services.

His influence and his teaching were now, as in his future career, inspiring. Years afterwards, one of his students wrote:

"... seine Art und Weise, sein frisches gesundes Wesen steht mir lebendig vor der Seele, und es gehen selten Wochen, nie Monaten vorüber, ohne dass ich an Sie denken muss."

[His nature and manner, his fresh healthy disposition, remain vividly impressed upon my soul; seldom do weeks, and never months go by, but I must think of him.]

His zeal never flagged; he directed his students towards the object which his own genius sought. For a long time his choice alternated between mathematics and physics—mathematics that leads through the mysterious to the wonderful, physics without which mathematics can accomplish little. After the manner of the pioneers, he took care that his mind should not drift. He chose a direct object, and for that, with the utmost skill, he steered. His direct object at Cologne, was the investigation of the galvanic circuit. He there investigated the relative conductivities of metals, the theory of

the galvanometer, and by experiment, the law of flow of electricity in conductors. In April, 1826, he realised, however, that if he could break away completely from the restraints of teaching, he could establish the truth concerning electrical circuits. So convinced was he of this, that he requested the authorities to grant him leave of absence for a whole year, undisturbed. Leave was accorded in a most gracious and

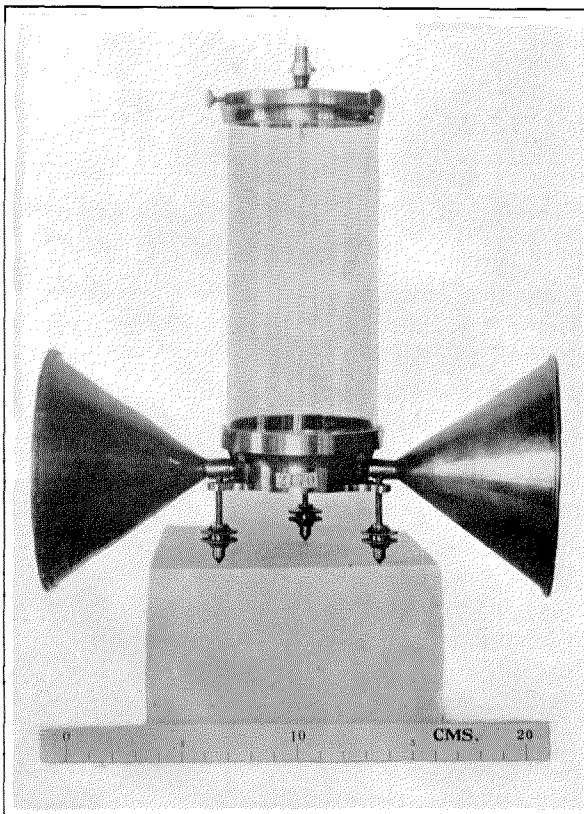

Figure 5—Thermo-galvanometer Used by Ohm. It contains two rectangular bars, probably one of bismuth and the other of antimony, one above the other, at a distance sufficient to allow the lower magnet of an astatic needle to swing between them. The ends of the bars are soldered together, and the upper bar has a longitudinal saw-cut through which the lower suspended magnet can pass to its proper level. The funnel-shaped reflectors are directed towards the solderings.

generous manner, and he betook himself to his brother's house at Berlin. He was probably actuated also by a second motive, for notwithstanding his happy surroundings at Cologne, he was conscious that his achievements deserved recognition in the form of an appointment to a professional chair, and on December 15, 1818—

only a year after his arrival in that city—he had written to the Royal Prussian Konsistorium requesting that his case might be kept before them in this respect. If he could now produce something tangible, both objects would be

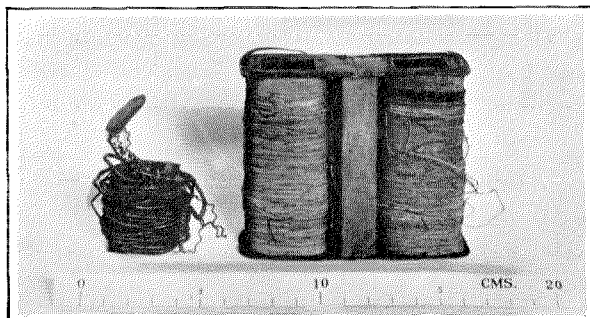

Figure 6—Relics of Ohm's Apparatus. Bobbins wound with wire.

secured. The tangible result of his sojourn in Berlin was, in fact, his book, "Die galvanische Kette, mathematisch bearbeitet," which was published in Berlin in May, 1827.

Confirmation of his law of electrical circuits described in this treatise, came from Fechner of Leipzig, from Pfaff of Erlangen, and from Poggendorff of Berlin. Criticism, however, was levelled against it, gently enough by Kämtz of Halle, but more provokingly by G. F. Pohl in the *Jahrbücher für wissenschaftliche Kritik*, to which Ohm forcibly replied. Scientific strife led to the breaking off of friendly relations, and Ohm, taking into account the true nature of the opposition, relinquished his appointment at Cologne and, during the six years 1827–1833, retired into private life.

His desire for freedom to continue his investigations, his annoyance at the delay in obtaining an appropriate appointment, his irritation at being attacked where he ought to have been supported, explain his action at this juncture; but behind it all there was a common cause. His philosophy, that of arriving at the truth by observation and measurement, clashed with what was then being taught at Bamberg, Jena, Heidelberg, and Berlin. Germany was suffering from bureaucracy tempered by despotism, impressed upon the wreckage of an empire that had been restrained from advance by feudal forms and various animosities. Hegel had arisen to teach that human life is of more consequence

than its incidents, destiny was again to be the rule, details were nothing, specialism was to be discouraged, the national conscience was to arise and unify the scattered states into an imperial organisation, rising above the finite to the infinite. Hegel had been concerned in the establishment of the *Jahrbücher für wissenschaftliche Kritik*, and in 1827 the popularity of Hegel, expressed in poetry, medals and gifts of silver mugs, was at its zenith. Hartmann, therefore, discloses the truth when he says

"Die Hegelsche Philosophie beherrschte zu jener zeit das Feld. Sie wollte die Naturgesetze auf dem bequemen Wege der souveränen Spekulation, nicht auf dem mühevollen Pfade der Messung und Beobachtung ergründen. Das war nun freilich nicht nach Ohms geschmack; er war aus einem andern Holtz geschnitzt."

[At that time Hegel's philosophy predominated. It sought to prove the laws of nature, not by the irksome means of testing and observation, but by the convenient method of sovereign speculation. This of course, was not to Ohm's taste; he was of different calibre.

Apart from these initial skirmishes, Ohm's law was for some years scarcely noticed, except by a few physicists. In France, between the years 1831 and 1837, Pouillet demonstrated its truth by direct experiment so effectively, and concentrated his mind upon it so intently, that

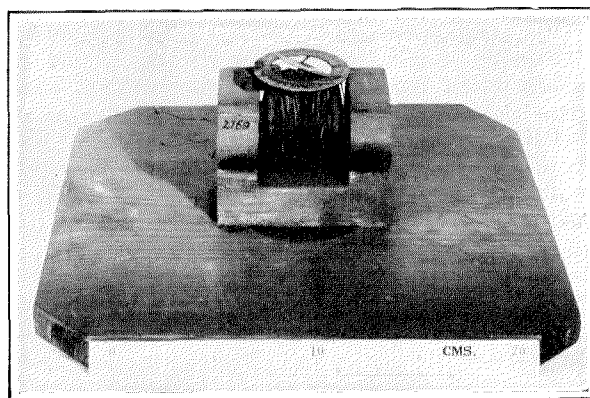

Figure 7—Relic of Ohm's Apparatus. A primitive galvanometer.

ultimately he almost thought he had discovered it. The triumph of Ohm came in 1841, when the Council of the Royal Society of London awarded him the Copley Medal for his researches into the laws of electric currents, contained in

various memoirs in Schweigger's Journal, Poggendorff's Annalen, and also in *Die Galvanische Kette Mathematisch Bearbeitet*. The Council declared that in these works Ohm had established, for the first time, the laws of the electric circuit a subject then of vast importance, and previously involved in the greatest uncertainty.

Ohm, the Council pointed out, had demonstrated that the usual vague distinctions between intensity and quantity have no foundation, and that all explanations derived from these distinctions are utterly erroneous. Both theoretically and experimentally, Ohm had proved that the action of a circuit is equal to the sum of the electromotive forces divided by the sum of the resistances, and that whatever might be the nature of the current, whether voltaic or thermo-electric, if this quotient be equal, the effect is the same. To Ohm also the Council assigned credit for providing means to determine with accuracy the values of the separate resistances and electro-motive forces in a circuit. They drew attention, moreover, to the extent to which the labours of Ohm had been neglected. Within the five years preceding the bestowal of the medal, however, Gauss, Jacobi, Poggendorff, Henry, and many other eminent philosophers had acknowledged the great value of Ohm's researches and their obligations to him in conducting their own researches. The special subjects noticed by the Council on this occasion were his researches on the conductivity of metals, on the power of electro-magnetic multipliers (galvanometers), and on the nature of unipolar conductors and hydro-electric currents.

In England, those physicists who had most experience in electrical researches bore the strongest testimony to the help they had derived from Ohm's results. It was confessed that if the works of Ohm had been earlier studied, the industry of experimenters would have been better rewarded.

The comment of Eugen Lommel upon this acknowledgment of Ohm's results was:

"So Würde Ohm vom Auslande her die späte Anerkennung zu Theil, die ihm das Vaterland so lange vorenthalten hatte."

[Thus foreign countries accorded to Ohm the recognition the fatherland had so long withheld.]

Lommel proceeds to state that after the publication of the work on the galvanic circuit,

Ohm's attention was directed to molecular physics.

The eulogy bestowed by the Royal Society upon his discoveries, encouraged him to investigate, by the aid of analytical mechanics, the form, magnitude and mode of operation of atoms. He wished, in fact, to produce a *Principia* for the microcosmos. Fate, however, stood between this desire and its realisation. The dismal years 1827-1833 were given by him to mathematical instruction at the Military School at Berlin. He tried unsuccessfully to obtain a better



Figure 8—University Buildings and Hauptstrasse, Erlangen, 1743-1826.

appointment there or at Oldenburg; for the remuneration was less than half what he had received at Cologne. Happily, on July 3, 1833, King Ludwig I, of Bavaria, issued a decree that relieved Ohm of these anxieties. He was given a professorship at the Polytechnic School of Nuremberg, and he retained touch with that institution until 1849. In 1835 he was appointed also to the Chair of Higher Mathematics at the University of Erlangen, and at the same time State Inspector of Scientific Education. Ultimately, he became Rektor at Nuremberg. Towards the end of 1849, he was appointed by

Maximilian II, Professor of Physics to the University at Munich; the Akademie of Science selected him as Conservator in Mathematical Physics, and in addition, following Steinheil, he was adviser concerning the development of telegraphy for the State. These manifold duties prevented him from continuing his researches in molecular physics. His biographers have found some compensation for this loss in the circumstance that in 1852 and 1853 he published at Munich his results, obtained in the summer of 1851, on interference phenomena and polarised light, and that he discovered how to express his conclusion in a simple formula. Unfortunately, these results, in which two plates of crystal in polarised light could be made to produce a series of concentric coloured ellipses, resembled in many respects those arrived at, quite independently, by Langberg of Christiania, and published in the Norwegian "Magazin for Naturvidenskaberne" for 1841.

Notwithstanding his disinclination for teaching, circumstances to the end obliged Ohm to teach, and he taught well. He was an advocate for individual instruction. The usual two-hour "lecture" was broken up by him; about half was at the black-board, and the remainder was given to working out examples with his students. In this manner he remained in touch with his class. Throughout Germany, his method left its effect. The conditions, however, under which he taught were opposed to rapid progress. For example, students had forms to sit upon, but no desks at which to write. Their mathematical knowledge at entry was so slight that physics to them was at first unintelligible. He realised this, and in 1852 he devoted his precious time to writing out for them with his own hand complete notes, which were lithographed.

Ohm lived simply. He was of marked energy, of middle height, compactly built, sturdy and strong. He was clean shaven, and his friend Mann says that this physiognomy was of the Martin Luther type. His eyes were large and penetrating; his mouth revealed wit, satire and good humour. The long dark-blue coat he wore was provided with side-pockets which always held a snuff-box. In diction and phrase he excelled; moreover, his voice was full, and far into his life it retained its attractive quality. If a problem was to be solved, he approached

it with his students as though he did not yet know what it would reveal. He encouraged them to find the answer, and at last he would ask: Do you understand? Is it clear? After he had explained it, it was always clear, crystal clear. Bauernfeind has recorded that Ohm was by nature benevolent. The bitterness of his early rebuff did not rankle. He spoke but little, but what he said was of substance. Beyond the College gates, he was known within his own country but slightly.

His scientific writings were brought together and published at Leipzig in 1892—under the editorship of Dr. Eugene Lommel, Professor of Physics at the University of Munich—with the title "Gesammelte Abhandlungen von G. S. Ohm." It is a book of 855 pages, relating to 23 communications in which can be seen the results of researches extending over thirty years. The subjects dealt with are comparatively few, but the treatment is thorough, and there is evidence line upon line of tenacity of purpose. From the first, there is manifest the determination of Ohm to establish the law of flow of electricity in metallic conductors. This led him naturally to consider the development of such measuring instruments as the multiplier, or galvanometer, which Poggendorff and Schweigger had devised in 1821. It attracted him also to the results obtained by the English physicists, Children and Davy, with regard to the glow of wires heated by electric currents. Ohm further investigated the question whether the law established for metallic conductors was applicable to liquid conductors. In addition, time was occupied in elucidating the experiments of Ermann on so-called "unipolar conductors." Then followed his work in acoustics, particularly with reference to combination tones, and lastly his experiments and theory relating to polarised light.

From these contributions of Ohm to natural science may be singled out three of transcendent value: his law of electric flow, his law of combination tones, his philosophy of research in physics. The law of electric flow is based upon experimental results appertaining to a property of matter. It implies that the potential difference between any two fixed points on a given homogeneous conductor, when the flow of electricity between those points is steady, is a

direct measure of the current in the conductor, between those points. The ratio of that potential difference to that current, in these circumstances, is a characteristic of the portion of the conductor in question, and is called the "resistance." So long as Ohm's law applied, "resistance" thus defined is constant for all values of the potential difference between the two points. In his own words:

"Die Grösse des Stromes in einer galvanischen Kette ist der Summe aller Spannungen direkt, und der ganzen reducirten Länge der Kette umgekehrt proportional, wobei man sich erinnern muss, dass jetzt unter reducirter Länge die Summe aller Quotienten verstanden wird, die aus den zu homogenen Theilen gehörigen wirklichen Längen und dem Produkte der entsprechen Leitungs-vermögen und Querschnitte gebildet werden."

[The magnitude of the current in a galvanic circuit is directly proportional to the sum of all the electromotive forces, and inversely proportional to the whole of the reduced length of the circuit, and it must be remembered that by reduced length is to be understood the sum of all the quotients which can be formed corresponding to all the actual lengths of the homogeneous parts and the products of the corresponding conductivities and cross-sections.]

The law is most easily demonstrated to hold in the case of homogeneous metallic conductors at constant temperature.

Ohm's law thus defined is applicable to all conducting systems and is free from ambiguity; its usefulness has carried it into the wider field of electrical research and engineering, where its interpretation has occasionally been stretched to the very limits of its validity. From metallic conductors it has been extended to electrolytes, from electrolytes to dielectrics, from dielectrics to electric arcs, and from arcs to thermionic valves. Moreover, by mathematical devices, inductance, capacity, and leakage have all been operated upon to convert them into terms capable of being interpreted as "resistance," so as to bring them under the jurisdiction of a kind of Ohm's law. A clash consequent upon this struggle for latitude occurred in England in the summer of 1896, when there was a fierce and prolonged debate with regard to the existence, or not, of "negative resistance" in the electric arc. The attack was led by Dr. S. P. Thompson, at a meeting of the Physical Society of London, and was hotly responded to by

Professor W. E. Ayrton, in a characteristic speech beginning with the words "It is a pity that so much erudition should be marred by three obvious misconceptions. . . ." After some weeks of acid controversy, it was decided to refer the matter for settlement to Oliver Heaviside who gave judgment as follows:

"I am asked my opinion about negative resistance. This I take to mean simply that if a body formally obeyed Ohm's law, $E = RC$, and Joule's law, $H = RC^2t$, but with R a negative instead of a positive quantity, it would possess negative resistance. The effects produced by the negativity of R (and other quantities) have occupied my attention in certain papers, and are interesting and instructive. But I have no faith whatever in the permanent existence of a body with negative resistance, on account of the general instability. At the same time I am not prepared to deny that a substance might temporarily, and under suitable circumstances, behave as a negative resistance approximately, especially if it is in a state of continuous material change. . . . Whether the arc may be conveniently regarded in this light, is not for me to say. I do not know enough about the arc. I prefer gas for personal use."—*Oliver Heaviside*, July 28, 1896.

Pioneer work in electrical communication, from the middle to the end of the nineteenth century, was in great measure carried on by electricians whose equipment of theory was limited to applications of Ohm's law in the somewhat ambiguous form

$$\begin{aligned} \text{Current} = C &= \frac{E}{R} \\ &= \frac{\text{Electromotive-force of battery}}{\text{Resistance}} \end{aligned}$$

When they dealt with single metallic conductors, there was not much difficulty. The application of the formula to networks, and to circuits containing electrolytes, especially if so-called "back Electromotive forces" happened to be present, was sometimes troublesome to them. The meaning of the difference of potential between two points was clear, because most of the electricians of that time were familiar with static electricity, and with some form of electrometer. They had, however, to grasp the fact that in applying Ohm's law they were concerned not merely with the electromotive-force of their battery, but with electro-

lytic and other effects, usually involving a counter electromotive force E_1 , so that the current was given by

$$C = \frac{E - E_1}{R},$$

where R was known or could easily be measured. With the improvement of galvanometers, there followed the ammeter and the voltmeter. Electricians began to think less in terms of resistances, and more in terms of current and fall of potential along conductors. At the next stage of the advance, attention was directed to concise definitions of electrical power and electrical energy. Ohm's law remained the basis, and carried its way at last into the new field of alternating current theory. This had been forbidden ground, for Ohm's law predicated the steady state, and here all that was constant was inconsistency. Nevertheless, a variety of Ohm's law at last sprang into existence for alternating currents, and it flourished exceedingly. Thus Ohm's law was—as Ohm had prophesied in *Schweigger's Journal* of 1826, it would be—in perfect agreement with experiments in all directions, and characterised by simplicity that extends its application to all experience with electric currents—simplicity such as is only found in truth. Or in his own words:

“. . . wie nur in Gefolge der Wahrheit zu erblicken ist, als das reine Gesetz der Natur verkündigt.”

[Revealed only in the quest of Truth, as manifested in the pure law of Nature.]

He started from the fact that when two dissimilar metals, or certain other substances, touch one another, they maintain at the point of contact a difference of potential. He recognised that chemical changes in fluid portions of a circuit introduce complexities that occasionally lead to apparent exceptions. These, until interpreted, amount almost to contradictions. He therefore deferred consideration of the parts of circuits that are subject to chemical change, and he dealt first with a circuit of homogeneous material of the same cross-section throughout. For such a circuit he found by experiment that the slope representing potential, coordinated against electrical resistance, is a straight line. This line he plotted, and he proceeded in like

manner to obtain zig-zag representations of the fall of potential for composite circuits built up of conductors of various lengths, sections, and materials. Then he showed how to calculate the fall between any two given points along such a composite circuit. He demonstrated that for the steady state, or in his words, for a circuit—“deren Zustand bleibend ist”—the current is of equal strength at all points along the conducting system, and that a change of current at any one point corresponds to similar change of current throughout. He stated his law, in terms not of “resistance” but of “reduced length.” By “reduced length” he meant the length of a wire—of given material, such as standard copper, and of given sectional area—having a resistance equal to the sum of the resistances of the circuit in question.

He pointed out that this law differed essentially from those of Davy, of Becquerel, of Barlow, and of his own early investigations; the discrepancies in those tentative formulae he attributed to the smallness of the range available in the interpolations by which they had been obtained. His argument was next directed to proving that interchange of the parts of a composite line of conductors has no effect upon the total resistance. He proved that for all points along the conductor, provided that the ratio of potential difference to resistance is constant, the current is constant. The trouble in his experiments arose because the resistance of his battery was large and unsteady. He explained why results of greater consistency were obtained with a thermocouple, where the resistance is small. Then he dealt with problems relating to cells in series and in parallel, the effect of putting a galvanometer into the circuit, and general expressions for the resistance of conductors in parallel. He studied also what happens when a conducting body of considerable size is brought up to a circuit, and he showed that the effect is independent of the material of the added body provided that it is a conductor. He completed the task by mathematical investigation of the current in a circuit when the atmosphere exerts some effect (i) without chemical changes, and (ii) with chemical changes. In this part of his work he led the way to the problem of leakage of transmission lines, and its solution by hyperbolic functions in exponential form.

To convert what at first was an empirical rule, into a physical law of the highest order, it was necessary for Ohm to give it the support of theory. He proceeded to develop a theory of electric flow, following the results of Laplace, of Poisson, and chiefly of Fourier with regard to the diffusion of heat. During the years 1807-1816, Joseph Fourier had communicated several important contributions upon diffusion to the Institut de France. In 1822 there was published his *Théorie Analytique de la Chaleur*—which Heaviside in 1895 described as the most entertaining mathematical work ever seen. Its appearance was well timed to influence Ohm. Fourier began with the observation that different bodies possess in different degrees the power (i) To contain heat; (ii) To conduct heat through their substance; (iii) To receive or to transmit heat through their surfaces. Corresponding thereto he defined (a) The capacity (la capacité de chaleur); (b) Specific conductivity (la conductibilité propre); (c) Emission conductivity (la conductibilité extérieure).

Fourier had found that when a metal bar is exposed at one end to the constant action of a source of heat, and every point of the bar has attained its highest temperature, the system of fixed temperatures is distributed along the bar in accordance with a logarithmic law. His next step was a statement to the effect that the slope of any curve at a given point measures in geometry the tangent, in dynamics the velocity, in heat the quantity that flows at each point of a body across a given surface, in a small unit of time. He further laid it down that the quantity of heat that one molecule receives from another in a given time is proportional to the difference of temperature of the two molecules, and he derived, for the temperature at any given point along the bar, an equation of the exponential form that in recent years has become familiar in the corresponding problem of electrical transmission, where attenuation is taken into account.

Ohm assumed that the three constants and the mode of handling the differential equations that had been used by Fourier and by Poisson in the heat problem would be directly applicable to electrical conduction. He therefore introduced corresponding coefficients, and he wrote down the differential equation connecting the rate of change of potential with time at any

point along an electrical conductor, in terms of the potential itself and of the second differential of potential in respect to distance. The current was next expressed as the rate of change of potential with distance, multiplied by a coefficient; and he showed that since there can be no heaping up of electricity at a point, such an expression with appropriate coefficients can be applied to composite conductors, or to branched circuits. Further, a branch might be a liquid, provided that there is a good contact at the surface of separation. His first differential equation was subsequently made to represent the steady state by omitting the time term; the integration was thus simplified, and he obtained an expression for the potential at any given point along the conductor—the law of electrical diffusion, where the diffusion occupies the entire conductor. He considered also what happens when such a conductor is left to itself, and further the effect of bringing into contact with it, at a given point, a mass of metal or other conducting substance.

Maxwell (Art. 333, "Electricity and Magnetism") paid full tribute to the excellence of this work of Ohm, but he held that Ohm, misled by the analogy between electricity and heat, entertained the erroneous opinion that a body when raised to a high potential becomes electrified throughout its substance, as if electricity were compressed into it. Maxwell pointed out that although this opinion itself was wrong, it led Ohm to employ the Fourier equations to express the true laws of conduction of electricity through a long wire. In these circumstances it is desirable here to record the original statement of Ohm (p. 145, *Gesammelte Abhandlungen*):

"Es ist nämlich durch theoretische Betrachtungen sowohl als auch durch Versuche, welche an dem elektrischen Strome angestellt worden sind, keinem Zweifel mehr unterworfen, dass die bewegte Elektrizität in das Innere der Körper dringt, und ihre Menge sich deshalb nach dem Körperlichen Raume richtet, während es auf der anderen Seite ebenso ausgemacht ist, dass die ruhende Elektrizität an der Oberfläche der Körper sich sammelt und ihre Menge deswegen von der Flächengrösse abhängig ist."

[From theoretical considerations and by experiments with electric currents, there is left no further doubt that electricity in motion penetrates the interior of bodies, and that consequently the quantity

depends upon the volume of the bodies. On the other hand, it is found that the static electricity on the surface of the bodies accumulates and that its quantity on this account depends upon the extent of the surface.]

It must be remembered that Ohm's task was to bridge the gulf between static charge and the steady state of electric flow. He had to contend with the fact that whereas a static charge resides only on the surface of a conductor, electricity in motion through a wire, for the steady state, utilises not merely the surface but the whole cross-section and substance of the wire. Was he then in error in the manner suggested by Maxwell? The essential distinction that Maxwell wished to emphasize was no doubt that to which he directs attention in Art. 244 of "Electricity and Magnetism." In the electrical case, however powerfully a closed conductor may be charged, there are no signs of electrification within it; and an insulated body within it will, when taken out, exhibit no electrical effects. In the thermal case, if such a conductor is raised to a high temperature, the body within it will, after a considerable time, rise to about the same temperature as the conductor itself, and when it is taken out it will be hot. Conducting bodies can absorb and emit heat, but they can neither absorb nor emit electricity. Hence, in electrical phenomena there is complete absence of anything to correspond to capacity for heat, or in Maxwell's words:

"It is impossible to give a bodily charge of electricity to any substance by forcing an additional quantity of electricity into it."

If Ohm had lived to reply to Maxwell he would have responded—"I never said you could." He should be credited with having used the analogue to Fourier's *capacité de chaleur* with mental reservations.

Heaviside, who otherwise appreciated the work of Ohm, re-echoed the complaint that the assumption that a wire possesses the power of storing up electricity in its substance, like heat, is erroneous. In partial vindication of Ohm, however, he added:

"Why he should have come to the right result by wrong method was simply that, whether electricity is stored up in the substance of a wire, or goes to the surface and stays there, the equations are of exactly the same form."

In the interpretation of Ohm's law by analogies, Heaviside also warned electricians against supposing that electromotive force has to "overcome" resistance, as though resistance were a force of friction. In the sense in which resistance is spoken of in association with Ohm's law, the mechanical analogue of resistance is more closely that of a coefficient of velocity in the case of a body, on a level surface, sliding steadily under the action of a constant force. The constant force (electromotive-force) is represented by the product of the velocity (current) and the coefficient (resistance), there being in this analogy no lifting of the load.

Contemplation of the physical contrasts that manifest themselves in the study of the way in which Ohm's law is established—the distinctions between heat and electricity, mechanical friction and electrical resistance, the residence of static charges of electricity at surfaces and the fact that electrical resistance to steady currents is a function of the whole cross-section, added to the part played by magnetic forces, and the mystery in all these circumstances of how an electric current heats a conductor—thus reveals to us how wide are the gaps yet to be filled between the conventional framework of hypothesis that serves so well as a base for calculation within the present range of electrical knowledge, and the real machinery and scheme of operation of conductance.

The work of Ohm upon so-called "unipolar" substances deserves attention. It relates to experiments by Jäger, Becquerel, Fechner, Hermann, and others, with metallic plates and condensers, particularly with regard to the effect of earth connections and residual charges, and to a group of partial conductors, containing disturbing electromotive forces. It was concerning such results that Biot said that in no branch of physics were there so many differences of opinion and uncertainties of those relating to *galvanismus*, and that there was (1831) scarcely a physicist whose views did not differ from those of every other upon important principles. Becquerel, Davy, Walker, Ritter, Berzelius, de la Rive, and Nobili, were all conspicuous in this heterodoxy. Ohm saw that much of the trouble arose from defective instruments. He realised that the galvanometer as then constructed did not answer the "Wo und Wie" as he called it.

Thereupon he directed attention to the merits of the electrometer that deals with only single points of a circuit, and he advocated the simultaneous use of both instruments, particularly in circuits containing metals and liquids.

Attention became more or less focussed upon an experiment by Ermann. He claimed to have discovered a class of imperfect conductors capable of transmitting more easily one of the electricities than the other. For example, into a piece of soap, alkaline and very dry, he introduced two metallic wires each communicating, respectively, with the poles of a battery. The two poles retained their potentials. But, on touching the soap with a conducting body, the negative pole became discharged, and the positive pole acquired the potential it possessed when the soap was removed and the negative pole was put to earth. He found the same result with the dried white of an egg, with the flame of phosphorus, the flame of alcohol, and with other flames, except that it was the positive pole that became discharged in flames. For this reason he introduced the terms "unipolar-negative" and "unipolar-positive."

Ohm interpreted the results as a property not of the substance interposed between the poles, but of the current that traverses the substance, *i.e.*, as an electrolytic effect. The soap, in his opinion, was decomposed into an acid and into an alkali. The acid he thought to be of an insulating character, and the acid, he supposed, enveloped the positive wire, preventing the positive charge from passing to earth.

The literature of this and allied subjects throughout Europe, for various reasons, covers an extended period. Ohm's book "Die Galvanische Kette" was translated into English in 1841, and into Italian in 1847; Pouillet supplied a translation of part of it in 1837, but it was not available in complete form in French until 1860, when J. M. Gaugain produced an edition with appreciative critical notes. By 1860 it was widely known that Ohm had discovered what was generally called the law of length, section, and derived circuits, but it was not then generally recognised that this law was associated with a theory that embraced innumerable questions relating to the propagation of electricity.

In 1838 *Faraday (Experimental Researches, Vol. 1, No. 1635)* discussed unipolar bodies. His remarks:

"If a unipolar body could exist, *i.e.*, one that could conduct the one electricity and not the other, what very new characters we should have a right to expect in the currents of single electricities passing through them, and how greatly they ought to differ, not only from the common current which is supposed to have both electricities travelling in opposite directions in equal amounts at the same time, but from each other! The facts which are excellent, have, however, gradually been more correctly explained by Becquerel, Andrews and others, and I understand that Professor Ohm has perfected the work, in his close examination of all the phenomena; and after showing that similar phenomena can take place with good conductors, proves that with soap, etc., many of the effects are the mere consequences of the bodies evolved by electrolytic action."

Ohm's researches on this question had appeared in *Schweigger's Jahrbuch der Chemie, Vol. 8, 1830*, and it is in relation to this that Faraday added:

"Not understanding German, it is with extreme regret I confess I have not access, and cannot do justice, to the many most valuable papers in experimental electricity published in that language."

Ohm's contributions to acoustics appeared in Poggendorff's *Annalen* in the years 1839-1843. His researches led to the establishment of his law governing combination tones—by which the human ear proceeds in its analysis.

He showed that the ear can derive the sensation of tone only from that particular motion of the air in which the particles oscillate like a pendulum. Helmholtz summarized the results by stating that every motion of the air that corresponds to a composite assemblage of musical tones is, according to Ohm's acoustic law, capable of being analysed into a sum of simple pendular vibrations, and to each such single simple vibration corresponds a simple tone, sensible to the ear, and having a pitch determined by the periodic time of the corresponding motion of the air. This law rescued acoustics from confusion. Its effect in the development of innumerable applications of physical science is everywhere to be observed. Yet it remained in comparative oblivion for eight years after the death of Ohm, *i.e.*, until Helmholtz in

Das menschliche Gehirn!

Mein Kopf war und dem fügen und noch wollen sich seine Kräfte nicht recht zu.
 zusammen finden, obgleich es im Mittel besser geht. Jede Beschäftigung vor einigen Tagen
 muß ich noch manchen und aber deshalb auch ich die nächste öffentliche Sitzung
 verzichten müssen.

Unter solchen Umständen wird mir auf die von Ihnen verlangte Angabe der
 Verdienste Gay Lussacs schwer fallen und können schwer fallen, wenn ich nicht
 geneigt wäre, daß die nächst Zeit spallend für den Herrn Vogel
 vorzuziehen kommen. Gay Lussac war mehr Experimentator als Physiker und alle seine
 zum physikalischen Arbeiten waren kleine Vorübungen von gewöhnlicher, nicht davon
 für sich ein wenig zur Zusammenfassung blieben. Der Experimentator wird daher
 Ihre Ziele, Herrn Vogel, vollständig zu erfüllen im Stand sein.

Mit der vollkommensten Hochachtung

München den 25^{ten} Nov; 1850

Ew. Hochachtungsvoll

Gesellschaftssekretär
 J. S. Ohm

Figure 9—Handwriting of G. S. Ohm.

TRANSLATION

TO COUNCILLOR VON THIERSCH,—

My head was in a whirl and is still not quite clear, although it feels much better. I must avoid all continuous occupation, and for this reason I shall not be able to attend the next public conference.

Under these conditions, the information you requested, relating to the merits of Gay Lussac would be difficult for me to give—this would cause me distress if I were not certain that you could obtain what is required, rapidly and surely through Councillor Vogel.

Gay Lussac was more of a chemist than a physicist, and all his purely physical work was merely a forerunner of the chemical, to which it always remained most closely related. A chemist will therefore be in a position to fulfil your request completely.

Yours,

G. S. OHM.

Munich, 25th November, 1850.

“Die Lehre von den Tonempfindungen” used it to explain the relation of overtones to music. This achievement of Ohm is enhanced by the fact that he possessed no ear for music. Urged by a strong desire to solve the riddle of musical tone, he enlisted the services of a musical friend to supply an ear, and he found this friend in Dr. Kellermann.

Ohm’s work was based upon the principle that the truth of what is demonstrated by experiment cannot be denied, that what is based upon hypothesis must only be accepted in so far as it is confirmed by observation, that until theory can be exhibited as precise calculations it is imperfect and does not inspire confidence, and that such calculations are the touchstone of hypothesis. His precept was that where these tests are lacking it is best to defer judgment until better data are available. He studied especially conductivity because he imagined that it would lead to knowledge of the internal structure of matter. Bauernfeind states that Ohm’s view was that the attractions and repulsions of magnets should be explained not by supposing the existence of positive and negative magnetism, but by imagining in the atoms (Körperatome) the existence of constant positive and negative currents.

At 10 p.m. on July 6, 1854, on which day, notwithstanding his bodily weakness, he had delivered his lecture, Ohm died. On the following Sunday he was buried at Munich. The grave is in the Sudliche Friedhof which can be reached from the city by way of Sundlingertor Platz and Thalkirchner Strasse. It is near the edge of a path that skirts the front of a building known as the Akadien, within the cemetery. Following that path, the grave is about twenty-three paces from the eastern extremity of the

building. It is overgrown with ivy, but the simple stone stands clear, and is inscribed:

Hier ruht
 GEORG SIMON OHM
 KGL. PROFESSOR
 an der Universität
 in München
 Geb. 16 Marz 1787
 Gest. 7 Juli 1854

[Here lies
 Georg Simon Ohm
 Professor
 at the University
 of Munich
 Born 16th March, 1787
 Died 7th July, 1854.]

It is unfortunate that a philosopher who devoted his life to precision should have inaccuracy stamped upon what is alleged to be his house, and an erroneous date engraved upon his tombstone. He was born not in 1787 but in 1789.

In 1881, The Electrical Congress at Paris adopted the name of Ohm for the practical unit of electrical resistance, 1 Ohm = 10^9 C.G.S. units. The standard Ohm is now determined with an accuracy of about 1 part in 100,000.

As an example of his handwriting, the letter (Figure 9) reproduced from Ludwig Hartmann’s book may be examined. It relates to a request made to Ohm by Thiersch for an obituary notice of Gay-Lussac, who died on May 9, 1850.

Broadcasting in Sweden, Norway and Denmark

By A. TARANGER

Standard Electric Aktieselskap

THE development of electrical communication always has had strong support from the three Scandinavian countries, Sweden, Norway and Denmark. Many of those who aided in its realisation were born within their boundaries, and the present high standard of telephone communication in Scandinavia proves that those responsible for its present progress are keeping in close touch with new inventions and designs that may improve its usefulness.

When broadcasting first appeared on the western horizon on its way from America via England to Europe, its application to Scandinavian conditions was immediately studied by the respective telegraph administrations. Its importance for intelligence communication was evident to all concerned, and it was realised also that the Scandinavian countries would have greater difficulties than the majority of other countries in establishing an efficient broadcasting service—for the lower the density of population, the more insecure is the economical basis for a broadcasting service.

The following data represent the position in this respect:

	Population	Area in km ²	Number of people per km ²
Sweden.....	6,040,000	448,000	13.6
Norway.....	2,750,000	323,800	8.5
Denmark.....	3,390,000	43,000	79.0
England.....	45,000,000	244,000	184.0

From these figures it is apparent that Scandinavian countries, especially Sweden and Norway, when compared with England, have greater difficulties in establishing an effective broadcasting service able to support itself economically.

The small density of the population was, however, not the only difficulty that presented itself to the Scandinavian Administrations. In Sweden and Norway, the geographical conditions were highly unfavourable to the distribution of electromagnetic waves. To appreciate this fact, it is only necessary to point out that the whole

interior of Norway consists almost exclusively of a mountainous plateau with slopes covered by forests. In Sweden the same conditions are found, though less pronounced. The consequence is that the population is distributed throughout a narrow strip round the coast. From the map, Figure 1, showing the density of population and its distribution, the difficulties which arise are evident.

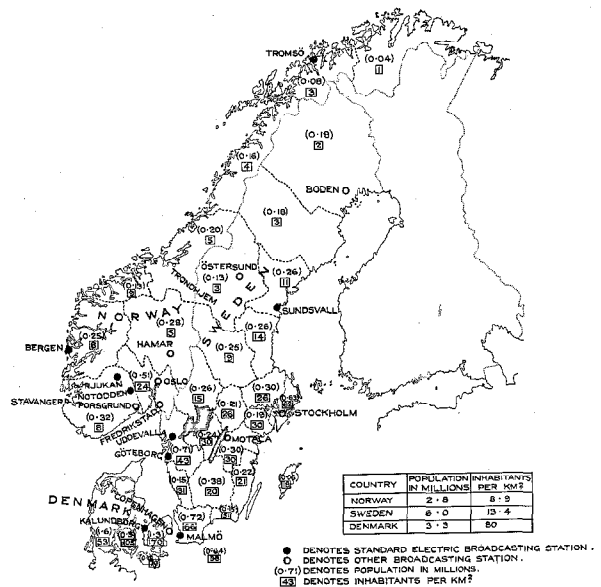

Figure 1—Map Showing Density and Distribution of Population Throughout Scandinavia.

In Denmark, conditions are much more favourable for the transmission of the electromagnetic waves, and also from the standpoint of density of population. The fact, however, that the main supply of programmes must be distributed from Copenhagen, on the island Sjælland, makes it difficult to arrange simultaneous broadcasting over relay stations for the reason that the submarine cables connecting the island with the peninsula Jylland are not suitable for transmitting music.

Sweden

The development of the Swedish broadcasting service is one of the most interesting chapters

in the short but important history of broadcasting. Taking into account its area, and the population living within its boundaries, Sweden must be regarded as having solved the question of establishing a public broadcasting service in a remarkably satisfactory way. Broadcasting started there in the fall of the year 1923, with one small 500-watt station, Western Electric type 1-A; during 1926, as many as 27 stations, involving the use of 6,000 km. of open wire line for simultaneous broadcasting purposes, were in operation. The total number of paid receiving licenses on March 15, 1927, was 265,000, or 44 per thousand of population. The fee is 10 kronor¹ per year, payable in January of each year.

The service exists through the cooperative efforts of the Swedish Government and a private programme service company called A/B Radiotjänst. The Swedish Government purchased all the main stations and all the technical equipment necessary for the simultaneous broadcasting of the programme through all stations. The main stations are Stockholm, Göteborg, Malmö, Sundsvall, Boden, Östersund and Motala. The latter, a high power broadcaster of 30 KW antenna energy, has replaced the station at Karlsborg. The Swedish Government operates all these stations, and supplies the technical apparatus and the operators needed to broadcast any important outside events at any place in Sweden.

The programme service Company supplies all the programmes, and operates studios in all towns having main stations. A local programme board is established in connection with all studios outside of Stockholm. These local boards have considerable power to decide the local programmes for each town, and often they have the opportunity to transmit All-Swedish programmes, viz., programmes simultaneously broadcast by all stations. It is claimed that the service in Sweden is so flexible that in 10 seconds all stations can be switched over from one studio to any other in that country. The headquarters of the programme service are in Stockholm, and from the studio located there, the main part of the programmes are transmitted.

To supervise the expenses involved, and to

¹ One English £ sterling is equivalent to 18.16 Swedish kronor, nearly.

provide interest on the invested capital, the programme service board receives one half, viz., 5 kronors, of the license fee. Amounts left over at the end of each year are returned to the Swedish Government coffers.

In order to control the expenditures as well as to aid in regulating the programme, one representative of the Telegraph Administration is on the Board of Directors of the programme service Company, and two representatives are on the Board of Programmes.

Aside from the seven main stations, twenty smaller relay stations are now in operation. Inasmuch as the Swedish Government obviously could not at once build a complete net of broadcasters to meet the demand of the whole country satisfactorily, temporary licenses were granted to radio clubs in towns outside the service areas of the main stations. Each of these local stations has been allotted a small service area corresponding to their antenna energy. For those who attain a total number of a thousand or more listeners, the Government pays over to the club 2 Swedish kronors per license belonging to that service area. Some of the larger local broadcasters are now operated by technical men from the radio department, who also have taken over the running expenses. These broadcasters are the so-called "desired" broadcasters, viz., stations serving large communities not expected to be included in the service area of the main broadcasters in the near future.

As will be seen from the above, the Swedish operating organization consists of two distinct parts; viz., the Government, and the programme service Company. The Government also exercise control of the service on behalf of the public. The reasons why the Government have taken an active part in the operation side of the service are as follows:

The Government have available in the radio department of the telegraph department, executives, engineers and operators trained in the installation and operation of radio transmitting apparatus; and further, it was estimated originally that the revenue that would be obtained from listeners would not be sufficient to make it possible for a privately financed concern to erect an adequate number of stations of satisfactory power output to serve areas not

comparatively densely populated. Moreover, the fact that the Government toll line service was involved, made it important that the technical side of the service should be dealt with by the Telegraph Administration.

Norway

As early as the spring of 1923, a 500-watt broadcasting station that had been lent to the Norwegian Telegraph and Telephone Administration by the Western Electric Norsk Aktieselskap (now Standard Electric Aktieselskap) was installed in Oslo. The Administration required this station in order to become acquainted with the technical problems involved; and it was hoped also to interest the public sufficiently, so that an idea could be obtained of what support a future operating concern might expect.

The preliminary service was stopped during the fall of the same year. Several attempts were made from different sources to obtain a license from the Norwegian Government to start a broadcasting service, but from various causes, none succeeded. Finally a group, consisting of the three large radio concerns and the Press, came to an agreement with the Norwegian Government, and in February, 1925, the first broadcasting company, Oslo Kringkastingselskap, was started, with a fully paid capital of 350,000 Norwegian kroner² (about £ 19,100). The public readily purchased the shares.

The important terms of the license were as follows:

The Broadcasting Company was granted a license to operate one or more broadcasters within the area enclosed by a circle of 150 km. radius with Oslo as centre.

The Company was required to purchase the stations needed, but these were to be erected on premises chosen by the Norwegian Government through the agency of the radio department of the Norwegian Telegraph Administration. The stations were to be operated by the radio department, but the cost of services so rendered were to be paid for by the Company.

Each listener, within the service area allotted to the Company, pays a fee of 20 kroner, collected by the Telegraph Administration.

² One English £ sterling is equivalent to 18.32 Norwegian kroner, nearly.

For the service, the Administration receives 20 per cent of the total amount of the fees.

Further, a stamp duty is paid on all radio material sold, the duty being collected by all dealers in radio apparatus. The value of the stamps was stipulated to be approximately 10 per cent of the retail value involved.

For the organization of the control service necessary for this stamp duty, and for the collection of the duty from the dealers, the Norwegian Government retains 20 per cent of the total amount. As this stamp duty is also collected on apparatus sold outside the service area of the Company, other broadcasting companies which may be formed for other service areas are given a right to obtain part of this revenue. The division of the revenue is dependent upon the number of listeners registered under each service area. There is one representative of the Norwegian Government on the Board of Directors of the Company.

The license is granted for five years with a right for the Norwegian Government to change the terms of the contract after two years. If the new terms are not agreed upon, the Norwegian Government take over the Company's assets at their book value. The whole plant must be depreciated to no value after five years. At the end of each year, the amount left over of the income of the Company is paid over to the Norwegian Government, with the exception of the payment to the shareholders of 7 per cent on the par value of the stock. Due consideration is given to the necessity for providing funds for future expansion, depreciation of the plant, and losses.

There exist now three operating companies in Norway; viz., Oslo Kringkastingselskap, Bergen Kringkastingselskap, and Troms Kringkasting A/S. The total number of receiving licenses issued is 63,000, of which more than 48,000 belong to the Oslo area; about 11,000 to the Bergen area, and 550 to the Troms area. The rest do not belong to any area.

Two operating companies in Trondhjem and Stavanger are trying to interest local capital, but up to the present, the attempts have not been successful.

There are now eight broadcasters in operation in Norway, of which six belong to the Oslo area, one to the Bergen area, and one to the

Troms area. The operating license is to all intents and purposes alike for the three Companies.

To sum up, it can be said that Norway has adopted a system of several operating concerns to serve the needs of the public under Government control and assistance, but not with financial participation on behalf of the Government.

The difficulty experienced in Norway is mainly that, while Oslo is the most remunerative area, yielding a revenue in excess of what is absolutely needed for a satisfactory service, the Bergen area hardly yields sufficient for the maintenance of good programmes and the running expenses for the stations. Areas with a smaller population will, on the present basis, not yield sufficient income to meet the expenses involved. Naturally the total overhead expenses are larger when three or more companies are established, than when only one company has charge of the whole country. A point in favour of changing the present system is that adequate programmes can only be expected to be obtained from the capital city, Oslo. If these programmes were relayed, a charge would be made to the other broadcasting companies, and in this way the favourable position of the Oslo Company would be further accentuated. On the other hand, when the geographical formation of the country is considered, the consequent spreading of the population along the coast, and the poor state of the toll lines, there are evidently many factors in favour of the establishment of local broadcasting companies.

Denmark

Of the three countries, Denmark was earliest in the field of broadcasting, for the Danish Government station at Lyngby was used partly as a broadcaster towards the end of 1922. Later, through the cooperation of several interested parties, a broadcaster was manufactured and erected in Copenhagen. The radio department of the Telegraph Administration have operated the broadcasting station, and have provided a studio for the use of the programme organization established through the cooperative efforts of radio clubs and dealer associations. Expenses were, in the first in-

stance, covered by a voluntary fee paid by listeners and dealers.

In 1924, however, the Danish Government instituted a compulsory fee for all listeners, but a difference was made between the amounts to be paid by those using crystal sets, and those having valve sets. A definite operating organization was established in 1925.

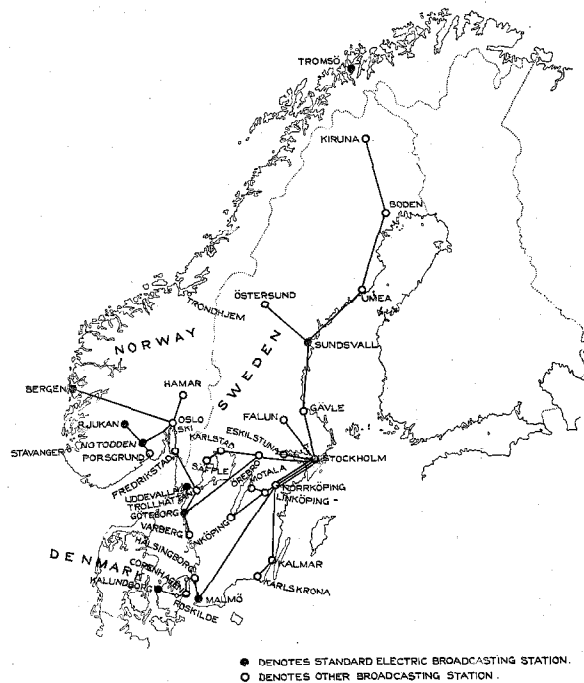

Figure 2—Map Showing Network Used for Simultaneous Broadcast of Scandinavian Programmes.

The Danish Government undertook to erect and operate all broadcasters needed for the country and also agreed to provide the programmes. In order to represent all the interests involved, a supervisory board of thirty-two members was appointed by the Government. This number, however, was too large to be really useful to supervise the extension of the service and the development of the plant and has been reduced to nine. A fee of ten Danish kroner³ is paid by each listener, the total number of whom is now approaching 150,000.

An active feeling existed among the public that their interests were not sufficiently provided for and, in the spring of 1926, the Danish Government decided to purchase a station of

³ One English £ sterling is equivalent to 18.20 Danish kroner, nearly.

7.5 KW antenna energy to serve the whole country and to erect several relay stations in suitable places. The Government installed at Kalundborg, on the island Sjaelland, a 7.5 KW Standard broadcaster, which was placed in service on August 29, 1927. The old Copenhagen station is still working, but is being replaced by a new station now under construction.

The organization chosen by Denmark is completely run by the Danish Government, but the interests of the listeners and the trade have been regarded by incorporating their representatives in a board of control, which in reality is responsible for the broadcast service. The "Radio Council," as the Board of Control is called, is thus an operating concern responsible to and financed by the Danish Government.

The results obtained, as indicated by the number of listeners—approximately 54.8 per thousand on December 31, 1927—show that the system is adequate for the needs of the country, and place Denmark in a position amongst the first broadcasting countries in Europe.

All-Scandinavian Programmes

It is natural that the three countries, Sweden, Norway and Denmark, so closely related geographically, politically, and in the nature of

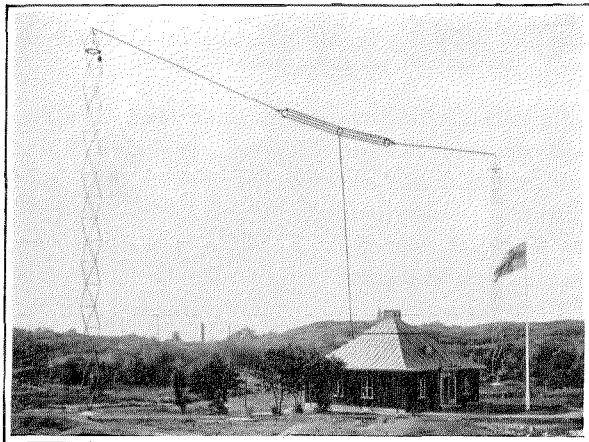

Figure 3—Göteborg (Sweden) Broadcaster.

their people and languages, should cooperate to a considerable extent by interchanging programmes and comparing experiences. During recent years, several All-Scandinavian programmes have been transmitted by all broad-

casters in Scandinavia, and during the winter season the operas arranged by the Swedish programme Company, Radiotjänst, is a regular feature on the Norwegian programmes.

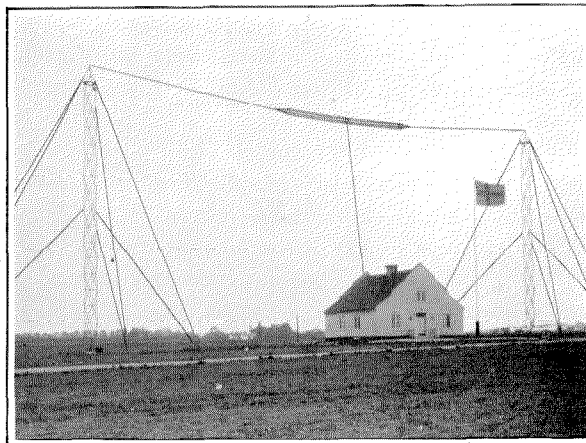

Figure 4—Malmö (Sweden) Broadcaster.

The network used for the simultaneous broadcast of Scandinavian programmes is shown in Figure 2. Relaying musical programmes to Denmark involves technical difficulties arising from the necessity of including a Krarup loaded sea cable between Helsingborg and Helsingör in the line transmission circuit. The frequency-attenuation characteristic of this cable is not satisfactory for the transmission of music, and often it has been found preferable to use the transmission from the Malmö broadcaster as the last link in the circuit between Stockholm and Copenhagen.

The circuit between Stockholm and Oslo involves mainly overhead lines via Göteborg to a small place called Ski, 80 km. outside of Oslo. From there it passes through a special non-loaded pair in the loaded cable Ski-Oslo. This special pair is equalised to give uniform attenuation over the range of frequencies involved in the transmission of music.

As, however, the attenuation of this open wire circuit, approximately 800 km. in length, varies with changes in the leakage resistance, arising from changes in the weather, it is difficult to keep the quality of the All-Scandinavian programme up to the high standard obtained when broadcasting from local studios. Especially in Norway, great difficulties are experienced in keeping the transmission equivalent

constant on long open wire circuits, and tests are now being made to determine the feasibility of replacing the wire circuits by short wave radio transmission circuits.

Broadcasting Stations in Daily Operation

The illustrations (Figures 3 and 4) show broadcasters of Western Electric manufacture now in operation in Göteborg and Malmö. The following is a list of all stations now in daily operation in Sweden, Norway and Denmark:

BROADCASTING STATIONS IN DAILY OPERATION

Name of Station	Wave-length	Antenna Power	Owner
<i>Norway</i>			
Hamer	555.6	1000	Broadcasting Co.
Aalesund	512	500	Government
Porsgrund	500	1000	Broadcasting Co.
Tromsø	500	150	" "
Oslo	461.5	1500	" "
Rjukan	448	250	" "
Fredrikstad	434.8	1000	" "
Notodden	411	800	" "
Bergen	370.4	1500	" "
<i>Denmark</i>			
Kalundborg	1153.8	7500	Government
Copenhagen	337.1	3750	"

BROADCASTING STATIONS IN DAILY OPERATION

Name of Station	Wave-length	Anode KW	Owners and Operators
<i>Sweden</i>			
Boden	1200	1.00	Government
Borås	230.8	0.25	Radio organization
Eskilstuna	250	0.30	" "
Falun	357.1	—	" "
Gävle	204.1	0.40	" "
Göteborg	416.7	1.10	Government
Halmstad	215.8	0.40	Radio organization
Hälsingborg	229	0.40	" "
Hudiksvall	272.7	0.25	" "
Jönköping	201.3	0.40	" "
Kalmar	254.2	0.40	" "
Karlskrona	196	0.40	" "
Karlstad	220.6	0.45	" "
Kiruna	238.1	0.50	" "
Kristinehamn	202.7	0.45	" "
Malmberget	400	0.40	" "
Malmö	260.9	1.10	Government
Motala	1380	40.00	"
Norrköping	275.2	0.40	Radio organization
Stockholm	454.5	1.50	Government
Sundsvall	545.6	1.10	"
Säffe	252.1	0.60	Radio organization
Trollhättan	277.8	0.70	" "
Uddevalla	294.1	0.12	" "
Umeå	229	0.30	" "
Uppsala	500	0.30	" "
Varberg	297	0.40	" "
Örebro	236.2	0.35	" "
Ornsköldsvik	222.2	0.40	" "
Ostersund	720	1.00	Government

KALUNDBORG RADIO¹

By KAY CHRISTIANSEN

Chief Engineer, Danish Telegraph Administration

Introduction

THE Danish main broadcasting station at Kalundborg was opened in August, 1927. It was projected and built by the Danish Telegraph Administration in close cooperation with the manufacturers of the equipment. The radio transmitter was built by Standard Telephones and Cables, Limited, of London, who have been responsible for several important and successful broadcasting stations. This Company was formerly an Associated Company of the Western Electric Company, Incorporated, of America, who have built over two hundred broadcasting equipments, eighteen of which are of a type similar to the Kalundborg broadcaster.² It was these circumstances, together with the comparatively low price, that decided the Administration to adopt this arrangement. So far as relates to the antenna, the construction of the buildings and the placing of the machines, Standard Telephones and Cables, Limited, in all cases approved of the plans of the Danish Telegraph Administration, and on the other hand, the Administration complied with the Company's wishes relating to the station.

Although the transmitter itself was built and tested in London, Standard Telephones and Cables, Limited, conformed to the wishes of the Administration in having the rotating machinery, the transformers, and the switchboards with their instruments and apparatus manufactured by Danish firms. The masts were designed by the consulting engineers, Dr. Nökkentred and Friis Jespersen, and were built by Naskov Skibsværft. They constitute a noteworthy example of entirely Danish labour. The construction of the building, and the arrangements therein, were placed in the hands of Kalundborg

contractors. The antenna and buried wire earth system were made by the Telegraph Office.

Description of System

Before describing the plant at Kalundborg, it is desirable to give a short description of the entire plant, comprising essential parts at Copenhagen, and the lines interconnecting Kalundborg and Copenhagen, Figure 1.

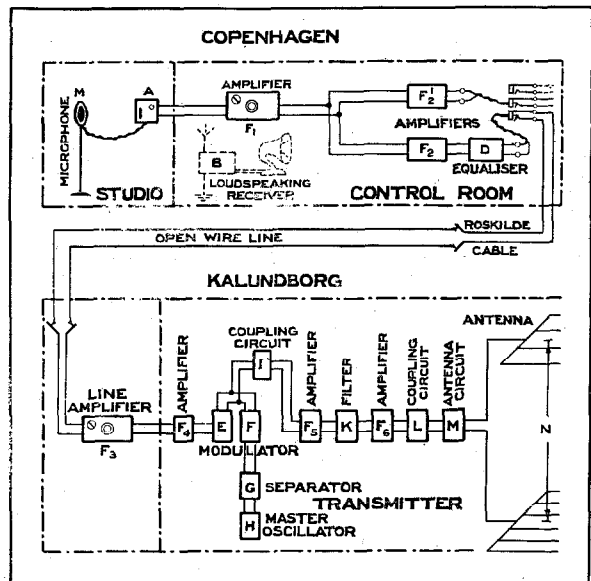

Figure 1—System Diagram, Copenhagen and Kalundborg.

In the studio at Copenhagen is a microphone *M*, supported on a pedestal that can be moved about so that the microphone may always occupy the proper position with regard to performing artists. The cord from the microphone terminates in a small box, *A*, in which is mounted a switch for the microphone current and a little lamp which lights so long as the microphone is connected in circuit. From *A*, the lines are taken to the control-room in which the weak current from the microphone is supplied to *F*₁, which is a 3-valve amplifier. During the transmissions, an operator is always placed at this

¹ From an article in "Elektroteknikerer," Vol. 21, page 497.

² Editor's note: These eighteen stations are distinctive by having a separate master drive oscillator. The combination of this feature with low power modulation was first introduced by the International Standard Electric Corporation. Kalundborg was the first station to go into operation with this improvement.

amplifier in order to alter the amplification ratio in accordance with the requirements of the music. If, when the amplifier F_1 is adjusted for a "pianissimo" passage to be transmitted at suitable intensity, the music should become "forte," the electric effect would probably be too violent. Hence, the amplification ratio must be reduced. In carrying out these adjustments, the operator is aided by an instrument on which the deviations of a pointer show when the amplification is too high. The operator also has at his disposal

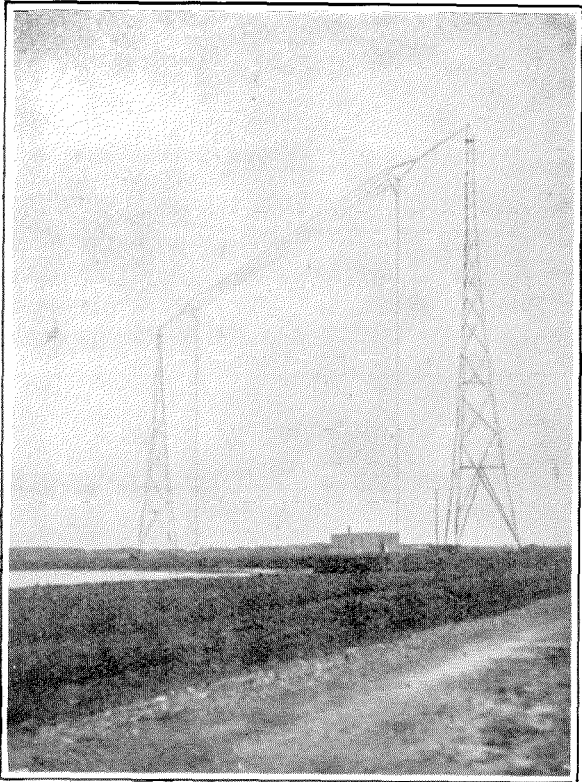

Figure 2—Transmitting Station, Kalundborg.

a controlling receiver B , with which the music transmitted by the broadcast station is received and reproduced by a loudspeaker.

If only one broadcast station is operating, the current from F_1 goes direct to the line; but often the same microphone arrangement is employed both for the station at Copenhagen, and for the station at Kalundborg. In this case, the current is branched off to two amplifiers, F_2 and F^1_2 . The outputs from these two amplifiers are then connected to the two lines to the stations. Amplifiers F_2 and F^1_2 are used in order to prevent

noise in one line from troubling the other station.

Before reaching the line to Kalundborg the current from F_2 passes through an equalizer D which serves for correcting the distortion produced by the line. The connection to the line is by means of cords, so that it is possible quickly to switch over to a reserve line. From Copenhagen to Roskilde, the line consists of particularly heavy type cores in a Krarup cable. From Roskilde to Kalundborg, the line is open wire line. The cable has the disadvantage that it attenuates the high tones more than the low ones. The equalizer D corrects for this disadvantage by favouring the high tones.

When the speech current arrives at Kalundborg, it is amplified by means of a special line amplifier (repeater) F_3 , after which it is impressed upon the radio transmitter comprising a series of different pieces of apparatus.

The first stage is an amplifier F_4 , slightly larger than the amplifiers above mentioned. Its plate voltage is 800 volts. The amplifiers previously mentioned have plate voltages of 150 to 350 volts. The next stage is the modulator, the main components of which are two tubes (E) and (F). The speech is impressed upon the grid circuit of one of them (E), whereas the other (F) receives the high frequency oscillations generated by the master oscillator (H) and amplified by a "separator" (G) before being impressed on the grid of tube (F).

It will be explained later that the result of the operations of the modulator is that the speech or music—which is considered to comprise tones of frequencies from 30 to about 10,000 cycles per second—produces intensity variations in the high frequency current, the frequency of which in this case is about 261,000 cycles per second. The intensity variations correspond exactly to the speech or music. The modulated high frequency current now passes coupling circuit (1) functioning as a filter for removing all undesired components from the current. The pure high frequency current—the variations in amplitude of which represent an "image" of the speech transmitted—is passed on through an amplifier (F_5), a second filtering circuit (K), amplifier (F_6), and coupling circuit (L), which eventually impresses the energy on the antenna circuit (M) in which the antenna proper (N) is the part transmitting the high frequency oscillations to the

ether. The oscillations are still of the frequency determined by the master oscillator; viz., about 261,000 cycles per second, or, in other words, the wave length is about 1,150 metres.

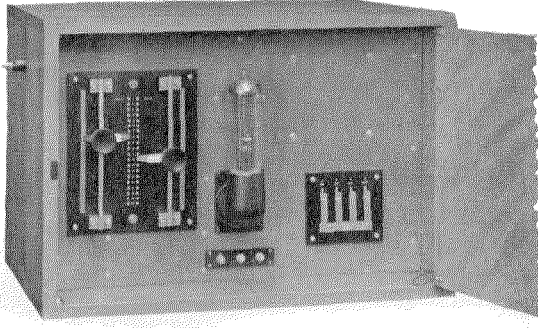

Figure 3A—Master Oscillator.

Method of Operation—Transmitting Station, Kalundborg

The transmitting station is built on the peninsular Gisseløre in the neighbourhood of Kalundborg (Figure 2). The station is here as close to the centre of the country as is possible without necessitating the use of sea cables in the transmission circuit between studio and radio transmitter. The place is very suitable for broadcasting purposes, as the surrounding country is flat.

The object of the master oscillator is to provide the high frequency alternating current to be used as a carrier wave, and at the same time to secure constant frequency. The oscillator is a valve oscillator of low energy. It is contained in a metallically screened box (Figures 3A and B), and it is in principle a Colpitts circuit, characterised by having capacitive reaction.

From the master oscillator, the high frequency energy is taken to the "separator" which is an amplifier tube of the same size as that used in the master oscillator. The object is both to amplify the carrier wave, and to separate the master oscillator from the modulator, so that changes due to the latter do not react on the master oscillator.

From a potentiometer provided with both coarse and fine adjustment, the carrier wave after suitable amplification is taken to the modulator, the circuits of which are shown in Figure 4. The modulation is in accordance with the

Heising system, which is often called the "constant current" system. Two identical tubes (*A* and *B*) both receive their plate voltages through a large inductance (*C*). This inductance has

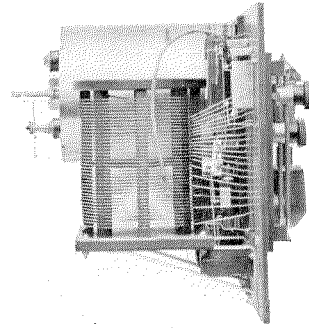

Figure 3B—Master Oscillator (Interior view).

the effect of opposing variations of the current at audio frequency; consequently, if the plate currents of the two tubes are I_1 and I_2 , the sum of I_1 and I_2 is constant. The speech current is supplied from an amplifier comprising a single

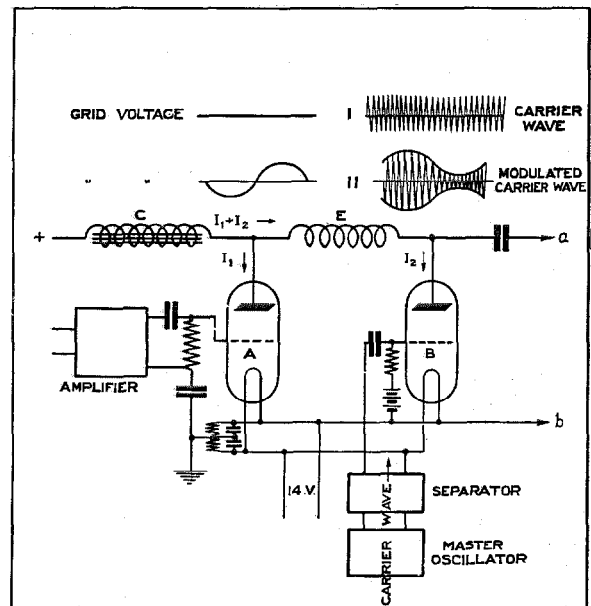

Figure 4—Modulating System Circuit Schematic.

50-watt tube to the grid circuit of tube *A*, which thus means that I_1 varies in accordance with the speech. In other words, as $I_1 + I_2$ must remain constant, I_2 must vary with the speech in such a way that I_2 is large when I_1 is small, and vice versa.

The carrier wave is taken from the separator to tube (B) in which the high frequency current is amplified before passing on in the direction of *a-b*, choke coil (E) being inserted to prevent the high frequency current from flowing towards the left. The modulator will now operate so that the high frequency current (the carrier wave) flows in the plate circuit of B, and its amplitude (indicated by *I*) will remain constant so long as no talking takes place. It has been shown, how-

power. The master oscillator, the separator, and the tube amplifying the speech before it is impressed on the modulator, are all of 50 watts, whereas the two tubes of the modulator are 250 watts each.

The modulated carrier wave is now impressed on interstage circuit (D). The voltage drop across condenser (E) is transferred to the succeeding amplifier which comprises four 250 watt tubes in parallel. (F) is a large blocking con-

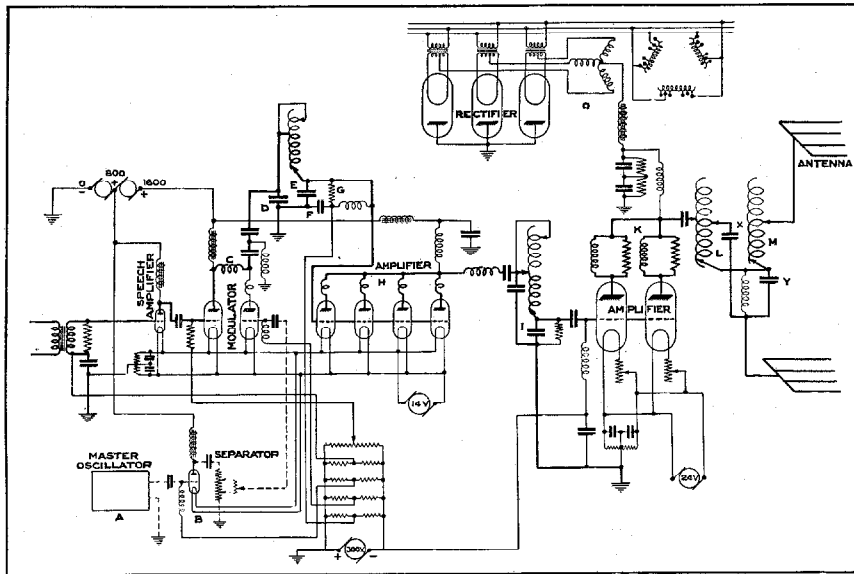

Figure 5—General Circuit Schematic for Radio Transmitter.

ever, that when speech current is supplied to tube (A), I_2 will vary in accordance with the speech; viz., the plate voltage of (B) will vary in accordance with the speech. B's operation as an amplifier is, therefore, no longer undisturbed, but B will amplify the impressed carrier wave more or less according to whether the plate voltage is high or low. Consequently, the amplitude of the carrier wave will vary in accordance with the speech (see II of Figure 4), that is to say, it is modulated.

The remaining apparatus in the transmitter only serves for filtering and amplifying the modulated carrier wave. In Figure 5 is shown a circuit diagram of the transmitter in which the parts of the apparatus mentioned above are easily recognised; viz., the master oscillator, the separator and the modulator, indicated by A, B and C, respectively. It is here necessary to indicate only the approximate values of the

condenser of high capacity so that, as far as high frequency currents are concerned, the resistance (G) may be considered as a shunt to condenser (E). (G) is provided in order to make the damping in circuit (D) so high that the resonance curve becomes broad enough for including both "sidebands"; (G) also provides such conditions that variations in the input impedance of amplifier (H) do not react upon circuit (D). The current is now filtered again in an interstage circuit (I) before finally being impressed upon the high power amplifier (K). This amplifier comprises two water-cooled tubes each capable of handling approximately 15-KW at 12,000 volts. The two tubes are connected in parallel and receive their plate voltage from the rectifier arrangement (O) which obtains its power from a 3-phase, 220-volt, alternating current produced by a motor alternator placed at the station. The plates of the rectifier tubes are water-cooled

and earthed. Consequently, the filaments and the secondaries of the transformers supplying the filament voltage possess a potential in respect to earth. The rectified voltage of about 12,000 volts is passed through smoothing condensers and inductances in the usual manner, in order to be freed from ripple. Before being impressed upon the antenna circuit by way of a capacitive coupling, the entire energy is passed through another filtering circuit.

tuning coil to the earth network, which mainly consists of a great number of copper wires buried in the earth and spaced about a metre apart, at right angles to the direction of the antenna.

When the antenna is correctly tuned, the currents I_1 and I_2 in the two downward leads are equal. At the midpoint, M , of the antenna, the current is zero and the voltage a maximum. It is considered that the advantages of thus making the antenna oscillate in two halves are

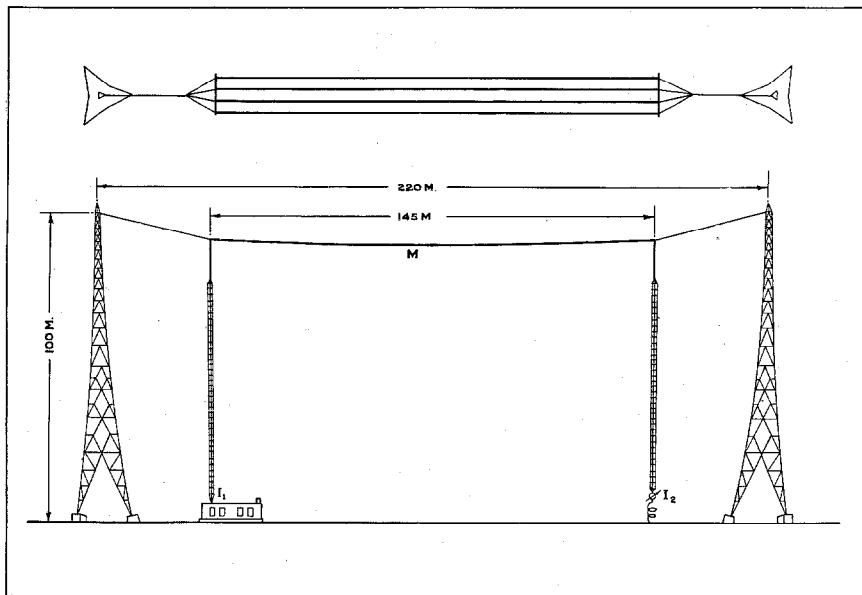

Figure 6—Antenna System.

A motor alternator supplies, in addition to the alternating voltage for the rectifier plant, a voltage for three motor generators for the plate, filament and grid voltages. Of the three generators, one supplies a 16-volt filament voltage and 800- and 1600-volt plate voltage for the air-cooled tubes. Another provides the grid-biasing potentials for all the tubes. The third provides the filament voltage (24 volts) for the two water-cooled tubes.

The antenna is suspended between two masts, 100 metres high, spaced 220 metres apart (Figure 6). The effective antenna length being only 145 metres, there is a considerable distance between the current-carrying leads and the masts, so that the losses therein are highly reduced. The antenna comprises four wires and a downlead at both ends. One of these leads terminates at the transmitter; the other connects through a

that the current distribution to the earth network becomes more effective and produces smaller earth losses. The two downward leads further provide stable antenna construction.

By modulating the carrier wave, a whole series of frequencies arises among which the carrier wave itself and the "sidebands" are predominant and are those wanted in the case of ordinary broadcasting. This band of frequencies is used, in the case of ordinary detection, in the detector of the receiver for reproducing the speech.

The ideal broadcast station should transmit at constant volume a frequency band comprising the entire radio frequency band from 0 to 10,000 cycles. This has not yet been accomplished. A broadcasting station which is to work well in practice must at least be able to reproduce the range from 100 to 5,000 cycles, and a station employable for speech transmission only

must reproduce the range from 200 to 3,000 cycles.

The total widths of the carrier and the two sidebands are in the three cases 20,000, about

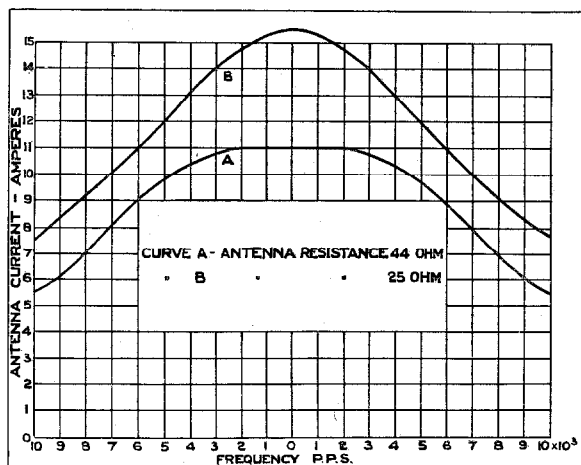

Figure 7—Overall Band-width Curves of Kalundborg Transmitter.

10,000, and about 6,000 cycles per second, respectively. The Kalundborg station which uses a carrier frequency of about 261,000 periods should thus, if it were an ideal station, be able to transmit at the same intensity all frequencies from 251,000 to 271,000 cycles (the corresponding wave range is from about 1,110 metres to about 1,195 metres). This means that all the oscillatory circuits—including the antenna circuit—must possess a certain band width.

Operating Characteristics—Kalundborg Transmitter

Figure 7, the resonance curve of the Kalundborg transmitter, shows the antenna current as a function of the frequency. Curve A corresponds to an antenna resistance of 44 ohms, and curve B to an antenna resistance of 25 ohms. The actual curve lies somewhere between the two, the actual antenna resistance being 36 ohms. The resonance curve is consequently broad—and must be broad—and the common assertion that this should be regarded as a fault at a station, is incorrect.

Figure 8 shows a transmission curve for the transmitter, approximately as the conditions actually are, the wave length in this case being 1200 metres and the antenna resistance 44 ohms.

From 40 to 6,000 cycles, all frequencies are transmitted at exactly the same intensity.

Although the transmission curves are very good, efforts are always being made to improve the characteristics, in accordance with the principle that each part in itself ought to be as perfect as possible. It is worth noting that much better results have been obtained with regard to amplifiers and radio transmitters, than with regard to receivers; receivers, and particularly loud speakers, have much greater faults. It is also far more important that the conditions should be correct at the transmitter, where the amplification ratio of the energy from the microphone to the antenna amounts to something like 2,000 millions.

Safety Features

In a radio transmitter of this power, employing as it does high tension voltages of 800 volts, 1,600 volts and 12,000 volts, it is obvious that arrangements must be provided to protect the operating staff from coming into contact with any apparatus at a dangerous potential. It is also necessary to protect the apparatus from overload. To protect the operators, the equipment is so arranged that meters at high voltage to earth are mounted behind glass screens. When the transmitter door is closed, therefore, there is no danger of an operator coming into

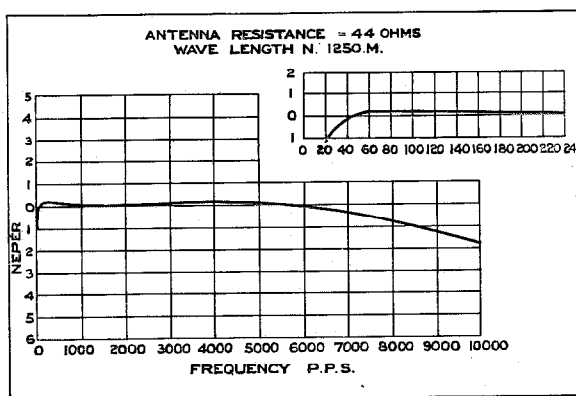

Figure 8—Frequency Characteristic Curve of Kalundborg Transmitter.

contact with any apparatus at a potential dangerous to life. When the enclosure door is opened, a switch operates, and automatically cuts off all high tension supplies.

In order that an operator may be safe when working within the enclosure, two isolating switches are placed just inside the enclosure. These are opened by the operator as soon as he enters the enclosure. They prevent the application of high tension supply to the transmitter. Thus, if another operator should close the door

are inserted in series with these gaps in order to limit the current when a discharge occurs. In addition to the above, the high tension smoothing choke is protected by a ball gap connected across it.

It may be of interest to note incidentally that an overload relay may be operated, owing to a

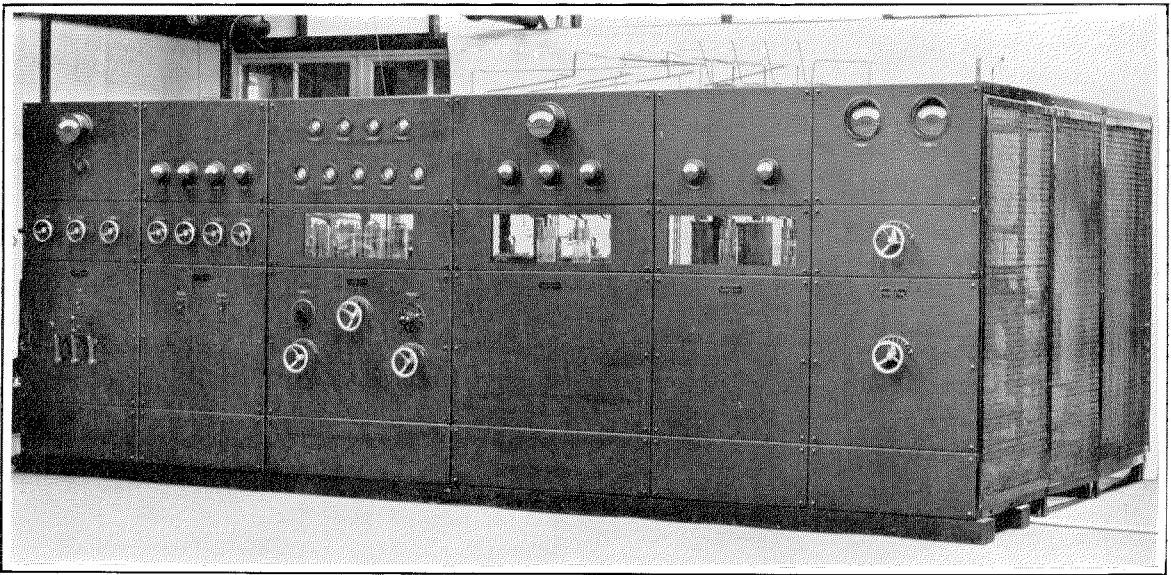

Figure 9—Front View of Radio Transmitter.

accidentally and attempt to apply the power, no high tension supply would be obtained, and therefore the person inside the enclosure would be protected.

To protect the apparatus, the following devices are provided in addition to the normal fuses:

1. Water flow alarm which operates to remove all power to the water-cooled tubes in the event of failure of the water supply.
2. Water temperature alarm, which rings a bell if the temperature becomes excessively high.
3. An overload relay, which protects the 800-volt and 1,600-volt circuits and operates to remove the field from the 800–1,600-volt generator.
4. An overload relay in the 12,000-volt circuit, to protect the water-cooled tubes and to operate to break the supply to the primary of the high tension transformer.
5. Spark gaps, to protect the insulation in the event of high voltage surges: (a) Between each phase of the high tension transformer and ground; and (b) Across the 12,000-volt smoothing condenser. Resistances

sudden peak in modulation. In order that the shut-down period due to this cause may be as short as possible, reset buttons are mounted on the front of the radio transmitter. Thus, when an overload relay operates and disconnects the 1,600-volt or 12,000-volt supply, the associated reset button can be operated, whereupon the interrupted supply is immediately re-applied. If the operation of the overload relay was merely due to excessive modulation, the transmitter will continue to operate when the reset button is pressed, but if the overload persists, the overload relay will again operate and remove the supply concerned.

Elimination of Harmonics in the Carrier

It will be noted from Figure 5 that three coupling, or interstage, circuits are employed—between the modulators and the 4-tube amplifier *H*, between *H* and the power amplifier *K*, and between the power amplifier *K* and the antenna

circuit. These interstage circuits serve to eliminate harmonics of the carrier frequency as follows:

1. When the closed circuit "L" (Figure 5), for instance, is tuned, the impedance of the

2. The "driving voltage" of the antenna is proportional to the reactance of the condenser "Y." As this reactance is very much lower at harmonic frequencies than at the fundamental, the effect of these har-

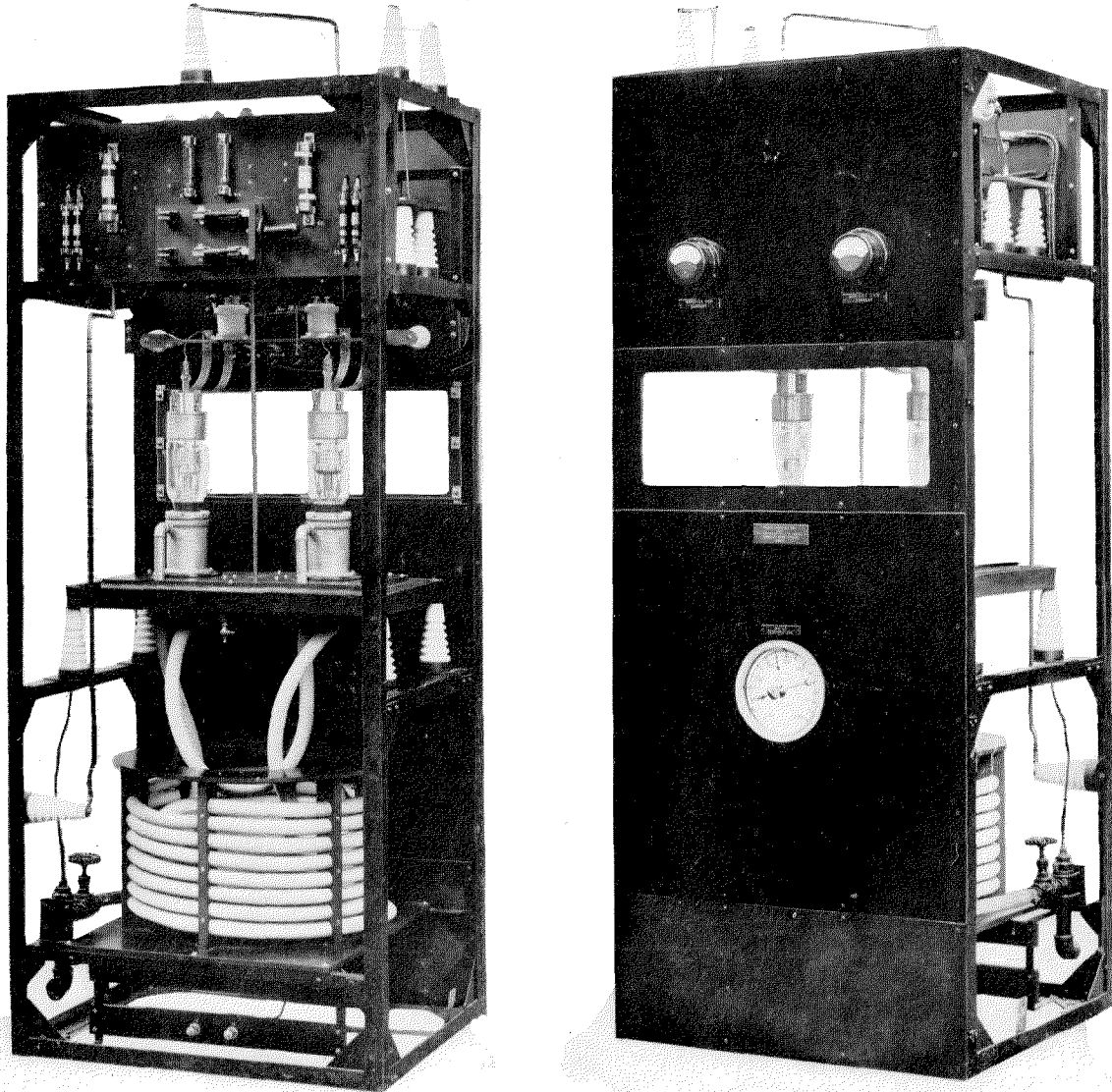

Figure 10—Power Amplifier Unit.

condenser "X" is high at the carrier frequency, but at the frequencies of harmonics, the impedance is very low, and therefore the currents due to harmonics are to a very large extent by-passed to ground.

monic frequencies on the antenna is practically negligible.

The remarks on the coupling circuit "L" also apply to the two interstage circuits "E" and "I." It will be seen that every effort is made to

suppress the radiation of harmonics. The success of these efforts will be appreciated when it is stated that the power radiated due to harmonics is less than one millionth of that radiated at the fundamental frequency.

Transmitter Equipment

Figures 9 to 13 show different views of the interior of the transmitter rooms. Figure 9 is a front view of the transmitter itself. Through the windows the tubes can be seen dimly; first, to the left, the six 250-watt tubes forming the modulator and the intermediate amplifier, then the three rectifier tubes, and finally the two water-cooled tubes forming the high power amplifier.

Figure 10 shows the high power amplifier from both sides. The two water-cooled tubes are inserted into two water-jackets. The water is let in and let out through the long, helically wound tubing, which at the same time serves for providing a suitable resistance to earth. It must be remembered that the potential on the jacket is 12,000 volts.

Figure 11 shows the last panel comprising inductances and a condenser for the circuit before the antenna circuit.

The motor generators for the filament current and the plate voltage were manufactured by

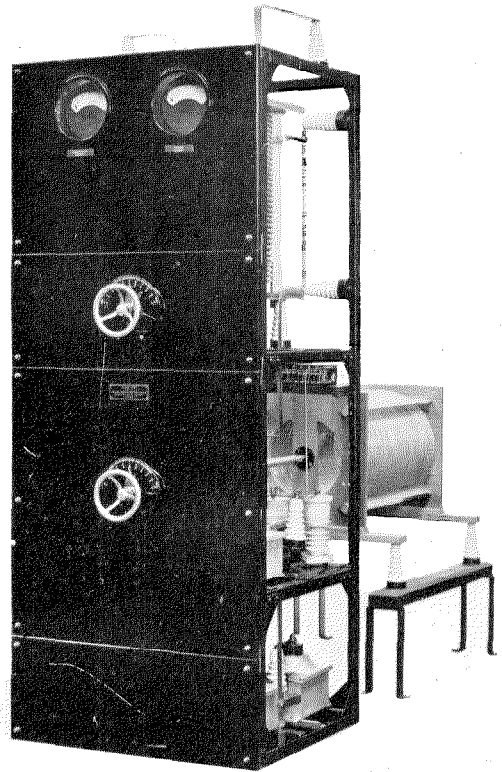

Figure 11—Tuning Unit.

A/S Titan and Thomas B. Thrige. Nordisk Elektrisk Apparatfabrik manufactured the switch gear for the motor alternator.

Controlling "Quality" in a Broadcasting System

By E. K. SANDEMAN

European Engineering Department, International Standard Electric Corporation

IN the theory and practice of radio transmission, the term "quality" refers to the degree of faithfulness of reproduction of speech and music afforded by audio frequency apparatus. In view of the importance of quality in contributing to the enjoyment of the listener, and taking into account the large amount of work that has been done in connection with it, the investigation of the quality characteristics of the radio station at Kalundborg, Denmark, is here described to illustrate the nature of the general problem.

The studio of the Kalundborg Station is situated about sixty miles from Copenhagen. Two Krarup loaded pairs in a cable connect the studio to the station, and serve respectively as music line and control line.

On the occasion of the equalisation of the transmission line, at the request of the Danish Telegraph Administration, a number of quality measurements were made on the component parts of the transmission path. These component parts are indicated in Figure 1.

In the absence of extraneous noise and non-linearity, quality is determined by the curve connecting reproduction-efficiency and frequency. If reproduction-efficiency is defined as the ratio of output power to input power, then, in the case of an amplifier, it is greater than unity and, in the case of a transmission line, less than unity. Since, to a practical degree of approximation, equal percentage increases in the energy of the sound produce equal changes in loudness, the loudness L of a sound is proportional to the logarithm of I , the sound intensity, or symbolically, since

$$\Delta L = \text{constant} \times \frac{\Delta I}{I},$$

proceeding to a limit and integrating,

$$L = \text{constant} \times \log I.$$

In computations dealing with quality, therefore, it is customary to plot the logarithm of the reproduction-efficiency rather than the

reproduction-efficiency itself. If Napierian logarithms are used, then the reproduction¹ is obtained in Népers (βl) by dividing that logarithm by two. If common logarithms are used,

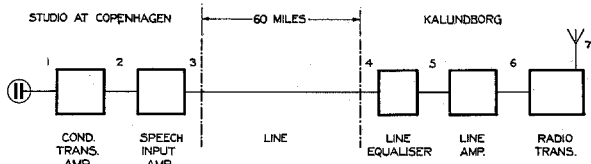

Figure 1—Component Parts of Transmission Path.

the reproduction is obtained in Decibels (TU) by multiplying by ten, thus,

$$\text{Népers } (\beta l) = \left(\frac{1}{2}\right) \log_e \frac{P_2}{P_1},$$

$$\text{Decibels (TU)} = 10 \log_{10} \frac{P_2}{P_1},$$

where P_1 equals the input power and P_2 the output power.

It may be noted incidentally that—

$$\begin{aligned} \text{Népers } (\beta l) &= \frac{1}{2} \times \frac{1}{10} \times \log_e 10 \times \text{Decibels} \\ &= 0.115 \text{ Decibels.} \end{aligned}$$

It is thus evident that whereas attenuation gives rise to a negative number of Népers or Decibels, amplification (gain) gives rise to a positive number of Népers or Decibels. In drawing these curves, it is usual to plot both gain and attenuation as positive quantities; for purposes of combination or comparison, however, an attenuation curve must be inverted before relating it to a gain curve.

Three types of curves are used in this paper in order to indicate the performance of the equipment from a quality standpoint—i.e., gain, attenuation and response curves.

Gain curves are employed in the important case where under normal working conditions

¹The term "reproduction" is here used to embrace both attenuation and amplification.

the output power is always greater than the input power in a fixed ratio. Gain curves are plotted as ordinates, in Decibels at each frequency, expressing the logarithm of the ratio of output to input power. Each ordinate, therefore, represents, independently of the other ordinates, the gain at the frequency indicated; and the larger the ordinate, the greater the reproduced power for a given input.

Attenuation curves are shown where, under normal working conditions, the output power is always less than the input power in a fixed ratio, which is of importance. Attenuation curves are plotted as ordinates in Decibels at each frequency and express the logarithm of the ratio of input to output power. Each ordinate, therefore, represents, independently of the other ordinates, the attenuation at the frequency indicated and the larger the ordinate, the smaller the reproduced power for a given input.

Response curves are used where the magnitude of any isolated observation of power ratio depends upon the conditions of measurement which may or may not coincide with the working conditions as, for instance, where attenuation through the ether is concerned. Response curves are plotted as ordinates in Decibels above or below an arbitrary zero response, defined as the response at 1,000 cycles, in such a way that positive ordinates indicate more gain (or less attenuation) and negative ordinates, less gain (or more attenuation) than the gain (or attenuation) at 1,000 cycles.

Field Measurements

In making the measurements involved in the Kalundborg Broadcasting Station, each piece of

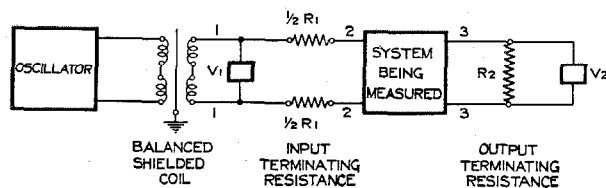

Figure 2—Schematic of General Arrangement for Making Measurements.

equipment, and the system as a whole, were arranged so that the impedance conditions occurring in practice, were closely simulated. At the input of the system, the equivalent of a generator

of constant e.m.f. and of internal impedance equal to that of the apparatus normally connected to the system, was supplied by two series resistances ($\frac{1}{2}$) R_1 as illustrated in Figure 2.

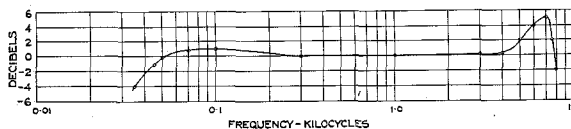

Figure 3—Response from Input of Condenser Transmitter Amplifier to Output of Speech Input Amplifier.

Constant voltage from a valve oscillator was applied at different frequencies to points 1-1. Measurement of this voltage was made by means of a voltmeter at V_1 , consisting of a thermocouple in series with a suitable resistance. At the output of the system, a resistance R_2 simulated the terminating apparatus; the voltage across it was measured by means of a high impedance voltmeter which has been coded as the International Standard Electric No. 74,006-N Transmission Measuring Set. The ratio between ($\frac{1}{2}$) V_1 and V_2 determined the gain or loss of the system.

In making measurements of this character, it is usual to assume that the terminating impedances are pure resistances. This explains why, in extreme cases—where the impedance values of two pieces of apparatus, joined together under operating conditions, differ widely at certain frequencies from the terminating resistance used in making the measurements—the overall curve obtained by adding the ordinates of the individual reproduction curves, may differ from the observed overall curve. If either piece of apparatus presents towards the other, an impedance which does not vary with frequency, then it is justifiable to assume that the overall characteristic may be obtained by combining the individual characteristics, provided that the measuring impedance for both pieces of apparatus is the same, and is equal to the non-varying impedance. Input and output transformers are frequently so designed that, within the range of reproduced frequencies, the impedance which they present to other apparatus is constant, and approximately of zero angle. The output transformer of the speech input amplifier conforms to this, while the input transformer departs from it slightly. For this reason, it was considered

necessary to take an overall characteristic of the speech input equipment only, as shown in Figure 3, while it was not considered necessary to take account of the transition loss between the speech input amplifier and the line.

10,000 cycles. Two mil wire was used for this resistance, in order to make sure that the deviation of the high frequency resistance from the value measured with direct current would be negligible.

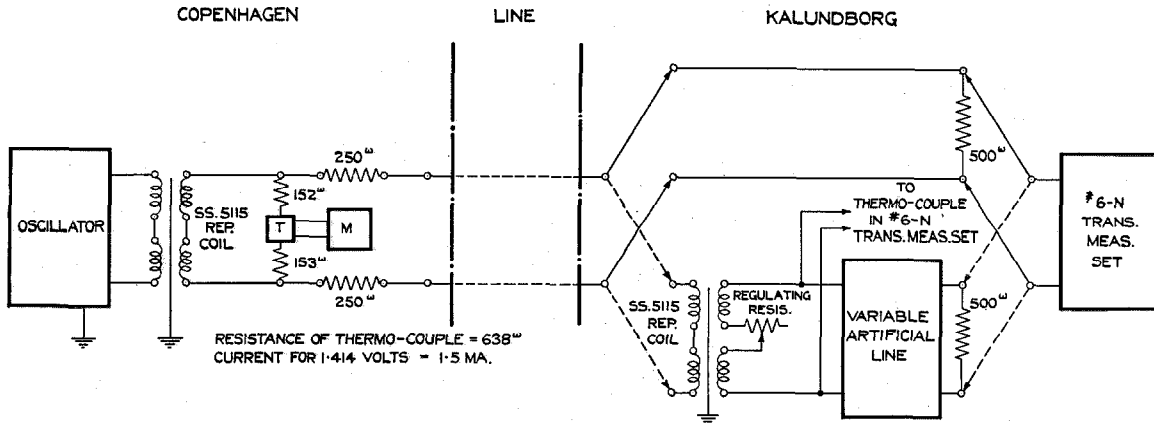

Figure 4—Circuit for Making Attenuation Measurements.

For making attenuation measurements, the arrangements shown in Figure 4 were employed. The alternative circuit obtained by throwing the two double-pole, double-throw switches into the down position was used for calibrating the valve voltmeter in the transmission measuring set. Normally, this set contains means for

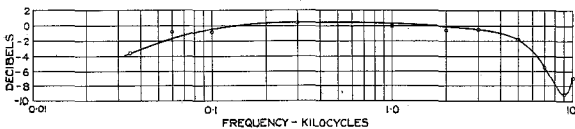

Figure 5—Response Characteristics of Kalundborg Radio Transmitter.

self-calibration, but these means can be used only when a local oscillator, capable of giving adequate power, is available. The power received over the line was not sufficient for this purpose, hence an additional means of calibration was required.

The radio transmitter response measurements (Figure 5) were made with a distortionless receiving set, the circuit of which is shown in Figure 6. The 1,000-ohm resistance, shown in the latter figure in series with the loop, was used for the purpose of broadening the tuning, and so reduced the distortion due to the suppression of the side bands to less than 1/10 Decibel at

The output circuit was designed as a low pass filter matched into its terminating impedances, and introduces a maximum loss of only 1/8 Decibel at 10,000 cycles, the cutoff frequency being 40,000 cycles.

The circuit arrangement for the response measurement on the radio transmitter is shown in Figure 7, which is practically self-explanatory. The thermocouple is intended to maintain the input approximately constant. The response characteristic is given by the differences between the levels measured at each frequency at points A and B, and is expressed in Decibels relative to the difference in level measured at 1,000 cycles. Since difference in levels only is required,

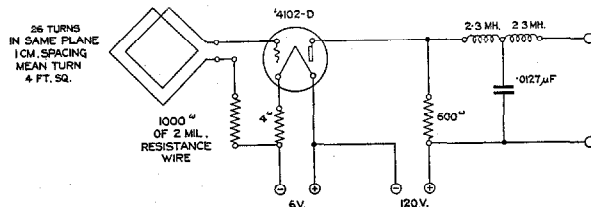

Figure 6—Circuit for Distortionless Receiving Set.

calibration of the No. 74,006-N set before each reading is unnecessary, and a very considerable saving in the time required for making the measurement may be effected.

The overall response measurements, from Copenhagen, to the output of the radio transmitter, were made in the same way as the attenuation measurements, the No. 74,006-N set having been connected to the output of the distortionless receiving set, instead of to the line output. The calibrating arrangements, however, were the same as in the case of the line attenuation measurements.

Since gain measurements on amplifiers are every day occurrences, it need only be mentioned that similar conventions were observed in measuring the amplifier in the studio at Copenhagen, as are adopted in making line attenuation measurements and response measurements.

The No. 74,006-N Transmission Measuring Set

As will be evident from the preceding, most of the measurements on the Kalundborg Station involved the use of the No. 74,006-N set. It is designed to measure transmission levels relative to an arbitrary zero level of one milliwatt in 600 ohms. By comparing the levels at two points in a circuit, transmission equivalents of circuits and apparatus and gains of amplifiers may be measured. It is normally intended to operate at any single frequency between 50 and 5,000 cycles per second, but with care, accurate measurements may be carried out in the range of 30-10,000 cycles per second. The set will

reproduced in Figure 8, and a schematic in Figure 9. The only difference between the No. 74,006-G and the No. 74,006-N sets is that the former is calibrated in British Miles of Standard Cable and the latter in Népers.

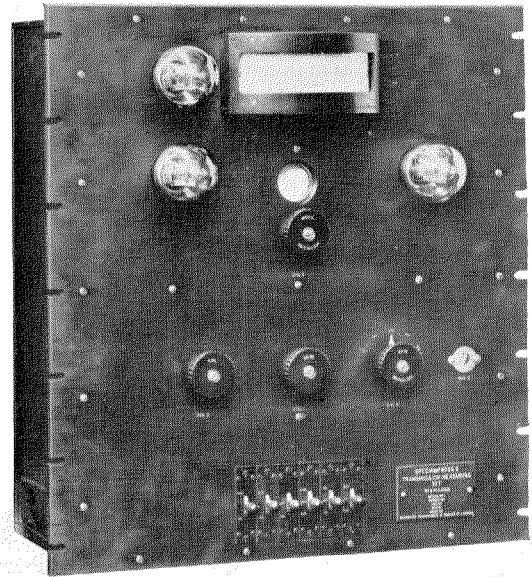

Figure 8—No. 74006-G Transmission Measuring Set.

Attenuation is normally measured by applying to a 600-ohm resistance, in series with the input of the unknown circuit, a voltage such

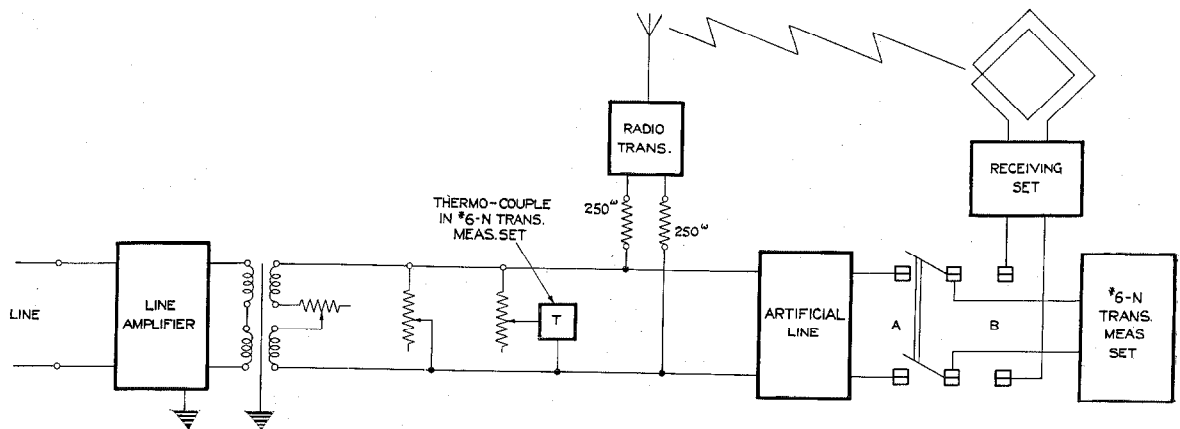

Figure 7—Circuit for Response Measurements on Radio Transmitter.

measure transmission equivalents up to 3 Népers, transmission levels from + 2 to - 3 Népers and gains up to 5 Népers.

A photograph of the No. 74,006-G set is

that, provided the unknown circuit has an impedance which is a pure resistance of 600 ohms, one milliwatt will be supplied to it; the level at the output, when terminated with

600 ohms, is then measured. Losses due to departure of the line impedance from 600 ohms are considered to be part of the measured attenuation. If the two ends of the circuit are

bridged. While the equaliser was intended only to compensate the line distortion up to 7,000 cycles per second, it is interesting to note the great accuracy with which compensation is

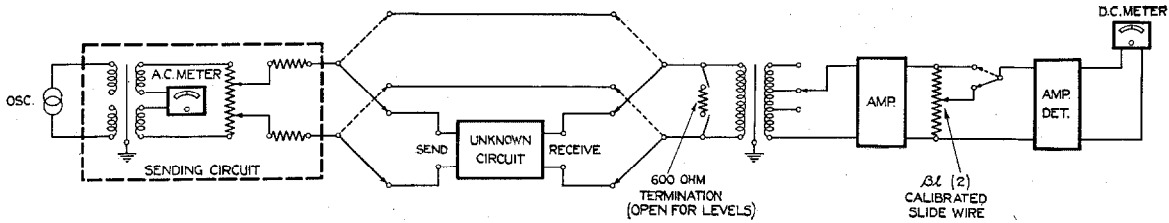

Figure 9—Schematic of No. 74006-G Transmission Measuring Set.

not at the same place, it is necessary either to employ a second transmission measuring set, or other suitable means to supply the input. (For the present tests, 500 ohms were adopted, instead of 600 ohms, to give agreement with the impedance of the apparatus used.)

Readings are taken by means of a calibrated slide wire in the valve voltmeter, which is a potentiometer introducing losses, the magnitude of which is indicated in Népers on the dial. By adjusting the sensitivity of the amplifier detector and applying a known level by means of this calibrating circuit, a meter in the anode circuit of the last valve of the voltmeter is arranged to give a standard (usually midpoint) deflection for any given calibrating level with the potentiometer in the most sensitive position. The unknown level is then applied to the input, and the slide wire is adjusted until the standard deflection is obtained. The value of the unknown level is then indicated on the slide wire dial, in Népers, below zero level.

Kalundborg Broadcasting Station—Results of Measurements

The attenuation of the Copenhagen-Kalundborg music line with 500-ohm terminations, before and after equalisation, is shown in Figure 10; that is, points 3-4 and 3-5 of Figure 1. The equaliser shown schematically in Figure 10 is of the shunt type, and was placed at the output end of the line, firstly, in order that the speech-to-noise ratio in the line might be a maximum, and secondly, to avoid impedance complexity at the output of the speech input amplifier across which monitoring apparatus is

realised in practice when the line attenuation curve is smooth. No deleterious effect was observed due to distortion of transients by the resonances in the equaliser.

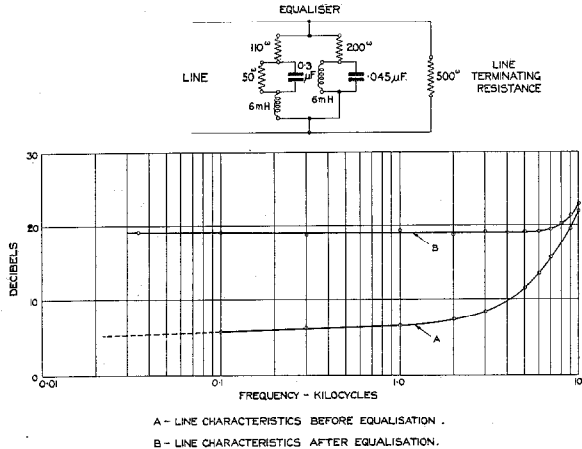

Figure 10—Attenuation of Copenhagen-Kalundborg Music Line Before and After Equalisation.

The attenuation measured from the input (3) of the amplifier at Copenhagen to the output (6) of the line at Kalundborg with 500-ohm terminations is shown in Figure 11.

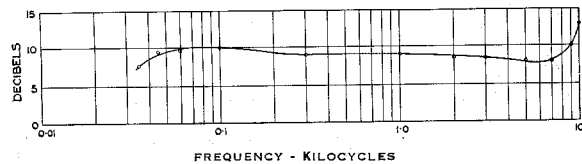

Figure 11—Attenuation of Line + Equaliser + Line Amplifier.

The response of the Kalundborg radio transmitter measured from an input impedance termination of 500 ohms to the distortionless receiving set is indicated in Figure 5. This is

equivalent to a measurement from (6) to (7) in Figure 1.

Figure 12 indicates the response from (3), the input to the line at Copenhagen to (7), the output of the radio transmitter at Kalundborg,

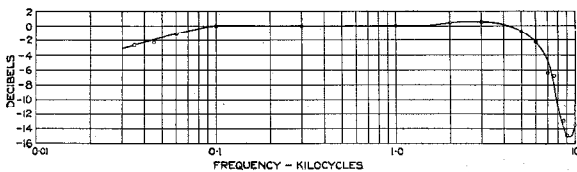

Figure 12—Overall Response from Input to Line at Copenhagen to Output of Radio Transmitter at Kalundborg.

measured from an input impedance of 500 ohms to the distortionless receiving set.

The gain of the speech input amplifier, on full gain operating between 200 and 500 ohms, is shown in Figure 13.

The response curve from (1) the input to the condenser transmitter amplifier to (3) the output of the speech input amplifier is reproduced in Figure 3.

No overall curve—namely, from points 1–7 of Figure 1—was taken, for the reason that the final adjustments of the speech input equipment were made after all measuring gear had been removed from Kalundborg. There is, however,

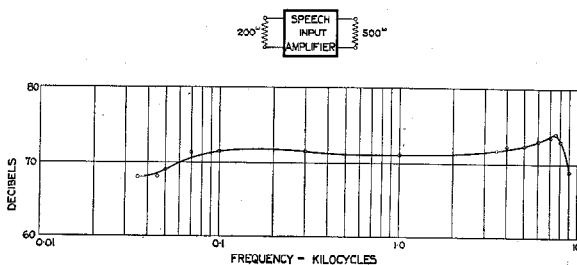

Figure 13—Gain of Speech Input Amplifier.

little reason to expect that unusual transition losses at different frequencies would make the result differ materially from that obtained by combining the curves of Figures 3 and 12 by direct addition of ordinates. This addition has

been made, and the resulting overall curve from points 1 to 7 is shown in Figure 14.

Within the range of reproduced frequencies, 35–7,000 cycles per second, the curve of Figure 14 represents perfect reproduction, as judged by

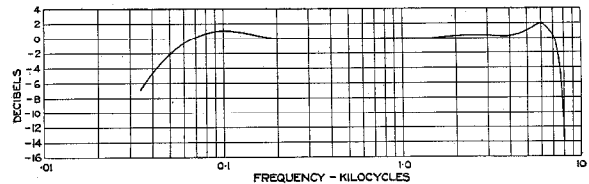

Figure 14—Overall Curve of Whole System.

the ear; and although musical instruments produce frequencies outside of this range, there is not much evidence to show that their æsthetic value is great, even if receiving apparatus were generally available capable of reproducing them, which is not the case.

A response curve is shown in Figure 15, which was obtained from the condenser transmitter of identical type at the laboratories of the International Standard Electric Corporation at Woolwich. Condenser transmitters of this type show only small deviation from instrument to instrument, so that this curve, when combined directly with that of Figure 14 gives the characteristics of the station from air to ether. Since the

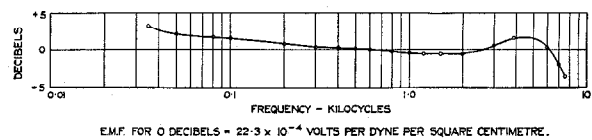

Figure 15—Response Curve of Condenser Transmitter.

condenser transmitter was measured in a circuit identical with that in which it was operated, no distortion is introduced by transition loss.

Acknowledgment

During the course of the work the author was assisted in a very able manner by Mr. R. O. Carter.

Radio Reception and the Broadcasting System

By W. L. McPHERSON

Engineering Department, Standard Telephones and Cables, Ltd.

Introduction

PROBABLY few persons in any civilised community would to-day fail to recognise a radio receiving set at sight. With its valves, its tuning elements and its whole gleaming array of components, it is to millions commonplace, to hundreds of thousands a fascinating toy, easily put together, easily caused to give results considered eminently satisfactory by the happy maker. Reception from the ends of the earth, ear-piercing volume, speech scarcely understandable—results which would certainly have astounded the radio man of the previous decade—are all that is expected or demanded by many listeners. Unfortunately no more is thought possible by a large section of the public who listen in wonder, and stop listening when their curiosity is satisfied. To them, the ordinary receiving set gives nothing intrinsically satisfying; its musical output is blended with false tones and strange noises, obtained in an intermittent manner after much juggling with numerous dials. Occasionally, however, a set is encountered which has been designed according to definite principles, to meet definite requirements, and the output from which appeals even to the fastidious musical ear. In what follows, these definite principles and requirements are discussed and their application to the design of radio broadcast receiving sets is illustrated.

That highly satisfactory results are possible is due entirely to progress made in the radio industry during the present decade, and more particularly in the application of the three-electrode thermionic valve. It is difficult to find any radio function which in one way or another has not been affected by the advent of this valve. As a detector, it has provided a device of great stability combined with efficiency and comparatively large volume capacity. As a high frequency amplifier it has increased the receiving range; and as a low frequency amplifier it has increased the volume of sound which can be delivered. As an oscillator, it has provided a means of changing the frequency of a tone

carrying current. By virtue of reaction or feedback it even gives some control over the resistance of a circuit, and thus over its selectivity. On the laboratory side, it has made available a convenient means of generating steady and undamped high frequency currents; it has simplified enormously all measurements involving high frequencies; and it has made possible the accumulation of trustworthy data by means of which the designer may arrive with comparative ease at the commercial solution of his problems. Nevertheless, the introduction of the valve has not simplified the design of receiving sets. It has brought with it problems of its own—as of stable amplification. It has intensified previously existing problems—the full benefits of amplification, for example, depending on a degree of selectivity far higher than was necessary when amplification was unknown. And in the design of a receiving set of good quality, sensitive, and selective, for broadcast purposes, these problems are found in their full complexity.

The question may be asked, "What are the functions of such a receiving set?" In general terms, they involve:

1. Picking up audio frequency energy carried by radio frequency energy.
2. Translating the radio frequency energy so that the audio signal is made directly available.
3. Delivering the audio frequency energy at a suitable volume level to some reproducing device such as a loud speaker.

The whole process must take place in a manner such that the final output is neither more nor less than an exact replica, in frequency and amplitude variations, of the audio energy actuating the microphone in the particular broadcasting station to which it is desired to listen—and this regardless of whether the station is distant one mile or hundreds of miles, whether it is the only one in the country, or whether it is one of a closely concentrated group.

Such are the functions of the ideal radio broad-

cast receiving set. How close it is possible to approach this ideal will be seen later.

Before proceeding further, it will be helpful to consider in some detail both the nature of the radio telephone signal as used in broadcasting and the process of translating the "radio" signal to a "telephone" signal. This latter process generally goes by the name of detection or rectification.

Nature of the Radio Telephone Signal

Practically all broadcasting stations at the present time operate on the constant current choke control system, or on some system which gives the same overall result—variation of the amplitude of the radiated wave, combined with constant radio frequency, the amplitude variations following in frequency and relative magnitude the variations of the output from the microphone in the broadcasting studio. Expressed mathematically, and assuming for the sake of simplicity that the output from the microphone is a pure tone,

$$i = A \sin \omega t [1 + k \sin (pt + \theta)], \quad (1)^1$$

where i = instantaneous value of the modulated current

A = maximum amplitude of the unmodulated current

$\omega = 2\pi f$

f = frequency of the radio current

$p = 2\pi n$

n = frequency of the microphone output current

θ = phase angle of the microphone output current

k = modulation factor, proportional to the amplitude of the microphone output.

It can be shown² that k must not exceed unity, as otherwise the envelope of the modulated current will no longer be a true reproduction of the modulating current.

If such an expression be analysed it will be found equivalent to the sum of three undamped components of different frequencies, known re-

spectively as the carrier, upper sideband and lower sideband, and given by the following expressions:

$$\text{Carrier} = A \sin \omega t, \quad (2)$$

$$\begin{aligned} \text{Upper Sideband} \\ = - (1/2)kA \cos [(\omega + p)t + \theta], \end{aligned} \quad (3)$$

$$\begin{aligned} \text{Lower Sideband} \\ = + (1/2)kA \cos [(\omega - p)t - \theta]. \end{aligned} \quad (4)$$

The carrier component corresponds, of course, to the unmodulated radio current, while the upper and lower sidebands carry the tone which is being transmitted. The sideband frequencies differ from the frequency of the carrier by plus and minus the modulating frequency, respectively; their amplitudes are equal and proportional to the modulation factor—viz., to the amplitude of the microphone output—and their phases are inverted. In order to secure true reproduction of the transmitted wave, therefore, it is essential that the receiving set should be capable of picking up and passing on with equal efficiency all frequencies between $(f + n)$ and $(f - n)$. Notwithstanding the "constant frequency" of the broadcasting transmitter, the receiving set must handle with uniform efficiency a band of frequencies whose midpoint is that of the carrier, and whose width is $2n$, where n is the highest tone frequency it is intended to transmit. Unless this is accomplished, the input to the translating or detecting device will not be a complete replica of the radiated wave, and the detected output will be modified accordingly. In practice, n is not less than 5000 for good reproduction of music; even this relatively high value is rather low for absolute faithfulness, but only an extremely critical ear will notice the slight loss of quality incurred by this restriction.

Detection

As regards detection, the operation of all the detecting devices in common use depends upon the curvature of the input-output characteristic; viz., on the output containing a term proportional to the square of the input.

Assuming that there is applied to the input terminals of the detector a voltage proportional to the modulated radio current, as given by equation (1), and that the instantaneous output current of the detector is related to the input

¹ John R. Carson, Proceedings Institute of Radio Engineers, Vol. 7, p. 187, 1919.

² R. A. Heising, Proceedings Institute of Radio Engineers, Vol. 9, p. 305, 1921.

voltage by the equation,

$$i_D = a + be + ce^2, \quad (S)$$

where i_D is the output current and a , b , and c are constants for the detector, it will be found that the output contains a whole series of terms which can be grouped as follows:

(a) Amplification terms exactly proportional to the input; viz., frequency and relative amplitude proportional to the carrier and the two sidebands

(b) Three steady current terms derived from the three components of the modulated wave. They are

$$\begin{aligned} &+ (\frac{1}{2})A^2c \dots \dots \text{from the carrier,} \\ &+ (\frac{1}{8})k^2A^2c \dots \dots \text{from the upper sideband,} \\ &+ (\frac{1}{8})k^2A^2c \dots \dots \text{from the lower sideband.} \end{aligned}$$

(c) Two terms of the required output audio frequency,

$$+ (\frac{1}{2})kA^2c \sin (pt + \theta)$$

derived from the upper sideband component, and

$$+ (\frac{1}{2})kA^2c \sin (pt + \theta)$$

derived from the lower sideband component. These two terms, equal in amplitude, frequency, and phase, add together to give $kA^2c \sin (pt + \theta)$ which will in the future be referred to as the true audio output.

(d) An audio term of double the modulating frequency, derived from the two sidebands, and equal to

$$- (\frac{1}{4})k^2A^2c \cos 2(pt + \theta).$$

This is of the nature of a distortion term, and cannot be eliminated unless one of the two sidebands is eliminated.

(e) Double radio frequency terms derived from each of the three components of the modulated wave

$$\begin{aligned} &- (\frac{1}{2})A^2c \cos 2\omega t \\ &+ (\frac{1}{8})k^2A^2c \cos \{2(\omega + p)t + 2\theta\} \\ &+ (\frac{1}{8})k^2A^2c \cos \{2(\omega - p)t - 2\theta\} \end{aligned}$$

(f) A term of twice the carrier frequency, and of amplitude proportional to the square of the modulation factor,

$$- (\frac{1}{4})k^2A^2c \cos 2\omega t.$$

This term is due to beats between the two sidebands.

(g) Terms of twice the carrier frequency, plus and minus the modulating frequency, of amplitude proportional to the modulation factor,

$$- (\frac{1}{2})kA^2c \sin (2\omega t + pt + \theta)$$

derived from beats between the carrier and upper sideband components, and

$$+ (\frac{1}{2})kA^2c \sin (2\omega t - pt - \theta)$$

derived from beats between the carrier and lower sideband components.

Of these groups, (c) and (d) are the most important as they fix directly the character of the audio output. Group (a) is also of importance, as its presence leads to the possibility of reaction or feed back, intentional or accidental. Group (b), which is proportional to the amplitude of both carrier and sidebands but which is independent of carrier and modulation frequencies, has no direct effect either on the character or the intensity of the output; it is, however, one of the most useful groups in connection with signal strength measurements, and in certain cases it is useful in facilitating adjustment of the tuning elements. Groups (f) and (g) are of no direct use, but their presence must be noted as they may appreciably affect the performance of an amplifier in which detector action due say to overloading of the valves occurs.

It will be noticed that quite a number of these terms are due to the presence of both sidebands. If one sideband were completely eliminated, the character of the audio frequency output would be improved, as the double frequency term in group (d) would disappear. In the case of broadcast transmission, such complete suppression of one sideband only, leaving the carrier and the other sideband untouched, is unfortunately not practicable. Assuming that both sidebands are unavoidably present, each contributes to the true audio frequency output, and must be fed to the detector with the same efficiency as the carrier component in order that the set may deliver an audio output truly proportional to the modulating signal.

So far there has been considered only the case of pure tone modulation. In reality the modulating tones are usually complex, and the modulated current may be represented by

$$i = A \sin \omega t [1 + \{k_1 \sin (p_1 t + \theta_1) + k_2 \sin (p_2 t + \theta_2) + \dots\}].$$

In this expression A and ω have the same meaning as before, while k_1 , p_1 , θ_1 , etc., represent the modulation factor, frequency, and phase of the various components which make up the complex tone. Analysing this equation, we get as before a carrier component, a number of upper sideband components of frequency $f + n_1$, $f + n_2$, etc., with amplitudes proportional to $(\frac{1}{2})k_1A$, $(\frac{1}{2})k_2A$, etc., and a corresponding number of lower sideband components. Applying such a complex modulated signal to a square law detector, it will be found that the output contains within the audio range a complex tone $A^2c\sum k \sin (pt + \theta)$ which is the desired term, a distorting complex double frequency tone proportional to $(\frac{1}{4})A^2c\sum k^2 \cos 2(pt + \theta)$ and a number of distorting components of frequencies equal to the sums and differences of the modulating tone component frequencies taken in pairs, and of amplitudes proportional to $(\frac{1}{2})k_1k_2A^2$, $(\frac{1}{2})k_1k_3A^2$, etc., corresponding to the pairs of frequencies n_1 , and n_2 , n_1 and n_3 , etc.

The foregoing analysis is applicable to practically all types of detector which it is economically feasible to use in receiving sets for home reception. It holds good, however, over only a limited range of amplitude. Above this limited range saturation effects come into play, shown up generally by the presence of terms corresponding to the third and fourth powers in the curve connecting input and output of the detector. Both of these introduce audio frequency harmonic terms in the output, and in addition the fourth power gives rise to amplitude distortion of the modulation frequency audio output, usually in the form of a decrease in amplitude by amount $d(3/2)k \sin (pt + \theta)A^4(1 + (3/4)k^2)$, where d is the fourth power coefficient in the input-output equation, and pure tone modulation is assumed. By the addition of this fourth power term it is usually possible to cover the effective working range of the input to detectors of the crystal type, and those depending on curvature of the anode characteristic. In the

case of grid leak detection, the practical amplitude range may be extended still more; there is, however, a definite change in the method of rectification.

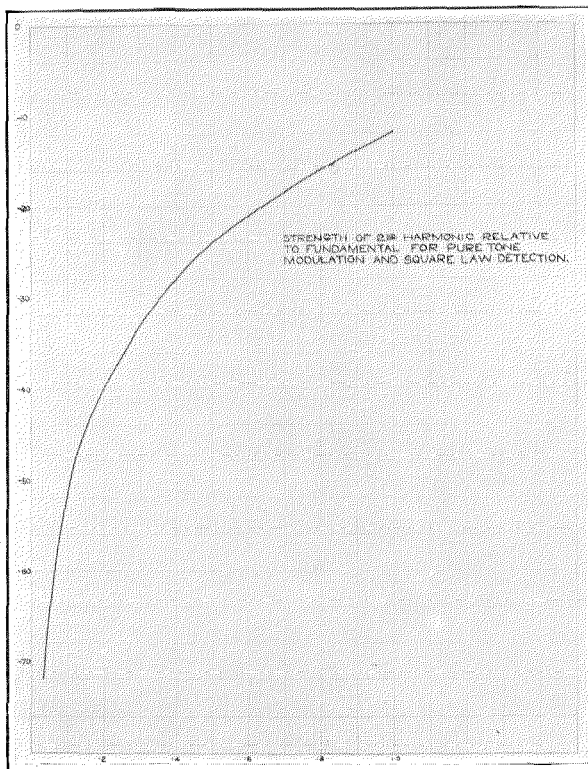

Figure 1—Strength of Second Harmonic.

It may be stated that with all ordinary detectors the safe input range is limited to that over which the square law can be applied, but that this input range can be extended at the expense of a certain amount of amplitude distortion. The amount of the amplitude distortion arising from the presence of an appreciable fourth power term in the input-output equation, and the amount of asymmetric distortion due to the introduction of harmonic frequencies arising from the use of both sidebands of a modulated wave and beats between the sidebands in the case of complex tone modulation, are in each case proportional to the degree of modulation. With low modulation it is almost negligible. This is illustrated in Figure 1, which shows the relative intensity of the fundamental and harmonic components for varying degrees of pure tone modulation; in Figure 2, which shows the relative in-

tensity of fundamental, harmonic, and sum and difference frequencies for varying degrees of modulation by a complex tone ($\sin pt + 0.25 \sin 5 pt$); in Figure 3, which illustrates for a particular case the variation in fundamental output for constant degree of modulation and varying carrier amplitude; and, in Figure 4, which shows for a particular case the amplitude variation of the fundamental due to a fourth power term for constant carrier and varying degree of modulation. Figures 3 and 4 apply to the same detector.

It will be seen from the preceding that the process of detection is not entirely perfect; distortion occurs owing to the introduction of spurious frequencies. Generally speaking, this distortion can be safely neglected. In the first place, all the distorting terms are of the second order of magnitude compared with the fundamental, as they are proportional to the product of the sideband amplitudes, which are usually small relative to the carrier, while the fundamental is proportional to the product of sideband and carrier amplitudes. In the second place, absolutely pure tones are rare; nearly all musical instruments are rich in harmonic tones of sufficient strength to swamp the second harmonics set up in the detector. Thirdly, strong lower tones tend to mask weak higher tones so that they are not perceived. The result of all these factors in combination is that detector distortion arising from beats between the various sidebands is, at its maximum, not perceptible to the average person, and can rarely be detected even by the best musically trained ears.

Before leaving the subject of detection, it is necessary to refer to the grid leak type of detector now in common use. Owing to its performance being a function not only of input amplitude but also of the modulation frequency, this necessitates some modification of the preceding theory. This is obvious when it is remembered that the input impedance contains a capacity element and must, therefore, vary with frequency. On this score the grid leak detector is generally condemned as giving inferior quality to a detector of the anode bend or crystal type whose impedance is—at any rate to a much greater extent— independent of frequency. The objection is, however, academic rather than real; for, pro-

vided the input is held within its proper limits and the values of the grid leak and condenser are suitably chosen with regard to the wave length and modulation frequency, it is practically impossible to distinguish between the two types of detectors. "Provided that the input is held within proper limits"—there we have the real weakness of the grid leak detector, in that it has an appreciably smaller "latitude," to use a photographic term, than has the anode bend type. While highly efficient with small inputs (which is the reason for its popularity) it overloads at relatively small volume, this overloading being accompanied by all the amplitude distortion encountered when an anode bend detector is overloaded. With very large inputs, the "grid leak" functioning may entirely disappear, and the valve may actually operate on the curvature of the plate characteristic at the top bend.

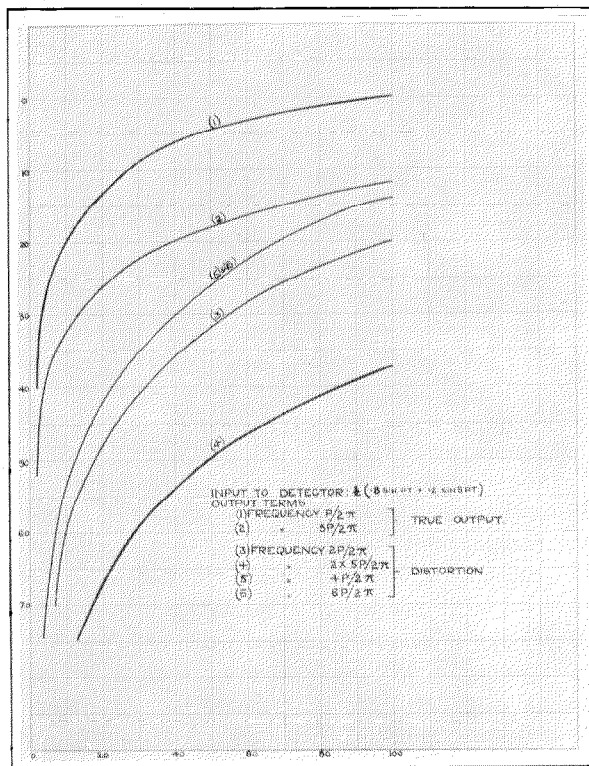

Figure 2—Strength of Harmonics in TU.

The question now arises: How much of the analysis applied to the simple "curvature" detector can also be applied to the grid leak detector? Relative to the latter, no mathematical theory which is not cumbersome to a

degree has yet been evolved; it has, however, been fairly well established that so far as the audio components are concerned, the curvature theory can be safely applied over, at any rate, the safe working range, as may be gathered from

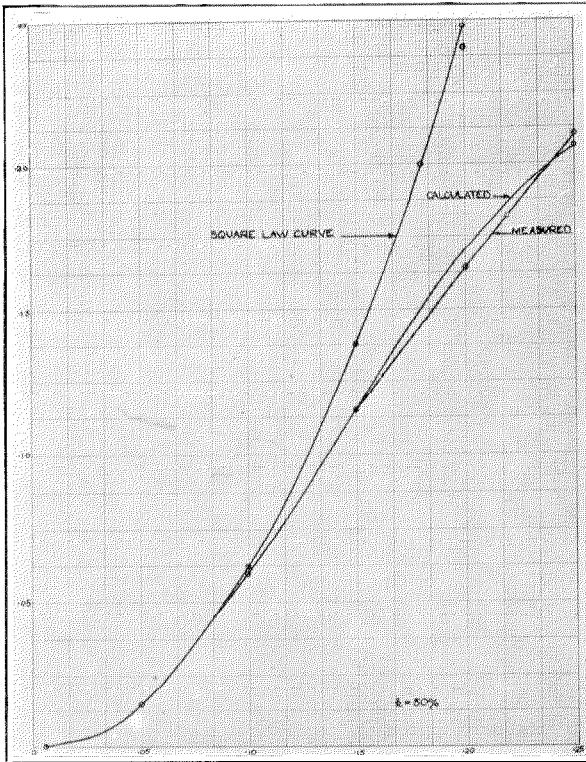

Figure 3—Voltage Output from Detector for Constant Modulation.

Figures 3 and 4, both of which apply to a "peanut" valve acting as grid leak detector. As to the terms of double radio frequency, these are considerably reduced owing to the relative short-circuiting effect at that frequency of the reduced grid condenser impedance. From the practical standpoint, therefore, the simple detector theory already outlined may be regarded, so far as considerations of quality are concerned, as including the grid leak type of detector.

So far we have assumed that the received signal has been available at the detector input terminals without reference to the other parts of the receiving system; viz., the collector or aerial, and the selecting or tuning circuits. It is obvious that we require at the detector input terminals the maximum possible signal (within limits) from the desired station, and from the

desired station only. The actual magnitude of this input depends upon

- (a) The field set up by the transmitting system
- (b) The efficiency of the aerial
- (c) The efficiency of the tuning system
- (d) The constants of the detector in use

Electric Field and Aerial Systems

The field set up by the transmitting station is of course entirely independent of the receiving set, the design of which it determines to a large extent. The magnitude of this field is usually expressed in microvolts per metre, the strength of the (vertical) electric field. Its value is a complicated function of the aerial current and aerial structure at the transmitting station, of the wave length used, of the terrain intervening between the transmitting and receiving sites, and also to some extent of the electrical state of the atmosphere, variations in which are generally believed to be the factor governing the phenomenon known as "fading." In daylight the value is fairly steady, and can be roughly estimated by empirical formulæ of the Austin-Cohen type. Figure 5 may be taken as typical of the field strength from a 1 KW broadcasting station at various distances, for transmission over average agricultural land, with no high intervening hills or thick woods in the immediate vicinity of the receiving station. It will be seen from the curve that a "local" station will give, at a distance of three to four miles, a field strength as great as 25,000 microvolts per metre, while a "distant" station, say one hundred miles away, will give a field of only 150 microvolts per metre.

The efficiency of the aerial system depends partly on the type and partly on the details of construction. There are in practice two main types, the "open" aerial usually erected out of doors, and the closed or "frame" aerial of small dimensions for indoor use. Either type may be *a*periodic or tuned. In general the open aerial is considerably more effective as a collector of energy than is the frame aerial, though not necessarily—indeed not usually—more efficient, taking the efficiency as the ratio of input energy to output energy. The difference in effectiveness is entirely due to the much larger mechanical dimensions of the open aerial.

So far as open aerials are concerned, the designer of a receiving set can only take account of probable electrical constants as determined by the usual amount of space available for the aerial, or the limitation of its dimensions by the law of the land. Figures representative of ordinary practice are—length 100 feet maximum, average about 70 feet; height 20 to 40 feet, capacity 0.0002 to 0.0005 microfarads, inductance approximately 20 microhenries and resistance 20 ohms. Occasionally wide departures from these figures may be encountered due to lack of space, proximity of trees or buildings, the desire to conceal the aerial for the sake of appearance, etc., but for design purposes the figures given above may be taken as meeting the vast majority of cases.

With frame aerials, on the other hand, mechanical dimensions and electrical constants are completely within the designer's control, and their choice is involved in the design of the complete equipment. As already stated, the effectiveness of a frame aerial is less than that of the larger open aerial, but this to a great extent is compensated for by the fact that the frame aerial has strong directional properties, and does not pick up so much atmospheric noise as the non-directional open aerial. Incidentally, it may be explained that atmospheric noise is simply due to the continual readjustment of the electrical state of the atmosphere, and appears as a continuous succession of highly damped electrical disturbances which are scattered over the entire radio frequency spectrum and are not very directional, at any rate over that part of the frequency spectrum occupied by broadcasting. This reduction in noise, due to the directional properties of the frame aerial, contributes materially to the quality of reproduction. In addition to the reduction in general noise, there is the reduction in interference from stations working on the same or very close wave lengths but in a direction forming an angle of say 45 to 135 degrees with the direction of the station being received. This may be considered as giving a degree of selectivity in addition to that obtained by the usual tuning arrangements and in a form which has the special feature that it does not involve the frequency response characteristic and so cannot affect quality by failure to trans-

mit all the sideband frequencies with the same efficiency.

For high grade reproduction, therefore, the frame aerial has distinct advantages over the open aerial, notwithstanding the higher effectiveness of the latter as a collector of signal voltages; and when, in addition to these advantages, its convenience in portability, neatness of appearance and entire absence of disfiguring external wiring and masts is considered, it is evident that the open aerial survives only because it permits the use of simple sets with low running costs due to decreased need for amplification and hence fewer valves.

In designing a frame aerial the main factors to be considered are the "pickup" or signal field collecting power, the minimum wave length to be received, and the resistance. The pickup is proportional to the area-turns, which should

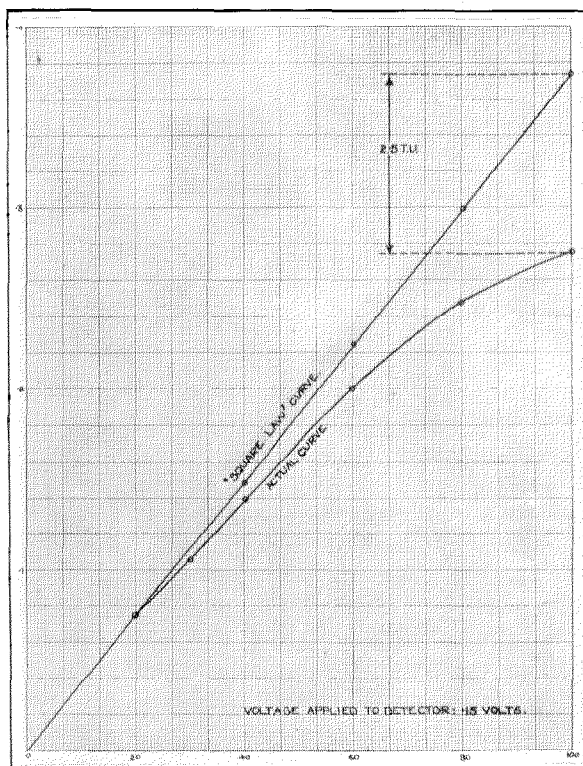

Figure 4—Voltage Output from Detector for Varying Modulation.

therefore be made as large as possible. The area of the frame is, however, subject to limitations on account of general convenience, portability, appearance, etc., and for ordinary domestic use an area of four square feet can seldom

be exceeded; this area should approximate to the circular in shape, but for manufacturing reasons a square shape is usually adopted. The number of turns is limited by the minimum wave length it is desired to receive, as governed by

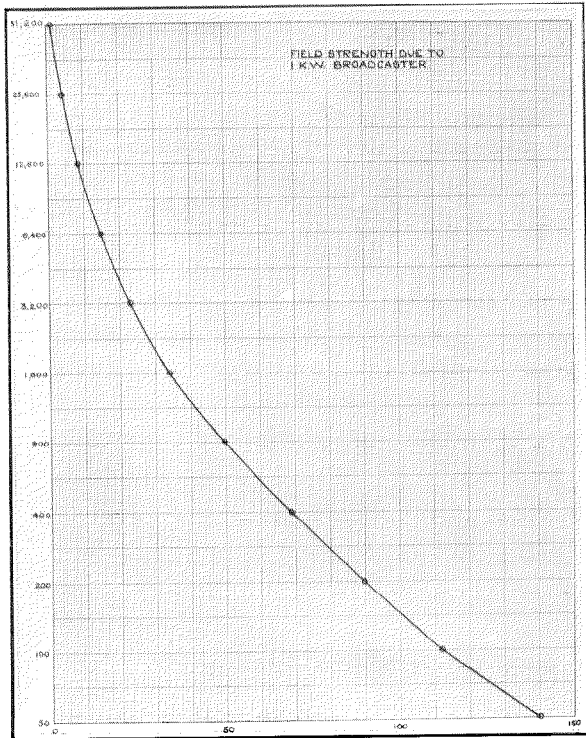

Figure 5.

the minimum tuning capacity available and the inductance of the frame aerial itself. The minimum tuning capacity is itself a function of the construction of the frame, as it includes the self-capacity of the frame winding, and varies with the spacing of the turns and area of the frame. The resistance of the frame depends upon the type of wire, total length of wire, and distribution of the turns. The problem resolves itself in fact into the design of a tuning inductance for the desired wave lengths and resistance, to occupy a given area as above and to operate in conjunction with a given tuning condenser.

With the mass of accumulated data now available, the design of a frame aerial is a comparatively simple problem provided the wave length band to be covered is restricted to the normal broadcasting wave lengths of 200 to 600 metres. Most of the aerials in practical use approximate

to one of square shape with 2 foot sides and ten to twelve turns with 0.25 inch spacing of stranded wire. Where a larger band of wave lengths is to be covered, as in the case where it is desired to include long wave stations such as Daventry and Radio-Paris, the design becomes a much more difficult problem, as the large number of turns necessary for pickup on the longer waves involve "dead end" and other capacity effects which seriously react on the efficiency when using the aerial for short wave reception. It is absolutely necessary in such cases to sectionalise the frame winding, connecting the sections as required through switches of very low capacity. The standard type of telephone key is quite unsuitable, owing to the high capacity between the springs. In extreme cases it may even be necessary, on account of manufacturing expense, to use fewer turns than the theoretical possible, and compromise by using the maximum practicable number of turns and adding loading coils to bring up the total inductance to the value required for tuning purposes. This is the case, for example, in the No. 44001 Frame Aerial, shown in Figure 12. The single layer winding, carried by four spreaders, has a total of 21 turns of which only 10 are used for pickup and tuning purposes on wave lengths up to 800 metres, the remainder being disconnected and open circuited by means of the switch carried in the box at the foot of the frame. All the turns are used for pickup and tuning on wave lengths between 800 and 1400 metres; while for wave lengths between 1400 and 3000 metres, all the turns are used for pickup purposes and in addition the inductance coils carried in the switch box are cut in by the switch and used in series with the inductance of the frame winding for tuning purposes.

The efficiency of the tuning system must be considered from two aspects. In the first place, tuning—viz., the deliberate introduction of resonance—is necessarily employed in the majority of cases in order to obtain the maximum output from the collector system, which always possesses a certain amount of reactance. Secondly, resonance is employed to enable selection to be made between stations operating on different wave lengths. The inductances and condensers used to balance the reactance of the collector system are, however, not pure reactances, and their presence

adds a certain amount to the losses directly associated with the collector; moreover, absolutely sharp tuning or resonance while tending to high selectivity also tends to loss of quality. As already pointed out, a radio telephonic signal is carried not on one frequency, but on a band of frequencies, and a resonant system must inevitably tend to reduce the efficiency of collection or transmission of some of these frequencies at the expense of others. If the resonant frequency of the system is made to correspond to the carrier frequency, then the upper and lower sidebands will be symmetrically attenuated, the attenuation being higher with increase of modulating frequency. In extreme cases this effect is sufficiently serious to render speech very drummy and of low intelligibility, while musical quality is utterly destroyed. Within the normal broadcasting band of wave lengths, the ratio of modulating frequency to carrier is so low that exceedingly sharp resonance is necessary for the effect to be noticeable, and the losses in the components normally used are such that the resonance curve is kept sufficiently blunt to ensure at least a high degree of uniformity in the transmission of all the side frequencies, with correspondingly high quality. If, however, "reaction" or "feed back" is used to bring up the volume efficiency, it does so in effect by reducing the losses in the system, and may easily render the resonance curve of the system so sharp that the failure to transmit to the detector the higher side frequencies is very noticeable in musical items or even in speech.

Bearing these considerations in mind, it will be seen that the efficiency of the tuning system is a rather elastic quantity, depending partly on what is possible in the design of the tuning elements, and partly on what importance is attached to quality as against selecting power. It can be stated, however, that with average apparatus the overall efficiency of the collector (aerial) and tuning system is such that an open aerial will deliver to the detector a carrier voltage of approximately one hundred times the field strength in units per metre while a closed frame aerial will deliver approximately one-tenth that amount, when receiving within the normal band used by broadcasting stations; viz., on wave lengths between 200 and 600 metres. On longer

wave lengths the efficiency may be appreciably smaller unless recourse is had to proportionately larger aerials which are not always possible or convenient. There are, however, comparatively few broadcasting stations operating on wave lengths above 600 metres, and such as do exist are of exceptionally high power, which compensates to a considerable extent for the decrease in receiving system efficiency due to limitation of aerial dimensions.

Referring now to the two field strengths already quoted for "average" local and distant broadcasting stations, and using the aerial and tuning system efficiencies as above, we see that

(a) The local station will deliver to the detector a carrier voltage of approximately 2.5 volts, receiving on an open aerial, or 0.25 volts, receiving on a frame aerial.

(b) The distant station will deliver to the detector a carrier voltage of approximately .015 volts, receiving on an open aerial, or 0.0015 volts, receiving on a frame aerial.

Since practically all detectors available for use in ordinary receiving sets require a carrier voltage of approximately 0.2 volts in order to give a telephone signal of reasonable intensity in head receivers, the local station will give really strong reception; the distant station will, however, probably be quite inaudible, the detector requiring at least thirteen times the available voltage. This increase in voltage may be obtained by interposing some form of high frequency amplification prior to detection. If frame aerial reception is used, the local station will still be able to operate the detector, but the volume will be considerably less than with the open aerial. Assuming that the detector follows the square law up to an input of 2.5 volts, the reduction in signal strength due to substituting a frame for an open aerial will be approximately 40 TU. Few detectors, however, obey the square law over such a comparatively wide range, and the difference in volume between the open aerial and the frame aerial actually will be considerably less than 40 TU, the signal on open aerial being weaker than the theoretical value due to the strong fourth power term—which incidentally may cause appreciable amplitude distortion at such a high input.

Selectivity and Amplification

At this point, it is desirable to consider the set with respect to its selectivity characteristics. Local and distant broadcasting stations, it has been noted, may give signal fields of 25,000 and 150 microvolts, respectively, and the frequency separation between the two stations may be as low as 20,000 cycles. Selectivity, as previously indicated, is attained through the application of the principle of resonance. The question now is, what degree of selectivity is required, and in what way can resonance be applied, so that the receiving set can discriminate between two voltages having a ratio of 25,000 to 150, viz., a ratio of 167, and a frequency separation of 20,000 cycles say in 750,000, corresponding to wave lengths of 400 metres and 411 metres for the two stations. It is apparent that the stronger signal must be attenuated 167 times to give a signal equivalent to that of the weaker, and at least another ten times in order that the distant station may be clearly heard above it, thus giving a requirement of a total attenuation of 1670 of one signal frequency when the set is adjusted for the other signal frequency. Furthermore, provision must be made for obtaining this attenuation at any wave length within the broadcast band.

Given this selectivity, there still remains the question of detecting the weaker signal. As already stated, this must be amplified at least thirteen times, in order to get reasonable audibility and in actual practice an amplification of thirty to forty is advisable, for open aerial reception. If frame aerial reception is desired, the requisite amplification is of the order of three or four hundred.

In addition to the selectivity and amplification required, one other point requires consideration. Some means, obviously, must be provided for controlling the amount of amplification, in order to avoid distortion when receiving a strong signal as from the local station. Such a signal, applied to the detector, through an amplifier capable of raising the distant station signal to a suitable level, would only result in saturation of both amplifier and detector, with accompanying distortion, which probably would be increased as a result of overloading on the output side of the detector.

Grouping these various requirements, it is clearly advantageous to split up the selecting arrangements into two main divisions, the first connected with the aerial tuning system proper, and the other included in the amplifier, so that in proportion as the signal sought for is weak, the necessary amplification is accompanied automatically by increased selectivity. Such an arrangement is almost universal, and tends to simplify the difficulties otherwise involved in constructing high frequency amplifiers which will cover the whole broadcast band without adjustment. This is especially the case in Europe, where it is necessary to arrange sets so that the few, but important, long wave stations such as Daventry and Radio-Paris can be tuned in as well as the stations on the more normal wave length band of 200 to 600 metres in use both in Europe and America. In what follows, therefore, no mention will be made of other than "tuned" systems of high frequency amplification.

The three leading methods of amplifying a radio telephonic signal at the present time are by means of

- (a) "Reaction"
- (b) "Tuned anode" valve amplifiers
- (c) The "supersonic" method

Of these three, only the latter two methods are strictly within the definition, in that the output is truly proportional to the input; but the use of reaction is in practice so closely allied to the use of amplification proper that it seems expedient to deal with it at the same time.

Amplification by reaction is obtained by feeding the signal energy to a valve which is adjusted so as to be just on the threshold of oscillation at the same frequency as the incoming carrier. Under these conditions the incoming signal has a trigger effect and sets the valve circuit into actual oscillation so long as the signal lasts, and power is fed back to the input side, just to balance the power which would normally be expended in that input circuit by the incoming signal. The system as a whole behaves to the signal voltage as though the resistance of the circuits had vanished. Therefore, the signal is able to set up very much larger currents than would otherwise be the case, and the output

may be considered as amplified relative to what it would be if no reaction were used. A typical circuit is shown in Figure 6.

Probably no weapon in the armoury of the radio engineer has been more seriously abused than has reaction. It costs little to apply it to any valve detector set; the increase in signal strength is very marked; and the increase in

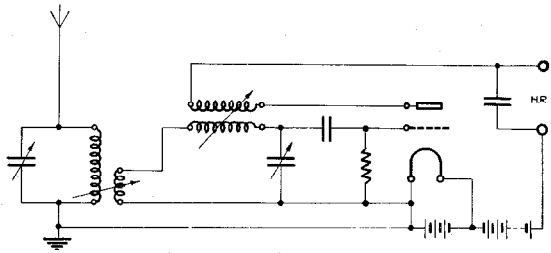

Figure 6—Simple Reaction Amplifying Circuit.

sensitivity is at times enormous owing to the fact that the amplification possible is not a constant but increases almost linearly with decrease in strength of the incoming signal when the latter is weak. It, however, has two very serious disadvantages when applied to a broadcast receiving set. The first disadvantage is that owing to its apparent neutralisation of the resistance of the circuit, very sharp resonance is produced, with attendant loss of quality due to cut off of the higher modulating frequencies, this loss of quality being proportional to the amplification obtained with any particular adjustment of the degree of reaction or feed-back. As a result of the very sharp resonance, selectivity is concentrated in one circuit and its tuning rendered very delicate. The second, and most serious disadvantage, is that unless the greatest care is taken in handling the set, the valve will actually burst into oscillation and act as a low power transmitter which may combine with the broadcast signal to produce an interfering tone which will be picked up by all receiving sets within a radius of a mile or more and thus spoil the reception from the broadcasting station. Moreover, this interfering tone is heard in the originating receiver with considerably greater strength than is the modulated telephonic signal, and there is thus a strong temptation to the user deliberately to bring his set into oscillation in order to facilitate "searching" for a weak station.

The nuisance arising from the accidental or deliberate misuse of reaction in this way is too well known to need further comment. It must be emphasised, however, that the nuisance arises from the misuse of reaction. If precautions are taken either in actual operation, or by arranging the circuits so that if the set does burst into oscillation little or no energy is transferred back to the aerial, reaction must be regarded as a legitimate tool even in a telephonic receiving set, provided of course that due weight is given to the probable effect on quality. Taking the latter aspect as the governing one, it has been found in practice that an equivalent amplification of ten can be usefully obtained by the application of the feed-back principle. Variations in valve characteristics, however, are such that in order to be sure of reaching this figure it is usually necessary to arrange the circuits so that full control is obtained of the amount of reaction, viz., some adjustment must be provided capable of bringing the set into oscillation; thus, the quality obtained from the set is to a considerable extent dependent on the discretion of the user.

Amplification by means of a tuned anode system is now very common. An elementary circuit is that shown in Figure 7, which illustrates a single stage of amplification feeding a valve detector. It will be noticed that part of the tuning is directly associated with the aerial,

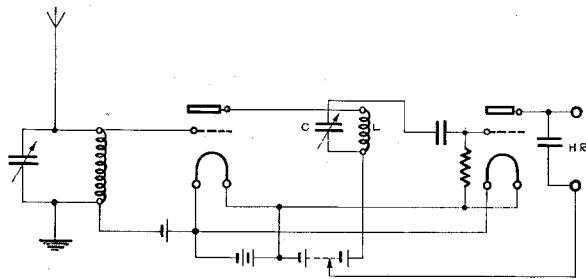

Figure 7—Simple Tuned Anode Amplifying Circuit.

additional selectivity being obtained through the resonance of the anode circuit, C.L., only the signals selected being amplified and any others being by-passed. At first sight it would appear that the selectivity of the amplifier portion is dependent only on the constants of the C.L. circuit, that is to say, on the inductive and capacitive reactances of the tuning elements,

and the resistance of the closed resonant system, due chiefly to the coil itself. This, however, is not the case. The impedance of the amplifying valve must be considered as in series with the e.m.f. feeding the closed system, and as exerting an appreciable damping effect. As a result, receiving sets employing tuned anode amplification as a rule require at least two stages of such amplification if a high degree of selectivity is to be obtained, and with three fairly critical tuning adjustments their use becomes rather difficult unless each adjustment is provided with calibration. Against this disadvantage must be balanced the good quality obtained due to selection in a series of relatively flat resonance circuits avoiding cutoff of the side frequencies. This type of amplifier is increasingly popular for high grade sets in America, where the wave length band is limited; in Europe its good quality is beginning to be appreciated, but the necessity for providing for the long wave stations in conjunction with interchangeable tuning coils has so far deterred manufacturers from taking it up to any great extent.

While the circuit in Figure 7 shows the tuned anode system in its simplest form, and one very common in actual practice, other forms of it are frequently encountered. The resonant circuit, C.L., may be replaced by an air-core transformer with either or both primary and secondary tuned by variable condensers, or the anode may be coupled to the tuned circuit through only a portion of the inductance. All these variations reduce, when analysed, to the equivalent of the simple circuit in the diagram; their chief advantage is that they offer a means of equating the plate load to the impedance of the valve itself, and also offer possibilities of increasing the selectivity at the expense of signal strength. In addition to these variations, where two or more stages of amplification are employed it is generally necessary to provide some form of reversed feed-back to neutralise the feed-back which inevitably occurs through the capacity between the electrodes of the valves, and which might cause serious internal oscillation, or at any rate a tendency to oscillation which would have a disastrous effect on the quality of reproduction. Where only one stage of amplification is employed, the increase in signal strength obtained is seldom sufficient for ordinary work, and it is

usual to increase the gain by the introduction of reaction, the circuit being arranged to feed back energy not to the aerial circuit, but to the tuned anode circuit. The interposition of the amplifying valve between the seat of the reinforced oscillations and the aerial is supposed to prevent any re-radiation in the event of reaction being deliberately or accidentally pushed so far as to cause the generation of oscillations. It must be acknowledged, however, that this supposition is not usually borne out in practice, for even if no coupling exists between the elements of the various tuned circuits, sufficient energy may be fed back through the valve inter-electrode capacity to cause some disturbance; while it not infrequently happens that before the anode cir-

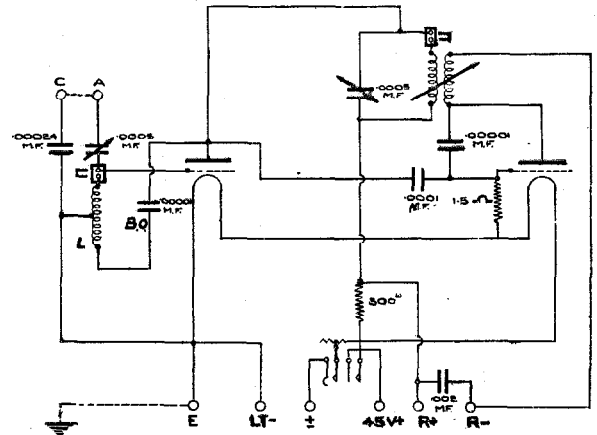

Figure 8—Circuit Diagram of Weconomy Two-valve Detector and Tuner Set.

circuit itself is brought to the point of oscillation sufficient feed-back occurs through the valve capacity to set the aerial itself into vigorous oscillation, to the detriment of all other receivers in the immediate neighbourhood. This possibility, however, can be largely obviated if the precaution is taken to provide a compensating reversed feed-back circuit (Figure 8) as employed in the No. 44081 Receiving Set. This set includes one stage of tuned anode amplification with reaction on the tuned anode, and the provision of a neutralising circuit consisting of the balancing condenser B.O. and the inductance coil L. The balancing condenser is equal in capacity to the condenser formed by the grid and plate electrodes of the amplifying valve, while the neutralising coil is coupled to the aerial tuning coil in such a way that the mutual

inductance between the two coils is equal to the mutual inductance between the aerial tuning coil and the complete aerial circuit—viz., to the inductance of the tuning coil itself—but opposite in sign. The operation of this circuit is as follows:

The signal field sets up an e.m.f. in the aerial circuit, and causes currents to flow therein, the corresponding potential across the tuning inductance being transferred to the grid of the amplifying valve; the amplified potential appears across the tuned anode circuit, or effectively between the anode and filament or earth, and in addition to the currents set up in the tuned anode circuit a current is fed back through the valve capacity to the grid and through the tuning coil to earth, inducing in the aerial circuit an e.m.f. corresponding to the magnitude of the current and the mutual inductance between the tuning coil and the aerial circuit as a whole. Another current is driven through the balancing condenser

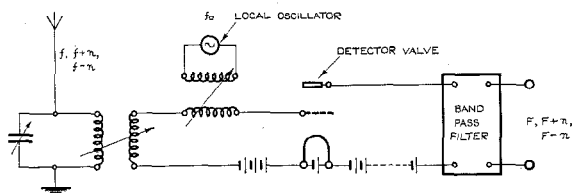

Figure 9—Simple Supersonic Circuit Schematic.

and the neutralising coil to earth, and induces in the aerial circuit an e.m.f., corresponding to the value of the current and the mutual inductance between the neutralising coil and the aerial circuit. Since the magnitudes of the currents are almost entirely dependent on the capacities in their paths, and these capacities are made equal, the currents are equal, while the e.m.f.'s induced in the aerial circuit will be equal but of opposite sign, owing to the sense in which the windings are connected. Thus no voltage set up in the anode circuit of the amplifier will give any effective feed-back, and there is no possibility of re-radiation. For this to be strictly true with the circuit shown, some means should be provided for adjusting the self and mutual inductance of the neutralising coil in accordance with changes in wave length, to correspond with changes of the effective coupling between the tuning coil and the aerial, and changes in phase relationships. In practice, however, it has been found sufficient to fix the adjustments of the

balancing circuits once for all, so far as operation over the wave lengths covered by a fixed tuning coil and variable condenser is concerned.

Amplification by the supersonic method presents what admittedly is one of the most remarkable applications of radio technique on the reception side. Practically every possible use of the valve is exploited in turn, from the generation of oscillations to the amplification and detection of oscillations, and the resultant circuit, complex both in construction and in functioning, is yet exceedingly simple in operation, and can be made to yield a degree of selectivity as high as is consistent with good quality of reproduction.

The supersonic system is characterised by two main features: transfer of the signal modulation from the received carrier frequency to another much lower but still supersonic frequency (generally referred to as "intermediate" rather than "supersonic") and amplification of the new modulated carrier in an amplifier designed to deal with that particular carrier frequency only, followed by detection as in ordinary sets. No signal can be amplified unless its frequency is first converted to that intermediate frequency for which the amplifier is designed. The amplifier itself, having to handle only one carrier frequency (of course with the attendant sidebands due to modulation) can be designed for much greater efficiency than is possible in an amplifier covering the whole wave length band used by the various broadcasting stations; while the constants of the selecting circuits in the amplifier can be fixed once for all, and adjusted to pass the frequency band requisite for good quality, with very large attenuation for all frequencies outside this band.

The manner in which the signal modulation is transferred from the original carrier to a new carrier of intermediate or supersonic frequency is indicated in Figure 9. The signal may be received by means of any convenient system, such as an open aerial, and is fed to a detector valve together with a strong voltage from some local oscillator, of frequency $f_0 = f - F$, where F is the carrier frequency for which the amplifier is designed. The total input to the detector is then proportional to

$$A \sin \omega t - \left(\frac{1}{2}\right)kA \cos [(\omega + p)t + \theta] + \left(\frac{1}{2}\right)kA \cos [(\omega - p)t - \theta] + B \cos 2\pi f_0 t,$$

where the first three terms represent the input components due to the signal carrier and the signal sidebands, and $B \cos 2\pi f_0 t$ is the input due to the local oscillator. Beats will occur between the signal components and the local oscillator component, owing to the ordinary detector action as outlined previously; and amongst a large number of other terms the output of the detector will be found on analysis to contain the following three components:

$$AB \sin 2\pi Ft; - \left(\frac{1}{2}\right)kAB \cos [(2\pi F + p)t + \theta]; \\ + \left(\frac{1}{2}\right)kAB \cos [(2\pi F - p)t - \theta].$$

It is obvious that these three components correspond to a modulated wave of frequency F , that for which the amplifier is designed, the modulation being exactly proportional to the original signal wave, $k \sin (pt + \theta)$.

The question may be asked, how is it possible to use a detector at the very beginning of the system, seeing that the whole necessity for using high frequency amplification arises owing to the signal being too weak to operate a detector. The answer is that detection in the initial stages of a supersonic receiving set is not applied to the incoming signal by itself, but to the incoming signal considered as very weak sidebands of the strong local carrier of amplitude which is by design made sufficiently powerful to ensure efficient detection. The amplitude of the resultant intermediate frequency carrier is proportional to the product of the amplitudes of the incoming signal carrier and the local beating carrier, and could be made indefinitely large if the square law of detection held good for all inputs independent of magnitude. As already mentioned, however, the square law of detection holds good for only a limited range of detector input, and a negative fourth power term comes into consideration, the effect of which is to determine a definite optimum value for B . In practice it is advisable to work rather below this optimum value, so as to ensure that the modulation carried by the intermediate frequency wave is an exact duplicate of that carried by the incoming signal wave.

In addition to the required output, the detector delivers terms corresponding to twice the local carrier frequency, twice the frequency of the signal components, etc. These extra components are filtered out either before or during

amplification, so that only the modulated wave of frequency F is fed to the final detector. All of these "stray" components are of very much higher frequency than F and there is no difficulty in eliminating them, a relatively simple filter sufficing.

The preceding explanation of the conditions necessary for the transference of the modulation to the intermediate frequency is based on the

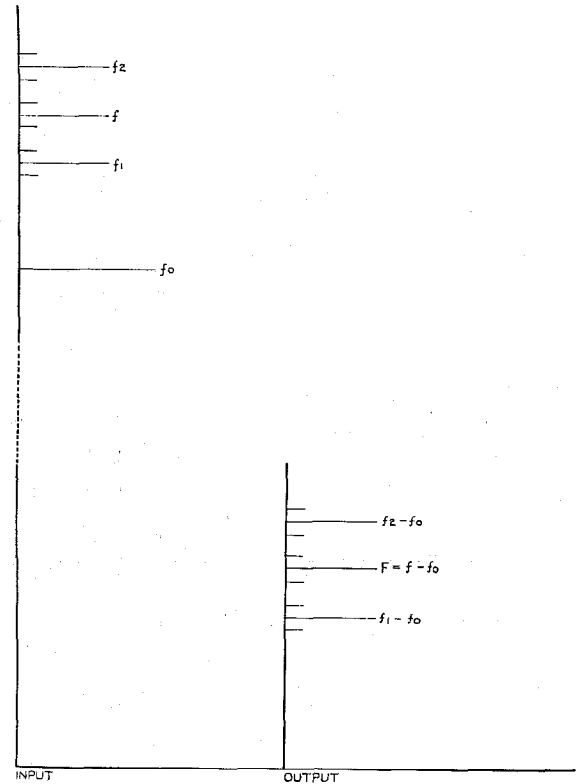

Figure 10 A

Figure 10 B

Supersonic Frequency Spectra.

assumption that the frequency of the local oscillator is lower than the signal carrier frequency by the amount F . It is, however, equally possible to obtain the required transference by using a local oscillator frequency which is higher than the signal carrier by the intermediate frequency. The essential condition is that the difference between the received and local carrier frequencies is made equal to that for which the amplifier is designed. For any particular received frequency there are, therefore, two possible settings of the local carrier

which may be used. That this choice is available is sometimes a feature of considerable value, especially when very severe interference is encountered.

In order to emphasize the fact that supersonic amplification, notwithstanding its complexity, does not involve the employment of methods which in themselves result in loss of quality, the expression "transfer of modulation" has here been used. It is, however, equally correct to view the process as one of changing the carrier frequency from that actually received to that fed to the amplifier. If a number of stations are being picked up simultaneously on various wave lengths and fed to the frequency-changing detector together with some local carrier as

and f_1 is much greater after the frequency changing than originally, and hence it is very much easier to separate one from the other by means of resonance or band pass filters. This feature accounts to a great extent for the extraordinary selectivity which it is possible to attain with supersonic receiving sets. In fact, the selectivity obtainable on the output side of the detector is so great that care must be taken not to allow it to become excessive, otherwise some of the upper side frequencies of the desired signal will be cut off. Tuned anode circuits are especially dangerous in this respect; in general it is preferable to avoid having any highly resonant circuits in the intermediate frequency amplifier.

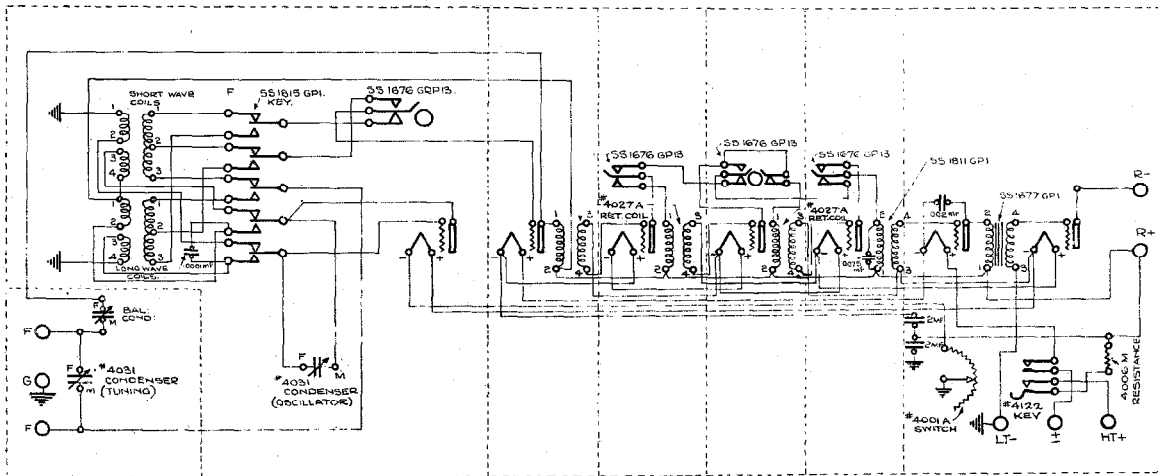

Figure 11—Schematic of the No. 4002 Radio Receiving Set.

above, the received signals will be reproduced on the output side of the detector with all their carriers changed to new values equal to the difference between the local carrier frequency and the original carrier frequencies. This is shown diagrammatically in Figure 10. Here f_0 is the frequency of the local carrier, while f , f_1 , f_2 , are received signal carriers, each with its own set of sidebands. Figure 10a shows their distribution along the frequency spectrum as they are fed to the detector; while Figure 10b shows the distribution of the output along the frequency spectrum. Everything is displaced, but the numerical separation between the various elements is unaltered. The result is that the percentage difference between say the carriers f

The choice of a suitable value for the intermediate frequency is governed by a number of considerations. The lower limit is implied in the name "supersonic"; so far as the human ear is concerned, anything above 30,000 cycles per second can be considered as supersonic, which, when allowance is made for tone modulation up to 5000 cycles, gives a lower limit of 35,000 cycles per second for the carrier frequency for which the amplifier should be designed. If instead of the human ear, the limit of audible frequency be based on the characteristics of existing sound reproducers, we may safely choose a frequency somewhere about 10,000, giving a lower limit of 15,000 cycles for the intermediate frequency. The upper limit is, of course, fixed

by the lowest carrier frequency which will be received. Within these limits, the design of the amplifier is favoured by keeping the intermediate frequency low inasmuch as the effect of valve inter-electrode capacity giving rise to coupling between the input and output circuits is thus reduced. Consequently, the amplification which can be employed without running into instability is increased and the shunting effect of small capacities is decreased, so that greater amplification per stage can be obtained. From the operating standpoint, however, the highest possible value of intermediate frequency is favoured. It has been remarked in connection with the reception of any particular wave length that either of two oscillator (local carrier) frequencies may be used to convert the signal carrier to the required intermediate frequency. It follows that for any particular setting of the oscillator there are two incoming frequencies, both of which will be converted to the same intermediate frequency automatically. The difference in signal strengths given by the two carriers will depend on their relative amplitude, and it is evident that if the aerial circuit is tuned to one of the carriers, a signal of the other carrier frequency will result in reduced interference in proportion as its frequency is separated from that of the tuning adjustment in use in the aerial circuit. This type of interference is peculiar to supersonic reception. Since the separation of the carriers which will give rise to this double channel is twice the intermediate frequency, it is obviously desirable that the latter be as high as possible so that the maximum attenuation of the interfering carrier will occur before it reaches the frequency changing detector. A further advantage in using a high intermediate frequency is that valve noise in the amplifier generally is somewhat less than with lower frequencies. The designer, therefore, must compromise between these conflicting requirements and select a valve for the intermediate frequency which will give good stability and high gain in the amplifier, and yet avoid any serious double channel interference.

Supersonic Receiving Sets

Since the supersonic receiving set is of outstanding interest and importance, it seems desirable by way of illustration to consider in some

detail the design of the No. 4002 Set. The circuit schematic is shown in Figure 11 and the set itself, together with its associated equipment, in Figures 12 to 14, inclusive. It is intended for use in conjunction with the No. 4001 Frame

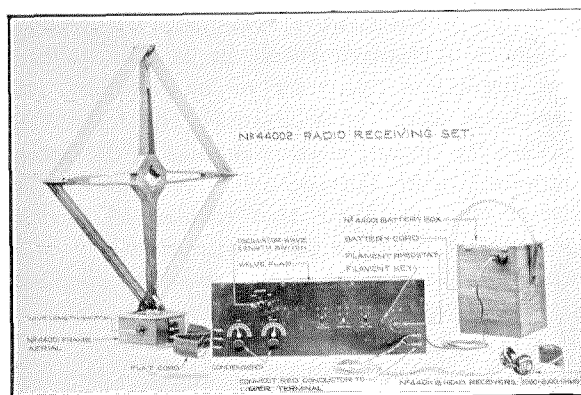

Figure 12—No. 4002 Receiving Equipment Complete with Frame Aerial and Battery Box.

Aerial, and employs seven valves of the peanut type, the filaments of which are connected in series. Three stages of intermediate frequency amplification are provided, one, two, or three stages of amplification being cut in as required by means of vertical type keys. Transformer coupling is used between the stages, the transformers having iron cores of the shell type, mounted in metallic screening cases. Owing to the inherent capacity of the windings, the transformers operate as though partially tuned, and are designed to give maximum amplification at the frequency of approximately 45,000, which has been chosen as the most convenient value for the intermediate frequency, bearing in mind that the set is intended for use on wave lengths up to 3000 metres (frequency 100,000 cycles). Between the intermediate frequency amplifier proper and the last detector, is a filter coupling using an air core transformer tuned by an external condenser. In conjunction with the partial tuning of the interstage coupling transformers, this filter determines the frequency pass band and hence the selectivity of the amplification system, while the tuned frame aerial gives a further degree of selectivity independent of the amplifier. One valve is allotted the special function of generating the local e.m.f. required for the frequency conversion, while another valve

is used as a first detector to give the intermediate frequency wave. It is possible to combine the two functions in one valve, thereby gaining a slight economy, but this arrangement usually makes necessary very careful choice of the valve

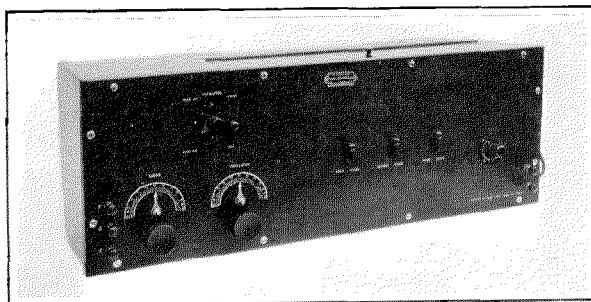

Figure 13—No. 4002 Receiving Set—Front View.

if efficient operation is to be retained, and may result in a loss of selectivity due to the generation of rather strong harmonics in the oscillator.

The local e.m.f. is applied to the first detector of the set by induction into a coil which is in series with the grid of the detector and which does not form part of the frame aerial tuning circuit; in this way the load on the oscillator and hence the magnitude of the local e.m.f. is kept approximately constant independent of variations in the tuning of the frame aerial. At the same time there is little risk of the frame aerial circuit being pulled into step with the local oscillator and acting as a radiation circuit. Both detectors operate on curvature of the anode characteristic with large negative grid bias, so as to reduce the risk of overloading. The appropriate grid bias for any valve is obtained by using the voltage drop across the other filaments. From Figure 14, it will be noted that shielding is extensively employed; the frame aerial tuning circuit, the oscillator circuit, and each stage of intermediate frequency amplification are individually shielded, while the last detector and the stage of L.F. amplification occupy a common shielded compartment. The D.C. feed circuits—filament, grid and plate—are cable formed, while any leads which are at high frequency potential to the battery system are run separately. Since either one, two or three stages of intermediate frequency amplification can be used according to the setting of the keys, a range of

amplification is provided sufficient to enable the set to be used with equal efficiency on either local or distant stations.

It will be seen from the foregoing that the design of a radio receiving set which will meet modern demands as to sensitivity and selectivity and at the same time deliver to the audio reproducing system an input substantially similar to that broadcast by the transmitting station, and also retain ease of control, is by no means easy.

Loud Speaker Operation

The better class of radio receivers generally are used under conditions where loud speaker operation is desired. For this purpose an audio frequency amplifier should be provided which is capable of delivering to the loud speaker an undistorted signal energy of not less than .05 watts and preferably about .25 watts. The power output of the majority of detectors available for ordinary use is considerably below these values, being of the order of .00005 watts when operating just below the overload point. It is, therefore, generally necessary that the detector be followed by one or two stages of audio frequency amplification having a gain of at least 30 TU and that this gain be constant over the frequency range essential for the undistorted reproduction of high quality musical programs. The production of such an amplification system is in itself no mean problem and while, strictly

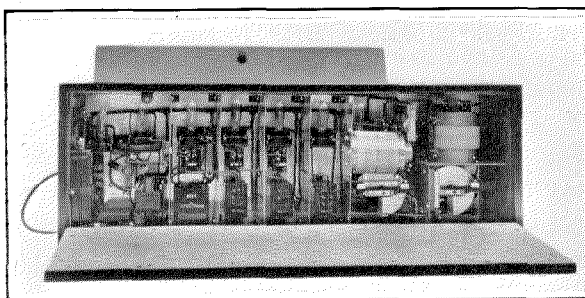

Figure 14—No. 4002 Receiving Set—Rear View.

speaking, not part of the radio design, it must nevertheless be considered in relation thereto. Its study is not, however, within the scope of this paper, except for the determination as above of the required gain and output level.

Electrical Communication and Progress in the Irish Free State

By L. J. KEOGH

Standard Telephones and Cables, Ltd.

Progress in Telephony

WHEN Southern Ireland obtained Dominion status, the new Irish Government realised the need of an efficient up-to-date telephone service. As soon as the necessary funds had been placed at the disposal of the Telephone Administration, engineering and stores headquarters were organised, and a small factory was equipped in Dublin to handle repairs and assembly. The work of making good the plant, both internal and external, which had been destroyed during the troublous times, was in itself a great undertaking; but while this was being effected, future development was well in view, and extensive line work was carried out as indicated on the accompanying map. New districts were opened up, particularly in the North West, and communication by means of radio telephony was established between the more important islands off the west coast and the mainland. People who had been completely isolated were enabled easily to get into touch with their fellow countrymen at any time.

The lines between Dublin and Limerick, Cork, Waterford and many other important centres were in an imperfect condition, but the new Administration reorganised all the existing lines and furnished additional channels wherever it seemed necessary. Underground networks and distributions in city areas also needed overhauling, and extensive alterations were necessary. To effect these changes a substantial contract for twelve months' work was placed with Standard Telephones and Cables, Ltd., London, covering the supplying, laying and jointing required in the city of Dublin itself, and in the metropolitan area, as well as in Limerick and Cork.

For the Dublin area, an automatic programme was chosen, and it was decided to adopt the step-by-step system, such as was being installed by the British Post Office in provincial areas.

As a temporary measure, manual exchanges were installed to relieve the situation in Dublin. The existing main exchanges, Crown Alley, Rathmines, Clontarf—all local battery magneto-

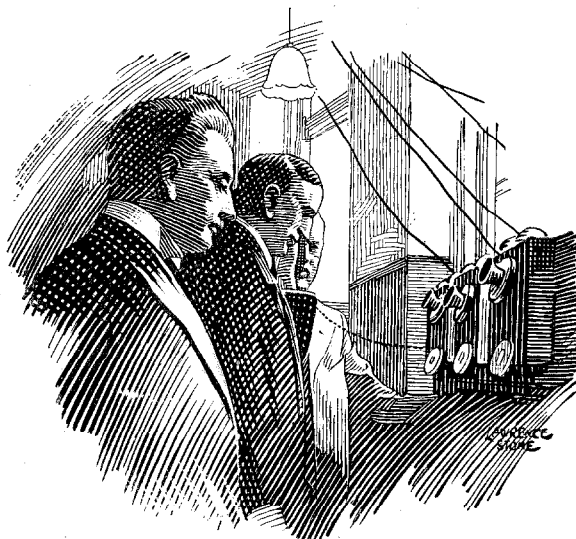

Visit to Ship Street Automatic Exchange of Cabinet Ministers, showing Mr. J. J. Walsh, Minister for Posts and Telegraphs, initiating first call, Mr. Cosgrave, the President, and Mr. P. Mulligan, the Irish Engineer-in-Chief

calling types—were seriously congested. The only comparatively modern exchange was Ballsbridge, which is a central battery type. It is unnecessary to lay stress upon the fact that the first automatic exchanges were far from presenting a straightforward engineering proposition.

A contract was placed with the Standard Company for two new Dublin exchanges—Ship Street (1,600 lines) and Merrion (2,000 lines)—to replace the two temporary manual relief exchanges mentioned above. The Ship Street equipment was the first step-by-step apparatus manufactured at the Hendon works of the Standard Company.

The opening of the Ship Street exchange, the first automatic exchange in the Irish Free State, was an event of special importance, marking a step in the development of automatic telephony

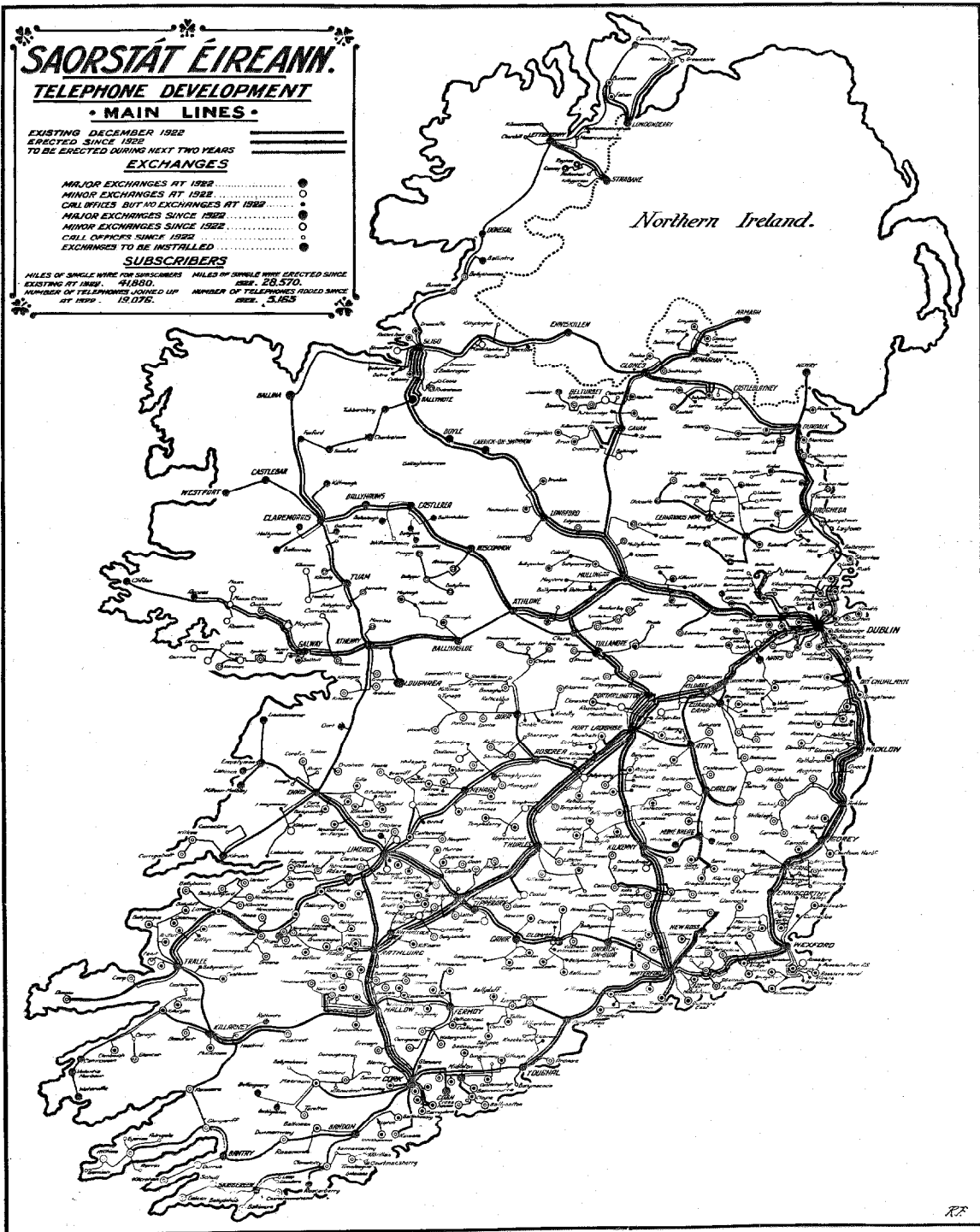

Map of Ireland Showing Telephone Development in the Irish Free State.

in Ireland. The exchange was cut over on July 24, 1927, and in spite of the difficulties involved in arranging junction working with apparatus of the former systems, the cutover was very satisfactory and no appreciable inconvenience or delay to subscribers was involved. The second automatic exchange, Merrion, with a total equipment of 2,000 lines was cut over on December 10, 1927, with equal success.

Such energetic steps generally were taken by the State Engineer and his representatives that most of the arrears have now been wiped off, a highly skilled staff has been trained, and telephonic service throughout the State has been placed on a very sound footing.

Broadcasting

The revenue for the broadcasting service is obtained by the Department of Posts and Telegraphs by the levying of a license of 10/- per set and by a duty of 33.1/3 percent

The two broadcasting stations which have been put into operation by the Free State Government are situated respectively in Dublin and in Cork. The latter is a 1.5 KW (Geneva rating) transmitter, designed and built at the Hendon Works of the Standard Telephones and Cables, Ltd., London. The station is located at Sunday's Well, a suburb of Cork, and is housed in what was the female prison for the district. The station serves Cork, the second city of the State, and also the thickly populated area of County Cork—in all, a population of about 400,000. Special features in the radio transmitter are the use of a very stable master oscillator for generating the carrier frequency, and modulation at low power level followed by amplification of the modulated carrier up to the required aerial power. Push-button starting is provided—the operation of a single press button starting or stopping the whole transmitter.

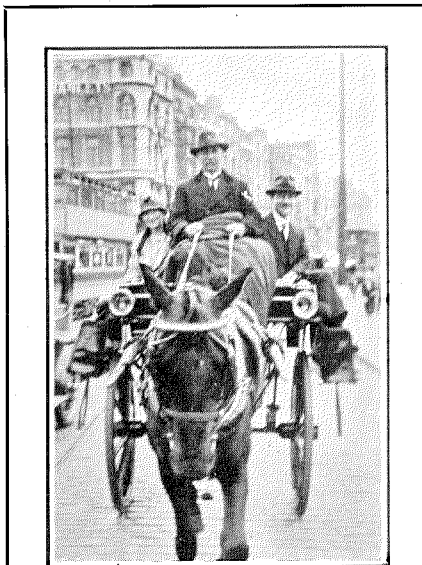

Mr. O'Neil, Staff Engineer in Charge of Automatic Plant, in a Jaunting Car.

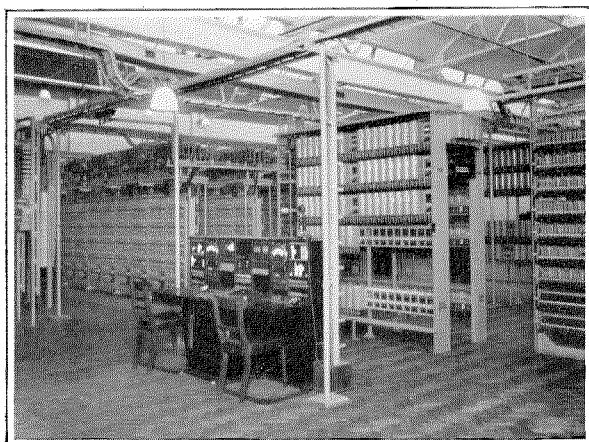

Automatic Equipment and Test Desk* for Merrion Exchange.

on all radio apparatus and components thereof imported, irrespective of country of origin.

* Photograph of equipment as set up at the factory before installation.

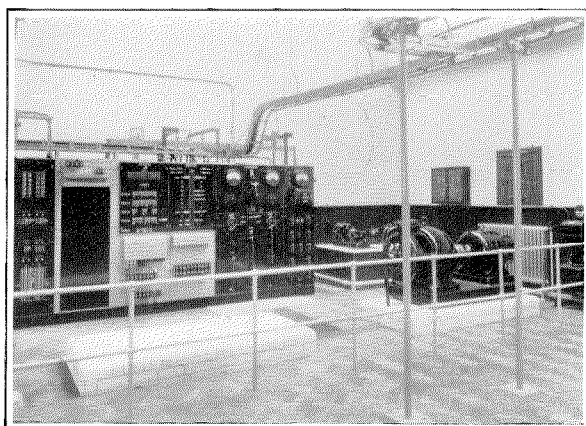

Power Plant * for Merrion Exchange.

The Department of Posts and Telegraphs constructed the aerial and earth system, which was designed by the Standard Company's engineers. An inverted "L" type aerial is

employed, consisting of four spans, each 156 feet in length, the masts being of wood 120 feet in height. The aerial is capacitatively coupled, and facilities are provided for using either a

Exchanges.....	520
Call Offices.....	1,005
Exchange Stations.....	25,370

The annual increase in total stations is 2.1 percent.

General Progress

Since the Free State took control, excellent work has been done generally. Buildings destroyed during the period of trouble have been rapidly rebuilt, and there is now little evidence of those days. Extensive road work has been carried out, so that all trunk and important roads are now in first-class order. An ambitious hydro-electric scheme to provide electricity from the River Shannon, has been initiated and the work is now well in hand. Beet sugar factories have been opened, and considerable work has been successfully undertaken to educate the Irish dairy farmer in the scientific marketing of his main products, butter, eggs, etc.

It is doubtful if the charms of Ireland are

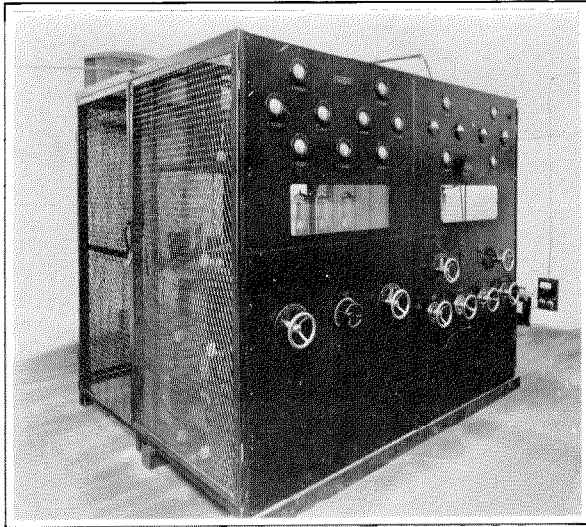

1.5 KW (Geneva Rating) Radio Broadcasting Transmitter at Cork Broadcasting Station.

buried earth system or an insulated counterpoise. The earth system consists of an earth mat composed of 7/22's S. W. G. copper, covering an area of approximately 20,000 square feet.

The Administration is at present considering the installation of a high-power station to afford crystal reception to the people in the Irish Midlands and West of the State.

Communication Projects Completed 1922-1927

During the period 1922-1927, the following work was brought to completion:

New Exchanges Opened	{ Manual.....	297
	{ Automatic.....	2
Miles of Conduit Laid.....		151
Miles of Cable Laid.....		146
Distributing Points Opened.....		1,170
Miles of Open Wire Trunk Line Run.....		3,443
Broadcasting Stations Opened.....		2

The Department of Posts and Telegraphs maintains the electrical control and communication lines of the railways throughout the State.

At present the Department operates:

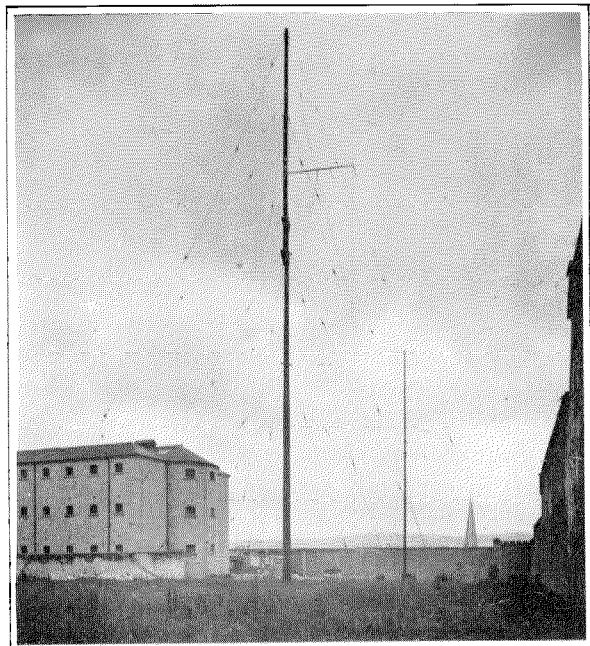

L-type Aerial at Cork Broadcasting Station.

sufficiently known. Quiet and pretty seaside villages are to be found every few miles on every coast. To those who appreciate natural scenery of great beauty and diversity, the whole

of the country with its mountains and lakes must appeal. The sportsman finds in all parts, excellent fishing, shooting and hunting. The resident in, or visitor to, Dublin, within a few minutes of the centre of the city, is excellently provided for at small cost, with golf, tennis, swimming, rowing, yachting or with practically any other form of sport or open air pastime.

The whole country abounds in archaeological remains, and within easy reach of Dublin there are many spots that will afford pleasure to the explorer.

The visitor to Ireland, of course, finds much of historical interest, and in Dublin can visit

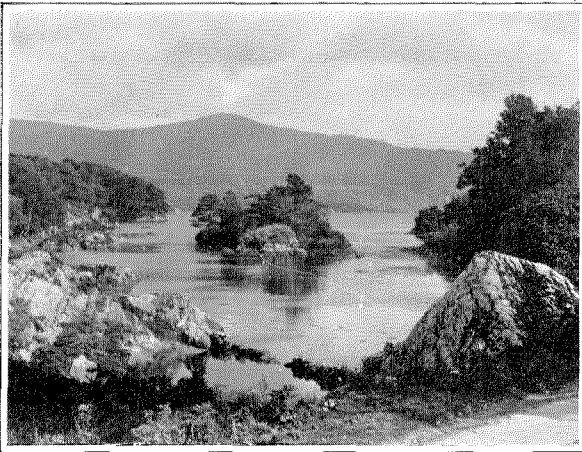

Glengarriff Bay, County Cork.

Trinity College, St. Patrick's Cathedral, Christ Church, the Old Houses of Parliament and many other notable monuments. The famous library of the university contains amongst other treasures, the "Book of Kells," probably the most beautifully illuminated manuscripts of the Gospels in existence, written in half-uncials of the seventh century.

No words on the subject of Ireland would be complete without mention of the Dublin Horse Show. This is the chief annual event organised by that enterprising body, the Royal Dublin Society, and except for the industrial section, it is restricted to horses, including the heavy dray horse as well as valuable thoroughbreds and hunters. Apart from the show itself, this is the main social event of the year; Dublin

and district is "en fete" for the week, buyers of horses and hunting people from almost all parts of the world foregather in Dublin, making the show a spectacle that is unique and one that has to be seen to be appreciated.

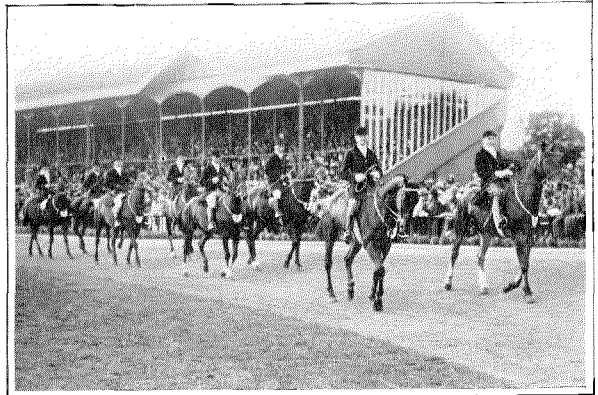

Royal Dublin Horse Show—1927.

In some remote parts of Ireland, there are still people whose only language is Gaelic, and in the rural areas generally the traditional Irish dancing and music prevail. The Irish Govern-



Royal Dublin Horse Show. International jumping competition. A Swiss officer jumping.

ment are now taking energetic steps to encourage and foster the native tongue as well as the national culture in music and literature. The ass and flat cart are still the standard means of

conveyance employed by the peasant for taking the daily yield from his cows to the neighbouring creamery, where it is made into butter and cheese. The cattle and horse fair remains a feature of country life, and the drover in many cases takes his herd of cattle great distances,

often starting the night before the fair in order to arrive in time to dispose of it there.

The Irishman still uses the picturesque side or jaunting car, although within the last two years or so, this characteristic vehicle has been seriously challenged by the taxicab.

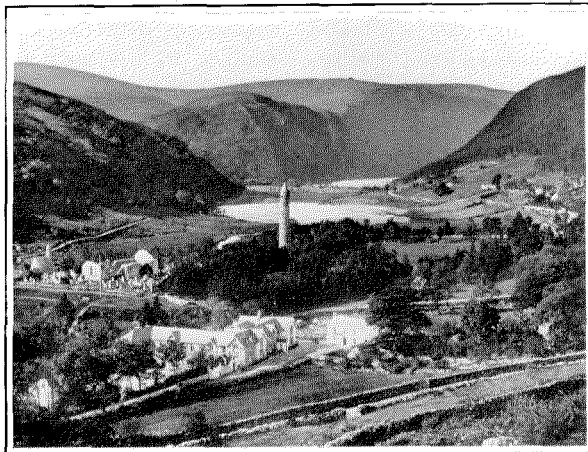

Glendalough, County Wicklow.

Australia First to Use Type C-2-F Carrier System

Long Haul Single Channel Carrier Telephone Systems Connect Melbourne with Important Farming Centres in Victoria and South Australia

By J. S. JAMMER

Carrier Engineer, International Standard Electric Corporation

THE installation of two Type C-2-F Single Channel Carrier Systems has completed another link in Australia's enormous trunk line network. This marks a further step toward the Telephone Administration's goal, which is to provide a highly efficient, nation-wide telephone service. The magnitude of such an undertaking may be more readily appreciated if it is recalled that Australia covers an area twenty-five times as great as that of England, with a

scheme of using long haul single channel carrier circuits as forerunners to multi-channel systems to relieve traffic congestion and to improve transmission on "omnibus" and other circuits.

In providing trunk line facilities in a sparsely populated district the traffic requirements, as a rule, are such as to necessitate the use of omnibus circuits. This must be done in order to provide service to the way stations until such time as the traffic justifies the provision of a traffic

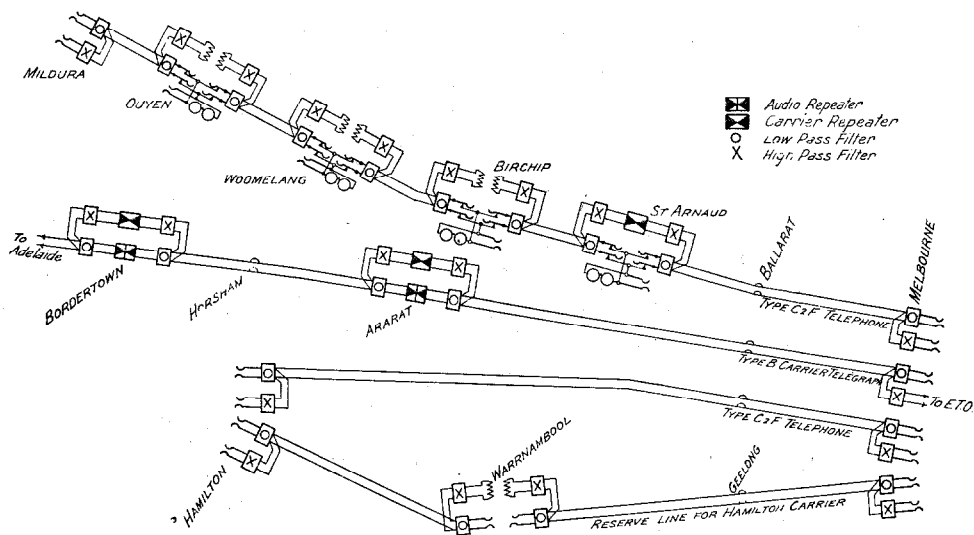

Figure 1—Schematic of Carrier Circuits in Victoria.

total population less than that of the city of London. In line with the progressive policy characteristic of their nation, the Australians were quick to appreciate the advantages of carrier and promptly adopted this method of economically providing high grade communication channels.¹

These two single channel installations are of particular interest because they are the first systems of this type to be installed, and because they are an actual working application of the

¹"Why Australia Adopted the Carrier Current System," J. S. Jammer, *International Telephone Review*, Vol. IV, No. 3, July 1928.

distributing centre. For heavily loaded lines, the omnibus method of operation is not efficient from a traffic standpoint; and as stations are added and the line extended, the transmission to the more remote stations becomes unsatisfactory. Because of the unstable impedance of omnibus circuits, telephone repeaters cannot be used to improve the transmission. Thus, we are forced ultimately to provide high grade channels to a distant traffic distributing centre, and it is in such cases that the Type C-2-F Carrier System proves of considerable advantage.

There exists in the western portion of Victoria, and the southeastern portion of South Australia, a tremendous farming district which has a large community of interest with Melbourne—the important seaport and financial centre of south-

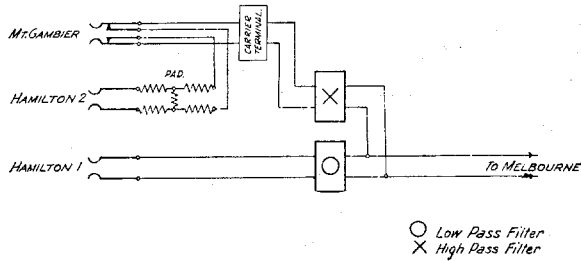

Figure 2—Switching Arrangements at Hamilton.

eastern Australia. This is one of the oldest cultivated districts in Australia, work in the region having begun over one hundred years ago. Hamilton, a prosperous country town with a population of about 5,000, is the logical traffic centre for telephone and telegraph communication from Melbourne to this important farming district.

Before the advent of carrier between Melbourne and Hamilton—a distance of 168 miles—there existed but one 200 pound non-repeated physical circuit, which gave a transmission equivalent of about 12 TU. Feeder lines extend from Hamilton up to a distance of one hundred miles, the longest of these extensions being to an important tourist district known as Mount Gambier, in South Australia. The increasing demand for an improved telephone service in this region caused the Australian Administration to consider seriously the erection of a new physical circuit which would be of such grade as to provide good transmission from Mount Gambier to Melbourne; but, when the full advantages of the Type C-2-F System were realised, this means providing a new circuit was immediately adopted. The carrier system was installed between Melbourne and Hamilton, and normally operates on the Melbourne-Hamilton physical circuit with an alternative route through Geelong and Warrnambool, as indicated in Figure 1. By providing carrier transfer filters at Warrnambool, two separate high frequency circuits are made available; and, as these are not on the same pole route, continuous service to the Hamilton district is ensured.

In order to give an 8 TU equivalent from Mount Gambier to Melbourne, the carrier channel is worked at a 4 TU gain from Melbourne to Hamilton. This with the 12 TU loss which exists in the line between Hamilton and Mount Gambier, gives a net loss of 8 TU from Mount Gambier to Melbourne. The circuit can be extended to Sydney on a Sydney-Melbourne carrier channel working at a 3 TU equivalent, thus giving Mount Gambier an 11 TU circuit to Sydney—a distance of over 1,000 miles.

In order that the carrier system will not be overloaded when the circuit is used for Hamilton business, an 8 TU pad is inserted in the low frequency circuit for Hamilton connections. This pad is automatically cut out when the circuit is switched through to Mount Gambier. A simple diagram of this arrangement is shown in Figure 2.

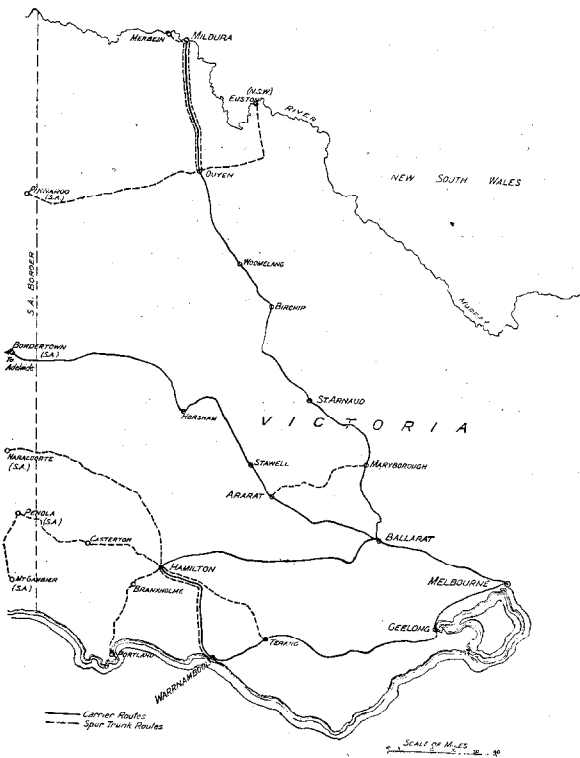

Figure 3—Map of Centres Served by the Type C-2-F Carrier System.

Other important centres which are switched at Hamilton for connection with Melbourne, Sydney and Adelaide, are Braxholme, Portland, Casterton, Penola and Naracoorte. The relative

location of these centres and the two routes from Melbourne to Hamilton are shown on the map, Figure 3.

The northwestern district of Victoria—the Mallee district—is a very fertile region, the principal products being fruit and wheat. This fruit area has given rise to the dried fruits industry, which recently has been stimulated by the Government's assigning tracts of land to returned soldiers. The centre of this rich and fertile district is Mildura, and, here again, we find the clearing house for the commercial activities in the district is the traffic centre for the communication system.

A great deal could be written about the romantic history of Mildura, the centre of a district which, by modern irrigation methods, practically was converted from a desert into a profitable farming district.

Mildura is first noted in history in 1846 when the district was a cattle run, known as Tretman. For a number of years this area was considered to be of so little value that the cattle owners did not bother to register their holdings. In 1886 the Chaffey Brothers, who were engaged in promoting irrigation settlements in California, learned that cheap land, suitable for irrigation, might be had in Australia. They investigated the matter, and, after analysing the soil, appreciated that water was the only thing required to convert this district into flourishing farms and vineyards, whereupon a company was formed which entered into an agreement with the Australian Government to undertake the irrigation.

When the Chaffey Brothers obtained possession of this district they set apart an area, which is now called Mildura, as the centre of the colony. By 1890 the population of Mildura had grown to 2,000, and the thousands of acres had been split into orchards producing grapes, oranges, lemons, peaches and figs.

As the district improved it was appreciated that some transportation facilities would be required and eventually the Government built a railway line from Melbourne; this was opened on 13th November, 1903. Year after year the production increased and in 1911 the population reached 6,000; however, the greatest extension came during the World War when Turkey and Greece, two of the principal dried fruit producing

countries of the world, were forced to cut down their production.

The first soldier settlements in the district were established in 1917, and in 1920 Mildura reached the height of its triumph. The products were bringing tremendously high prices and there was a great deal of trading in land blocks, but in 1923 there was a big slump in the dried fruit market and the district got its most severe set-

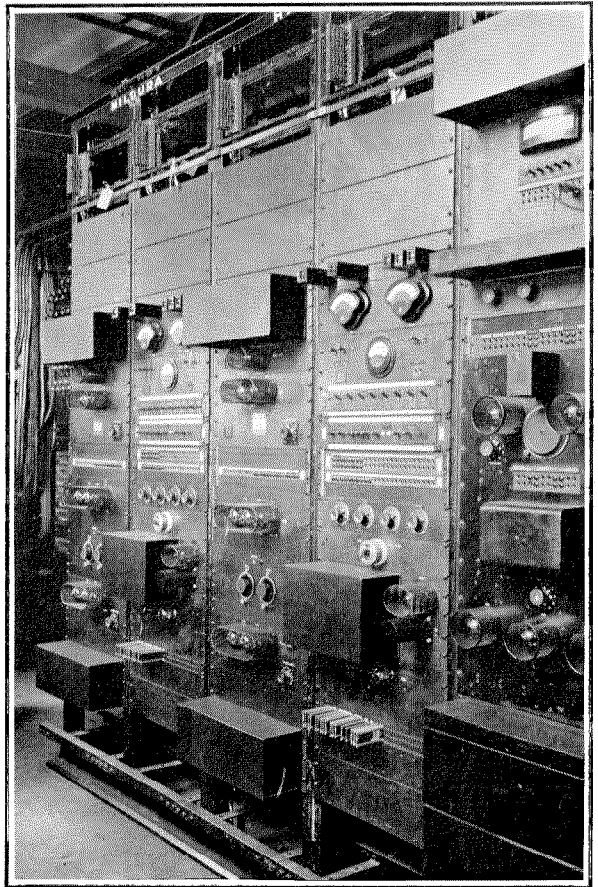

Figure 4—C-2-F Carrier Terminals in the Melbourne Office. The two bays shown at the left are the Mildura system and the next two bays, the Hamilton system. The single bay at the right is one of the bays of the Sydney-Melbourne three channel carrier system.

back. The Australian Government, recognising a crisis in the industry, made an effort to stabilise prices and assisted in the effective distribution of the product. This period of depression has been overcome and the district is again becoming more prosperous; it is expected that the coming year will show a marked advance.

Before the carrier equipment was installed

there existed one physical telephone circuit from Melbourne, through Ballarat, St. Arnaud, to Mildura—a distance of 360 miles. This was an omnibus circuit, with a number of stations

other words, the Melbourne subscriber talks over the carrier all the way to Mildura, and then back over the physical circuit to the intermediate stations as far back as Birchip. The low frequency equivalent by this path to Birchip is 7 TU. As indicated in Figure 3, the important centres of Euston, Merbein, and Pinnaroo, feed into this line.

Figure 4 shows the two terminals in the Melbourne Office, the two bays on the extreme left being the Mildura system and the next two bays, the Hamilton system. The one bay on the extreme right is one of the channels of the Sydney-Melbourne system² which was installed in 1925.

Before the carrier systems were installed high frequency line measurements were made to make sure that the circuits would be suitable for car-

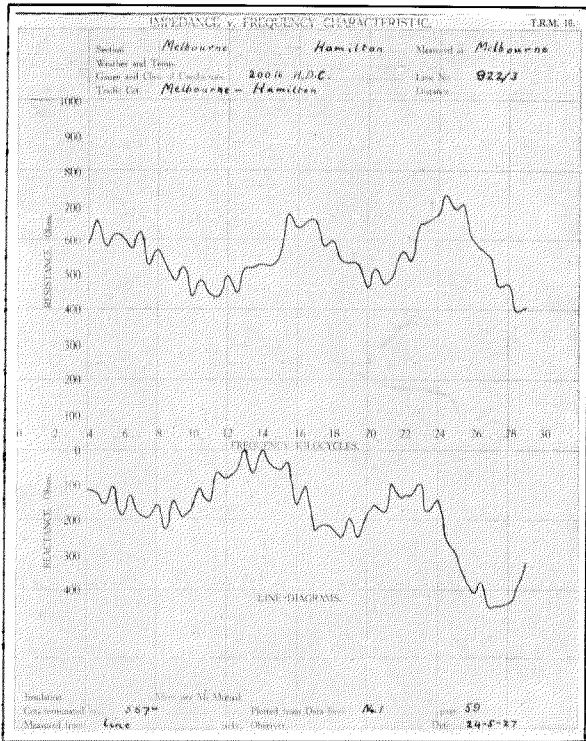

Figure 5—Impedance-Frequency Characteristics of the Melbourne-Hamilton Circuit Measured from the Melbourne Terminal.

bridged across the line at intermediate points. In order to relieve the traffic congestion on the through Mildura business and to provide better transmission to the more remote way-stations, it was decided to install a Type C-2-F System on this route. Figure 1 shows a line diagram with the carrier repeater at St. Arnaud, and carrier transfer filters at Birchip, Woomelang and Ouyen.

The low frequency equivalent of the physical circuit from Melbourne to Mildura was about 16 TU. Now that the carrier is installed, the physical circuit is broken at Birchip, which provides any station on the Melbourne side with an equivalent of not more than 12 TU. The carrier channel itself is set up to operate at a zero equivalent from Melbourne to Mildura, so that subscribers beyond Birchip are actually connected to Melbourne through Mildura. In

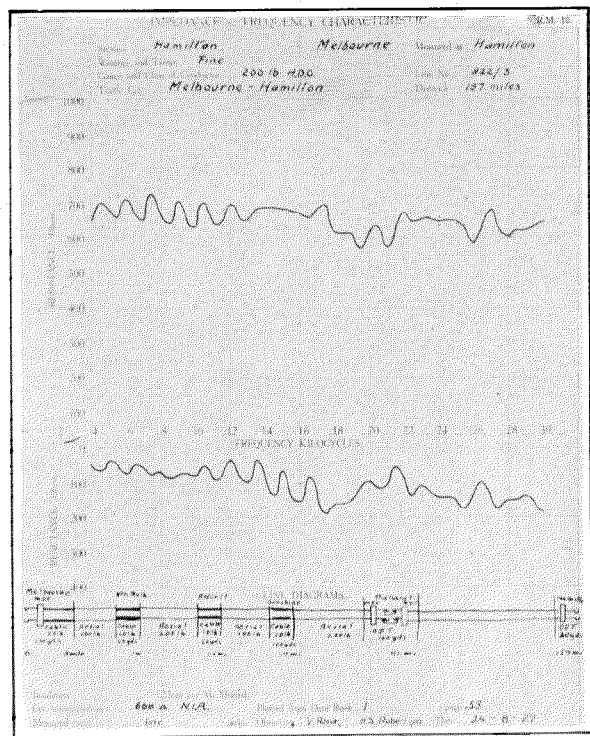

Figure 6—Impedance-Frequency Characteristics of the Melbourne-Hamilton Circuit Measured from the Hamilton Terminal.

rier operation and to locate any line irregularities. Impedance measurements are a fair criterion of

² "Carrier Telephone System Installed Between Sydney and Melbourne," Francis A. Hubbard, ELECTRICAL COMMUNICATION, Vol. IV, No. 3, January 1926.

the line characteristics, and the measurements made on these circuits are shown in Figures 5 to 9.

Figures 5 and 6 show the impedance of the Melbourne-Hamilton circuit, measured first from the Melbourne terminal and then from the Hamilton terminal. The line shows some distortion in the impedance characteristics when looked at from the Melbourne terminal, but over the range of the C-2-F System, that is, up to 10,000 cycles, is good enough for carrier operation. This system, therefore, was put into service without any changes in the line whatever. Similarly, no changes in the Melbourne-St. Arnaud section of the Melbourne-Mildura line were required.

Measurements of the St. Arnaud-Mildura section of the line, however, indicated a serious

measurements made from Mildura are much more satisfactory than those made from St. Arnaud. From the frequency interval between the peaks of the impedance characteristic it was

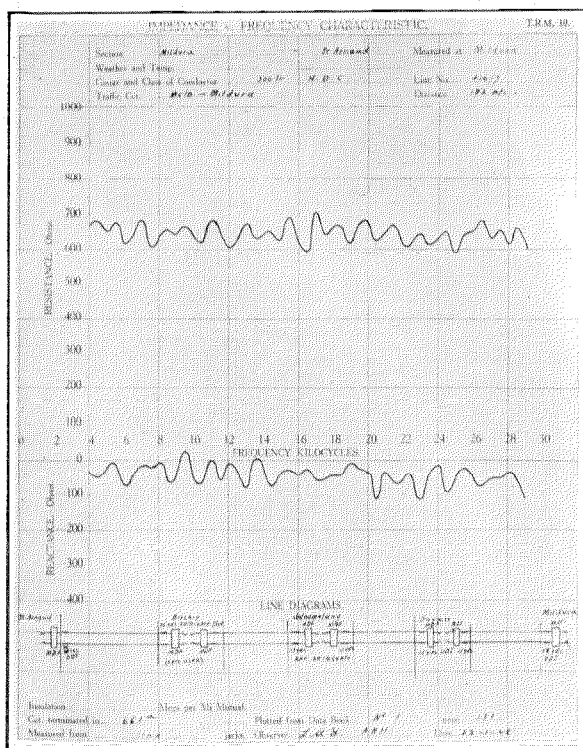

Figure 7—Impedance-Frequency Characteristics of the St. Arnaud-Mildura Section of the Line Measured from Mildura.

distortion in the impedance characteristic, as shown on Figures 7 and 8. The irregularity in the line causing this trouble was near the St. Arnaud Office, and it was for this reason that the

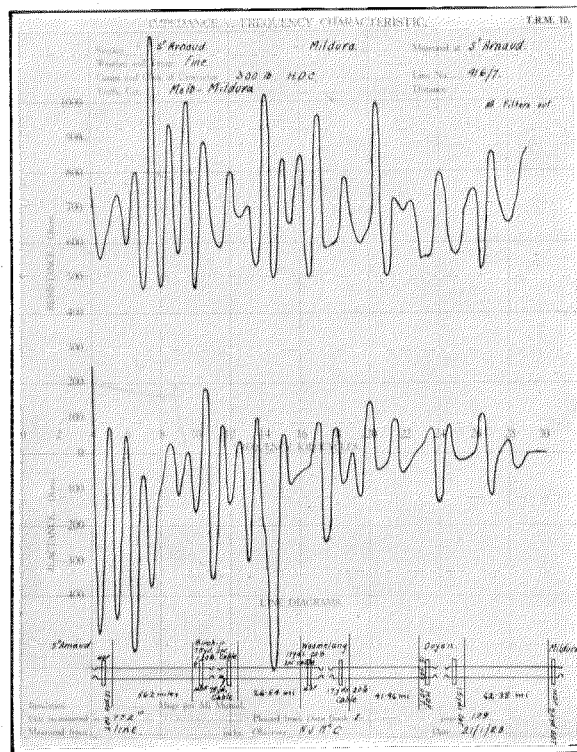

Figure 8—Impedance-Frequency Characteristics of the St. Arnaud-Mildura Section of the Line Measured from St. Arnaud.

possible to compute the distance of the line irregularity from the St. Arnaud Office; this trouble was removed, whereupon the line was satisfactory for carrier operation. The measurements of this section after the line had been cleared up are shown in Figure 9.

There is one more interesting point in connection with these two installations, and that is the demonstration of the high degree of accuracy with which the carrier equipment is being produced.

The Melbourne-Hamilton system, which was the first ordered, was manufactured by the Western Electric Company, Inc., at Hawthorne (U. S. A.), and the Melbourne-Mildura system, the second ordered, was manufactured at the Hendon factory of Standard Telephones and Cables, Ltd., London. The American system

was mounted on 6 foot 11 inch floor supported racks and the English equipment, on 8 foot 6 inch channel iron, ceiling supported racks.

The Australian Administration decided, for the sake of uniformity, to put all the London made equipment in the Melbourne Office, and to place one terminal of the Melbourne-Hamilton system at Hamilton and the other at Mildura.

It was realised that it might be necessary to interchange filters, as the band filters which are used with the C-2-F System are specially selected to work in pairs; however, the filter characteristics were measured, and it was found that all the filters involved were practically identical, so that the American equipment could be used on one end of a system and the London equipment on the other end without any modification whatever. Both these systems are giving perfectly satisfactory results in every respect.

It is indeed gratifying to observe the not unimportant contribution of the telephone towards the development of Australia—a nation which again proves to be a pioneer in the adoption of modern methods, in that it is the first to use the Type C-2-F Carrier System.

Acknowledgment

The writer wishes to acknowledge with thanks the kind assistance of Mr. N. J. McCay, of the Postmaster-General's Department; also of the Markets and Migration Commission of the Commonwealth of Australia, for the use of photographs.

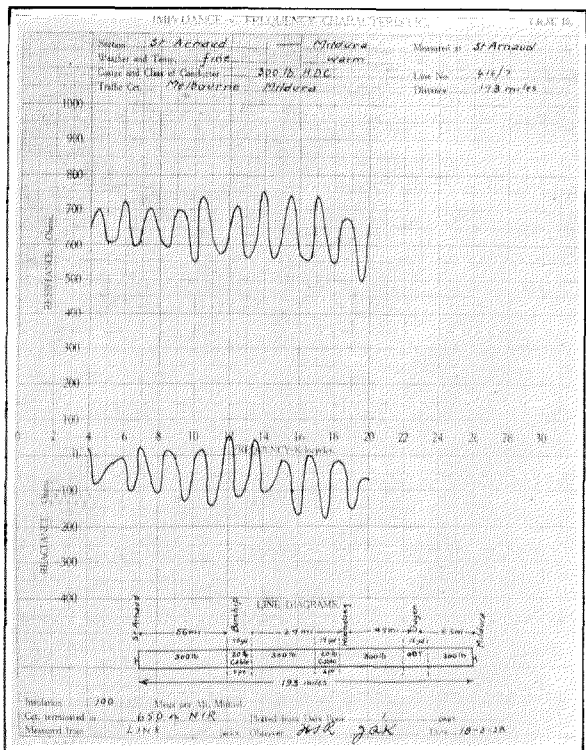
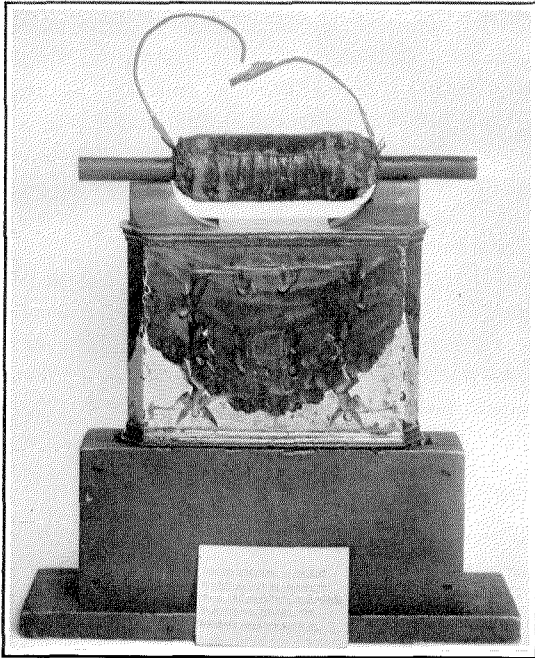

Figure 9—Impedance-Frequency Characteristics of the St. Arnaud-Mildura Section Measured from St. Arnaud after the Irregularity in the Line Was Removed.

A Famous Lodestone

The descriptive card reads: Russian Lodestone in Ancient Mounting Used by Faraday to Show the Induction of Currents by a Natural Magnet, and Faraday's Coil Used with It.

THE King George III Collection of apparatus at King's College, London, contains among other treasures the lodestone used by Faraday in his experiments on induced currents. This Collection consists pri-



marily of the apparatus presented to King's College in 1841 by Queen Victoria. It was originally brought together by George III at the Royal Observatory, Kew. By the courtesy of the authorities at King's College the lodestone is illustrated in the accompanying figures.

It is elaborately mounted, and of fine workmanship. On one side of the mounting is written in Russian the word, "Siberia," and on the other, the date, 1777. At the front is a coloured representation of two angels with trumpets, presiding over eight hard-working miners. At the back of the magnet is represented the same angels guarding only seven miners. The fate of the missing miner is not recorded.

Below the pictures is written in Russian, partly obliterated, a statement of the weight of the lodestone and the weight it is capable of sustaining. There is also a signature, W. W. Petroff 1803. An old notebook at King's College records the weight and the pull of the

stone, but unfortunately the entries are based upon untrustworthy conversions. Today the weight of the lodestone with its mounting, but without the supports or the armature, is about 12 kilogrammes, and the pull is about 16 kilogrammes.

In Faraday's experiment the method of operation was to set the spark-gap of the coil to the required small length, and then to detach one end of the bar suddenly from its pole by a blow from the hand.

A detail of importance is to be observed at the spark-gap. The two bent conductors leading to the gap are of stout copper wire. One of these is filed to a blunt point. The other terminates in a copper disc upon the face of which is a removable zinc plate, fastened by a single screw. It is to be inferred that Faraday experimented upon sparks between various metals. The coil is protected by a leather covering that cannot be removed without injury to the relic; consequently the windings cannot

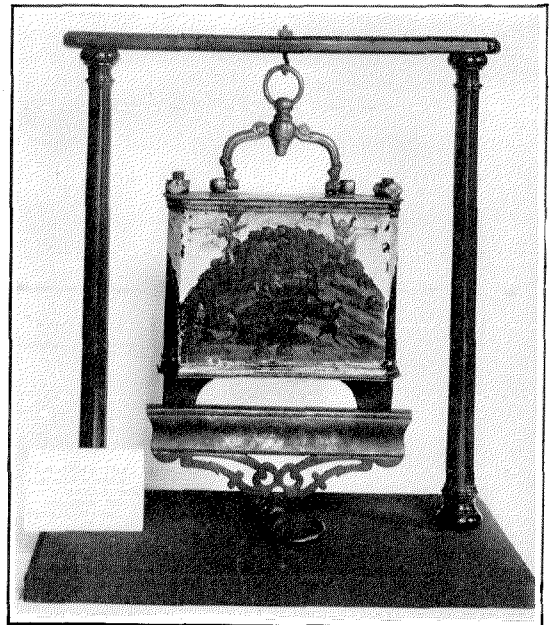

be examined. Judging from the ends, where they are brought out, there appear to be several windings, possibly eight, in parallel. The principles of design of coils had not in those days been ascertained.

International Standard Electric Corporation

Head Offices
NEW YORK, U. S. A.

European General Offices
LONDON, ENGLAND
PARIS, FRANCE

Associated and Allied Companies

Standard Telephones and Cables, Limited.....*Aldwych, London, England*
Branches: Birmingham, Glasgow, Leeds, Manchester, Dublin,
Cairo, Johannesburg, Calcutta, Singapore.

Standard Telephones and Cables (Australasia), Ltd.....*Sydney, Australia*
Branches: Melbourne, Wellington.

Bell Telephone Manufacturing Company.....*Antwerp, Belgium*
Branches: Berne, The Hague, Brussels.

Standard Electric Doms a Spolecnost.....*Prague, Czecho-Slovakia*

Standard Electrica, S. A.....*Madrid, Spain*
Branch: Barcelona.

Standard Elettrica Italiana.....*Milan, Italy*
Branch: Rome.

Standard Electric Aktieselskap.....*Oslo, Norway*

Le Materiel Telephonique.....*Paris, France*

United Telephone and Telegraph Works, Ltd.....*Vienna, Austria*
Branch: Tallinn (Reval).

Standard Electric Company W. Polsee.....*Warsaw, Poland*

Standard Electric R/T.....*Budapest (Ujpest), Hungary*

Compania Standard Electric Argentina.....*Buenos Aires, Argentina*

International Standard Electric Corporation, Branch Office.
Rio de Janeiro, Brazil

Nippon Electric Company, Limited.....*Tokyo, Japan*
Branches: Osaka, Dalny, Seoul, Taihoku.

Sumitomo Electric Wire & Cable Works, Limited.....*Osaka, Japan*

China Electric Company, Limited.....*Peking, China*
Branches: Shanghai, Tientsin.

Sales Offices and Agencies Throughout the World

To those interested in better communication the International Standard Electric Corporation and its Associated and Allied Companies offer the facilities of their consulting engineering departments to aid in the solution of problems in Telephony, Telegraphy and Radio.