

ELECTRICAL COMMUNICATION

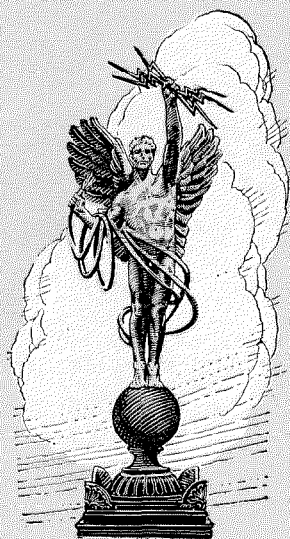

JANUARY
1928

No. 3
VOL. 6

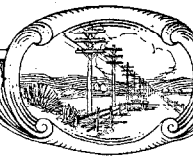

ELECTRICAL COMMUNICATION

A Journal of Progress in the
Telephone, Telegraph and Radio Art

EDITORIAL BOARD

J. L. McQuarrie	F. Gill	G. Deakin	P. E. Erikson	G. H. Nash
G. E. Pingree	P. K. Condict	E. A. Brofos	E. C. Richardson	F. A. Hubbard

H. T. Kohlhaas, Editor

Published Quarterly by the

International Standard Electric Corporation

Head Offices

41 BROAD STREET, NEW YORK, N. Y., U. S. A.

European General Offices

CONNAUGHT HOUSE, ALDWYCH, LONDON, W. C. 2, ENGLAND

75, AVENUE DES CHAMPS-ELYSEES, PARIS (8e), FRANCE

G. E. Pingree, President

L. N. Rock, Secretary

H. B. Orde, Treasurer

Subscription \$1.50 per year; single copies 50 cents

Volume VI

JANUARY, 1928

Number 3

CONTENTS

THE VOLTA CENTENARY EXHIBITION AT COMO.....	115
MEETING OF TELEPHONE AND TELEGRAPH ENGINEERS AT COMO	121
PROVIDING MADRID WITH AUTOMATIC TELEPHONE SERVICE. 127 <i>By Kenneth McKim</i>	
LA TRANSFORMATION DU RÉSEAU TÉLÉPHONIQUE DE PARIS EN AUTOMATIQUE.....	141
<i>Par G. Pocholle</i>	
IN MEMORIAM: ERNEST PENNY.....	153
THE INTERNATIONAL CONFERENCE ON HIGH TENSION SYS- TEMS	154
<i>By G. H. Nash</i>	
THE CALCULAGRAPH.....	158
<i>By H. C. Dilsizian</i>	
LOADING COIL CORES AND THEIR MAGNETIC STABILITY....	161
<i>By Fumio Shida</i>	
SIMULTANEOUS BROADCASTING IN CZECHO-SLOVAKIA.....	171
<i>By E. K. Sandeman</i>	





New Building of the Cuban Telephone Company, Havana. It is the highest building in Cuba, consisting of ten stories and a three-story tower. The illustration shows the results of the recent installation of floodlighting equipment.

The Volta Centenary Exhibition at Como

MAY TO OCTOBER, 1927

THE object of this exhibition cannot be better stated than in the words of the invitation of the Executive Official Committee:

Alessandro Volta, by his marvelous invention of the voltaic cell rendered possible telephony and telegraphy. These are foremost amongst the applications of electricity to the practical problems of civilisation. To recall his achievements, it was thought appropriate to regard telegraphy and telephony as a symbol, and to promote at Como an International Exhibition and an International Technical and Scientific Congress relating to them and to radio. We therefore invite all public and private telephone administrations, all manufacturers of apparatus and telegraph and telephone material, and all persons interested in the problems of telegraphy, telephony, and radio to participate in the Exhibition and at the Congresses.

The historic Villa del'Olmo (Figure 1), that recently became the property of the Como Council, was utilised for the Exhibition. It is situated about a mile from Como, at the edge of the lake. With its large park and spacious pavilions it admirably served its purpose.

The Exhibition was formally opened on May 28, 1927, by H. M. the King of Italy. The operating administrations or companies, giving telegraph and telephone service in different countries, exhibited representative items in the Villa del'Olmo itself. Manufacturers' exhibits were located in the new pavilions on the left of the Villa. Professor di Pirro, Director General of the Istituto Sperimentale of the Italian Post, Telegraphs and Telephones, was responsible for the organisation of the first group. Mr. Comboni, Secretary of the Italian Electro-technical Association, organised the second group. There was also an exhibit to convey an idea of the development of hydro-electricity in Italy and another of silk material and silk-weaving machinery.

The exhibits (Figure 2) of the International

Standard Electric Corporation and the Standard Elettrica Italiana, its Italian Associated Company, located in the largest pavilion, were intended to show the various aspects of electrical communication. The outside plant exhibit included underground and open-wire lines installed in the park. The underground exhibit demonstrated the method of laying a cable into a trench from a cable reel trailer, and the arrangements for jointing, pressure testing, mechanical protection and bonding.

A loading coil manhole, of countersunk type, had a base of concrete, supporting two concrete cylinders containing the bodies of the loading pots. The sides and ends were of concrete and the top was made of removable slabs of reinforced concrete, so that the cable joint was easily accessible. One of the loading pots was jointed to the main cable. The second pot was in position, ready to be jointed.

Another method of protecting the joints, especially for non-armoured cables laid in ducts, was illustrated, in which two cable joints were protected by means of a collapsible concrete box. The base and the ends of the box were in one piece. The sides and the lid could be removed to give enough space when working on the joint.

Toll and exchange cables, including an armoured cable and a leading-in cable from an aerial route, entered a manhole from different sides and through a glazed earthenware duct, thus indicating the manner in which it could be led into the basement of an exchange.

The aerial exhibit showed how a underground cable may be extended from a terminal pole of an aerial route. An insulating joint separated the underground and aerial sheaths to prevent stray currents from passing to or from the underground system. The steel strand was of suitable strength for the suspension of the heaviest type of telephone cable manufactured. The loading of an aerial cable was illustrated by an H-pole structure, carrying two loading pots supported by brackets and girders. Provision was made also for the two additional pots to be placed subsequently. On the next pole, the toll cable was terminated through fuses and lightning

arresters contained in a No. 18 type cable terminal, and from this point the toll circuits were continued by ten pairs of open-wire toll-lines, suitably transposed. In the same span, a subscriber's aerial cable was erected. Half of

place of the switchboard type used heretofore. This testboard is used in repeater and terminal stations for making maintenance measurements on the lines and apparatus, and for making temporary connections between the lines and



Figure 1—The Villa del'Olmo.

this was terminated on the next pole through carbon arresters and a "B" type cable terminal. Some of the remaining circuits were taken underground; the others were carried over the last span in a small aerial cable and ended in a C-type terminal.

The repeater exhibit, Figure 3, displayed specimens of the various types of bays placed in one row. From left to right they were: the No. 5 Toll Testboard, the repeating coils and networks, the 20-cycle ringers, the voice frequency ringers, the 4-wire terminating sets, the 2-wire and 4-wire repeaters, and the testing and supply apparatus.

The No. 5 Toll Testboard employs the ordinary iron racks used for repeater mounting, in

apparatus to meet emergencies. A voltmeter position and a Wheatstone Bridge position were exhibited and part of the jack field was wired to the apparatus on the other racks. The next three bays contained the repeating coils used to obtain the proper impedance ratio between the line circuits and the repeater or office equipment, also the balancing networks for 2-wire repeaters and the low frequency correctors for 4-wire repeaters. The first bay on the left was for the 2-wire circuits, while the two bays on the right were for the 4-wire circuits.

The repeater rack itself consisted of five bays. The first from the left included the 20 to 20 ~ through ringer panels, the second the voice-frequency ringer panels, and their test panel,

while at the bottom were the terminating sets for the 4-wire circuits. The third and fourth bay included respectively the 2-wire and 4-wire repeaters, the latter being used for long circuits. The last bay on the right carried echo suppressors and their test panel. The echo suppressor is designed to eliminate the echo currents coming back on a long 4-wire circuit.

The exhibit of automatic switching machines consisted of various types of automatic private branch exchanges. The telephone service in the whole exhibition was given by a No. 7000 P.B.X., with its associated attendant's board to establish and record the toll calls.

The second part of the automatic exhibit was a demonstration of the Rotary System for large



Figure 2—Exhibit of the International Standard Electric Corporation and Its Associated Company, Standard Elettrica Italiana.

The last rack consisted of four bays of testing and control apparatus. On the left was a transmission measuring set, capable of measuring transmission line levels and losses, repeater gains or apparatus losses. The second bay included a variable frequency oscillator, having a range of 35 to 50,000 cycles per second and its special amplifier, for the supply of amplified testing frequencies.

The third bay carried the meter panels for measuring currents in the filament and plate circuits, a filament control panel for making valve rejection tests, and a key panel. The last bay on the right contained the fuse panels and the plate (circuit and 20 ~ ringing supply) protection lamps. A small rack, erected behind the main exhibit held a generator giving the voice frequency ringing current, at 500 cycles magnetically interrupted at 20 cycles.

city areas, showing the way in which a call is established through the interconnected offices. Though there were only five lines completely equipped, every particular case, such as "busy line" and "non-completed call," could be shown and demonstrated.

The third part consisted of a certain number of small automatic P.B.X.'s of the step-by-step type. On each side of the No. 7000 automatic switchboard was a No. 7001 P.B.X., the capacity of which was 35 lines.

In order that the visitors might get an idea of the different kinds of manual switchboards used in urban and toll telephony, some typical specimens were exhibited. The first on the right consisted of two positions of a No. 1 Toll Board, and an associated cord circuit repeater. Every line which can be used with this repeater has a balancing network and the operator has a de-

vice to put them in circuit and to control the gain.

One of the principal exhibits was the broadcasting station, complete with its studio, control, and machine rooms. The radio transmitter was

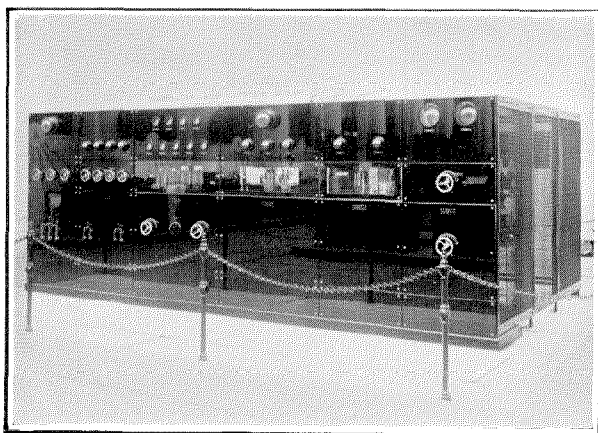

Figure 3—Repeater Exhibit of the International Standard Electric Corporation.

capable of delivering 5 KW. to the antenna system, and it operated on a wave-length of 500 metres. It is similar to that of Prague, except that the speech input equipment and oscillator modulator unit have been modified.¹

Two forms of microphone were used; i.e., the condenser type and the double-button carbon instrument. Adjacent to the studio was the control room, which contained the speech input equipment and a power switchboard at the back.

The radio transmitter itself (Figure 4) was of recent type, in which the carrier current is generated at very low power level. Modulation also is performed at low level, subsequent multi-stage high frequency amplification giving the power required for feeding the antenna. This arrangement results in high quality modulation and it has other important advantages.

A No. 1 Public Address System was used for distributing speeches and music. The connections were such that, if desired, the System could be operated from the microphone and the speech input equipment used in broadcasting.

The loud speakers were arranged in four groups, giving different kinds of service. Some of the projectors were set in a direction to send

¹"The Prague Radio Broadcasting Station," E. M. Deloraine, *ELECTRICAL COMMUNICATION*, Vol. 5, No. 3, January 1927.

speech and music over the lake and to the other bank, east of Como. The broadcasting station and Public Address System were used regularly and they relayed daily the orchestra of the Villa d'Este; another orchestra also played nearly every day in the studio.

The Public Address System was used during the Italian and International Regattas, on the Lake of Como. A small radio transmitter was installed in a motor-boat, while the receiving set in the studio transmitted directly the results, through the Public Address System, to the thousands of people crowded over the Exhibition ground.

In September, when numerous congresses were held in Como, the broadcasting station and the Public Address System were used to relay the principal speeches delivered in the Villa del'Olmo, the Social Theatre or the Carducci Institute of Como.

Apart from the testing apparatus shown in the repeater exhibit, specimens of portable sets were exhibited; i.e., a transmission measuring set, a crosstalk measuring set, a capacity unbalance set and several artificial lines. The oscillators used to provide the testing current for these sets included small vibrators as well as vacuum tube oscillators of large frequency range. There was also a test set, giving the complex wave used for crosstalk measurements. These oscillators were located near a cathode ray

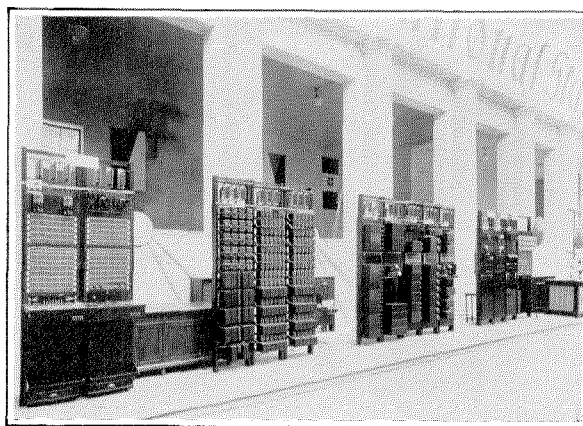

Figure 4—5 KW. Radio Transmitter—Front View.

oscillograph on which their wave-forms could be examined by the visitors. A microphone was used also to show the wave forms of the vowels of speech. In all these tests the time

base was obtained with low frequency oscillating current controlled by a neon lamp.

There could be seen also different types of subscribers' sets, either for local battery or for central battery plants, and for automatic lines. Among them were different models of the French Administration 1924 type, manufactured by Le Matériel Téléphonique, and chosen by the Administration as the standard set.

Next were a few examples of radio apparatus, including a two-tube receiving set, made in Antwerp, an amplifier and the associated Kone Loudspeaker. The exhibit included also a field strength measuring set, developed in London, used for the determination of antenna efficiency. The field to be measured could be adjusted to a value as low as one microvolt/metre. At the back of the broadcasting station, was a 50 watt point-to-point transmitter, of the type used in whalers.¹

A collection of vacuum tubes showed the types employed in repeater equipment and those for radio telephony. Among them was the 10 KW. water-cooled tube with pyrex glass envelope used for large broadcasting stations, such as the Rugby station on the transatlantic radio-telephone circuit.²

The chief items of importance among the telegraph exhibits were two No. 14 Morkrum Teletype Printers,³ operating upon an artificial line, and a Keyboard Perforator⁴ and a Tape Transmitter for the Baudot Multiplex System.

The train or tram dispatching installation consisted of a dispatcher station and three way-stations.

Exhibits of the Telephone and Telegraph Administrations

Instructive features were to be observed in the Exhibition of the Telephone and Telegraph Administrations, located in the Villa del'Olmo itself.

¹"Radio Telephony Applied to Antarctic Whale Hunting," E. A. Rattue, *ELECTRICAL COMMUNICATION*, Vol. 5, No. 4, April 1927.

²"Transatlantic Radio Telephony—Radio Station of the British Post Office at Rugby," E. M. Deloraine, *ELECTRICAL COMMUNICATION*, Vol. V, No. 1, July 1926.

³"Morkrum—Kleinschmidt Printing Telegraph Systems," H. P. Clausen, *ELECTRICAL COMMUNICATION*, Vol. 5, No. 3, January 1927.

⁴"A New Keyboard Perforator for the Baudot Printing Telegraph System," A. E. Thompson, *ELECTRICAL COMMUNICATION*, Vol. 3, No. 4, April 1925.

The Austrian Administration exhibited among other items the Hauck type battery made in 1866 at Vienna, a diagram of the first duplex telegraph experiments carried out at the Vienna Imperial Academy of Science in 1853, a complete collection of parts of telephone and telegraph installations, and a map of the Austrian cables.

The French Exhibit comprised some historical apparatus, including Bourseul's receiver and Branly's coherer. There were also parts of a small broadcasting station and of a short wave station and a model of the buildings and antenna of the Bordeaux-Lafayette wireless station. It was completed by some examples of aerial lines, switchboards and subscribers' sets, among which the type 1924 handset made by Le Matériel Téléphonique, and chosen by the Administration as a standard set, could be seen.

The German Administration had gathered a number of early models of telegraph sets, among which those of Steinheil, Gauss and Werner were especially to be noticed. It also had a collection illustrating the history of the electric cell, from a Volta's "pila" to the modern telephone cells.

The General Post Office of Great Britain showed a model of one of the Rugby masts for the transatlantic radio-telephone station and for their long-wave radio-telegraph stations. In front of the mast were a number of early models of vacuum tubes. The historical part contained a d'Arsonval microphone and receivers of the Bell and Reiss type. The modern apparatus included some measuring sets, particularly for checking microphone efficiency.

The Dutch exhibit included photographs, drawings, and parts of equipment, illustrating the short-wave links between Holland and Java.

The Hungarian Administration exhibited two models of the wireless station at Csepel and Szekesfehervar and a great deal of apparatus manufactured by leading Hungarian firms.

The exhibition of the Italian State was very important, as a great number of government departments had taken part in its preparation. A special commission had been appointed by the King of Italy for the publication of a national edition of Volta's works; the volumes ready at the time of the Exhibition were exhibited as well as photographs of Volta's most interesting manuscripts and apparatus (Figure 5).

A collection of Marconi's first radio telegraph transmitters and receivers and early radio-telephone transmitters was shown; and among other historical apparatus, the Istituto Superiore Postale Telegrafico Italiano sent the transmitter used in the radio-telephony experiments¹ between Rome and Tripoli in 1908.

showing the rapid development of the telephone plant, particularly in the northern part of that country.

The Swiss Administration exhibited some of their earliest switchboards. A map illustrated the efforts made to provide adequate national and international service.



Figure 5—Italian State Exhibit, Including Volta Relics.

The Italian Services exhibited telephone and radio-telephone sets specially made for specific purposes. The Italian Navy had erected, near the side of the lake, a short-wave wireless telegraph station, using a simple self-oscillating water-cooled tube of the 10-KW. type.

The Japanese Administration sent photographs showing automatic exchanges in course of installation in Tokio and the development of radio, in which the International Standard Electric Corporation and its Associated Company, the Nippon Electric Company, Ltd., are playing a very large part.

A representative collection of apparatus used in Sweden was completed by a luminous map

¹See Jour. Inst. E. E., Vol. 64, November 1926, page 1113.

A few models of telephone poles and a number of photographs illustrated the work of the Czecho-Slovakian Administration and particularly the beginning of their cable network.

In addition, the American Telephone and Telegraph Company's exhibit presented a general survey of the activities of the Bell System, together with the important steps in the history of telephony in the United States. A replica of Dr. Bell's Exhibit at the Centennial Exposition at Philadelphia in 1876 could be seen. There were three models of the first commercial telephones employed in the United States, and also a working model of the first commercial switchboard. It had eight lines and was installed in 1878 to connect fifty subscribers at New Haven, Connecticut.

Meeting of Telephone and Telegraph Engineers at Como

SEPTEMBER, 1927

I. Fourth Reunion of the Comité Consultatif International

II. International Congress of Telephony and Telegraphy

I. Fourth Reunion of the Comité Consultatif International des Communications Téléphoniques à Grande Distance

THE regular meetings of the C.C.I. ordinarily take place at their headquarters in Paris. This year, on a special invitation from the Italian Telegraph Administration, the fourth reunion of the C.C.I. was held at Como from September 5th to 11th, concurrent with the commemoration of the centenary of Alessandro Volta.

The series of meetings, comprising morning and afternoon sessions, were held at the Villa Margherita, a beautiful villa on the shore of Lake Como, which together with its extensive grounds has been purchased by the town of Como for the use of the general public.

The questions under discussion following previous practice were divided into a series of five groups, as follows:

- 1st Group General Organisation
- 2d Group Protection, Corrosion, etc.
- 3d Group Transmission
- 4th Group Standard Reference System
- 5th Group Traffic and Exploitation.

The outstanding decisions taken in the discussion are briefly described below under the headings of their respective groups.

FIRST GROUP—GENERAL ORGANISATION

A new arrangement was made regarding the election of the President. In future there will be no permanent president, but at the commencement of each reunion a president will be elected who will hold office during the period of that reunion. Under these rules Professor di Pirro was elected President for the Como sessions.

In view of the possibility of the extension of circuits to Constantinople and Asia Minor, it was decided to invite the Telephone Administrations of Albania, Bulgaria, Greece and Turkey to join the C.C.I.

It was further decided that the next meeting

should be held in Paris next year during the last week in May and the first week in June.

SECOND GROUP—PROTECTION, CORROSION, ETC.

On the questions of protection, corrosion, chemical action and associated problems, the C.C.I. already has the co-operation of the following bodies:

- International Union of Railways
- International High Power Conference
- International Union of Producers and Distributors of Electricity

It was decided to write to the International Union of Tramways with a view to obtaining their co-operation also.

The discussions were largely centred around questions of corrosion and chemical action, and the sub-commissions report which had been drawn up at The Hague last July was adopted with some modifications.

THIRD GROUP—TRANSMISSION

The question of admissible losses on long distance circuits were discussed and the limits already laid down were more definitely stated, particularly in view of their application to switched circuits.

The requirements which international open wire lines should fulfill was discussed. Advice already given was amplified to include some additional electrical requirements and also some mechanical requirements.

Some advice was formulated regarding the use of intermediate cables in open wire lines, particularly where repeater operation was involved, and some practical details of methods were contributed in the form of memoranda by the International Standard Electric Corporation and Messrs. Siemens and Halske.

The above questions were covered in a report drawn up by a sub-commission appointed at the last reunion. The report was adopted with some minor modifications.

The transmission unit was again discussed,

it having been decided at the previous reunion that both the unit on the common logarithm basis and the unit on the naperian logarithm basis should continue to be used concurrently. The former, which had been referred to variously as the natural unit, $\beta 1$ unit, etc., is to be known as the nepér with symbol "n," whilst the latter, which has been known as the TU, is to be called the decibel with symbol "N." For the purposes of C.C.I. transactions the full names of nepér and decibel will be used.

Two sub-commissions of special interest were nominated: one, under the direction of Great Britain, to investigate the question of the co-ordination of wireless and land telephony with special reference to the possibility of extending the transatlantic service to Europe generally; the other, under the direction of Switzerland, to deal with international symbols and to obtain the co-operation of the International Electro-technical Commission.

It was decided that the vocabulary, a draft of which had already been issued, should be revised and all terms rigorously excluded which do not purely apply to telephony and telegraphy.

FOURTH GROUP—THE STANDARD REFERENCE SYSTEM

The installation of the Standard Reference System is expected to be completed early in 1928, when a representative of the American Telephone and Telegraph Company is expected to arrive in Paris.

A Permanent Commission, under the direction of Captain Cohen of the British Post Office, has been set up to deal with all questions relating to the practical use of the Standard Reference System. This Commission will make all necessary arrangements regarding the installation and maintenance of the Reference System.

At the general plenary assembly the C.C.I. expressed its very cordial thanks and appreciation both to the American Telephone and Telegraph Company for its generosity in providing the Standard Reference System, together with the advice and service of its engineers, and to the French Administration for having arranged an ideal location free of cost to the C.C.I. A vote of thanks was also accorded to Captain Cohen for the work he has done on this important subject.

FIFTH GROUP—TRAFFIC AND EXPLOITATION

The simplification of international accounts was discussed and it was decided to try an experimental method over a period of three months. A number of operating detail questions were discussed and arranged. Some discussion was devoted to the multiplying factor to be used in estimating the tariffs over circuits which included submarine cable.

The possibility of leasing international private wires was discussed and a principle was agreed to for international land lines where spares were available.

A traveling commission was appointed to study the question of handling the traffic between the various Bourses throughout Europe. In some cases this traffic amounts to as much as 90 percent of the international traffic.

II. *International Congress of Telephony and Telegraphy*

A feature of the celebrations inaugurated in Italy this year by the Italian Government to do honour to the memory of Alessandro Volta, the pioneer physicist, who died in Como one hundred years ago, was an International Scientific and Technical Congress dealing with telephony and telegraphy. This congress, to which invitations were issued to leading scientists and electrical engineers throughout the world by a special Volta Centenary Committee, appointed by the Italian Government, was held at Lake Como from the 10th to the 15th of September, 1927. It followed a line similar to that of the congress held in Budapest in September, 1908, which was convened as the result of suggestions made by the Hungarian and French delegates to the International Telegraph Congress held in London in 1904. A second congress of the same kind was held in September, 1910, in Paris, and a third was to have taken place in Berne in September, 1914, but was cancelled on account of the war.

Over one hundred scientists and technicians from all parts of Europe and from the United States of America were present at the Como Congress. Of this number thirty-five came prepared to deliver technical and scientific papers on subjects, bearing on the art of communication by wire and wireless.

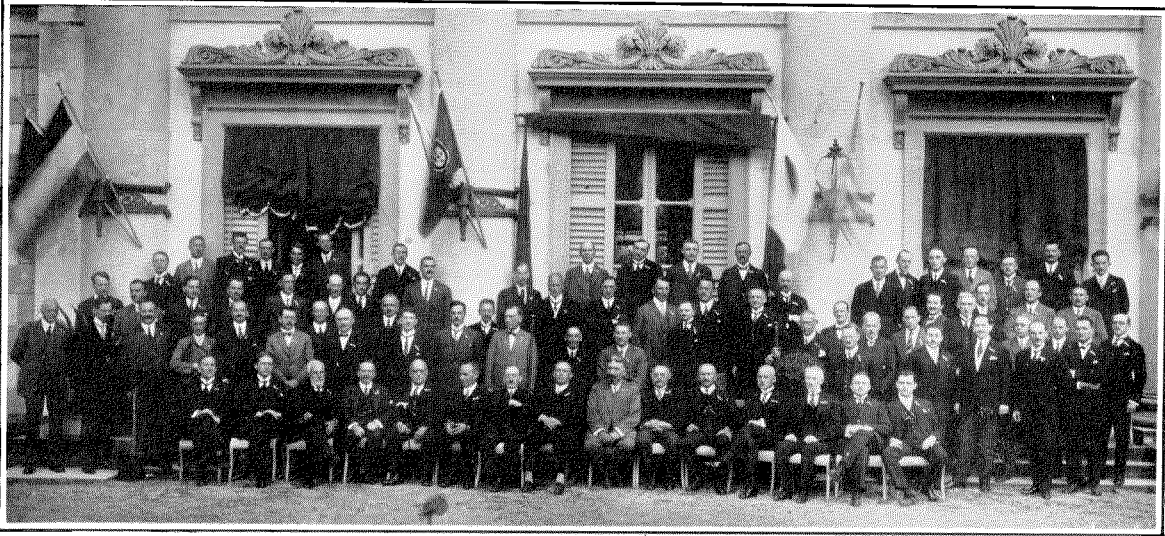

Delegates Attending the Fourth Reunion of the Comité Consultatif International at Como, September 5 to 12, 1927. Front Row (seated left to right) are some of the Chiefs of the Administration delegations: M. Muri (Switzerland), M. Hallgren (Sweden), M. Kol (Hungary), M. Heider (Austria), M. Abild (Norway), Dr. Breisig (Germany), Professor di Pirro (Italy)—President of the C.C.I., M. van Embden (Holland), M. Barrillau (France), M. Dethioux (Belgium), M. Chocholin (Czecho-Slovakia), M. Modenov (U.R.S.S.), M. Campé (U.R.S.S.), M. Zuchmantowicz (Poland), M. Constantinesco (Roumania).

The inaugural ceremony was held on the morning of September 10th in the Great Hall of Villa del'Olmo, the main building of the Volta Centenary Exhibition. His Excellency, the Hon. F. Pennavaria, Under Secretary of State for Posts and Telegraphs, presided and delivered an address of welcome to the delegates. He was followed by several speakers, including the Hon. C. Baragiola, Lord Mayor of Como, Professor Vallauri, President of the Italian Electrotechnical Association, Dr. Alberto Pirelli, President of the International Chamber of Commerce and Dr. G. di Pirro, Director of the Istituto Sperimentale in the Italian State Telegraph Department.

After according to the Members of the Conference a welcome from the Italian industries, Doctor Alberto Pirelli, in his capacity as President of the International Chamber of Commerce, directed attention to the great importance to Members of that Congress—which represented world-wide interests in matters relating to production and exchange—of questions concerning international telephone communications.

He said he had pleasure in seeing present, at the Congress, Members of the International Chamber of Commerce who had participated in the work of dealing with telephone problems. He recalled that at the Conference of the

International Chamber of Commerce held in Brussels in 1925, as well as at the recent Conference at Stockholm, the development and improvement of international telephone communication—of such great moment to the commercial world—attracted exceptional attention. He mentioned that, in addition, the Stockholm Conference had established a Permanent Commission for studying such questions, and that they had passed a resolution to ensure constantly increasing collaboration with the International Consulting Committee. He concluded with the assurance that scientific and technical men would find in business men assembled at the International Chamber of Commerce all the moral support they might desire to have for the practical realisation of their projects.

At 2:00 o'clock in the afternoon the delegates to the Congress made a pilgrimage to Camnago, where a memorial wreath was placed on the tomb of Volta, and where delegates were presented to Viscountess Volta, a direct lineal descendant of the great scientist.

At 4:30 P.M. was held in Villa Margherita the first technical session, which was begun with the election of presiding Officers. Professor di Pirro was unanimously chosen President of the

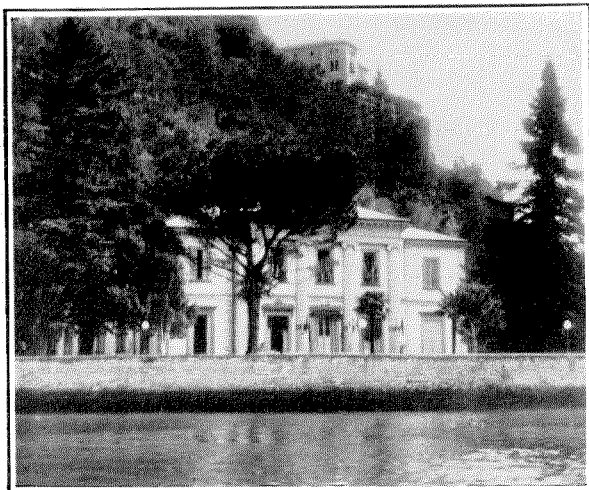

Villa Margherita, where the meetings of the C.C.I. and the International Telephone and Telegraph Congress were held.

Congress; Dr. F. Breisig of the German Reichspost, Dr. G. A. Campbell of the American Telephone and Telegraph Company, Captain B. S. Cohen of the British Post Office and Monsieur H. Milon, Chief Engineer of the French Telegraph Administration, were unanimously elected Vice Presidents.

It was decided that, owing to the large number of papers to be presented (of which a full list is given below) and the shortage of time at the disposal of the Congress, it would only be practicable for those who had contributed memoirs to read brief explanatory summaries and to illustrate them, if possible, by means of lantern slides; and that the language to be used preferably should be French as it was understood best by the majority of the delegates. The first of the abbreviated memoirs was then read.

The following day, being Sunday, no technical sessions were held. A commemoration meeting was held, in the auditorium of the Teatro Sociale, at which delegates of the International Congress of Physicists (which, under the presidency of Sir Ernest Rutherford, also held a series of meetings at the Istituto Carducci in Como) as well as members of the International Electro-technical Commission, convened at Bellagio, were present. The Lord Mayor of Como, as President of the Volta Centenary Committee, welcomed the delegates on behalf of the city of Como. After brief addresses by Professors

Majorana, Vallauri and di Pirro, Senator Antonio Garbasso delivered the memorial oration on the life work of Volta. Homage to the great Italian genius was also paid by scientists from other countries, notably by Dr. A. E. Kennelly of Harvard University, Professor Paul Janet, dean of l'Ecole Supérieure d'Électricité, Paris, Dr. Max von Laue of Berlin University and Sir Ernest Rutherford, President of the Royal Society of Great Britain, who dealt particularly with Volta's association with the work of the Royal Society.

The inaugural speeches in the Great Hall at Villa del'Olmo, as well as those delivered at the memorial service in the Teatro Sociale, were broadcast from the 5 KW. broadcasting station, installed by the International Standard Electric Corporation at the Volta Centenary Exhibition.

The delegates attending the meeting and accompanying ladies, numbering in all over seven hundred, were entertained at luncheon in Hotel Plinius by the city of Como.

During the first four days of the following week (Sept. 12-15) the technical sessions were resumed with morning and afternoon meetings, during which the various lecturers gave résumés of their papers, the majority of which were illustrated by lantern slides. As will be seen from the appended list, the topics covered a wide range of subjects connected with telephony and telegraphy, including transmission by radio and television. Many of the papers aroused animated discussions, signifying the interest aroused by the subjects presented. It is under-

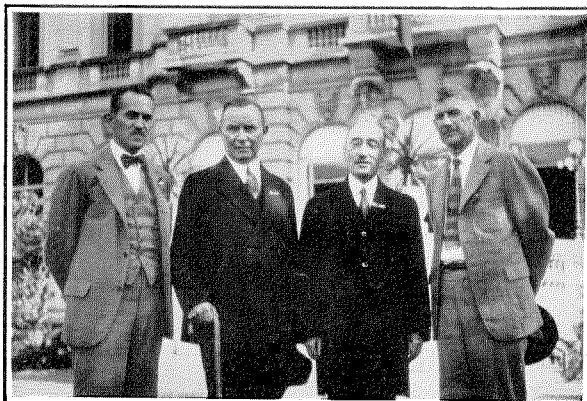

Four Leading Mathematicians at the International Congress of Telephony and Telegraphy at Como, September 10 to 15, 1927. (Left to Right): Dr. Carson (U. S. A.); Dr. Breisig (Germany); Dr. di Pirro (Italy); Dr. Campbell (U. S. A.).

stood that in due course the papers and discussions will be published, giving a full record of the proceedings.

On the lighter side of the Congress the Italian hosts provided an excellent programme of entertainments for their guests. This included excursions on the beautiful Lake of Como, a performance of Puccini's posthumous opera "Turandot" at the Teatro Sociale, visits to the Centenary Exhibition, where during the first evening of the Congress an official dinner was tendered to the delegates and ladies accompanying them. The Congress closed with a dinner at Hotel Plinius, the President of the Congress, Dr. di Pirro occupying the chair. The Italian State Railways granted reduced fare tickets to the delegates for travel all over Italy, the tickets being valid for one month after the closing of the Congress.

At the conclusion of the proceedings a restricted number of invitations were issued by the Volta Committee to members of the Congress to visit Rome and participate in the final celebrations to be held there in honour of Volta. These celebrations included, on the 19th, a reception in the Capitol, under ideal weather conditions.

Senator Marconi delivered an eloquent address on the pioneer work in physics of his great countryman, Volta. This was attended by the members of the Electrotechnical Commission and of the Congress of Physicists, as well as by the delegates from the Telephone and Telegraph Conference.

On the following day, after laying a wreath on the tomb of the "Unknown Soldier," the delegates visited the Forum, the Colosseum and the Palatine, being conducted by guides speaking different languages, who had an expert knowledge of Roman history and archeology. A luncheon was given at the Palace of the Caesars and in the afternoon, after a short visit to the outskirts of the city, including a drive along the Appian Way, the delegates were received personally by Signor Mussolini at the Villa Torlonia, where tea was served in the beautiful gardens, to the accompaniment of an excellent programme of music. The delegates were honoured also by an invitation to be presented to His Holiness the Pope on the 21st of September.

It is difficult to estimate the exact value of a Congress of this kind. The contributions made on recent technical and scientific progress in telephony and telegraphy will constitute an important source of information to those interested in the subjects dealt with. Of no less importance, however, are the closer friendships, which are formed between communication engineers from all the countries represented, friendships which are based on a better understanding of the other man's problems and an appreciation of the work which is being carried on in the various countries to further scientific and practical progress in telephony and telegraphy.

PAPERS PRESENTED AT THE INTERNATIONAL
TELEPHONE AND TELEGRAPH CONGRESS AT
COMO—SEPTEMBER 10-15, 1927

- BREISIG, Prof. Dr. F. (Berlin)—Logarithmic measures of ratios between quantities of like nature and their place in the absolute system of measurements
- BUBENIK, Prof. Dr. Ing. (Brno)—The influence of high tension lines upon telephone lines
- BUCKLEY, Dr. O. E. (Bell Telephone Laboratories, New York)—High-speed Ocean Cable Telegraphy
- CAMPBELL, Dr. G. A. (American Telephone and Telegraph Co., New York)—The practical application of the Fourier integral
- CARSON, Dr. J. R. (American Telephone and Telegraph Co., New York)—The present status of wire transmission theory and some of its outstanding problems
- COHEN, B. S. (London)—Apparatus standards of telephonic transmission and the technique of testing microphones and receivers
- COLLET, Ing. L. J. (Paris)—Notes on the general theory of bi-polar and quadri-polar systems
- DI PIRRO, Prof. Dr. G.—On certain types of electric circuits with constants varying from point to point
- ERIKSON, P. E. (International Standard Electric Corporation, London)—The present state of long-distance cable telephony in Europe
- GIEBE, Prof. Dr. E. (Berlin)—Piezo-electric crystals as frequency standards
- GIORGI, Prof. Ing. G. (Rome)—Wave filters and infinite lines, subjected to variable currents of an arbitrary form

- HANSFORD, Dr. R. V. (London)—A modern long-wave, high-power radio telephone and telegraph station, using thermionic valves
- HARTLEY, R. V. L. (Bell Telephone Laboratories, New York)—Frequency relations in electrical communication
- HIRSCH, Ing. R. (Telefunken, Berlin)—Progress in the technique of long-wave high-power stations using high-frequency alternators
- HOEPFNER, Ministerial Councillor (Berlin)—The technical exploitation of long cables
- KENNELLY, Prof. Dr. A. E. (Harvard University, U. S. A.)—The application of hyperbolic functions in the recent progress of submarine telegraphy
- KORN, Prof. A. (Charlottenburg, Berlin)—Photo-telegraphy and the problem of television
- KÜPFMÜLLER (Berlin)—On certain relations between the frequency characteristics and the transient phenomena in linear systems
- LEITHAUSER, Prof. Dr. (Berlin)—A new method for the exact measurement of wave lengths from distant transmitting stations
- LE CORBELLER, Ing. Ph. (Paris)—The Loudspeaker
- LO SUDRO, Prof. Dr. A. (Rome)—The saturation current of thermionic valves
- MAJORANA, Prof. Dr. Ing. Q. (Bologna)—A new system of telegraphy by visible light and by ultra-violet rays
- MEISSNER, Dr. Ing. (Berlin)—On radiation in space with horizontal polarization
- PAGES, Ing. A. (Paris)—Multiplex telegraphy at audible frequencies
- PLEIJEL, Prof. Dr. H. (Stockholm)—On the theory of homogeneous parallel lines
- POHLMANN, B. (Berlin)—On loaded submarine cables
- POLLACZEK, Dr. (Berlin)—The influence of the earth on the electromagnetic field of waves transmitted along aerial lines and on the mutual induction between parallel lines
- PUPIN, Prof. Dr. M. I. (Columbia University, U. S. A.)—A new type of artificial line for duplex working of submarine cables
- ROBINSON, C. (London)—The submarine link in international telephony
- RUKOP, Prof. Dr. H. (Berlin)—On the progress made in short-wave radio telegraphy
- SALINGER, Dr. H. (Berlin)—On the conditions governing the speed of telegraph transmission
- SCHROETER, Dr. Phil. F. (Berlin)—Recent progress in tele-photography with the Telefunken-Karolus-Siemens system
- TURPAIN, Prof. Dr. A. (University of Poitiers)—The use of very short waves in radio telephony, employing conductors
- VALLAURI, Prof. Ing. G. C. (Turin)—Absolute measurement of radio-telegraphic frequencies, produced by piezo-oscillators
- WAGNER, Prof. Dr. W. (Berlin)—Electric wave filters
-

Providing Madrid with Automatic Telephone Service

By KENNETH McKIM

Information Department, International Telephone and Telegraph Corporation

ON December 29, 1926, the Spanish capitol joined the large and constantly growing group of cities that enjoy automatic telephone service, for on that day a multiple office machine switching system serving the entire city was cut over simultaneously. The importance of this event to the people of Madrid was recognised by His Majesty King Alfonso XIII, who presided at the inaugural formalities, and who set in motion the shafting of the No. 7-A Rotary Standard Electric switching equipment.

It was the culmination of an intensified effort to provide for a city of approximately a million inhabitants, an entirely new telephone plant in sixteen months, a task that involved not only the substitution of automatic for manual service, but also the erection of buildings, the planning of a distributing system that would serve as the foundation for all future plant expansion, and the construction of an underground cable network, amidst the difficulties characteristic of Old World cities.

Enough time has now passed since the event to give assurance to the statement that the Rotary equipment is affording the utmost satisfaction both to the Compañía Telefónica Nacional de España and to the public, and that the people of Madrid have found that automatic telephony far exceeds their greatest expectations. The contentment is so general and has become so widely known that eighteen other Spanish cities in which the company is preparing to inaugurate Rotary automatic service within the next two years are exhibiting keen anxiety for this reform.

Owing to the condition of the old manual plant, parts of which had been in service twenty-five years, it was found impracticable to consider the conversion of the exchanges to automatic separately. It was decided, therefore, to install a complete new and independent local plant to be put into service at one time. Although this procedure was difficult, and contrary to general practice in the conversion of local service from manual to automatic in large cities, inspection

of the old manual plant of Madrid showed the necessity for this procedure.

The overhead outside distributing plant consisted of wires that stretched over the house tops from wooden structures that stood like violin bridges on the cornices and ridge poles of buildings. From tall steel towers at street corners and in the plazas, cables hung in long festoons or were "draped" between the house top structures. The circumstance that the towers were necessarily higher than the houses, added neither to the esthetic appearance of the city nor to the facility for maintenance.

When the Compañía Telefónica Nacional de España acquired the various state and private telephone plants of Spain in 1924, with a concession to develop and operate an efficient nation-wide system, Madrid had a toll office and three manual exchanges, the latter named Mayor, Jordan and Salamanca, with capacities, respectively, of 5,600, 3,480 and 3,600 lines. Of these, Mayor (Figure 1) situated on the historic Puerta del Sol, served the central portion of the city, and was correspondingly congested. The switchboard was of a lamp signal local battery multiple type, and was installed in 1910.

The Jordan and Salamanca common battery exchanges were opened in residential sections of the city in 1916 and 1917, respectively. To tide over the emergency until the new automatic plant could be made ready, the company in January, 1926, opened the Hortaleza exchange in the business part of the town. This exchange was equipped with a modern common battery multiple switchboard, type No. 2001-D, with sixteen trunk and subscriber positions, and equipped for 1,200 lines. It was put into service to provide some relief to the overloaded Mayor switchboard.

Here also was installed an 18-position No. 2001 toll switchboard, to which ten more positions were added in December, 1926, and a No. 4 toll testboard. The long distance exchange took the place of the antiquated boards which had handled the city's toll business

previously and which were located in a building situated at the entrance to the Puerta del Sol.

As subscribers formerly had been permitted to buy their own telephones, there were in service in Madrid instruments of various ages and makes, especially of the magneto types connected with the Mayor exchange (see Figures 2, 3 and 4). Many were far more attractive to

three exchanges for the initial installation, two of 5,000 lines each, and one of 7,000. Floor capacity for expansion to meet the full requirements of their respective areas was provided in the first two cases. Property was acquired adjoining the Salamanca manual exchange, and a permanent building was erected there with room for 20,000 lines of switching equipment-



Figure 1—Overhead Wires and Cables Entering the Mayor Manual Exchange, Madrid, through a Tower on the Roof. The housetop construction, typical of the old outside distributing plant, may be seen on the horizon.

the eye than helpful to the ear. Private branch exchanges, also the property of subscribers, were similarly diverse. In planning new inside and outside plant to take the place of this curious assemblage, careful and thorough study of the requirements of the city was a preliminary necessity. This was started immediately after the concession was granted, and was based on the estimated telephone developments for the next twenty years. On August 27, 1925, after consideration of all factors concerned, it was decided to adopt No. 7-A Rotary automatic equipment¹ and work was started at once on

¹"No. 7-A Machine Switching System," G. Deakin, *ELECTRICAL COMMUNICATION*, Vol. 3, No. 3, January 1925.

On February 6, 1926, this building was ready. This permitted the installation of the first 5,000 line unit to commence. The Jordan manual exchange building was remodeled, and on January 16, 1926, a crew began the installation of the first 5,000 lines. This exchange also has an ultimate capacity of 20,000 lines.

In the case of the exchange to supplant the Mayor and Hortaleza manual exchanges a special problem was presented. The Company had bought a large and magnificently situated vacant plot on Gran Via, at the centre of the city, with the intention of erecting a fourteen-story headquarters building which at the time would accommodate an automatic exchange with

an ultimate capacity of 40,000 lines. But to wait for the completion of such a structure would have greatly retarded the reformation of

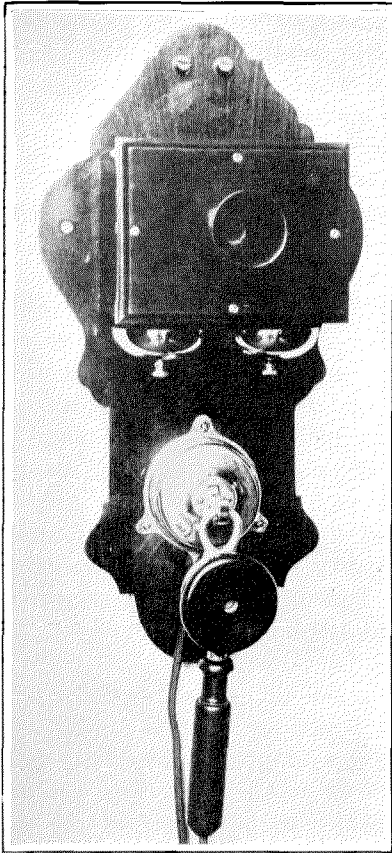

Figure 2—Old Telephone, Peninsular B.C. Type A, One of Those Used in Spain before the Compañía Telefónica Nacional de España Began to Operate the Spanish Telephone System.

the local telephone service, with which the public was justifiably dissatisfied.

In the interests of the subscribers, therefore, it was decided to put up at the rear of the plot a provisional building large enough to house 10,000 lines. This building could be abandoned when the permanent headquarters building was finished and it could be equipped with an automatic installation to be cut over without prejudice to public needs. The construction of this emergency building was started on November 13, 1925, and on March 8, 1926, the installation of 7,000 lines of Rotary equipment was begun.

In 1925, the engineers planned the underground cable plant that should supersede the

overhead system already described, and that should be ready for service at least by the time the automatic exchanges could be cut over. The first section of trench was opened in October, 1925, in order to take advantage of certain street repairs, although little was actually done toward the construction of the underground system until December 17th of that year. The last trench was closed on May 28, 1926. During that brief time, 280,000 metres of duct were laid under the streets of Madrid. As there was a complete lack of plans of existing underground construction in Madrid, the workmen frequently were running into buried pipes, sewers, electric power cables, etc., at various levels, so that it was necessary in many instances to dig to an extraordinary depth in order to lay the conduit



Figure 3—One Instance of the Telephonic Variety Employed in Spain by the Companies Preceding the Compañía Telefónica Nacional de España.

free of interference with these other various underground systems. The narrowness and crookedness of many of the streets in old Madrid added fresh difficulties (Figures 5 and 6).

The outside distributing plant was developed with 600 and 1,200 pair cables. Owing to the density of the population, 85.5 per cent of the cables employed were of the 0.51 millimetre conductor class.

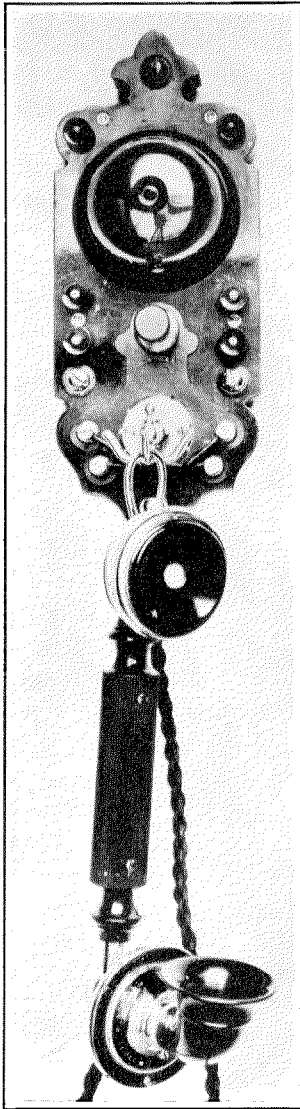

Figure 4—Type in Use in Madrid, among Other Models, before the Advent of the Automatic.

As cable splicing was virtually an unknown art in Spain, and as the Company had adopted a policy not only of using national products so far as possible, but also of employing Spanish personnel, one of the first steps in the development of an underground cable system was the creation of the necessary cable splicers. One

school was established in Madrid and another in Barcelona. That the instruction was thorough and the students apt is demonstrated by the fact that the one hundred and twenty cable splicers who were employed in construction of the Madrid outside plant were all Spanish mechanics who had passed through the Company's school, where they had learned the trade from first rudiments.

Owing to the congested and tortuous character of the older parts of Madrid, and to the great number of houses either without basements or common patios, it was found necessary in those sections to install the fachada (or wall) type of distributing cables. To be less visible, these were placed under cornices or balconies wherever possible, and every practicable precaution was taken not to mar the architectural lines or esthetic effect of the fronts of the buildings. To make such installations, an intensive campaign had to be conducted to obtain permits from property owners, but generally when the proposal had been explained to them, a cooperative attitude was met with from the landlords.

In some of the newer outlying areas, the standard American type of aerial cable construction was adopted. A contract was entered into with the municipality to allow the underground cables to be placed in the water-pipe subway, known as the Canal of Isabel II, in portions of the city where that subway passes under the streets. This reduced materially the amount of trenching and served to relieve the public of the annoyance of having some of the principal thoroughfares, such as the new Gran Via and the traffic congested Alcala Street, opened up by construction gangs.

In preparing Madrid for the cut-over to automatic, the Company in a period of about eight months pulled 111,780 metres of cables through the ducts of the underground construction, placed 165,720 metres of the wall type, and erected 91,200 metres of aerial type cables. In the trenching and placing of the ducts, approximately 800 men were employed, and in the construction of the cable plant, 1,255 men.

Figures 7 to 11, inclusive, show views of the Madrid automatic plant. A distinctive feature is that all line finders, sequence switches and

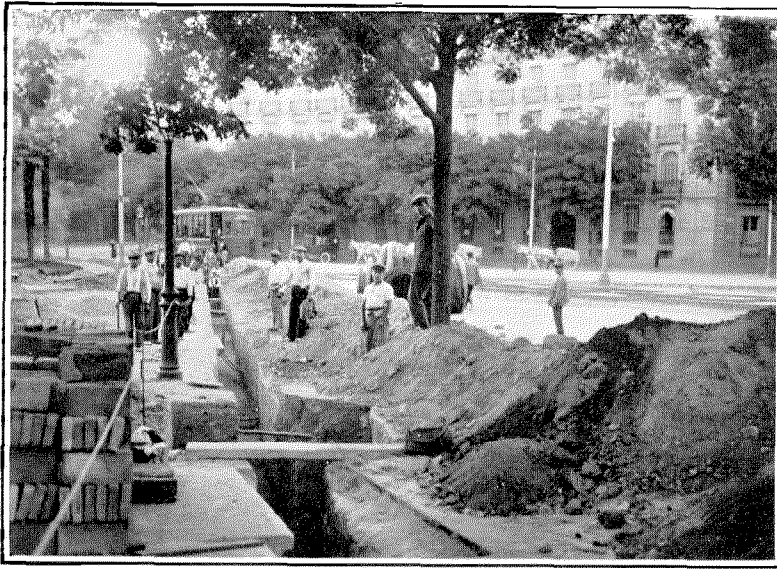

Figure 5—Running a Trench of the Underground Telephone Cable System across the Plaza Colon, Madrid. The variety of pipes and bare cables of other subterranean systems crossing at various levels may be noted.

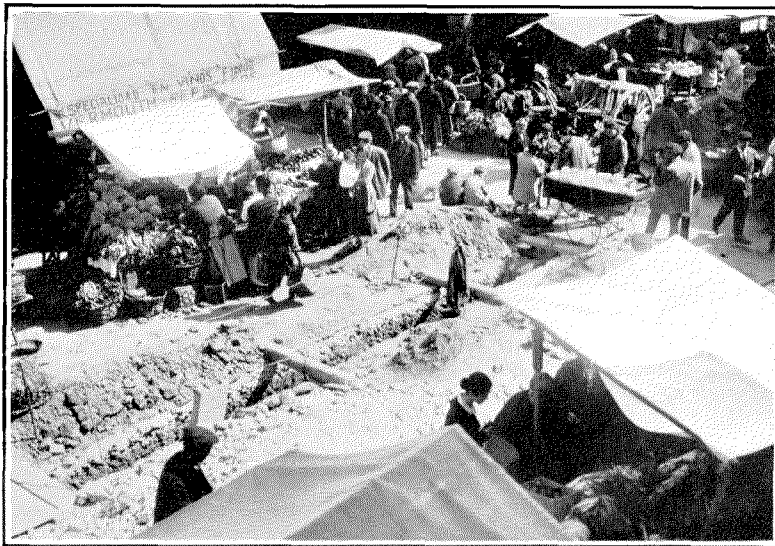

Figure 6—Running the Telephone Cable Trench through a Crowded Market-place in Augusto Figueroa Street, Madrid.

selectors are gear-driven, this being the first multi-office area in which that type of drive has been used exclusively. "The Spanish circuits," as those of the Madrid plant are called, contain many new features, such as the "hold-over" circuit for registers, and the automatic release of a register, if held for more than 30 seconds without dialing. Routine testing equip-

ment for line finders, selectors, and registers is provided, together with complete facilities for monitoring and testing inter-office junctions.

The subscribers' lines are cabled from the M.D.F. to terminal strips mounted above the final selector bays, and from there to the final selector arcs, 200 lines comprising one final selector group.

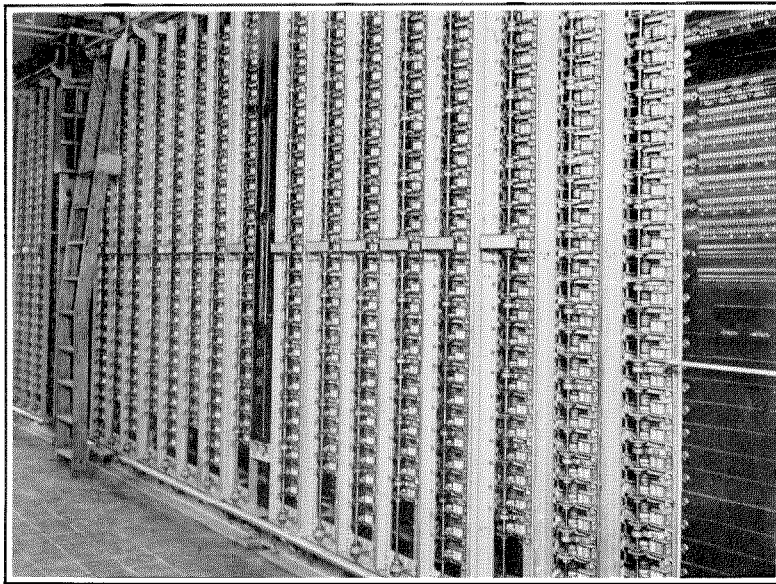

Figure 8—Second Line Finders, Salamanca Exchange, Madrid.

Each line finder bay is equipped for 100 subscribers' lines, the first fourteen line finders which serve this group of 100 lines being mounted

in the lower half of the bay, and their associated relays, as well as 100 line and cut-off relays, in the upper half. The A, B and C wires from the line finder arcs and cut-off relays are wired to terminal strips mounted above the line finder bays.

The subscribers' lines are connected to the line relays and line finder arcs by means of jumpers from the final terminal strips to the line finder terminal strips, these being, in effect, an I.D.F. for distributing the subscribers' lines to the line finder groups as traffic conditions require.

The number of trunks between offices are as follows:

Gran Via to Jordan.....	185
Gran Via to Salamanca.....	124
Jordan to Gran Via.....	220
Jordan to Salamanca.....	88
Salamanca to Gran Via.....	220
Salamanca to Jordan.....	132

In addition 22 trunks from Jordan and Salamanca to Gran Via for special service two-digit calls and 38 four-digit direct automatic trunks from toll to Jordan, and 27 from toll to Salamanca are equipped.

The number of local second group selectors at Gran Via is 293; at Jordan, 122; and at Salamanca, 78. Gran Via is also equipped with 35 second selectors for special service calls, and 87 four-digit automatic trunks from toll.

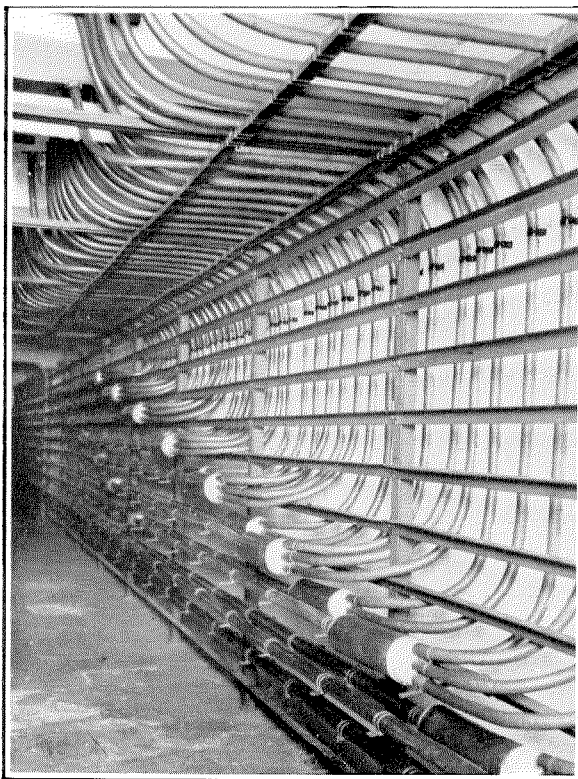

Figure 7—Cable Vault in Jordan Automatic Exchange, Madrid.

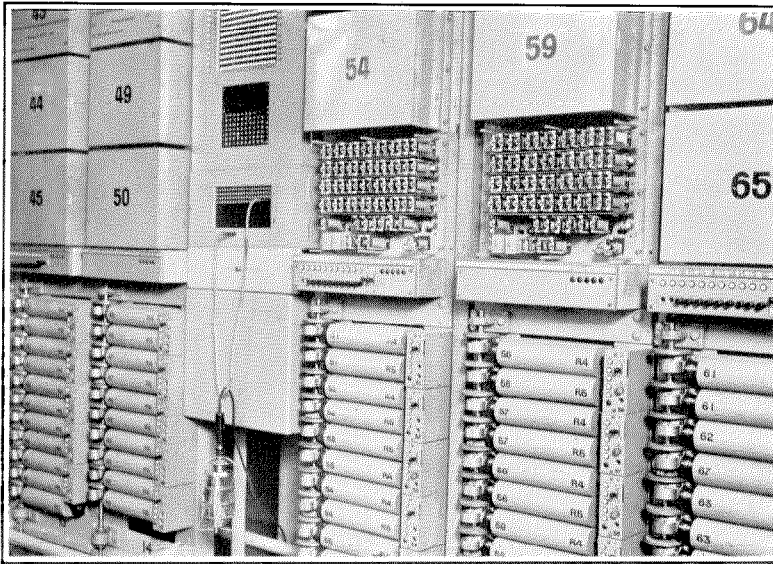

Figure 9—Register Bays, Showing Relays, in the Temporary Gran Via Exchange, Madrid.

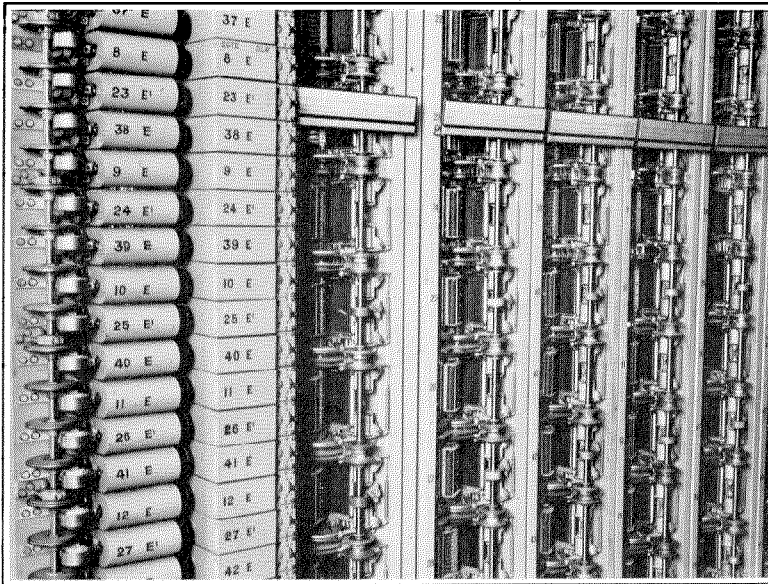

Figure 10—Group Selectors, Salamanca Exchange, Madrid.

The number of register circuits for the 7,000 lines at Gran Via is 95, and for Jordan and Salamanca with 5,000 lines, 68 each.

At Gran Via exchange, ten groups of connecting circuits of 56 circuits each are equipped, and at Jordan and Salamanca, seven groups of 58 circuits each.

The register choosers, associated with each

connecting circuit, are 50 point, gear driven line finders with seven brushes, having access to 48 register circuits, two sets of terminals being reserved for other purposes.

The last four connecting circuits in each group at Gran Via exchange are used as automatic 5-digit trunks from the Hortaleza exchange, 200 metres distant, where are installed the toll

and toll recording, information, suburban and official P.B.X. boards, the latter being used as a private branch exchange board for the various departments of the Company.

In each of the three exchanges there is provided special first line finder equipment, designed for two-party line selective ringing service. As party line service is practically unknown in Spain, this relatively small quantity of equipment has been provided by the Company in order to promote telephone development and the telephone habit through the introduction of this type of service at a price below the normal rates.

For the ordinary final selector groups of 200 lines, Gran Via has thirty-one groups with 24 finals each; Jordan, twenty-two groups with

20 finals each; and Salamanca, twenty-three groups with 15 finals each.

In each exchange, certain groups of 200 subscribers' lines are reserved for private branch exchange service, and are equipped with special final selectors designed for P.B.X. hunting. As the calling rate into these groups is naturally higher than into the ordinary groups, a greater number of final selectors is provided. Gran Via has four groups of 33 finals each; Jordan, three groups of 28 each; and Salamanca, two groups of 20 each. Each group of 200 subscribers' lines is also equipped with one test final and one toll offering final selector.

All relays and sequence switches associated with the various types of selectors are mounted on combined relay and sequence switch bays, with a capacity of 45 circuits each. Adjacent to each sequence switch are mounted the routine test key and a listening and "busy" jack.

Each level on a first group selector has access to 20,000 subscribers' lines, the register circuit being so wired that the 10,000's digits 1 and 2, 3 and 4, etc., are directed to the odd levels 9, 7, 5 and 3, level one being reserved for special service calls, so that the present capacity of the Madrid area is 80,000 lines.

The capacity may be brought up to 180,000 by the introduction of 6-digit dialing, at which time the even levels may be brought into use, the register circuit being so wired that by slight alterations and additions this may be easily accomplished.

The register consists of 4 sets of counting relays and two sequence switches, and is so designed that the 10,000's counting relays can be used to receive the unit impulses from the subscriber's dial. The arrangement of the wiring is such that the registers may be readily converted for use when 6-digit dialing is introduced.

A monitoring and test desk (Figure 12) is provided for each exchange where, by means of jacks and keys any outgoing junction may be tested, or "made busy," or a group of first line finders or subscribers' lines may be placed under observation. The permanent glow lamps (P.G.L.) and jacks are mounted in this desk. These lamps are associated with the connecting circuit and flash when a connecting circuit is disconnected from a register circuit if a subscriber fails to dial within 30 seconds after

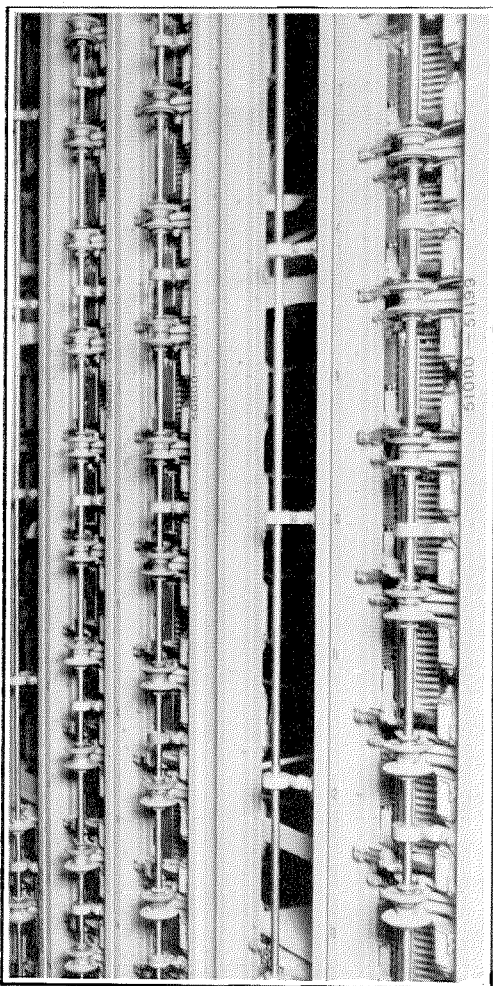

Figure 11—Final Selectors in the Salamanca Exchange, Madrid.

receiving the dialing tone or between digits or if held by a faulty line. This cuts down the holding time of the registers, and with the larger grouping of registers in the register choosers requires fewer of them.

Mounted in this desk also are the overflow lamps from the first line finders and connection circuits, which indicate when all circuits in any group are busy.

Group switch guard lamps are provided which indicate that the calling subscriber has failed to release after the called party has restored his receiver, and are also used to indicate the number of a connection circuit connected to a register. Associated with each register circuit is a key (F.L.K.) mounted in the panel, below the G.L. lamps, which, if depressed when a register is held by a connecting circuit, will cause the G.L. lamp to burn, thus indicating the number of the connecting circuit connected to that register.

Each register is equipped with a "Hold-over" feature which will hold the register and selector circuits, if for any reason all the impulses are not stepped out of the register after the subscriber has dialed the full number of digits. When the subscriber restores his receiver, his line is freed to make another call, but a lamp (H.O.L.) on the register will light and the faulty call can then be traced out by an attendant.

A complete system of audible and visual alarms is provided throughout the equipment for the purpose of notifying an attendant of all abnormal conditions such as failures of battery or ringing power equipment, and various kinds of subscribers' line troubles.

The power equipment (Figure 13) at each automatic exchange is identical. It includes a 48 volt 4500 ampere-hour battery consisting of 25 cells each, with a tap from each of the last seven cells extending to an end cell switch which is automatically operated to maintain a 48V exchange potential within the limits of plus or minus 2 volts.

The charging equipment consists of two motor driven compound generators with a capacity of 385 amperes at 48-60 V, so arranged that they can charge the batteries or float the load singly or in parallel. When charging, the machines are shunt connected, and when floating the load their voltage is automatically regulated by

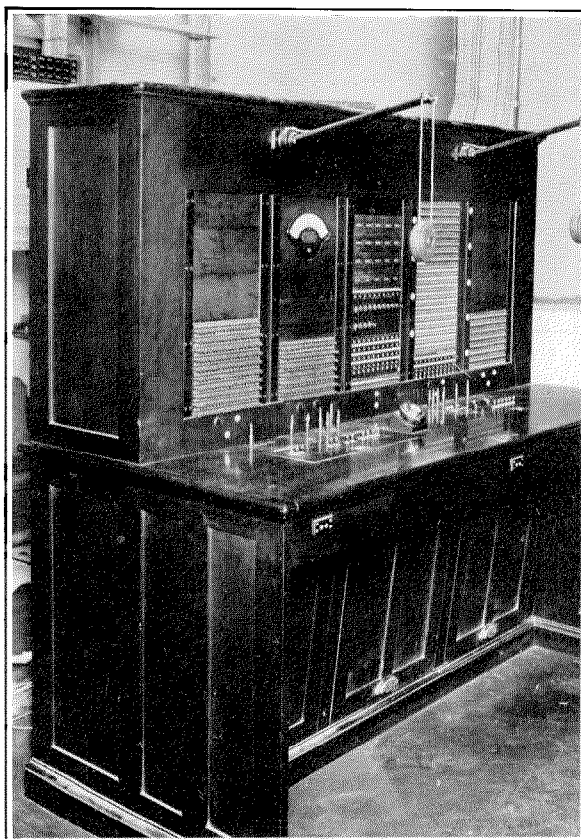

Figure 12—Monitoring and Test Desk.

means of the compound winding in the generators.

A reserve engine driven generator-set consisting of a 6 cylinder engine directly connected to a generator is provided for prolonged failures of the commercial power (Figure 14). These sets are capable of supplying current at 220 volts to the motor generator sets for floating the busy hour load, including the switchrack motors, and 110 volts for a reasonable percentage of the switchrack and building lighting.

The switchrack motors are normally operated from commercial power supply of 220 volts; but in the event of failure of the commercial power, a 48 V motor driven from the main battery connected to a 220 V generator is automatically started and current is fed to the switchrack motors in place of the commercial power. This generator also furnishes a limited number of emergency lights for the switchrack.

Owing to varying local conditions, a uniform plan could not be carried out for the cut-over

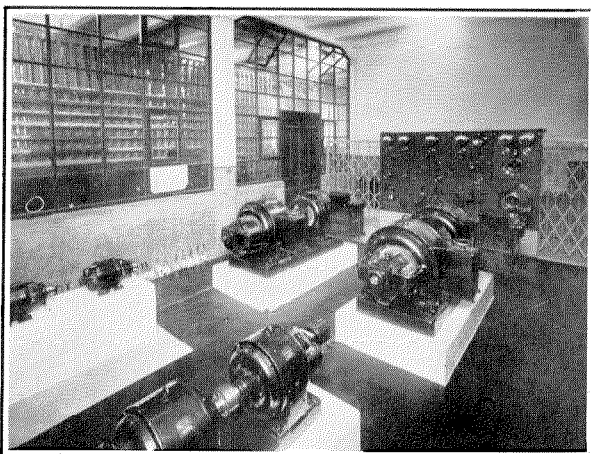

Figure 13—Power Plant with Main Distributing Frame of the Gran Via Temporary Exchange (Madrid) in the Background.

of all of the exchanges. In the case of the old Mayor local battery exchange subscribers who were to be served by the provisional Gran Via automatic office, the plant was completely duplicated. Automatic telephones were installed in the houses of the subscribers, beside the manual magneto instruments, and connected by the underground cable system with the main frame of the automatic exchange, while the manual telephones continued to give service by means of the old overhead connections with Mayor.

In the Jordan and Salamanca offices, the new main frames were installed as closely as possible to the existing main frames of the common battery manual exchanges. As quickly as the underground cables were installed in these two areas, automatic telephones were substituted for manual in the homes of the subscribers. These were connected by means of the underground cable plant to the new main frames, and by jumper wires to the old main frames, thus enabling them to work temporarily as manual common battery telephones. The old overhead wires and cables in the Jordan and Salamanca areas thereupon ceased to appear further in the local service.

It was thus possible in the two exchanges mentioned above to accomplish the cut from the old switchboards to the new Rotary switching equipment by the usual plan of cutting the temporary jumpers and removing the cut-off relay plugs in the new switchboard.

As mentioned in the introduction, the physical cut-over, which was set for midnight to take advantage of the light traffic load, was preceded on the afternoon of the 29th of December with a formal ceremony in which the King, his cabinet, foreign diplomats and upwards of 200 invited guests, representative of the financial, industrial and political life of the nation, took part. This was held at the Salamanca exchange, since it was the only place where there was space available for such a gathering.

A large vacant room on the ground floor of the new building was decorated and provided with long, narrow tables and chairs for the guests and a raised platform at the rear of the room, where a table and seats were placed for His Majesty, General Primo de Rivera, the Infante Don Fernando, General Martinez Anido, Minister of Gobernacion, the Papal Nuncio, the Marqués de Urquijo, President of the Compañía Telefónica Nacional de España, and Colonel José Tafur, Director General of Communications. A reproduction of a photographic view of His Majesty and those who accompanied him is shown in Figure 15. At each seat in the room was a watchcase receiver and a small map of the principal telephone lines in Spain.

The inaugural ceremony started at 3:30 P.M. with an address to the King by the Marqués de Urquijo, in which he outlined briefly the work accomplished by the Company in the two years of its existence.

After dealing with the decision to install automatic plant in the twenty towns of Spain and reciting some statistics in the development

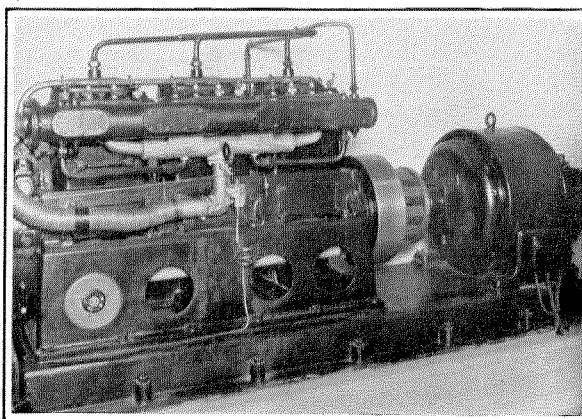

Figure 14—Emergency Gas Engine of the Auxiliary Power Plant, Madrid.

of the new system, both local and long distance, the Marqués announced that as a demonstration of the practical effectiveness of the service, the chief engineer, Mr. F. T. Caldwell, would establish a circuit and enable all present to hear a conversation over a distance of 3,800 kilometres, "a distance never attained in Europe, and one which, if it were established in a straight line, would cross Europe from east to west."



His Majesty the King of Spain.

General Primo de Rivera rose and responded briefly to the Marqués de Urquijo in the name of the Government. The chief engineer then conducted a roll-call of sixteen repeater stations, establishing a circuit that touched San Sebastian on the Bay of Biscay, Barcelona on the east coast of the Peninsula, Ceuta in the Spanish protectorate of Morocco, and, turning north through Madrid, terminated at Coruña, in the northwest corner of Spain.

As the repeater stations responded to the roll-call, lamps lighted automatically on two huge wall maps, enabling the audience with greater ease to follow the course of the demonstration. A small copy of these maps, placed on the table

in front of King Alfonso, and provided with tiny green lights, served to visualize the event for the King and those around him.

When Coruña had answered, the King signified his desire to speak over the circuit that had established a new European long distance record, and taking the gold-inlaid telephone that had been provided for him, said:

"I must congratulate myself as well as congratulate Spain and the Compañía Telefónica Nacional de España upon the magnificent achievement in communication which has just been realized. Nothing gives me greater pleasure than to witness every day the advance of Spain on the road of progress. The most important progress of all is the moral, the ethical. No society can live without refined idealism, nor without the cultural side which familiarizes us with science, and allows us to use its unlimited resources for the good of humanity. From both will spring the principles which will inspire the life of the people. The Spaniard is obliged, more than any other, to fall back on his proud traditions, which have given vitality to nations that are the pride of the world. Without boasting or false illusions, with perseverance and optimism, let us all work for the Spain of today with the mind fixed on the Spain of tomorrow—on the Spain of our sons."

King Alfonso then went on a tour of inspection of the exchange, terminating on the second floor, in the Rotary switching equipment room. Here the Bishop of Madrid-Alcala was waiting in full robes to pronounce his benediction upon the plant which was to provide the future telephone service for the capital of Spain. Following this solemn act, His Majesty threw a switch arranged to set in motion the shafting in the exchange. Thus ended the impressive ceremonial part of the cut-over.

At 11:55 P.M. operators on the manual switchboards began to challenge calls.

The various steps of the cut-over may be followed in the accompanying work schedule (Table I) which was carried out that night on a strict time basis, with a dispatcher who handled all movements by telephone. In general, the trunks to the toll board were first released and

cut into the automatic plant, after which the subscribers' lines were cut over from the manual to the automatic service.

1924 and effected such reforms as were practically possible. Although the quality improved vastly under the new control, the condition of

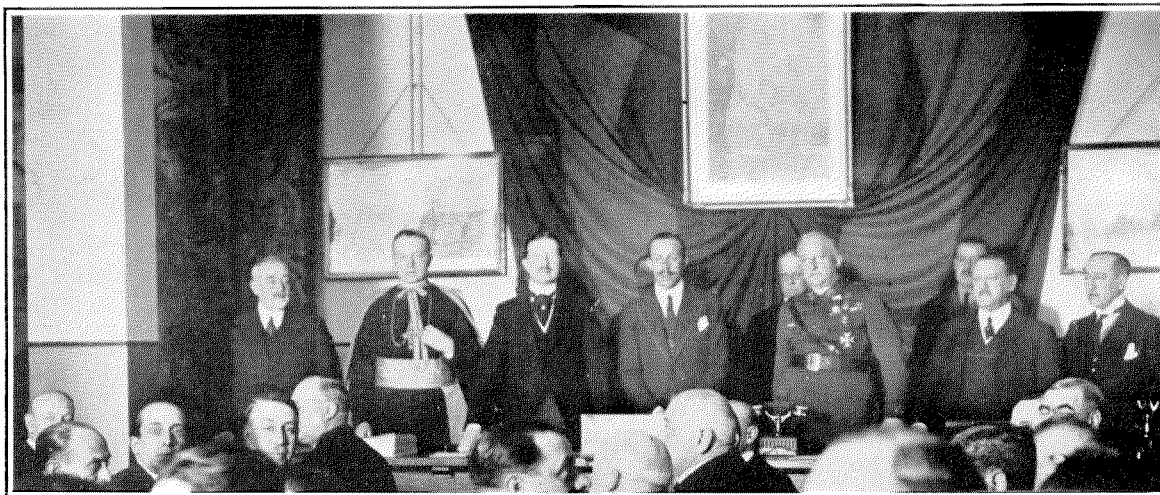

Figure 15—King Alfonso XIII and Those Who Accompanied Him at the Demonstration of Long Distance Service in Madrid on the Occasion of the Inauguration of the Automatic Plant, December 29, 1927. From left to right—Colonel José Tafur, Director General of Communications; the Papal Nuncio, Mgr. Tedeschini; Infante Don Fernando; H. M. King Alfonso; General Primo de Rivera; General Martínez Anido, Minister of the Interior; the Marqués de Urquijo, President of the Compañía Telefónica Nacional de España and Vice President of the Standard Electrica, S. A.

In the case of the Salamanca and Jordan exchanges, the cables from the manual switchboards to the manual main frames were first cut at the terminal blocks, as representing the quickest method of severing the connections and the cut-off relay plugs were pulled, thus establishing automatic service, after which the jumper wires between the new and old main frames were cut and removed.

Subscribers of the old Mayor exchange were given automatic service by pulling the plugs on the cut-off relays. A little while later, the operators of Mayor exchange were sent home, and the battery switch was withdrawn.

Notwithstanding the hour selected for the cut-over, Madrid started with a highly abnormal traffic load. Curiosity was the predominating cause. During the first few days the traffic went as high as 300 percent above normal and then gradually settled down to a new calling rate about 50 percent higher than had existed on the old system.

The curiosity load is easy to explain. In the first place, local service in Madrid had been far from ideal, even after the Compañía Telefónica Nacional de España took over its operation in

the old plant made it out of the question to render really satisfactory service. The subscribers had been told that the practical remedy for their sorrows was to build a new automatic plant and scrap the old one, and that the Company was doing this with all possible speed. Great things had been promised for the automatic service, and with this hope the public had watched with growing interest the construction of buildings, the digging of the streets, the pulling of the cables through the manholes, and the installation of wall cables and telephones in their houses.

Another powerful influence in developing and maintaining interest in the coming of the automatic telephone had been the educational campaign carried on to instruct both subscribers and non-subscribers in the proper use of the dial instrument. In the weeks immediately preceding the cut-over, Commercial Department agents made visits to the houses of all subscribers to instruct them in dialing and to allow them to hear the dialing, ringing and busy tones. Public demonstration stations were set up in twelve different parts of the city to allow passers-by to practice the use of the automatic,

TABLE I
WORK SCHEDULE
Order for Operation
Madrid Cut-over—December 29, 1926

No.	Description	Office	Supervisor	Begin	Finish
1	Report men on duty	Hortaleza and Telefonemas	Mr. Hale	P.M. 7:00	P.M.
2	Report ready to change jumpers Telefonema trunks	Hortaleza	"	7:30	
3	Report Traffic releases multiple for three Telefonema trunks	"	Mr. Quinn	8:00	
4	First order to tie down jumpers for Telefonema trunks	"	Mr. Hale	8:00	8:15
5	Report Traffic releases multiple for eight Telefonema trunks	"	Mr. Quinn	10:00	
6	Second order to tie down jumpers for Tele- fonema trunks	"	Mr. Hale	10:05	10:30
7	Report men on duty	Gran Via	Mr. Ward Mr. Schooneman	10:15	
8	"	Jordan	Mr. Eckstein Mr. Rinkjob	10:15	
9	"	Salamanca	Sr. Marin Mr. Stalder	10:15	
10	Report Power Plant running	Gran Via	Mr. Schooneman	10:30	
11	"	Jordan	Mr. Rinkjob	10:30	
12	"	Salamanca	Mr. Stalder	10:30	
13	Report all men at their positions	Gran Via	Mr. Ward Mr. Schooneman	11:50	
14	"	Jordan	Mr. Eckstein Mr. Rinkjob	11:50	
15	"	Salamanca	Sr. Marin Mr. Stalder	11:50	
16	"	Hortaleza	Mr. Hale	11:50	
17	Report Traffic Release	All	Mr. Quinn	11:55	
18	Order to Cut Multiple Cables	Jordan	Mr. Eckstein	Midnight 12:00	A.M. 12:05
19	"	Salamanca	Sr. Marin	12:00	12:05
20	Order to Cut Jumpers	Gran Via	Mr. Ward	12:00	12:05
21	Wait for Reports on 18, 19 and 20 before next orders				
22	Order to remove fibres from cut-off relays	Gran Via	Mr. Schooneman	A.M. 12:07	12:20
23	"	Jordan	Mr. Rinkjob	12:07	12:20
24	"	Salamanca	Mr. Stalder	12:07	12:20
25	Order to shut down manual	Jordan	Mr. Eckstein	1:00	
26	"	Salamanca	Sr. Marin	1:00	

ADDITIONAL WORK SCHEDULE

No.	Description	Office	Supervisor	Begin	Finish
1	Order to connect trunks for 04 Service	Hortaleza	Mr. Hale	A.M. 12:15	A.M. 1:30
2	Third order to tie down jumpers for Tele- fonema trunks	"	"	12:15	12:25
3	Report Replaced fibres cut-off relays	Jordan	Mr. Rinkjob	12:45	
4	"	Salamanca	Mr. Stalder	12:45	
5	"	Gran Via	Mr. Schooneman	1:15	
6	Report Removed temporary jumpers auto- matic M.D.F.	"	Mr. Ward	3:00	
7	"	Jordan	Mr. Eckstein	7:00	
8	"	Salamanca	Sr. Marin	7:00	
9	Report Test of Inter-Office trunks	Gran Via	Mr. Caldwell	7:00	
10	"	Jordan	"	7:00	
11	"	Salamanca	"	7:00	
12	Order to shut down manual	Mayor	Sr. Garrion	10:00	

NOTE:—A.M. refers to the morning of December 30, 1926.

and at these places instruction was given to 41,477 persons. At the same time, 22,074 illustrated folders and 6,422 copies of the Company's magazine were passed out to visitors at these demonstration booths. Moving pictures showing the use of the automatic telephone were run in the principal theatres, large advertisements were published in the newspapers, cards and posters were displayed in public places, and subscribers were circularized.

While all this publicity undoubtedly stimulated curiosity to try the new service, at the same time it served the helpful purpose of familiarizing the people with the use of the automatic telephone. The effort and expense represented by this educational campaign proved to be well justified by the low subscribers' error factor manifested immediately after the cut-over, and that steadily declined in the months that followed.

It is not extravagant to say that the automatic service has more than lived up to the fondest expectations of the people of Madrid. To meet the general demand for additional facilities, the Company proceeded immediately after the cut-over to extend the plant in all parts of the city. Work was started on the first of the year 1927 upon a new exchange building, to be known as Delicias, to serve a portion of the area now belonging to the Gran Via office. Meanwhile, the installation of additional equipment was started in the three existing exchanges, so that by the end of 1927 Gran Via had approximately 10,000 lines, Salamanca 8,000 and Jordan 7,000,

thus giving Madrid an increase from 17,000 to 25,000 lines in the first year following the cut-over. The first 5,000-line unit of the Delicias exchange will come into service in 1928. Additions of 3,000 lines in Jordan, 2,000 in Salamanca and 2,000 in Delicias, and the first 5,000-line unit of the permanent Gran Via exchange, will be cut in before the close of 1929, bringing the automatic plant facilities of Madrid up to 42,000 lines.

A new long distance switchboard will be installed in the permanent Gran Via building in 1929. Meanwhile, in the Hortaleza exchange are the 28-position No. 2001 Toll Board; the 16-position No. 2001-D Board which, with certain modifications, is handling the suburban service as well as the P.B.X. calls of the Company; a 10-position information desk; and a 10-position recording desk.

The 6-position complaint desk is in the provisional Gran Via exchange, and there is located in a building on the Puerta del Sol a 28-position board where are handled the "telefonemas," or written messages that are handed in by the public for transmission by telephone to all parts of Spain.

Outside plant extensions are varied and correspondingly large. The programme includes laying 23,000 metres of fibre conduit; pulling 21,725 metres of underground cable, containing 39,492,000 metres of conductors; installing 52,900 metres of wall cable, representing 6,669,550 metres of conductors; stringing 5,375 metres of aerial cable, with a total conductor length of 1,373,500 metres; planting 150 poles and placing 6,420 metres of drop cable.



Modern Wall Telephone Type.

La Transformation du Réseau Téléphonique de Paris en Automatique*

Par G. POCHOLLE

Ingénieur des Télégraphes

La téléphonie automatique se généralise rapidement dans le monde entier. La France n'est pas en retard sur ce point et, actuellement, toutes les installations neuves de moyenne et grande importance sont équipées en automatique.

L'article ci-dessous—qui fait suite aux études que nous avons publiées précédemment sous la signature de M. Cornet, Ingénieur en chef des Postes et Télégraphes—est consacré au réseau de Paris, dont la transformation en automatique est en voie de réalisation.

L'auteur, après quelques considérations d'ordre général, décrit les appareils qui seront employés à Paris, puis expose la façon dont seront résolus quelques-uns des problèmes que pose la transformation d'un réseau téléphonique de l'importance de celui de Paris: organisation générale du réseau, liaisons entre centraux automatiques et centraux manuels, liaisons entre Paris et les réseaux limitrophes atteints directement sans passer par l'interurbain.

Il montre enfin les avantages considérables qui seront obtenus par le téléphone automatique: rapidité, sûreté, facilités d'entretien et souplesse d'exploitation.

La Téléphonie Automatique à Paris

LA TECHNIQUE des réseaux urbains de moyenne et grande importance est définitivement orientée vers l'automatique; introduit pour la première fois en France dans un réseau public à Nice, en 1913, l'automatique a été successivement installé à Angers, Marseille, Orléans, Dieppe, Vichy, Le Havre, Montpellier. Les installations de Lyon, Bordeaux, Rennes, Troyes, Nantes, Fontainebleau, Colmar sont en cours de montage; la transformation de tous les autres réseaux importants est prévue dans un avenir très rapproché; enfin celle de Paris, à l'étude depuis plusieurs années, a été décidée en octobre dernier, et les travaux d'installation vont commencer incessamment.

NÉCESSITÉ D'UNE TRANSFORMATION PROGRESSIVE

Le réseau de Paris compte actuellement 150 000 abonnés environ, répartis en une trentaine de séries: Gutenberg, Central, Louvre, etc. . . . , à chacune desquelles correspond un central téléphonique ou « multiple »; le trafic est très intense, si on le compare à celui de la plupart des grands réseaux étrangers: 1 500 000 communications urbaines par jour, soit environ 250 000 communications à l'heure chargée, avec des pointes de près de 20 000 communications

* Reproduced, by kind permission, from *La Technique Moderne*. Vol. XIX., No. 13, July 1, 1927.

simultanées. La transformation d'un réseau aussi important ne saurait être instantanée. D'une part, aucun constructeur ne serait capable de livrer en une seule fois le matériel nécessaire. D'autre part, la substitution générale et instantanée de centraux automatiques aux centraux manuels existants exigerait le dédoublement de toutes les installations. L'opération serait, de plus, désastreuse au point de vue financier: un grand nombre de centraux manuels sont tout récents et en excellent état de service; désaffecter ces centraux alors qu'ils sont loin d'être amortis serait gaspiller les deniers de l'État.

CONSÉQUENCES

La transformation du réseau de Paris sera échelonnée sur une dizaine d'années environ; lorsqu'elle sera entièrement terminée, le réseau comptera vraisemblablement près de 400 000 abonnés (l'accroissement du réseau, très rapide, suit une loi à peu près exponentielle au taux d'environ 10% par an).

Le programme de transformation prévoit l'équipement de 40 000 lignes par an en moyenne; les premiers bureaux automatiques seront les suivants:

Carnot (rue Guyot): 6 000 lignes équipées en 1928, complété à 10 000 en 1929;

Diderot (avenue Daumesnil): 10 000 lignes équipées en 1929;

Gobelins (boulevard de Port-Royal): 10 000 lignes équipées en 1929;

Vaugirard (rue Jobbé-Duval): 8 000 lignes équipées en 1929;

Trudaine (rue de Navarin): 10 000 lignes équipées en 1929.

La coexistence, pendant toute la période transitoire, de centraux manuels et de centraux automatiques nécessite des installations spéciales destinées à écouler le trafic manuel vers automatique et automatique vers manuel; ces installations comprennent des *indicateurs d'appels* d'une part, des *positions semi-B* et *claviers de sélection directe* d'autre part.

La transformation en automatique nécessite, de plus, des installations spéciales destinées à écouler le trafic échangé entre le réseau urbain et les réseaux limitrophes de la banlieue de Paris; ces installations, analogues aux précédentes, seront rassemblées dans des *centres de transit*.

Établissement d'une Communication en Réseau Automatique

Le poste d'abonné en réseau automatique diffère des postes actuels par l'adjonction du *cadran d'appel* (fig. 1).

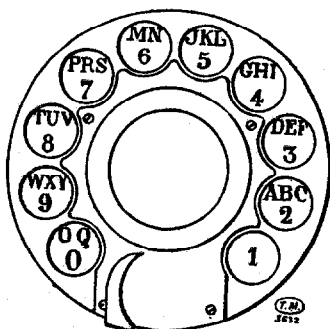

Fig. 1—Dispositif du cadran d'appel de Paris

DEMANDE DE COMMUNICATION EN RÉSEAU AUTOMATIQUE

Pour demander une communication en réseau automatique, décrocher l'appareil et porter le récepteur à l'oreille. Une tonalité spéciale, dite *signal de transmission* (tonalité continue de même hauteur que le retour d'appel), indique que les organes du central sont en mesure de recevoir l'appel (cette tonalité parvient au demandeur une seconde et demie environ après le décrochage). Envoyer alors avec le cadran successivement chacun des signes, lettre ou chiffre, composant le numéro de l'abonné demandé (pour demander par exemple Ségur 46-62, envoyer SEG 46-62).

L'envoi d'une lettre ou d'un chiffre se fait très simplement de la façon suivante: enfoncer l'index dans le trou correspondant à cette lettre ou à ce chiffre; tourner le disque mobile jusqu'à ce que le doigt soit arrêté par la butée fixe; lâcher alors le cadran, qui revient de lui-même à sa position de repos. L'envoi d'un chiffre dure en moyenne une seconde et demie et l'envoi d'un appel complet, à Paris, environ dix secondes. Le demandeur perçoit le *retour d'appel* ou le

signal d'occupation aussitôt la *sélection* terminée, soit en moyenne treize à quatorze secondes après le début de la manœuvre du cadran. Cette durée est légèrement augmentée dans le cas où le demandé est relié à un bureau manuel, mais n'excède pas alors vingt à vingt-cinq secondes.

AIGUILLAGE DE LA COMMUNICATION

La manœuvre précédente a pour effet de relier la ligne du demandeur à celle du demandé de la façon suivante.

L'abonné décrochant son appareil, sa ligne se marque appellante au central. Elle est prise aussitôt par un *chercheur de lignes* ou *chercheur primaire*, puis à la suite par un *chercheur d'appels* ou *chercheur secondaire*. Ces chercheurs sont des organes de présélection, destinés à concentrer le trafic et à le répartir également sur l'ensemble de l'installation automatique. La présélection étant effectuée, la ligne de l'abonné est prolongée par un *chercheur d'enregistreurs* vers un *enregistreur* qui, aussitôt connecté, envoie à l'abonné demandeur le signal de transmission.

L'abonné demandeur manœuvrant son cadran, celui-ci transmet au central des *impulsions*; une impulsion est un signal télégraphique composé d'une rupture de 0,066 seconde et d'une fermeture de 0,033 seconde. A chaque lettre ou

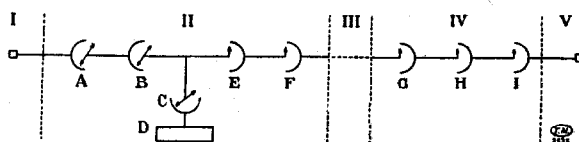

Fig. 2—Diagramme d'établissement d'une communication entre deux abonnés reliés à des bureaux automatiques différents

I, Poste et ligne de l'abonné demandeur;—II, Bureau automatique de départ;—III, Ligne auxiliaire;—IV, Bureau automatique d'arrivée;—V, Poste et ligne de l'abonné demandé.

II.—A, Chercheur primaire ou de lignes;—B, Chercheur secondaire ou d'appels;—C, Chercheur d'enregistreurs;—D, Enregistreur-traducteur;—E, Sélecteur primaire (de bureau);—F, Sélecteur secondaire (de bureau).

IV.—G, Sélecteur tertiaire (numérique);—H, Sélecteur quaternaire (numérique);—I, Sélecteur final (numérique).

chiffre envoyé par l'abonné correspond un *train d'impulsions*, composé d'autant d'impulsions élémentaires qu'il existe d'unités dans le chiffre envoyé ou dans le chiffre inscrit sur le cadran à côté de la lettre envoyée (le chiffre 0 correspond à 10). Chaque train d'impulsions est reçu dans l'enregistreur sur un commutateur à 10 positions;

à la fin de l'envoi, le numéro complet est en quelque sorte matérialisé par l'orientation de ces commutateurs. Le rôle de l'abonné est alors terminé.

L'enregistreur ayant reçu le numéro demandé commande et contrôle le mouvement et l'arrêt en position convenable d'une série d'organes aiguilleurs ou *sélecteurs*. Le diagramme de la figure 2 montre l'établissement d'une communication en réseau complètement automatique; les sélecteurs primaire et secondaire aiguillent la communication vers le bureau auquel est relié l'abonné demandé; les sélecteurs tertiaire, quaternaire et final placés dans le bureau d'arrivée aiguillent la communication jusqu'à la ligne de l'abonné demandé.

Aussitôt les appareils orientés en position convenable, le demandé est *sonné* ou signalé *occupé*; le demandeur perçoit le retour d'appel ou le signal d'occupation. L'enregistreur, dont le rôle est terminé, se libère. Les organes de sélection reviennent en position de repos lorsque les abonnés raccrochent à la fin de la communication.

Nous verrons plus loin comment les choses se passent lorsque, en période de transformation du réseau, l'un des deux abonnés est encore relié à un central manuel.

Les Appareils Automatiques

Le réseau de Paris sera équipé avec le matériel du type dit *Rotary*, décrit antérieurement par notre Revue.¹ Les appareils ayant subi depuis cette date quelques modifications, nous croyons utile de les décrire à nouveau ici, en indiquant les raisons de ces modifications et les avantages qui en résultent.

CHERCHEURS

Les chercheurs de lignes (fig. 3 à 5), d'appels et d'enregistreurs sont du même type. Un chercheur se compose:

1° D'un *banc de contacts* fixe semi-cylindrique de 100 points (50 points pour le chercheur d'enregistreur);

2° D'un *chariot porte-balais* mobile autour de l'axe du banc. Le chariot porte deux jeux de balais diamétralement opposés montés électriquement en parallèle. Lorsque le banc est à 50

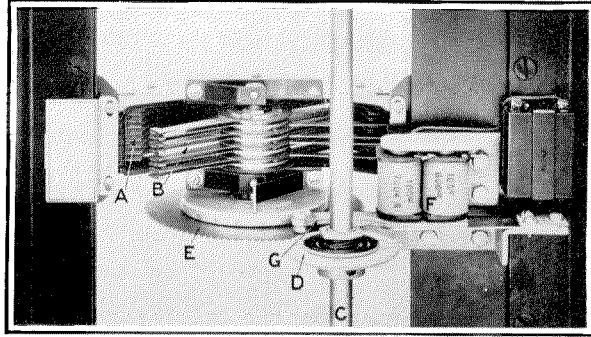

Fig. 3—Vue d'un chercheur
A, Banc de contacts;—B, Balais;—C, Arbre en rotation permanente;—D, Roue motrice;—E, Roue entraînée flexible;—F, Electro d'embrayage;—G, Armature de l'électro d'embrayage.

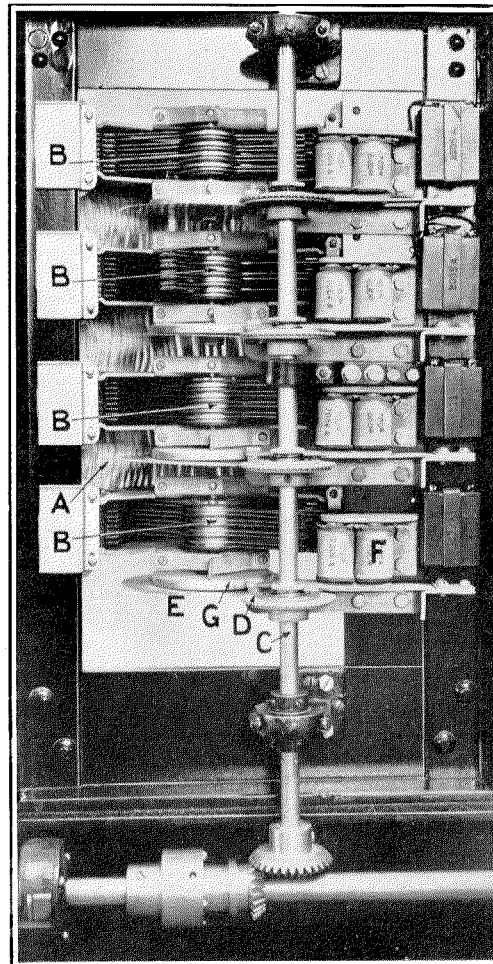

Fig. 4—Vue avant d'une baie de chercheurs
A, Multipliage en câbles-rubans;—B, Chariots porte-balais;—C, Arbre en rotation permanente;—D, Roue motrice;—E, Roue entraînée flexible;—F, Electro d'embrayage;—G, Tambour numéroté.

¹ Voir La Technique Moderne, t. XIV, n° 12 (15 nov. 1922), p. 490.

points, les deux jeux explorent successivement les mêmes broches; lorsque le banc est à 100 points, les deux jeux sont décalés de la moitié de l'intervalle compris entre deux balais et explorent deux séries de 50 jeux de broches, elles-mêmes

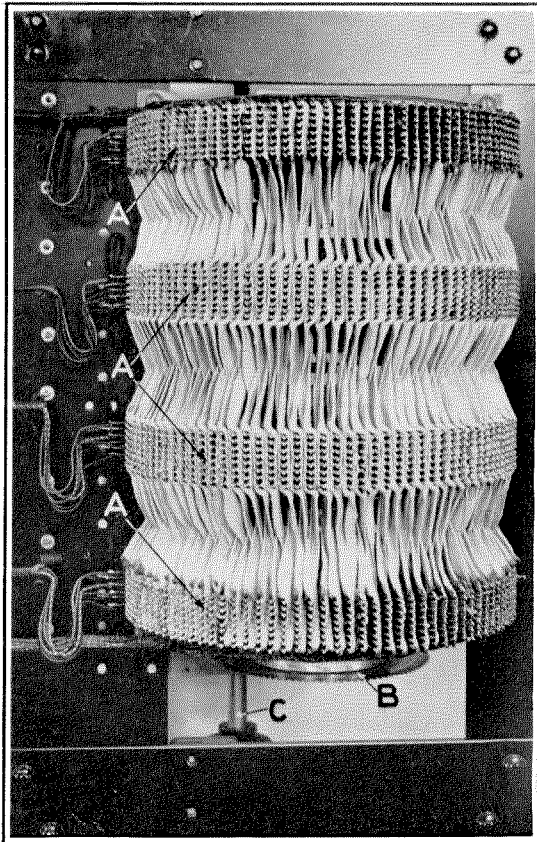

Fig. 5—Vue arrière d'une baie de chercheurs
A, Broches de soudure reliées par les câbles-rubans;—
B, Roue flexible du chercheur inférieur;—C, Arbre en rotation permanente.

décalées l'une par rapport à l'autre de la même quantité.

Cet appareil diffère assez sensiblement de l'ancien chercheur Rotary. Le champ de recherche a été porté de 60 à 100 lignes afin de réduire le nombre d'organes nécessaires à l'écoulement du trafic. D'autre part, le mode d'entraînement a été modifié: l'embrayage magnétique a été remplacé par un engrenage à roues dentées; la roue motrice, calée sur l'arbre, est animée d'un mouvement de rotation continu; la roue entraînée, solidaire du chariot porte-balais, est flexible; au repos, l'armature de l'électro d'embrayage maintient écartée de la

roue motrice la roue dentée flexible en lui imprimant une déformation élastique. Ce dispositif permet de déterminer très exactement les tolérances admissibles: en particulier, le glissement au démarrage est au plus égal au pas de l'engrenage; le circuit magnétique de l'électro d'embrayage en position de travail peut comporter un entrefer: la rémanence n'est plus à craindre et le glissement à l'arrêt est pratiquement nul.

SÉLECTEURS DE GROUPES

Le sélecteur (fig. 6 à 8) se compose:

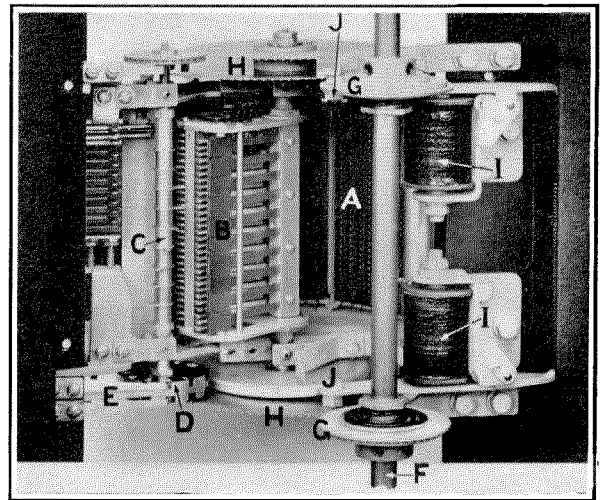

Fig. 6—Vue d'un sélecteur de groupe
A, Banc de contacts;—B, Chariot porte-balais;—C, Déclencheur de balais;—D, Interrupteur d'impulsions inverses et de centrage;—E, Frotteurs de l'interrupteur;—F, Arbre en rotation permanente;—G, G, Roues motrices;—H, H, Roues entraînés flexibles;—I, I, Electros d'embrayage;—J, J, Armatures des électros d'embrayage.

1° D'un *banc de contacts* fixe, semi-cylindrique, de 300 points disposés en 10 niveaux de 30 points;

2° D'un *chariot porte-balais*, mobile autour de l'axe du banc; le chariot porte 10 jeux de balais—un par niveau—tous montés électriquement en parallèle; un jeu de balais ne peut venir en contact avec le banc que s'il a été préalablement déclenché; un rouleau libre l'enclenche à nouveau lors du retour au repos;

3° D'un *arbre déclencheur de balais*, mobile autour d'un axe parallèle au précédent. Cet arbre porte dix ergots—un par niveau—disposés en hélice (le pas de l'hélice est de 30° par niveau environ) et un interrupteur d'impulsions inverses.

Le fonctionnement de l'appareil est le suivant: sous le contrôle de l'enregistreur qui reçoit les impulsions inverses produites par l'interrupteur, l'arbre déclencheur de balais s'oriente en position convenable; le chariot porte-balais démarre alors, le jeu de balais convenable est déclenché au passage devant l'ergot du déclencheur de balais et explore au cours de la rotation du chariot les 30 lignes du niveau correspondant.

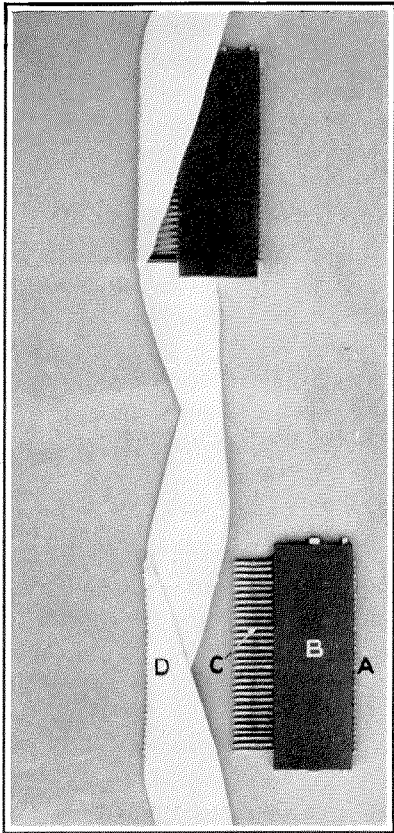

Fig. 7—Vue d'un câble-ruban pour baie de sélecteurs
A, Broches de contact;—B, Isolant moulé;—C, Broches de soudure;—D, Câble-ruban.

Cet appareil se distingue de l'ancien sélecteur Rotary par l'augmentation du champ de sélection (30 points par niveau au lieu de 20). L'entraînement est analogue à celui du chercheur précédemment décrit (engrenages à roue entraînée flexible). De plus, l'interrupteur d'impulsions inverses a été complètement modifié: au lieu d'un galet commandant des ressorts de contacts, il se compose (fig. 9) d'un disque en matière isolante dont la surface cylindrique porte une bague conductrice convenablement découpée sur la-

quelle viennent frotter trois balais: un balai central, point commun, relié à la terre en permanence, un balai d'impulsions inverses et

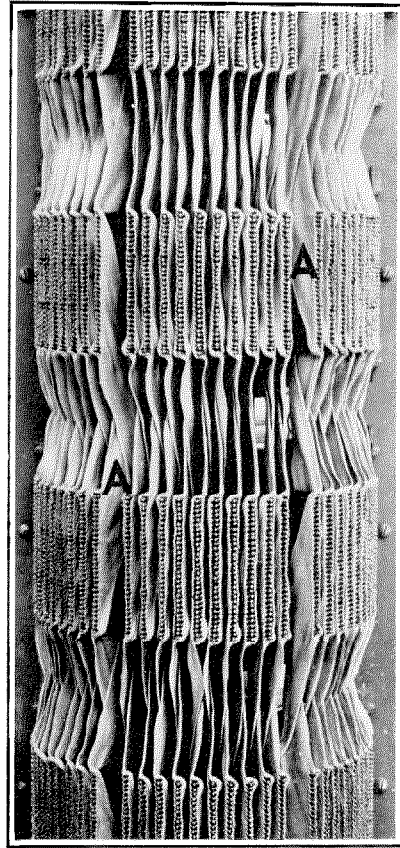

Fig. 8—Vue arrière d'une baie de sélecteurs
A, Câbles-rubans

un balai de centrage. Ce dispositif a permis d'augmenter les coefficients de sécurité des circuits; l'emploi combiné de l'embrayage à roues

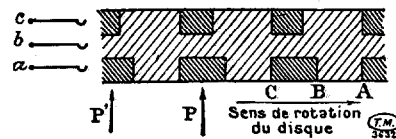

FIG. 9. — Schéma de l'interrupteur d'impulsions inverses.

///, Plaque conductrice; — //, Isolant; — a, Balai relié au fil d'impulsions inverses; — b, Balai relié à la terre; — c, Balai de centrage relié à l'électro d'embrayage; — A, B, Impulsion de court-circuit; — B, C, Impulsion de fermeture; — A, C, Impulsion complète; — P, P', Positions d'arrêt.

dentées et du balai de centrage a permis de supprimer l'électro-frein tout en augmentant la précision de l'arrêt.

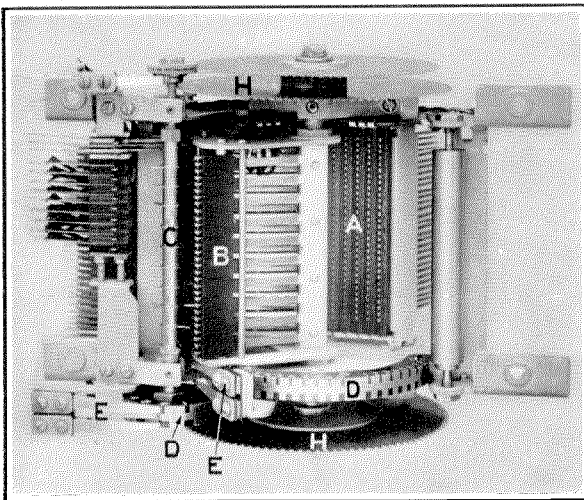

Fig. 10—Vue d'un sélecteur final (non monté sur baie)
A, Banc de contacts;—B, Chariot porte-balais;—C, Déclencheur de balais;—D, Interrupteur d'impulsions inverses et de centrage;—E, E', Frotteurs de l'interrupteur;—H, H, Roues entraînées flexibles.

SÉLECTEURS FINALS

Le sélecteur final (fig. 10) est identique au sélecteur de groupe, sauf en ce qui concerne:

1° Le champ de broches, qui est à 200 points (un bloc supplémentaire de 100 points peut être ajouté dans certains cas particuliers);

2° Le chariot porte-balais, qui porte un interrupteur d'impulsions inverses analogue à celui de l'arbre déclencheur de balais.

COMBINEURS

Le combineur (fig. 11 et 12) qui sera employé à Paris diffère profondément de l'ancien combineur Rotary à axe vertical. Le nouveau combineur,

dit à axe horizontal, déjà en service dans plusieurs installations, se compose:

1° D'un axe à section carrée sur lequel sont calées de 8 à 24 cames (non compris la came conductrice);

2° De balais fixes, au nombre de 4 par came. Chaque came se compose d'un disque isolant sur les deux faces duquel sont fixées des plaques conductrices convenablement découpées. Les deux plaques d'une came sont reliées électriquement; deux cames voisines peuvent être reliées par une bague conductrice.

L'entraînement est également produit par un engrenage à roue entraînée flexible. La came conductrice ou came A est à bords relevés de façon à augmenter la précision de l'arrêt. Il peut exister 18 positions d'arrêt, de 20° en 20°. Ce combineur permet d'effectuer, au cours de l'engagement d'un appareil, toutes commutations possibles entre 96 fils pris par groupes de 4, 8, 12, etc. . . . Il a permis de donner une très grande souplesse aux circuits, tout en supprimant un certain nombre de relais et en augmentant les coefficients de sécurité (fig. 13 et 14).

Les Circuits

Les circuits qui seront réalisés à Paris ne diffèrent pas dans leur ensemble des circuits Rotary qui ont été décrits bien souvent au cours de ces dernières années. L'emploi du combineur type horizontal et les modifications apportées aux appareils ont permis d'augmenter sensiblement les coefficients de sécurité.

Certains circuits ont dû être adaptés aux problèmes particuliers posés par la transformation du réseau. Nous allons exposer brièvement

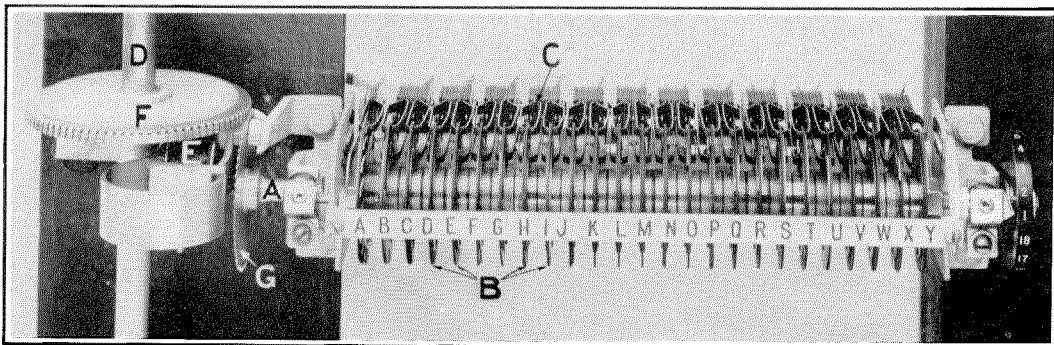

Fig. 11—Vue d'un combineur
A, Axe;—B, Cames;—C, Frotteurs fixes;—D, Arbre en rotation permanente;—E, Electro d'embrayage;—F, Roue motrice;—G, Roue entraînée flexible.

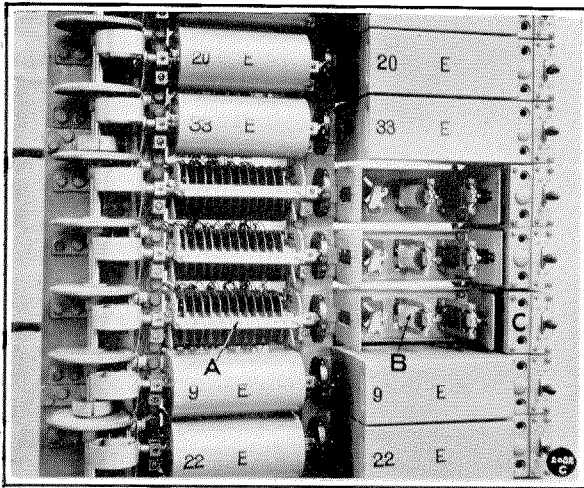

Fig. 12—Détail d'une baie de combineurs et relais
A, Combineurs;—B, Relais;—C, Clé, lampes et jacks d'essais.

le principe du circuit le plus important, celui du *traducteur*.

TRADUCTION.—Le système automatique de Paris sera, comme ceux de Londres et de New-York, caractérisé par l'emploi de la traduction. L'étude générale d'un grand réseau automatique montre qu'il est extrêmement intéressant de ne pas lier le dispositif des voies employées pour l'acheminement des communications à la façon dont l'appel est effectué, c'est-à-dire aux indicatifs des différents bureaux.

Nous avons dit plus haut qu'un appel au cadran est fait sous la forme SEG 46-62 par exemple. L'indicatif SEG reçu dans l'enregistreur doit permettre à cet organe d'aiguiller la communication, par un nombre convenable d'étages de sélection, vers le bureau demandé, Ségur en l'espèce. L'indicatif à trois lettres correspond à l'envoi de trois trains d'impulsions, donc à la commande de trois commutateurs d'enregistrement; si l'on employait pour effectuer la sélection les procédés habituels, le bureau demandé serait atteint obligatoirement par l'intermédiaire de trois sélecteurs et de trois seulement. Or, il est intéressant de pouvoir disposer à volonté du nombre des étages de sélection, ainsi que du niveau à atteindre sur chacun des sélecteurs employés.

Le *traducteur* fait partie de l'enregistreur; c'est un commutateur qui possède autant de positions d'arrêt que de directions possibles (une par bureau ou service spécial); l'indicatif étant

reçu, le traducteur démarre et vient s'arrêter dans la position correspondant à la direction demandée (fig. 15). Il contrôle alors la sélection en liaison avec les commutateurs d'inversion; son circuit est disposé de telle sorte que, suivant la direction demandée, il peut assurer une, deux, trois ou quatre sélections successives avant d'arriver au bureau destinataire: il « traduit » ainsi l'indicatif envoyé par l'abonné en un nombre de 1 à 4 chiffres.

Un répartiteur de traduction, placé entre les bancs des commutateurs enregistreurs de récep-

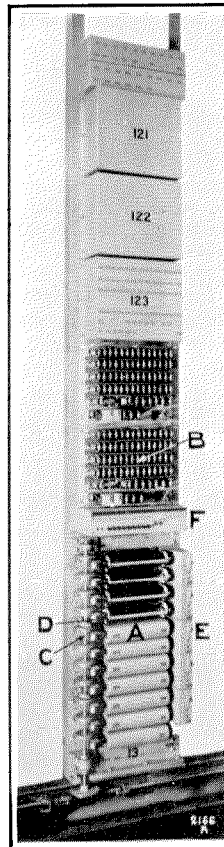

Fig. 13—Vue d'ensemble

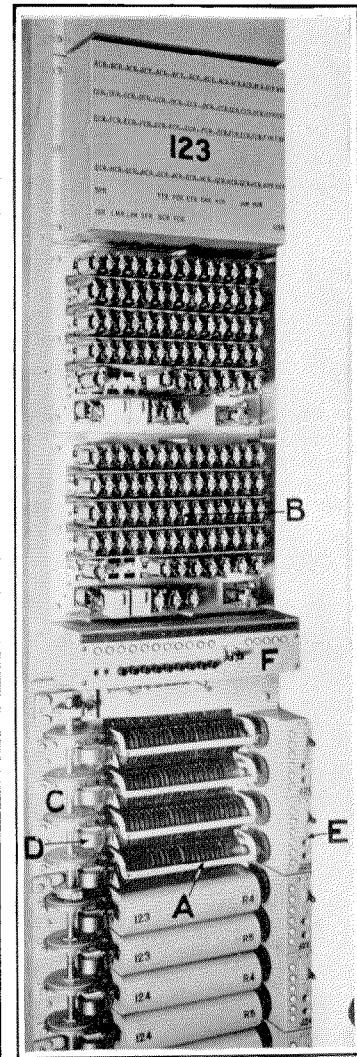

Fig. 14—Détails
Fig. 13 et 14.—Vues d'ensemble et détails d'une baie d'enregistreur à relais (type Nantes)

A, Combineurs;—B, Relais;—C, Arbre en rotation permanente;—D, Dispositif d'embrayage des combineurs;—E, Lampes de contrôle, clés, et jacks d'essais;—F, Lampes et clés de contrôle.

tion et d'inversion et le banc du traducteur, permet de changer à volonté le tracé de l'acheminement de la communication.

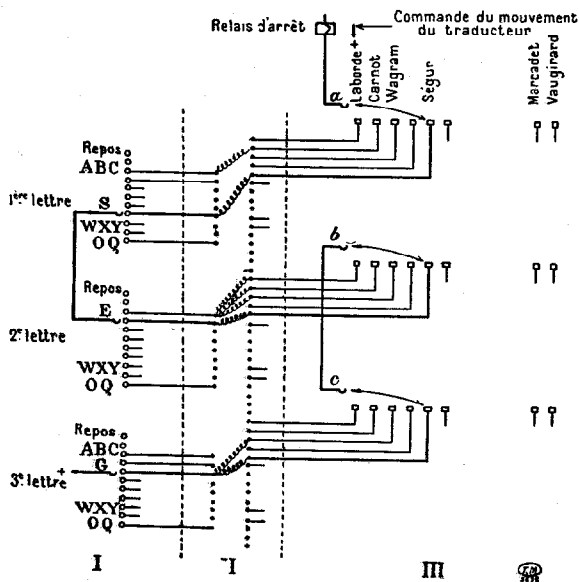

Fig. 15—Schéma du circuit du traducteur. Réception I, Organes enregistrant l'indicatif envoyé par l'abonné; —II, Répartiteur de traduction côté réception;—III, Traducteur;—a, b, c, Balais de réception du traducteur.

On a supposé l'indicatif SEG reçu et le traducteur en position de repos. Le traducteur démarre et s'arrête sur les broches correspondant à la direction Ségur. Un deuxième répartiteur relie les balais d'inversion du traducteur aux organes enregistrant les impulsions inverses. Un balai spécial détermine pour chaque direction le nombre d'étages de sélection.

La traduction donne à l'automatique une souplesse remarquable. Elle permet d'établir un tracé rationnel des lignes auxiliaires entre bureaux en assurant à celles-ci l'utilisation optimum. Elle permet, en cas d'incident sur un faisceau de lignes, de détourner très rapidement les communications en faisant des mutations dans le répartiteur de traduction. Elle permet de généraliser l'emploi extrêmement avantageux des sélecteurs tandem. Enfin, les séries d'un grand réseau manuel que l'on transforme en automatique peuvent conserver leurs appellations nominales, alors que les séries d'un grand réseau équipé sans traduction doivent être désignées à l'annuaire par des nombres; on évite ainsi un changement général de numérotation, et l'annuaire peut conserver sa forme habituelle: l'abonné Ségur 46-62 par exemple sera inscrit sous la forme SEGur 46-62.

Liaisons Automatique Vers Manuel

Lorsqu'un abonné automatique demande un abonné manuel, tout se passe pour le demandeur comme si le demandé était lui-même automatique. L'abonné ayant envoyé son appel, l'indicatif oriente le traducteur qui aiguille l'appel sur une ligne auxiliaire se rendant au bureau d'arrivée. Mais les quatre chiffres envoyés par l'abonné, au lieu de commander la mise en place de sélecteurs numériques, actionnent des commutateurs, d'ailleurs équivalant à ces sélecteurs en ce qui concerne le contrôle effectué par l'enregistreur. Ces commutateurs commandent l'allumage de

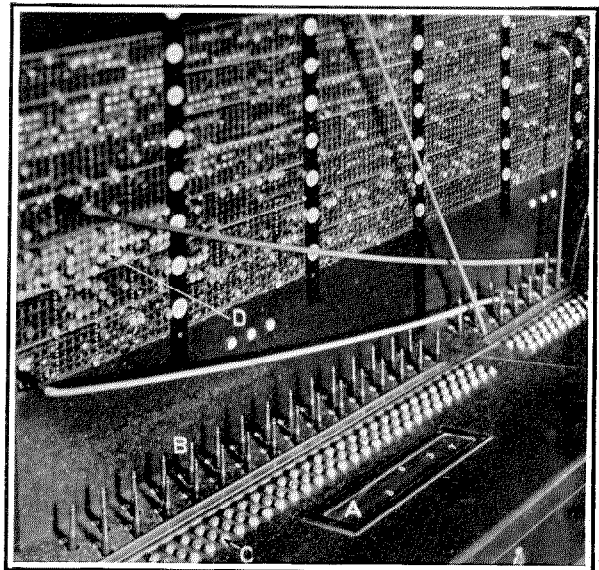

Fig. 16—Vue d'une position à indicateur d'appel sur groupe d'arrivée

A, Panneau lumineux;—B, Monocordes;—C, Lampes de contrôle (appel, occupation, fin);—D, Jacks généraux.

lampes qui font apparaître le numéro demandé en chiffres lumineux sur une position dite à *indicateur d'appels*, indiquant ainsi à l'opératrice qui dessert cette position la connexion à établir.

Ici deux solutions sont possibles:

1° INDICATEURS D'APPELS SUR GROUPES D'ARRIVÉE (FIG. 16 ET 17)

L'opératrice de la position à indicateur d'appels est une opératrice d'arrivée du bureau destinataire; elle dispose du multiplage des lignes d'abonnés. La jonction prise par l'appel aboutit devant elle sur un monocorde qui se signale appelant par l'allumage d'une lampe; l'opératrice saisit ce monocorde et, après avoir fait le test,

l'enfonce dans le jack général de l'abonné demandé.

Cette méthode est la plus logique et la moins coûteuse; mais elle n'est pas toujours applicable, car certains bureaux manuels ne se prêtent pas à l'installation de ces indicateurs d'appels.

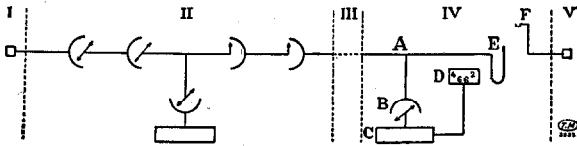

Fig. 17—Diagramme d'établissement d'une communication automatique vers manuel. Indicateur d'appel sur groupe d'arrivée

I, Abonné demandeur;—II, Bureau automatique de départ;—III, Ligne auxiliaire;—IV, Bureau manuel d'arrivée;—V, Abonné demandé.

IV.—A, Ligne axiliaire entrante;—B, Chercheur de jonction;—C, Enregistreur d'indicateur d'appels;—D, Panneau lumineux d'indicateur d'appel;—E, Monocorde;—F, Jack général de l'abonné demandé.

2° INDICATEURS D'APPELS TANDEM SANS MONOCORDES (FIG. 18)

L'opératrice de la position à indicateur d'appels est placée en *tandem* entre le bureau de départ et le bureau d'arrivée. Les jonctions ne sont que représentées devant elle par des jeux de lampes et vont aboutir sur les monocordes d'une position d'arrivée ordinaire du bureau destinataire. La jonction prise par l'appel se signale par l'allumage d'une lampe à l'opératrice tandem; celle-ci entre en relation par ligne d'ordres avec

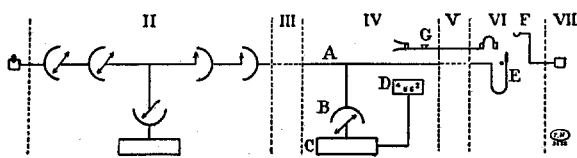

Fig. 18—Diagramme d'établissement d'une communication automatique vers manuel. Indicateur d'appels tandem sans monocorde

I, Abonné demandeur;—II, Bureau automatique de départ;—III, Ligne auxiliaire;—IV, Bureau tandem;—V, Ligne auxiliaire;—VI, Bureau d'arrivée;—VII, Abonné demandé.

IV.—A, Ligne axiliaire en transit;—B, Chercheur de jonctions;—C, Enregistreur d'indicateur d'appels;—D, Panneau lumineux d'indicateur d'appels.

VI.—E, Monocorde d'arrivée;—F, Jack général de l'abonné demandé.

IV, V et VI.—G, Ligne d'ordres.

l'opératrice d'arrivée et lui indique le numéro de l'abonné demandé et la jonction appelante; l'opératrice d'arrivée saisit le monocorde corre-

spondant et l'enfonce dans le jack général de l'abonné demandé.

Les positions à indicateurs d'appels tandem peuvent être placées en un point quelconque du parcours entre le bureau de départ et le bureau d'arrivée. Il peut être avantageux de les placer, soit dans le bureau automatique de départ, soit dans un bureau intermédiaire, soit dans le bureau manuel d'arrivée.

Liaisons Manuel Vers Automatique

Lorsqu'un abonné manuel demande un abonné automatique, tout se passe pour l'abonné demandeur comme si le demandé était lui-même manuel. L'abonné énonce verbalement à l'opératrice de départ le numéro qu'il demande.

Ici encore, deux solutions sont possibles.

1° SÉLECTION DIRECTE (FIG. 19)

L'opératrice de départ, au lieu de se mettre en relation avec une opératrice d'arrivée par ligne d'ordres, enfonce la fiche d'appel du dicorde dans un *jack individuel* correspondant à la direction demandée; cette manœuvre a pour effet de connecter le jack individuel avec un

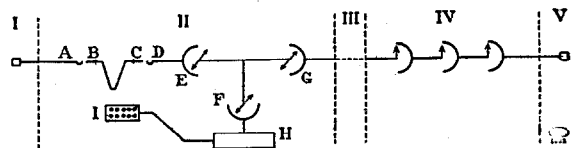

Fig. 19—Diagramme d'établissement d'une communication manuel vers automatique. Sélection directe
I, Abonné demandeur;—II, Bureau manuel de départ;—III, Ligne auxiliaire;—IV, Bureau automatique d'arrivée;—V, Abonné demandé.

II.—A, Jack local de l'abonné demandeur;—B, Fiche de réponse;—C, Fiche d'appel;—D, Jack individuel de sélection directe;—E, Chercheur de jack;—F, Chercheur d'enregistreur;—G, Chercheur de jonction;—H, Enregistreur de sélection directe;—I, Clavier de sélection directe.

enregistreur; l'opératrice « tape » alors, sur un clavier de 10 boutons numérotés de 0 à 9, les quatre chiffres du numéro demandé; ces chiffres sont reçus dans l'enregistreur; en même temps, le jack, et avec lui l'enregistreur, se relie à une ligne auxiliaire aboutissant sur un sélecteur du bureau automatique d'arrivée; l'enregistreur contrôle la sélection numérique; lorsque la ligne de l'abonné demandé est atteinte par le sélecteur final, l'abonné demandeur perçoit le retour d'appel ou le signal d'occupation. L'opératrice de

départ possède la supervision comme dans le cas d'une communication manuelle.

2° POSITIONS SEMI-B (FIG. 20)

L'opératrice de départ traite les communications destinées aux bureaux automatiques comme celles destinées aux bureaux manuels; mais elle se trouve en relation, sur la ligne d'ordre, non avec une opératrice d'arrivée d'un bureau manuel, mais avec une opératrice dite *semi-B* placée en tandem entre le bureau de départ et le bureau d'arrivée; celle-ci possède un clavier sur lequel elle « tape » le numéro demandé; ce numéro est reçu dans un enregistreur qui se comporte dès lors comme un enregistreur de sélection directe; les jonctions sont représentées devant l'opératrice semi-B par des jeux de lampes indiquant l'occupation ou la disponibilité, ce qui lui permet de désigner à l'opératrice de départ le numéro de la ligne auxiliaire à employer.

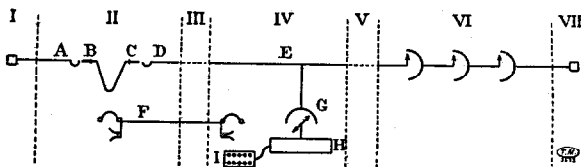

Fig. 20—Diagramme d'établissement d'une communication manuel vers automatique (position semi-B)

I, Abonné demandeur;—II, Bureau manuel de départ;—III, Ligne auxiliaire;—IV, Bureau tandem;—V, Ligne auxiliaire;—VI, Bureau automatique d'arrivée;—VII, Abonné demandé.

II.—A, Jack local de l'abonné demandeur;—B, Fiche de réponse;—C, Fiche d'appel;—D, Jack de ligne auxiliaire;—E, Ligne auxiliaire en transit;—F, Ligne d'ordres;—G, Chercheur de jonction;—H, Enregistreur semi-B;—I, Clavier semi-B.

Les positions semi-B peuvent être placées en un point quelconque du parcours entre le bureau de départ et le bureau d'arrivée. Il peut être avantageux de les placer, soit dans le bureau manuel de départ, soit dans un bureau intermédiaire, soit dans le bureau automatique d'arrivée.

Liaisons Avec les Réseaux Limitrophes

Les liaisons des bureaux automatiques de Paris avec les bureaux manuels de banlieue seront assurées dans les deux sens par des installations analogues aux précédentes.

Toutefois, on ne peut relier tous les bureaux de Paris à tous les bureaux de banlieue par des

lignes directes; on emploie par suite des positions tandem à indicateurs d'appels ou semi-B qui, non seulement transforment un appel automatique en appel manuel ou inversement, mais encore aiguillent les communications vers les différentes directions possibles. Ces positions tandem sont donc pourvues de monocordes.

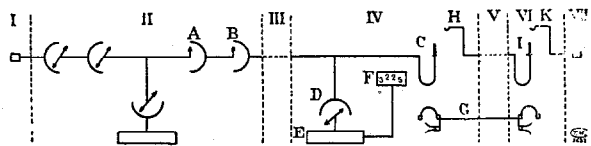

Fig. 21—Diagramme d'établissement d'une communication automatique vers banlieue. Indicateur d'appels tandem avec monocorde

I, Abonné demandeur;—II, Bureau automatique de départ;—III, Ligne auxiliaire;—IV, Centre de transit;—V, Circuit Paris vers banlieue;—VI, Bureau manuel de banlieue;—VII, Abonné demandé.

II.—A, Sélecteur primaire;—B, Sélecteur secondaire de banlieue.

IV.—C, Monocorde de position tandem;—D, Chercheur de jonction;—E, Enregistreur d'indicateur d'appels;—F, Panneau lumineux d'indicateur d'appels;—G, Ligne d'ordre;—H, Jack de circuit.

VI.—I, Monocorde de groupe d'arrivée;—K, Jack général de l'abonné demandé.

1° Dans le sens bureau automatique de Paris vers bureau manuel de banlieue (voir fig. 21), on emploie des *positions tandem à indicateurs d'appels avec monocordes*. Les lignes venant des bureaux automatiques arrivent sur des monocordes, et l'opératrice tandem aiguille la communication vers l'un quelconque des bureaux de banlieue qu'elle dessert en enfonçant le monocorde dans le jack de la ligne auxiliaire qui lui est désignée par l'opératrice d'arrivée.

2° Dans le sens bureau manuel de banlieue vers bureau automatique de Paris (voir fig. 22),

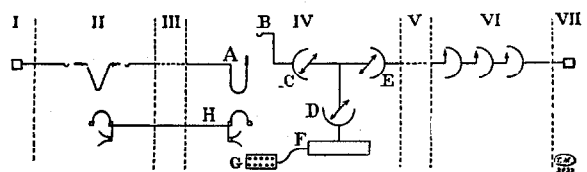

Fig. 22—Diagramme d'établissement d'une communication banlieue vers automatique. Position tandem à sélection directe

I, Abonné demandeur;—II, Bureau manuel de banlieue;—III, Circuit banlieue vers Paris;—IV, Centre de transit;—V, Ligne auxiliaire;—VI, Bureau automatique d'arrivée;—VII, Abonné demandé.

IV.—A, Monocorde de position tandem;—B, Jack individuel de sélection directe;—C, Chercheur de jack;—D, Chercheur d'enregistreur;—E, Chercheur de jonction;—F, Enregistreur;—G, Clavier de sélection directe;—H, Ligne d'ordres.

on emploie des *positions tandem à sélection directe*. Les jonctions venant des bureaux manuels aboutissent sur des monocordes et l'opératrice tandem, à laquelle l'opératrice de départ indique le bureau et le numéro de l'abonné demandé, dispose de jacks de sélection directe pour assurer l'aiguillage des communications vers l'un quelconque des bureaux automatiques de Paris.

L'étude générale des liaisons entre Paris et sa banlieue conduit à concentrer ces positions—tandem à indicateurs d'appels avec monocordes et tandem à sélection directe—dans des *centres de transit*, au nombre de quatre. A chaque centre de transit correspond un secteur de banlieue (nord-ouest, nord-est, sud-ouest et sud-est), le centre de transit nord-ouest, par exemple, desservant toutes les communications échangées dans les deux sens entre tous les abonnés automatiques de Paris et tous les abonnés de la banlieue nord-ouest.

Les centres de transit pourront dans la suite devenir automatiques au fur et à mesure de la mise en automatique des réseaux de banlieue. Les positions tandem seront remplacées par des sélecteurs tandem qui aiguilleront les communications Paris-automatique vers Banlieue-automatique et vice versa par voie complètement automatique.

Avantages de l'Automatique

La technique automatique, avons-nous dit, se généralise rapidement, non seulement en France, mais dans le monde entier. C'est là le signe d'avantages incontestables par rapport à la téléphonie manuelle. Nous allons énumérer ci-dessous les principaux, en remarquant que, s'ils ne peuvent évidemment jouer pleinement qu'en réseau complètement automatique, ils se manifesteront progressivement à mesure de la transformation.

RAPIDITÉ ET SÛRETÉ

La communication est établie en moins de quinze secondes, ceci à n'importe quelle heure

du jour ou de la nuit, aussi bien au moment des pointes—le nombre des organes étant calculé pour écouler à une probabilité extrêmement dure le trafic maximum—qu'aux heures creuses, les organes étant évidemment toujours à la disposition des abonnés.

Les risques d'erreurs sont réduits au minimum, et ne peuvent plus provenir que d'une inattention de l'abonné.

Les fausses manœuvres (connexions en double, tests erronés, etc.) sont rigoureusement impossibles, par suite de verrouillages électriques effectués par les circuits.

Les coupures intempestives sont complètement éliminées; la communication toute entière une fois établie est placée sous le seul contrôle des abonnés; elle est coupée par eux-mêmes lorsqu'ils raccrochent leurs appareils.

L'appel au cadran est une opération extrêmement simple, qui évite les pertes de temps.

La rupture est immédiate: dès que le demandeur a raccroché, tous les organes sont libérés, et il peut demander immédiatement une nouvelle communication (il suffit pratiquement d'abaisser à fond le crochet commutateur pendant une seconde au plus).

FACILITÉS D'EXPLOITATION ET D'ENTRETIEN

L'automatique permet de résoudre aisément un grand nombre de problèmes que la téléphonie manuelle n'aborde que difficilement. L'organisation générale d'un réseau peut, en automatique, être conçue de façon à utiliser au maximum tous les organes et toutes les lignes.

Par la mise en œuvre de circuits d'essais systématiques, l'état des installations est connu à chaque instant, des essais préventifs complets permettent de réduire au minimum le nombre des dérangements et d'assurer un service tout à fait remarquable.

Enfin, si le prix de revient d'une installation est plus élevé en automatique qu'en manuel, les frais de personnel sont considérablement diminués, de sorte que l'exploitation automatique est sensiblement moins onéreuse que l'exploitation manuelle.



Ernest Penny

In Memoriam Ernest Penny

It is with deep regret that we have to record the death, on October 26th, in Madrid, of Mr. George Ernest Reginald Penny, Chief Engineer of the Standard Electrica S.A.

Mr. Penny joined the Engineering Department of the London House in 1904. He was given charge of the Apparatus Division in 1911 and appointed Assistant Chief Engineer in 1919. Three years later he was transferred to the European Engineering Department and was thus one of its early members. During the War he was prominently associated with the activities of the London House in the solution of vital problems concerning the development of new types of war material, particularly in the invention, development and manufacture of hydrophone equipment.

On several occasions, during his career, he was called upon to make foreign journeys. In 1918 he visited America to demonstrate hydrophone equipments to the American Naval Authorities. During 1920 he spent many months in the Straits Settlements and in India, studying means for the protection of telephone apparatus against deterioration. In 1923 he again visited America, this time for the study of machine switching systems. The years 1924-1926 were spent chiefly with the Australian House in Sydney, where he gave general assistance in telephone engineering matters.

His early association with the Company, his wide and varied experience, as well as his high personal and professional abilities fitted him for a prominent position, and insured his success in all the varied phases of his career. His many friends within and without the Company remember him as a man of the highest integrity, with broad views and simple tastes. He was a strict disciplinarian but he exercised his discipline firstly upon himself, seeking the result as regards others in the effects of his own example, and he established for himself a standard of efficiency that often imposed on him a burden beyond the powers and conscientiousness of most men. He possessed an essentially honest mind; he was not concerned to find the answer to a problem along any line of predisposition, but he tackled the matter with the sole desire to find truth and a real solution. Possessed of a mind clear and precise, and a power of expression easy and effective, his judgment upon controversial questions always demanded respect, while his cheerful energy and good temper made him singularly successful in composing differences of opinion. His administrative experience had taught him to seek solutions of problems by reasoning from general principles. Nevertheless, when necessity arose, he would face the details—often complex and difficult—with dogged perseverance, until he arrived at a practical result. On his foreign travels he had frequently to face tasks of this character single-handed.

From his earliest years he was a lover of outdoor sport. His hobby was photography and he brought back from his foreign journeys many good examples of his triumphs in that direction. His friends will remember that he was a good musician and a skillful player of the piano and organ. Those who knew him best were aware that his principal home study was the Bible, and that it to him was something real that inspired him in his daily work.

He married early in 1914 Miss Ethel Setterfield of Eastbourne, England, who went with him on his travels, and who supported him alike in his sports, his music and his work, both at home and abroad.

Early in last October, when in Madrid, he was troubled with gastric disorder which rapidly developed into an obscure fever suspected to be typhoid. Double pneumonia supervened and although everything was done to afford relief, the end came suddenly. His death at the age of only forty-one years renders the loss particularly sad. It will be deplored by his innumerable friends, both within and without the circle of his professional activities, particularly those of the International Telephone and Telegraph System.

The International Conference on High Tension Systems

By G. H. NASH

Chief Engineer, Standard Telephones and Cables, Ltd.

BEFORE the Great War there were few international organisations dealing with engineering problems. Each country had its own technical institutions at which papers were read and problems were discussed, but there was little direct exchange of views between engineers of different countries. There was, of course, the International Electrotechnical Commission, usually referred to as the "I.E.C.," founded in 1906, but this existed for standardisation in matters where practice had become stabilised rather than for discussion of current problems.

Since the War, there has been an increasing sense of the value of discussion of common technical problems from the international standpoint. This has resulted in the holding of a series of international conferences, particularly in connection with problems of power generation and transmission, so that at present there is some risk of undue multiplication of conferences with consequent overlapping of agenda. One of the earliest and most successful of these is the International Conference on High Tension Systems.

At the end of January, 1921, as a result of a conversation between M. Bauer, Director of the Swiss Society for the Transmission and Distribution of Electricity, and M. Aubry, Chief Engineer of the Compagnie Générale d'Électricité in Paris, M. Tribot Laspière, Secretary of the Union des Syndicats de l'Électricité, had the idea of organising a conference which would bring together the engineers of the principal countries concerned with the development and distribution of electrical energy. His project was approved, and the Union thereupon suggested to foreign engineering associations interested in this work that a Conference should be held in Paris. The proposal was welcomed, and the first Conference was held in November, 1921.

The object was to allow of the joint study of all technical problems relating to the construction and operation of large high tension systems. It was definitely understood that only technical

problems would be dealt with. Problems affecting legislation, or the import or export of power would not be considered, as these had political aspects with which a private assembly was not able to deal. To maintain this private character it was agreed also that the Conference should not include government representatives, and that if engineers in the service of any government took part in the Conference they would do so in their personal capacity and not as official delegates.

In order that work undertaken by the Conference might not overlap in any way that of the I.E.C., the proposition was discussed with M. Mailloux and M. Le Maistre, then respectively, President and Secretary of the I.E.C. It was agreed that there need be no interference between the objects of the two Conferences. The I.E.C. existed mainly for international standardisation; the object of the new Conference was to effect an exchange of ideas on methods of construction and operation not yet ripe for standardisation. The discussions would, therefore, be confined to a single field and would cover practical and industrial matters as well as those which were mainly scientific. The Conference might, however, make recommendations to the I.E.C. on certain subjects on which general agreement had been reached. With this understanding the I.E.C. not only did not oppose the new Conference, but helped considerably in launching it. The President, Dr. Mailloux, in particular, did a considerable amount of work in order to make it a success.

Professional associations of different countries were invited to form National Committees which might nominate official delegates to the Conference. At the same time other representatives both from operating and manufacturing interests in those countries were invited to take part as free members. As Standard Telephones and Cables, Ltd., was interested in power transmission by high-tension cable, as well as in communication between stations and in remote control of switch-gear, Mr. T. N. Riley, Chief Cable Engineer, attended the Conferences.

First Conference

At the first Conference, held in November, 1921, twelve countries participated, represented by forty-seven official delegates; in addition, a number of free members attended. The official language used in the discussions was either French or English and interpreters were present to translate remarks made during the discussion. At the first Conference about sixty-four papers were read covering:

1. Description of existing or projected high tension systems
2. Operation of central stations
3. Construction of lines
4. Sub-stations
5. Technical operation and protection
6. Communication between stations

At the end of the Conference a resolution was passed expressing the opinion that the reports and discussions had served a very useful purpose and that further Conferences should be held from time to time.

Second Conference

The second Conference took place at the end of November, 1923. Twenty countries were represented by eighty-five official delegates, the total number of visitors from abroad being one hundred and forty-three as against fifty-three on the first occasion. The number of papers read was reduced to forty-nine, as the first Conference had been somewhat overloaded and discussion handicapped. The general programme was similar to that of 1921 except that certain subjects had been noted for special study. These were:

- Construction of very high tension lines
- Construction and operation of open air sub-stations
- Choice of transmitting pressures
- High tension cables
- International regulations for high voltage lines
- Education of the public concerning the risks of high voltage lines

In order to cover the ground thoroughly, one delegate was appointed "rapporteur" in connection with each of these subjects and was charged with the duty of collecting information

on the practice of each country and arranging for its presentation to the Conference by separate papers or in a combined report.

Visits to installations were arranged in connection with the Conference.

Third Conference

The third Conference was held in June, 1925, the scope being slightly widened in order to include the generation of electricity. Twenty-seven countries were represented, the total number of representatives from abroad numbering two hundred and twenty-six. Ninety-nine papers were presented in three main groups:

1. Generation
2. Construction and installation of lines
3. Operation of systems

At this Conference as in the two previous ones, discussion was considerably handicapped by the fact that a number of papers were sent in too late to be presented at the meeting, and it was agreed that, at future conferences, arrangements should be made to have papers ready in time. Steps were taken to establish an agreed international model for statistics of production, transmission and distribution, so that economic results in different countries might be more easily compared. Recommendations were also made to the I.E.C. to press forward the establishment of an international agreement on the methods of testing oils and electrical machinery.

Fourth Conference

The fourth Conference was held at the end of June, 1927. Twenty-eight countries were represented, Germany having been added since her admission to the League of Nations. Seventy-five papers were presented, divided into the same three groups as in 1925.

Figure 1 shows a view from the platform of one of the meetings. Amongst the delegates will be noted Dr. A. E. Kennelly near the lantern, Dr. J. B. Whitehead at the door, Messrs. Sonnenfeld and Konstantinovaky, who are associated with the Kabelfabrik A. G. Bratislava on the right of the third row. Figure 2 shows a view of the platform during a discussion on insulating oils.

The subject of high-tension cables is steadily increasing in importance and on this occasion no fewer than nine of the papers presented dealt therewith, the discussion overlapping into the following session of the Conference. Broadly speaking, these papers fell into three groups dealing with, (a) the influence of occluded air and moisture, (b) the best physical structure, and (c) the method of testing which will give a satisfactory indication of reliability in service. A considerable amount of research work on these points has been carried out during the last two years at the high-tension research laboratory of Standard Telephones and Cables, Ltd., at Woolwich.

In the course of the discussion, Mr. Riley pointed out that most of the deterioration tests put forward were chemical, and that the research work carried out by Standard Telephones and Cables, Ltd., in connection with oils for cable insulation had shown that a much more sensitive measure of deterioration could be obtained by electrical measurements of the change of power-

factor of the oil. The discussion also elicited that, in the past, oil refining had been directed rather to producing a lubricant than to perfecting a dielectric.

In general, the data put forward by other experimenters confirmed the results already obtained at Woolwich, London.

The importance of adequate drying and impregnation in a modern high-voltage cable is now recognised, but the detailed methods of securing these results and the material structure favouring them, is not so well appreciated.

It is generally agreed that the type of three-core cable having an equipotential sheath round each core is likely to give the best results in operation. On the method of testing there is not equal agreement. It is recognised that cables may pass the routine excess pressure test and yet fail in service after weeks or even months, and engineers are at present divided into two schools of thought. On the one hand, it is considered that a test of the power factor-voltage characteristic before and after heating on load, affords the



Figure 1—At the Fourth Conference—View from the Platform

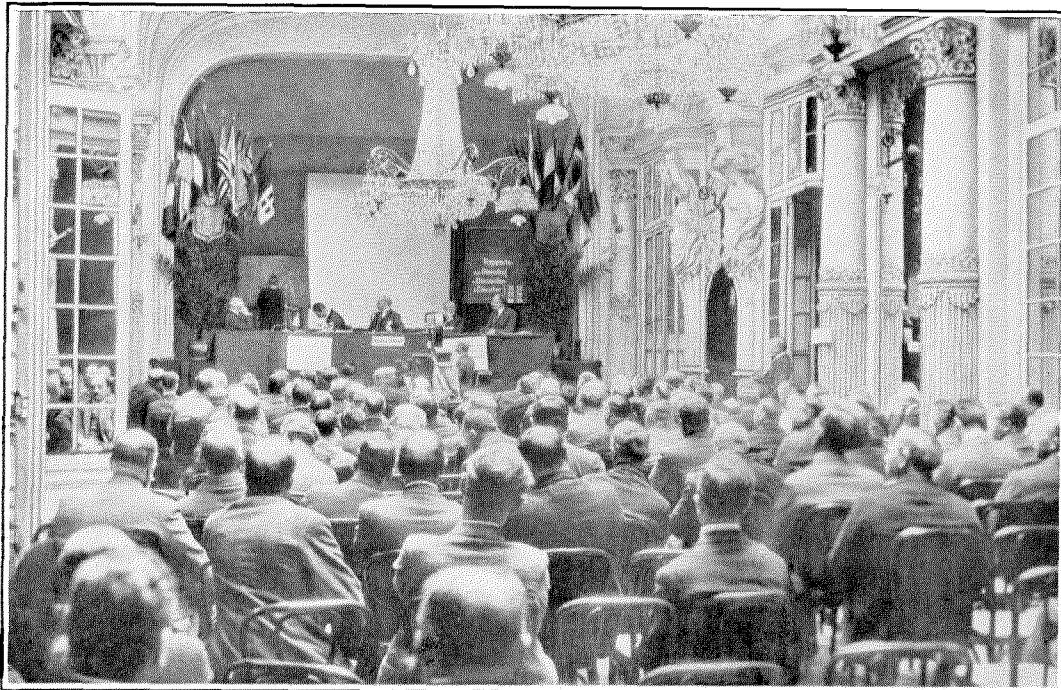

Figure 2—A Meeting of the Fourth Conference

best indication of whether the cable will be stable in service. On the other, it is maintained that the time for which a cable will withstand a given pressure has a definite relation to the pressure, and it is possible to determine by an extra high pressure short period test what lower pressure the cable will withstand indefinitely. A committee was formed to formulate proposals for acquiring further evidence on this point.

As the length of transmission lines increases, communication between stations by telephone cable in the neighbourhood of the high tension lines becomes more costly and less satisfactory in operation, and there is an increasing tendency towards the use of carrier current communication making use of the power lines themselves. A number of the papers which were read described the various systems which have been tried. In the discussion, attention was directed to the extreme difficulty in such systems of eliminating parasitic noises arising either from the power lines themselves or from external static discharges.

Such noises not only disturb speech but might lead to false calls if the disturbance happened to

be of the same nature as that to which apparatus is designed to respond. In many systems installed at the present day, telephone communication is only satisfactory because the operators know more or less the nature of the communication to be received.

During the conference, visits were arranged to high-voltage plants of interest in the neighbourhood of Paris, in particular to the generating station of Gennefilliers from which power is transmitted by 60,000 volt underground cable, and to the 1,000,000 volt laboratory of the Porcelain Factory at Ivry.

These conferences are incomplete without the social functions which afford members a better opportunity of getting into personal touch with their confreres in other countries than is possible in the more rigid circumstances of controlled discussion. The organisation of these gatherings by our French hosts left nothing to be desired and, although the weather was adverse for the greater part of the week, during the one open air function—a garden party held at the fine old residence given by the Rothschild family to the French nation—the sun shone brilliantly.

The Calculagraph

By H. C. DILSIZIAN

Export Department, International Standard Electric Corporation

THE Calculagraph as designed for telephone service was developed to provide an accurate means of computing the duration of long distance conversations. Its true value to the telephone world can be appreciated best by a brief survey of its predecessors.

Before the advent of the Calculagraph, it was the practice in many exchanges to record the start and finish of toll calls by glancing at a wall clock and writing down the time in longhand on tickets provided for the purpose. These tickets were taken to clerks who computed the elapsed time by subtracting one record from the other. A check for accuracy of computation was made by a second group of clerks. Careful tests showed that, because of the human element involved in this practice, approximately 20 percent of the records contained inaccuracies of one minute or more. In practically every instance these errors were in favor of the subscriber.

The use of time stamps for recording the start and finish of conversations was a decided step forward. While the human element was thereby partially eliminated, the actual computation of elapsed time was performed by clerks and the precautions taken could not prevent errors.

Another instrument used was the stop watch, which indicated the exact duration of a call by pressing a button at the start and finish of a conversation. The stop watch, however, presented several serious disadvantages. With it the operator could handle only one call at a time and the actual record had to be made in longhand, which involved loss of time for the operator, and impaired the general efficiency of the service.

The problem, therefore, was to overcome the weak points of these methods and devise a machine which would embody their respective advantages. It was required in effect that the desirable features of time stamps, namely, the accurate recording of the start and finish of a conversation, be combined with the accuracy of the stop watch in indicating elapsed time;

that provision be made for recording this elapsed time; and, finally, that the machine desired should be capable of handling, practically simultaneously, not only one, but an unlimited number of calls. The solution to the problem was the Calculagraph.

Within a comparatively brief period telephone companies in the United States and other countries realized the value of the Calculagraph, and today, with a few rare exceptions, it is used in connection with all long distance calls in the United States and Canada.

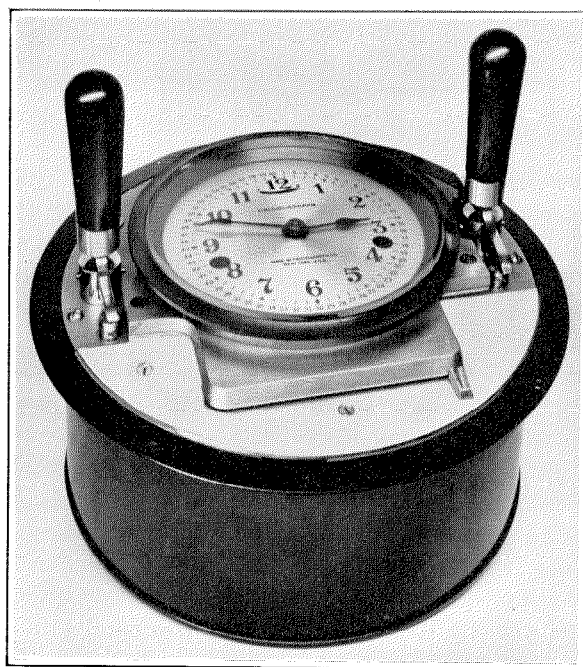

Figure 1—The Calculagraph.

The Calculagraph (Figure 1), which is manufactured exclusively by the Calculagraph Company of Harrison, New Jersey, is either a spring driven or an electrically actuated time recorder, which prints the date and time of the day similar to other time stamps, but it also has the exclusive feature of automatically computing and printing the length of time elapsed between the start and finish of an operation. Its special

construction enables it to record accurately the duration of an unlimited number of toll calls without regard to the consecutive order of starting. In practice a Calculagraph usually is placed between two operators (Figure 2) who

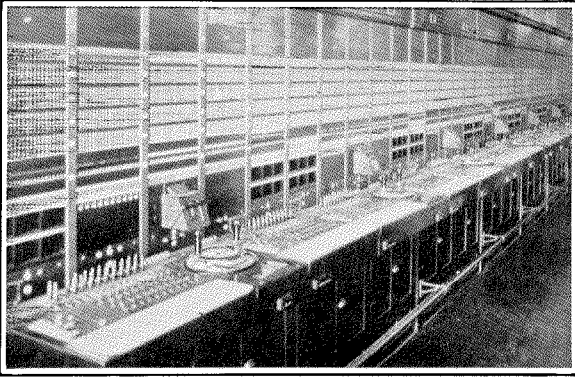

Figure 2—Switchboard with Calculagraphs Placed between Operators' Positions.

employ it on all toll calls handled by them for recording the start and the finish of conversations.

At the commencement of a conversation the operator inserts a ticket in the slot of the Calculagraph and moves the right hand lever backward and then forward, as illustrated in Figure 3. The backward movement prints the hour of the day in the form of a clock dial, and

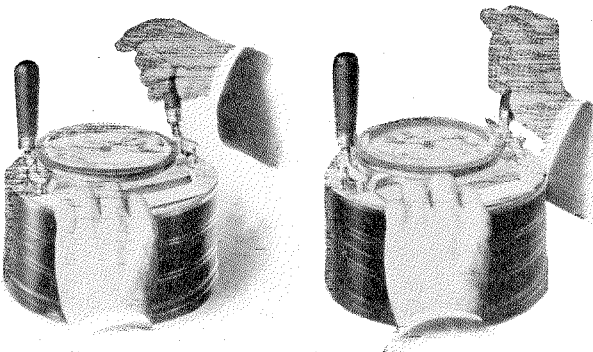

Figure 3—Recording the Start of a Call.

immediately below, if desired, the year, month and day. The triangular pointer shown just above "X" in Figure 4 corresponds to the hour hand of the clock; the arrow within the circle, to the minute hand. Thus the record reproduced in the figure indicates that the call was connected on May 5, 1927, at 10:10 A.M. Incidentally, it may be of interest to note that

it is necessary to set the date stamp each day; the A.M. and P.M. designations are controlled automatically by the Calculagraph mechanism.

The forward motion of the right hand lever prints the two elapsed time dials, together with the serial number of the machine. After this operation the ticket is withdrawn from the slot, the record at this stage appearing as in Figure 4, and the Calculagraph is ready for stamping tickets for other messages in a similar manner.

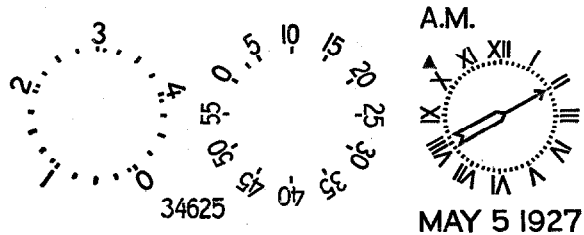

Figure 4—Record of the Start of a Call.

When a call is completed, the ticket covering it is again inserted in the slot of the Calculagraph and the left hand lever is pulled forward. This operation stamps the pointers in the two elapsed time dials imprinted at the start of the call, thereby indicating the elapsed time in minutes and fractions. The completed record appears as illustrated in Figure 5, which shows that the call lasted four minutes.

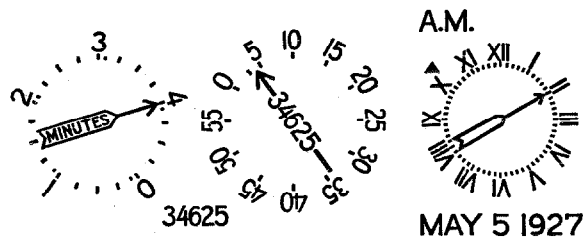

Figure 5—Record of a Completed Call.

To insure the record being started and completed on the same instrument, one of the elapsed time pointers bears the serial number of the machine corresponding to that stamped by the forward motion of the right hand lever at the beginning of the call.

The Calculagraph, in addition to being silent in operation, is of the highest quality, entirely hand assembled, and is given a series of rigid inspections during the course of manufacture. Contrary to what might be expected, the mechanism is extremely simple and rugged.

Each of the two printing dials which record the elapsed time is made of two parts, one part carrying the circle of figures and division marks and the other, the pointer or arrow. The two parts are secured together rotatively by a dowel pin, whereby the arrow always points to the zero mark of the circle. The vertical movement of the parts is independent of each other.

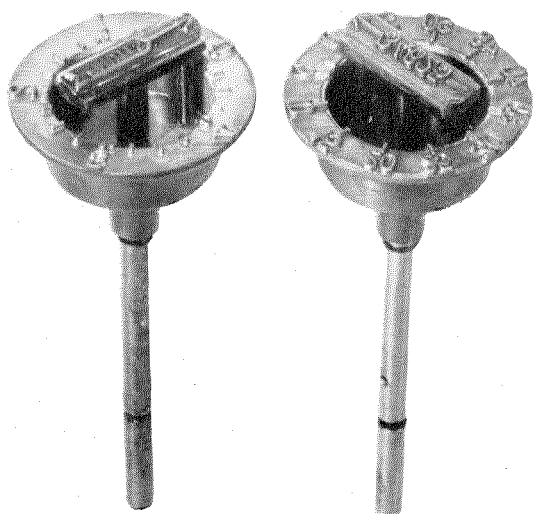

Figure 6—Illustration of Movement of Arrows When Recording the End of a Conversation.

It was mentioned previously that the forward motion of the right hand lever stamps the two elapsed time dials. That operation forces the figures upward and causes them to make an impression on the record, while the arrows, which always point to the zero mark in the circles, remain depressed. When the left hand lever is operated at the end of the conversation, the arrows alone move up, while the figures remain in their original position as indicated in Figure 6.

During the interval between the beginning and the end of a call, the dials containing the circle of Arabic numbers and their associated pointers revolve in unison; and the record card always is inserted into the Calculagraph in the same position. Since the circles are stamped at the beginning of the call and the pointers at the end, the positions of the arrows within the circles indicate the elapsed time or duration of the call. By means of the smaller of the two elapsed time dials the duration of the call may be read accurately without difficulty.

Irrespective of the position of the zero mark when imprinting the larger elapsed time dial at the start of a conversation, it will have travelled 60° at the end of a 10-minute call. If the arrow which travels along with the zero mark is stamped at the conclusion of the call, it will point to "10" on the imprint. In the meantime, if a second call is started immediately after recording the beginning of the previous call and, for example, continues for $6\frac{1}{4}$ minutes, the zero mark and its associated arrow in the larger circle will have travelled $37\frac{1}{2}^\circ$ from the point of origin of the second conversation. The impress of the arrow (Figure 5) made at the conclusion of the call will point a little to the right of "5." At this time the arrow in the smaller dial will have described an arc of 450° , or one complete revolution plus 90° , and will point to $1\frac{1}{4}$. The "5" of the larger dial plus the $1\frac{1}{4}$ of the smaller will indicate the exact duration of the call.

It will be noted that the recording of the second call has no bearing whatever on the first. With the Calculagraph any number of calls may be handled and be recorded accurately without regard to sequence.

Loading Coil Cores and Their Magnetic Stability

By FUMIO SHIDA

Engineer, Sumitomo Electric Wire and Cable Works, Ltd.

Being a lecture on the Historical Survey of the Core of Loading Coils and on the Magnetic Stability of the Powdered Iron Core given at the Annual Grand Meeting of the Japanese Institute of Telephone and Telegraph Engineers in September, 1926.

The text has been rendered into English and the whole is given here though not without some apprehension on the part of the author as to its being too verbose for some specialists.

SINCE the publication of Pupin's loading theory on telephone circuits, the efforts made by American engineers in regard to the construction of the core of loading coils is, indeed, beyond our speculation. The writer wishes to review briefly, its historical developments in design and construction and also wishes to give his interpretations of some of the phenomena in and concerning the compressed powdered iron core of loading coils.

The properties which a good loading coil should have and requirements which are very desirable from the standpoint of construction may be itemized as follows:

(1) A number of coils may be used at a given point simultaneously without mutual interference. The coils, therefore, must not have stray magnetic fields.

(2) Electrical loss due to the loading of these coils should be relatively small.

(3) Inductance of the coil should be independent of current. Hence, it should be magnetically stable.

It seems as though the ring form of winding is the only commercial form to conform with the first requirement satisfactorily. In fact, this method remains unchanged although in other respects the coils have undergone various changes and improvements. Figure 3 shows a portion of a coil with the ring form of winding.

To meet the second requirement, it is necessary to make the resistance of the winding of the coil, which is wound to have a certain inductance, very small. In order to minimize the resistance, the coil should have relatively small volume. In order that the coil may be small, a high permeability iron instead of an air or a wood core must be used. When an iron core is used, hysteresis and eddy current losses must be minimized. The use of a fine iron wire for core

construction for this purpose is one of the very good methods. In fact, this type of cores has been extensively used until several years ago. In these coils, the size of a wire which is said to have given the best result was as fine as four mils in diameter.

Satisfying the third requirement with the use of an iron core, presents a most difficult task and therefore the greatest effort was made in order to obtain this desirable property. At first, research had been extended to find the iron having the property of magnetic stability against variable magnetic force. The result of the research indicated that hard drawn wire is better in this respect, than soft wire. Therefore in practice, 4-mil wire which has 95 or 60 permeability through hard drawing was concluded to be the best for the core of loading coils and the loading coils with such cores were extensively used for several years.

But since the requirements imposed on telephone circuits became more severe and complicated by superposing the telegraphic current, by constituting phantom circuits or by the additional use of repeaters, the stability of the magnetic property of the core formed with iron wire of this kind was still found not satisfactory.

It seems quite proper to extend the explanation a little further in this regard to make it clear. A hard drawn iron wire core has relatively stable permeability. Yet the state of instability often arises when the core is subjected to a great variation of magnetizing force. When a strong electric current once flows through the loading coil which has the iron core of the described nature, thus subjecting the core, even temporarily, to a strong magnetizing force (this very often occurs in practice, through the superposition of the telegraphic current or through the current used in testing or by lightning discharges), the core will be magnetized, leaving residual magnetism, and hence the core will be exposed to a certain magnetic field intensity. The inductance of the loading coil depends entirely upon the value of the permeability of the core; and the permeability of a core of this kind varies in accordance with the magnetic field

intensity to which the core is exposed. Thus, in the above case, the loading coil will have very different inductance from the ordinary case. In this way, a circuit loaded with this form of coil meets impedance irregularity and may show, therefore, a peculiar phenomenon of better operation without than with loading coils. In fact, the trans-continental circuits in the United States were at first loaded with such coils which subsequently were disconnected due to the difficulty just mentioned. These circuits were reloaded with a new provision of air gaps in the cores of the coils to improve the constancy of inductance.¹ This method was patented by an American and is, indeed, an interesting one. The process of providing the gaps may be described as follows:

There is a small gap between windings of the coil. A mechanically operated saw is placed diametrically over these gaps and the core is thus cut, perpendicular to the magnetic flux path, into two similar, semi-circular pieces. A certain thickness of mica is inserted in these gaps and then a brass ring, which is made to fit tightly over the coil, is carefully placed to assure the original ring form. Viewed from the magnetic standpoint, there is a noticeable difference before and after the gaps are provided. It is due to the demagnetizing action within the iron core caused by the surface distribution of magnetism on the four faces at the gaps when the core is magnetized. The result of the demagnetizing action is that it decreases on the one hand, the effective permeability of the core and, on the other hand, it increases the magnetic stability of the core.

Though by providing gaps, the superior magnetic stability of the core can be obtained, it must be admitted that it has short comings such as causing a stray magnetic field and hence, magnetic interference.

Starting from the fact that the polarization of the core brings out the demagnetizing action which in turn, operates to secure the stability of permeability of the core, we may rightly expect that a powdered iron core, when properly constructed, would render the result which is sought. It is readily seen also that this form of core is not only superior and effective in obtaining con-

¹These open wire circuits are operated at present without loading coils.

stancy in effective permeability but also it is better from the standpoint of hysteresis and eddy current losses. In order that this theoretic deduction may be realized, a large amount of energy, time and money were spent in search for a practical powdered iron core and the present compressed powdered iron core is the resultant product of these unfathomed sacrifices.

This research, however, had been begun prior to the World War but the real progress did not take place until the War. With the War, importation of diamond dies for 4-mil wire from Europe stopped. With this as an incentive and spur, research engineers in this field had gone madly (as it was said) after the powdered iron core to replace the 4-mil iron wire core.

This method of getting a constant permeability and hence, a constant inductance, is the best known method at present and all loading coils of recent manufacture are of this type. The writer wishes to outline in the following, its process of manufacture, its magnetic property and its theory.

It was in 1887 when Heaviside asserted that powdered iron, hardened with wax is effective in reducing eddy current. Since this time, many scholars followed him in the study of the powdered iron core but all failed in their attempts, due to the fact that such a core had too small permeability for the purpose under consideration. However, Mr. B. Speed, Engineer of the Western Electric Company, Inc., conceived that if a pure and finely divided iron powder could be insulated and compressed so that the specific gravity was nearly that of the solid iron, it should be possible at low flux densities to obtain permeabilities of the order required for the loading cores. After this, research and efforts for improvements were continued with renewed vigor and prospect, and needless to say that many and marked improvements were made before the Western Electric Company finally succeeded in placing its product in the market.

Let us go back, for a moment, to trace the development. At first, iron powder was obtained by reducing iron oxide in hydrogen. This iron powder was then insulated by means of a suitable film of oxide by reoxidation and a coating of shellac. In order that the particles might not harden into a mass, the powder was continually stirred with shellac solution while

being dried. The insulated powder thus obtained was then subjected in a mold, to a pressure of 100,000 pounds per square inch at the surface of the powder, shaping it into the ring form. The compression was found too small and it was later replaced with 200,000 lbs. per square inch.

The iron powder obtained from iron oxide, however, was not entirely satisfactory due to the fact that the method was costly and although the particles were hardened to a certain extent, by compression, they were still too soft to give magnetically desirable results. Consequently, improvement along this line was then still urgent. With the suggestion, that if electrolytic

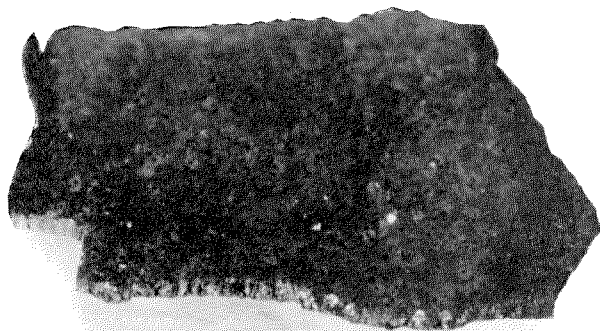

Figure 1—Photograph of a Piece of Iron Peeled off from a Cathode

iron was pulverized and was used in place of iron oxide, some of the defects might be modified, if not eliminated, research had been carried out with zeal and constancy. The method, which is employed today, was finally found as the result of the efforts made in this research.

As for the insulation, all methods of oxidation and shellacking had been carefully attended to and experimented with, but the result was not satisfactory. Mr. J. C. Woodruff found that by mixing the iron powder with flaked zinc, before applying shellac, and rolling the mixture in a drum for a few hours and then removing the zinc by sieving, a very thin and tough insulation of the grains of iron could be obtained. Insulation thus obtained rendered a very satisfactory result, incurring no breakdown after the cores were compressed. This method is the best, the

simplest and the most economical one at the present time.

The method of getting electrolytic iron at present is by using a mixture of ferrous sulphate and chloride and ammonium sulphate as electro-

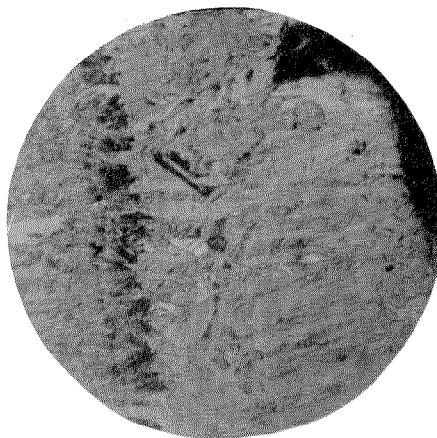

Figure 2—Photomicrograph (Enlarged 100 Times) of Cross Section of Piece of Iron Shown in Figure 1

lyte. As for electrodes, mild steel and polished steel are used for anode and cathode, respectively. The current density is 12 amperes per square foot. The cathodes are removed when the deposit has reached a thickness of 1/8 to 1/4 inch, and are washed in hot water to remove the electrolyte. The deposited iron is then stripped from the cathode sheets and broken up into pieces about an inch square. This material is then pulverized with a ball mill to the size which will pass through an 80-mesh sieve without

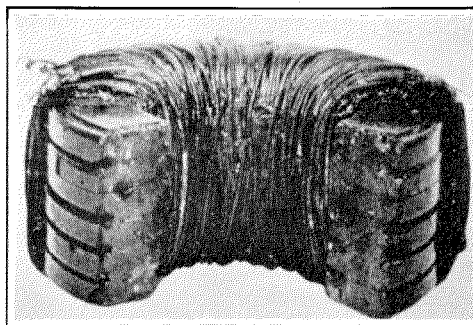

Figure 3—Loading Coil with Ring Form of Winding in Which Part of the Core and Winding Has Been Removed

residue. Figure 1 shows the photograph of a piece of iron peeled off from a cathode and Figure 2 shows the photomicrograph of its cross section (enlarged 100 times).

Pulverized iron is either annealed or unannealed, according to the grade of core required and then compressed into the form. Annealing is done by heating the powder approximately up to 850 degrees centigrade in a cast iron box and is slowly cooled down with the furnace. During this process, the powdered iron forms into lumps so that it is necessary to pulverize it again through a rock crusher. Annealed powder is relatively soft so that when placed under compression, the particles have a tendency to flatten out. Annealing is done in order to utilize this property.

A given weight of the powder is poured through a funnel into a mold on a hydraulic pressing machine (which is similar in construction to a lead sheathing machine) and is molded into a ring form under the pressure of 200,000 pounds per square inch. Immediately after the application of this pressure, the core thus shaped is found heated to the extent that it is almost impossible to touch it with a bare hand. This fact indicates that the compression is giving a ramming effect to the core which is being molded.

The dimensions of these rings differ according to their different uses and requirements, but one of the very common types is $\frac{1}{4}$ inch in thickness with an outer diameter of 4 inches and an inner diameter of $2\frac{1}{2}$ inches. Several of these rings are piled in tiers and wrapped around with cloth, over which is wound the cotton insulated wire as shown in Figure 3.

The Western Electric Company has three standards of cores, namely, Grade *A*, Grade *B* and Grade *C*, all of which are manufactured by the same process, and compressed under the same pressure. These three grades of cores have different magnetic properties owing to the fact that the size of the powder particles and the composition of the powder, as well as its heat treatment, are different in each grade, other things being the same. Grade *A* is the one whose iron powder is passed through an 80-mesh sieve (linear) and is entirely annealed. It has a specific gravity of 7.1 and an effective permeability of approximately 55.

Grade *B* is the same as Grade *A* except that the greater part of the powder used is not annealed; more specifically, 90 percent of it is not annealed and the remaining 10 percent is annealed. Specific gravity of this grade is 6.4 and

the effective permeability is 35. Annealed iron is added in order to bring the permeability up to the desired value and also to add somewhat to the mechanical strength of the rings. Grade *C* is manufactured from a mixture of annealed and unannealed powder in the same proportion as Grade *B* but the size of the grain is much smaller; namely, that which passes through a 200-mesh sieve. Specific gravity and permeability in this case are 6.0 and about 25 respectively.

The fact that these three classes of rings have different specific gravities and permeabilities has an important relationship with the theory to be given later. Therefore, the writer wishes to speculate a little further in regard to the cause of such variations. First of all, the fact of the greater specific gravity in Grade *A* than *B* and of *B* than *C*, immediately suggests that the total air spaces still left after compression is least in *A* and greatest in *C*. The reason, as the writer sees it, is that Grade *A* has its powder all annealed and, therefore, it being softer, the percentage of particles which are deformed (flattened) by compression is greater so that intergranular space (as it may be termed) is proportionally less in *A* than *B*. In the case of Grade *B* and *C*, the difference is entirely due to the fineness of the grains of these two standards. With the greater particles, the mass as a whole is further removed from the state of liquid and the compressional force is transmitted mainly in the direction of the force applied so that the particles are quite effectively flattened out, filling up the empty spaces. On the other hand, the mass formed by the finer particles is nearer to the liquid state (doubtless to say that the iron powder under consideration is far from being in a liquid state but one may so consider it in the case of comparison) so that the applied force is transmitted in all directions and the force effective in deforming the particles and filling up the gaps is decreased. It is inferred from this view, that the specific gravity is greater in *B* than *C*. As to the difference in effective permeability, if the relation, which the writer will explain later on, between the effective permeability and the deformation of the grain in the three standards is considered, the case will become self-explanatory.

If the permeability of a core is a constant, the coil which is built with it has a constant inductance, irrespective of current. Furthermore, this

inductance can be measured very readily and accurately. If, however, a coil is built with an iron core of variable permeability, the difficulty encountered is not only inductance irregularity but also the complexity of measurement. The following method is one in common use in such a case.

The measurement of inductance of a coil of this kind is always made with alternating current but in this particular case, direct current is superposed on alternating current. Direct current is varied as desired to change the intensity of magnetization and inductance is measured with different field intensities at various intensities of magnetization. These variable inductance data are taken so as to express inductance with corresponding magnetization of the core (internal field intensity) or magnitude of current in the coil. If the variation of inductance is known, permeability at each of these instances can be found.

Such expressions of inductance as stated above have meaning and significance in the case of a solid iron core or a bundled small iron wire core but a core built with iron powder has great ambiguity in such expressions. Yet it is still used occasionally. We find such an example in a discussion on a powdered iron core, given in the Transactions of the A.I.E.E. on page 1340, Vol. XL, 1921. In it, H , B , and μ are expressed similarly as described above. In the same paper, permeability μ and magnetizing force H are said to have been calculated from the following formulas:

$$L = \frac{4\pi N^2 A \mu}{l \times 10^9}, \quad H_{\max} = \frac{4\pi N I \sqrt{2}}{l \times 10}$$

- where L = Inductance in henries
 I = Current in amperes (r.m.s.)
 H = Magnetizing force in gaussess
 B = Flux density in gaussess
 μ = Permeability of core
 N = Total number of turns of winding on the core
 A = Cross-section of core cm.²
 l = Mean length of the magnetic circuit in cm.

Judging from the foregoing discussion, it is clear that these formulas are correctly applicable only where the core of a coil is air, solid iron or

bundled iron wire. In these cases, H as expressed in the formula, is in reality the expression of the field intensity in the core. If this value is multiplied by the permeability of the core material, flux density B can be obtained directly. In the case of the powdered iron core, however, the same formula cannot be well applied, since H as given therein exists nowhere in the core due to the fact that it is neither iron nor air but a composition of the two. Within the particles, H is less due to the polar demagnetizing action, and within the air spaces, it is much greater (which will be explained later) than the H as expressed. The permeability μ , which is calculated by substituting measured values of L and known physical factors such as N , A and l in the formula for various values of current densities, is the expression of effective permeability of the powdered core itself. Therefore it has (more or less) some significance. However, from the standpoint of the relationship between this effective permeability and the permeability of electrolytic iron, it has no value.

Indeed, such a composite core as we have here, must be treated as a composition, in order to find any explanation at all for problems such as the following:

(1) Why does effective permeability decrease and stability increase when solid is made into powdered form?

(2) Why does effective permeability increase and stability decrease with increasing deformation by compression while the true permeability of electrolytic iron remains constant?

These problems of effective permeability and stability of the powdered iron core seem to be governed entirely by the polar demagnetizing action of iron particles of which it is composed. In this connection, the writer wishes to state his own belief and oblige himself for criticisms from his readers.

If a piece of iron is brought into a magnetic field of intensity H_0 , the magnetic field intensity H within the piece is less than H_0 , due to the fact that the magnetic induction of the piece causes polar formation which sets up a counter field within the piece, thereby decreasing the field intensity. This counter field or in other words, demagnetization, is proportional to I , the intensity of magnetization. The proportionality between the two is called the demagnet-

izing factor and is designated by \bar{N} . The value of \bar{N} depends upon the directional shape of the piece, that is, on the length of the piece in the direction of magnetization. The shorter it is, the greater will be the value of \bar{N} or vice versa.

This value for a regular form, such as an ellipsoid of revolution can be calculated. The formula for the calculation and the calculated values of \bar{N} for various values of m (ratio of major to minor axis of ellipsoid of revolution) are as follows:

$$\bar{N} = \frac{4\pi}{m^2 - 1} \left\{ \frac{m}{\sqrt{m^2 - 1}} \log (m + \sqrt{m^2 - 1}) - 1 \right\}.$$

TABLE

m	0	0.5	1	2	3	4	5	6	7
\bar{N}	12.566	6.586	4.189	2.120	1.328	0.939	0.701	0.538	0.431
m	8	9	10	11	12	14	16	18	20
\bar{N}	0.357	0.295	0.254	0.222	0.196	0.153	0.122	0.100	0.084
m	∞								
\bar{N}	0								

In the case of irregular form, it is usually difficult to compute \bar{N} . However, whatever the shape or form may be, the value of \bar{N} always lies between the two limits of 4π and zero just the same as in the case of an ellipsoid of revolution, so that any shape has a corresponding ellipsoid of revolution having the same \bar{N} .

If the above discussion is represented in equations, we have,

$$H = H_0 - \bar{N}I, \quad (1)$$

in which

$$I = \kappa H = \kappa(H_0 - \bar{N}I).$$

Therefore,

$$I = \frac{\kappa H_0}{\bar{N}\kappa + 1}. \quad (2)$$

In this case, an average intensity of magnetic induction, B , within the iron piece is,

$$B = H + 4\pi I. \quad (3)$$

Substituting (1) in (3), we have

$$B = H_0 - \bar{N}I + 4\pi I = H_0 + I(4\pi - \bar{N}). \quad (4)$$

Substituting (2) in (4), we get

$$B = H_0 + \frac{\kappa H_0}{\bar{N}\kappa + 1} (4\pi - \bar{N}) = \frac{H_0(1 + 4\pi\kappa)}{\bar{N}\kappa + 1} \quad (5)$$

$$= H_0 \frac{\mu}{\bar{N}\kappa + 1}.$$

Again,

$$B = \mu H = H_0 \frac{\mu}{\bar{N}\kappa + 1}.$$

Therefore,

$$H = \frac{H_0}{\bar{N}\kappa + 1}, \quad (6)$$

where H_0 = Original field intensity

H = Actual field intensity within the piece of iron

I = Intensity of magnetization

\bar{N} = Demagnetizing factor of the piece

κ, μ = Susceptibility and permeability of the piece material, respectively

Since the powdered iron core under discussion is the case in which fine iron powder is located in a magnetic field, the magnetic induction in each particle can be represented by formula (5).

In the case of a loading coil, uniform magnetic field intensity H_0 is,

$$H_0 = \frac{4\pi Ni\sqrt{2}}{l \times 10}. \quad (7)$$

Therefore, a mean magnetic induction B in each particle is

$$B = \frac{4\pi Ni\sqrt{2}}{l \times 10} \times \frac{\mu}{\bar{N}\kappa + 1}. \quad (8)$$

and

$$L = \frac{4\pi Ni\sqrt{2}}{l \times 10} \times \frac{\mu}{\bar{N}\kappa + 1} \times \frac{NA}{i\sqrt{2}} \times 10^{-8}$$

$$= \frac{4\pi N^2 A}{l \times 10^9} \times \frac{\mu}{\bar{N}\kappa + 1}, \quad (9)$$

where L = Inductance in henries

i = Current in amperes

H = Magnetizing force in gauss

B = Magnetic induction or flux density in gauss

μ = Permeability of electrolytic iron

κ = Susceptibility of electrolytic iron

N = Total number of turns of winding on the core

A = Cross-section of core in cm^2

l = Mean length of the magnetic circuit in cm.

\bar{N} = Demagnetizing factor of iron powder

Examining formula (9), we find the term, $\mu/(\bar{N}\kappa + 1)$, which is equivalent to permeability μ in the case of a closed magnetic circuit. In a case such as we have here, where the core is

formed by iron powder, it is necessary to use this term, which may be called an apparent permeability, instead of the ordinary permeability μ of the iron. In the discussion of the

dimensions and constants, \bar{N} is calculated backwards, so to say. The method employed for measuring inductance of a coil having a core of this kind will be described later.

In the case of a core of powdered iron hardened with wax, instead of being compressed, the mean \bar{N} for the particles can be approximated. The particles in this case may be considered as spheres, in the direction of magnetization. Then mean \bar{N} of the particles can be assumed to be $4\pi/3$ and, therefore, the effective permeability, of the core will be

$$\frac{\mu}{\bar{N}\kappa + 1} = \frac{4\pi\kappa + 1}{\frac{4\pi\kappa}{3}} \doteq 3.$$

This indicates the fact that such a core has an effective permeability of approximately three times that of an air core. This furnishes the reason why the powdered iron core in its early stage of development, had an effective permeability of very small value and, therefore, was, not suited for a core material in practice.

Again,

$$\frac{\mu}{\bar{N}\kappa + 1} = \frac{4\pi\kappa + 1}{\bar{N}\kappa + 1}.$$

If the value $\bar{N}\kappa$ in this expression were very large

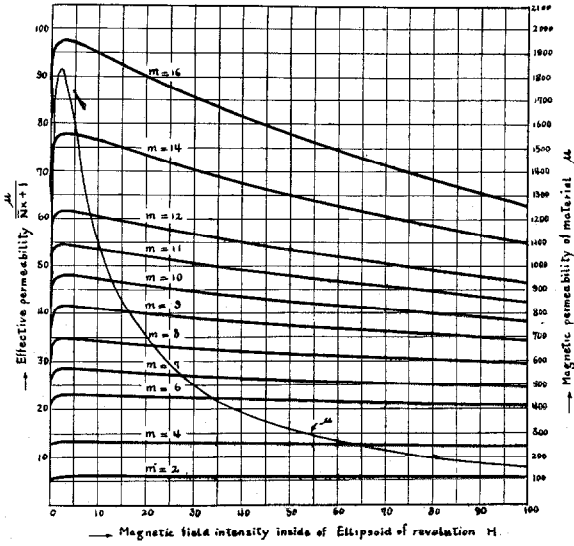

Figure 4—Relation of Effective Permeability of Various Ellipsoids of Revolution to Field Intensities Inside of the Ellipsoids

powdered iron core in the A.I.E.E. Transactions, this term is represented by simple μ and is called effective permeability.

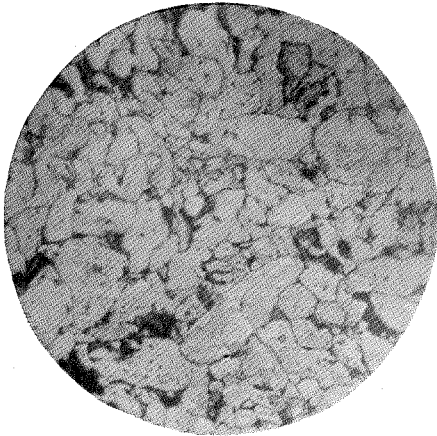

Figure 5A—Photomicrograph (Enlarged 100 Times) of Surface of One of the Powdered Cores

The value of \bar{N} for a powdered iron core cannot be calculated mathematically so that the inductance of the core is measured experimentally and, by substituting the value of μ of electrolytic iron in formula (9) with other values of physical



Figure 5B—Photomicrograph of the Surface Shown in Figure 5A but Enlarged 400 Times Instead of 100

as compared with 1, the same expression would be reduced to

$$\frac{\mu}{\bar{N}\kappa + 1} \doteq \frac{4\pi\kappa}{\bar{N}\kappa} = \frac{4\pi}{\bar{N}}$$

and become a constant. If effective perme-

ability of a core is constant, the inductance of the coil with such a core is constant and its magnetic stability will be perfect. But in such

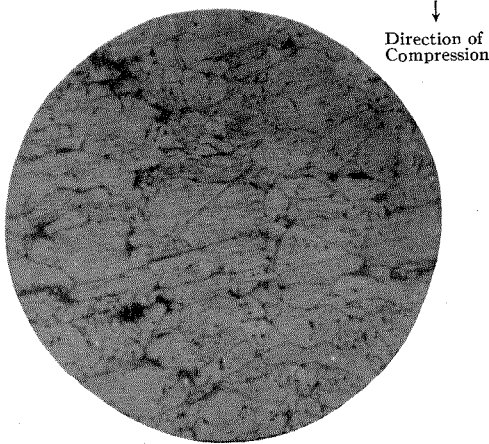

Figure 6A—Photomicrograph (Enlarged 100 Times) of Cross Section of Piece Shown in Figure 5A

a case, effective permeability would usually be very small just as was shown in the case of the powdered iron core which is not formed by compression but hardened with wax only. When \bar{N} is further removed from 4π , $\mu/\bar{N}\kappa + 1$ varies with the change in μ and κ , and a larger effective permeability is obtainable but the stability diminishes accordingly. The limiting case $\bar{N} = 0$ is solely controlled by μ and the stability vanishes. This is the case where small iron

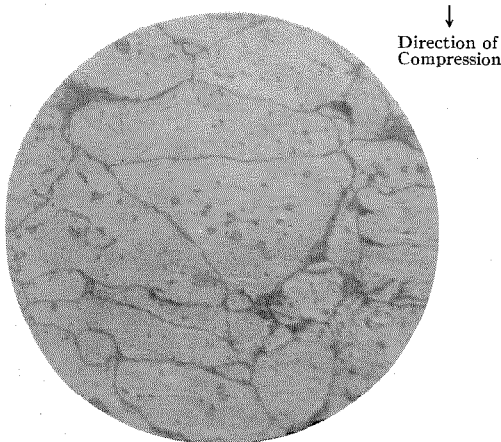

Figure 6B—Photomicrograph of the Cross Section Shown in Figure 6A but Enlarged 400 Times Instead of 100

wire was used for core, and points out the fact that the inductance of a loading coil of this type would invariably change with the current density variation.

Figure 4 shows the variation of the effective permeability of various ellipsoids of revolution according to the various field intensities which would exist inside of the ellipsoids. These ellipsoids are assumed to be of iron which has the same permeability as shown in the figure. Figure 5A is a photomicrograph (enlarged 100 times) of the surface of one of the powdered cores and 5B is the same as 5A except that the enlargement is 400 times instead of 100. Figure 6A is another photomicrograph (enlarged 100 times) of its cross section, cut perpendicular to the magnetic flux path—pressure was applied from both sides (above and below) of the core. Figure 6B is the same as 6A except for the size being enlarged 400 times instead of 100. While the photograph of the surface shows irregularity of particles in shape but without trend for any particular shape or form, cross sectional views show distinctly the deformation of grains in the direction of compression. From these photographs it can easily be seen that these particles are compressed nearly to a disc form and the magnetizing force is in the direction parallel to the flat surfaces of these discs. The demagnetizing factor \bar{N} for the circular disc, magnetized in the direction perpendicular to its axis, can be very roughly estimated to have a like value of \bar{N} as an ellipsoid of revolution having the same value of m as would obtain in the case of a circular disc which is folded in half and rolled up with the folded edge in the centre.

Judging from the fact that effective permeabilities for the three standards of grade A, B and C are 55, 35 and 25, respectively, values of the ratio m for the corresponding ellipsoids of revolution and these of \bar{N} and $4\pi/\bar{N}$ can be roughly estimated. The results are as follows:

Grade	A	B	C
m	11	8	6
\bar{N}	0.222	0.357	0.538
$4\pi/\bar{N}$	56.6	35.2	23.4

If we use our suppositional values of \bar{N} as obtained above, and substitute in $\mu/\bar{N}\kappa + 1$ with various values of μ and κ , it is clearly seen that permeability is greatest and the stability least in A and permeability least with greatest stability in C. In Figure 6, the particles do not seem

flattened out enough to justify the value, $m > 6$. Perhaps it is due to the fact that while the photograph shows the cross sectional view of the particles compressed into the disc form the majority was not cut at the centres of the discs by the surface taken in the picture so that there is not much difference between thickness and length.

Since field intensity H within a particle is,

$$H = \frac{H_0}{\bar{N}_k + 1}$$

it is never equal to the magnetizing force

$$H_0 = \frac{4\pi Ni\sqrt{2}}{l \times 10}$$

unless \bar{N} becomes zero; otherwise, H is usually smaller than H_0 . Magnetic field intensity H' in the gaps is (due to the law of continuity of magnetic lines of induction or flux) equal to the flux density B which in turn is equal to B as expressed in formula (5). Therefore,

$$H' = \frac{\mu}{\bar{N}_k + 1} \tag{10}$$

The greatest value of \bar{N} is 4π , in which case and only then, H' becomes equal to H . However, \bar{N} is usually smaller than 4π ; therefore, $\mu/\bar{N}_k + 1$ is larger than 1. This proves that the intensity in the gaps of a powdered iron core is greater than the magnetizing force H_0 .

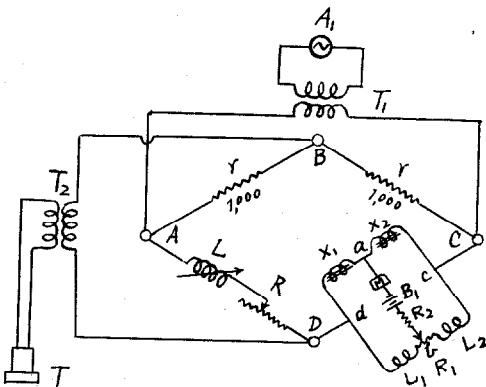

Figure 7—Method of Measuring the Inductance of a Loading Coil with DC Superposed over AC

One method of measuring the inductance of a loading coil with d.c. superposed over a.c. is done with a bridge such as the one shown in

Figure 7. In this figure, $A-B-C-D$ constitute the main and the first bridge, rr are resistances of 1,000 ohms, each forming AB and BC arms. The arm AD is composed of an inductometer L and a non-inductive resistance R ; the arm CD

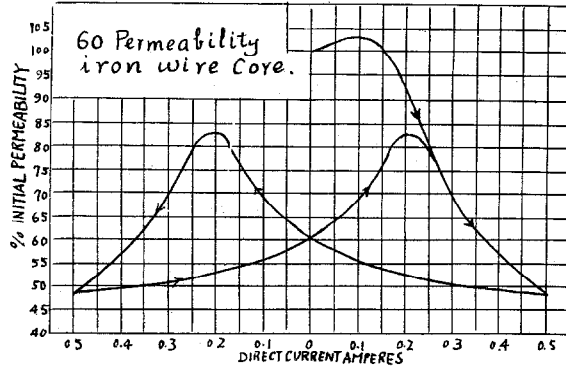

Figure 8—Variation of a Loading Coil with a 4-Mil Hard Drawn Iron Wire Core

has another bridge, called the second bridge, $abcd$. This second bridge is composed of X_1, X_2 , (which are two coils with the same core under investigation and it may be seen from the diagram that these coils are connected in series with the bridge 1), L_1, L_2 , (which represent air core inductance coils, whose inductance and effective resistance are balanced to each other), a non-inductive resistance R_1 , battery B_1 , with a

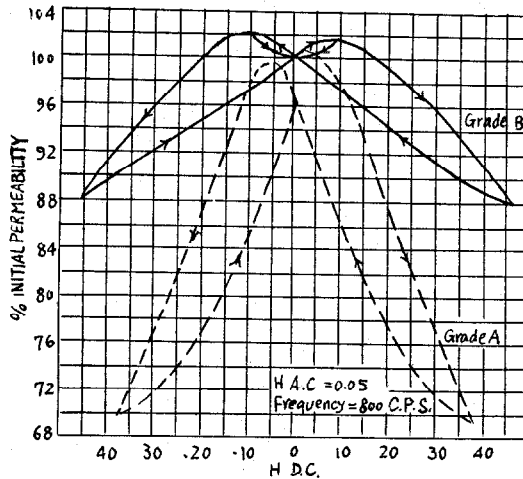

Figure 9—Variation of Loading Coils with Grade A and B Cores. DC Superposed over AC

rheostat R_2 and an ammeter M to measure the current flowing through ab . If a perfect balance of the second bridge is obtained, there will be

no potential difference between points *cd*. T_1 , T_2 are transformers, the former for the power source and the latter for the telephone receiver T . Both are well shielded. A is the power source of suitable frequency.

The measurement is made as follows:

(1) Balance the first bridge without d.c. in the second bridge.

(2) Superpose suitable d.c. in the second bridge.

(3) Take note of the first adjustment of L and R on the AD arm of the first bridge and then readjust them for balance. If the difference of these two adjustments be denoted by $\Delta L'$ and $\Delta R'$, the relationship between these quantities and ΔL and ΔR , denoting the changes in inductance and resistance of the two coils, X_1 , X_2 , due to superposition of d.c., can be given by the following formulas:

$$\Delta R = \frac{\Delta R'}{2} \times \frac{(L_1 + L_2 + X_1 + X_2)^2}{(L_1 + L_2)^2},$$

$$\Delta L = \frac{\Delta L'}{2} \times \frac{(L_1 + L_2 + X_1 + X_2)^2}{(L_1 + L_2)^2}.$$

From these equations, computations may be made to obtain the curves, showing the percentage of variation in inductance (see Figures 8 and 9).

Figure 8 shows the inductance variation of a loading coil with a 4-mil hard drawn iron wire core. This type of core is commonly called 60 permeability core and is the best among its class. Yet, as the curve indicates, from the standpoint either of residual magnetism or stability, it is inferior, by far, to a powdered iron core. Figure 9 shows the variation characteristics of the Grade *A* and *B*. The improvement is very clear at a glance.

Simultaneous Broadcasting in Czecho-Slovakia

By E. K. SANDEMAN

European Engineering Department, International Standard Electric Corporation

Introduction

SIMULTANEOUS Broadcasting refers to the process of radiating a programme, originating at any one place, simultaneously from a number of transmitting stations. The use of wireless links for this purpose has certain advantages in special cases, as for instance

equalisers. It is not usually necessary to correct for the distortion introduced by open wire lines until very long lines are encountered.

To provide the correct energy levels in the lines it is essential that distortionless valve amplifiers capable of delivering adequate volume to the line terminals be installed.



Figure 1—Photograph of Prague, Showing the Castle of the Ancient Kings of Bohemia with the Cathedral in Background

where it is required to bridge a great distance over the sea, but for communication over land, the use of wire circuits is more usual.

When these lines contain even short lengths of cable in their make-up, it is necessary to compensate for the unequal attenuation of different frequencies by means of networks which build up the total attenuation at each frequency to the same value. These networks are known as

Flexible switching arrangements must be supplied to enable any combination of stations to be connected quickly into the circuit, and to provide for the checking of the fidelity of reproduction and the correctness of the volume level at any point in the resulting circuit network.

The system described in this paper is a typical example of the arrangements necessary in practice to meet these requirements.

Interconnecting System

The controlling interest of the Czecho-Slovakian Broadcasting Company is held by the Ministry of Posts and Telegraphs. There are three stations located respectively at Prague, Brno and Bratislava. In addition, a 2 KW broadcaster manufactured by Standard Telephones and Cables, Ltd., London, is in process of installation at Kosice.

In the Prague station, which was described in a previous issue of "Electrical Communication,"¹ the transmitter supplies 5 KW and in the Brno Station 2.4 KW of unmodulated energy to the antenna. The station at Bratislava is an 0.5 KW outfit.

A system has been installed recently for the interconnection of the three completed stations by land lines and it is expected that Kosice will be included in the near future. Arrangements are provided by means of which the programme from any one of the studios or from a local theatre or music hall in any one of the towns may be radiated from either or both of the other stations simultaneously. Connection between Prague-Brno, and Prague-Bratislava is effected by means of circuits of which the make-up is chiefly open wire. There is no direct connection between Brno and Bratislava.

Line Connections

As an example of the type of circuit employed, the make-up of pair No. 2524 between Brno and Prague is given:

Type of Line	Length in Km.	800 Cycle Attenuation per Km. (β /Km.)	800 Cycle Attenuation (β)	800 Cycle Attenuation (TU)
3 mm. O.W.....	161	0.0043	0.965	6.05
4 mm. O.W.....	67	0.0026	0.174	1.51
5 mm. O.W.....	0.45	0.0017	0.008	.07
2 mm. Krarup Cable	7.7	0.0285	0.220	1.91
Total.....			1.097	9.54

The measured value of attenuation at 800 cycles was 9.8 TU.

All lines are equalised in the 30-5000 cycle range by standard Western Electric 1-A Equal-

¹"The Prague Radio Broadcasting Station," E. M. Deloraine, ELECTRICAL COMMUNICATION, Vol. 5, No. 3, January, 1927.

isers. In Figure 2 is shown the mean observed attenuation characteristics of line No. 2524, both before and after equalisation. Even with reflections present, it is evident that the de-

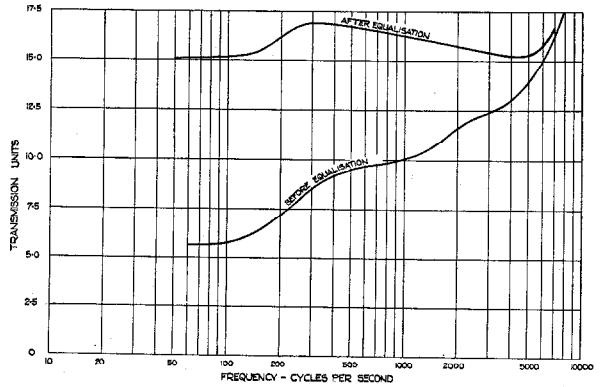

Figure 2—Attenuation of Pair No. 2524 of the Telephone Line between Brno and Prague, before and after Equalisation

partures from uniform attenuation of the final characteristic are small, it having been found possible in every case to equalise within the limits of ± 1 TU.

Figure 3 illustrates the characteristics of a line between the National Theatre in Prague and the Control Room in Prague before and after equalisation. A view of the National Theatre is shown in Figure 4.

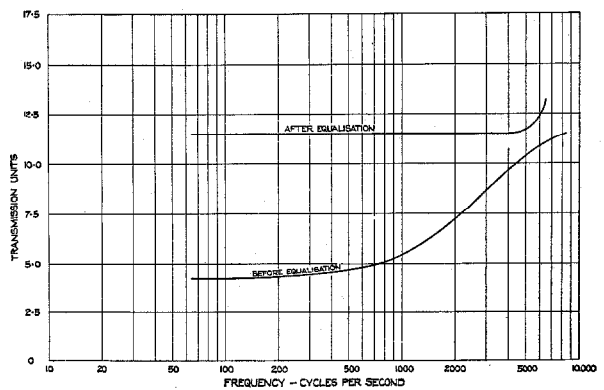

Figure 3—Attenuation of Line between National Theatre (Prague) and Studio (Prague), before and after Equalisation

It will be seen that in the present state of development of the art, the land line system introduces no detectable distortion into the transmission, and except for differences that may exist between the stations, a programme originat-

ing at any one station may be radiated with as great fidelity from any other station as from the local station.

In Figure 5 is shown a circuit of the type of equaliser used. This consists merely of a shunt impedance made up of a three dial variable resistance in series with a resonant rejector circuit having two alternative resonances, one

equalised to 5,000 cycles so that the 3,000 cycle setting of the equaliser is never used. In order to economise in amplifiers, equalisation was not carried out to a frequency higher than 5,000 cycles. This is justifiable since the higher frequencies are not reproduced by existing receiving apparatus. At a later date it will be a simple matter to equalise the lines to a higher value of



Figure 4—National Theatre, Prague

for equalising to 3,000 cycles and one for equalising to 5,000 cycles. The variable resistance is adjusted to provide for different lengths of line. The values of the effective resistances of the two alternative inductances, are so chosen that the equaliser is capable of exactly neutralising the distortion in No. 19 gauge cable when an appropriate value of series resistance is inserted. Reference to Figure 3 will be of interest in connection with this statement. It should be mentioned, however, that the accuracy of measurement was not greater than ± 0.25 TU. In the system in Czecho-Slovakia all circuits have been

frequency and to increase the number of amplifiers accordingly.

Equalisers for the interurban lines, Prague-Brno, Prague-Bratislava and Prague-Pilsen are situated in the central control room of the system at Prague. Since there is but one type of equaliser, which is capable of being adjusted to fit the characteristic of any line, it is only necessary to have a limited number of equalisers in the central station, the equalisers being set to fit any line with which they are connected. Actually, four equalisers are installed at Prague; this provides for the case of a programme in a theatre in

Prague being simultaneously broadcasted from Prague, Brno and Bratislava. One equaliser is then inserted in each of the following lines: Theatre—Control Room (Prague); Control Room—Prague Transmitting Station; Control Room—Brno; Control Room—Bratislava.

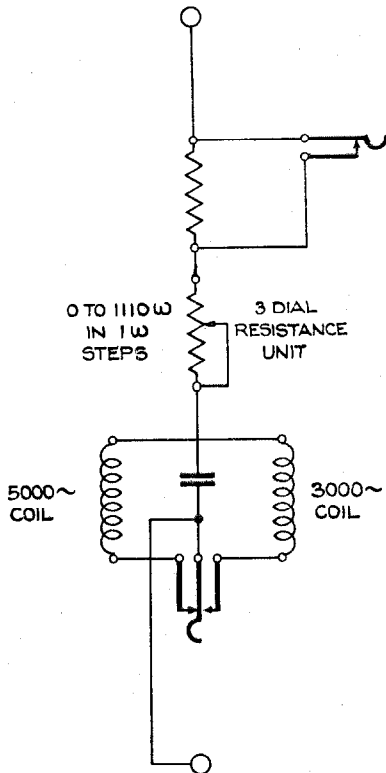

Figure 5—Circuit of Standard No. 1-A Equaliser

To illustrate the simplicity of the use of these equalisers a list of the resistance settings is given below for four of the lines measured.

	Resistance Ohms
Control Room in Prague—Brno.....	160
“ “ “ Prague—Bratislava.....	060
“ “ “ Prague—National Theatre in Prague	200
“ “ “ Prague—Smetana Hall in Prague...	400

After these values have been established by measurement, an unskilled attendant can equalise any line in a few seconds.

Two line impedances have been standardised for the case of a radial system such as the present one; 200 ohms at the central control station where are situated all the equalisers, and 500 ohms at the theatres and provincial stations. In the case where an equaliser is situated at a provincial station for the purpose of equalising a local

theatre line, an impedance of 200 ohms must be used.

The 500 ohm value was chosen as a compromise covering the general case of all types of line at the end remote from the equaliser; and 200 ohm, as the average impedance of an equalised cable circuit at the end where the equaliser is situated. It should be realised that the preservation of exact impedance matching is of little importance provided the line is capable of being equalised to be flat when operating between impedances equal to those of the terminal amplifiers. In practice such extreme variations of impedance as would violate this condition do not occur. The only other reason for preserving impedance matching is the question of loading appropriately the output of vacuum tubes employed. Here again no difficulty is experienced, since all valves in the system are operated with a power output approximately of one hundredth of their overload power.

For the simple measurements necessary to determine the equaliser settings referred to in the preceding paragraphs, apparatus is connected at each end of the line as shown in Figure 6, where *O* is a valve oscillator preferably covering a range of 30 to 5,000 cycles per second.

*V*₁ is any convenient form of voltmeter, and may be a thermocouple or a valve voltmeter. The two 250 ohm resistances afford a balanced simulation of the 500 ohms impedance which will be connected to the line.

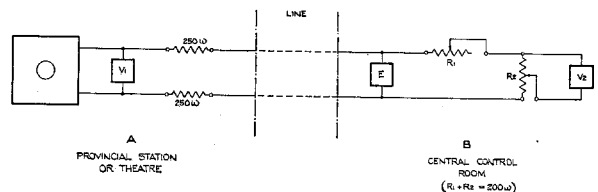

Figure 6—Arrangements for Line Measurements to Determine Equaliser Settings

E is the equaliser.

*R*₁ and *R*₂ effectively constitute a potentiometer, *R*₁ being decreased when *R*₂ is increased, and vice versa, so that the sum (*R*₁ + *R*₂) is equal to a constant, i.e., 200 ohms, the impedance which will close the line at the end in question.

*V*₂ is a high impedance distortionless voltmeter of sufficient sensitivity. It is convenient to employ a detector valve preceded by a resistance

coupled amplifying stage. Standard 4102-D valves having a voltage amplification of 30 are used. The variation in sensitivity is only 6 percent from 100 cycles to 10,000 cycles and so can be neglected.

To equalise to 5,000 cycles, that frequency is supplied at A , and R_1 and R_2 are adjusted to give a suitable deflection on the voltmeter; this deflection is noted. Since the inductance and capacity elements of the shunt are in resonance, at the above frequency, the variable resistance in the equaliser makes little difference to the deflection, but it is usual to guess the final value and to set the equaliser resistance at this value. The lowest frequency to which it is required to equalise is then supplied at A , and with the same deflection on V_1 as for 5,000 cycles, the resistance in the equaliser is adjusted until the same deflection as was obtained at 5,000 cycles on V_2 is again obtained. This value of resistance is then the required value. In every case, however, it is advisable to make a check test at frequency intervals not greater than an octave, and in this case it always was done. During the check test the resistance in the equaliser is kept constant, and R_1 and R_2 are varied to keep the deflection on V_2 constant; the values of R_2 then give directly relative values of voltage ratio between the input and output of the line.

Volume Level of Speech and Music

In every case during transmission the volume at the input to an interurban line is adjusted to an energy level about 2 TU. higher than zero level, the latter being taken as 5.9 milliwatts. Standard volume indicators are provided at the control room in Prague, and also at the local stations, by means of which the power level delivered to any line may be measured.

With this volume it is found that the received energy is sufficiently high to overcome interference, while the input energy is not sufficiently high to cause trouble in neighbouring circuits.

Circuit Arrangements

In the control room at Prague is a 100-line exchange fitted with single two point break jacks and a certain number of ringing indicators. The ringing indicators are bridged across the interurban lines and the theatre control lines. The

interurban lines are brought out to two jacks in parallel but the indicators are so wired that they are disconnected when a plug is put into either jack. Only single lines are provided between the towns. These lines have, therefore, to serve both for music lines and control lines. The in-

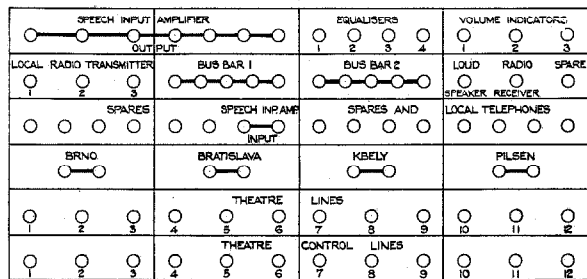

Figure 7—General Arrangement of Simultaneous Broadcasting Switchboard at Prague

stallation of a superimposed telegraph circuit for control during broadcasting is being contemplated. In Figure 7 is indicated the general ar-

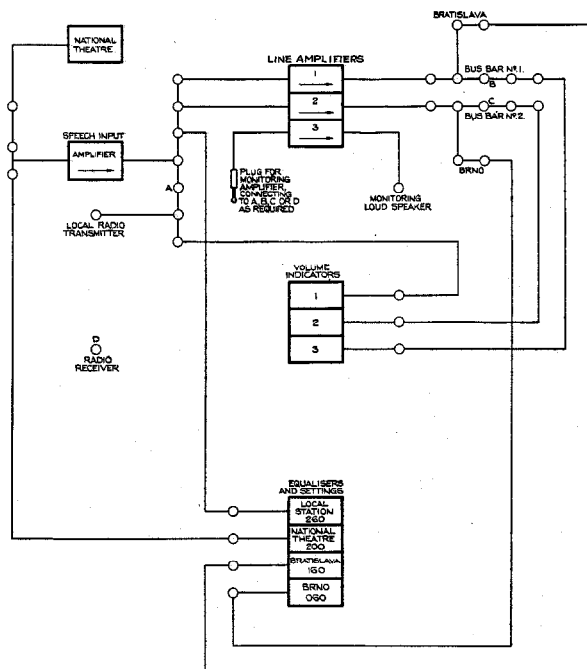

Figure 8—Control Room Arrangements of Simultaneous Broadcasting System

angement of the switchboard in Prague. Equalisers and volume indicators are brought out to jacks so that they can be connected with any line as required.

Distribution of programmes to the interurban

lines is effected by means of Western Electric Amplifiers inserted in the special cord circuits of the exchange. During transmissions the inputs of these amplifiers are connected in parallel to the output of the speech input amplifier which is connected with the local transmitter in the

the three stations, Prague, Brno and Bratislava.

Arrangements are provided so that either of the impedance matching transformers associated with the line amplifiers may be associated with the amplifier normally used with the loud speaker for monitoring purposes. The arrangement is in

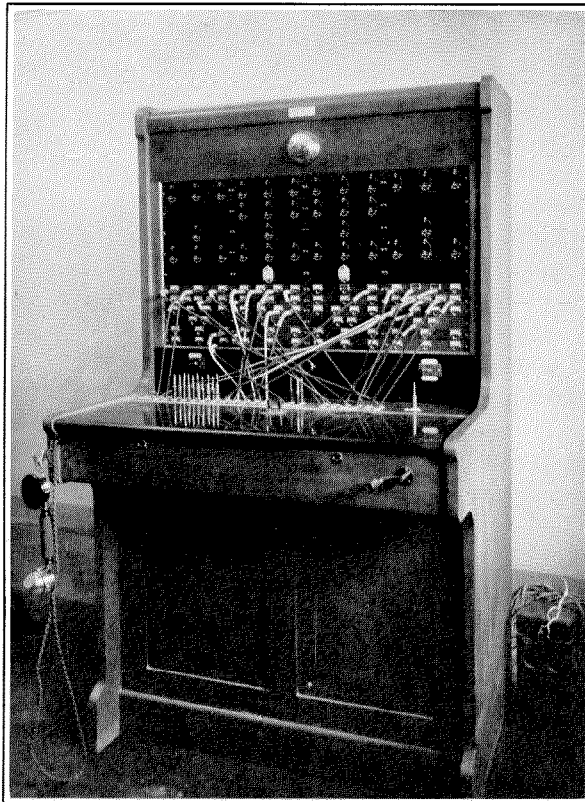

Figure 9—Simultaneous Broadcasting Switchboard at Prague

standard manner. For the purpose of maintaining flat transmission characteristics, one 10,000 ohm resistance is inserted in each leg of the input of each line amplifier. As the amplifiers have a high output impedance, standard impedance matching transformers are inserted between the output of each amplifier and its line.

In Figure 8 are shown the circuit arrangements for the simultaneous broadcasting of a programme, originating in a theatre in Prague, from

fact symmetrical, so that the loud speaker amplifier forms a spare for the line amplifiers.

Figure 9 shows a general view of the switchboard in Prague. It might be mentioned that the illustration is not altogether up to date, inasmuch as certain changes in the equipment were made after the photograph from which the figure was reproduced was taken. The switchboards at Brno and Bratislava are of similar construction, but are arranged for fifty lines.



Figure 10—Philharmonic Concert Hall, Prague

Summary

The outstanding features in the Czechoslovakian system are simplicity, reliability and flexibility of operation. The system is constructed so that it is capable of unlimited exten-

sion in a manner such that these qualities may always be retained. The only improvement of importance to be incorporated in the system is the extension of the frequency range to 8,000 cycles, a change which will be introduced at an opportune time.

International Standard Electric Corporation

Head Offices
NEW YORK, U. S. A.

European General Offices
LONDON, ENGLAND
PARIS, FRANCE

Associated and Allied Companies

- Standard Telephones and Cables, Limited.....*Aldwych, London, England*
Branches: Birmingham, Glasgow, Leeds, Manchester, Dublin,
Cairo, Johannesburg, Calcutta, Singapore.
- Standard Telephones and Cables (Australasia), Ltd.....*Sydney, Australia*
Branches: Melbourne, Wellington.
- Bell Telephone Manufacturing Company.....*Antwerp, Belgium*
Branches: Berne, The Hague, Brussels.
- Standard Electric Doms a Spolecnost.....*Prague, Czecho-Slovakia*
- Standard Electrica, S. A.....*Madrid, Spain*
Branch: Barcelona.
- Standard Elettrica Italiana.....*Milan, Italy*
Branch: Rome.
- Standard Electric Aktieselskap.....*Oslo, Norway*
- Le Materiel Telephonique.....*Paris, France*
- United Telephone and Telegraph Works, Ltd.....*Vienna, Austria*
Branch: Tallinn (Reval).
- Standard Electric Company W. Polsee.....*Warsaw, Poland*
- United Incandescent Lamps and Electrical Company, Limited.
Budapest (Ujpest), Hungary
- Compania Standard Electric Argentina.....*Buenos Aires, Argentina*
- International Standard Electric Corporation, Branch Office.
Rio de Janeiro, Brazil
- Nippon Electric Company, Limited.....*Tokyo, Japan*
Branches: Osaka, Dalny, Seoul, Taihoku.
- Sumitomo Electric Wire & Cable Works, Limited.....*Osaka, Japan*
- China Electric Company, Limited.....*Peking, China*
Branches: Shanghai, Tientsin.

Sales Offices and Agencies Throughout the World

To those interested in better communication the International Standard Electric Corporation and its Associated and Allied Companies offer the facilities of their consulting engineering departments to aid in the solution of problems in Telephony, Telegraphy and Radio.