

# ELECTRICAL COMMUNICATION

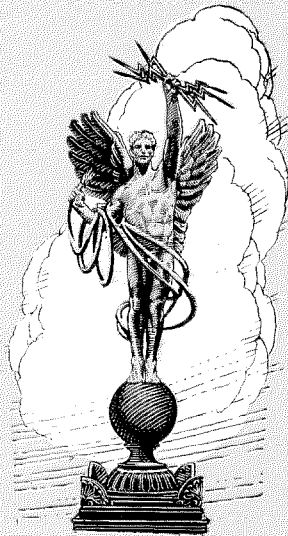

APRIL  
1926

No. 4  
VOL. 4

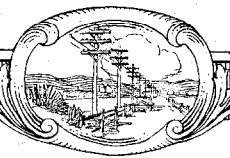

# ELECTRICAL COMMUNICATION

A Journal of Progress in the  
Telephone, Telegraph and Radio Art

## EDITORIAL BOARD

J. L. McQuarrie      F. Gill      G. Deakin      P. E. Erikson      G. H. Nash  
G. E. Pingree      P. K. Condict      W. E. Leigh      E. A. Brofos      E. C. Richardson      F. A. Hubbard  
H. T. Kohlhaas, Editor

Published Quarterly by the  
**INTERNATIONAL STANDARD ELECTRIC CORPORATION**

Head Offices

41 BROAD STREET, NEW YORK, N. Y., U. S. A.

European General Offices

CONNAUGHT HOUSE, ALDWYCH, LONDON, W. C. 2, ENGLAND  
75, AVENUE DES CHAMPS-ELYSEES, PARIS (8e), FRANCE

G. E. Pingree, President      K. E. Stockton, Secretary      H. B. Orde, Treasurer

Subscription \$1.50 per year; single copies 50 cents

Volume IV

APRIL, 1926

Number 4

## CONTENTS

STOCKHOLM-GOTEBORG RAILWAY CABLE .....	199
<i>By I. Billing</i>	
7001 TYPE OF AUTOMATIC PRIVATE BRANCH EXCHANGE..	209
<i>By B. A. Turkhud</i>	
THE HAGUE TELEPHONE NETWORK .....	221
<i>By B. A. Turkhud</i>	
SWITCHBOARD CORDS.....	243
<i>By E. S. McLarn</i>	
TELEPHONE TRAIN CONTROL IN THE ARGENTINE REPUBLIC	253
<i>By C. F. Bulstrode Whitlock</i>	
DEVELOPMENT AND APPLICATION OF LOADING FOR TELEPHONE CIRCUITS.....	258
<i>By Thomas Shaw and William Fondiller</i>	

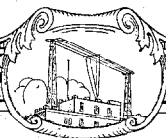

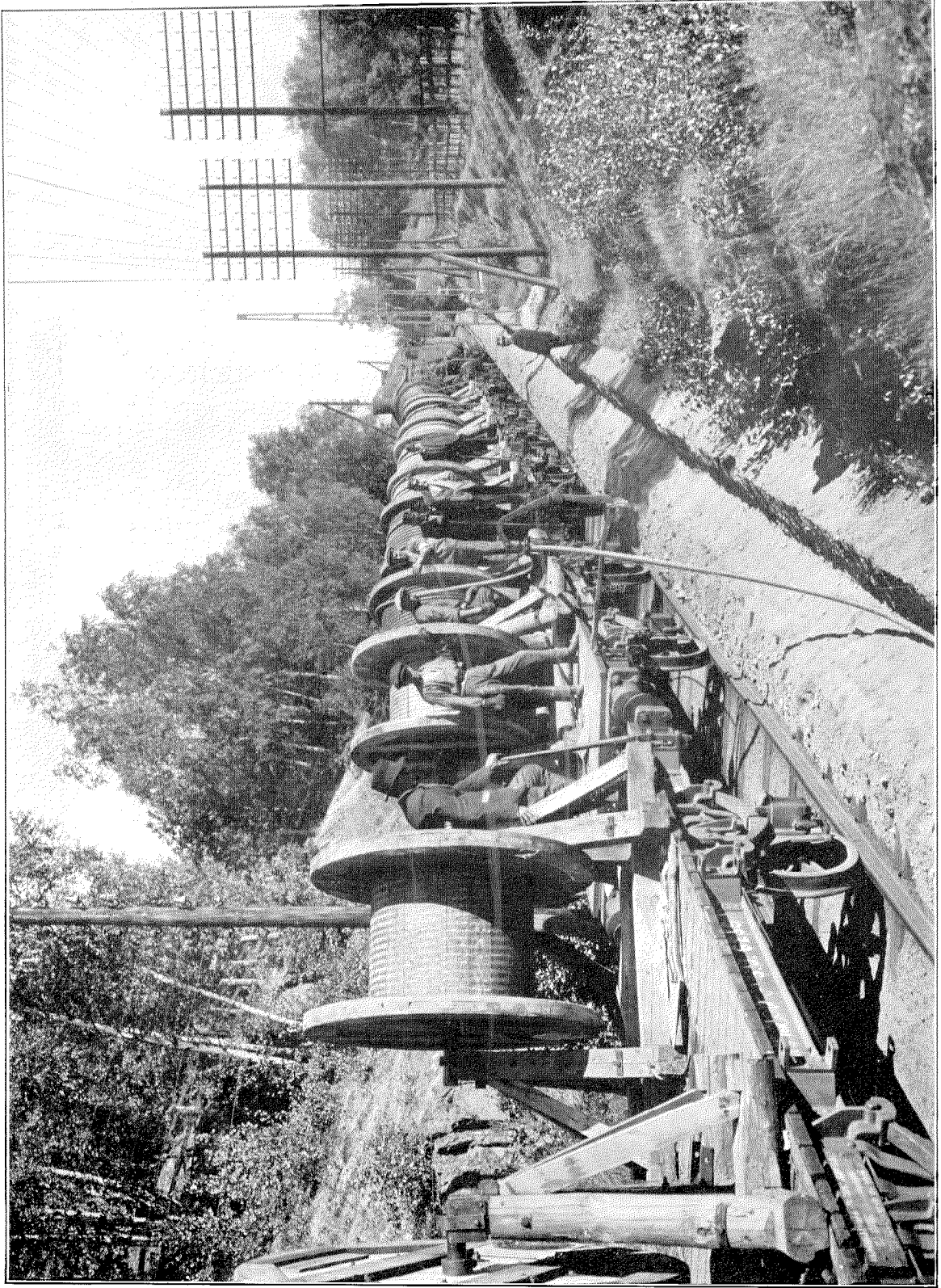

Stockholm—Göteborg Cable—Train Paying Out Cable

# Stockholm-Göteborg Railway Cable

By I. BILLING

*Byrådirektör, Royal Swedish State Railways*

## *Description of the Conditions under Which the Cable Is to Be Used*

THE electrification of the State Railway between Stockholm and Göteborg, a distance of 458 km., was started in 1924, and probably will be finished during the first half of 1926. In conjunction with this work a cable for the railway telephone and telegraph circuits has been installed alongside the track. It is the purpose of this paper to describe the cable and the conditions under which it will be used, as well as to outline the installation problems encountered and to summarize the tests applied both before and after installation.

In arriving at a decision on the railway cable project, there was available experience regarding interference between electric railways and telephone circuits, which was gained in Sweden partly from the 434 km. railway for conveying ore between Riksgränsen and Lulea, which belongs to the State Railways, and partly from the privately owned Nordmark-Klarälven Railway (150 km.).

The Kiruna-Riksgränsen railway, which forms part of the Riksgränsen-Lulea system is a single-track line operated by single-phase alternating current at a frequency of 15 cycles per second and a pressure of 16000 volts. Telephone circuits ran parallel to the trolley-wire at a distance of about 17 metres, and it was found that the statically induced voltage on the telephone circuits amounted to about 500 volts, and the electromagnetically induced voltage to 8–10 volts, per 100 ampere-kilometres in the trolley wire. The results of the measurements were reported upon on December 30, 1918, by the Committee working on the interference question; the Report<sup>1</sup> of the Committee, published at Stockholm, is dated 1919.

Upon the basis of experience gained, this Committee drew up certain rules for the reduction of interference from single-phase railways, and the

<sup>1</sup>(Undersökningar Rörande Svagströmsstörningar vid med Enfasström Drivna Elektriska Banor—Published at Stockholm 1919, by A. B. Svenska Teknologföreningens Förlag.)

railway-communication circuits on the Riksgränsen-Lulea line were constructed in general accordance with those rules.

It was found that the static charge on telephone-circuits so constructed was reduced from 500 volts to about 50 volts. The remanent disturbing voltage was still further reduced by means of a compensating circuit, strung on the poles supporting the trolley-wire. The electromagnetically-induced voltage on the telephone circuits, which had previously amounted to about 8 volts per 100 ampere-kilometres, was reduced to 0.2 volts per 100 ampere-kilometres.

This result was not as good as might have been expected, the reason being that the track transformers are to some extent short-circuited owing to the imperfect insulation of the rails from earth. On the Riksgränsen-Lulea route, the resistance of the earth and of the sleepers is comparatively high. In southern Sweden, on the other hand, where these resistances are low, the leakage currents from the rails would have been so great that the compensating effect of the track transformers on the magnetically induced voltage would have been almost nullified.

On the private railway, Nordmark-Klarälven, the method of connecting the transformers in an insulated return-circuit, strung along the tops of the poles supporting the trolley wire, was adopted. When the electrification of this line was completed in 1922, this arrangement was found to give very good results.

Meanwhile, the Swedish Parliament had decided in 1920 that the Stockholm-Göteborg railway should be electrified; but they stipulated, as a necessary condition for the electrification, that a satisfactory solution of the problems arising out of interference between the railway power-system and the Telegraph Administration's circuits, should be found. On this account, a Committee was appointed in the same year to prepare recommendations after examination of all data. During the period 1920–1922, this Committee carried out exhaustive researches both on the Riksgränsen-Lulea and the Nordmark-Klarälven lines. At the end of 1922, the

Committee arrived at its conclusions<sup>2</sup>, and amongst other satisfactory methods of avoiding interference, the following recommendations were made regarding single-phase electrification:

The most satisfactory method of avoiding power interference in the case of single-phase railways is to move the communication-circuits away from the power circuits—unless of course the communication-circuits are in specially constructed underground cables—to such a distance that, with properly arranged track transformers, the interference is reduced to an allowable value.

If the communication-circuits are in cable, the cable sheath should be well earthed, and should form a complete screen to the communication-circuits, especially where long distances are involved. In this respect, iron armouring should be more effective than simple lead covering.

It was decided that, for economic reasons, the Telegraph Administration's high-speed telegraph circuits would have to remain as earth-return circuits upon their removal from the railway. Consequently, decisions had to be arrived at with regard to the possibility of limiting the induced voltage to 15 or 20 volts as a maximum. The voltages likely to arise from short-circuits on the power system also had to be considered. The Committee came to the conclusion that satisfactory operation of telephone and telegraph circuits could be expected if the circuits were separated from the railway by at least 200 metres, and if the following condition were fulfilled:

"The railway power-circuit should be provided with an insulated return, with transformers so designed that, for each transformer-station, with the maximum expected load, the unbalance current multiplied by the length of circuit traversed should not exceed 300 ampere-kilometres for any load condition, or 1500 ampere-kilometres under short-circuit conditions. The former value corresponds to an induced voltage of 15 volts for a communication-circuit at 200 metres from the railway.

With double tracks, each trolley wire should be provided with compensating transformers.

The transformers should compensate at least 98% of a current of 0.2 ampere at 1000 cycles per second, when the transformers are not handling any other current.

The transformers should be placed not more than 3.0 km. apart.

The return-circuit should not be replaced by the track circuit in case of faults developing. The compensating-circuit should be used in cases where the communication-circuits cannot be moved to the above specified distances from the railway, and they should be arranged to give sufficiently low statically induced voltages. In such cases, arrangements should be made so that the trolley-wire and compensating-circuit can only be switched in or out simultaneously.

The single-phase supply circuits which will eventually be necessary along the railway should be constructed as insulated metallic circuits balanced both electrostatically and electromagnetically. To this end transpositions should be made at least every 10 km., in such a way that a whole number of circuit-sections are included. Such circuits should be erected in the immediate vicinity of the railway premises. If it is considered necessary to earth the neutral, the usual precaution should be taken to limit the effects of an earth fault.

The generators must be as free as possible from harmonics. The trolley-wire must be separated electrically from the generators by means of transformers, since the same freedom from harmonics cannot be obtained in other ways. The switching arrangements employed in the trolley-wire system should be so designed as to avoid short-circuits when faults are being located.

The maximum flux-density used in the transformers entering into the system must not be so high as to introduce harmful harmonics.

All locomotive motors should be as free as possible from harmonics, advantage being taken of any devices which may become available owing to improvements in design.

The trolley-wires should only be used for supplying current to the locomotives or to short distance lightly loaded local circuits which are not liable to interfere with neighboring communication-circuits.

<sup>2</sup>For Abstract of Report see "Teknisk Tidskrift"—Feb. 3, 1923.





current of 1 ampere through one line winding without the initial inductance being changed by more than 2%, or the coil being in any way damaged.

With regard to the types of circuits to be included in the cable, it was necessary that provision should be made for all the communication-circuits belonging to the railway. These had formerly been of open-wire construction. In addition, it was considered that the cable should provide a number of circuits associated with the electrification-scheme, as well as a suitable number of spare circuits.

It was decided also that, for the greater part of the route, the following should be included:

One circuit for recording the loads on the transformer stations.

Three block-signalling circuits.

Two Railway Telephone circuits with magneto ringing.

Two Telephone circuits, employing Western Electric Selectors.

One train Order Telephone circuit, with magneto ringing.

Four direct long-distance Telephone circuits.

Two direct short-distance Telephone circuits.

One Bell Telegraph circuit (Morse circuit with bell calling).

Three local Telegraph circuits (Morse).

Two circuits for Telegraph or as spares.

Besides this, on the 48 km. section Stockholm-Järna, the cable was required to provide the following additional circuits, for the Stockholm-Malmö line, which branches at Järna:

Four circuits, three for direct Telephone circuits, and one for a Telephone circuit with Western Electric Selectors.

The diameters of the conductors were so arranged that there should be seven circuits of 1.4 mm. diameter conductors, to be used for the load-recording circuit, the four direct telephone circuits, and the two circuits equipped with Western Electric selectors. The remaining circuits, comprising 18 pairs on the Stockholm-Järna section, and 14 pairs on the Järna-Göteborg section, were to be of 0.9 mm. diameter conductors.

Regarding the electrical characteristics of the cable, the following points were specified:

The conductor-resistance, measured with direct-current at 15° C., must not exceed 17.5 ohms per sq. mm. of cross-section per km. of wire.

The resistance unbalance between the two wires of a pair within a loading section must not exceed 1% of the resistance of one of the conductors.

The capacity between the two wires of a pair, measured with alternating current at 800 cycles per second, must not exceed 0.039 mf. per km., in any individual case, and the average capacity per km. for a cable length must not exceed 0.036 mf.

The capacity unbalance between any two adjacent pairs must not exceed, as an average for a length of about 448 metres, 100 mmf.

The capacity unbalance between any two pairs whatever must not exceed 250 mmf. in any instance.

With regard to crosstalk between the different circuits in the cable, it was specified that the crosstalk between any two circuits in the completed cable, measured on the sections Stockholm-Hallsberg, Hallsberg-Falköping or Falköping-Göteborg should not be worse than that corresponding to an attenuation of  $\beta_1=7.5$  (65 TU). For this test the circuits were to be closed with a resistance approximating to the characteristic impedance of the circuit. The above unbalances and crosstalk values were to be measured at 800 cycles per second.

Certain of the circuits intended for long-distance use were to be loaded. Six 1.4 mm. circuits were to be loaded over the whole distance between Stockholm and Göteborg, whilst eight circuits of 0.9 mm. conductors between Stockholm and Järna, and four between Järna and Göteborg were also to be loaded. The loading was to be such that the mean attenuation-constant of the 1.4 mm. circuits should not exceed 0.011 per km., and for the 0.9 mm. circuits  $\beta=0.022$  per km. (*i.e.*, 0.096 and 0.191 TU per km. respectively). The angular velocity was not to be less than  $\omega_0=16400$  radians per second (2610 cycles per second). The mean characteristic impedance of the circuits was not to exceed 1460 ohms for 1.4 mm. conductors, and 1660 ohms for 0.9 mm. conductors, when measured with 1 milliamperes at 800 cycles per second.









In subdividing the supply of the cable, the following decisions were arrived at in order that the above values might be obtained.

For the length of 343 km. of cable between Stockholm and Falköping—in which cable of Swedish manufacture, installed and loaded by the Western Electric Company, was used—the loading-coil spacing was to be 2671 metres, and the loading coil inductance and effective resistance, measured with 1 milliampere at 800 cycles per second, were to be 0.175 henry and 11.4 ohms respectively; the same values measured at 1800 cycles were specified as 0.177 henry and 16.0 ohms. The direct-current resistance was to be 8.2 ohms.

For the length of 115 km. of cable between Falköping and Göteborg, the loading coil spacing was to be 2200 metres and the self-inductance and effective resistance of the coils, measured at 800 cycles and 0.5 milliamperes, were specified as 0.177 henry and 10.5 ohms. The effective resistance at 1900 cycles per second was not to exceed 17.5 ohms.

Since certain of the telephonic circuits were intended to work with repeaters, limits were placed to ensure uniformity of the constants of the cable. According to the Western Electric methods, it was specified that the singing-point, over the range 400 cycles per second to 1800 cycles per second, should not be less than 20 miles of standard cable. The layups adopted for the three different types of cable are shown in Figure 3. (A, B and C).

-  DENOTES GREEN & WHITE PAPER WRAPPING.
-  DENOTES BLACK PAPER WRAPPING.
-  DENOTES GREEN PAPER WRAPPING.
-  DENOTES WHITE PAPER WRAPPING.
-  DENOTES RED PAPER WRAPPING.
-  DENOTES BLUE PAPER WRAPPING.

Key to Figure 3

**Installation of the Cable, Loading Coils, Etc.**

Most of the trenching work was carried out with a digging machine of American manufacture, shown in Figure 4. This was drawn by a locomotive, which also provided compressed air for manipulating the plough-share. The plough

made a trench 0.6 metres deep. Where, on account of the character of the ground, the digging machine could not be used, the trench was

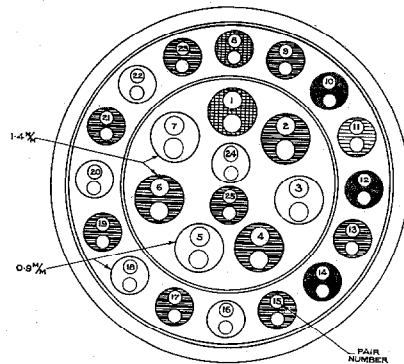

Figure 3a—Cross Section of Cable, Stockholm-Jarna Section

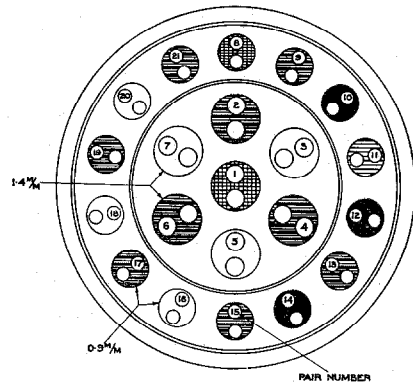

Figure 3b—Cross Section of Cable, Jarna-Falköping Section

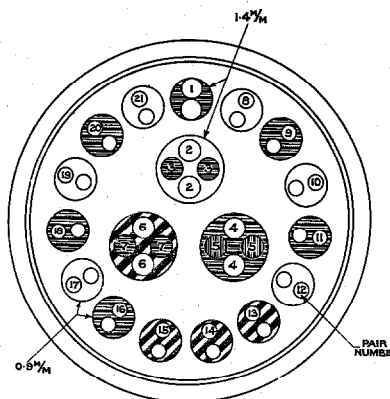

Figure 3c—Cross Section of Cable, Falköping-Göteborg Section

dug by hand. This was the case where the trench had to be dug more than 1.9 metres from the track.

The laying was carried out by a special train, in such a manner that the cable was unrolled from the drums, and laid directly in the trench, while the train was driven forward at suitable speed. (See Frontispiece). In certain parts of the railway-yards and elsewhere, when it was not possible to lay the cable from the train, it had to be carried out and laid by hand. At all joints,

On those parts of the route where it was possible to lay the cable at the required depth of 0.6 metres, no further protection was, as a rule, afforded. An exception was, however, made at road and railway crossings, where a protection of angle-iron or of iron pipes was provided. Similarly, an iron protection was laid over the cable where it was less than 0.6 metres deep, or



Figure 4—Trenching Machine at Work

branching points and loading points, an extra loop of cable was laid, so that the jointing work could later be carried out at a distance from the track, while traffic was in progress, without risk to the personnel. Simultaneously with the laying, or immediately afterwards, check measurements were made of the cable lengths, and the positions of the loading points were decided. On the Falköping-Stockholm section, six cable-lengths were laid per loading section, and three random-joints and two test-joints were made per loading section. On the Falköping-Göteborg section, five cable-lengths per loading section were used, and the conductors were jointed straight through, after which the balancing was carried out at the loading points by condenser balancing methods.

where it lay in macadam ballast. In the latter case impregnated planks were laid underneath the cable. On bridges or culverts, the cable was protected by iron pipes, split iron troughing, or by rails, and it was securely fastened.

At water crossings, such as the canals at Töreboda and Södertälje, and at the viaducts at Liljeholmen and Stockholm, cable having an additional layer of 5.4 mm. iron wire was used, for example at Södertälje. On the Stockholm-Falköping section, the loading coils were installed in chambers of concrete. In the upper part of the chambers, a convenient space for carrying out the jointing work was available.

After the installation of the loading coils, the top of the chamber was closed by a lid of impregnated wood, and the whole was covered with

ballast. On the Falköping-Göteborg route, no such manholes were provided: the loading-coil cases were buried directly in the ground, and covered with planks or sleepers, and finally with ballast. Occasionally it was necessary to make a concrete foundation under these cases, or to blast a chamber for them in rock.

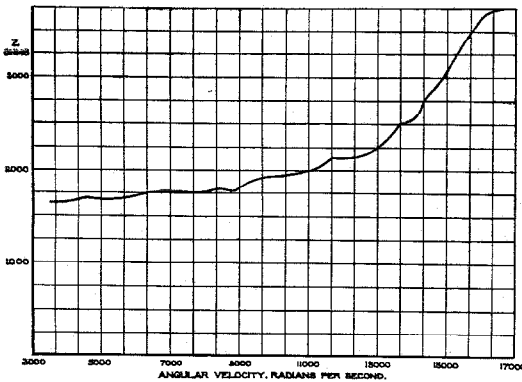

Figure 5—Impedance Curve for 1.4 M/M Circuit, Falköping-Göteborg Section, Pair No. 5

The cable was led into all stations and connected to terminal boxes. In the Stockholm-Falköping section, one box was used on each side, while on the Falköping-Göteborg section a combined box was used for terminating the two cables. At the houses of the station-masters, plate-layers, and others, a few circuits were brought out and terminated. At these points T-joints were made, and terminal boxes were used.

On the whole line between Stockholm and Göteborg, no fewer than 72 stations and 306 branch points occur. The total number of loading points is 181, and there are 895 jointing boxes. The location of the cable is marked out with special markers of cast iron, anchored in the ballast. Such markers are placed at all joints and branching points, also at loading points where necessary, and at railway crossings, in which case a marker is placed on either side of the track. In railway yards, a marker is placed at about every 100 metres.

On account of the very cold Spring, the laying of the cable, which was carried out during 1924, could not be commenced before May 5th. The first cable-length was laid at Falköping towards Stockholm on May 5th, and on May 12th cable

laying was started from Falköping towards Göteborg. The cable laying proper was finished on the latter line on August 18th, and on the Falköping-Stockholm section on October 20th. The complete installation, including the testing, was finished by September 18th, for the Falköping-Göteborg section, and by December 4th for the Stockholm-Falköping section.

After the tests, the railway took over the installation, and installed the telephone and telegraph apparatus.

### Results

Final tests on the installed cable were carried out as the work was completed. The Falköping-Göteborg cable was tested between September 16th and 18th, the Falköping-Hallsberg cable between September 23rd and October 2nd, and the Hallsberg-Stockholm section on October 23rd and between November 15th and December 4, 1924.

The results of these tests, together with the electrical data of the cables are summarized in the table on the opposite page.

Representative curves of Impedance and Attenuation are shown in Figures 5 and 6.

From the results obtained in the final tests, it was seen that the transmission properties of the circuits were considerably better than had been expected. According to the programme which had been prepared, it had been expected that the attenuation-constant for the 1.4 mm. circuits would be  $\beta = 0.011$  per km. (0.096 TU per km.). The total attenuation between Stockholm and Göteborg (458 km.) would then have been about

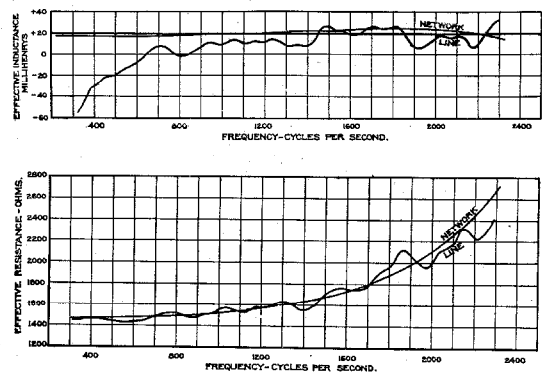

Figure 6—Impedance Curves for 1.4 M/M Circuits, Hallsberg-Falköping Section, Pair No. 7. Looped at Falköping to Pair No. 6

	Frequency Employed	Measured Value		Guaranteed Value	
		1.4 mm.	0.9 mm.	1.4 mm.	0.9 mm.
<i>Falköping-Göteborg Section</i>					
Resistance per loop km. (ohms)					
Non-loaded <sup>1</sup>	0	20.8	50.4	22.8	55.0
Loaded <sup>1</sup>	0	23.8	52.8	—	—
Insulation resistance, in megohms per km. of wire					
Non-loaded	0	61000	85000	1000	1000
Loaded	0	66000	80000	—	—
Capacity mf. per km.	800	0.0303	0.0308	0.0345	0.0345
Attenuation Constant					
$\beta$ per km.	800	0.009	0.0176	0.011	0.022
TU per km.	800	0.078	0.1525	0.096	0.191
Characteristic Imp. Z.	800	1690	1660	$\geq 1600$	$\geq 1600$
Natural Frequency $\omega_0$		<sup>2</sup> 18100	—	$\geq 16500$	$\geq 16500$
Crosstalk					
$\beta_1$	800	10.0	10.0	$\geq 8.0$	$\geq 8.0$
TU	800	86.5	86.5	$\geq 69.4$	$\geq 69.4$
Impedance Uniformity	800	550/1000	520/1000	$\geq 700/1000$	$\geq 700/1000$
<i>Falköping-Hallsberg Section</i>					
Resistance per loop km.					
Non-loaded <sup>3</sup>	0	22.0	52.6	22.8	55.0
Loaded <sup>3</sup>	0	24.4	55.0	25.8	58.0
Insulation resistance, in megohms per km. of wire					
Non-loaded	0	2200	1900	1000	1000
Loaded	0	1900	2250	—	—
Capacity mf. per km.	800	0.0306	0.0245	0.036	0.036
Attenuation Constant					
$\beta$ per km.	800	0.009	0.018	0.011	0.022
TU per km.	800	0.078	0.155	0.096	0.191
Characteristic Imp. Z.	800	1500	1665	<sup>4</sup> 1460	<sup>4</sup> 1660
Natural Frequency $\omega_0$	800—3050	>16400	19200	16400	18700
Crosstalk $\beta_1$	800	9.6	9.6	7.5	7.5
"Singing Point" in TU	400—1800	27.8	—	18.9	—
<i>Hallsberg-Stockholm Section</i>					
Resistance per loop km.					
Non-loaded <sup>5</sup>	0	21.8	52.2	22.8	55.0
Loaded <sup>5</sup>	0	24.2	54.7	25.8	58.0
Insulation resistance, in megohms per km. of wire					
Non-loaded	0	>40000	>40000	1000	1000
Loaded	0	40000	40000	—	—
Capacity mf. per km.	800	0.0306	0.0245	0.036	0.036
Attenuation Constant					
$\beta$ per km.	800	0.009	0.017	0.011	0.022
TU per km.	800	0.078	0.148	0.096	0.191
Characteristic Imp. Z.	800	1500	1680	<sup>6</sup> 1460	<sup>6</sup> 1660
Natural Frequency $\omega_0$	800—3050	16400	>18700	>16400	18700
Crosstalk $\beta_1$	800	9.0	9.0	7.5	7.5
"Singing Point" in TU	400—1800	26.5	—	18.9	—

<sup>1</sup> at +10° C.<sup>2</sup> calculated value<sup>3</sup> Reduced to +15° C. Measured at about +10° C.<sup>4</sup> With 5 $\frac{5}{8}$  variation.<sup>5</sup> At about +2° C. to +10° C.<sup>6</sup> The high values for insulation resistance are attributable to the fact that the rooms in which the cable terminals are located were heated, which was not the case on the Falköping-Hallsberg section.

$\beta_1 = 5.04$  (43.7 TU). Taking into account the losses introduced by the terminal apparatus at Stockholm and Göteborg, the total attenuation was calculated as  $\beta_1 = 5.3$  about (46.0 TU). Upon this basis it was planned to use three repeaters on the Stockholm-Göteborg circuits, each repeater giving a gain of  $\beta_1 = 1.3$  to 1.4 (11.3 to 12.2 TU). The resultant overall attenuation would then be  $\beta_1 = 1.1$  to 1.4 (9.5 to 12.2 TU).

The value of  $\beta$  per km. which was actually obtained was as low as 0.009, (0.078 TU per km.) and the attenuation on the circuits between Stockholm-Göteborg was therefore  $\beta_1 = 4.15$  (36.0 TU) or, allowing for local losses,  $\beta_1 = 4.4$  (38.2 TU) at most. This fact allowed of a reduction in the number of repeaters from three to two. If the gain of each of these two repeaters were  $\beta_1 = 1.3$  to 1.4 (11.3 to 12.2 TU) the overall loss would be  $\beta_1 = 1.6$  to 1.8 (13.9 to 15.6 TU). It was therefore decided that two repeater stations, located at Katrineholm and Falköping, should be used, instead of the three stations originally planned at Järna (or Flen), Hallsberg and Falköping. Tests made after the installation of the repeaters showed that, with the repeaters giving a gain of  $\beta_1 = 1.4$  (12.2 TU) the overall attenuation between Stockholm and

Göteborg, excluding local losses, was  $\beta_1 = 1.3$  (11.3 TU).

Further, the lower attenuation resulted in improved transmission on the 1.4 mm. circuits which were planned to be used within a traffic section without repeaters (circuits equipped with selectors). The longest of these circuits, between Stockholm and Hallsberg (200 km.) has a total attenuation of only  $\beta_1 = 1.8$  (15.6 TU) instead of the calculated value of 2.2 (19.1 TU). This makes it possible for the circuits to be extended by other circuits. Similar improvements were also obtained in the local 0.9 mm. circuits, which were only expected to be used for distances up to 90 km., but which can now be used up to 125 km. without repeaters.

### ***Interference Tests***

Although complete interference tests on the whole of the route have not yet been carried out, a sufficient number of measurements have been made to show with certainty that the circuits in the railway telephone-cable will be perfectly satisfactory. These measurements also indicate that if the State telephone-circuits are separated by at least 200 metres from the electric railway, they will not be subject to any disturbance therefrom of sufficient magnitude to render the circuits "uncommercial".

---

# 7001 Type of Automatic Private Branch Exchange

By B. A. TURKHUD

*Bell Telephone Manufacturing Company, Antwerp*

**I**N view of the extensive adoption of the 7001-Type Automatic Private Branch Exchange (P.B.X.), this paper describes briefly the apparatus involved, and the means adopted for dealing with "Local", "Central Office", "Tie-line", "Conference", "Code" and "Fire Service" calls, and in addition outlines the principles in accordance with which automatic selection is secured.

## *Apparatus*

The 7001 Type Automatic P. B. X. is made up of units of 35 line capacity and is economical for installations varying from 20 to 70 lines. The units are portable and self-contained so that the work of installation is reduced to a minimum.

The board operates on a normal battery potential of 36 volts and gives efficient service on substation loops varying from zero to 500 ohms and insulation resistance of 20,000 ohms wire to wire. The substation lines are ordinary two-wire circuits. The subsets are of the standard pattern as furnished on automatic "Central-Office" lines, and the dials are regulated to the normal speeds required at such main-line instruments. Each fully equipped unit has capacity for 5 connection-circuits. By assuming a holding-time of 1 minute for a local call, these 5 channels will carry 105 calls in the busy-hour with a delay of 1 call per 100. With 4 circuits the call-carrying capacity reduces to 75, whilst with 3 circuits it becomes 50. These connection-circuits are not held during conversation on either "Central Office", "Tie-line" or "Conference" calls, and this traffic does not, therefore, cause congestion of "Local" calls.

Figure 1 shows the self-supporting unit totally enclosed by side-panels and doors. Its overall height is 5'-10-5/16" (1785 mm.), its width 2'-9" (838 mm.) and its depth 1'-2 1/2" (368 mm.) The double hinged doors at the front and back give easy access to the apparatus and wiring as will be apparent from Figures 2 and 3 which show the front and rear of fully equipped 35 and 70-line units respectively.

At the top of the unit (Figure 2) are four mounting plates providing accommodation for a maximum of 40 "line" and "cut-off" relays. To the left of these are the interference relays

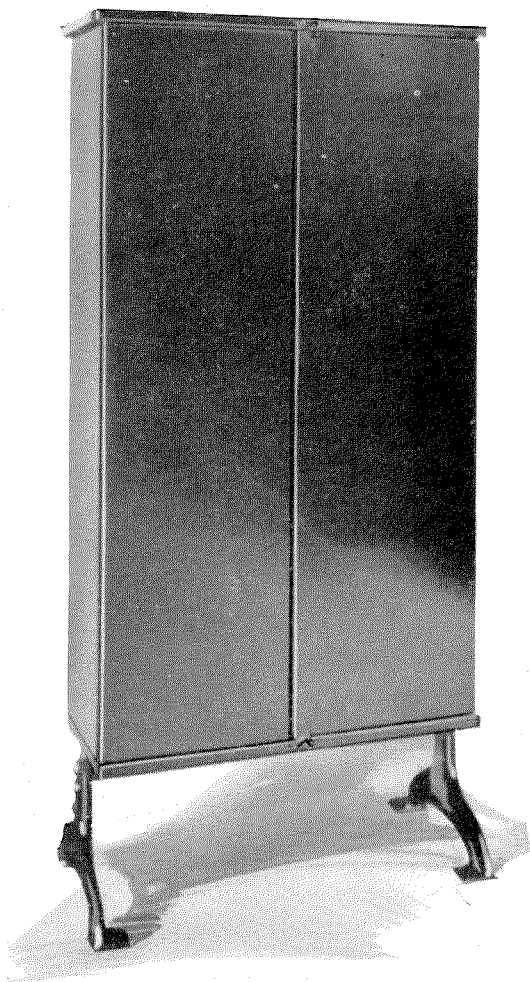

Figure 1—No. 7001—Automatic PBX—Closed

which prevent trunk finders from hunting a line during such times as the attendant is directing an incoming "Central Office" call to the called line. Below the interference relays is the fuse-panel equipped with the regular alarm type fuse.

Below the "line" and "cut-off" relays are mounted resistances associated with the cut-off relays and also the line-finder common starting

relays. The top-row switches are the line finders and the bottom-row are the final selectors. The space between these two rows is reserved for supplementary finals required for a 70-line installation. These supplementary finals furnish the links between the two 35 line units composing the 70-line installation. The controlling sequence switch and relays, forming part of the connecting circuit, are mounted below their associated selectors. At the bottom of

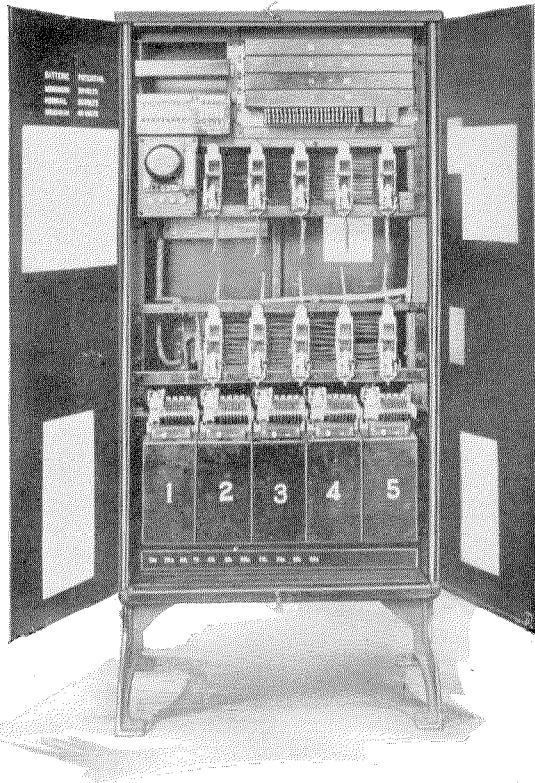

Figure 2—35-Line Unit—Front View

the unit is a mounting plate for the common relays. Access to the bank wiring is obtained by swinging the connecting rack (Figure 3) outward.

The principles governing the design of the board are illustrated in the typical junction diagrams (Figures 4 and 5). Figure 4 relates to a 35-line unit and Figure 8 to a 70 line unit. The essential difference between these two units, apart from the increased capacity, consists in the provision of supplementary selecting switches. It will be seen, from Figure 4, that each connecting circuit is composed of three

components, a hunting switch or line finder, a selecting switch or final selector and the controlling and switching apparatus.

The line finder and final selectors are self-propelling switches actuated by a ratchet and pawl mechanism under the control of an electromagnet; a line finder switch is illustrated in Figure 6. Apart from slight constructional differences between the two switches, the fundamental distinction is that whereas the line finder has no normal or home position, in the selector a starting terminal or home position is necessary because this switch is controlled by the dial impulses sent in by the substation.

Both types of switches are made up of a stationary part called the "arc" and a rotating member known as the "brushes." In the line finder, the arc is composed of 8 horizontal rows of 22 flat terminal pins insulated from each other and from the pins in adjacent rows. The rotor is mounted at the centre of this arc and is furnished with 8 brushes, arranged in two groups of 4 displaced 180° relatively to each other, by means of which rubbing contacts are made with the terminal pins in the arc. The even rows of terminals are "wiped" by one set of brushes and the odd rows by the other set. This switch therefore provides a total of 44 positions, 22 of which are accessible to each set of brushes.

The selector-arc is provided with 6 terminal rows, in two of which there are 22 terminal pins and in the others 21. The 6 rotor brushes, making contact with these terminals, are mounted one above the other without any relative angular displacement and are grouped electrically into two independent sets. Only one set at a time is connected up during a call.

The controlling and switching apparatus individual to a connection circuit consist of a number of relays, condensers, resistances, etc., and a step-by-step horizontal type sequence switch. The sequence switch, which is illustrated in Figure 7 is a combination of the sequence switch previously illustrated in "Electrical Communication"<sup>1</sup> and the ratchet and pawl driving mechanism used in the step-by-step type of switch. The ratchet wheel is provided with the necessary number of teeth to

<sup>1</sup>"No. 7A Machine Switching System." G. Deakin. *Electrical Communication*, Vol. III, No. 3.

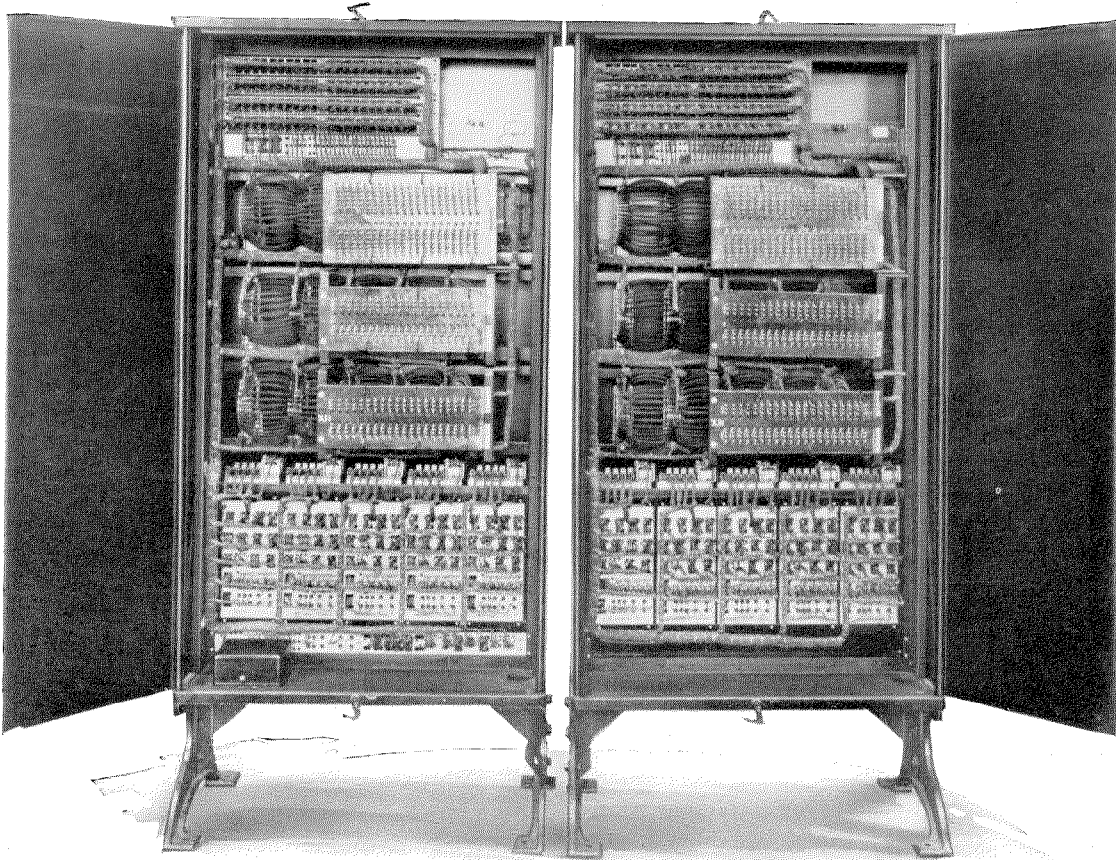

Figure 3—70-Line Unit—Rear View

enable the switch to be stopped in any one of 36 positions as called for by the several circuit combinations. In the circuit drawings these positions are marked 1, 1½, 2, 2½ . . . 17½, 18, 18½.

### Local Calls

To make a local call, the substation receiver is lifted and the dialling tone listened for. The line relay attached to the line is energized and closes a circuit which causes all free line finders to rotate in search of this calling line. The line finder which picks it up, marks its test terminal "busy." The other free line finders are then stopped. The substation receives the dialling tone and dials the two digits corresponding to the number of the required station. The selection proceeds, in the manner to be described later, and the final selector is brought to rest

on the terminals of the required line. If the called station is free, interrupted ringing is applied automatically to the called set and the calling station receives a ringing signal. When the call is answered, the ringing is tripped and conversation can take place. On the release

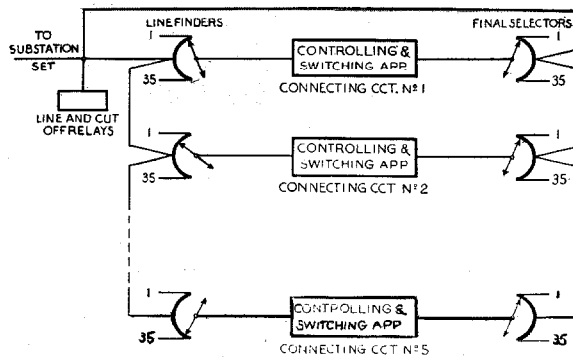

Figure 4—Junction Diagram 35-Line PBX Arranged for Local Calls Only



of the connection, the selector switch is returned to its home position after which the circuit is made available to other calls.

**Central Office Connections**

Central Office traffic can be provided for in a variety of ways depending on the method of

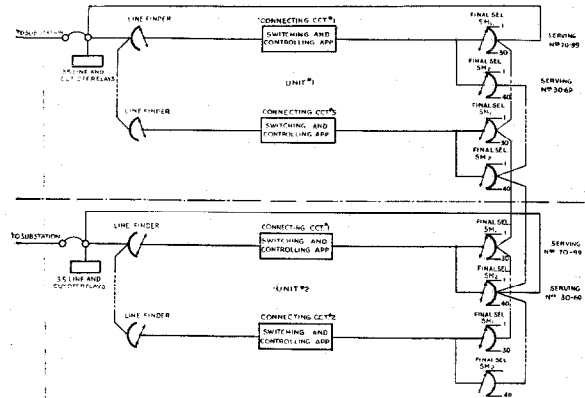

Figure 5—Junction Diagram 70-Line PBX Arranged for Local Calls Only

handling calls, on the number of trunks, on the volume of the traffic and on the number of substations entitled to receive and originate such calls.

The method of handling calls can be classified under three heads.

This is known as—Attended “IN” and “AUTO” out.

- (c) Incoming and outgoing calls completed automatically i.e. Auto “IN” and “OUT.”

Of these three methods (a) and (b) are most commonly adopted. The arrangement (c) which has been provided for a Government Department in New Zealand, is applicable only to areas where the No. 7-A Machine Switching System is in operation.

**Attended “In” and “Out”**

When two or three exchange lines are provided and Central Office calls are few, a small “pony” board is usually installed. This board, which is obtainable for use either with a magneto or a common battery Central Office, is provided with the necessary jacks for the trunk lines and also for such substations as are entitled to receive or make calls to the Central Office. A number of patching cords are furnished and the attendant’s set consists of a standard instrument. The signalling and bridging apparatus required in connection with the trunks are placed in the trunk circuit. Such a board can be served conveniently by a clerk, porter or other employee along with other duties.

When the Central Office trunks are numer-

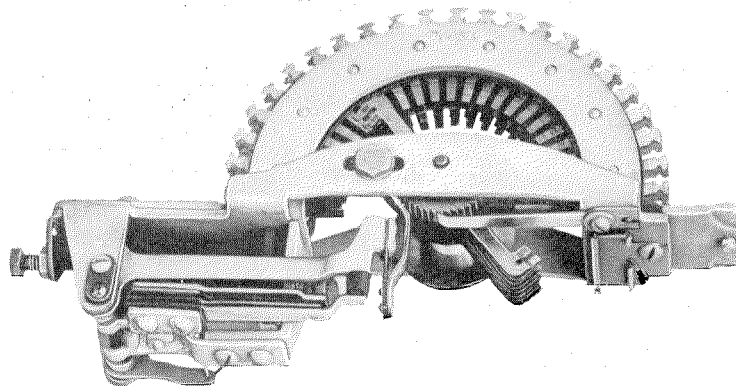

Figure 6—Step-by-Step Line Finder Switch

- (a) Incoming and outgoing calls to be completed by the attendant. This method is referred to as Attended “IN” and “OUT.”
- (b) Incoming calls from Central Office completed by attendant, outgoing calls completed automatically; that is to say, without intervention of the attendant.

ous and the traffic more intense, a standard lamp signalling attendant’s cabinet similar to that shown in Figure 8 is provided. Such a board requires a full time operator and is furnished with all the facilities usually obtainable in manual equipments. Lamp supervision is provided and facilities for through signalling from

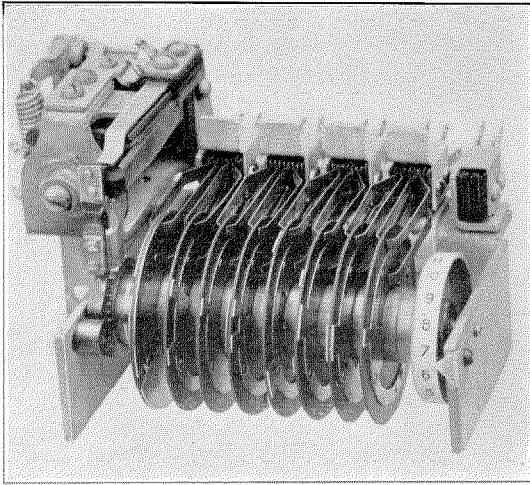

Figure 7—Step-by-Step Sequence Switch Individual to Each Connection Circuit

the substation to the Central Office can be added if required.

For some installations on the continent, it is stipulated that means shall be available for limiting Central Office facilities to certain substations, that is to say, the substations are divided into two categories, unrestricted stations with full facilities and restricted stations with telephone facilities limited to local calls. The unrestricted stations are provided with lamps and jacks on the attendant's board as in manual practice, but the restricted stations are not so provided. All stations, however, can call the attendant by dialling the number allotted, but the restricted circuits are terminated on a key, thus preventing any possibility of the calls being extended.

An additional facility permits the attendant to bridge across a local automatic connection for the purpose of offering a Central Office or a toll call.

Finally, in the case where the Central Office is automatic, a repeating coil circuit is provided in order that conversation may be carried on even if the attendant should forget to restore the dialling key after making a call.

A typical junction diagram of an installation providing "In" and "Out" Central Office service is shown in Figure 9.

#### **Attended "In" Automatic "Out"**

"Automatic out" service gives a substation direct access to the Central Office on dialling the digit "O".

The facilities provided and the method of operation on incoming calls is substantially the same as when attendance is provided for all calls. The modifications to the circuit consist mainly in the provision of trunk "busy" signals and in arrangements for making the trunk "engaged" to the local automatic switches when the attendant originates or answers a Central Office call.

When "attended in" and "automatic out" service is provided, it is possible to arrange for 3 classes of substations.

- (1) Unrestricted substations with full facilities.
- (2) Supervised substations which may receive Central Office calls and originate such calls *via* the attendant's board.
- (3) Restricted substations debarred from Central Office service.

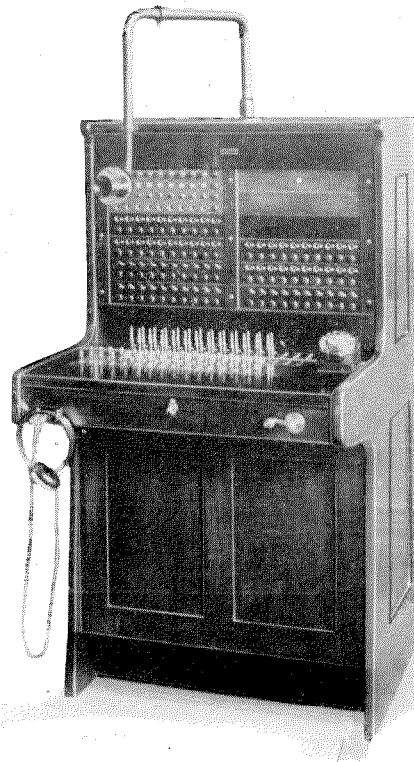

Figure 8—Attendant's Cabinet

All stations in category (1) are provided with jacks for incoming calls and they obtain access to the Central Office by dialling "O." Those in (2) are furnished with jacks and lamps; for Central

Office connections they signal the attendant by dialling "O." Substations in (3) are not provided with jacks but they can reach the attendant over a key-ended circuit by dialling a regular number. If desired, a lamp-lighting

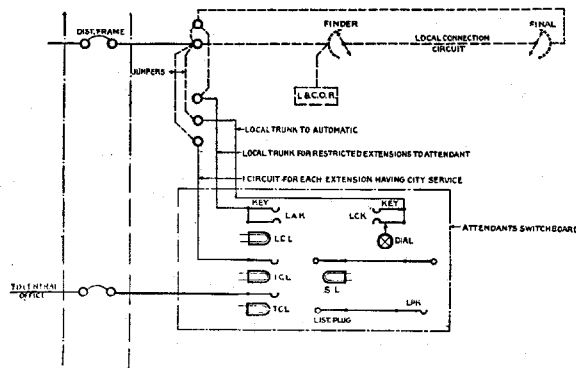

Figure 9—Junction Diagram 35-Line PBX with Attended "In" and "Out" Central Office Service

finder can be furnished, in which case these restricted substations can also reach the attendant by dialling "O."

Figure 10 is a typical junction diagram of 70 line units equipped for attended "IN" and mixed

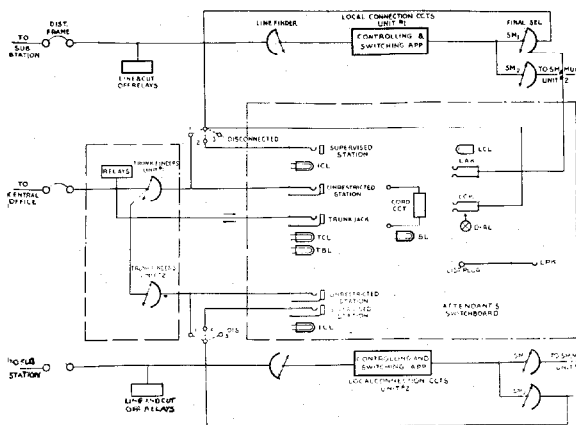

Figure 10—Junction Diagram 70-Line PBX with attended "In" and Mixed "Out" Service

"OUT" junction service. In cases where there are no substations in category (2) the lamps and jacks for the supervised substations are not required.

The principle governing the design of the automatic out-junction circuits consists essentially in marking the calling substations line and directing to it a free trunk finder associated with a Central Office trunk. The marking is done by

means of the final selector when the substation dials the digit "O" and consists in the application of a test potential to the test terminal of the substation line in the line finder and trunk finder arcs. At the same time a common starting circuit is closed which causes all free trunk finders to rotate in search of the calling station. When this station is picked up, the line is extended over the line-finder and trunk-finder arc multiple to the Central Office, and the remaining trunk-finders are stopped. The local connection circuit is then released and becomes available for other calls.

This arrangement results in economy in the P. B. X. connection circuits, since these circuits are held for a short interval only on Central Office calls, after which they again become available for traffic.

To guard against difficulties caused by slow clearing at the Central Office, provision is made for holding the trunk busy until the connection is severed there.

For substation calls originating at a time when all trunk finders are busy, a busy-tone is provided as a signal for release and subsequent trial.

To simplify Figure 10, only one substation line per unit is shown, but the connection for the various categories of stations at the line-finder arc are indicated by "1", "2" and "3." The remaining connection represents the local calling circuit—LCK—set apart for the attendant and by means of which any station on the P. B. X. can be reached by dialling.

The junction unit required for housing the trunk line-finders and their associated relays is illustrated in Figure 11, which is a front view of

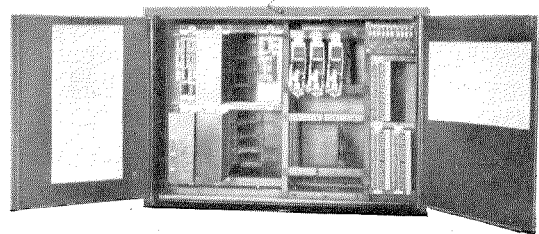

Figure 11—Junction Unit for Trunk Line Finders and Associated Apparatus—Front View

the equipment and shows the apparatus required for 3 Central Office trunks. This unit is suitable for a maximum of 8 trunks, as will be

seen from the drillings, and is for use with a 35 line P. B. X. The unit itself is complete with a small fuse panel, terminal strips, relays, etc., and the technical information required for maintenance and adjustment is pasted on the hinged doors. It may be mounted on top of the local unit, an arrangement which permits of a very simple cabling scheme, and shortening of the multiple cable between the trunk and line finders.

The scheme just described and illustrated in Figure 10 pre-supposes sufficient Central Office traffic to justify a full-time operator. However, it is possible for a clerk or other employee to operate a board in addition to his or her regular duties. In this case, a unit known as an "attendant's box" can be employed. This is so designed that when there is an incoming Central Office call, the attendant can direct the finder associated with the trunk to the wanted substation. This direction of the trunk-finder can be brought about either through the agency of a key associated with that substation line or by dialling the wanted station. The attendant after directing the call may converse with the called station before allowing the call to go through. After the connection is completed, secrecy is assured; however, the substation can recall the attendant by "flashing" the switch-hook which then opens the lock and permits the attendant to enter the circuit.

The attendant's box circuit may be operated by means of keys or a dial. In the former case, a key is provided for each substation entitled to receive Central Office calls, the depression of this key marking the terminal for the trunk finders. In the latter case, the attendant is provided with a switch combination consisting of a selector and line finder. The selector is directed to the terminals of the substation by means of a dial and it marks that substation for the attendant's line-finder and also for the trunk-finder. As soon as the call is put through, the attendant's switch combination is available for directing other incoming calls. In practice this switch combination is provided in duplicate as a reserve.

Figure 12 shows an attendant's box with a dial designed for a maximum of 8 Central Office trunks; the equipment shown is for 3 trunks only. Each trunk is furnished with a trunk listening key LTK, a release and dialling key

DK (used in exceptional cases), a trunk calling lamp TCL, and a trunk busy lamp TBL. The attendant's switch circuit is provided with a calling key CK, a supervisory bridging key SBK, a listening key LK, a special reply key SRK, a break down key BDK and a common pilot lamp CBL.

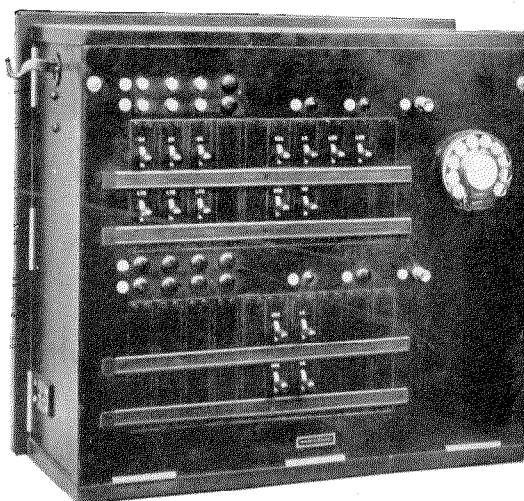

Figure 12—Attendant's Box with Dial

The method of operation is as follows: on the arrival of a call TCL lights, the attendant throws the corresponding key LTK, lifts the receiver and obtains the necessary particulars. The operation of LTK causes the trunk busy lamp TBL to light and TCL to go out. The attendant now throws the calling key CK, lamp CBL lights and on seeing this the attendant dials the wanted number; if the line is free, ringing is applied. When the called station replies, the trunk finder associated with the operated LTK key rotates to the terminals of the called substation's line. When the line is picked up, pilot lamp CBL is extinguished and the attendant then restores CK and LTK. The substation having answered, TBL is extinguished. Meanwhile, the attendant's selector switch returns to normal and is available for other calls.

If the attendant is doubtful whether the called substation can deal with the enquiry or if it should be transferred to another number, the keys SBK and CK are depressed, after which the connection is set up, by means of the dial.

The depression of key SBK prevents the trunk finder from rotating in search of the line when the called station answers. The attendant is bridged across the local circuit over the line finder switch and if satisfied that the call is for this station, restores SBK, thus permitting the trunk finder to pick up the line. Lamp CBL is then extinguished and LTK can be restored.

In the event of the substation being busy on the arrival of a toll connection, the attendant can offer a call. If the substation is talking on a local connection this can be broken down by depressing a break-down key BDK. The entry of the attendant on a busy connection is heralded by a warning tone. In the case when the substation is held on an incoming Central Office call this breakdown is not effective. In such a case, the attendant asks the substation to "flash his switchhook" thus causing the TBL and TCL

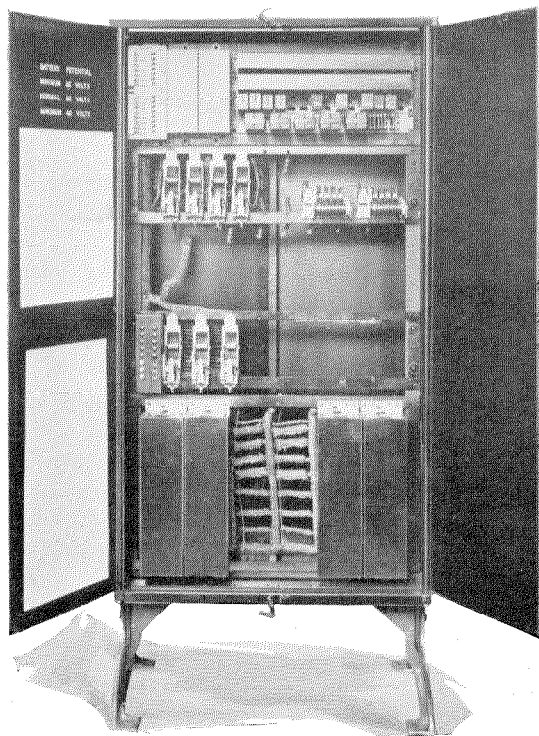

Figure 13—Junction Unit Associated with Attendant Box

lamps to light, after which the release key DK is depressed and the substation is made free for the toll call.

If a substation is slow in answering an incoming call and the attendant wishes to make use of

the switch to extend another incoming call, the special reply key SRK is thrown. The depression of this key reproduces the conditions of an answering substation and allows the trunk finder to rotate to the line, after which CBL is extinguished and the attendant restores LTK. Until the called substation answers, the TBL lamp will glow. If the Central Office should clear before the substation answers, release is automatic.

An incoming Central Office call to one substation can be transferred to another by flashing the switchhook, thus causing the TCL and TBL lamps to light. The attendant can then listen in by throwing the associated key LTK, the calling lamp TCL being extinguished but the trunk busy lamp TBL remaining lighted. Connection to the other substation is completed by the attendant's depressing key DK. The Central Office connection is held, but the original local connection is released.

Figure 13 shows the attendant's switch unit with capacity for 8 incoming trunk circuits and 2 attendant's switches. The relays at the top of the unit form part of the attendant's switch-circuit; associated selector line-finder and sequence-switches are mounted immediately below. The equipment shown is for a 35 line local unit. If the local unit is 70 lines, two additional selectors are required.

Below these switches are mounted 3 trunk line finders and below these are the relays associated with the trunk circuits.

### *Automatic "In" and "Out"*

This method of dealing with Central Office calls is applicable only to automatic Central Office areas served by the 7-A Machine Switching System, inasmuch as it requires the provision of special final selectors in the Central Office. Each such final can be made to serve 10 independent automatic P.B.X. installations allowing to each about 20 extensions. Where one level will not suffice for a P.B.X. installation, two or more levels, not necessarily adjacent, may be assigned to the P.B.X. The regular exchange numbers corresponding to the particular level or levels are then allotted to the P.B.X. substations which are to be listed in the directory.

### Tie Line Service

By tie-line service is meant direct junction service between two or more private branch exchanges. Three such P.B.X.'s may be interconnected by means of 2 wire bothway tie-lines and operated as a unit.

Figure 14 shows two possible arrangements of tie-lines. The case illustrated in (a) represents

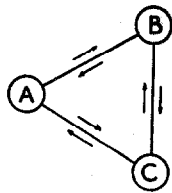

(a) LOCAL TIE LINE SERVICE

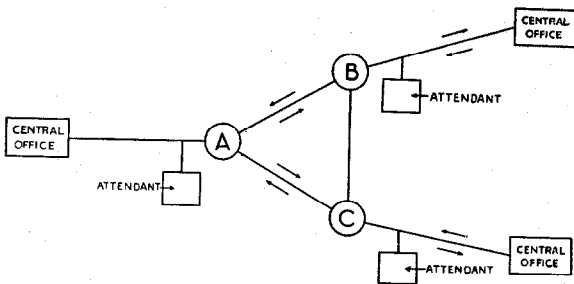

(b) TIE LINE AND C.O. SERVICE

Figure 14—Tie Line Schematics

tie-line service without Central Office connections; (b) shows the case where each of the P.B.X.'s have direct Central Office trunks in addition to tie-lines between themselves.

To ensure good transmission over tie-lines, they are divided into two groups. The one group comprises P.B.X. installations where the resistance of the longest substation line plus the tie-line does not exceed 500 ohms, in which case talking current is furnished from the local connection circuit at the terminating exchange. When this limit is exceeded, the calling and called substations are provided with talking current from their respective P.B.X.'s.

The general appearance of a tie-line unit (Figure 15) is similar to the junction unit. The method of operation also is similar.

A substation desiring a connection over a tie-line to another P.B.X. dials a single digit, say 1. The final in the local connection circuit moves to the corresponding terminal and a circuit train

is started which causes the tie-line finder to hunt for the calling station. The other end of the tie-line is connected to the line-finder arcs in the distant P.B.X. where it is picked up in the

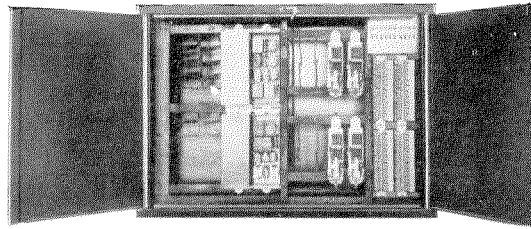

Figure 15—Tie Line Unit

regular manner. When the tie-line is picked up at the distant end, the connection circuit at the originating P.B.X. is broken down. The calling station receives the dialling tone from the distant P.B.X. and dials the number of the wanted station in the regular manner.

In the case of a 70 line P.B.X. with Central Office service facilities, the addition of a tie-line does not reduce the capacity of the board for substation lines, but in the 35 line board such an addition reduces the capacity to 34 substations.

The facilities thus far described are summed up in Figure 16. This illustrates the case of a

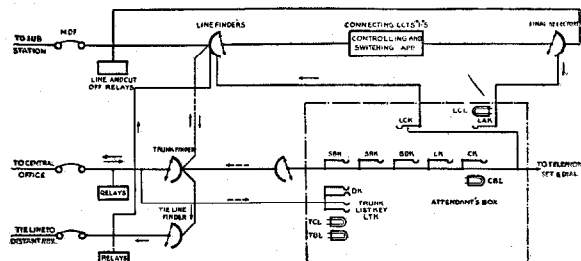

Figure 16—Junction Diagram 35-Line Automatic PBX Arranged for Central Office Trunks, Tie Lines and Attendant's Box

35 line P.B.X. provided with attendant's box and switch for attended "IN" and automatic "OUT" Central Office service and tie-lines. For simplicity one local connection circuit only is represented, and the attendant's switch combination appears as one switch. A diagram for the 70 line unit constructed on similar lines would show the additional final selectors, tie-line finders, junction finders, and attendant's switch necessary for coupling up the two units.

### **Miscellaneous Services**

In addition to the regular services described above, this board can be provided with conference facilities, code calling, fire alarm service, and group hunting. The conference facility permits a number of substations to be called and connected to a common circuit. In general, one conference line switch is provided to which a maximum of 35 lines can be connected, thus giving a wide choice in the lines to be called in conference. The facility of being able to call a conference in general is limited to a few individuals, but the choice of stations to be called is not limited. The procedure for calling a conference is simple and quick. During such occasions the local connection circuits are not used, thus obviating any blocking of other calls.

The code calling circuit enables an individual to be reached by telephone if he is on the premises but away from his desk. This is effected by means of the code call, which is allotted to such a station and which is broadcasted from ringers appropriately located. The individual being called can then go to the nearest telephone and get into communication with the calling station by dialling his substation number.

The fire-alarm service enables the Chief of the local fire-brigade to originate a call simultaneously to all members of the brigade.

The group hunting facility is provided to enable a number of stations to be tested in sequence for a free line, when the first number of the group is dialled and found to be busy. An example of a case where group hunting is beneficial, is an enquiry office at a railway station where it is immaterial which particular enquiry clerk is connected. Such group hunting facilities merely require the addition of a few resistances for the lines which are grouped together. Provision for mounting them is made in all units.

### **Power Plant**

The power plant required for operating the board consists of two sets of storage batteries with suitable charging equipment. Each set of batteries is composed of 18 cells giving a normal potential of 36 volts. The capacity of the sets is chosen to suit the traffic and the estimated average holding time of connections. If the traffic is such as to justify the provision of 5

connecting circuits per 35 lines, batteries of the sizes given below meet the requirements and furnish sufficient capacity for operating the switch-board during two working days with the usual allowances for contingencies.

- 35 Lines, no Central Office trunk equipment—14 ampere hours per battery.
- 70 Lines, no Central Office trunk equipment—28 ampere hours per battery.
- 35 Lines, with Central Office trunk equipment—28 ampere hours per battery.
- 70 Lines, with Central Office trunk equipment—28 ampere hours per battery.
- 70 Lines, with more than 5 Central Office trunks and intense local traffic—42 to 56 ampere hours per battery.

Where DC power is available and regulations permit, the batteries are charged directly from the mains through a suitable rheostat or bank of lamps. Where the public supply is alternating in character, a small rectifier is provided.

The batteries, each containing 6 cells enclosed in glass jars which are mounted in a cabinet, are supplied in portable cases. To reduce power wiring to a minimum the charging panel is fixed to the cabinet. Two pairs of power wires, one pair for talking and the other for signalling, are run from the cabinet to the bus-bars on the automatic switchboard. The several circuits are then fed over alarm type fuses.

If neither of the above mentioned charging schemes is feasible a small charging set is furnished.

### **Circuits**

Space does not permit of a detailed description of the various circuits employed in a 7001 type automatic P.B.X. but an outline of the principles which governed the design of the selective part of the circuit may prove of interest.

In the 35 line unit the substations receive numbers in the block 60-95 inclusive. Thus there are 4 groups of lines differing primarily in the tens digit. The selecting arrangements consist of two distinct operations, namely, the selection of the decade and the selection of the particular unit in that decade.

The selection of the decade takes place in two operations, one of which is the registration of the tens digit and the other the propulsion of





The numbering for the 70 line installation is from 30-99, of which numbers 30-69 are connected to one unit, and 70-99 to the other. The tens digits 3-9 inclusive are thus used; the selection process consists in determining the unit in which the wanted line is to be found, then in driving forward the proper final to the starting terminal of the decade containing the wanted line and finally in selecting the line.

### *Red Cross Hospital at the Hague*

To conclude this article, a brief description is given of a P.B.X. furnished to the Red Cross Hospital at the Hague, Holland, by the Telephone Department of the Municipality, and installed by them. The installation provides equipment for 35 substations, 3 Central Office trunks and 4 connecting circuits. Attendance is given on incoming Central Office calls by means

of an attendant's box and switch, but outgoing calls to the Central Office are made automatically.

To meet the Hospital authorities' requirements for day and night switching, two attendants' boxes and switches are located in two widely separated points in the building.

Figure 18 shows the junction diagram, and Figure 19 the day-attendance box. The latter is operated by the night-nurse. The Central Office trunks are furnished with a key at each box to enable the trunk to be picked up at either point. To guard against the possibility of both keys being normal simultaneously, a signal can be arranged at both points to indicate this condition.

The equipment for charging the batteries operates on 125 cycle alternating current supplied by the Municipality. The maximum output of the rectifier is 5 amperes.

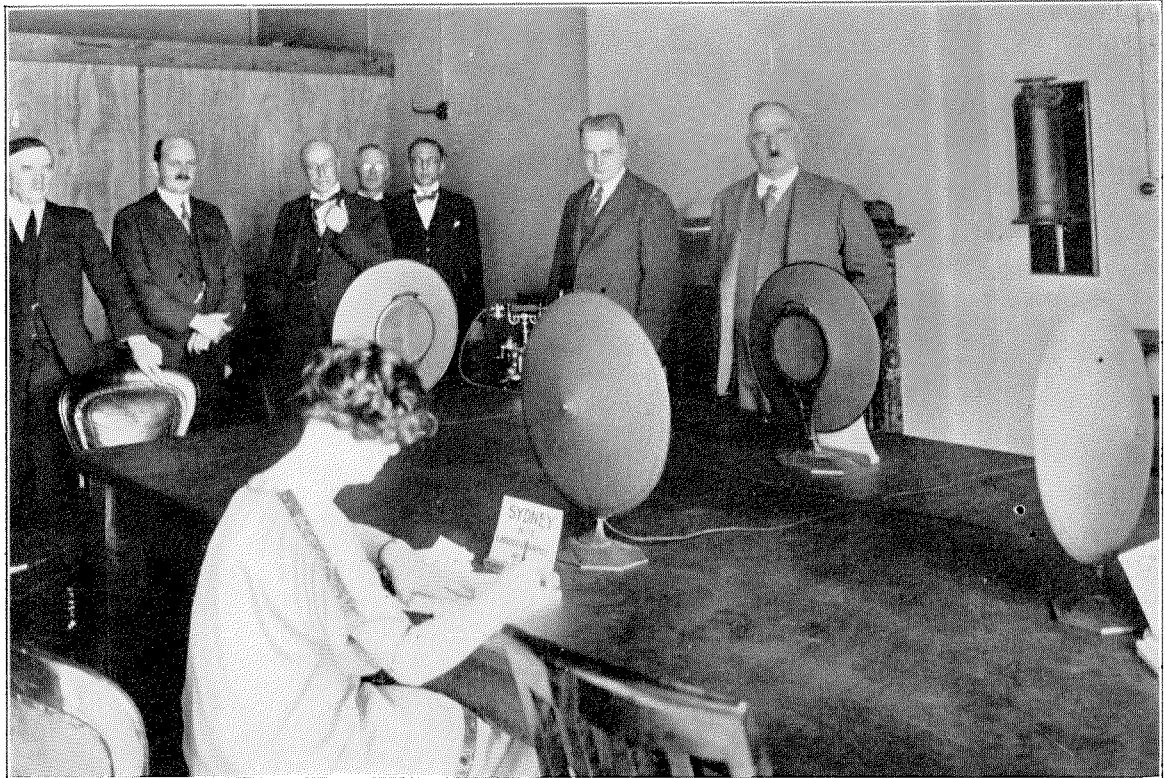

Australian Post Office Officials Listening to Four Conversations Being Carried on Over the New Carrier Telephone System Between Sydney and Melbourne. In the Photograph, Beginning at the Left, Are Mr. W. G. Gibson, Postmaster General; Mr. H. P. Brown, Director of Postal Service; Mr. J. W. Crawford, Chief Engineer; Mr. R. M. Partingham, Victoria State Engineer; Mr. S. H. Witt, Director of Research; Mr. J. S. Jammer, of the International Standard Electric Corporation, and Mr. H. C. Bright, Deputy Postmaster General

# The Hague Telephone Network

By B. A. TURKHUUD

*Bell Telephone Manufacturing Company, Antwerp*

THE Hague area furnishes an interesting example of the rapid growth of a telephone network. Twelve years ago, when the contract was placed for automatic switching apparatus, it was estimated that 20,000-line capacity would suffice, and the equipment was planned accordingly. Later, however, the Hague Administration foresaw that the growth of the system would necessitate more liberal provision and they called for a 60,000-line capacity for the network. It is a tribute to the flexibility of the No. 7-A Machine Switching System (7-A M.S.S.) that re-arrangements to meet these unexpected conditions were carried out easily and to the entire satisfaction of the Telephone Direction. The principle of register control, which is a particular feature of this system, provides facilities for meeting difficult cases of this character.

In 1913 the Hague telephone service was provided by means of two common-battery exchanges: Centrum, or Hofstraat, and Scheveningen. The first exchange was equipped for 8400 lines and the second for 2000 lines. The growth of the number of lines at this period was just over 10% per annum. To meet this development it was decided to provide one new automatic exchange and to replace the existing manual office at Scheveningen by automatic switching equipment. The Telephone Direction at that time made an exhaustive study of the automatic systems on the market and visited installations in all countries, including America, where automatic offices of various sizes were in operation. As a result of these investigations it was decided to adopt semi-automatic operation and to convert to full automatic later.

In 1914 a contract was awarded to the Bell Telephone Manufacturing Company at Antwerp for the manufacture for the Hague of the No. 7-A Machine Switching (Rotary) System<sup>1</sup> under the patents of the Western Electric Company. The first order was for 2200 lines for Scheveningen, subsequently increased to 2600, and for 2000 lines for Hague West, with a switch-

ing capacity of 20,000 lines for the area. Precedence was given to the Scheveningen office. Calls incoming to Scheveningen from the manual equipment were to be forwarded over order wires and handled by semi-B operators located at Scheveningen. Calls outgoing to the manual office were to be displayed on call-indicator positions and completed in the manual multiple. Finally, calls to and from the Hague West office were routed over incoming trunk selector switches located in each office.

In 1916, the Municipality foresaw that the original capacity of 20,000 lines for the Hague would prove insufficient. They therefore requested that the equipment should be extended to serve six—10,000 line exchanges. Again, in 1918 the Company was notified that further contracts would be placed covering new equipments: at Centrum, 8000 lines, Bezuidenhout 3000 lines and extensions of Scheveningen and Hague West to 5000 and 7000 lines respectively.

An indication of the extent of the equipment, the method of trunking, and the estimated volume of traffic at the present time, is given in Figure 1, which shows the junction diagram for the Scheveningen and Hague West exchanges.

## *Scheveningen Exchange*

This exchange was cut into service on January 7, 1920, with 3400 semi-automatic lines. The cut-over was followed by the installation of 600 additional lines, which were placed in service in October, 1921. Finally, in July, 1922, 1000 additional full automatic lines were made available.

The terminal-room and power plant are on the ground floor, and the automatic equipment and operators' tables are on the first floor. Figure 2 shows the operating room with the semi-automatic tables in the foreground and the manual toll switching section at the back. The standard method of semi-automatic operation was adopted. Calls to the manual

<sup>1</sup>For a description of the No. 7-A Machine Switching (Rotary) System, see *Electrical Communication*, Vol. 3, January, 1925.

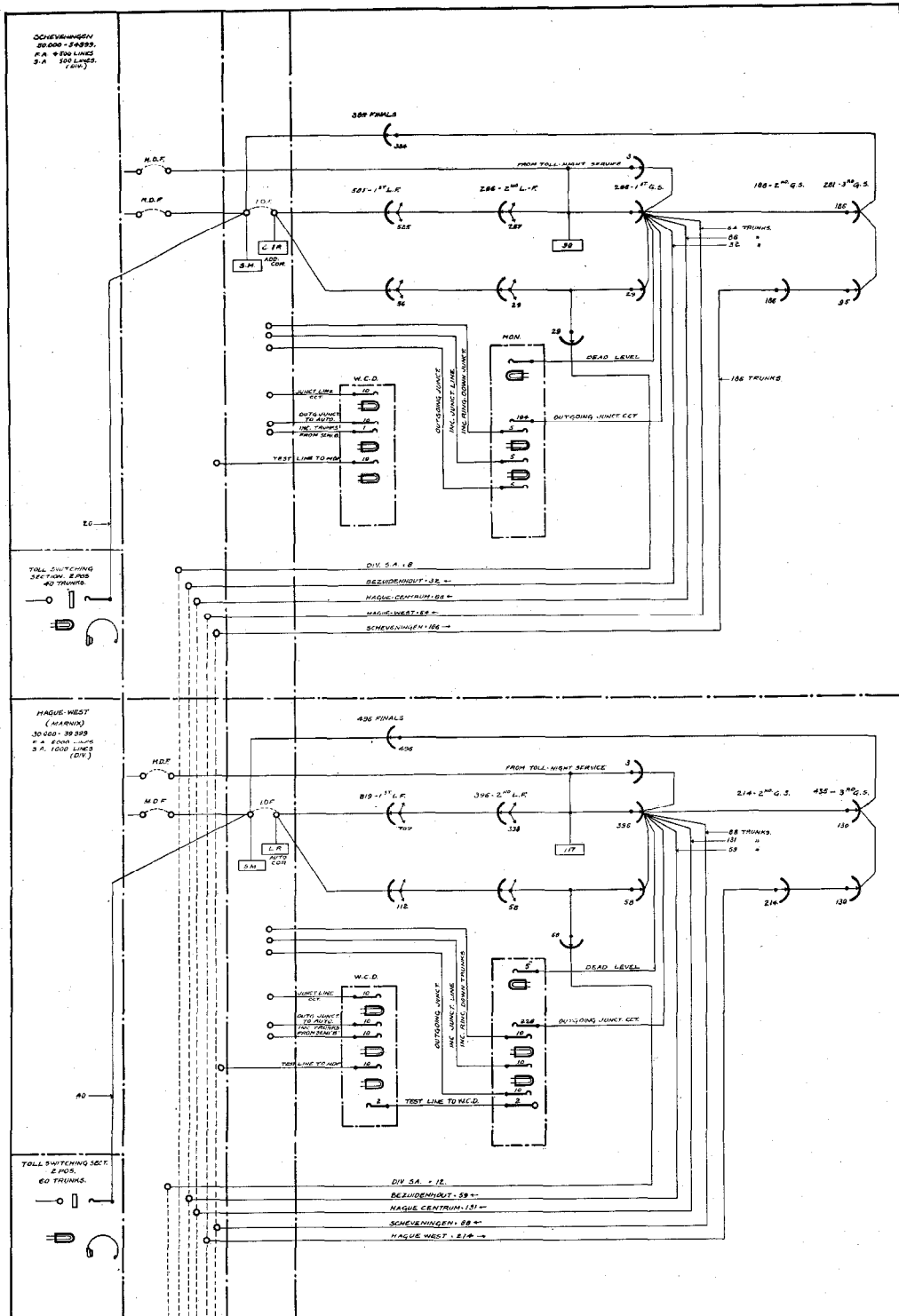

Figure 1—Junction Diagram—Scheveningen and Hague West (Marnix) 1925

exchange were routed over trunks to call-indicator positions at Centrum. Incoming calls from Centrum were handled by semi-B operators and completed over incoming group-selectors at the Scheveningen exchange. Incoming toll

sequence switches are the component parts which go to make up the connection circuit. Two groups of connection circuits, each group with 27 circuits, are illustrated.

The first line-finder switches are mounted

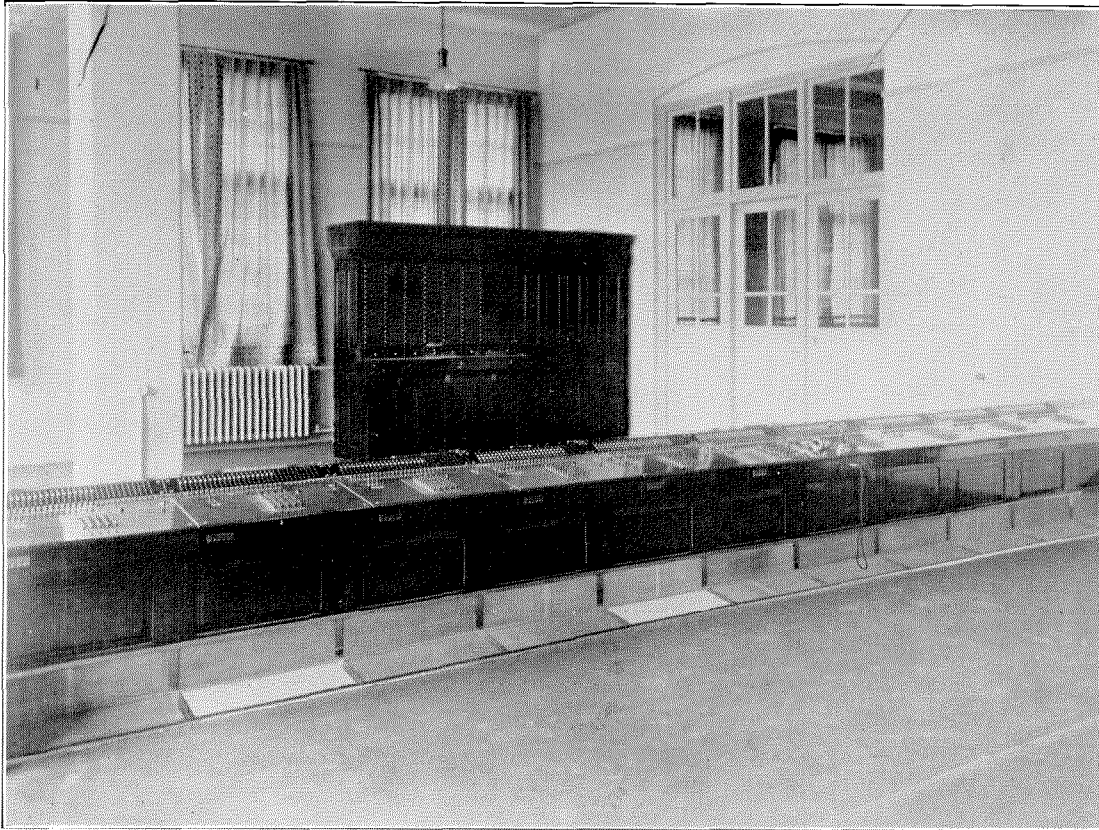

Figure 2—Scheveningen Exchange—Operators' Tables and Toll Switching Section

calls were completed manually at the toll switching section.

Figures 3 to 5 illustrate the machine equipment. Figure 3 shows a rack of connection circuits. Commencing from the left, there is a bay of relays and other subsidiary apparatus forming part of the operator's connection circuits. To the right of this are two bays of second line-finders with a capacity of 15 switches per bay. The next three bays show the first group selector switches with the controlling sequence switch alongside each selector. These bays have a capacity of 11 switches per bay. Beyond the selector-bays is a bay of sequence switches used for selecting a free register. The relays, line-finders, selectors and

on a rack similarly to the second line-finders depicted in Figure 3. The line-finder bays are capable of accommodating 15 switches per bay, but the traffic requires only 7 line-finders per group of 60 lines. Consequently, the ribbon cable is split in a manner such that each bay serves two groups of 60 subscribers. The line-finder and starting relays are mounted on the relay bays at each end of the rack. These bays also carry the fuse panel. The line and cut-off relays are mounted on a separate rack.

Figure 4 is a view of the selector switches. It also shows the arrangement of the ribbon cable at the back of the bay. In this figure, the cross-connection rack between the selectors

can be seen to the right. The central motor method of driving the switch rack shafting through worm and bevel gearing is also clearly shown. The motor illustrated is  $\frac{1}{8}$  H.P. and it is loaded only to 50% of its rated capacity.

A typical combined sequence-switch, relay and register bay, equipped with ten registers,

### *Concentration of Semi Automatic Service*

In view of a reduction in the number of semi-automatic positions, due to conversion of lines to full automatic operation, not only at Scheveningen, but at Hague West and Bezuidenhout, the Municipality called for an arrangement whereby the semi-automatic service

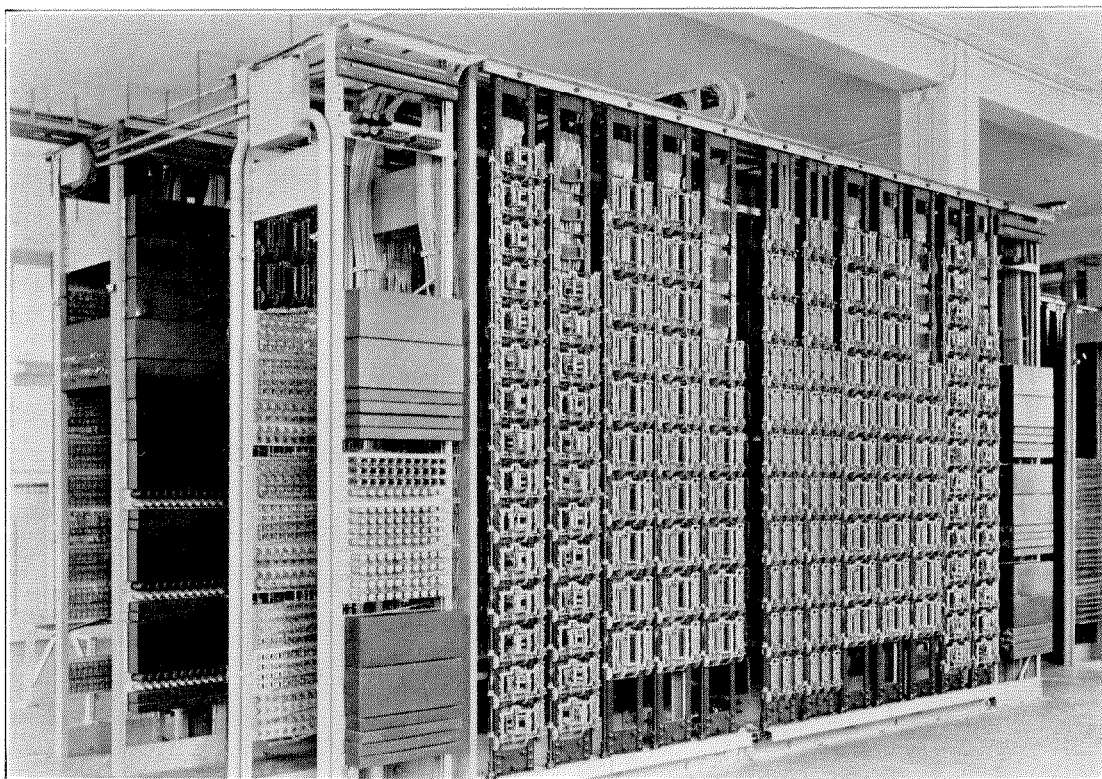

Figure 3—Scheveningen Exchange—Rack of Connection Circuits

is shown in Figure 5. The relays are mounted on the left of the bay and the step-by-step switches on the right. The step-by-step switch to the left is the directing switch and the remaining five are the numerical registers. The controlling sequence switch may be seen mounted between the two parts of the bay. Terminal strips located at the rear of the bay adjacent to the sequence-switches provide cross-connecting facilities between the No. 10,000 numerical switch and the counting and discriminating relays, thus enabling the numbering to be varied at will, and giving great flexibility.

could be handled by operators located at one central point; viz., the Centrum exchange. A suitable scheme was devised, which is shown in principle in Figure 6. It will be seen that the register chooser-switches, and the semi-A positions, are located in the Centrum exchange, but that the call is completed over the local switches. A semi-automatic subscriber at Scheveningen wishing to make a call, lifts his receiver and is connected to a local connection circuit. This circuit is provided with a sequence switch which searches for a free trunk relay group associated with a register chooser-switch located at Centrum. The reg-

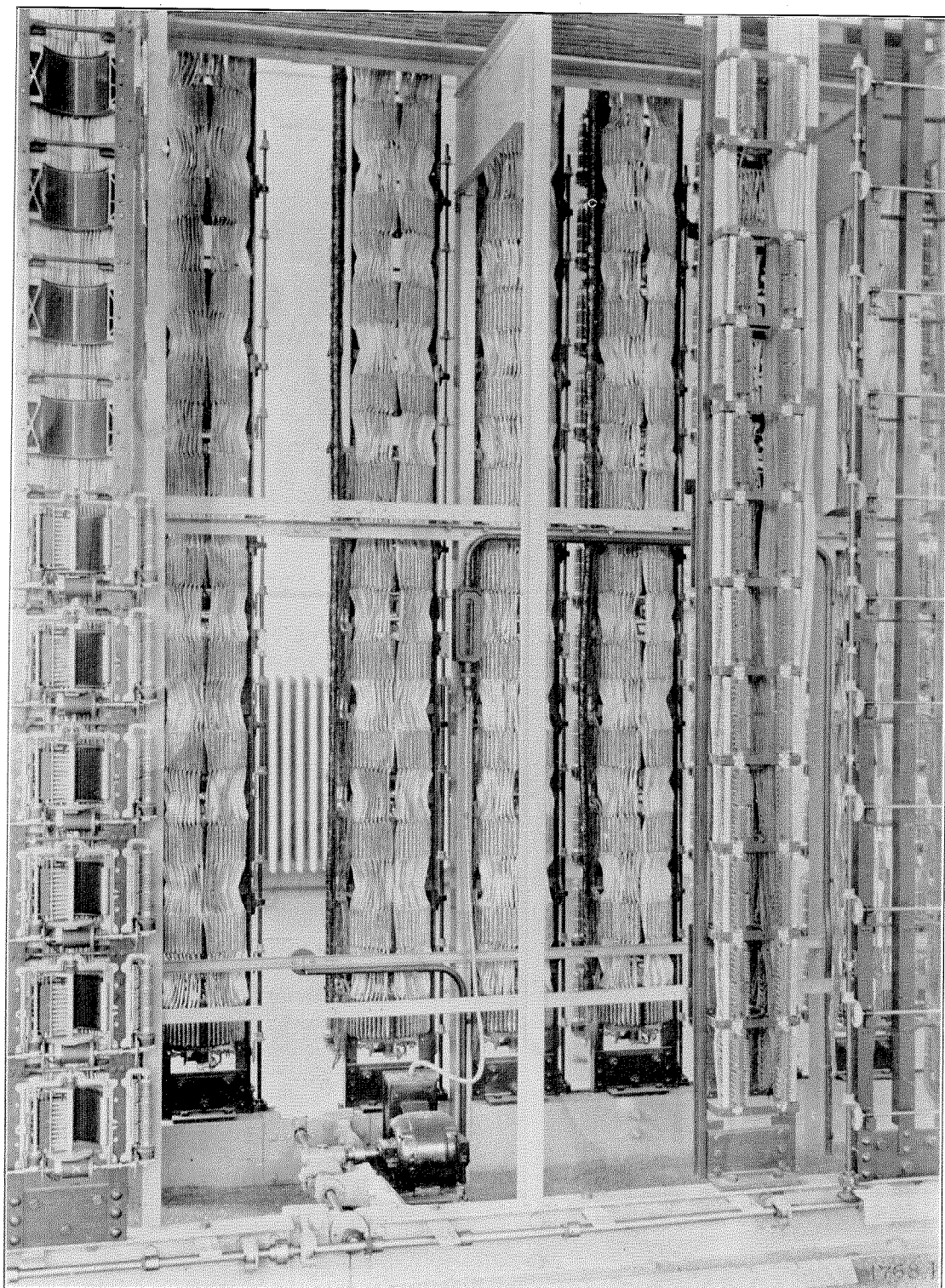

Figure 4—Scheveningen Exchange—Selector Rack Showing Central Motor Drive

ister-chooser at Centrum then extends the connection to a free register and thus to the semi-A operator who is equipped with a pilot

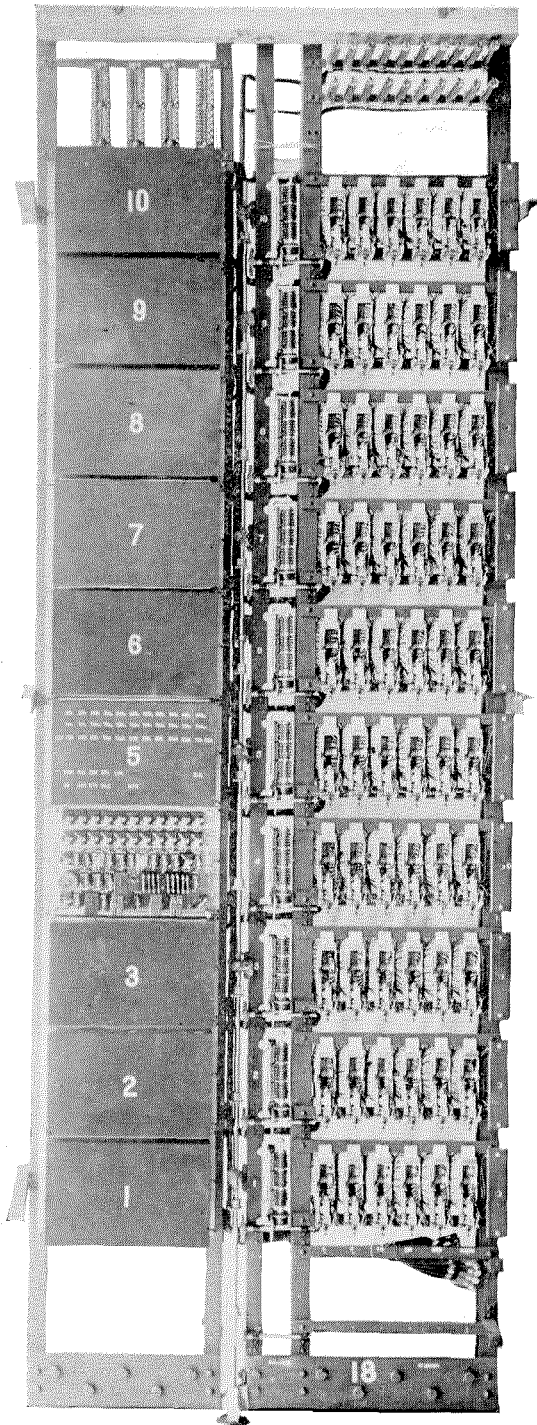

Figure 5—Combined Sequence Switch, Relay and Register Key

lamp and keyset only. The operator ascertains the requirements and depresses the corresponding key or keys on her keyset. The register now controls the first group selector at the Scheveningen office in the selection of the proper level. If the call is local, the third group and final selectors are set, after which the trunk to the operator is made free. If the call is to another office, it is routed over incoming selectors at the required office and thence over final selectors to the terminals of the called line. Release is automatic and does not require the intervention of the operator.

This concentration service was brought into use in 1924 and the statistics show that about 760,000 calls from the three offices, Scheveningen, Bezuidenhout and Hague West were handled by the four semi-A positions at Centrum during the last three months of 1924. Each concentration position is provided with three registers and the average load per concentration operator is about 480 calls per busy hour.

The Scheveningen exchange (Figure 1) is now equipped for 4500 full automatic and 500 diverted semi-automatic lines. The number of working lines at the end of 1924 was 3572.

#### *Hague West or Marnix Exchange*

This exchange, variously referred to as Hague West or Marnix, is designed for a capacity of 10,000 lines, of which 4000 semi-automatic lines were cut into service in February, 1921. The equipment occupies two floors. The ground floor accommodates the power plant and Main Distributing Frame (M.D.F.) and the first floor the Intermediate Distributing Frame (I.D.F.), automatic equipment and operators' tables. The method of operation is similar to that at Scheveningen.

In October, 1921, an additional 1500 semi-automatic lines were brought into use; and finally, in August, 1922, the equipment was extended by 1500 full automatic lines, thus bringing the equipment to a total of 7000 lines. In the same year, the Municipality called for the conversion of seven groups of connecting circuits from semi to full automatic and for the provision of 69 full automatic registers, with their associated equipment. Finally, in 1923, two more connecting circuit groups

were converted to full automatic operation, and equipment was provided for handling the traffic for the two remaining semi-automatic groups by means of operators' tables and registers located at Hague Centrum.

Figure 7 shows a general view of the Hague West automatic switchroom and Figure 8, the cable-runs above the various switchcracks. Figure 1, the present arrangement, shows the exchange equipped with 6000 full automatic

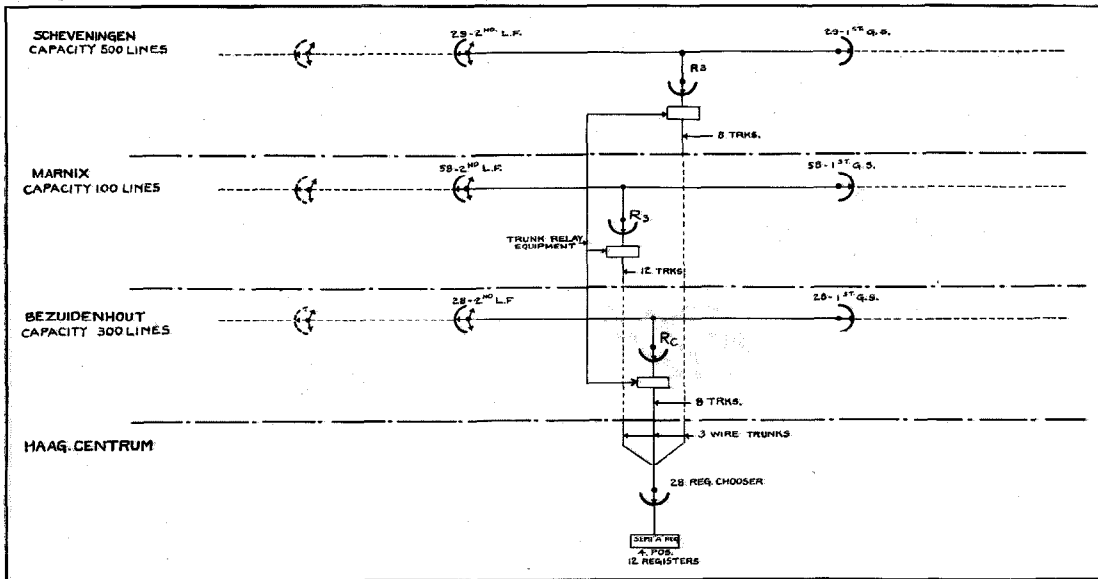

Figure 6—Junction Diagram Showing Arrangement for Diverting Service, Automatic Traffic to Centrum

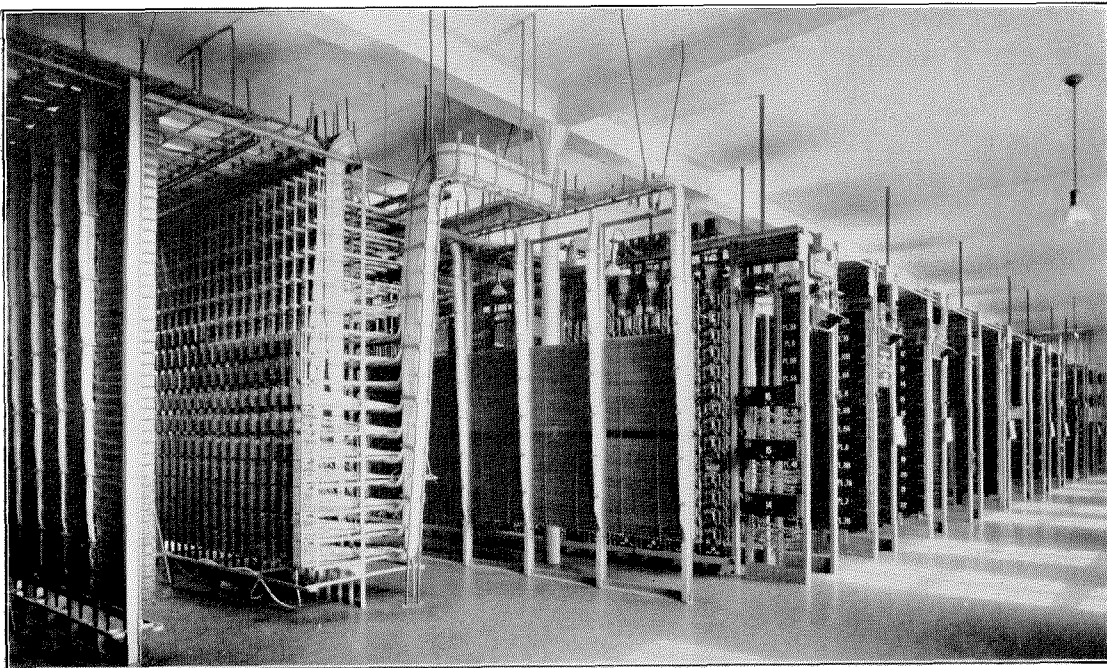

Figure 7—Hague West—General View of Automatic Switch Room



and 1000 diverted semi-automatic lines. The number of working lines at the end of 1924 was 5819.

### ***Bezuidenhout Exchange***

This exchange came into being on the cut-over of the Scheveningen equipment when the 2000-line multiple board, rendered obsolete at Scheveningen, was transported intact on

Figures 9 to 11 show part of the equipment of the Bezuidenhout exchange. In Figure 9 are seen the first group selectors, sequence switches and relays, forming part of the connection-circuits. It will be noticed that the original design, in which the controlling sequence-switch was mounted alongside the selector, has been abandoned together with the arrangement for mounting the associated relays

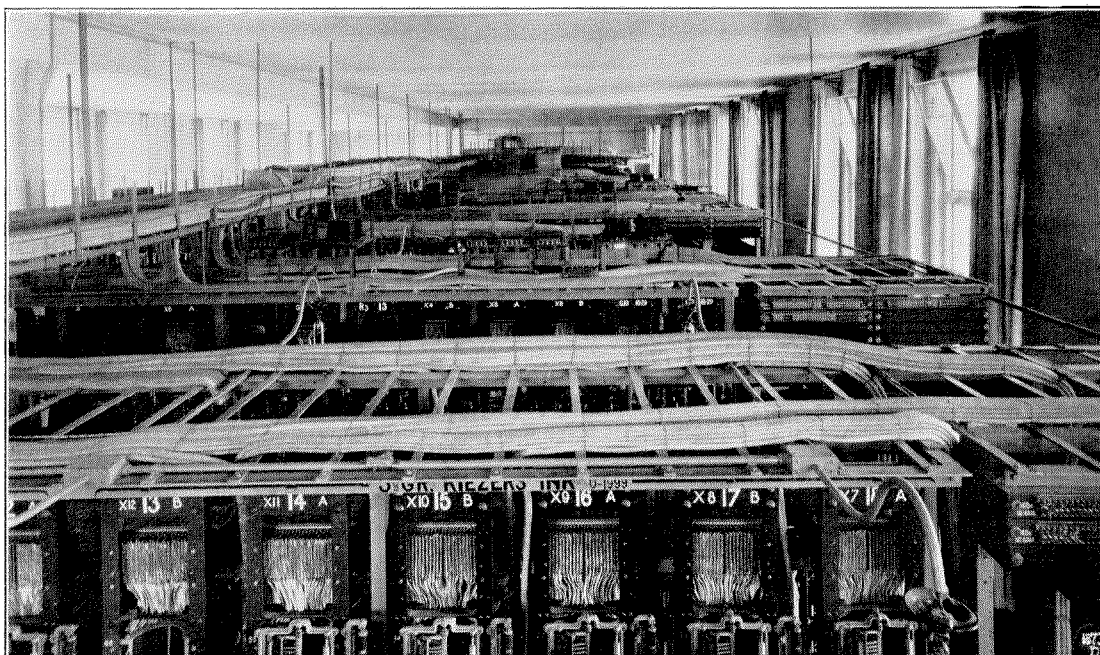

Figure 8—Hague West Cable Runs

a special truck to the temporary new building at Bezuidenhout. This remarkable transfer, carried out by the Municipality, proved completely successful.

The new Bezuidenhout exchange was reached by means of ringdown trunks. This board was replaced in August, 1923, by 7-A Machine Switching System equipment for 2000 semi-automatic and 1000 full automatic lines. The equipment was located on two floors as in the case of Marnix exchange.

In the following year, after the cut-over of the Centrum exchange, the work of converting one group of semi-automatic connection-circuits to full automatic was carried out and the remaining semi-automatic lines were concentrated on operators' positions at Hague Centrum.

in relay cabinets located at the end of the switchrack. In the present design the sequence-switch and relays form a combined bay placed alongside the selector bay. This arrangement, among others, is advantageous from a maintenance viewpoint, and makes practicable the complete cabling and testing of the circuit in the factory. Figure 10 represents a rack of final selector switches with their associated sequence switches and relays mounted on a combined bay alongside the switches. Figure 11 is a view of the register monitoring and out-trunk test desk. The equipment on this desk enables the daily routine-testing of the inter-office trunks to be carried out and permits of the monitoring of calls.

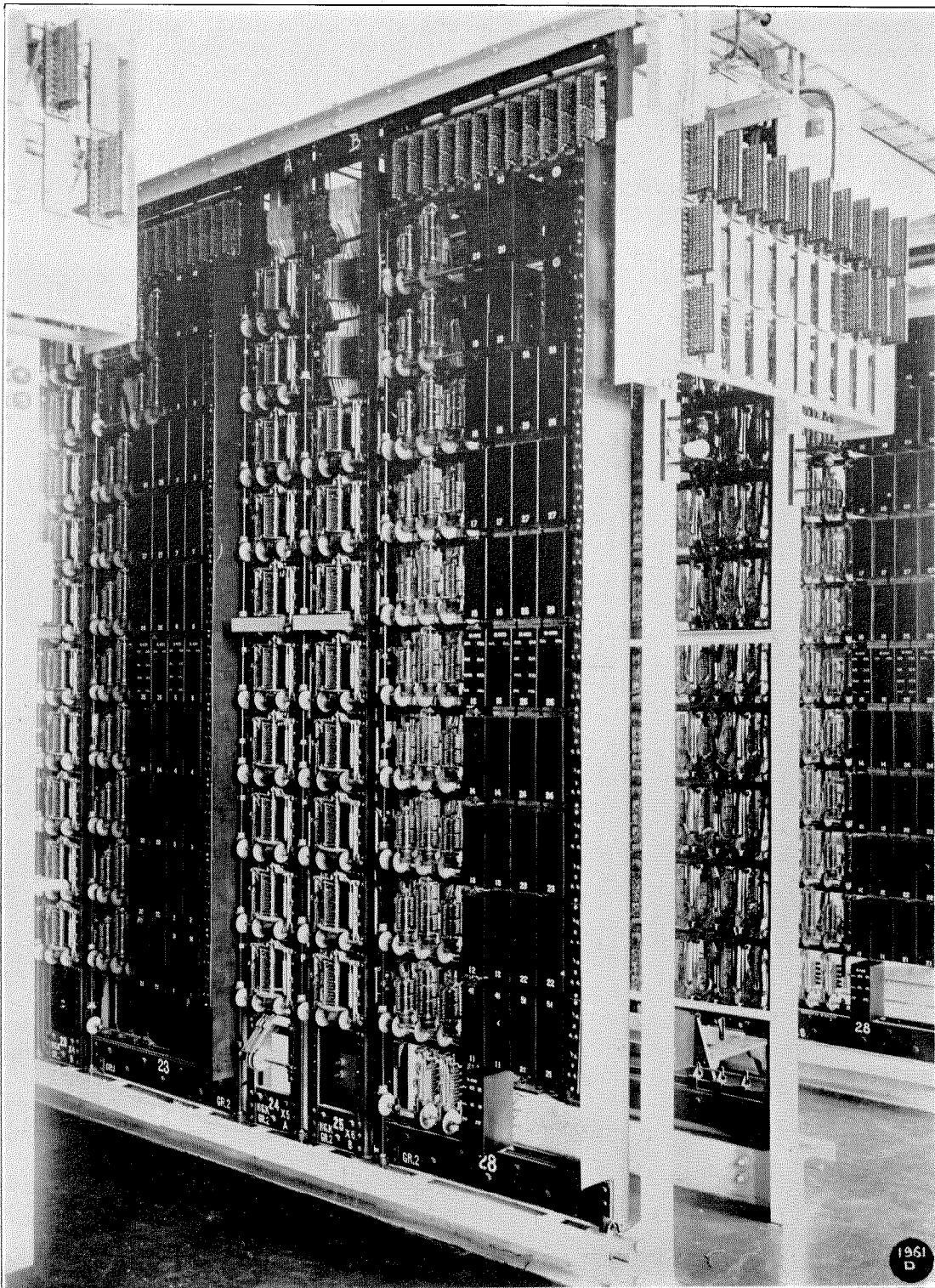

Figure 9—Bezuidenhout Exchange—Rack of Connection Circuits

The exchange is now equipped for 2500 full automatic lines and 500 diverted semi-automatic lines. The number of working lines at the end of 1924 was 2229.

### *Hague Centrum Exchange*

This exchange is designed for a capacity of 10,000 lines. It was opened to traffic on February 15, 1924, with equipment consist-

difficult conditions. The total space which the Municipality were able to set apart for the 10,000 line automatic equipment was a room 25.52 metres long by 9.4 metres wide and 3.79 metres high plus a small adjoining room 9 x 9 metres which was separated from the larger room by a main wall. The conditions therefore not only restricted the superficial area but limited the height, which was

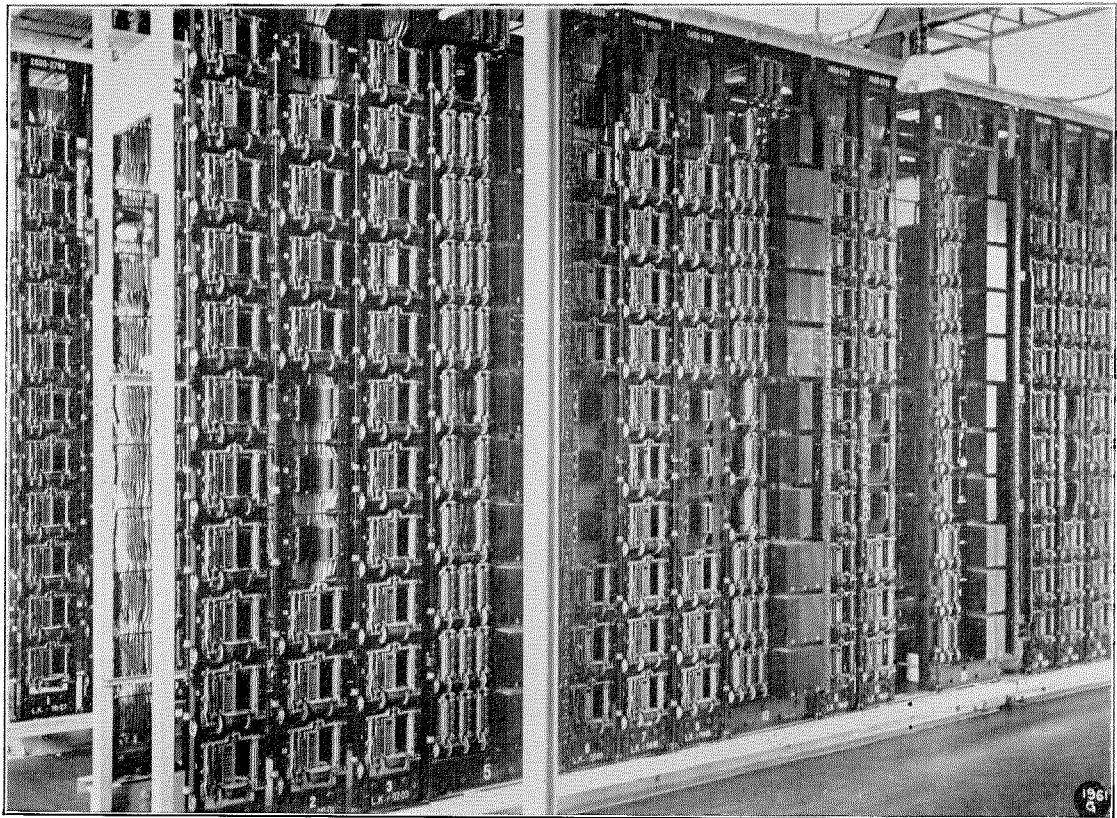

Figure 10—Bezuidenhout Exchange—Rack of Final Selectors

ing of 7000 semi-automatic and 1000 full automatic lines. At the time of the transfer the load was taken exclusively by the semi-automatic lines and about 6200 subscribers were connected.

This office completed the first multiple office area to be equipped entirely with 7-A Machine Switching System apparatus. Figure 12 is a floor plan of the switching equipment at the Centrum office. The layout of this automatic equipment is a striking example of the adaptability of the 7-A M.S.S. to meet

not sufficient to allow of racks of the maximum capacity. Despite these disadvantages, the equipment was accommodated to the complete satisfaction of the Municipality who were thereby saved the considerable expense which would have been incurred in obtaining new premises in an expensive and congested part of the City.

A few notes on the system of cabling between the racks may be of interest. In consequence of the development of the new gear-driven line-finder, which dispenses with the inter-

mediate distributing frame and the line and cut-off relay rack, the method here described differs in several respects from that adopted for the latest type of full automatic equipments. The cabling arrangements for the semi-automatic equipment are shown diagrammatically in Figure 13, and those for the full automatic in Figure 14. In both layouts, the cables from the multiple or horizontal side of the

are connected by circuit cabling to the first group-selectors mounted in the same rows. In the case of the semi-automatic equipment, cables are also run from the second line-finders to the Table Distributing Frame (T.D.F.) seen to the right of Figure 12. These circuits are then cross-connected to the cord-circuits on the operators' tables (Figure 13). The position sequence-switch is provided to "disable"

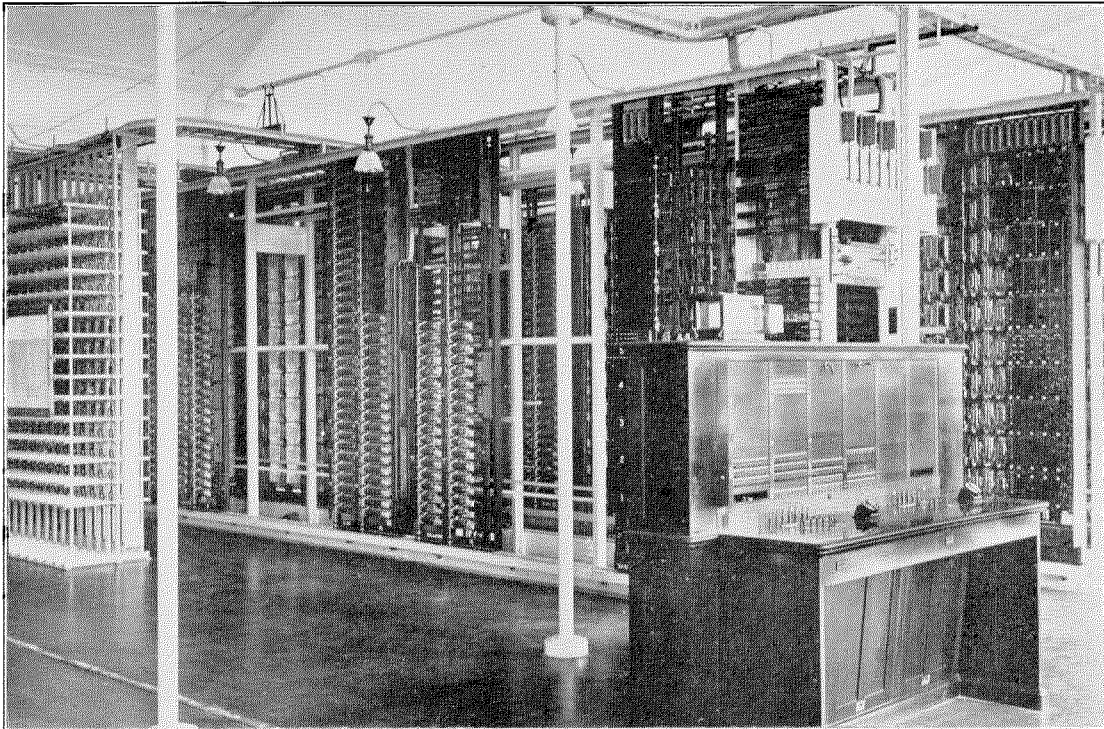

Figure 11—Bezuidenhout Exchange—Register Monitoring and Out-Trunk Test Desk

intermediate frame are made off to terminal strips mounted on the final switch bays. Cables are run also from this side of the frame to the service meter-rack. The first line-finders, to the left of Figure 13, are cabled to the answering or vertical side of the I.D.F. from which side cables are run to the line and cut-off relay rack, as in standard manual common battery practice.

The brush members of the first line-finders are wired to terminal strips located at the ends of their respective switch-racks where they are cross-connected, as required, to cables leading to the arcs of second line-finders. The second line-finders, rows 15 to 22, Figure 12,

all cords on a position when an operator is absent.

An incoming call is signalled by the steady burning of a calling lamp. The semi-automatic connection-circuits are each provided with Register Chooser switches (RC), and on the arrival of a call this sequence switch hunts for a free register associated with the position on which the cord is terminated. Each operator's position is furnished with three registers. As soon as a free register is taken into use, a lamp associated with the calling-cord flashes, and the operator sets up the connection which is then routed over the corresponding first group selector.

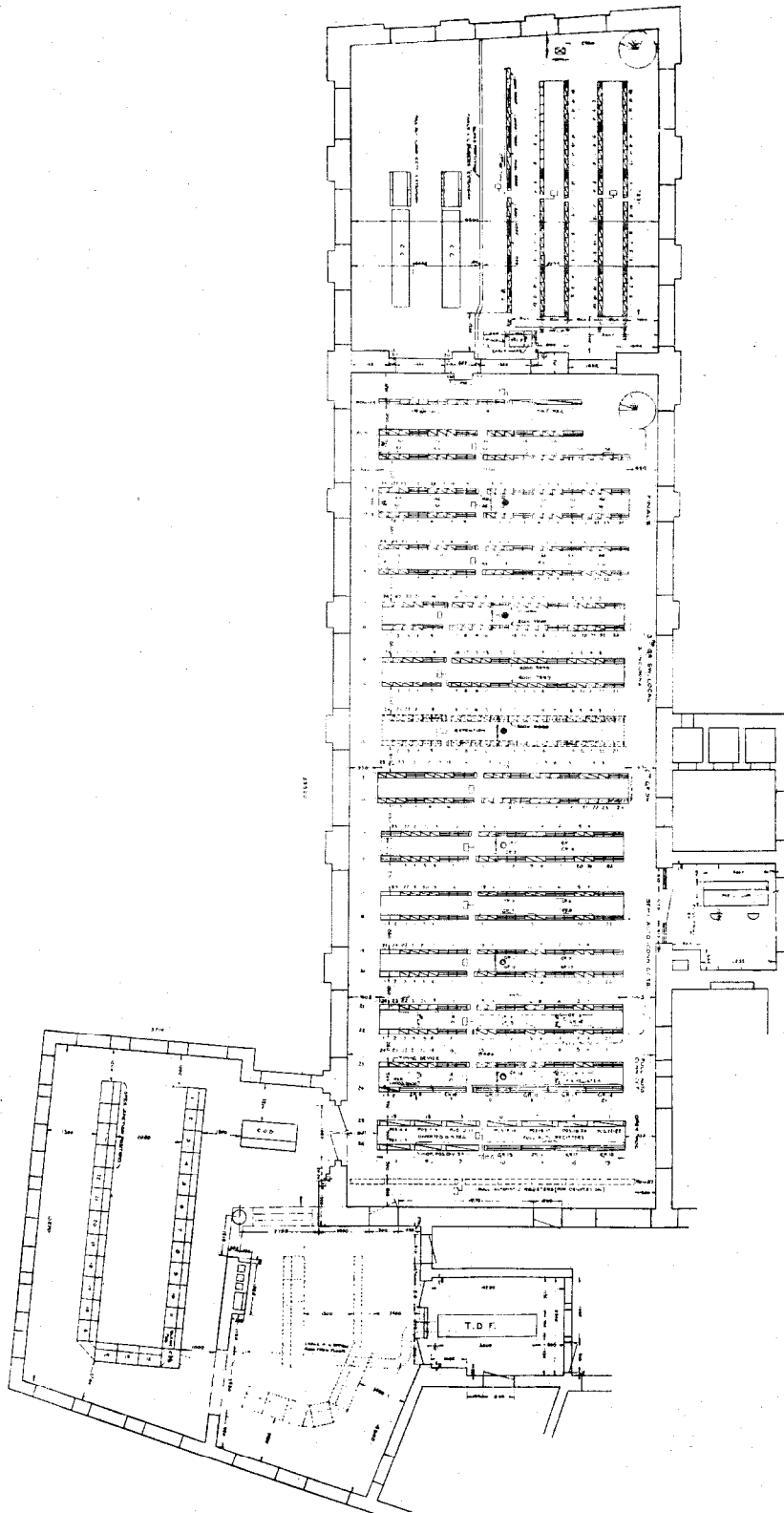

Figure 12—Centrum Exchange Floor Plan, Automatic Switch Room

The arcs of the first group selector are cabled to terminal strips where they are connected to cables leading to the third group selector switches in rows 7 to 11, and the arcs of these are in turn cabled to the final switches, rows 1-6.

At the operators' tables, helping out features are provided which permit of team work between

chooser sequence switch. These switches are mounted in row 24. The contacts of all register choosers associated with a group of connection circuits are multiplied and connected to eleven registers, one for each stopping position of the switch, Figure 14. These full automatic registers are located in row 26.

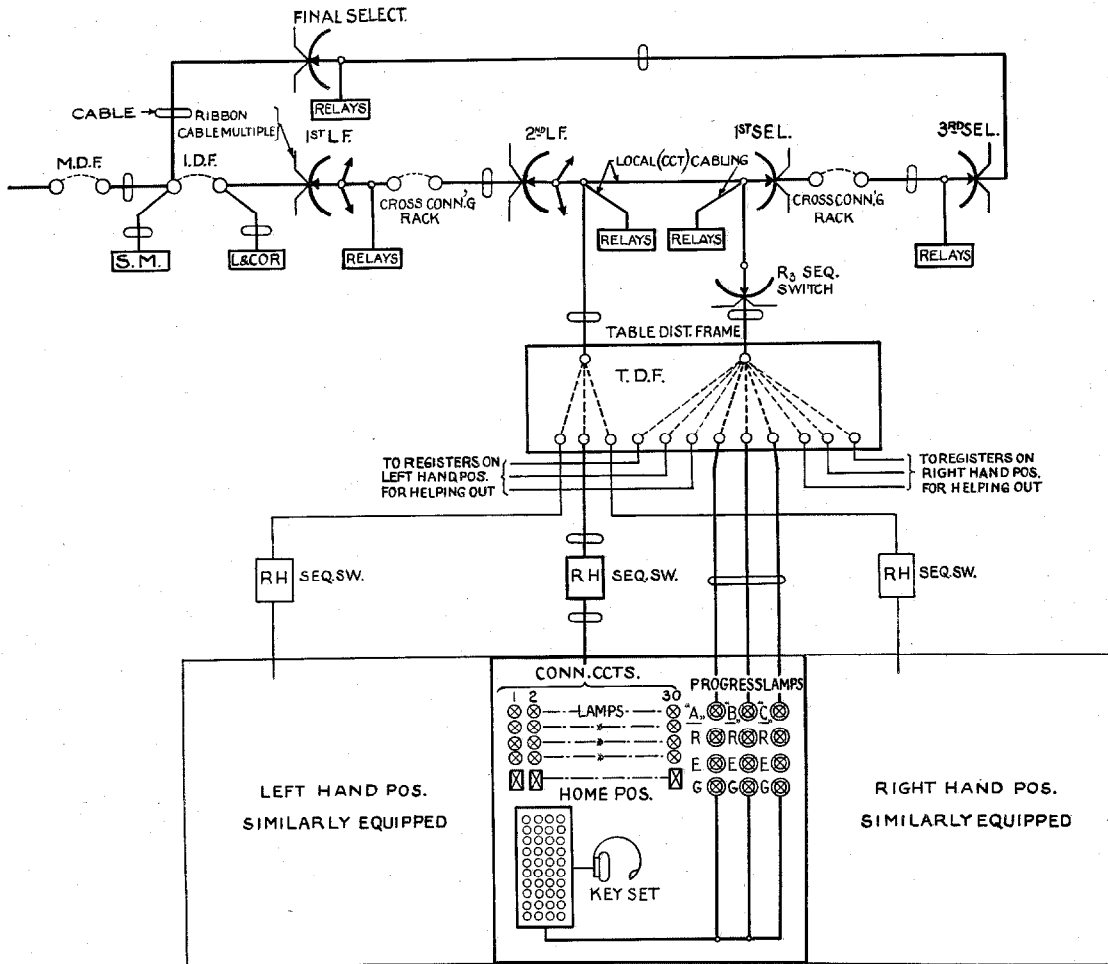

Figure 13—Cable Scheme for Semi-Automatic Equipment

the operators. If, for example, the home operator is busy, the register chooser-switch hunts for a free register on the positions to the left or right of the home position. The call is therefore not restricted to the three registers on the home position but has access to any one of nine registers.

Cabling for the full automatic equipment (Figure 14) is simpler. Each connection-circuit, rows 23 and 24, is provided with a register

When a hunting register chooser seizes a register, this register is immediately associated with the connection circuit and is placed under the control of the calling subscriber. When the selection is finished, the register is released and can be picked up by any other Register Chooser (RC) switch in this group.

The remainder of the cabling arrangements are identical with those explained in connection with the semi-automatic equipment.

In order to accommodate the automatic equipment at Centrum, it was necessary to remove the power plant from the first floor to the basement without an interruption in the supply of current. This was done by the Hague Municipality by first erecting a temporary board in the basement and connecting to it supplementary battery cables. One machine was then moved down and connected to the battery, after which the second machine was transferred. Finally, the original power board was moved below as a unit (complete

### Power Plant

The power plant arrangements at all four exchanges are similar in principle as regards the method of charging and discharging the batteries. At each exchange, two batteries of 12 cells and two batteries of 13 cells are provided. A 12-cell battery furnishes the 24 volts required for talking and toll purposes. The 48 volt potential used for signalling and switch operation is obtained by a series arrangement of a 12- and 13-cell battery. The charging and discharging arrangements are such

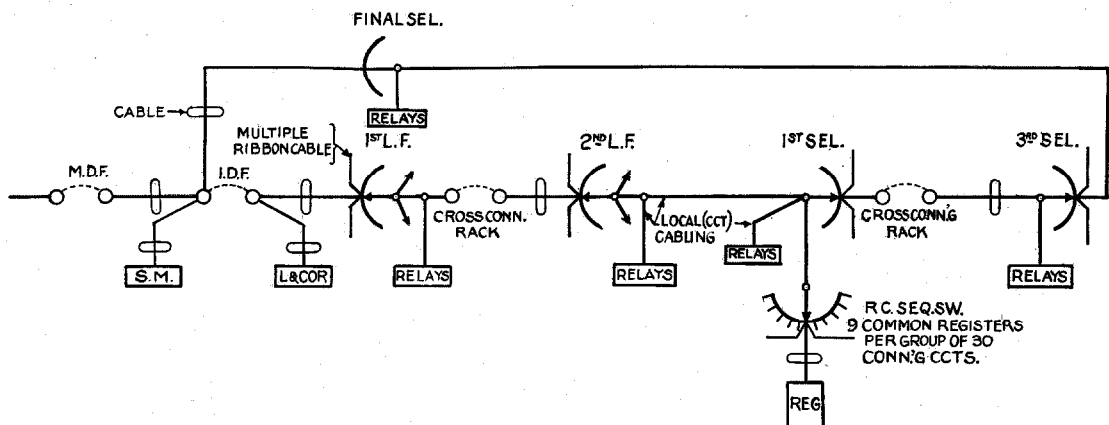

Figure 14—Cable Scheme for Full Automatic Equipment

with all equipment) and the two machines were re-connected to it. The whole removal was carried out without any disturbance whatever to the service.

This removal cleared a part only of the room required for the automatic equipment. The remaining space was occupied by the Main Frame, the line relays and the cut-off relays, associated with the working manual office. Part of this equipment was then thrown spare, after which the M.D.F. was removed to the floor below and the calling equipment to the floor above. The remainder of the material was moved into its new quarters. The whole of the work was carried out by the Municipality without disturbance to the manual office which, during this time, was working at full pressure.

In the present equipment at Hague Centrum there are 6720 semi-automatic and 1320 full automatic lines. The number of lines working at the close of 1924 was 5990.

that either one of the 12-cell batteries may be connected in series with either one of the 13-cell bank.

The voltage regulation on the exchange bus-bars is accomplished by means of an end cell switch—the end cells being part of the 13-cell batteries. For charging purposes, two motor-generator sets with voltage regulation between 22 and 37 volts are provided. Either machine is capable of charging a 12- or 13-cell battery.

The booster potential required for metering calls is provided by two small motor-generator sets having a voltage regulation from 50 to 60 volts and furnishing a current of 3 amperes. No meter batteries are provided.

To guard against a break-down in the public power supply, a 6 kw. petrol motor-alternator is installed at Scheveningen and Hague West respectively. Recently this petrol-set was brought into use during a break-down of one hour in the main supply. The operation was

entirely satisfactory and telephone service was maintained without any disturbance.

At Bezuidenhout and Hague Centrum, a battery-driven emergency set is provided for driving the switch-motors. In the event of a service failure, this set is automatically connected to the exchange-battery and it provides the necessary voltage for driving the switch-motors. The accompanying Table 1 shows

Bezuidenhout vary from 6%-8% whilst those to Scheveningen are few.

### Service

Ultimately, telephone service is judged by the degree to which the subscribers are satisfied. It is, therefore, necessary to make periodical checks from the subscriber's point of view to determine the percentage of calls which are

TABLE I  
Power Plant Particulars

EXCHANGE	CHARGING GENERATORS		EQUIPPED BATTERY CAPACITIES	
	Volts	Amps	2 x 12 cell	2 x 13 cell
Bezuidenhout.....	22/37	250	1200 AH each	1080 AH each
Centrum.....	22/37	300	2280 " "	1800 " "
Marnix.....	22/37	350	2170 " "	1520 " "
Scheveningen.....	22/37	350	2160 " "	1458 " "

the size of the power plant at each of the four exchanges.

### Traffic

The four exchanges are grouped about Centrum as indicated on the map in Figure 15. Scheveningen exchange to the northwest of the city is situated in a residential sea-side resort. Approximately 50% of the originated traffic is completed locally and the remaining calls are divided between Centrum and Marnix in the ratio of 2:1. Calls to and from the residential district of Bezuidenhout are few.

Marnix exchange is in the dense industrial region to the south-west. About 40% of the originated traffic is completed locally and outgoing traffic is directed mainly to Centrum and Scheveningen and divided roughly between these exchanges in the ratio of 6:1. Calls to Bezuidenhout are infrequent.

Bezuidenhout is in the south-east of the City, where development is rapid. About 30% of the originated traffic is local, between 45%-50% is directed to Centrum, and 3%-7% towards Marnix.

Centrum serves the central part of the city—the business quarter. Of the originated calls, about 60% are completed locally and from 20%-24% are directed to Marnix. Calls to

satisfactorily completed, and the number of ineffective calls.

These checks are made from the Service Observation Desk, where a trained operator observes the call from point to point and records the fate of each call. The Hague officials have paid particular attention to the collection of such service observations. They have taken care to see that the reports are accurately prepared and carefully analyzed. Such reports deal with three important points regarding the service; namely, the occupied time, the destination of calls, and their fate.

A translation of a typical summary sheet received from the Administration in connection with the Scheveningen office for December 1924 is shown in Figure 16. The upper part deals with the time data; the lower part is concerned with the destination and fate of calls. Observations are made from 9:30 a.m. to 11:30 a.m. and from 1:30 p.m. to 3:30 p.m.

In the upper part of the Form, Column A gives the number of calls observed at each stage of a call, Column B gives the total time taken by all observed calls to reach each stage, Column C gives the average time per call to reach any stage, and Column D gives the average time for each call when passing from one stage to





Figure 15—Map of The Hague

another. A total of six stages is taken as representing an effective connection.

Stage 1—The arrival of a call on the connection circuit.

Stage 2—The time when dialling tone is first heard and later disconnected owing to the subscriber having commenced to dial.

Stage 3—The completion of dialling.

Stage 4—The receipt of the ringing tone.

Stage 5—The commencement of conversation.

Stage 6—The release after an effective call.

In addition there are:—

Stages 7 and 8—The release of the switches after a busy or no answer connection.

Stage 9—The release of an uncompleted connection owing either to the subscriber or to the equipment.

SERVICE OBSERVATION REPORT (Full Automatic)

Exchange: Scheveningen

Period: December 1  
9:30 to 11:30 A.M.

to December 31, 1924  
1:30 to 3:30 P.M.

	A	B	C	D		A	B	C	D
	Cases	Total	Average	Diff.		Cases	Total	Average	Diff.
1 Call on Connecting Circuit	1006	766	0.76			766	577	0.75	
2a Dialling Tone Rec'd	1006	1421	1.41	(2b-1)		766	1092	1.43	(2b-1)
2b Operator Answers	1006	3642	3.62	2.86 (3-2b)		766	2827	3.69	2.94 (3-2b)
3 Dialling Last Number	1005	11242	11.19	7.57 (4-3)	B, C and D Time in Seconds	764	8316	10.88	7.19 (4-3)
4 Ringing or Busy Tone	999	14676	14.69	3.50 (5-4)		759	10868	14.32	3.44 (5-4)
5 Conversation Starting	841	21711	25.82	11.13 (6-5)		658	16878	25.65	11.33 (6-5)
6 Release of Connection	841	106445	126.57	100.75 (7-4)		656	85375	130.14	104.49 (7-4)
7 Release of Busy Connection	128	2569	20.07	5.38		73	1515	20.75	6.43
8 Release of No Answer Connection	30	2051	68.37	(8-4) 53.68		28	2099	74.96	(8-4) 60.64
9a Release of Uncompleted Connection By Subscriber	..	..	..		..	..	..		
9b Mechanical and Unclassified	6	582	97.00	(9b-3) 85.81	5	301	60.20	(9b-3) 49.32	

9:30 to 11:30 A.M. 1:30 to 3:30 P.M.

	Cases	Per Cent	Cases	Per Cent
10 Calls Observed	1006		766	
11				
12 Connections to "The Hague"		31.01		27.81
13 Connections to "Scheveningen"		46.42		48.96
14 Connections to "Marnix"		21.58		21.67
15 Connections to "Bezuidenhout"		0.99		1.56
16 Selecting Time to "The Hague"	3.58		3.44	
17 Selecting Time to "Scheveningen"	3.47		3.45	
18 Selecting Time to "Marnix"	3.85		3.54	
19 Selecting Time to "Bezuidenhout"	1.67		1.92	
20 Busy Calls	128	12.72	73	9.53
21 No Answer Calls	30	2.98	28	3.66
22 Wrong Number (Subscriber or Operator)	8	0.80	9	1.17
23 Wrong Number (Mechanical and Unclassified)	..	..	..	..
24 Uncompleted Calls	..	..	2	0.26
25a Interrupted Calls By Subscriber	..	..	..	..
25b Mechanical and Unclassified	6	0.60	5	0.65
26 Premature Release	1	0.10	2	0.26

Figure 16—Facsimile of Service Observation Summary

From the above, it will be apparent that the difference in the average time taken to pass from stage 1 to stage 2 (b) represents the time which elapses from the removal of the receiver to the response of the operator; in this case, 2.86 secs. The difference in the average times taken to reach stages 2 and 3 indicates the dialling time; namely, 7.57 secs. The difference between stages 3 and 4 gives the average selection time, 3.5 secs. The difference between stages 4 and 5 is the delay before the called subscriber answers, 11.13 secs. The time of conversation is given by the difference in the time for stages 5 and 6, and is 100.75 secs. On calls to a busy line, a busy signal is received at stage 4, and the releasing time on such calls is taken as stage 7. The difference between these two shows the average

time during which the subscribers listen to the busy tone; in the case under consideration this time is 5.38 secs. In a similar manner the difference in the average times for stages 8 and 4 gives the average time the subscribers hold the line on no-answer calls; in this case the time is 53.68 secs. Finally, the difference between stages 9 and 4 shows the average time that subscribers wait on a line when the call is not completed.

The lower part of the Form is self-explanatory. Thus, for example, the local calls observed at Scheveningen accounted for 46.42% of the total, whereas the calls to Marnix were only 21.58% of the total.

Lines 20-26 show the extent and cause of all ineffective calls. Thus "busy" calls amounted to 12.72%, "no answer" to 2.98, "wrong num-

TROUBLE REPORT

Exchange: Scheveningen                      Period: December 1                      to December 31, 1924  
 Number of Lines:                      3572                      Percentage "A" Conn. to Hague:                      31.01—27.81  
 Number of Stations:                                           Percentage "A" Conn. to Schev.:                      46.42—48.96  
 Number of "A" Conn.: 637243                      Percentage "A" Conn. to Marnix:                      21.38—21.67  
 Number of "B" Conn.:                                           Percentage "A" Conn. to Bezuidenhout: 0.99— 1.56

Complaints and Line Faults	1	2	3	4	5	6	7	8	9	10	11	12
	Cases	OK on Test	MDF	IDF	LR. COR & S.M.		Mult. and Arcs	Faults on Outside Lines	Receiver Removed	Total		
					Winding and Sol-dering	Cont. and Ad-justment				Outside	Inside	
A Complaints....	454	314	16	6	4	2	21	86	5	91	49	
B False Calls....	37	3	..	..	..	..	..	32	2	34	..	
Total.....	491	317	16	6	4	2	21	118	7	125	49	

"A" includes all complaints received and line faults noted in routine test.

Installation Faults Not Including the Above Mentioned		1	2	3	4	5	6	7	8	9	10	11	12	13	14	15
A	Sequence Switch and Registers.....				6		4	4	2	3						19
B	Line Finder and Selector.....				1				2			8				11
C	Multiple and Arcs.....			2				1								3
D	Relays.....			2	3		3	1	1			8				18
E	Wiring and Cabling.....															..
F	Lamps, Cords, Keys Miscellaneous..				4		..					1		1	1	7
G	Total.....	..	..	4	14	..	7	6	5	3	..	17	..	1	1	58

Extra Specification of These Faults

H	Dirty Contacts.....			1	6		5	3	4	2		5				26
I	Power Drive (Slipping etc.).....							1								1
J	Adjustment.....				3		1					4				8
K	Breakage and Wear.....															

Figure 17—Facsimile of Trouble Report Summary



17. This sheet relates particularly to the Central office equipment and the faults are classified according to circuits, and also under the various subdivisions of the equipment. It is, therefore, easy to determine the trouble cleared for each type of circuit and also for each particular part of the equipment forming

circuits, final selector-circuit and registers, is dealt with in Table 2 which shows the number of such circuits and the faults per circuit per annum.

These faults are further classified in Table 3 to show the proportion of trouble (including that caused by dust) due to switches, relays,

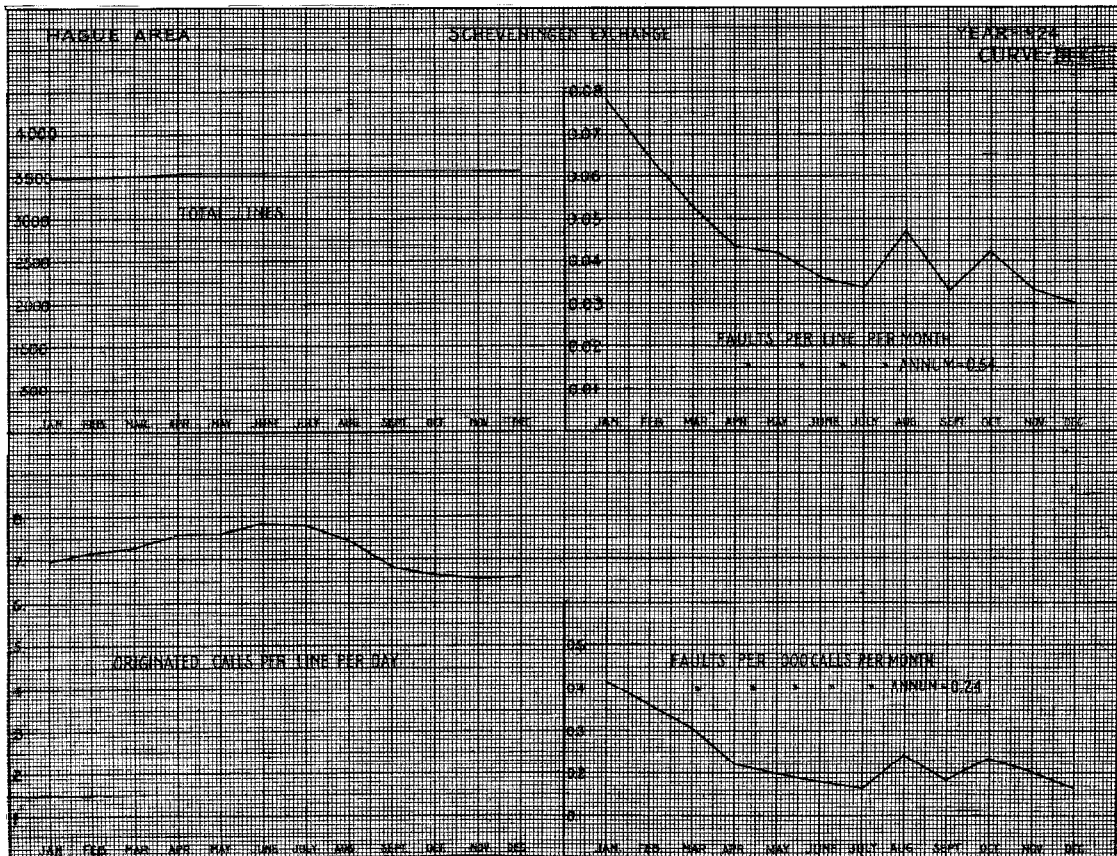

Figure 18—Results for Scheveningen Exchange—1924

that circuit. In addition to the above, the faults are classified also under dust, adjustment, breakage, etc.

The results obtained in 1924 for the Scheveningen exchange are plotted in the form of curves in Figure 18. It shows the growth in exchange-lines, the average daily calling rate, the exchange faults per line per month and per annum, and the exchange faults per 1000 calls per month and per annum.

The performance of the individual circuits such as the first line-finder circuit, connection circuit, second and third group-selector cir-

wiring and miscellaneous causes. The miscellaneous item covers lamp, key and fuse troubles.

In connection with Tables 2 and 3, it should be borne in mind that the Centrum Office was cut into service in 1924 and that, during this time, installation work was being carried on in connection with the conversion of semi-automatic equipment to full automatic operation. In addition, the work of concentrating the remaining semi-automatic lines on Centrum was in progress.

TABLE II  
Faults per circuit per annum

	Bezuidenhout Exchange		Marnix Exchange		Scheveningen Exchange		Centrum* Exchange	
	No. of ccts.	Faults per cct. per an.	No. of ccts.	Faults per cct. per an.	No. of ccts.	Faults per cct. per an.	No. of ccts.	Faults per cct. per an.
1st Line finders.....	349	0.17	819	0.16	581	0.06	1065	0.04
Connection ccts.....	192	0.87	399	0.78	289	0.64	588	0.55
Registers.....	55	2.04	110	4.40	90	1.57	*	0.44
2nd Group Selectors...	142	0.74	214	0.35	186	0.28	276	0.33
3rd Group Selectors....	206	0.48	425	0.46	281	0.45	680	0.26
Final Selectors.....	294	0.54	496	0.42	374	0.33	891	0.48

\* Based on 8 months record.

TABLE III  
Sub-division of faults among component parts of the circuits.

	Bezuidenhout Exchange Faults per cct. per an. due to			Marnix Exchange Faults per cct. per an. due to			Scheveningen Exchange Faults per cct. per an. due to			Centrum* Exchange Faults per cct. per an. due to		
	Sws.	Rel.	Wir. & Misc.	Sws.	Rel.	Wir. & Misc.	Sws.	Rel.	Wir. & Misc.	Sws.	Rel.	Wir. & Misc.
1st Line finder.....	0.10	....	0.07	0.05	0.02	0.09	0.01	0.01	0.04	0.01	....	0.03
Connection ccts.....	0.45	0.18	0.24	0.40	0.14	0.24	0.32	0.21	0.11	0.35	0.11	0.09
Registers.....	1.17	0.29	0.58	2.—	1.25	1.15	0.71	0.73	0.13	0.28	0.09	0.12
2nd Group Selectors.....	0.32	0.34	0.08	0.18	0.08	0.09	0.10	0.15	0.03	0.15	0.10	0.08
3rd Group Selectors.....	0.28	0.06	0.14	0.21	0.06	0.19	0.20	0.15	0.10	0.13	0.03	0.10
Final Selectors.....	0.28	0.08	0.18	0.28	0.05	0.08	0.20	0.06	0.07	0.30	0.10	0.08

SWS—Switches.

REL—Relays.

WIR—Wiring.

\*Based on 8 months record.

## Maintenance

In view of the experience gained by the Hague Officials, the relatively large amount of time spent on systematic overhauling of equipment and the careful attention given to routine maintenance, the following brief extract from their written instructions may prove useful.

### FINAL SWITCHES

One bay of finals is inspected per day when special attention is given to the mechanical adjustment and lubrication.

Electrical tests are made to verify that all finals on the bay are selected by the third group selectors and that the finals select the correct numbers both in the even and odd hundred group.

Finally, the several driving discs associated with the trip spindle, sequence switch and brush carriage are driven in for a period of two hours in the slack period of the day.

### FIRST LINE FINDERS

Mechanical inspection of one bay of line-finders per day, when all adjustments are verified and the necessary cleansing and lubrication is carried out.

Systematic observations of line-finders for a limited period, to see that the several switches take up calls properly.

### THIRD GROUP SELECTORS

The mechanical inspection of one bay of switches is done each day and electrical tests are made to verify that all third group selectors are accessible to the first group selectors. In addition to this, the driving-in routine referred to under the finals is put into force.

### CONNECTION CIRCUITS

Six connection circuits are inspected for mechanical adjustment each day. Each connection circuit comprises a second line-finder, first group selector and three sequence switches.

Electrical tests are then made to see that each connection circuit can be picked up by a call. Special attention is paid to see that the register chooser switch is capable of picking up each register associated with it.

Finally, the driving-in of all switches is carried out.

REGISTERS

In addition to the daily routine test on registers, they are inspected mechanically once a month when all adjustments are verified.

Each register is also tested once a week for correct electrical operation. During this test the following calls are made:

1. Calls to two numbers, one odd and one even, in each group of 1000 numbers
2. A false call completed via the monitoring equipment

3. A dead level connection

4. Two calls one to an even number and the other to an odd number in each 1000 group at each of the other exchanges

The chart reproduced in Figure 19, which was prepared by the Administration, shows the number of man-hours spent on the maintenance of the Marnix exchange during one week in 1925. It will be seen that the actual time spent in clearing faults occupied 14.5% of the whole. The "proving" of the equipment occupied 58.8% of the total time and, of this, 37.2% was spent in the systematic overhauling of the equipment. Based on these results, the maintenance of the equipment as a whole required 6.5 man-hours per line per year. The Administration states that the staff of fifteen men will not be increased when the equipment is extended to its full capacity of 7,000 lines.

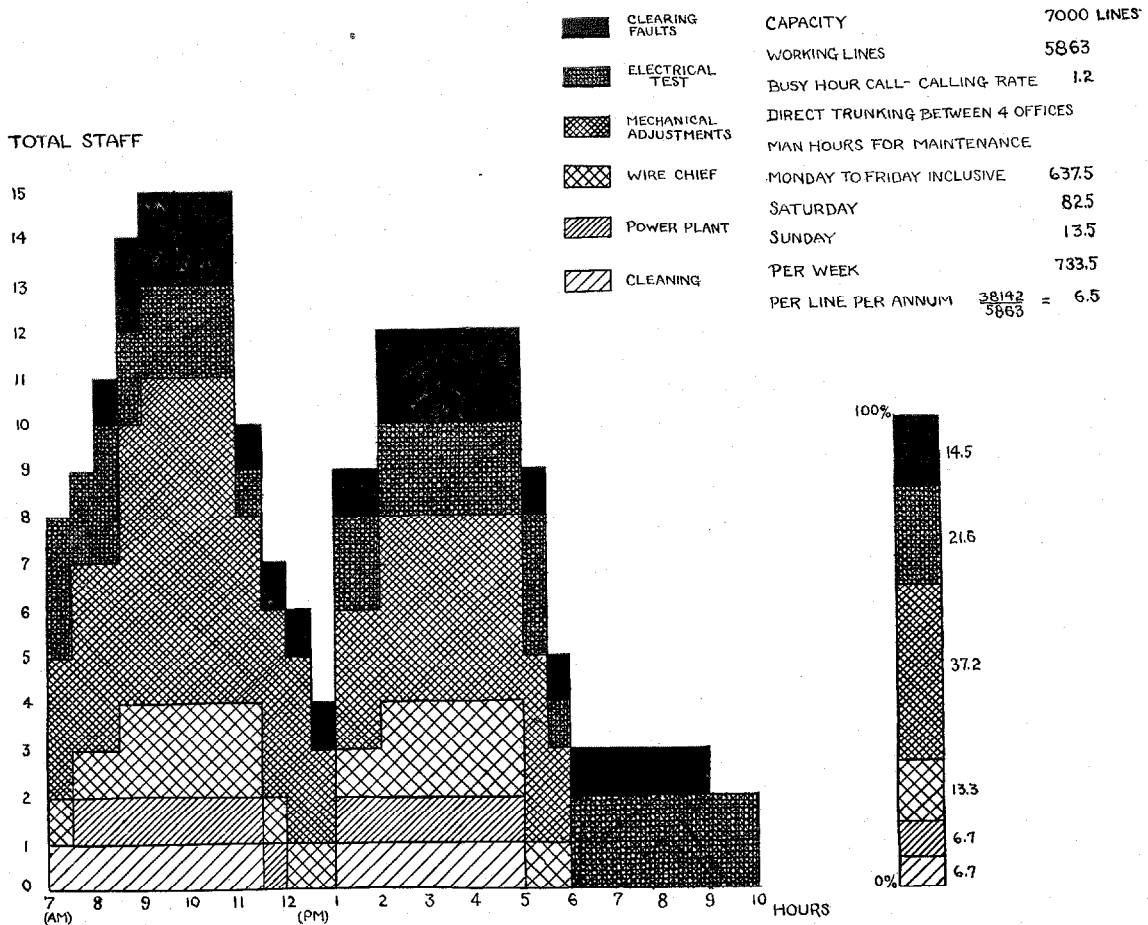

Figure 19—Maintenance Chart—Marnix

# Switchboard Cords

By E. S. McLARN

*Engineering Department, International Standard Electric Corporation*

OF the many kinds of apparatus going to make up a central office switchboard, perhaps the least striking but certainly one of the most important is the switchboard cord. This, as is well known, is the connecting link between the calling and

human element. Consequently the service conditions that a switchboard cord must meet are such that no mechanical tests have ever been devised that will even closely approach them, and the only absolutely reliable method of securing accurate information regarding its

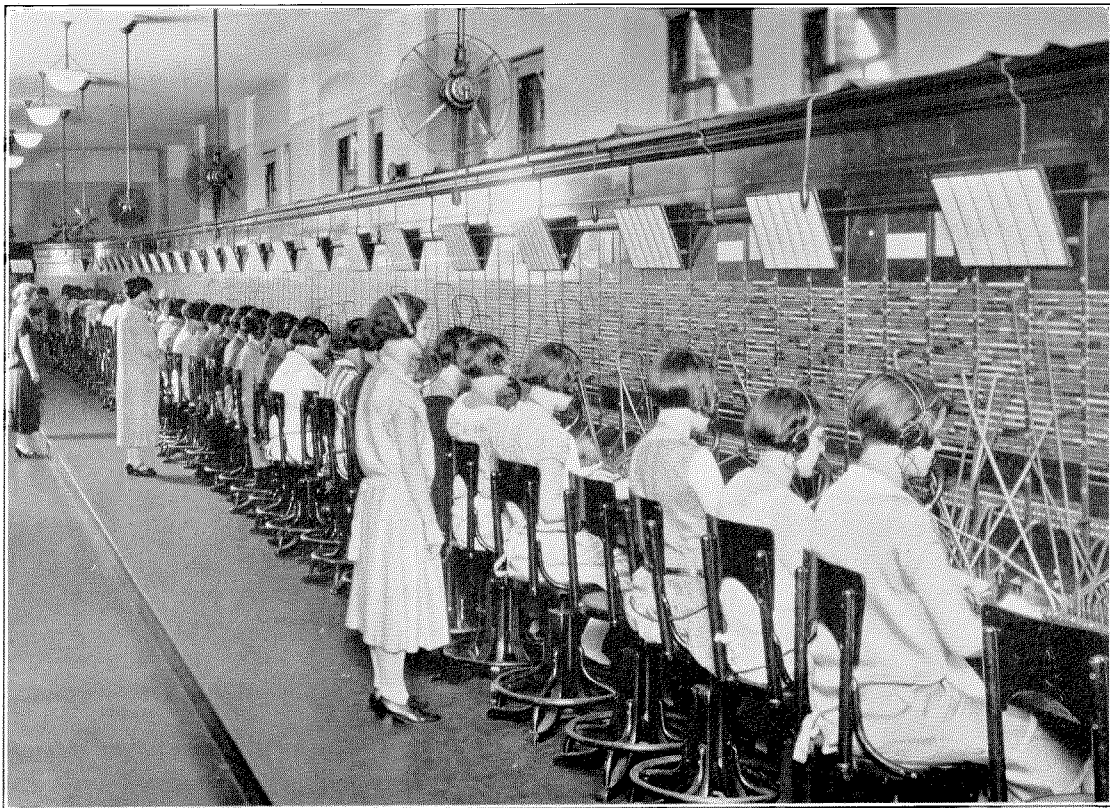

Switchboard Cords in Service—Canal A Board—New York Telephone Company

the called subscriber. With the guidance of the operator it corresponds to a selector of an automatic system but with this difference: a selector is purely mechanical in its operation, the conditions of service being exactly known and the mechanism designed accordingly. The switchboard cord, on the other hand, is subject to the whims of the operator; it is manipulated by human hands and in consequence is heir to the sort of abuse that is associated only with the

life consists in putting the cord through an actual service test. This method is too slow for use as a regular procedure.

It has been possible, fortunately, to devise tests for switchboard cords that make it practicable to procure, within a reasonable time, comparative data on the probable life of the cords in service, and for use in the study of suggested improvements in construction. In view of their fundamental importance, they



will be discussed as a preliminary to the historical and descriptive information contained in this paper.

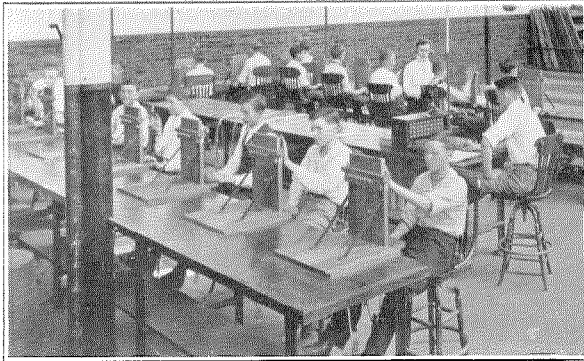

Figure 1—Cord Testing Room

### **Comparative Life Tests**

Cord testing boards are maintained by the Western Electric Company, Inc., and are manned by young men operators who, by movements closely akin to those employed by telephone operators, simulate service conditions as nearly as possible. Figure 1 shows the general arrangement of the test room.

The actual operations through which the cords are put must be as nearly alike as possible and conform closely to past testing practice since otherwise the comparative value with past tests would be lost.

The sequence of operations involved is as follows:

(A) The plug resting on the plug seat is grasped and raised to the line of a jack with the tip of the plug placed in the sleeve hole of the jack.

(B) The plug is inserted in the jack by opening the hand, and driving home the plug firmly by pressing the flat palm of the hand against the bend of the cord which forms naturally at the heel of the plug.

(C) The cord is grasped about six inches from the heel of the plug and pushed forward, close to the plug forming a loop in the cord and with this same grip the plug is jerked out of the jack.

(D) This hold on the cord is released and the plug allowed to fall back in its seat.

These operations are performed with each hand alternately and the cycles repeated. Figure 2 illustrates the operations.

To eliminate the possibility of one operator giving the cords rougher treatment than another, the operators exchange positions and the cords are tested for noisy conductors every half hour. This test is made by bending the cord backward and forward at the heel of the plug and if scratchy or noisy the useful conductor life has ended. From this point on the test is continued in the same manner until the external braid is worn through to the reinforcement at the plug end. The number of operations before breakage of the conductors occurs or the braid becomes worn through is accurately counted by an automatic mechanism.

In spite of all the pains that are taken to duplicate service conditions at these test boards, it is found that the results obtained are considerably at variance with the results of actual service tests. In the shop tests the cords are perhaps more roughly handled by the testers than by the average switchboard operator. On the other hand, the cord is not affected by perspiration to the full extent in the few days required to complete the tests. The result is that, in general, the conductors become noisy much sooner in the shop tests than in service but on the other hand the braid life relative to conductor life is much more favorable in the shop tests. In the shop tests on the No. 447 cord, which has been standard until recently for toll and local positions using  $\frac{3}{8}$ " center jacks, a noisy conductor usually develops after about 12,000 operations but the braid does not fail until about 29,000 operations. In service the same cord usually develops braid trouble in about 16,000 operations, the conductors not having become noisy in the meantime. This brings about a repair (which will be discussed later), resulting in new conductors and braid coming into play at the butt of the plug.

### **Cord Requirements**

The present day switchboard cord, like all other telephone devices, is the result of evolution. In the early days, the switchboard cord, although relatively just as important a link as today, had not the volume of service

to perform, nor was it restricted in dimensions nearly to the extent of today. The modern multiple switchboard crowds into minimum space the maximum number of subscribers lines. In general the minimum spacing of the multiple jacks is  $\frac{3}{8}$ " vertically and horizontally. The plug attached to the cord must be slightly less in diameter than  $\frac{3}{8}$ " and the cord must be even less to fit into the plug. The dimensional restrictions on present day cord construction, therefore, are apparent.

The ideals striven for in switchboard cord construction are: (a) small diameter, (b) low resistance, (c) long life, (d) flexibility, (e) low moisture absorption qualities, (f) high insulation resistances, (g) low cost. In practice, limitations are encountered that compel a compromise or rather a balancing of qualities in order that a cord may result, reasonably meeting all of these seven requirements without over-emphasis of any one of them.

### ***Evolution of Cord Construction***

As early as 1878, we have conclusive evidence that flexible electrical conductors were constructed of tinsel. We have, however, no constructional data bearing on this conductor. In the generally accepted sense, tinsel is a metallic thread used for purposes of ornamentation. It is made by rolling fine wire, usually of copper, down to a thin ribbon and serving this ribbon helically on a cotton or linen thread producing what is known as tinsel thread. Maximum brilliancy is obtained by gold or silver plating the wire before rolling.

It is notable that for a number of years the commercial tinsel thread of commercially pure copper, either with or without plating, was used for making tinsel switchboard cord conductors. The use of a bronze alloy tinsel having much greater ability to resist bending or taking a permanent set without becoming brittle, thus adding greatly to the life of the tinsel conductor, is of comparatively recent date. The plated tinsel is not objectionable except for cost. It adds nothing to the worth of the cord, however, and has not been generally used by the Western Electric Company, Inc.

Cord conductors since the beginning of the industry have followed either one of three forms, namely:

- 1—Laminated conductors built up of a number of tinsel threads twisted or braided together.
- 2—Solid conductors of steel or brass wire or tape wound helically to secure the necessary flexibility.
- 3—A combination of the laminated and solid conductors.

At times differentiation occurred between local and toll cords due to the higher resistance of the conductors in some types of construction. This may be seen by referring to Figure 3. That it was necessary at periods in the past to maintain two cords, one for local and the other for toll service, was due directly to the need of higher conductivity in toll than in local cords in order that the grade of transmission might be maintained as high as possible. Until a cer-

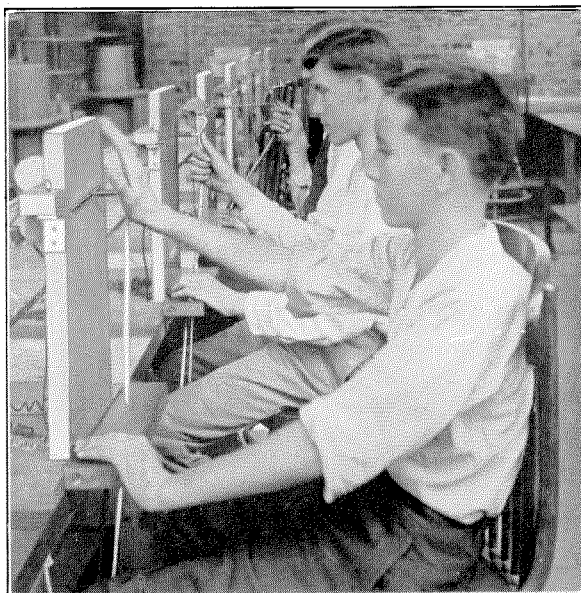

Figure 2—Cord Test

tain period in the development of tinsel cords was reached, the life of solid conductor cords was far beyond that of tinsel cords. The maintenance factor on local cords is of greater importance than on toll cords for the reason that so many more are required. In consequence the long life, high resistance, steel, helically wound cord was standard for many years for local service while the tinsel type having much lower resistance but a great deal shorter life was standard for toll service.

In 1887, we gather from records that are vague in spots that the Western Electric Company, Inc., was furnishing two varieties of switchboard cords. One, which was probably used in local connections, was made up of

It was finished at the plug end for use with plugs designed for  $\frac{7}{16}$ " center multiple jacks. About 1900, the  $\frac{3}{8}$ " center multiple jack made its appearance together with a cord known as the No. 136 for use with the plug

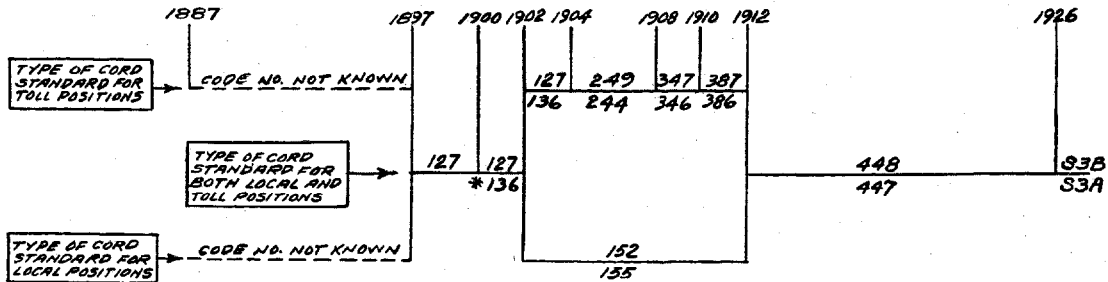

Figure 3—Local and Toll Cords—1887 to Date

conductors formed by iron wire wound around a linen cord. This cord had high conductor resistance. For long distance connections another cord, made up of extra heavy gold tinsel conductors, probably was used. Detailed constructional data on these two cords are not available and the records are not sufficiently clear to say with any degree of certainty that a differentiation was made between local and toll cords at this early date.

designed for the new jack. The No. 136 cord was the counterpart of the No. 127 except that the diameter at the plug end was reduced by leaving off some of the reinforcing braid. From 1900 to the present day it has been necessary to supply two switchboard cords, one for the  $\frac{7}{16}$ " center jack No. 49 and the other for the  $\frac{3}{8}$ " center jack No. 92, these cords differing constructionally only in the amount of reinforcing braid at the plug end. The cord for the  $\frac{3}{8}$ " jack having less reinforcement naturally does not stand up quite so well as the one for the  $\frac{7}{16}$ " center jack. Since it is the weaker of the two, plugging tests and service trials are usually made on the  $\frac{3}{8}$ " center cord and the number of operations that may be expected before trouble develops, referred to in this paper, apply to it. The chart, Figure 3, shows corresponding "small" and "large" cords at different periods. (The No. 244 cord, Figure 4, is very similar in appearance to the No. 127 and No. 136 cords).

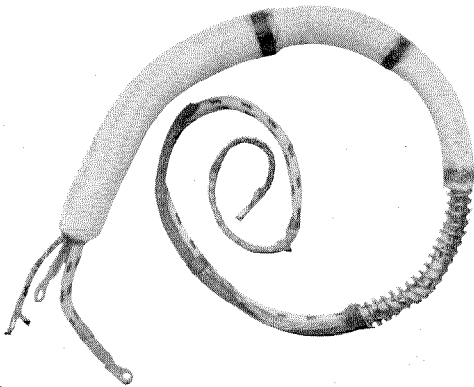

Figure 4—No. 244 Switchboard Cord

In 1897, a type of cord known as the No. 127, a compromise between a steel local and a tinsel toll cord, made its appearance. Unfortunately a photograph of this cord is not available but it probably was made up of a combination of tip and ring conductors of tinsel and a sleeve conductor of brass wire, helically wound. The resistance was such that the cord was considered suitable for both local and toll work.

In 1902, we find a new cord known as the No. 155, Figure 5, for local positions only, the tip and ring conductors being formed of flat steel helices laid concentrically and the sleeve of a copper and a steel helix, wound reversely and in contact at each convolution. The resistance of the conductors of the six foot cord is 9 ohms for the tip (center helix), 11 ohms for the ring (intermediate helix) and 1 ohm for the sleeve. This cord had very good life characteristics and remained standard for local positions until about 1912.

In 1904, improvements were made in the No. 136 cord that not only increased the life but reduced the conductor resistance. This cord, known as the No. 244, Figure 4, was made up of a brass helix in contact with a

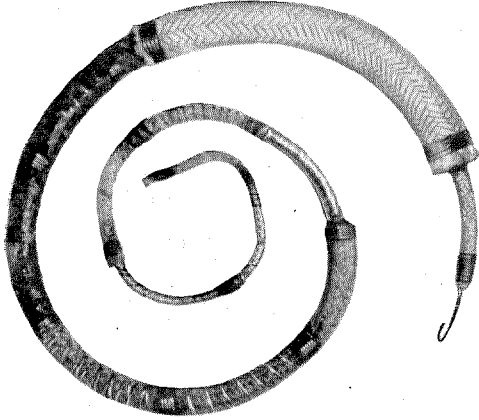

Figure 5—No. 155 Switchboard Cord

copper tinsel conductor forming the sleeve and the copper tinsel conductors within the helix forming the tip and ring conductors. It replaced the No. 136 for toll positions. The tip and ring conductors were about  $\frac{6}{10}$  ohm and the sleeve about  $\frac{3}{10}$  ohm for a six foot cord.

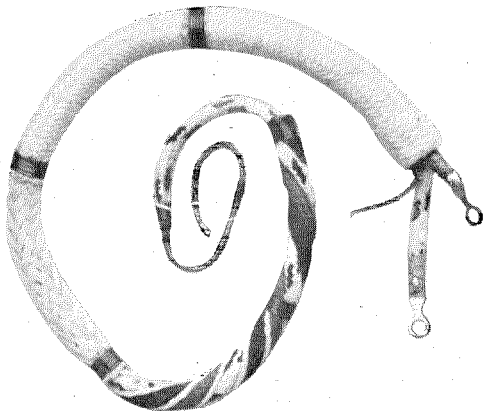

Figure 6—No. 346 Switchboard Cord

In 1908, the No. 346, radically different from the cord previously used, was introduced for toll work. In the No. 346 cord, Figure 6, the tinsel conductor was formed by braiding tinsel threads together, but instead of using a brass helix surrounding the tip and ring conductors for the sleeve all three conductors were of tinsel, which after being insulated were twisted together in rope form, the space be-

tween the conductors being filled with cotton threads to make the surface approximately cylindrical. The resistance of each of the three conductors was about  $\frac{9}{10}$  ohm for a six foot cord. The rope construction somewhat improved the life of the conductor. It is the first cord in which plugging tests were recorded, the first sign of conductor breakage appearing at about 3820 operations. It was standard for toll positions until 1910 when the No. 386 cord made its appearance.

In 1910, a very great improvement in tinsel cords was introduced in the shape of the No. 386 cord, Figure 7, which replaced the No. 346

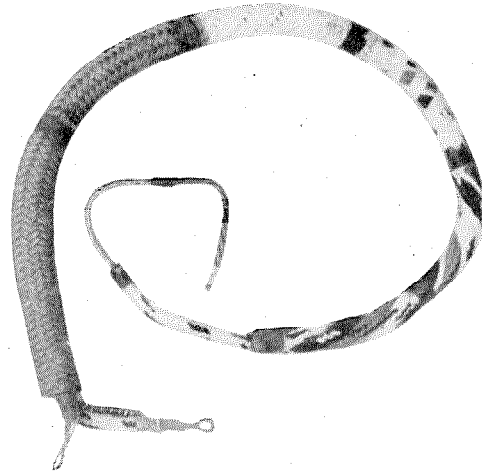

Figure 7—No. 386 Switchboard Cord

for toll service. The principal feature of this cord was the use for the first time of an alloy tinsel known as the No. 36 tinsel in place of commercially pure copper. A change in construction was made at this time by twisting six ends of the new tinsel thread together instead of braiding. Three such units were twisted into a rope making a conductor of 18 tinsel threads and, in turn, three such conductors after being insulated were twisted into rope form. Filler threads were also used in this conductor. The three conductors were each about  $\frac{9}{10}$  ohm for a six foot cord. The record of plugging tests shows a life for this cord of approximately two times the No. 346 which it replaced. It was standard for the Bell System for toll service until 1912, the No. 155 steel cord remaining the standard local cord until that time.

1912 saw the results, for which cord designers had long been waiting, realized. They succeeded in producing a cord of tinsel conductors comparing favorably in life with the steel No. 155 cord. It was known as the No. 447 cord and replaced the No. 155 cord for local service and the No. 386 for toll service, making but one cord for both services. The construction of the No. 447 cord, Figure 8, was practically the same as the No. 386 but it was treated with a bituminous compound that served to moisture-proof the cord without stiffening it to an objectionable extent. At the same time this moisture-proofing added considerably to the conductor life. The resistance of each conductor of this cord was about  $\frac{9}{10}$  ohm for a six foot cord and the record of plugging tests shows that about 12,000 operations are necessary before any one of the three conductors become noisy. The No. 447 cord remained the standard local and toll cord until early in 1926.

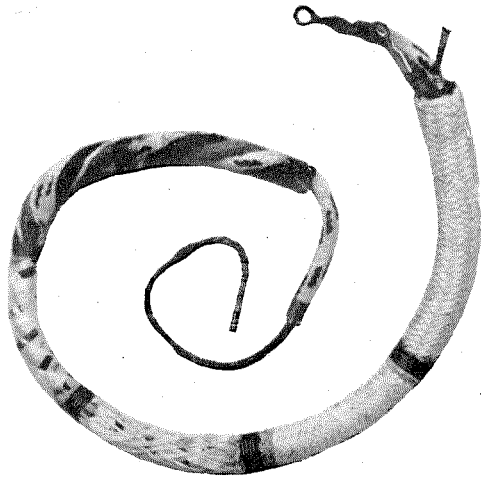

Figure 8—No. 447 Switchboard Cord

A new cord has now been standardized for both services, known as the double end tinsel type and coded the S3A switchboard cord. This new cord conductor is constructed of six tinsel threads of No. 36 alloy tinsel twisted about a central cotton thread, acting as a filler. The tinsel thread is different from that heretofore used, each cotton thread having two servings of the metallic ribbon applied at the same time in the same direction; that is, the two ribbons one on top of the other are applied to the cotton thread just as a single ribbon would be. The resistance of each

conductor of this new cord is about  $\frac{9}{10}$  ohm for a six foot cord. The conductor life is at least 50 per cent better than that of the conductor of the No. 447 cord. With the exception of the conductor, the construction is



Figure 9—Enlarged View of Conductor S 3A Switchboard Cord

identical with that of the No. 447. Enlarged views of the new conductor and also the conductor of the No. 447 cord are shown in Figures 9 and 10 for comparative purposes.

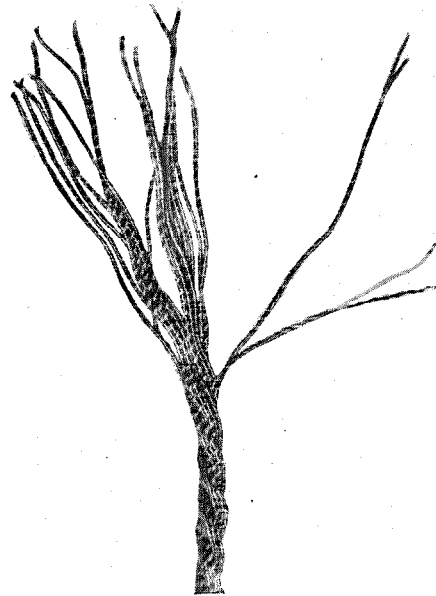

Figure 10—Enlarged View of Conductor 447 Switchboard Cord

Previous to the development of the S3A cord, failure would appear first in the shop tests in the conductors. With the double end type of tinsel conductors the condition is not so pronounced as the conductors frequently outwear the braid. This improvement in conductor life is reflected in service in this way: braid failure becomes a still greater proportion of cord troubles than before. Braid failure, however, can be detected by visual inspection and has no effect on telephone service while conductor failure is likely to interfere with the service before it is detected. The ideal service condition is met when the braid fails just before the conductors fail. A repair as described later will then bring new braid and new conductors at the point of greatest wear.

### **Cord Maintenance**

Cord maintenance in a large central office is an important item. On the average a cord is operated 70 times each working day. With the best sort of a cord the first repair must be made in about nine months or after some 16,000 operations since there are calculated to be 26 working days per month. Repairing of cords is therefore an important element in the maintenance and special tools have been developed for the purpose, known as the Nos. 312, 313, 314, 315, 316, and KS-2348 tools. (See Figures 11 to 16).

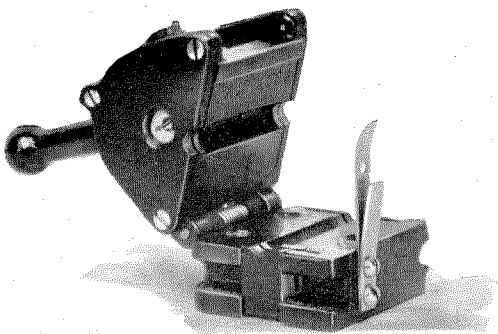

Figure 11—No. 312 Tool

The No. 312 tool, Figure 11, is used for cutting off the end of the cord and severing the braiding and reinforcement about 2" back from the new end. The tool holds the cord while the handle is pulled forward bringing two knives into position. One of the knives

trims off the frayed end while the other about 2" from it is in proper position to sever the braiding and reinforcement when the cord is revolved by hand.

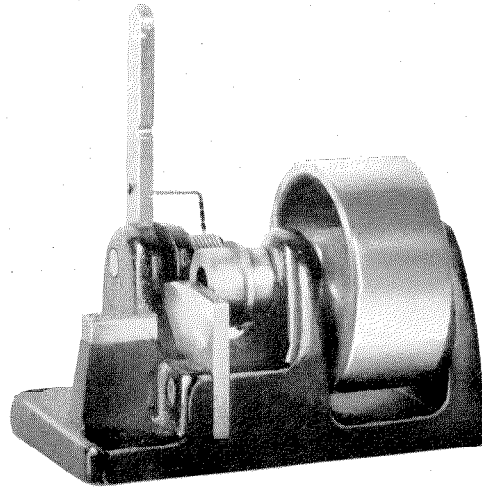

Figure 12—No. 313 Tool

The No. 313 tool, Figure 12, is used to sever the braiding on the individual conductors. Each conductor is inserted in the hollow shaft and held by a clamping bar in proper position for a cutter to be rotated by the handwheel and sever the braiding.

The No. 314 tool, Figure 13, is a pair of tweezers used to remove the braiding and reinforcements severed by the Nos. 312 and 313 tools from the cords and conductors.

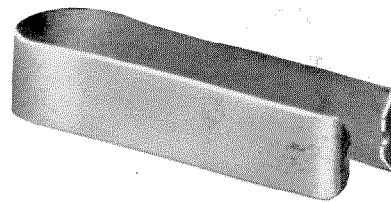

Figure 13—No. 314 Tool

The No. 315 tool, Figure 14, is a pair of pliers arranged with an adjustable needle point in one jaw which pierces the tinsel conductors, thus making a hole for the screws used to attach the individual conductors to the plug terminals.

The No. 316 tool, Figure 15, is used for untwisting the plug from the cord to be repaired

and twisting the plug on after the repair is made. It consists essentially of a hollow shaft driven by a crank and equipped with a chuck for gripping the plug.

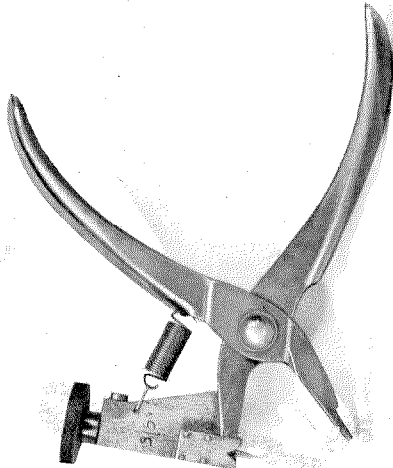

Figure 14—No. 315 Tool

The KS-2348 tool, Figure 16, is a small screw-driver with a projecting point that fits into a hole in the plug terminal screws and the shell screw preventing them from falling when being removed or replaced.

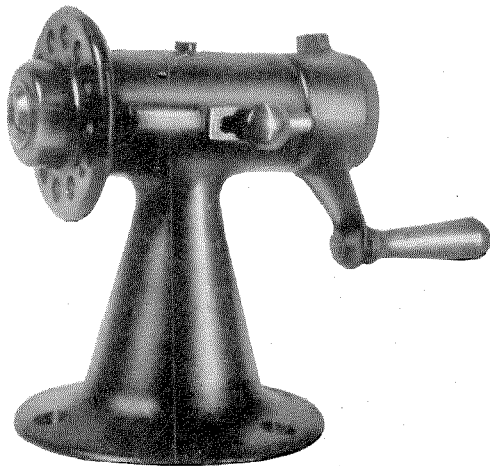

Figure 15—No. 316 Tool

With the use of these tools, repairs may be made very quickly at the switchboard without disconnecting the cords from the cord shelf. For the purpose, there has been developed a repair table mounted on casters which is equipped with the previously described tools or others performing essentially the same functions. This table is

shown in Figure 17. In some cases it may be found more convenient to take the cords to the repair shop and repair them in quantities. The cost of such repairs in general is of the order of \$0.10 to \$0.15. These repairs must be made increasingly often as the cord is in service. For example, the first repair may be necessary at the end of nine months, the second in six months, the third in five months and a



Figure 16—KS 2348 Tool

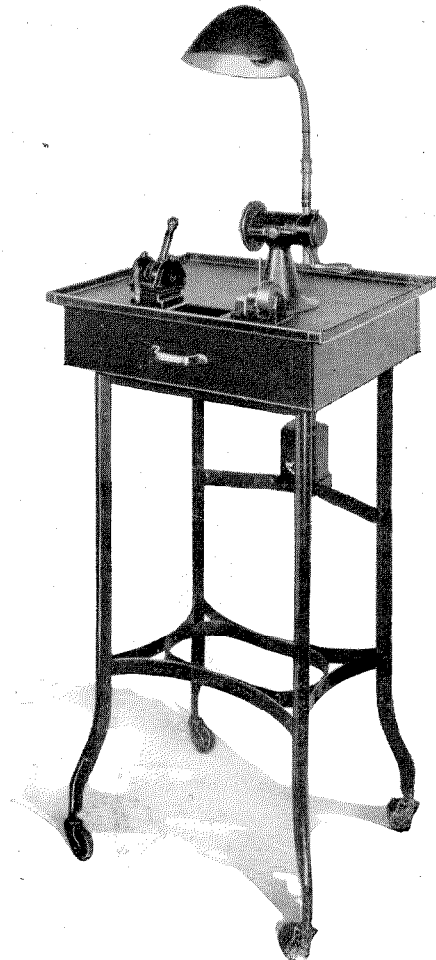

Figure 17—Repair Table

fourth, if the braiding is still good, may be made in four months. Usually, three to four repairs are obtained.

A point that must be considered in switch-

board cord maintenance studies is the balancing of the first cost of the cord against the total annual charges. Cord life is dependent not only on the constructional features but to an even greater degree on the quality of tinsel thread used in its construction.

Tinsel thread for the purpose must meet certain established conditions as follows:

- (a) The thread forming the core must not, for structural reasons, exceed a certain maximum diameter, yet its tensile strength must not fall below a certain minimum.
- (b) The metallic ribbon must be laid on the thread with special regard to the pitch. There is one best spacing of the successive convolutions and this must be uniformly maintained.
- (c) The metallic ribbon must have springiness or ability to stand much bending without breaking or permanently setting. This is not obtained with copper ribbon. All sorts of alloys were experimented with and No. 36 alloy (a number which is now used by the Western Electric Company, Inc., to designate their present tinsel) proved to be the best.
- (d) The material from which the metallic ribbon is rolled must be of uniform quality. To insure that No. 36 tinsel will give long and consistently uniform life, the preparation of the alloy and the drawing of the wire from which the tinsel ribbon is rolled require careful attention.
- (e) The metallic ribbon must have its thickness and width maintained within well defined limits. It has been found that this has an important bearing on the life of the completed cord.

Test data show that with construction differing in no other way except the use of the ordinary market quality of tinsel of commercially pure copper in place of No. 36 alloy

tinsel, the cord life will be reduced one-half to two-thirds. The No. 36 alloy tinsel costs more than the copper variety; however, the amount required for a cord is so small that the difference would be only a few cents and this would represent the total difference in cost between the two cords. While the use of the No. 36 tinsel may cost the consumer \$0.05 per cord more than he would have to pay for the same cord with copper tinsel conductors, he would be getting very good returns for this small sum. At best one year of service with three repairs at \$0.12 each may be expected from the "copper" cord of proper construction. Two years of service with three repairs at \$0.12 each may reasonably be expected from the No. 36 tinsel cord. For the sake of saving \$0.05 initially a very inferior cord using copper tinsel would be purchased which, on a yearly basis, would cost \$0.36 plus the original price as against \$0.18 plus one-half the original price for the No. 36 tinsel cord. In addition to this economic waste there would be the inevitable deterioration in telephone service that cannot be expressed in dollars and cents brought about by noisy or scratchy conductors developing prior to braid trouble and consequent aggravation to telephone subscribers.

### **Conclusion**

Consideration of switchboard cord construction, service requirements and maintenance factors makes it apparent that small additions in cost occasioned by improvements in design, such as the use of the No. 36 alloy tinsel described in this paper, are apt to be counterbalanced many times by the saving in maintenance costs.

It seems apparent that in the future, as in the past, the rate of progress made in cord design will be dependent to an important degree on forced shop or laboratory tests similar to those described above. The importance of these tests in furnishing data on which to forecast the probable life of cords can hardly be over-estimated.





Track Automobile After Collision with Locomotive

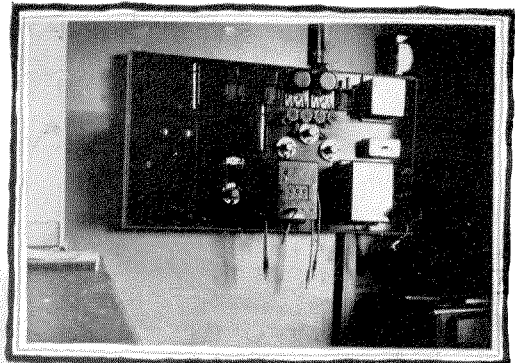

Local Train Despatching Station



Santa Fe Control Office

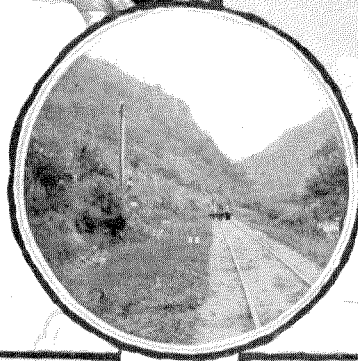

Line Construction Cordoba Hills

Train and Apparatus Gang



Pole Line Near Santa Fe



Cheroti Indian, Bolivian Frontier



# Telephone Train Control in the Argentine Republic

By C. F. BULSTRODE WHITLOCK

*Telephone and Railway Sales Manager, Compañía Standard Electric Argentina*

THE convenience and desirability of installing telephonic train control in the Argentine Republic was first demonstrated by the Western Electric Company, Limited, (Buenos Aires Office), during 1912 to all the railway companies simultaneously. In January, 1913, the first circuit was installed on a trial basis between Buenos Aires and Junín, a distance of 255 kms., on the Buenos Aires Pacific Railway.

This Railway had the advantage of possessing a metallic circuit on the Buenos Aires and Junín Division, composed of No. 11½ S.W.G. copper wire. At that time, neither the possibilities of using iron wire nor the idea of superimposed telegraph working on the train control metallic loop had been given serious consideration.

Some twenty-five way-stations were installed with the control office in Buenos Aires. From Pilar, 55 kms. out of Buenos Aires, the track was practically all single, with double tracking under construction. Within a short time, the experiment was found to be entirely satisfactory and, in view of the economies involved, the equipment was purchased by the Railway Company. No additional installations were made until March and October, 1914, when the same Company purchased equipments and installed them on their Villa Mercedes and Mendoza Divisions. Due to the outbreak of the European War, all projects under consideration were held up.

In July, 1916, train control equipment was installed on the Buenos Aires Pacific Railway between Junín and Laboulaye; in October and November of the same year, on the Buenos Aires Great Southern Railway between Buenos Aires and Seigné, and Seigné and Ayacucho, and on the Compañía General de Ferrocarriles de la Provincia de Buenos Aires between Buenos Aires and Salto. These two latter installations were the first to employ existing iron telegraph wires and to superimpose telegraph working over the metallic loop of the control circuit. On the Southern

Railway circuit between Buenos Aires and Seigné, 191 kms. in length, No. 8 B.W.G. was used, which had been erected some years previously. The Compañía General de Ferrocarriles circuit between Buenos Aires and Salto was 208 kms. long and was composed of No. 7 S.W.G. Both these circuits proved entirely successful and superimposed telegraph working was found feasible so that the practicability of train control over a division employing an iron wire No. 8 B.W.G. circuit at least 200 kms. in length was demonstrated. It was evident also that, if a railway company could afford, given telephonic control facilities, to dispense with one telegraph wire, the telephonic control facilities could be provided without the necessity of stringing additional wires, the only outlay being the cost of the apparatus as installed, and the labour of making transpositions in the line wires.

Notwithstanding the prevailing financial stress, economies involved in telephone train control were such that other companies planned trial installations. In May, 1917, the Southern Railway authorized a large project and the Compañía General de Ferrocarriles decided to equip the remainder of its main line to Rosario. A similar decision was made in September, 1917, by the Argentine State Railways in connection with a 396 km. circuit of No. 7 B.W.G. iron wire between Santa Fé and Bandera, the control office to be located in San Cristobal half-way between the two points and the circuit to contain 35 way-stations. It is of interest to note that, with the control office in the circuit continuously, transmission with either terminal was satisfactory regardless of the number of stations listening in and superimposed duplex telegraph working. This installation was the first to employ the 60-A type alternating current selector which is superior in impedance characteristics to the older 50-A type direct current selector used on the circuits previously mentioned.

At this period, labour strikes occurred which paralyzed railway traffic over the entire coun-

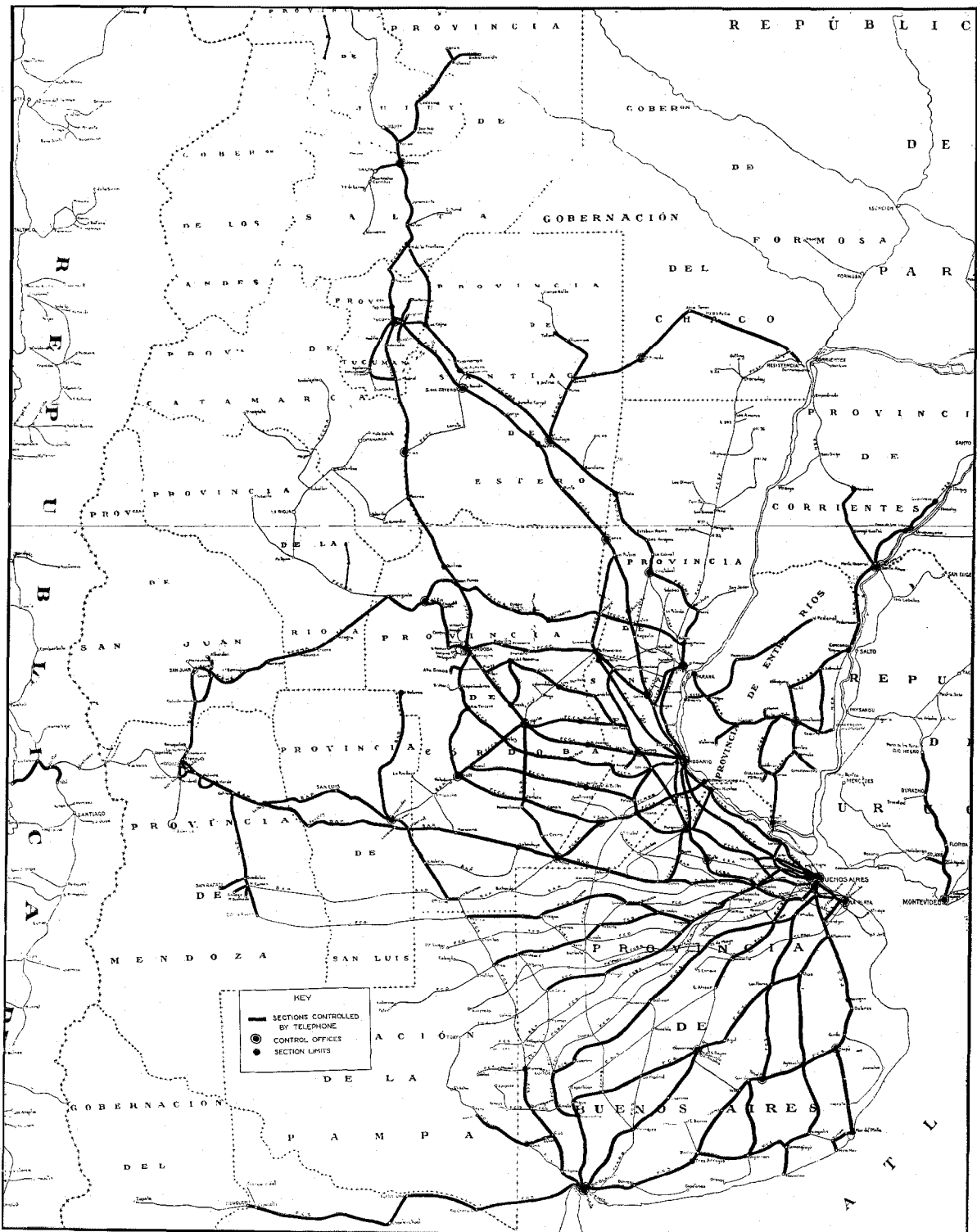

Railroad Map of the Argentine Republic, Showing Installations of Western Electric Telephonic Train Control Equipment

try for some three weeks and which brought about Government labour regulations restricting working hours and entailing the employment of larger staffs. Consequently, it became a matter of paramount importance to find some method of increasing useful engine hours and of suppressing the "planting" of trains in way-stations while crews were resting on completing their hours of duty. The lack of adequate means of communication was appreciated immediately and from that time, telephonic train control came into its own. Thus train control equipment was installed by the Central Argentine State Railways on its first section of three divisions between Rosario and Tucumán (August, 1918); the Entre Ríos Railway between Ibicuy, Basavilbaso and Concordia (August, 1918); the Central Córdoba Railway between Frontera, Alta Córdoba and Quilino (September, 1918); the Pacific Railway between Bahía Blanca, Rivera and Villa Iris, the latter employing an iron wire circuit of 217 kms. (September, 1918); as well as between Villa Mercedes and Villa Dolores on an iron wire circuit 224 kms. in length (December, 1918).

In January, 1919, the Entre Ríos installed the line between Basavilbaso and Paraná and, in March, authorized the purchase of material and apparatus for the remainder of its track mileage. In the same month the Central Córdoba installed a further section between Frontera and Rosario; the Province of Santa Fé Railway between Santa Fé and Rosario in July. In October, the Central Argentine, a strong and important Railway, placed an order for equipment covering about 95 per cent of its total mileage. On the latter, only iron wire has been used and the entire Railway has been divided into suitable control areas on a most economical basis.

The situation on the Buenos Aires Western, the last of the large broad gauge railways to adopt the system, deserves mention. For some years, it was in possession of a very efficient telegraphic control system, but eventually, in November, 1920, as the officials had foreseen, they were obliged by the stress in their telegraphic communications, caused by the arrangements necessitated by the Government regulations and their complex interpretations, to adopt telephone train control.

A scheme was carefully worked out and completed covering some 45 per cent of the total mileage, and is now operating at high efficiency, it being possible to reach by telephone from the Chief Control Office at Buenos Aires, Trenque Lauquen, 444 kms.; Pico, 524 kms.; Ameghino, 403 kms. distant and any immediate station or locomotive depot.

An additional step in advance occurred in July, 1922, when the Argentine State Railways decided to equip practically the whole of its Central Northern System. The entire contract was carried out by the Compañía Western Electric Argentina, including the provision of line material, wire, apparatus and the actual work of stringing the wires. Many tons of iron and copper wire and large quantities of insulators and pins were required in connection with the stringing of 3,500 kms. of metallic circuit, as well as equipment for the control offices and numerous way stations. Work was commenced in October, 1922, and finished in December, 1923.

Three line gangs of fourteen men each and an apparatus gang of three men were employed to do the work under the direct supervision of the writer. Each line gang, when working at full pressure, put on cross arms and strung wire at an average rate of 4 kms. per day beside doing minor repair work when necessary. Each line gang carried the materials they required and had their living quarters in five box cars. A travelling tank car was provided to insure a supply of fresh water since in many sections no water was available for miles, or it was too salty to be drinkable. The writer's headquarters during the whole period of construction were in a private car. A Drewry track automobile capable of speeds up to 50 miles an hour was available in order to reach the gangs and supervise their work. This car covered as much as 450 kms. in a day on several occasions. Practically all the labour employed had to be trained on the job, even the apparatus being installed by people who had never carried out such work previously. The existing line construction was not particularly good. There were quite long stretches of line with only 10 poles to the km. and, in general, the average was 12. Close to the Bolivian frontier, it was necessary to break a

path through a sub-tropical jungle. In the Chaco territory which, up to a few years ago, was wild and the home of the Indian, the gangs had to work in miles of swamps with water as a rule up to their knees, many an alligator

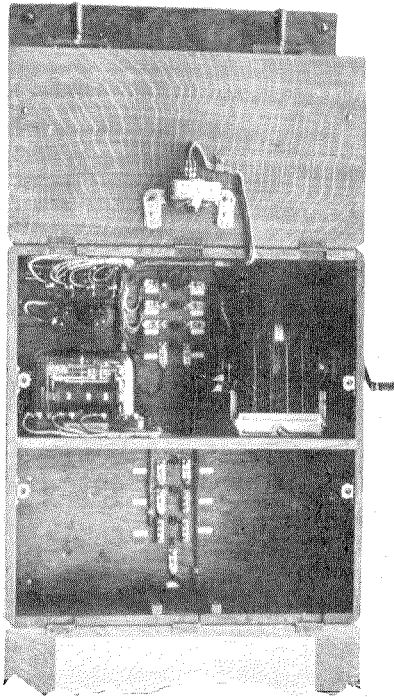

Figure 1—BA 160 Selector Set, Showing Upper and Lower Sections

being disturbed as they passed, as well as numerous snakes.

In view of the fact that work was often carried out far from centres of population, each gang, as a precautionary measure, was furnished with a first aid kit which contained the necessary articles for immediately attending to wounds, which, if left to themselves, would rapidly become unhealthy, as well as medicines for the treatment of simple ailments; also a generous supply of injections for snake bites, which latter fortunately were never required. Each man was obliged to purchase a mosquito-net and to use it. The foreman of each gang saw that neither wounds nor incipient sickness were neglected, it being considered better to insist on a man being laid up rather than risk his general health by continuing to work, on the off chance of getting

well under arduous working and climatic conditions. The result of this policy was highly satisfactory, since the speed of the work was not materially affected by the high temperatures that were encountered—on one occasion inside the private car at 4:30 P.M. the thermometer marked 42 degrees centigrade (108 degrees Fahrenheit), which goes to show that the men were kept very fit. Calls for outside medical assistance during the period of construction were not necessary.

To pass on to the completed installation—the transmission results were outstanding. Between Santa Fé and San Juan, there were 501 kms. of No. 9 B&S and 443 kms. of No. 12½ S.W.G. copper wire circuit, three control operators, six No. 47-A repeating coils for sim-

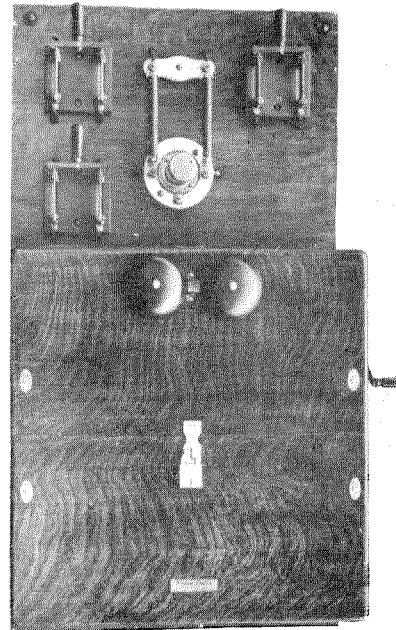

Figure 2—BA 160 Selector Set

plex working, and 66 way-stations; nevertheless reasonably good speech was obtainable between the points mentioned. Between Santa Fé and Tucumán there were 797 kms. of No. 12½ S.W.G. copper wire circuit, three control operators, six simplex coils and 72 way-stations, and it was still possible to hold conversations from end to end though not quite so well as in the previous case.

Such results, of course, meant that the State Railways was put in possession of means of

communication which were incomparably superior to the old telegraph method of giving station instructions and obtaining information. Previously a divisional office, after trains were about 50 kms. distant, was entirely unable to get in direct touch with any ordinary way-station, so that train crews scarcely ever got through a scheduled run within the regular ten hours of duty. This meant "planting" which, as previously intimated, consisted in pulling the fire at any wayside station when time was up, resting twelve hours, raising steam and then continuing the trip. With the telephonic control system, a control office can reach immediately any station or locomotive depot on its division, and is able, as well, to talk to the adjacent division operator, so that suitable arrangements can be made to get trains through on schedule time. "Planting" has now practically disappeared.

In the latest installation, the self-contained way-station set, designed by the writer, was furnished. As will be seen by reference to Figures 1 and 2, the apparatus is contained in a double compartment oak apparatus case, the upper section containing the apparatus and the lower the dry cells. Although not essential, two sets of cells are furnished, one for ringing and another for use in connection

with the transmitter. Two sets are preferred for the reason that a set which is no longer suitable for use in speech transmission may still be employed for ringing purposes. A circuit label is attached to the door, which gives the apparatus man all the information he requires for connecting up the set. Ordinarily, the set is used with a desk stand and foot switch; a fixed transmitter, push button and writing shelf can, however, readily be substituted.

The following statistics of installations completed or definitely sanctioned by the different railways, together with the map, will serve to summarize the extent to which Western Electric telephonic train control equipment is used in the Argentine Republic.

Railway	Kilo- metres of Circuit Installed	No. of Control Sections	No. of Way Stations	Percent- age of Total Track Equipped
Entre Ríos.....	1169	2	90	99.5
Central Argentine	4983	13	352	94.0
Central Córdoba..	1459	7	174	75.0
Great Southern...	3000	11	390	39.6
B. A. Pacific.....	3095	10	333	74.0
General of B. A...	377	2	46	29.6
Central of B. A...	100	1	17	24.7
Province of S. Fé.	166	1	20	8.7
State.....	3500	12	320	51.0
Western.....	1371	5	103	42.0

# Development and Application of Loading for Telephone Circuits<sup>1</sup>

By THOMAS SHAW

*American Telephone and Telegraph Company*

and WILLIAM FONDILLER

*Bell Telephone Laboratories Inc.*

*Synopsis:* A review of the art of loading telephone circuits as practised in the United States. The introductory section briefly reviews the theory of coil loading, and summarizes the principal characteristics of the first commercial standard loading coils and loading systems, thereby serving as a background for the description of the various improvements of outstanding importance which have been made in the loading coils and loading systems during the past fifteen years to meet the new or changing requirements in the rapidly advancing communication art.

These major improvements are described in detail under the appropriate headings (1) Phantom Group Loading, (2) Loading for Repeated Circuits, (3) Incidental Cables in Open Wire Lines, (4) Cross-Talk, (5) Telegraphy over Loaded Telephone Circuits, (6) Loading for Exchange Area Cables, and (7) Submarine Cables. The discussion of these various developments sets forth the relations between the loading features and the associated phases of telephone development, such as the cables, repeaters, telegraph working, and carrier telephone and telegraph systems.

The concluding part of the paper gives some general statistics regarding the extent of the commercial application of loading in the United States, and a brief statement indicative of the large economic importance of loading to the telephone using public.

*Because of lack of space this paper is printed in part only in this issue and will be concluded in July.*

## Introduction

THE year 1926 marks the fiftieth anniversary of the birth of the telephone, and the completion of the first 25 years of the commercial application of loading to telephone circuits by means of inductance coils inserted at periodic intervals. The present time is thus peculiarly appropriate for a survey of loading developments.

The purpose of this paper is to present a review of the art of loading telephone circuits, as practised in the United States. In a paper<sup>2</sup> presented before the Institute in 1911 Mr. B. Gherardi described the developments in loading up to that time and gave a comprehensive statement of the results obtained. In the present paper, therefore, references to the early developments in loading may be confined to matters

<sup>1</sup> Presented at the Midwinter Convention of the A.I.E.E., New York, N. Y., February 9, 1926.

<sup>2</sup> "Commercial Loading of Telephone Circuits in the Bell System," B. Gherardi, Trans. A. I. E. E., Vol. 30, 1911, p. 1743.

that are necessary to the treatment of the subsequent developments in the art.

During the period under consideration many improvements of outstanding importance have been made in the characteristics of the loading coils and in the loading systems, in order to meet new or changing requirements in the rapidly advancing communication art. The more important of these improvements are listed below and will be discussed in the sequence noted:

- I. Phantom Group Loading
- II. Loading for Repeated Circuits
- III. Incidental Cables in Open Wire Lines
- IV. Cross-Talk
- V. Telegraphy over Loaded Telephone Circuits
- VI. Loading for Exchange Area Cables
- VII. Submarine Cables

As a basis for the discussion of the characteristics of commercial loading systems and the various developments which have been made, the elementary theory of loaded lines and a review of the first loading standards will be given. Those interested in the exact mathematical theory are referred to more complete discussions which may be found in the bibliography appended hereto.

*Theory.\** It is convenient to discuss the coil loaded line in terms of its corresponding smooth line, a hypothetical line in which the constants of the inductance coils are assumed to be distributed uniformly along the line.

Table I gives simplified formulas which define the important line characteristics in terms of the primary line constants, the formulas being so arranged as to indicate directly the nature of the changes which occur when uniformly distributed inductance is added to a uniform line initially having zero inductance.

\* This section on Theory contains a small amount of discussion not included in the paper as presented.

TABLE I  
Approximate Line Formulas

Line Characteristics	Uniform Line Having Zero Inductance	Uniform Line Having Distributed Inductance
$\alpha$ , Attenuation constant	$\sqrt{\frac{pRC}{2}}$	$\sqrt{\frac{R}{2Lp}} \cdot \sqrt{\frac{pRC}{2}} = \frac{R}{2} \sqrt{\frac{C}{L}}$ (1)
$W$ , velocity of wave propagation	$\sqrt{\frac{2p}{RC}}$	$\sqrt{\frac{R}{2Lp}} \cdot \sqrt{\frac{2p}{RC}} = \sqrt{\frac{1}{CL}}$ (2)
$Z_0$ , characteristic impedance	$\sqrt{\frac{R}{pC}} / 45^\circ$	$\sqrt{\frac{Lp}{R}} / 45^\circ \cdot \sqrt{\frac{R}{pC}} / 45^\circ = \sqrt{\frac{L}{C}}$ (3)

In the above,  $\alpha$  is the real part of the propagation constant; and  $W = p/\beta$ , in which  $p = 2\pi f$  ( $f$  = frequency) and  $\beta$  is the wave length constant; *i.e.*, the imaginary part of the propagation constant. The formulas assume the leakage conductance  $G$  to be negligibly small; and in the case of the line with inductance, that  $R$  is small with reference to  $pL$ ;  $R$ ,  $L$ , and  $C$  being the line resistance, inductance, and capacitance per unit length.

Inspection of the formulas shows that the addition of distributed inductance:

(a) Reduces the attenuation constant and the velocity, provided that the ratio  $R/2L$  is less than  $p$ ; in practice, this limiting condition is approached only at very low frequencies which usually are of negligible importance in speech transmission.

(b) Increases the impedance, and improves the power factor.

(c) Makes the attenuation, velocity and impedance independent of frequency over the frequency range where  $R$  is small with reference to  $pL$ ; in practice, this condition holds generally, except at the low voice frequencies.

From the standpoint of the power transmission engineer, the general effect of loading in reducing the attenuation losses may be explained in terms of the changes in line impedance noted in (b) above. These impedance changes make it possible for the loaded line to transmit a given amount of power corresponding to speech sounds at a higher line potential and with a (proportionately) lower value of line current than is possible without the loading. In the non-loaded line which is inherently a low impedance line, the series dissipation losses which are proportional to the square of the line current are ordinarily very large relative to the shunt dissipation losses which are proportional to the square of the line potential. Consequently, when the line impedance is increased by a suitable amount the reduction in series losses is much greater than the increase in shunt losses and a substantial improvement in line efficiency is obtained

The optimum impedance for minimum line losses is that which results in the shunt and series losses being equal. Ordinarily, it is not economical to apply a sufficient amount of loading to reach this condition.

In general, commercial power lines are electrically short in terms of the wave length of the transmitted frequencies and consequently the sending end impedance is very largely influenced by the receiving end impedance. This allows high impedance transmission lines to be obtained by using high ratio transformers at the receiving end to step up the terminal impedance. On the other hand, telephone lines which are of interest from the loading standpoint are electrically long and the sending end impedance is practically unaffected by the terminal impedance. Consequently, the addition of series inductance to the line is the most practical way of increasing the telephone line impedance.

Investigating the question of concentrating the line inductance at uniformly spaced intervals, Professor Pupin gave his famous solution in a paper<sup>3</sup> presented before the Institute in May, 1900. Dr. G. A. Campbell in his paper<sup>4</sup> of March, 1903, also gave a mathematical development of the loading theory along somewhat different lines.

These early investigations showed that a coil loaded line should have several coils per wave

<sup>3</sup> "Wave Transmission over Non-Uniform Cables and Long Distance Air Lines," M. I. Pupin, Trans. A. I. E. E., Vol. 17, 1900, p. 445. Refer also to Pupin, U. S. Patents Nos. 652, 230 and 652, 231, June 19, 1900.

<sup>4</sup> "On Loaded Lines in Telephone Transmission," G. A. Campbell, *Philosophical Magazine*, March, 1903.



length in order to simulate a uniform line. The more closely the coils are spaced the more exact is the degree of equivalence, and when there are ten coils per wave length the equivalence is very close. On the other hand, the cost of the loading increases as the spacing is shortened. Thus, from the standpoint of commercial application, the question "What is the smallest number of coils per wave length that will give satisfactory transmission?" is very important. In the investigation which was made to determine the magnitude of the changes in attenuation, velocity and impedance, as the number of coils per wave length is reduced, abrupt changes in these characteristics were found to occur at the spacing of two coils per actual wave length. The critical frequency at which this spacing applies in a loaded line became known as the cut-off frequency, since at this frequency and higher frequencies the attenuation loss is so extremely large as to amount practically to a suppression, or cut-off effect.

At the cut-off frequency the velocity of the coil loaded line is lower than the velocity of the corresponding smooth line approximately in the ratio of  $2:\pi$ ; consequently, at the cut-off frequency there are approximately  $\pi$  coils per wave length, in terms of the velocity of the corresponding smooth line. The following expression defines the critical frequency in a coil loaded line having zero distributed inductance:

$$f_c = \frac{1}{\pi\sqrt{LsC}} \quad (4)$$

in which

- $f_c$  = cut-off frequency,
- $L$  = coil inductance,
- $s$  = coil spacing,
- $C$  = line capacitance per unit length.

[If the loaded line has distributed inductance, a correction is required in equation (4).]

The difference between the characteristics of a coil loaded line and its corresponding smooth line are sometimes designated "lumpiness" effects. They are due to repeated internal reflections at the points of electrical discontinuity in the line caused by the insertion of the loading coils. The lumpiness effects are usually small for the frequencies below approximately 75 per cent of the cut-off frequency. As the frequency exceeds this value, however, the lumpiness effects increase at an accelerated rate.

Figs. 1, 2 and 3 illustrate the differences in the attenuation, velocity, and impedance characteristics of a typical telephone cable, with and without loading. The characteristics of the corresponding smooth loaded line are also indicated, to illustrate the theoretical differences between uniform loading and coil loading. Fig. 1 includes

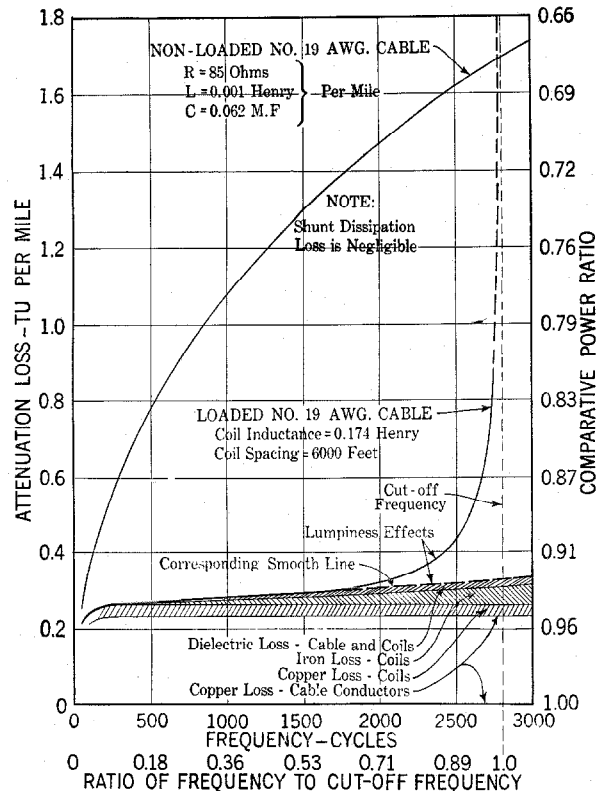

Figure 1—Attenuation-frequency Characteristics of Loaded and Non-loaded No. 19 A. w. g. Cable

curves which give an analysis of the different types of line losses, (a) the "series" losses due to heat dissipation in the conductor and the loading coils which are proportional to the square of the line current, (b) the "shunt" losses due to heat losses in the dielectrics, which are proportional to the square of the line voltage, and (c) the lumpiness effects due to internal reflections. The large reduction in the series losses accomplished by the loading is clearly indicated in the diagram. A corresponding proportional increase in the shunt dissipation loss also occurs, but as previously noted this effect is small in absolute magnitude relative to the decrease in the series losses. It is interesting to note that the particular type of loading illustrated in Fig. 1 so

increases the transmission efficiency of No. 19 A.W.G. cable that the loaded circuit can be used for distances about four times the permissible length of the non-loaded circuits. To obtain this increased transmission range without loading

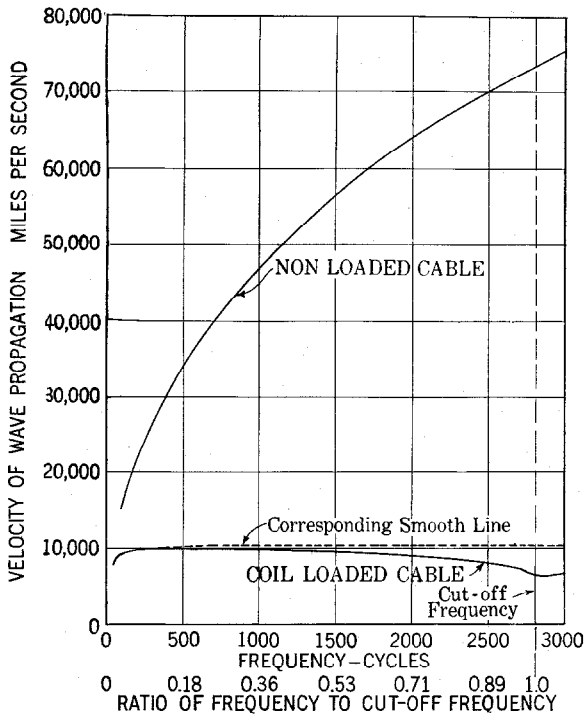

Figure 2—Velocity-frequency Characteristics of Loaded and Non-loaded No. 19 A. w. g. Cables of Figure 1

would require wires about eight times as heavy, i.e., No. 10 A.W.G.

Fig. 3 illustrates the dependency of the characteristic impedance of a coil loaded line upon the terminal condition. The most frequently used loading terminations are "mid-section" and "mid-coil." In the mid-section termination, the first loading coil is located at a distance equivalent to one-half of a regular loading section from the beginning of the line. Mid-coil termination is obtained by installing at the beginning of the line, a coil having one half of the inductance of the regular coils, the first full coil being installed at the end of the first complete loading section. For mid-coil and mid-section terminations, the characteristic impedance is approximately a pure resistance, which varies with frequencies as a complicated function of the ratio of the frequency to the cut-off frequency. With mid-coil termination the impedance-frequency character-

istic droops with rising frequency, approaching zero at the cut-off frequency. On the other hand, the mid-section termination has a rising characteristic, approaching infinity at the cut-off frequency.

*Early Standard Loading Systems.* One of the fundamental questions involved in the early commercial development work was that of determining what range of frequencies should be transmitted in order to furnish a satisfactory grade of speech transmission. The investigation of this point resulted in the adoption of a stand-

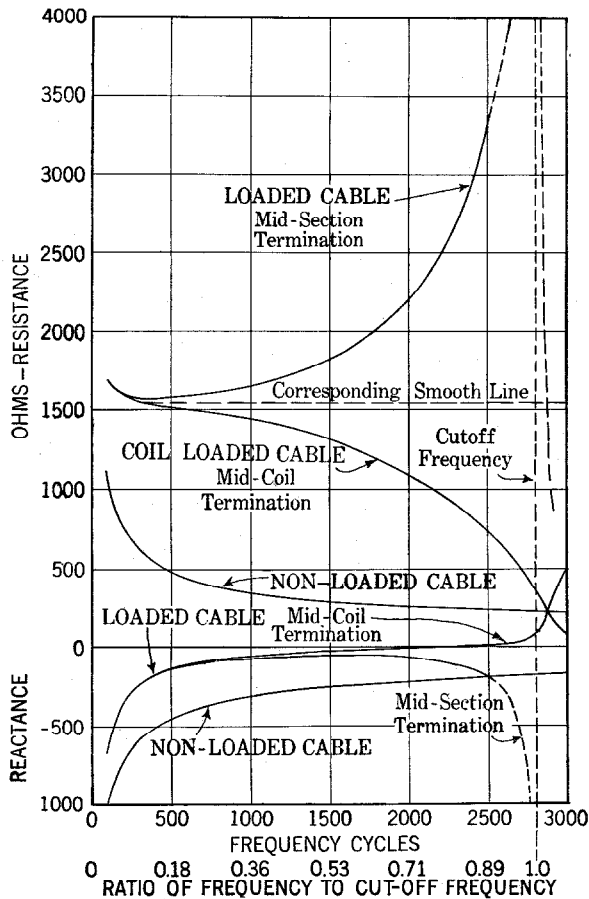

Figure 3—Impedance-frequency Characteristics of Loaded and Non-loaded No. 19 A. w. g. Cables of Figure 1

ard cut-off frequency of about 2,300 cycles. Table II lists the other important transmission characteristics of the first loading systems standardized about 1904 for use on cables:—

For open wire loading, only one loading system, known as "Heavy" loading, was standard-

TABLE II  
First Standard Cable Loading Systems

Loading Designation	Coil Inductance (Henrys)	Coil Spacing (Miles)	Inductance per Mile (Henrys)	Nominal Impedance (Ohms)	Attenuation Loss (TU per mile)		
					19 A.w.g.	16 A.w.g.	14 A.w.g.
Heavy.....	0.250	1.25	0.200	1800	0.28	0.16	0.11
Medium.....	0.175	1.75	0.100	1300	0.39	0.21	0.14
Light.....	0.135	2.5	0.054	900	0.51	0.27	0.17
		(Non-loaded Cable)			1.05	0.74	0.59

NOTE. These data apply to cables having a mutual capacitance of 0.070  $\mu\text{f}$  per mile and assume loading coils, the electrical characteristics of which are given in Table IV. The nominal impedance is defined by the expression  $\sqrt{L/C}$ . The new unit of transmission loss (TU) is described in a recent Institute paper.<sup>5</sup>

ized. This involved the use of coils having an inductance of 0.265 henry at a spacing of approximately 8 miles. This loading had approximately the same cut-off frequency as the cable loading standards described in Table II. The other important line and transmission characteristics are summarized in Table III.

ing forces; i.e., below 0.1 gilbert per cm. The core wire used in the open wire loading coils was drawn from the same stock, but differences in the drawing and annealing treatments gave it an initial permeability of about 65. This core wire had lower eddy current and hysteresis losses than the 95-permeability wire. A black enamel

TABLE III  
First Standard Open Wire Loading

Wire Diameter (In.)	Loading* Condition	Constants per Loop Mile			Nominal Impedance (Ohms)	Attenuation Loss TU per Mile
		R (Ohms)	L (Henrys)	C (Mf.)		
0.104	Non-loaded.....	10.4	0.0037	0.0084	660	0.075
0.104	Loaded.....	11.1	0.037	0.0086	2100	0.031
0.165	Non-loaded.....	4.14	0.0034	0.0091	610	0.033
0.165	Loaded.....	4.8	0.037	0.0094	2000	0.014

NOTE. Transmission efficiency figures assume dry weather insulation conditions, 5 megohm-miles, or better.

*Loading Coils.* The loading coils developed for use in the loading systems described in Tables II and III were of the toroidal type; i.e., they had ring-shaped cores formed by winding up a bundle of insulated fine wires on a suitably shaped spool. The core wire was 38 A. w. g. (0.004 in. diameter).

The wire used in the cable loading coil cores was a commercial grade of mild steel, hard drawn under conditions which gave it an initial permeability of 95. The term "initial permeability" signifies the permeability at very weak magnetiz-

insulation was used on the 95-permeability wire. A celluloid-shellac compound which could be applied at a lower temperature was used on the 65-permeability wire.

As illustrating the magnitudes involved, it may be noted that in order to meet the service requirements, the coils were designed so that for telephone currents of the order of 0.001 ampere, the magnetizing force  $H$  has a value of about 0.04 gilbert per cm., corresponding to a flux density of approximately  $B=2$  gauss.

The winding space on the cores was divided in half by means of fiber washers, and the winding was applied in two equal sections, one being

<sup>5</sup> "The Transmission Unit and Telephone Transmission Reference Systems," W. H. Martin, Trans. A. I. E. E., Vol. 43, 1924, p. 797; *Bell System Technical Journal*, July, 1924.

located on each half of the core. In installing the coils, one of these windings was inserted in one line wire and the other winding in the other line wire, so connected that the mutual inductance between windings aided the self-inductance for current flowing around the circuit through both windings.

The high costs of the open wire lines warranted considerable refinement in the design of the open wire coils. They were, therefore, made much more efficient and correspondingly larger than the cable coils. They were wound with insulated stranded wire and had much lower

individual coils to meet the electrical requirements, the spindles of coils are cabled to a short length of lead-covered cable which is referred to as a "stub" cable. Cast-iron cases with iron partitions were designed so as to provide a shielded compartment for each spindle of coils.

Commercially manufactured toroidal coils may have small irregularities in their windings resulting in a weak stray field which tends to cause cross-talk. The iron washers between coils and the partitions between spindle groups of coils provide effective cross-talk shields.

After placing the spindles of coils in the various

TABLE IV  
First Standard Loading Coils

Type Loading	Coil Code No.	Inductance (Henrys)	Average Resistance		Overall Dimensions	
			D-C. (Ohms)	1000-Cycle (Ohms)	Diameter (In.)	Height (In.)
Open Wire.....	501	0.265	2.5	5.9	9	4
Cable.....	506	0.250	6.4	22.3	4 $\frac{1}{8}$	3 $\frac{1}{4}$
".....	508	0.175	4.2	13.0	4 $\frac{1}{8}$	3 $\frac{1}{4}$
".....	507	0.135	3.2	9.1	4 $\frac{1}{8}$	3 $\frac{1}{4}$

NOTE. Effective resistance values apply for a line current of 0.002 ampere.

core losses. Another important difference between the open wire and cable coils was the use of high dielectric strength insulation in the open wire coils. The coils were subjected to a breakdown test at 8,000 volts (effective a-c.) and were protected in service by means of a special type of lightning arrester having non-arcing metal electrodes designed to operate at 3,500 volts direct current.

Table IV lists the principal characteristics of the loading coils initially used in the standard loading systems listed in Tables II and III.

*Loading Coil Cases.* The cases used for potting the cable loading coils were designed so that they could be installed in underground manholes or on pole fixtures.

The general method of assembly is to dry the loading coils thoroughly and then impregnate them under vacuum with a moisture-proofing compound. The coils are then mounted on wooden spindles, adjacent coils being separated by iron washers. After carefully adjusting the

compartments, the case is filled with a moisture proofing compound. The lead-sheathed cable stub is brought through a brass nipple in the cast iron cover of the case, and the cover is then bolted to the case. By means of a special design of case and cover joint, a double seal is provided to prevent entrance of moisture at this point. A wiped joint is made between the lead sheath of the cable and the brass nipple.

The conductors in the stub cable have an appropriate color scheme in their insulation to identify the terminals of the loading coils, thus facilitating splicing of the coils into the line circuits. A series of multi-spindle cases was standardized, ranging in capacity from 21 to 98 coils. Smaller quantities of coils were potted in a single spindle pipe type case.

Generally similar assembly and potting methods were used for the open wire coils, the important differences being first, that the open wire coils were always mounted in individual cases designed for mounting on pole fixtures, and

secondly, that the coil terminals were brought out of the case in individual rubber-insulated leads.

### I. Phantom Group Loading

In Mr. Gherardi's paper reference was made to the development of means for (a) phantoming loaded circuits and (b) loading phantom circuits. The large plant economies made possible by these developments have resulted in extensive applications of these principles.

The following discussion will consider first the coil winding schemes, after which the transmission characteristics of the loading systems and the electrical characteristics of the loading coils will be briefly described.

*Loading Methods.* Fig. 4 schematically illustrates the Bell System standard method for loading phantom circuits and side circuits of phantoms.<sup>6</sup>

The loading problem is to introduce the desired inductance into each of the three circuits of a phantom group without causing objectionable unbalances. The method illustrated in Fig. 4 involves individual loading coils for each circuit, the design being such that the side circuit coils are substantially non-inductive to the phantom circuit, while the phantom loading coil is substantially non-inductive to the side circuits. These desirable results require close magnetic coupling between the line windings in each coil. Consequently, in the side circuit coils each line winding is, in effect, distributed evenly about the entire core. The necessary high degree of symmetry required by balance considerations is obtained by dividing each line winding into two equal sections and interleaving them with the sections of the other line winding; thus each complete line winding consists of an inner section winding on one-half of the core and an outer section winding on the opposite half core. Similar design principles are applied to the phantom loading coils, with added complications, however, arising from the increased number of line windings. Each of the four line windings consists of an inner section winding located on one core quadrant and an outer section winding located on the opposite core quadrant, the

two line windings associated with a given side circuit being distributed about the same pair of opposite core quadrants. In arranging the

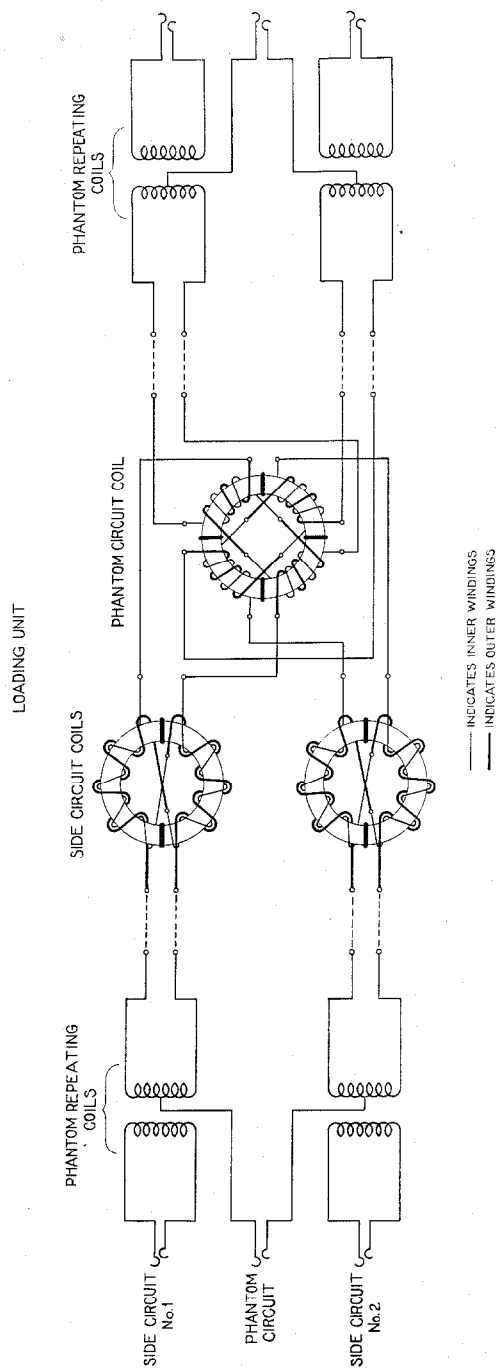

Figure 4—Bell System Standard Method of Loading Phantom Circuits and Their Side Circuits

windings on the core, precautions are taken to secure a symmetrical arrangement of the direct admittances among the line windings and from the line windings to the core and the case.

<sup>6</sup> U. S. Patents (No. 980,021 "Loaded Phantom Circuit," G. A. Campbell and T. Shaw. No. 981,015 "Phantom Loaded Circuit," T. Shaw.)

It is interesting to note that the three-coil loading scheme illustrated in Fig. 4 was employed in the Boston-Neponset cable, installed in 1910, which was the first successful installation of loaded phantom circuits in the world. Other schemes of phantom group loading using two-coil and four-coil arrangements have been developed here and abroad, but none of them is considered to be as satisfactory as the scheme illustrated in Fig. 4 from the standpoint of service and cost. These other schemes are described in a recent article<sup>7</sup> which compares them with the scheme above described.

*Loading Systems.* In adapting the circuits to phantom working, the electrical constants of the two-wire circuits were changed as little as pos-

coils at the same points as the side circuit coils; accordingly, in working to the same standard of cut-off frequency, the relative circuit constants summarized above resulted in the phantom loading systems having a nominal impedance approximately 60 per cent. as high as their associated side circuit loading systems. The transmission efficiency of the phantom circuit was 20 to 25 per cent. better than that of its associated side circuits, on which basis, the phantom circuits were suitable for use over somewhat longer distances than their side circuits.

*Cable Loading.* Data regarding the general characteristics of the first phantom group loading systems standardized for use on quadded telephone cables are given in the first four rows of

TABLE V  
First Loading Standards for Quadded Toll Cables

Item	Loading Designation	Type Circuit	Coil Inductance (Henrys)	Coil Spacing (Miles)	Nominal Impedance (Ohms)	Attenuation Loss—TU per Mile			
						19 A.w.g.	16 A.w.g.	13 A.w.g.	10 A.w.g.
1	Medium-Heavy.....	Side	0.210	1.4	1500			0.085	0.050
2	“ “.....	Phantom	0.130	1.4	950			0.069	0.040
3	Heavy.....	Side	0.250	1.25	1850			0.081	0.050
4	“.....	Phantom	0.155	1.25	1150			0.066	0.042
5	Heavy.....	Side	0.250	1.25	1850	0.24	0.14		
6	“.....	Phantom	0.155	1.25	1150	0.20	0.12		
7	Medium.....	Side	0.175	1.75	1300	0.31	0.17		
8	“.....	Phantom	0.106	1.75	800	0.26	0.14		

NOTES. A capacitance of 0.062  $\mu$ f. per mile is assumed in side circuits and 0.100  $\mu$ f. per mile in the phantom circuit. The pair capacitance value is smaller than that assumed in Table II, due to improvement in the cables.

All of the above loading systems have a cut-off frequency of about 2300 cycles.

sible in making them suitable for use as side circuits of phantoms. In the cables, two pairs having different lengths of twist were twisted into quad formation on a still different length of twist. The required balance was obtained on open wire lines by cutting in a large number of additional transpositions.

The construction methods chosen resulted in the phantom circuits having approximately 60 per cent. greater distributed capacity than their side circuits, and a lower distributed inductance, approximately in inverse proportion. It was obviously desirable to install the phantom circuit

<sup>7</sup>“Commercial Loading of Telephone Cable,” W. Fonder, *Electrical Communication*, July, 1925.

Table V. These loading systems were used principally on interurban toll cables. Because of the extra cost of the terminal and signaling equipment, and other factors involved in phantom working, it was not economical to use phantom circuits in the shorter lengths of loaded cable ordinarily involved in exchange area connections.

As soon as the development work on quadded toll cables and phantom group loading had progressed to a point where satisfactory commercial results were assured, active development work commenced on the Boston-New York-Washington cable project, involving the use of coarse gage quadded conductors and new types

of high efficiency loading coils designed especially for use on the coarse gage wires. The Boston-Washington cable was the first link in a rapidly growing network of toll cables which now interconnects the large population centers of the Atlantic Seaboard and the upper Mississippi Valley region, providing increased reliability of service as compared with open wire lines.

It should be kept in mind that at the time under discussion (1910-1911) no commercially satisfactory type of telephone repeater was available. Accordingly, in order to assure satisfactory service between Boston, New York, Washington, and intermediate points, it was necessary to provide 10-A.w.g. and 13-A.w.g. conductors in the new cable. Cost studies showed it to be desirable to use a special weight of loading intermediate between the old heavy and medium loading systems, which was therefore designated "Medium-heavy" loading. Information regarding this special loading is given in Items 1 and 2 of Table V. In items 3 and 4, corresponding data are given on the "high-efficiency" heavy loading designed for coarse gage conductors. This heavy loading was used on certain sections of the Boston-Washington cable where plant construction reasons made it desirable to install the coils in existing loading manholes installed at heavy loading spacing.

From the last column of Table V it is seen that there is very little difference between the efficiencies of the heavy and the medium-heavy loading systems when used on 10-A.w.g. conductors. This explains the more general use of the medium-heavy loading, which was less expensive because of the greater distances between coils. The effects under discussion are due to the part played by the loading coil resistance. The loading coils themselves conformed as

closely as practicable to the cost-equilibrium principle:—a condition of cost balance where a small improvement in transmission would require approximately equal expenditure whether by improving the loading or by adding copper to the cable conductors. On this basis, a somewhat less expensive grade of coil was used on the 13-A.w.g. wires than on the 10-A.w.g. wires. The grade of coils developed primarily for use on 16 and 19-A.w.g. cables, giving transmission results illustrated in Items 5-8 of Table V, was in turn less expensive than the "high efficiency" coils. In each case, since the phantom circuits were somewhat more efficient than their associated side circuits, a somewhat higher grade coil was used in the phantom circuits than in the side circuits.

*Open Wire Phantom Loading.* Phantom loading came into general use on open wire lines at about the same time as on quadded cables. In general, the methods used in applying phantom group loading to the open wire lines were used for the cable systems. The line characteristics for the side circuits were practically the same as for the original non-phantomed circuits (Table III); the principal difference being that caused by the small resistance of the phantom loading coils. The important linear and transmission characteristics of the phantom circuits are given in Table VI. The phantom loading coil had an inductance value of 0.163 henry.

*Loading Coils.* Table VII gives general information regarding the first standard side circuit and phantom loading coils used in the phantom group loading systems listed in Tables V and VI. The coils designed for open wire lines and for 10-A.w.g. cable had 65-permeability wire cores and stranded copper windings. The coils designed for 13-A.w.g. cables had 65-permeability

TABLE VI  
First Standard Open Wire Phantom Loading

Wire Diameter (In.)	Loading Condition	Constants per Loop Mile at 1000 Cycles			Nominal Impedance (Ohms)	Attenuation Loss TU per Mile
		$R$ (Ohms)	$L$ (Henrys)	$C$ (Mf.)		
0.104	Non-loaded.....	5.2	0.0022	0.0141	400	0.064
0.104	Loaded.....	5.8	0.023	0.0141	1300	0.027
0.165	Non-loaded.....	2.1	0.0021	0.0154	400	0.028
0.165	Loaded.....	2.6	0.023	0.0154	1200	0.012

TABLE VII  
First Standard Loading Coils for Phantom Working

Type Line	Inductance (Henrys)	Coil Code No.	Type Circuit	Average Resistance- (Ohms)		Overall Dimensions	
				D-C.	1000 Cycles	Diameter (In.)	Height (In.)
Open-Wire.....	0.265	512	Side Phantom	5.0	8.4	9.0	4.0
	0.163	511		2.5	4.4	11.0	4.9
10-A.w.g. Cable.....	0.210	520	Side Phantom	3.8	6.6	8.5	3.5
	0.130	519		1.9	3.4	10.4	4.0
	0.250	532	Side Phantom	4.1	7.8	8.5	3.5
	0.155	531		2.1	3.9	10.4	4.0
13-A.w.g. Cable.....	0.205	538	Side Phantom	6.0	9.2	5.7	2.5
	0.130	521		3.0	4.5	7.9	3.0
	0.250	534	Side Phantom	6.6	10.7	5.7	2.5
	0.155	533		3.3	5.3	7.9	3.0
16 and 19-A.w.g. Cable.....	0.250	515	Side Phantom	8.9	23.1	4.6	2.4
	0.155	530		4.4	11.9	5.9	2.9
	0.175	514	Side Phantom	5.4	14.4	4.6	2.4
	0.106	513		2.7	7.1	5.9	2.9

NOTE. The resistance data apply to circuits of a complete phantom group; *i.e.*, the side circuit data include effects of the phantom coils, and phantom circuit data include effects of the side circuit coils. Effective resistance values correspond to line current of 0.002 ampere.

wire cores and non-stranded copper windings. The other coils had 95-permeability wire cores.

**Potting Features.** The general practise for cable loading is to pot side circuit and phantom loading coils in the same case as phantom groups, since this has important installation and transmission advantages. The phantom coils, being considerably larger than the side circuit coils, are mounted in separate spindle compartments. The cross-connections between the side circuit and phantom coils are made within the case, in order to reduce the amount of splicing required in the field. Thus, the stub cable contains only the conductors to be spliced to the "east" and "west" conductors in the line cable. Quadded construction is used in the stub cable of all loading coil cases for phantom loading in order to avoid serious capacitance unbalances.

The multi-spindle cases used in potting the small size coils for 16 and 19-A.w.g. cables ranged in capacity from 12 to 24 phantom units. The larger size coils used on the coarser gage cables were potted in smaller complements.

Occasionally it is desirable to install side circuit loading alone and to install the phantom loading

at a later period. Accordingly, cable loading coil cases were designed to meet these conditions. The open wire coils were potted in individual cases.

## II. Loading for Repeatered Circuits

**General.** The development of telephone repeaters to the point where they could be used for commercial service in extending the range of telephone transmission was the beginning of a new era in the communication art. In this development work, the adaptation of the lines to the requirements of repeater operation was secondary in importance only to the development of satisfactory repeater elements and circuits for associating the repeater elements with the line. The reader is referred to an Institute paper by Messrs. B. Gherardi and F. B. Jewett<sup>8</sup> for general information regarding telephone repeaters and to a more recent Institute paper by Mr. A. B. Clark<sup>9</sup> for a general discussion of sub-

<sup>8</sup> "Telephone Repeaters," B. Gherardi and F. B. Jewett, Trans. A. I. E. E., Vol. 38, 1919, p. 1287.

<sup>9</sup> "Telephone Transmission over Long Cable Circuits," A. B. Clark, Trans. A. I. E. E., Vol. 42, 1923, p. 86, *Bell System Technical Journal*, Jan., 1923.



sequent developments in the application of repeaters to long telephone circuits.

The early work on the line problem was primarily concerned with obtaining a sufficiently high degree of regularity in the line impedance-frequency characteristics, so that the requisite high degree of balance could be obtained and maintained between the line and the repeater balancing network. Later on, particularly in preparing for the application of telephone repeaters to long toll cables, such as the New York-Pittsburgh-Chicago cable, it became necessary to change the fundamental transmission characteristics of the loading.

*Early Work—Reduction of Line Irregularities.* Commercial telephony, requiring two-way transmission, imposes severe balance requirements on repeater circuits over the entire band of frequencies which the repeater is designed to transmit, in order to avoid singing or distortion due to near singing. Within certain limitations, the higher the degree of balance between the line and the balancing network circuit, the higher will be the permissible amplification gain of the repeater.

The practical solution of this fundamental repeater-line balance problem required (a) the construction of lines having extremely regular impedance characteristics over the frequency band which the repeater is designed to transmit and (b) the development of balancing networks<sup>10</sup> capable of accurately simulating the sending-end impedance characteristics of the improved lines throughout this frequency range. On account of the great difficulty of getting a high degree of balance at frequencies near the cut-off frequency of the loading, partly due to line irregularity effects and partly due to network design complications, it has been found desirable to use electric wave filters<sup>11</sup> in the repeater sets which cut off at a frequency below the cut-off frequency of the loading. This margin of cut-off effects is usually 200 cycles or more, depending upon the repeater design and the type of loading involved.

The "regular" line referred to in (a) is one which is free from impedance irregularities. In the case of loaded lines, the loading coils should

<sup>10</sup> R. S. Hoyt "Impedance of Loaded Lines and Design of Stimulating and Compensating Networks," *Bell System Technical Journal*, July, 1924.

<sup>11</sup> U. S. Patents Nos. 1,227,113, and 1,227,114—G. A. Campbell.

have very closely the same inductance values, and the sections of line between loading coils should have closely the same value of capacitance. These uniformity features should be permanent, which requires that the coils should have a high degree of stability in their inductance characteristics; i.e., they should be capable of resisting the magnetizing effects of abnormal service conditions. Some of the older types of coils did not meet this requirement. The satisfactory way in which these fundamental coil requirements are fulfilled in the newer types of coils will be described in a subsequent section.

Uniformity in the loading section capacitance values involves uniformity in cable and line capacitance values as well as precision in the coil spacing. In toll cable loading the maximum deviations from the average spacing are kept below 2 per cent., and the average deviations are in the order of 0.5 per cent. or less.

In exceptional cases where physical obstructions are encountered in reducing the spacing deviations to a sufficiently low value, use is made of "building-out condensers" or "building-out stub cables" to normalize the capacitance of loading sections.<sup>12</sup> Abnormally long loading sections can usually be split up into two sections, one or both of which may then be "built out" to the normal standard capacitance values.

*Transcontinental Lines—High Stability Loading Coils.* The inauguration of commercial transcontinental telephone service over the New York-San Francisco line in January, 1915, marked the first commercial application of these general improvements in regularity of line construction, including the use of an improved type of loading coil.

In the extensive field work which was done in preparing for transcontinental telephone service, it was found that the inductance values of a considerable percentage of the open-wire loading coils then in use (Nos. 511 and 512 types, Table VII) had changed appreciably from the nominal values to which they were adjusted at the factory prior to shipment, and that these changes were due to core magnetization caused by abnormal currents induced by lightning discharges. In some cases abnormal currents induced by power transmission lines or electric railway distribution

<sup>12</sup> U. S. Patent No. 1,219,760—John Mills and R. S. Hoyt.

systems were responsible for the loading coil magnetization.

The inductance changes were not sufficiently large to have serious reactions on transmission over non-repeated circuits. Although individual coils varied in inductance from time to time, the general average of groups of coils was fairly constant. The effects of these individual variations on the impedance of the line were, however, too large to permit satisfactory operation with telephone repeaters. Some experiments made with improved lightning arresters, in an effort to reduce the coil magnetization trouble, were unsuccessful.

The solution of the problem of repeating loaded open-wire circuits required the development of loading coils which would be stable magnetically when subjected to extreme conditions of magnetizing current in the windings. The requirement was laid down for these coils that the inductance to speech currents should not be affected more than about 2 per cent. when a magnetizing current of two amperes was passed through either line winding. In view of the fact that the extreme residual magnetizing effect of this current on the No. 511 and No. 512 loading coils was approximately 30 per cent., it will be appreciated that this imposed a very severe stability requirement.

The design adopted involved the use of air-gaps in the cores of the iron wire core loading coils.<sup>13</sup> Two air-gaps were employed at opposite points in the cores and suitable clamping means were provided to hold the coil halves in proper alinement. The use of only two air-gaps in the cores of the phantom loading coil brought in unbalance tendencies not present in older designs, which were corrected by special refinements in the design.

The use of a magnetic circuit having "ends," while effective for producing self-demagnetization, brought in troublesome magnetic leakage which necessitated special potting methods. Because of the economy of cast-iron loading coil cases, it was decided to continue their use, but to increase their dimensions sufficiently to reduce eddy-current losses in the case to a tolerable point.

The air-gap type loading coils designed for the

<sup>13</sup> U. S. Patents Nos. 1,289,941 and 1,433,305—Shaw and Fondiller.

transcontinental circuits, coded Nos. 549 and 550 for the phantom and side circuits respectively, were more generally potted as phantom loading units than as individual coils, and in such instances the cross-connections between the phantom and side circuit coils were made inside the case. Important advantages of this arrangement were that the leakage losses during periods of low line insulation were greatly reduced as well as the liability of wrong connections of windings during the installation work. Fig. 5 is a photograph of an installation of open wire

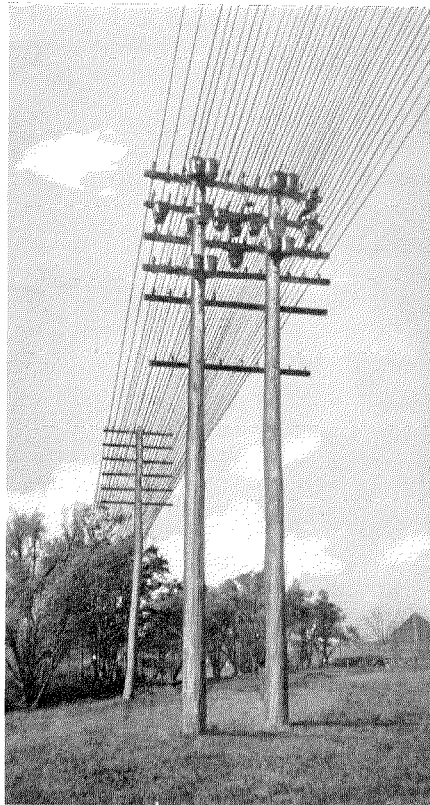

Figure 5—Typical Open Wire Loading Installation, Showing Four Phantom group (3-coil) cases and nine individual coil cases

loading coils illustrating both the individual coil and loading unit methods of potting.

Table VIII contains data on the air-gap coils standardized for open-wire circuits. It will be noted that these coils are somewhat less efficient from the standpoint of effective resistance than the older type coils (Nos. 511 and 512) listed in Table VII, though having marked superiority over the latter with regard to magnetic stability.

TABLE VIII  
*High Stability Coils Having Wire Cores with Air Gaps*

Type Loading	Coil Code No.	Type Circuit	Inductance (Henrys)	Average Resistance (Ohms)		Overall Dimension (Inches)	
				D-C.	1000-Cycles	Diameter	Height
Open-Wire.....	550	Side	0.245	5.4	11.1	8.1	3.9
“ “ .....	549	Phantom	0.150	2.7	6.4	10.0	4.0
10 and 13 A.w.g. Cable.....	556	Side	0.248	7.0	14.0	5.6	2.9
	555	Phantom	0.154	3.5	7.0	7.5	3.6
10 and 13 A.w.g. Cable.....	558	Side	0.200	6.2	10.9	5.6	2.9
	557	Phantom	0.135	3.1	5.9	7.5	3.6

NOTES. Open-wire coils used in Loading Systems, Tables III and VI. Cable coils used in Loading Systems, Table V. Resistance data apply to side circuits and phantom circuits of complete phantom groups. Effective resistance values are for 0.002 ampere line current.

To assist in getting maximum line regularity, the Nos. 549 and 550 coils were adjusted in the factory to meet  $\pm 1$  per cent. inductance precision limits. In the older types of coils  $\pm 5$  per cent. deviations had been allowed. The nominal inductance values of the Nos. 549 and 550 coils are somewhat below those of the Nos. 511 and 512 coils, the inductance difference corresponding roughly to the average magnetization effect of normal service conditions on the older types of coils.

The solution of the transcontinental line problem involved improvements in the regularity of the coil spacing as well as improvements in the magnetic stability of the coils. The line "clearing up" work usually involved a great deal of retransposing, since cross-talk considerations made it necessary to have the coils placed at balanced or neutral points in the transposition layout.

In the case of coarse gage cable circuits, such as the Boston-Washington and other toll cables installed prior to the advent of repeaters, the new requirements were met by the design of an air-gap type of wire-core coil on which data are given in Table VIII. They were somewhat smaller and not quite so expensive as the improved open-wire coils.

*Compressed Powdered Iron Core Loading Coils.* It soon became evident that the economical extension of the toll plant would involve the general introduction of telephone repeaters in cable as well as open-wire circuits. The use of tele-

phone repeaters made it possible to supersede the coarse gage conductors by 16 and 19-A.w.g. conductors for toll connections, and this greatly increased the need for an efficient and stable loading coil of lower cost than the air-gap wire core coil.

As a result of investigations carried on over a period of several years, there was developed for commercial use early in 1916 a new magnetic material, compressed powdered iron, which has been of the utmost value in loading coil design.<sup>14</sup> This improved magnetic material is described in a paper presented before the Institute by B. Speed and G. W. Elmen<sup>15</sup> which also discusses the electrical and magnetic properties of the material.

Briefly, the method of production consists of grinding electrolytically deposited iron to the desired fineness, insulating the particles of iron, and finally compressing these insulated particles in steel dies at such very high pressures as to consolidate the mass into a ring, the specific gravity of which is substantially equal to that of solid iron. The rings are then stacked in a manner similar to laminations of sheet material to form a core of the desired dimensions. Though the separate rings are approximately 0.2 in. thick, the insulation between the individual particles is so effective that despite the use of

<sup>14</sup> U. S. Patents No. 1,274,952, B. Speed; 1,286,965, G. W. Elmen; 1,292,206, J. C. Woodruff.

<sup>15</sup> "Magnetic Properties of Compressed Powdered Iron," B. Speed and G. W. Elmen, Trans. A. I. E. E., Vol. 40, 1921, p. 1321.

molding pressures of 200,000 lb. per sq. in., the eddy current loss in a powdered iron core is less than that obtainable with 0.004 in. iron wire. Depending on the heat treatment and the amount of insulation, the initial permeability can be varied from approximately 25 to about 75. The specific resistance is about 20,000 times that of ordinary iron. The permeability can be controlled within comparatively narrow limits by the manufacturing processes, thus making for greater uniformity. The great advantage of this material for loading coils, however, lies in its self-demagnetizing property. The powdered iron core by virtue of its very numerous, though extremely small distributed air-gaps, affords a means for constructing magnetically stable cores without the production of poles and their attendant magnetic leakage.

Fig. 6 gives photographs of a standard compressed iron powder core ring such as is used in

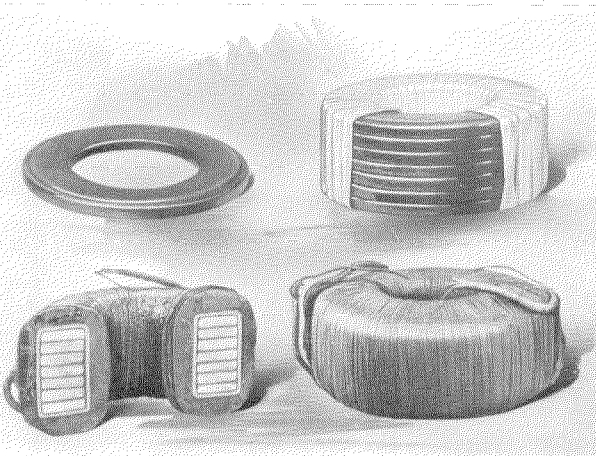

Figure 6—Compressed Powdered Iron Core Loading Coil

the cores of toll cable loading coils; a completely assembled core with part of the core taping removed; a completely wound coil of the side circuit type; and a coil in cross-section. Table IX gives general data regarding typical coils.

The first application of powdered iron cores was to replace some of the 95-permeability wire core loading coils in 16 and 19-A.w.g. cable. The effective permeability of the 95-permeability wire cores, making correction for air spaces and insulation, was approximately 60, and accordingly, the replacing powdered iron

cores were designed to have the same effective permeability.

As a result of further developments in the direction of applying vacuum tube repeaters to loaded cable circuits, it became necessary with the extension of the length of these circuits to improve the characteristics of the loading coils. This led to the development of an improved grade of powdered iron core having an initial permeability of 35 which corresponds closely to the effective permeability of cores using iron wire having a permeability of 65. It was decided that for circuits such as interoffice trunks and short cables which would not be operated with superposed telegraph, the 60-permeability compressed iron core coils should be used; while for toll cable work involving repeated composited circuits, 35-permeability cores should be employed. All of the compressed powder core coils intended for repeated circuits were adjusted to meet  $\pm 2$  per cent. inductance limits.

The effective resistance-frequency characteristics of 95-permeability and 65-permeability wire core coils and 60-permeability and 35-permeability powdered iron core coils having the same inductance (0.174 henry) and the same over-all sizes are given in Fig. 7. The large improvement as to freedom from residual magnetization effects afforded by the 35-permeability powdered iron core, compared with the 65-permeability wire core is evident from the curves of Fig. 8. The effective resistance and inductance variation with current strength are shown in Fig. 9 for a 35-permeability powdered iron core coil. The remarkable property of these cores of maintaining constancy of permeability is shown by the change of only 1 per cent. in permeability as the current strength varies 400 per cent. from, say 0.001 to 0.005 ampere.

It is interesting to note that after the process had been fully worked out and production was running on a commercial scale, the cost of the improved cores was comparable with that of the wire cores which they replaced.

In connection with the development of the new core material which was undertaken as a part of the loading coil development program, an enormous amount of work was involved which would not ordinarily be associated with loading coil design work. For instance, there

TABLE IX  
Typical Compressed Powdered Iron Core Loading Coils

Coil Code No.	Core Permeability	Inductance (Henrys)	Type Circuit	Resistance (Ohms)		Dimensions (Inches)	
				D-C.	1000-Cycles	Diameter	Height
562	60	0.245	Side	11.4	25.8	4.5	2.1
561	60	0.155	Phantom	5.7	11.7	6.3	3.0
564	60	0.174	Side	6.6	15.4	4.5	2.1
563	60	0.106	Phantom	3.3	6.7	6.3	3.0
582	35	0.245	Side	15.9	21.8	4.7	2.4
581	35	0.155	Phantom	8.0	10.0	6.7	3.1
584	35	0.174	Side	10.8	14.1	4.7	2.4
583	35	0.106	Phantom	5.4	6.6	6.7	3.1
584	35	0.174	Side	12.1	15.3	4.7	2.4
587	35	0.063	Phantom	6.1	7.0	4.7	2.8
590	35	0.044	Side	4.0	4.6	4.7	2.4
591	35	0.025	Phantom	2.0	2.0	4.7	2.8

NOTE. Resistance values apply to side circuits and phantom circuits of complete phantom groups. Effective resistance corresponds to 0.002-ampere line current.

These coils are used in the loading systems listed in Tables V and X.

were undertaken chemical studies on electro-deposition of iron and methods of insulating the iron particles, metallurgical studies of the production of finely divided iron by various means, refinements in shielded electrical measuring equipment for accurate determination of small core losses at voice frequencies, development of special permeameters to make possible the rapid

determination of the permeability of rings, the design of the steel moulding dies, selection of suitable grades of alloy steel to withstand the

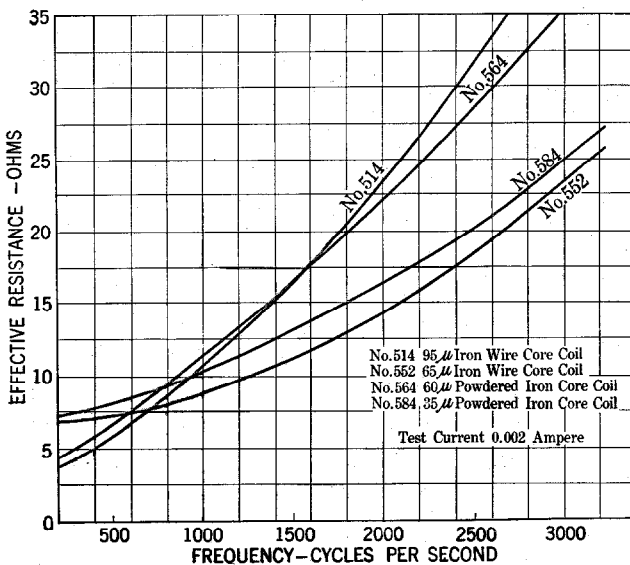

Figure 7—Effective Resistance-frequency Characteristics toll cable loading coils

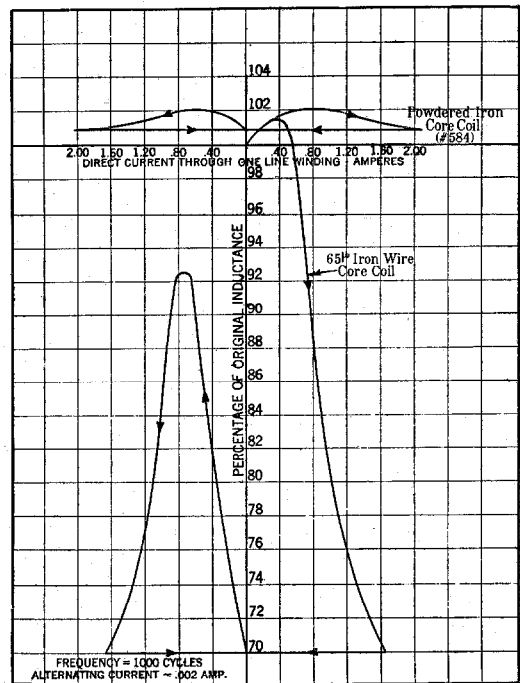

Figure 8—Residual magnetization Characteristics of Compressed Powdered Iron Core and Iron Wire Core Loading Coils

enormous pressures, and also various other special problems. These are mentioned here as illustrative of the scope of the problem of developing this new core material.

It is of interest to note that the compressed powdered iron core loading coil has been adopted

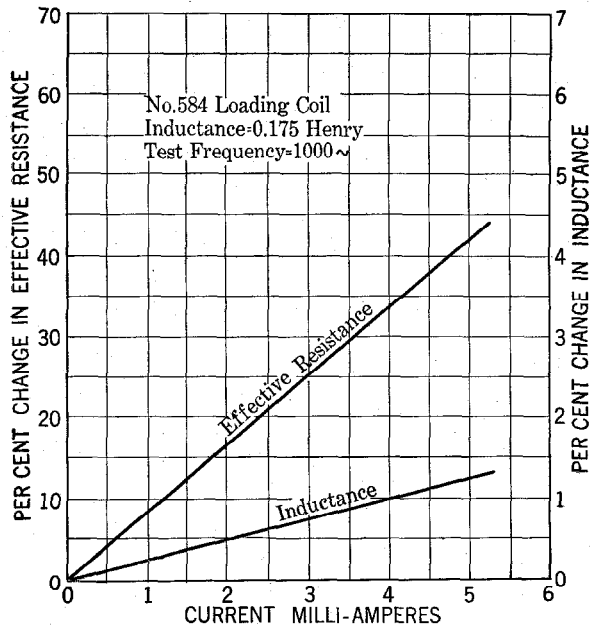

Figure 9—Variation of Inductance and Effective Resistance. With Line Current in 35-Permeability Compressed Powdered Iron Core Loading Coil

also as the international standard in Europe for repeatered circuits.<sup>16</sup>

*New Requirements for Cable Loading Systems.* In the first commercial applications of telephone repeaters, the new features in the loading were the improved types of coils already described and the improved precision of spacing the coils. No fundamental changes were made in the loading systems then standard.

The completion of the development of a satisfactory commercial type of telephone repeater marked the beginning of a long period of experimental work for the purpose of determining the commercial possibilities of the use of repeaters over long cable circuits. When loaded cables of improved impedance regularity became available, long circuits were built up for experimental

<sup>16</sup> Minutes of Second Conference of Permanent Commission, Le Comité Consultatif Internationale de Communications Telephonique a Grande Distance, page 55—p. 119, English Version.

purposes by looping back and forth. As the length of these circuits was increased, phenomena not previously observed in cable circuits became increasingly troublesome, and it became apparent that it would be necessary to develop new loading systems having improved velocity and higher cut-off frequency characteristics in order to realize the full possibilities of repeaters in extending the range and reducing the cost of long distance telephone service over cables.

The disturbances above mentioned were found to be due to:

- (a) Echo effects.
- (b) Velocity distortion.

These phenomena originate in the lines themselves and are made more apparent by the amplifying action of the repeaters. They are present in non-repeatered circuits but not to a noticeable degree. It is the combination of the extreme length of the circuit and the use of repeaters to keep the over-all loss low that makes the disturbances troublesome.

*Echoes.* Echoes are due to unbalance currents; i.e., to the reflection of electrical energy at points of impedance irregularity in the circuits. When the circuit is so long that the time of transmission from the point of reflection to the disturbed subscriber is appreciable, there will be echo effects unless the losses in the circuit are so large as to cause the reflected energy to become inappreciably small. On such circuits it may be necessary to work the repeaters at gains well below those at which "singing" occurs or distortion due to "near singing" is experienced.

Since the time of transmission is such an important factor in echo phenomena, reductions in the harmful effects of these disturbances have been obtained in the improved loading systems which have been developed for use on long repeatered circuits, by substantially increasing the velocity of transmission. Recently there has become commercially available a device known as an "echo suppressor" which interrupts the path of the echoes without disturbing the main transmission. A description of the device and its field of application was given in a recent Institute paper.<sup>17</sup>

<sup>17</sup> "Echo Suppressors for Long Telephone Circuits," A. B. Clark and R. C. Mathes, *Jour. A. I. E. E.*, p. 618, June, 1925.

*Velocity Distortion.* In a coil loaded line the steady state velocity of wave propagation varies with frequency. At the upper frequencies the velocity change is principally due to lumpiness effects of the loading and is, therefore, a function of the ratio of the frequency under consideration to the cut-off frequency. As illustrated in Fig. 2, the departure of the actual velocity from the nominal velocity of the corresponding smooth line ( $\sqrt{1/CL}$ ) increases as the frequency is raised, the rate of change increasing rapidly as the cut-off frequency is approached. At frequencies below approximately 0.3 of the cut-off frequency the coil loaded line has substantially the same velocity characteristics as the corresponding smooth line; when the frequency is further reduced, the departure of the actual velocity from the nominal velocity increases as a function of the ratio of the line resistance to the inductive reactance per unit length.

As a result of these velocity-frequency relations, a long loaded repeatered circuit may have seriously objectionable quality, even when the attenuation-frequency distortion is made negligible by the use of special devices at the repeater stations for correcting the attenuation-frequency distortion effects.

The velocity distortion is particularly noticeable during the building-up and dying-down periods, when it manifests itself as transient distortion. The duration of transient distortion depends, among other factors, upon the length of the line, the nominal velocity, and the cut-off frequency of the loading. In the old standard loading systems the high frequency velocity distortion caused by the lumpiness effects of the loading was more serious than the low frequency velocity distortion. Accordingly, a substantial reduction in the transient distortion has been obtained in the new standard loading systems by raising the cut-off frequency of the loading.

For further discussion of velocity distortion reference should be made to Mr. A. B. Clark's paper,<sup>18</sup> previously mentioned, which gives experimental results and to an earlier Institute paper by Mr. J. R. Carson<sup>19</sup> which gives the results of theoretical studies.

<sup>18</sup> Clark, Loc. Cit.

<sup>19</sup> "Theory of the Transient Oscillations of Electrical Networks and Transmission Systems," J. R. Carson, Trans. A. I. E. E., Vol. 38, 1919, p. 345.

*Characteristics of Improved Cable Loading Systems.* The principal electrical features of the H-44-25 and H-174-63 phantom group loading systems which have been developed primarily for use on long repeatered cables are given in Table X. Corresponding details of the older standard loading system developed for non-repeatered cables are also included in this table. Typical attenuation-frequency curves of the old and new loading systems are given in Fig. 10.

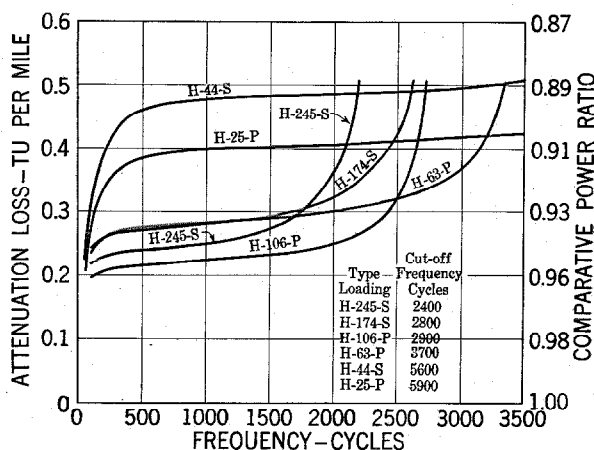

Figure 10—Attenuation-frequency Characteristics of Toll Cable Loading

In the following discussion of detailed characteristics, the various phantom group loading systems will be referred to in terms of recently standardized designations which include a letter to symbolize the coil spacing, in combination with two numbers which correspond with the effective coil inductance values in milhenrys, the first number referring to the side circuit coils and the second number to the phantom coils. The individual side circuit of phantom circuit loading systems have designations which include a letter to symbolize the coil spacing, coupled with the inductance value of the loading coils in milhenrys, and having a letter suffix "S" or "P" indicating the type of circuit, side or phantom.

The fundamental differences between the new and the old loading systems are with respect to velocity of wave propagation and cut-off frequency, these changes having been made in accordance with the preceding discussion primarily for the purpose of reducing echo effects and transient distortion. For reasons of plant economy and flexibility, the new loading systems all have the same coil spacing of 6,000 feet.

TABLE X  
Loading Systems—Small Gage Repeatered Toll Cables

Item	(a) Loading System	Circuit	(b) Coil Code No.	Nominal Impedance (Ohms)	Nominal Cut-off Frequency (Cycles)	Transmission Velocity Miles per Second	(c) Attenuation Loss TU per Mile at 1000 Cycles		(d) Maximum Geographical Length (Miles)
							19 A.w.g.	16 A.w.g.	
(1)	H-44-25	Side	590	800	5600	19000	0.48	0.25	5000
(2)	H-44-25	Phantom	591	450	5900	20000	0.40	0.21	5000
(3)	H-174-63	Side	584	1550	2800	10000	0.28	0.16	500
(4)	H-174-63	Phantom	587	750	3700	13000	0.28	0.16	1500
(5)	H-174-106	Side	584	1550	2800	10000	0.28	0.16	500
(6)	H-174-106	Phantom	583	950	2900	10000	0.22	0.13	500
(7)	H-245-155	Side	582	1850	2400	8000	0.25	0.16	250
(8)	H-245-155	Phantom	581	1150	2400	8000	0.20	0.12	250

NOTES. (a) Nominal coil spacing is 6000 feet in cable having a capacitance of  $0.062 \mu\text{f}/\text{mile}$  in the side circuits and  $0.100 \mu\text{f}/\text{mile}$  in the phantom circuits.

(b) The loading coil data are given in Table IX.

(c) These attenuation values apply at 55 deg. Fahr. Under extreme temperature conditions, the actual attenuation may be approximately 12 per cent larger or smaller, due principally to changes in conductor resistance with temperature. In long repeatered cable circuits these variations of attenuation with temperature require special corrective treatment by means of automatic transmission regulators. (Reference No. 9.)

(d) These length limitations are set by transient distortion effects; echo currents may limit circuit lengths to lower values, depending on the grade of balance of the lines and the permissible over-all loss.

The coil spacing being fixed, it necessarily follows that any reduction in coil inductance for the purpose of raising the cut-off frequency will also increase the transmission velocity. The attenuation improvement obtained by the loading decreases as the velocity is increased. High velocity loading is more expensive than low velocity loading, in the sense that more repeaters are required for the same over-all loss. Obviously, although high velocity loading could be used for short haul traffic, it would not be so economical as a low velocity loading. Commercial considerations thus justify a series of loading standards, graded to meet the requirements of the different lengths of circuits.

At the present time the two phantom group loading standards, H-44-25 and H-174-63, are sufficient to meet the graded requirements of commercial toll cable circuits, when used with suitable combinations of conductor sizes and repeaters. Three different general types of repeaters are used, known as the 21, 22, and 44 types.<sup>20</sup> The 21 type is used on two-wire circuits requiring only one repeater, under conditions

where switched connections involving other repeaters are not involved. The 22 type is used on two-wire circuits requiring one or more repeaters. The 44 type is used on four-wire circuits, where one pair of wires is used for one-way transmission in one direction and the other pair of wires for transmission in the opposite direction. When phantom circuits are worked on a four-wire basis, each one-way transmission path actually uses four wires.

Table XI lists the combinations of loading, conductor gage, and type of repeater circuit

TABLE XI  
Types of Toll Cable Facilities

Item No.	Length Circuit	Cable Gage	Type of Loading	Type Circuit	Type Repeater
(a)	(short)	19	H-174-63	2-wire	—
(b)		16	H-174-63	2-wire	—
(c)		19	H-174-63	2-wire	21
(d)		16	H-174-63	2-wire	21
(e)		19	H-174-63	2-wire	22
(f)		16	H-174-63	2-wire	22
(g)		19	H-174-63	4-wire	44
(h)		16	H-44-25	2-wire	22
(i)	(very long)	19	H-44-25	4-wire	44

<sup>20</sup> Gherardi—Jewett, Loc. cit.



which are used in meeting the wide range of commercial requirements. The position of the facility item in the table indicates the sequence of transmission excellence, Item (i) being the highest grade facility in this respect. In general, the cost of these facilities is in reverse order to the sequence of electrical excellence.

The exact limits of the field of use of a given type of facility depend upon the magnitude of the permissible over-all transmission loss, and upon the grade of repeater balance obtainable. A discussion of these features would bring in complicated engineering questions beyond the scope of the present paper. So far as loading features are concerned, it is sufficient to state that H-44-25 loading is generally used on circuits of approximately 500 miles or more. On circuits intended for switched business, it is frequently necessary to use this type of loading for much shorter distances. For further discussion of the use of repeated loaded lines reference is made to recent papers presented before the Institute by Mr. J. J. Pilliod<sup>21</sup> and Mr. H. S. Osborne.<sup>22</sup>

*H-63-P versus H-106-P Loading.* The standardization of the H-63-P loading to replace the H-106-P loading for association with H-174-S loading, is of particular interest in illustrating the reactions of repeater requirements on loading design. Phantom circuits necessarily have a lower attenuation constant than the associated side circuits, when the loading is designed to meet the same standard of cut-off frequency and the coils are spaced at the same loading points. When repeaters are used on such loaded phantom circuits, the net equivalent is practically no lower than the net equivalent of the associated side circuits, due principally to the fact that the loaded sides and phantoms have practically the same velocity and cut-off frequency characteristics.

Under present operating conditions for short small gage loaded circuits of such lengths that satisfactory transmission results can be obtained without using telephone repeaters, there is ordinarily no important advantage in having the

phantom circuit more efficient than the side circuits. It is a distinct operating convenience, of course, to be able to use the phantom circuit and its associated side circuits indiscriminately for the same class of service.

Having the above situations in mind, it was decided to redesign the phantom loading so that it would have approximately the same attenuation constant at 1,000 cycles as the associated H-174-S loading. This resulted in the reduction of the phantom loading coil inductance to 63 milhenrys. On the basis of equal attenuation losses in the phantom circuit and its side circuits, the continued use of a higher grade coil in the phantom circuit was no longer justified from a cost standpoint. Accordingly, the new 63-milhenry phantom coil (Code No. 587, Table IX) was designed to have approximately the same d-c. resistance as the earlier standard 106-milhenry coil (Code No. 583), since this permitted a substantial reduction in the size of the loading coil and a consequent reduction in cost, without increasing the over-all losses in the associated side circuits. The design finally chosen resulted in the phantom coil having approximately the same over-all dimensions as the associated side circuit coils. This permitted the phantom coils to be mounted on the same spindles with the associated side circuit loading coils as phantom groups, thus reducing the amount of inside cabling. This gave improved electrical results, besides reducing the potting costs. The use of the smaller size phantom coil, in combination with a larger size case, made it practicable to pot a total of 45 phantom group combinations (135 coils) in a single case. Using the same size case for potting phantom group combinations involving the older large size phantom coils, the limit on the number of coils was 108 (36 phantom groups).

The reduction of the phantom coil inductance from 106 to 63 milhenrys made a substantial increase in the cut-off frequency and in the velocity of transmission, as noted in Table X. These improved characteristics made the H-63-P circuit much superior to the H-106-P circuit from the standpoint of echoes and velocity distortion characteristics. On this basis the H-63-P circuit is intermediate in transmission excellence between H-174-S and H-44-25 circuits.

(To be concluded)

<sup>21</sup> "Philadelphia-Pittsburgh Section of New York-Chicago Cable," J. J. Pilliod, Trans. A. I. E. E., Vol. 41, 1922, p. 446; *Bell System Technical Journal*, Jan., 1922.

<sup>22</sup> "Telephone Transmission over Long Distances," H. S. Osborne, Trans. A. I. E. E. Vol. 42, 1923, p. 984.

---

---

# ***International Standard Electric Corporation***

*Head Offices*  
NEW YORK, U. S. A.

*European General Offices*  
LONDON, ENGLAND  
PARIS, FRANCE

## ***Affiliated Companies***

Standard Telephones and Cables, Limited . . . . . *Aldwych, London, England*  
Branches: Birmingham, Cardiff, Glasgow, Leeds, Manchester, Newcastle-on-Tyne, Southampton, Dublin, Cairo, Johannesburg, Calcutta, Singapore.

Bell Telephone Manufacturing Company . . . . . *Antwerp, Belgium*  
Branches: Berne, The Hague, Brussels, Riga, Reval.

Standard Electric Company W Polsce . . . . . *Warsaw, Poland*

Le Materiel Telephonique . . . . . *Paris, France*

Standard Electrica, S. A. . . . . *Madrid, Spain*

Standard Elettrica Italiana . . . . . *Milan, Italy*  
Branch: Rome.

Standard Electric Aktieselskap . . . . . *Oslo, Norway*

Vereinigte Telephon und Telegraphen Fabrik . . . . . *Vienna, Austria*

United Incandescent Lamps and Electrical Company, Limited  
*Budapest (Ujpest), Hungary*

Standard Telephones and Cables (Australasia), Ltd . . . . . *Sydney, Australia*  
Branches: Melbourne, Wellington.

Nippon Denki Kabushiki Kaisha . . . . . *Tokyo, Japan*  
Branches: Osaka, Dalny (Manchuria), Seoul (Chosen).

Sumitomo Electric Wire & Cable Works, Ltd . . . . . *Osaka, Japan*

China Electric Company, Limited . . . . . *Peking, China*  
Branches: Shanghai, Tientsin.

International Standard Electric Corporation . . . . . *Rio de Janeiro, Brazil*

Compania Standard Electric Argentina . . . . . *Buenos Aires, Argentina*

Sales Offices and Agencies Throughout the World

To those interested in better communication the International Standard Electric Corporation and its Affiliated Companies offer the facilities of their consulting engineering departments to aid in the solution of problems in Telephony, Telegraphy and Radio.