

# ELECTRICAL COMMUNICATION

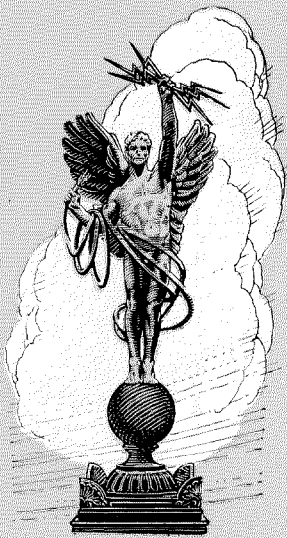

JANUARY  
1925

No. 3  
VOL. 3

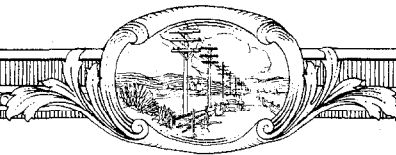

# ELECTRICAL COMMUNICATION

A Journal of Progress in the  
Telephone, Telegraph and Radio Art

## EDITORIAL BOARD

F. B. Jewett  
G. E. Pingree

E. B. Craft  
H. E. Shreeve

F. Gill  
E. A. Brofos

J. L. McQuarrie  
P. K. Condict

J. F. Rhame, Editor

Published Quarterly by the

**INTERNATIONAL WESTERN ELECTRIC COMPANY**  
INCORPORATED

195 BROADWAY, NEW YORK, N. Y., U. S. A.

Charles G. DuBois, President

George C. Pratt, Secretary

J. W. Johnston, Treasurer

*Subscription \$1.50 per year; single copies 50 cents*

---

Volume III

JANUARY, 1925

Number 3

---

## CONTENTS

NO. 7-A MACHINE SWITCHING SYSTEM.....	153
<i>By G. Deakin</i>	
SOME FUNDAMENTAL FACTS REGARDING TELEPHONE RATES.....	190
<i>By W. S. Gifford</i>	
TELEPHONE CIRCUITS USED AS AN ADJUNCT TO RADIO BROADCASTING.....	194
<i>By H. S. Foland and A. F. Rose</i>	
THE DEPENDENCE OF THE LOUDNESS OF A COMPLEX SOUND UPON THE ENERGY IN THE VARIOUS FREQUENCY REGIONS OF THE SOUND.....	203
<i>By H. Fletcher and J. C. Steinberg</i>	
BROADCASTING IN SOUTH AFRICA.....	209
<i>By F. H. Amis</i>	
SOME CONSIDERATIONS REGARDING RURAL TELEPHONY IN THE UNITED KINGDOM.....	213
<i>By E. S. Byng</i>	
THE TESTING OF LONG DISTANCE TELEPHONE CABLE DURING INSTALLATION.....	219
<i>By W. E. Mougey</i>	

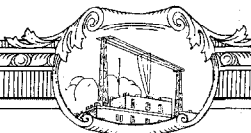

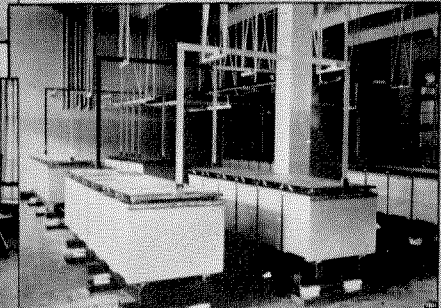
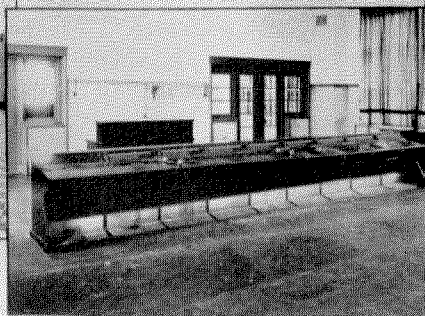
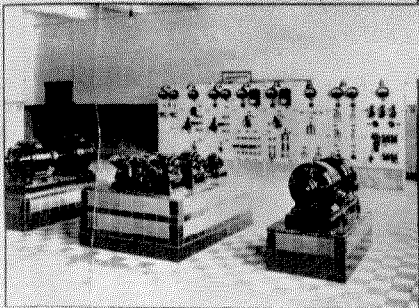
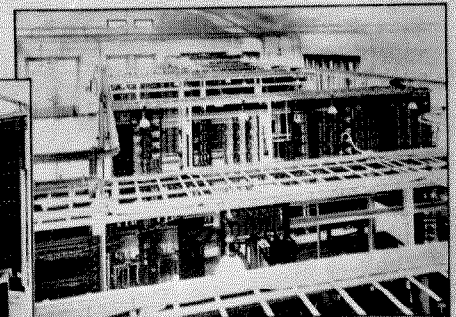
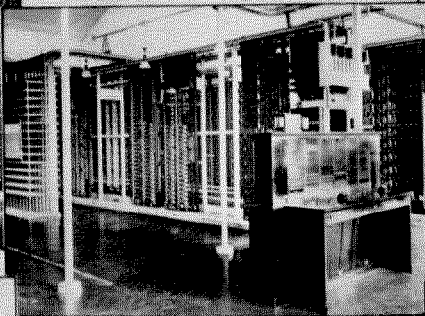
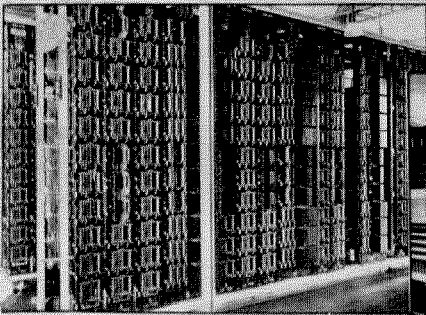
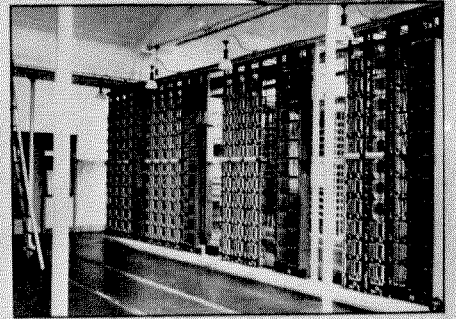
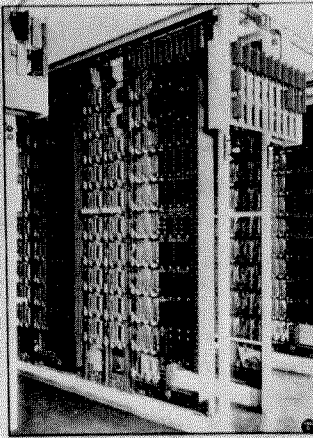
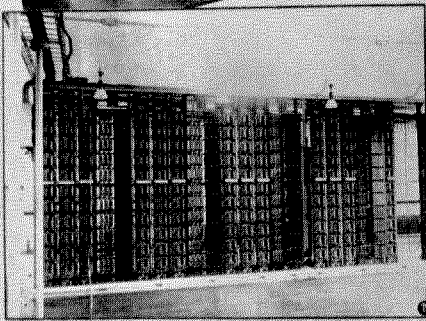
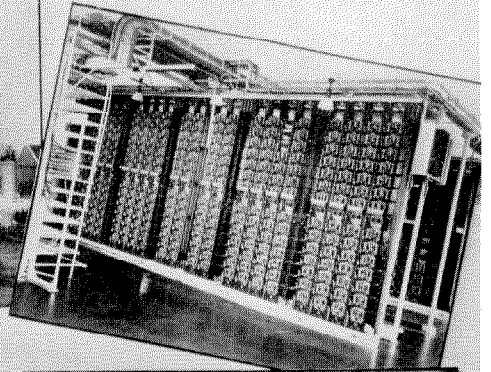
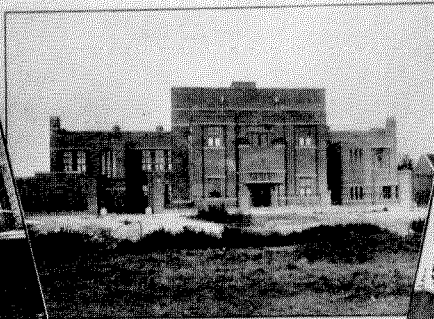
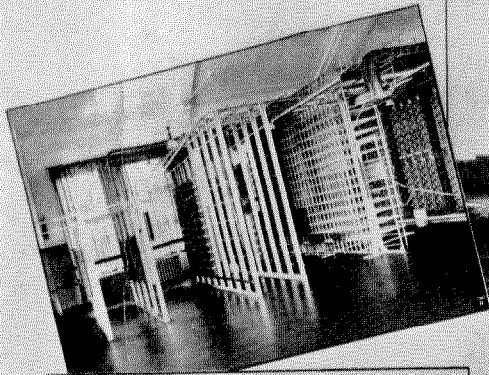

N° 7 A MACHINE  
SWITCHING SYSTEM

BEZUIDENHOUT EXCHANGE  
THE HAGUE-1923

# No. 7-A Machine Switching System

## Rotary System

By GERALD DEAKIN

*Assistant European Chief Engineer, International Western Electric Company—Chief Engineer,  
Bell Telephone Manufacturing Company*

A NOTABLE event in the progress of the No. 7-A machine switching system, often called the "Rotary System," took place in the Hague, Friday evening, February 15, 1924. On that date there was placed in service the new Centrum office, equipped for 700 semi-automatic lines and 1000 full automatic lines. The semi-automatic portion alone took the entire load of the then existing subscription of some 6200 lines. Saturday a small force watched the operation of the exchange for faults and irregularities, which were few in number. By Monday the exchange was carrying the full load as though it had been in service for many months, and, according to Hague officials, with a material and immediate improvement in service throughout the area, which has always been noted for good service.

The cut-over was interesting, first of all, for the reason that it made the Hague-Scheveningen area the first multi-office area to be served entirely by the No. 7-A machine switching system. This area now comprises three large offices in addition to Centrum. The four offices are equipped for 23,000 lines, of which about 5000 are connected to full automatic registers, and the remainder to semi-automatic registers. Another important feature was that the cut-over was planned by and made under the exclusive control of the staff of the Hague Municipality. A third feature was that the complete installation and final test out prior to turning the equipment over to the Municipality was made by the ordinary Dutch installation force of the Bell Telephone Manufacturing Company of Antwerp. No engineering inspection or test was made or found necessary.

This cut-over is cited at the beginning of this article to give a concrete illustration of the fact that the No. 7-A machine switching system has not only passed the trial and development stage but has reached the stage where it may be installed by any normal installation force without

specialists, and may be cut-over and maintained from the start by any properly equipped Telephone Administration without special help from the manufacturer. These are very important points on the Continent of Europe, where language, nationality, rates of pay and political considerations make it difficult, if not impossible, to maintain a general installation staff available for all countries. The Bell Telephone Manufacturing Company of Antwerp in conjunction with its Affiliated Companies throughout Europe and elsewhere has established in many countries small, but more or less permanent, national installation forces. These small forces, for the reasons just cited, must, if economical results are to be obtained, be capable of handling any kind of an installation. This is possible only when the installation work is of such a nature as not to require highly trained specialists or an elaborate installation equipment.

New Zealand may possibly be an even better illustration of the present status of the No. 7-A machine switching system. The New Zealand Government was one of the first to adopt the system and to date it has ordered nearly 50,000 lines of equipment, all of which have been or are being installed by the Telephone Administration under the supervision of a small engineering staff forming part of the Antwerp organization. This engineering staff, at the present moment, consists of five experienced engineers, one junior engineer and two clerks. This force is now supervising installations in no fewer than eight cities.

The No. 7-A machine switching system is one of the results of development work undertaken by the Western Electric Company in the late nineties. The system is based upon the use of power drive, which it was found, permitted larger and more robust switches than were theretofore employed.

With power drive came revertive control, based upon the principle that the call receiving mechanism and switch controlling mechanism,

called the register or sender, should be comprised of light and quick acting apparatus capable of following wide variations in dial speed as well as in the speed of the comparatively heavy switches. This is important, since the wider permissible limits of dial variation affect directly the cost of maintenance of the subscribers' dials.

In the No. 7-A machine switching system, the subscriber always dials into a sender located in the office to which his line is connected so that the conditions under which dialing takes place do not vary.

As the result of a rapidly growing demand in Europe for automatic equipment, the development and manufacture of the No. 7-A machine switching system was begun in Europe in 1911. The initial European studies were made in Berlin, but in 1912 the headquarters for development and manufacture were definitely established on the premises of the Bell Telephone Manufacturing Company in Antwerp. The system met with immediate success and the early orders for France, England, Switzerland, New Zealand, Sweden and Norway made it necessary to proceed without delay with the manufacture of the automatic apparatus.

As the existing factory buildings were not ample for the purpose, a new building had to be erected, but, in spite of all that had to be done and the short time which intervened before the outbreak of the great war, the Company was able to manufacture in Antwerp the entire automatic equipment for the first three automatic exchanges of this type installed in Europe. Many other exchanges now in operation contain apparatus also manufactured in Antwerp prior to the war.

The war was a great check to the progress of the system. The Antwerp factory was closed almost immediately after the commencement of hostilities. The tools and much of the partially manufactured apparatus were transferred to London, but shortly after this transfer the British Government, for reasons governed by war requirements, issued instructions making it impossible to continue further work there. The tools and apparatus were then transferred to the Hawthorne Works of the Western Electric Company in America, where manufacture was started on a small scale and continued until the end of

the war, thus permitting the Bell Telephone Manufacturing Company to make good the contracts it had taken, with some delays in the cut-overs.

Shortly after the signing of the armistice, energetic steps were taken to recommence manufacture in Antwerp. As the factory had been entirely stripped by the Germans, including the removal of the steam turbine upon which the factory depended for power, it took some time to put things in order, but, with everybody helping and with real co-operation, the manufacture of automatic equipment was again well under way in 1920.

During 1920 and 1921, the performance of the No. 7-A machine switching system apparatus in operating exchanges and the requirements of the exchanges themselves were carefully studied, maintenance costs were examined, further traffic studies were made, installation costs, government requirements and routines were carefully investigated; all with a view of finding out what could be done to reduce manufacturing, installation and maintenance costs. Since that time many important improvements have been made in the principal items of apparatus such as the finder, selector and sequence switch. The Antwerp Engineering Department includes a well equipped and highly organized automatic Circuit Laboratory, in which a very large number of valuable improvements and inventions have been made during the last four or five years. Circuits are tested to meet every conceivable combination of adverse circumstances as well as maximum and minimum line and junction resistance, inductance, capacity and leakage, also motor speeds, voltages, variations in commercial manufacture, margins, etc. When a circuit is passed by the Circuit Laboratory, its operation under all conditions is assured, there is no practising on the customer, likewise the limits for all pieces of apparatus are known. The operating limits given to the installer and maintenance men are not the laboratory limits. The practical operating limits always have ample margins of safety so that any adjustment made within these limits will insure the satisfactory performance of the apparatus.

From an equipment point of view, a great deal of work has also been done. This sort of work has to do with the placing of the equipment in

the exchange in such a manner as to assure economy from an installation point of view and easy accessibility from a maintenance point of view.

These improvements have not only reduced first and installation costs, but have, in addition, made material reductions in floor space requirements. All units comprising the No. 7-A machine switching system have now been standardized and, in addition to manufacture in Antwerp, preparations are being made for the immediate manufacture of the system by Le Materiel Telephonique in Paris and the United Incandescent Lamps and Electrical Company, Ltd., in Budapest. The most modern manufacturing methods are employed throughout and by far the greater part of the manufacturing operations is confined to punch press and automatic screw machine work.

It might not be amiss to mention here that, when the development of the No. 7-A machine switching system was begun, it contemplated both full automatic and semi-automatic operation. The first exchange was full automatic, the second semi-automatic and in the next few succeeding exchanges the semi-automatic installations rather predominated. However, the change in conditions brought about by the war re-acted strongly in favor of full automatic, so that at the present moment there seems to be little field, except in special cases, for semi-automatic operation.

The change from semi-automatic to full automatic was anticipated with the result that each semi-automatic No. 7-A machine switching system furnished was made readily convertible to full automatic, the only change involved being the replacement of the semi-automatic registers and the associated operators' equipment by full automatic registers. Such changes are now being carried out in Zurich, the Hague and elsewhere.

The careful study of, and experience gained in meeting European requirements during the past twelve years show conclusively that, in order to succeed in Europe, a system must be capable of meeting the many and varied requirements of the different Governments, Administrations and Municipalities. To do a great many things, all in the proper way, is not necessarily incompatible with economical manufacture and installa-

tion. The apparatus, except for relay windings, remains the same, the circuits differ, but it is the great flexibility of the No. 7-A machine switching system which permits it to meet with accuracy and ease any reasonable requirements for local, short haul, long distance and special services.

The greater part of the Antwerp plant, employing some 3,300 people, is now devoted to the manufacture of the No. 7-A machine switching system. The combined engineering staff of Division No. 1 of the European Engineering Department and of the Bell Telephone Manufacturing Company comprises some 240 people and is highly specialized for the study, design and execution of the smallest to the largest automatic telephone plant, from the small rural system with its many variations of service and junction working to the largest multi-office network with its numerous problems. An idea of the wide distribution of the No. 7-A machine switching system may be obtained at a glance from Table I. In addition to these complete equipments, automatic apparatus to the extent of 14,500 lines has been supplied to give automatic call distribution to existing manual common battery offices.

From the beginning, the cost of maintaining the No. 7-A machine switching system has compared favorably with other machine switching systems. It is possible to limit night maintenance to arrangements for replacing blown fuses or other work of an emergency character, and to do all routine testing and make repairs during the usual working hours. Certain central offices have been subjected to labour troubles and in at least two instances were left entirely unattended for a period of a week or more, except as regards the minimum labor necessary for charging the storage battery. In every case the equipment has continued to function with little trouble.

A small satellite forming a part of the Zurich network was placed in service during the early part of 1923. Almost immediately after cut-over, visits were restricted to two mornings a week, during which time the storage battery was charged and the necessary routine tests made; only once during the first eight months was it necessary to make a special visit to the office on account of trouble.

Many of the Telephone Administrations maintain complete and carefully prepared maintenance records. Faults are tabulated by circuits and reclassified by character, thus the number of faults occurring in each class of circuit is known, also the causes, that is, whether they were due to dust, loss of adjustment, opens, etc. The company assists in and encourages such work in every way possible, since these records, apart from their value to the Telephone Administrations, are of much value to the apparatus and circuit designer in disclosing, by careful study

machine switching system, is now being incorporated, under certain conditions, in direct impulse systems, and in certain competitive European power driven systems. In the No. 7-A machine switching system, the sender circuit is not a mere addition, it is in reality the heart of the system, which is built around it.

#### *Apparatus Manufacture and Design*

Each piece of apparatus in the No. 7-A machine switching system is manufactured, assembled and adjusted according to written specifica-

TABLE I  
No. 7-A Machine Switching System Lines Ordered

Country	Proceeding		Cut-over		Total		Grand Total
	Full	Semi	Full	Semi	Full	Semi	
Australia.....		1,600		3,000		4,600	4,600
Belgium.....	21,500		7,500		29,000		29,000
Denmark.....			1,440	11,200	1,440	11,200	12,640
England.....	1,860		2,780		4,640		4,640
France.....	5,000	570	120	11,180	5,120	11,750	16,870
Holland.....	15,100		5,000	18,000	20,100	18,000	38,100
Hungary.....	16,000				16,000		16,900
Italy.....	2,500				2,500		2,500
New Zealand.....	39,000		9,400		48,400		48,400
Norway.....	24,500		12,040	4,620	36,540	4,620	41,160
Roumaina.....	3,000				3,000		3,000
South Africa.....	1,000		1,135		2,135		2,135
Sweden.....			200	1,800	200	1,800	2,000
Switzerland.....	5,700		7,100	8,100	12,800	8,100	20,900
	135,160	2,170	46,715	57,900	181,875	60,070	241,945

Total lines ordered..... 241,945  
 (Ordered since the war..... 145,905)  
 Total lines in service..... 104,615

from month to month, any weak points which may exist.

The No. 7-A machine switching system was first in Europe in many matters pertaining to the handling of service in large networks. The first call indicator equipments were of the No. 7-A machine switching system type. The first office prefix translator was also of the No. 7-A machine switching system type and was put into service in the Amager Office, Copenhagen, January, 1923. The Copenhagen network is one of the largest in Europe and compares favorably in size with Paris. At the present moment this network comprises twenty-five offices and serves 118,000 stations. The sender circuit, which has always been a fundamental part of the No. 7-A

tions, giving definite limits for air gaps, spring pressures, spacing, speeds, short circuited turns, etc. When the various pieces of apparatus comprising a circuit are assembled and wired, they must function as a unit to meet all requirements without special or individual adjustment or "tuning up," the success of which is largely dependent upon the degree of perfection attained by the individual worker. To facilitate this work outside of the factory, printed instruction booklets have been or are being issued for each piece of apparatus, showing in detail, with ample illustration, how every adjustment should be made and the tools and gauges which should be employed. At first thought it might seem that these preparations are unnecessarily elaborate, but

the necessity will be appreciated when the wide distribution of the system is considered and when it is realized that very few of the people who install or maintain it will ever have the opportunity of visiting the factory of origin in order to become acquainted with the apparatus. The

apparatus as a whole has reached the end of its usefulness. The life tests so far made on the new finder cover a period of two years, and indicate that with careful maintenance there is no part of the switch which should require replacement in less than twenty-five years; the time

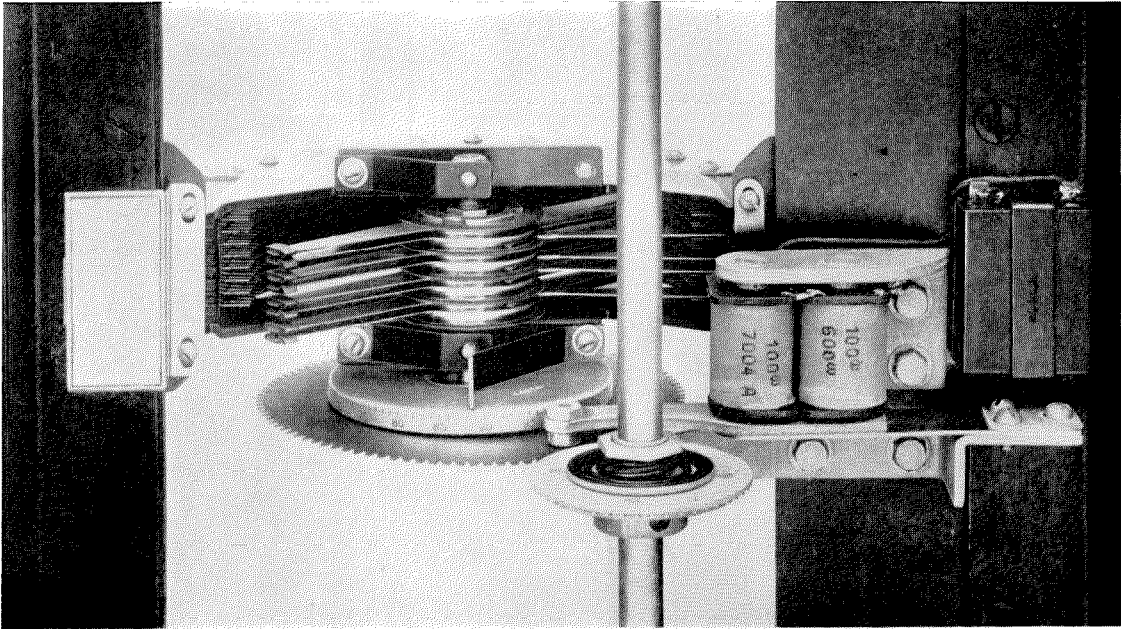

Figure 1—No. 7002 Type Finder

majority of the installers and maintenance men must gain their knowledge from written and limited verbal instructions.

The manual part of the No. 7-A machine switching system is not peculiar to it. On the contrary, it makes use of standard flat, side armature and other relays, to which special reference will not be made. The finder, selector and ribbon cable are peculiar to the system. The sequence switch is peculiar to and advantageous in any system employing power drive.

Every advantage has been taken of the data afforded by life tests. No piece of apparatus has been or is being used which has not promised or does not promise a very long life under conditions met with in actual practice in so far as they can be reproduced in the laboratory. Past experience has proved that a well designed piece of automatic apparatus has a long life and that an exchange is likely to become obsolete, due to changes in the art, long before the automatic

element in real life may, of course, introduce conditions not considered or not possible to reproduce in a laboratory test.

#### *Finder*

The No. 7002 type finder, now used as a first and second finder, as a sender selector and for many miscellaneous purposes of call distribution and in rural systems, is shown in Figure 1. It comprises an arc, a brush carriage with a flexible gear (driven gear), a clutch, a spark quencher and a driving gear, the latter attached to a continuously rotating vertical shaft.

The arc has capacity for 102 lines, 100 for regular use and 2 for test purposes. The terminals are mounted in 8 horizontal rows of 51 terminals each on an arc of 180°. The arrangement of the terminals in the arc and of the brushes in the rotor is such that one-half the lines, for example, the odd horizontal rows, are wiped over by one set of brushes during one-half of a revolu-



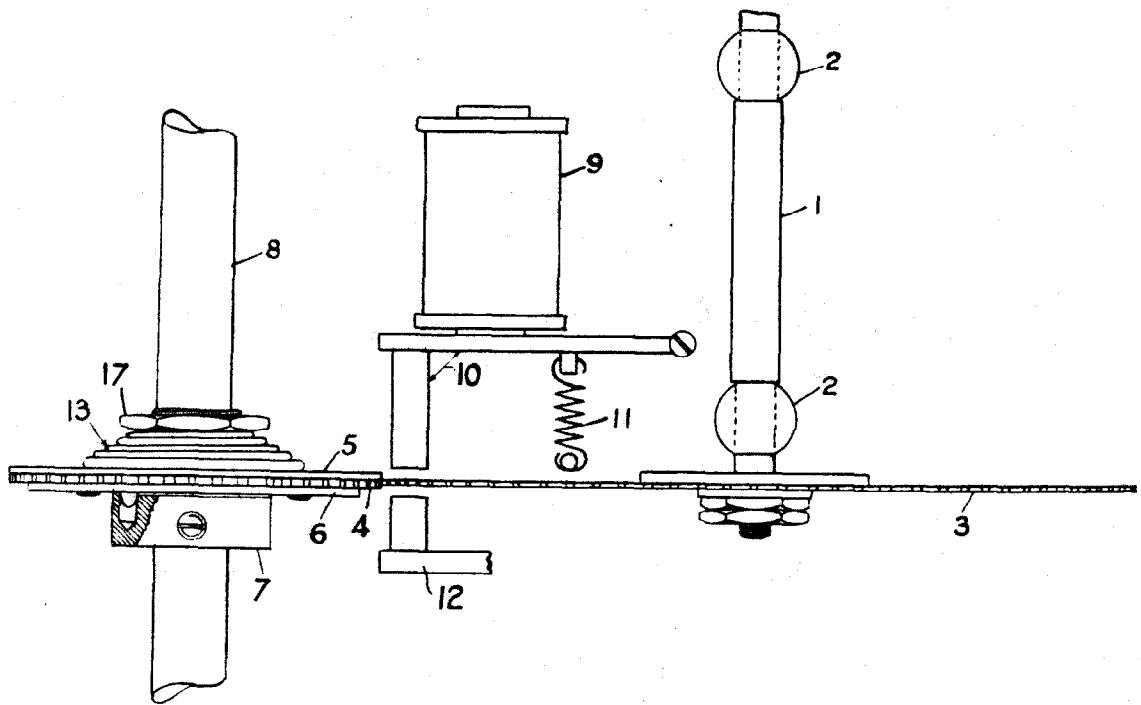

Figure 3—Gear Drive—Elevation

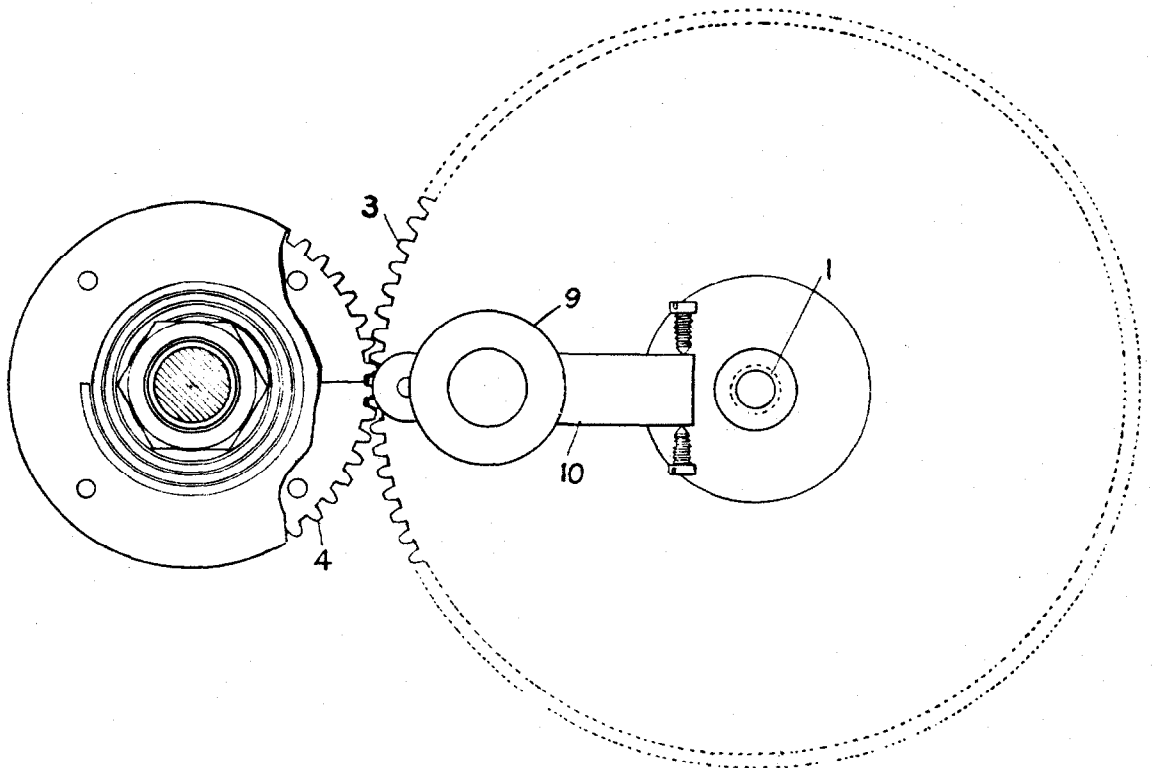

Figure 4—Gear Drive—Plan

tion, while the other half of the lines, or the even vertical rows, are wiped over by another set of brushes during the other half of the revolution. Connections are made to the two sets of brushes by means of the same set of feeder brushes.

The brush carriage is supported by self-aligning bearings mounted directly on the frame of

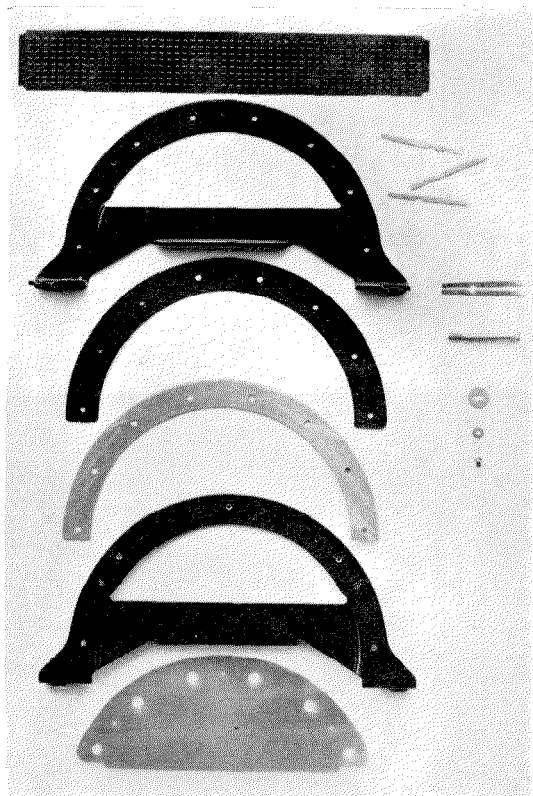

Figure 2—No. 7002 Finder—Arc Details

the arc. The self-aligning bearings are ball shaped and the circular holes in which they rest are reamed out after the assembly of the arc. In this way the center line of the brush carriage shaft is made to coincide with the center line of the semi-circular arc, no matter what irregularities may exist in the arc frame.

The details of the arc may be seen in Figure 2. Nearly all parts are punched. The terminals are insulated by and held in position between layers of Foudrinier paper, aluminum spacers being slipped in between the insulating strips between the different rows of terminals. The component parts are assembled in a suitable fixture, heated and then pressed to the proper thickness. The

compound in Foudrinier paper flows into the spaces between the terminals and excludes all air from the arc. When the arc cools, it is removed from the fixture, the terminals being solidly embedded in the compound. A strip of glazed non-hygroscopic paper, shown at the top of Figure 2, is slipped over the inner end of the arc terminals, thus giving the inner surface of the arc a smooth glossy finish and one which may be readily dusted and cleaned.

The gear drive which is now employed in the finder, selector and sequence switch functions as follows:

Referring to Figures 3 and 4, (1) is the brush carriage shaft revolving in self-aligning bearings (2). Attached to the lower end of the shaft is a thin flexible German silver disc gear (3), .015" thick and adapted to mesh with a corresponding driving disc (4), .020" thick and clamped between upper plate (5) and lower plate (6), the latter being secured by pins to collar (7), attached to continuously rotating vertical shaft (8). In order to cause the driven gear (3) to remain in positive mesh with the driving gear (4), the former is positioned and thereby tensioned so that it tends to spring through the teeth of gear (4), but is prevented from doing so by upper plate (5). This is the position of the gears when the finder is hunting. The gears remain in perfect and true mesh solely under the tension of the driven disc. That the wear due to this perfect mesh is extremely small and the life extremely long is shown by a partial life test made on a pair of gears under full load. The smaller of the two gears made 18,000,000 revolutions and at the end of this test not more than 20% of the useful meshing surface of the teeth had worn away.

The driven disc is controlled by a clutch (shown diagrammatically in Figures 3 and 4), comprising a magnet coil (9), armature (10), spring (11) and back stop (12). When the clutch magnet (9) is energized, armature (10) is attracted against the tension of spring (11). The driven disc (3) as previously indicated, moves under its own tension into mesh with the driving disc (4). When the wanted line or junction is found, the circuit in some well known manner deenergizes the clutch magnet, thereby releasing the armature which forces the driven disc (3) against back stop (12), thus holding the brushes

securely on the line terminals without pawl or other mechanical device cut or spaced to coincide with the spacing of the arc terminals. As the pressure of the armature on the flexible gear is about 4 pounds, the stopping action is extremely

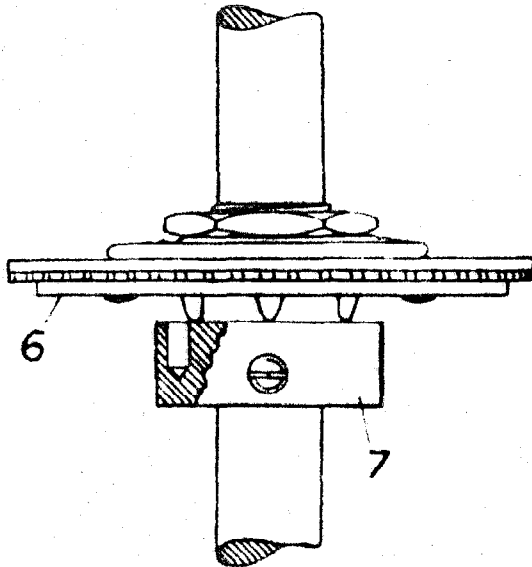

Figure 5—Gear Drive—Driving Gear Raised

quick. This quick action permits the finder to hunt at very high speeds. The normal hunting speed adopted as standard is 45 terminals per second. Overstepping, however, does not occur in the standard circuit until the speed of hunting exceeds 70 to 80, depending on the switch. In the laboratory, using more powerful clutches and faster relays, it was found possible to stop with accuracy when hunting at a speed of 120 terminals per second. This is a very much higher speed than is necessary for practical purposes.

To place the finder out of reach of the driving gear so as to permit the former to be rotated by hand when the power magnet is energized, means are provided, as shown in Figure 5, whereby the driving disc assembly may be lifted between the handle of a pair of pliers so that the pins attached to lower plate (6) rest on top of the shoulder of part (7), which is rigidly attached to the shaft. The driving disc assembly is held together by means of spiral spring (13). To restore the driving disc to normal it is merely necessary to stop it by hand until the pins fall into corresponding holes in part (7).

The assembled brush carriage, with driven

gear, number disc and self-aligning bearings, is shown in Figure 6. The unassembled piece parts and details are shown in Figure 7.

The contact ends of the brushes, generally called the brush shoes, are of hard phosphor

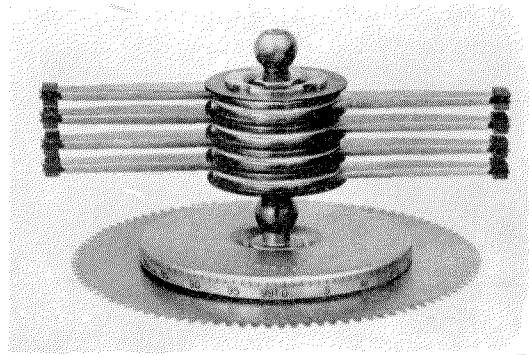

Figure 6—No. 7002 Finder—Assembled Brush Carriage

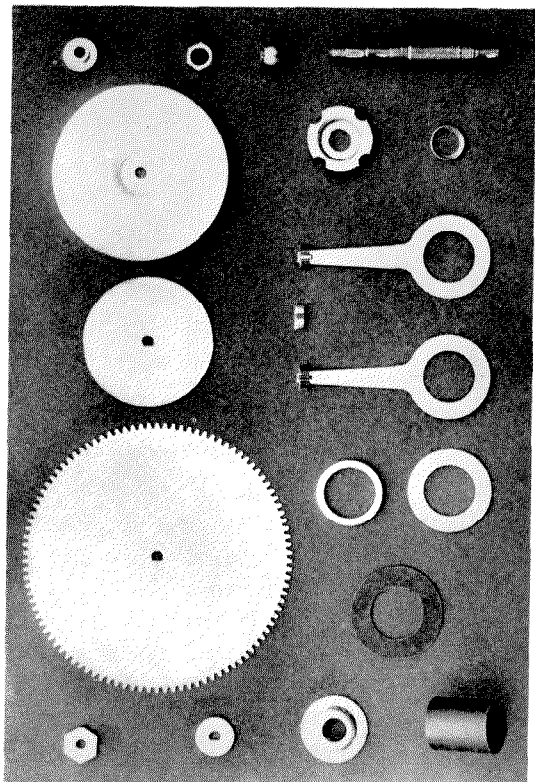

Figure 7—No. 7002 Finder—Brush Carriage Details

bronze and project .005" beyond the fibre insulator on each side. The purpose of the fibre insulator is to prevent short circuiting adjacent terminals when the brush shoe is midway be-

tween them and also to afford a smooth guide when the brush is travelling over the terminals. The contact ends of the brush shoes are so shaped that such wear as is unavoidable takes place at right angles to the direction of motion so that, should one shoe wear down faster than another, the angular relationship of all brushes

remains unaltered. The brush carriage is assembled in a special fixture having two diametrically opposed grooves so arranged as to receive the projecting ends of the brushes. By this means the brushes are lined up with very great accuracy. The design of the whole is such that there is no necessity whatsoever for any further adjustment of the brush carriage after it leaves the fixture.

The clutch is an extremely simple and powerful mechanism. The magnet and armature back stop assemblies are shown in Figure 8. All magnets in the No. 7-A machine switching system are self-protecting and for 18 volts, generally 200 ohms. The pressure of the armature against the back stop is obtained by means of a heavy reed spring and the final adjustment is made in the factory during assembly. The magnet and back stop are attached to the bay framework by means of heavy hexagonal headed screws, as

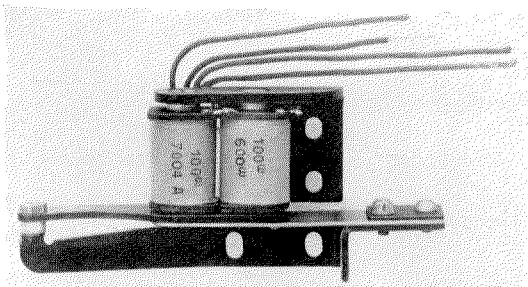

Figure 8—No. 7002 Finder—Magnet and Armature Back Stop Assemblies

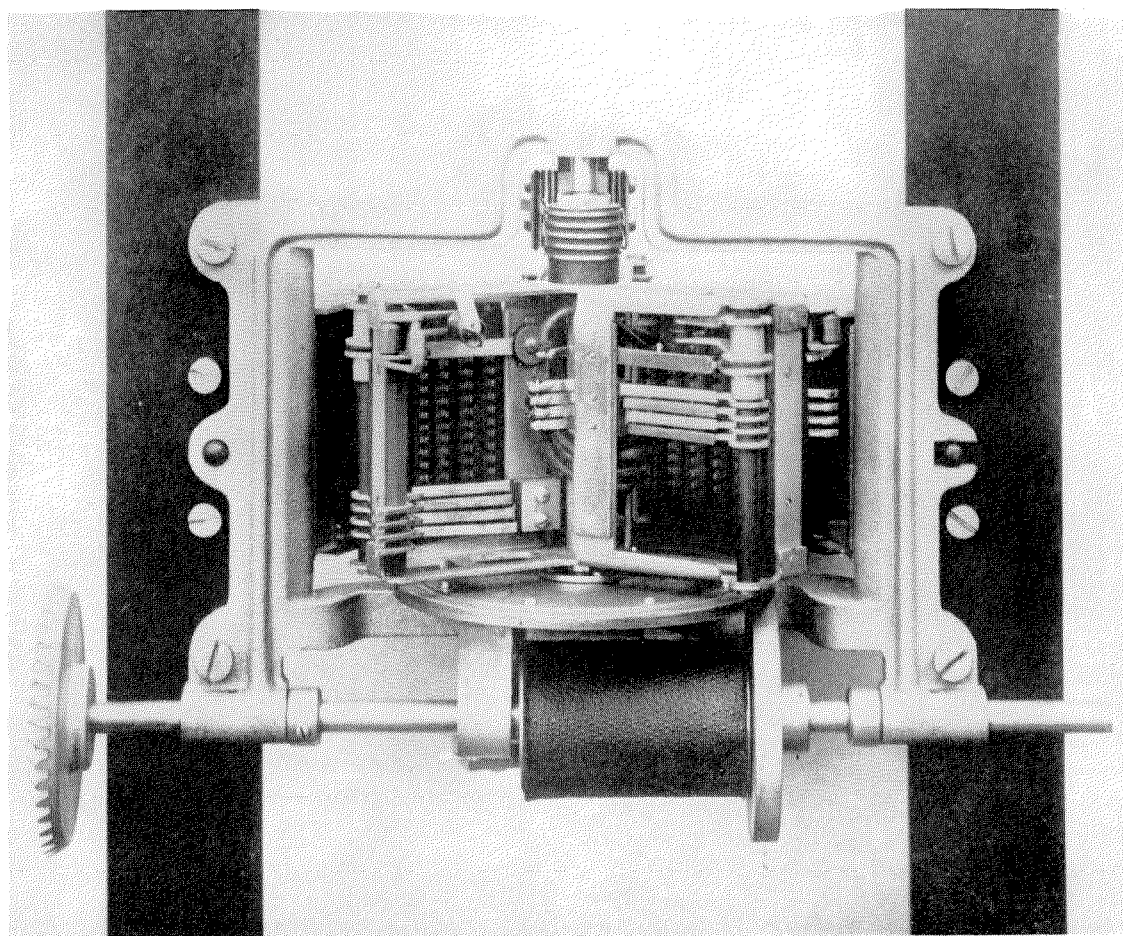

Figure 9—No. 7001 Finder

shown in Figure 1. The same size and type of screw is employed throughout for mounting purposes, also for the clamping of the line and cut-off use and gave a very good account of itself under very adverse circumstances in Marseilles and Zurich. These two exchanges were cut-over

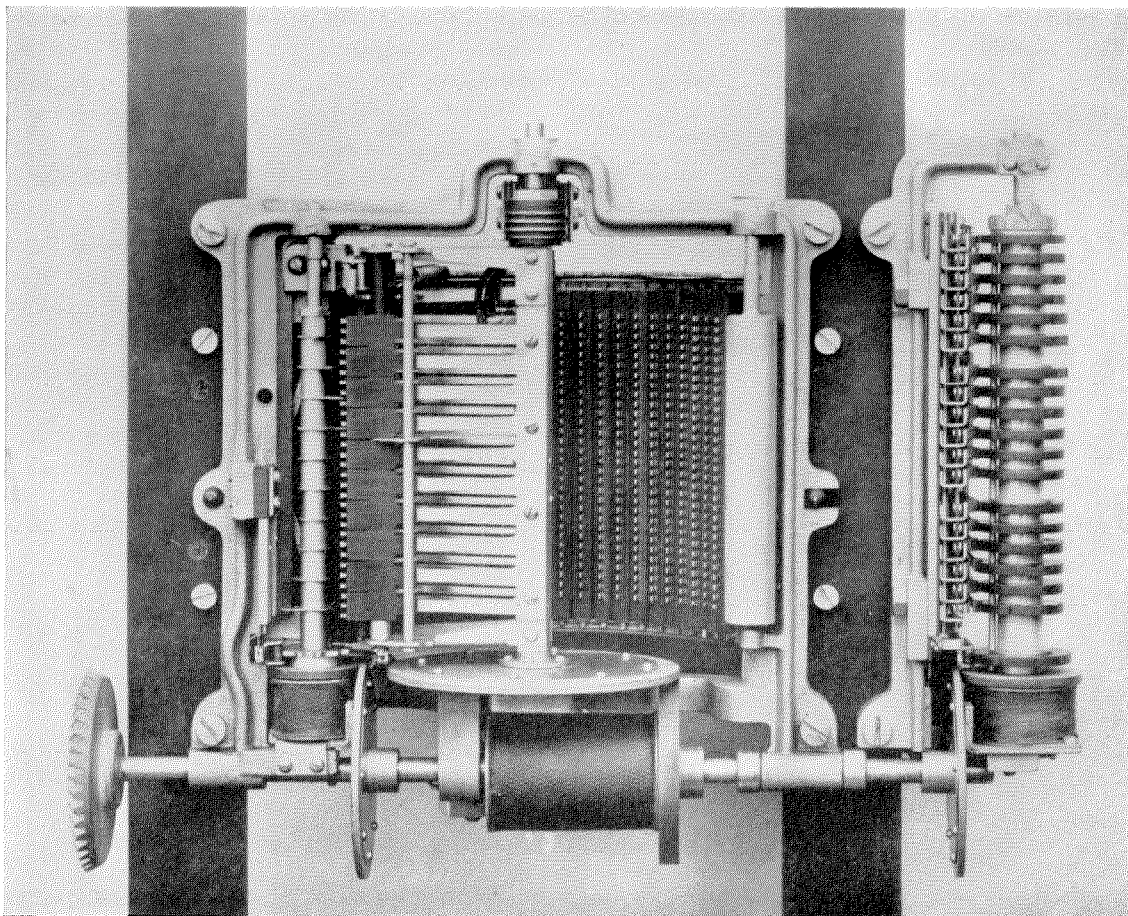

Figure 10—No. 7001 Selector Mounted with No. 7001 Sequence Switch

relay and resistance mounting plates. One box spanner wrench, therefore, answers many purposes.

The finder has a very high insulation resistance and as all air is excluded from the arc, it is particularly suitable for humid climates. The insulation properties of the arc have been given laboratory tests under the most severe conditions as to relative humidity and not only have they been found to be extremely high for the abnormal conditions created, but they also show a remarkable recovery after the conclusion of the tests.

The type of finder employed until recently and known as the No. 7001 is shown in Figure 9. This switch is now in very general and successful

during the latter part of the war and were unavoidably overloaded from 100% to 200%. This overload continued for 18 months or two years pending the receipt of additional equipment, which could not be obtained during the war. In spite of this heavy overload, which caused in particular a great deal of useless rotation of the first and second line finders, an almost insignificant amount has since been spent on repairs due to excessive wear. This earlier finder has capacity for 60 lines only and required 7 inches vertically for mounting, whereas the new finder, with its capacity for 102 lines, requires but 3½ inches for mounting.

### Selector

In view of the great success attained with the gear drive in the new finder, it was decided early last year to apply this form of drive to the selec-

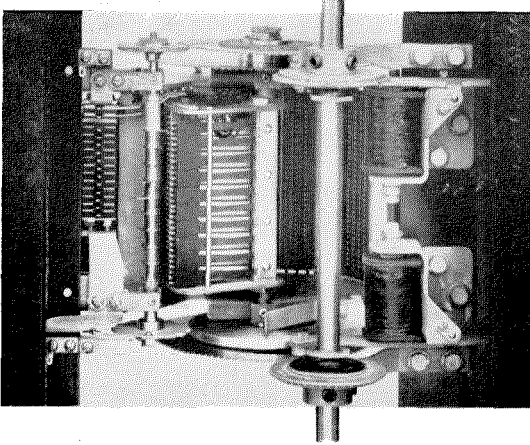

Figure 11—No. 7009 Selector Mounted on Bay

tor and sequence switch. The new selector is now in process of manufacture. It does not differ in any essential respect from the first or No. 7001 type, Figure 10, so far as the method of selection and the character of the brush contacts are concerned.

A front view of the new No. 7009 selector mounted in position on a bay with clutches and vertical shaft is shown in Figure 11. The com-

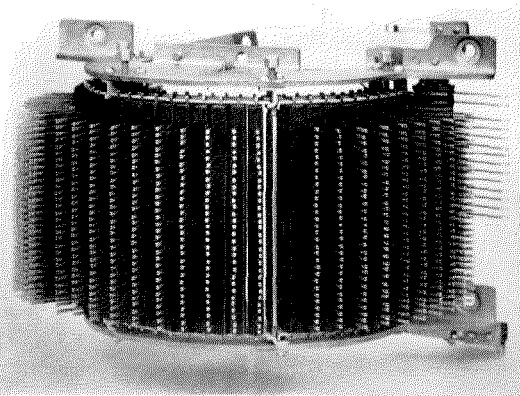

Figure 12—No. 7009 Selector—Rear View of Arc

plete selector consists of a semi-circular arc, Figure 12, a brush carriage, Figure 13, a trip spindle and terminal block, Figure 14; two clutches and two driving gears, Figure 11.

The arc, Figure 12, consists of a punched mild steel frame securing a series of vertical terminal blocks, one of which is shown in Figure 15. The blocks are numbered in groups of 10 arranged in three sectors which together form an arc of 180°. Moulded in each terminal block are 30 hard phosphor bronze pins, the inner ends of which are suitably formed to be engaged by the 10 sets

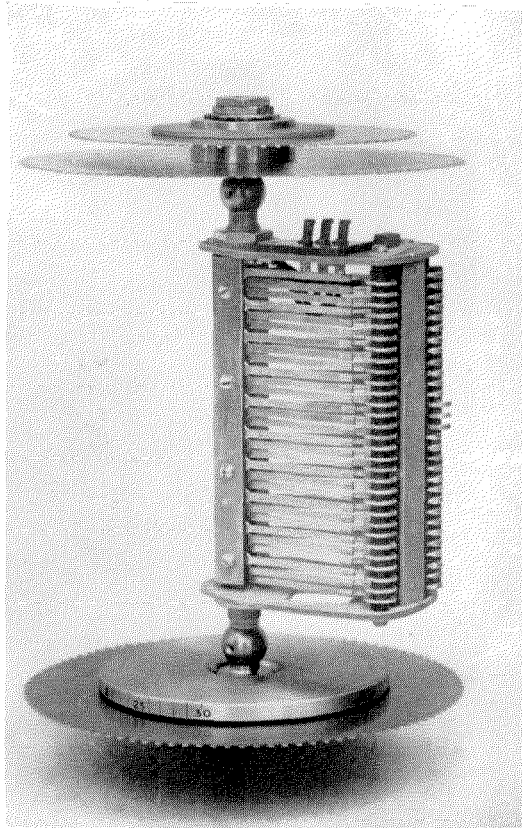

Figure 13—No. 7009 Selector Brush Carriage

of three brushes, which compose a part of the brush carriage, Figure 13; the outer ends are slotted and tinned to receive the ribbon cable, see Figure 15. The composition used for the moulding is tough and being non-hygroscopic provides a very high degree of insulation between the terminal pins. The same block is employed in both group and final selectors.

A group selector of the new type has capacity for 300 junctions, arranged in 10 rows of 30 circuits each. Where fewer junctions are required, the unnecessary terminal blocks are omitted. The final selector, while of the same construction, is ordinarily equipped with terminal blocks for

200 lines only, since numerically the capacity of the final selector must be some full hundred fraction of a thousand. Where, however, P.B.X. traffic is heavy and where it is not desired to reduce the numerical switching capacity of the exchange the additional 10 terminal blocks, or any part of them, are installed in the third sector of

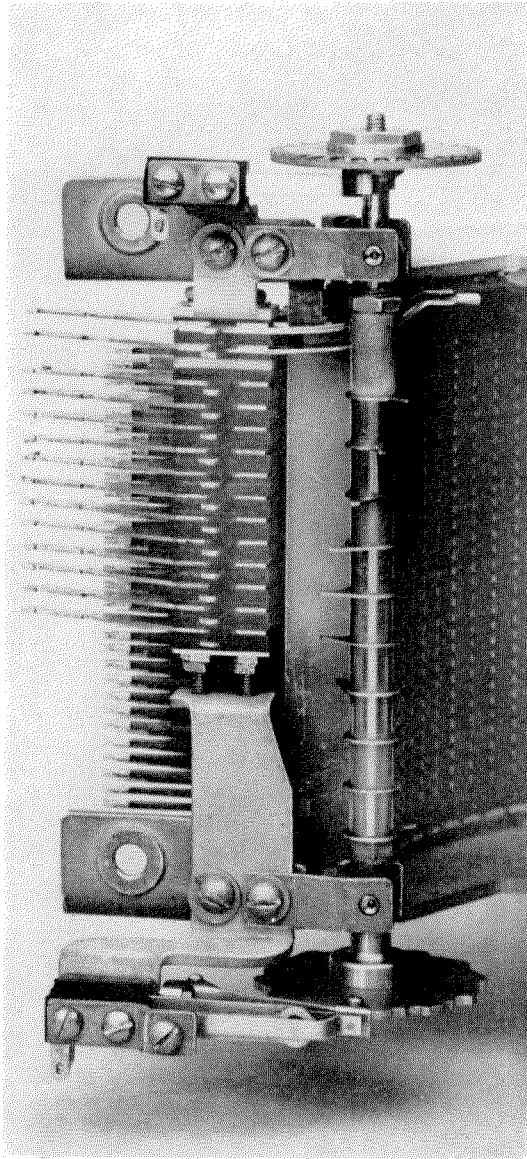

Figure 14—No. 7009 Selector Trip spindle and Terminal Block

the arc. A 10,000 line exchange may thereby be equipped for 15,000 lines. The extra 5000 lines are without individual numbers and may be used as auxiliary PBX junctions, but not as the first

junction of a group. The first junction requires a subscriber's number and must be in the block of 10,000 numbered lines.

The brush carriage, Figure 13, comprises 10 sets of three phosphor bronze brushes connected in multiple to three feeder brushes, which may be seen just below the upper discs. These feeder brushes press on collector rings attached to the under side of the top arc frame. The driven gear and number disc are attached to the lower end of the brush carriage shaft. Rotating freely on the upper end of the shaft immediately above the top bearing is a pair of reduction gears, the purpose of which is to drive the trip spindle, Figure 14. The 10 sets of three brushes are normally held in a latched position by 10 ebonite latch blocks, see Figure 11. The trip spindle, Figure 14, is provided with 10 tripping fingers, the points of which trace out a spiral around the shaft. One set of brushes, unlatched, may be seen in Figure 13.

The selector is controlled by two clutch magnets, Figure 11, each operating in exactly the same manner as in the finder. The upper magnet controls the rotation of the trip spindle and the lower magnet that of the brush carriage. As previously stated, the No. 7-A machine switching system is a revertively controlled system. When the fundamental circuit is closed, following the setting of the register or sender, the trip spindle clutch is energized, thereby causing the upper flexible driven gear to engage the upper driving gear and, by means of reduction gears, to rotate the trip spindle at approximately 15 steps per second. The interrupter cam attached to the lower end of the trip spindle, Figure 14, periodically closes the interrupter springs and thus causes impulses to be sent back to the sender. When the proper number of impulses have been sent, the fundamental circuit is opened and the clutch is released, with the result that the trip spindle comes to rest in the selected position with the appropriate finger projecting to trip the proper set of brushes. The lower magnet is now energized, the brush carriage rotates and, as it passes the trip spindle, the selected set of brushes is tripped. This set of brushes makes contact with the corresponding horizontal row of terminal pins, the remaining nine sets of brushes clear the pins by approximately 1-16". The terminal pins and brush shoes, as previously

stated, are both made of hard phosphor bronze; the contact surfaces are given a high polish. The brush shoes jump from one set of terminal pins to the next under the considerable pressure exerted on them by the multiple reed springs

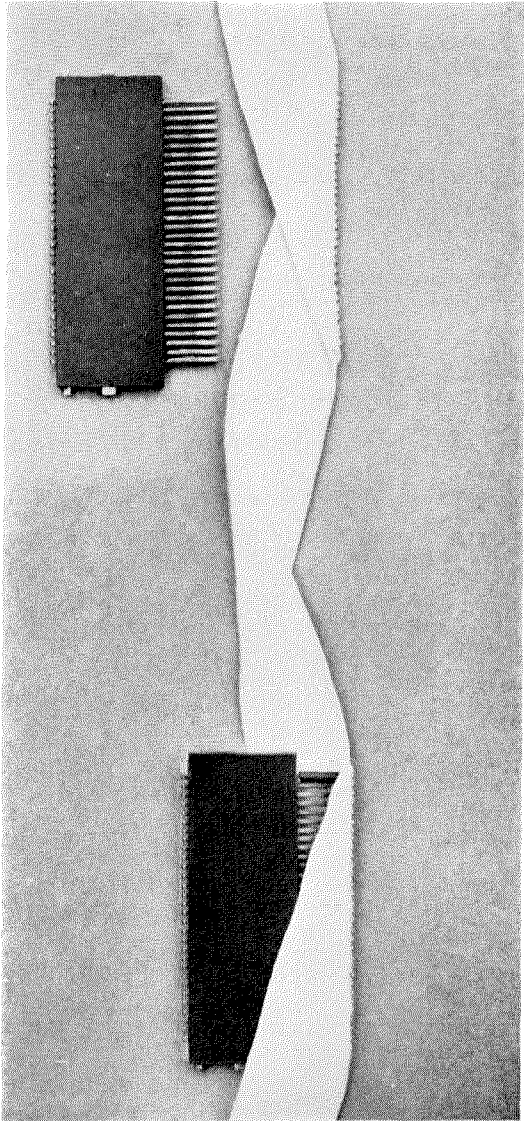

Figure 15—Ribbon Cable and Selector Terminal Block

at the rear, which springs also act as the conducting medium. The contacts are markedly self cleaning, extremely reliable, and, by virtue of the hard polished material employed, have very long life. The tripped set of brushes is reset at the end of a connection. This is done by means of a roller over which the brushes pass

after they leave the last terminal block. The roller forces the brushes back far enough to place them again under the control of the latch block.

When used as a group selector, the normal hunting speed is 30, so that the 30 junctions in one row may be tested in a period of one second. The hunting speed, if necessary, could be increased to 60 or more, but the time gained in selection by so doing is not worth the extra wear that would be thrown on the selector brushes and terminal pins when continuous hunting is considered. By slipping the multiple in the well known manner, a selector rarely fails to find a free junction in the first sector of the arc. When the switch is used as a final selector, the brush carriage speed is reduced to 15 steps per second so that the frequency of the impulses transmitted to the sender in the selection of the units is the same as that transmitted by the trip spindle.

From what has been said it will be seen that the normal speed of the selection, apart from hunting, is 15 steps per second instead of 10 steps per second, which is the average maximum speed for systems employing direct control.

An idea of the accuracy and precision with which the revertive impulses are transmitted back to the sender may be obtained from the oscillogram, Figure 16. The openings and closures are almost instantaneous, and the whole series of impulses is completely free from any indication of vibration. It is because of features such as this that the No. 7-A machine switching system functions with extreme accuracy over long and high resistance lines and junctions. Except for repeated 2-wire tandem junction working, repeaters are not employed at either end of any junction met with in ordinary exchange practice.

To facilitate testing and installation, all connections are brought out to a terminal block at the left, see Figure 14. The soldered connections are hidden from view by the iron bay but the test tabs are accessible from the front, see Figure 11.

Self-aligning bearings, secured directly to the arc frame, are employed throughout as in the line finder. The shaft is grooved at the bearings and by means of a grease gun, a heavy lubricant, such as vaseline, may be forced into the grooves through the holes in the bearings; these holes may be seen in Figures 11, 13 and 14.



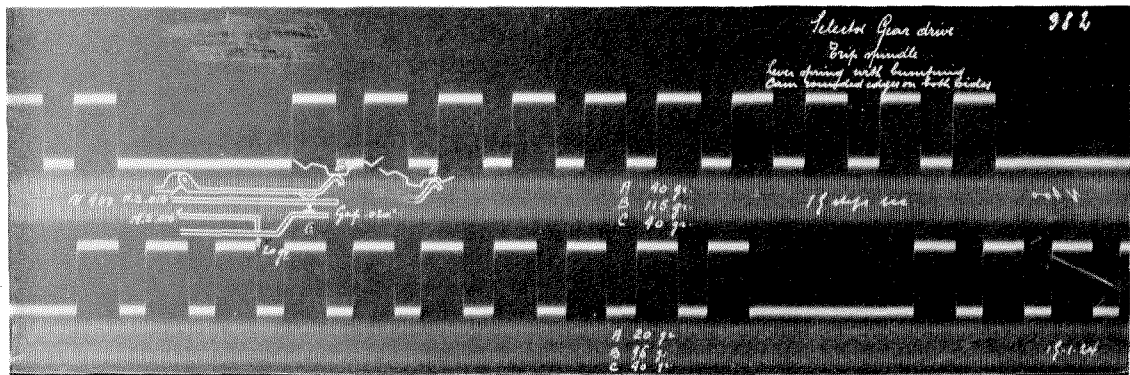

Figure 16—Oscillogram of Current Impulses Produced by Trip Spindle of a Selector

#### Upper Oscillogram

The spring tension at  
 A = 40 grammes  
 B = 115 grammes  
 C = 40 grammes  
 D = 20 grammes

#### Lower Oscillogram

The spring tension at  
 A = 20 grammes  
 B = 95 grammes  
 C = 40 grammes  
 D = 20 grammes

The springs marked N. S. .016" are made of nickel silver .016" thick.

In both cases the speed of the trip spindle is 15 steps per second whilst the oscillograph is operated at 400 ~ per second.

#### Ribbon Cable

From the beginning one of the important economic factors in the wiring and maintenance of the 7-A machine switching system has been the ribbon cable specially developed for multiplying individual banks or arcs, Figures 15 and 17.

Ribbon cable is composed of a number of parallel tinned copper wires, insulated from each other by silk and woven into the form of a flat ribbon with patterns; that is, with the various wires exposed at periodic intervals. To the left in Figure 17, is a photograph of the cable as it comes from the loom. To attach the cable, the pattern is first opened on a comb after which the cable is twisted into the form shown at the right. The final position occupied with relation to a selector terminal block is clearly shown in Figure 15. Ribbon cable is also used to multiple finder arcs. The compactness and accessibility of this type of cable at finder arcs may be seen from the photograph shown as Figure 18.

This type of cable has proved remarkably successful in practice. All soldered connections are exposed to view at all times. The wires are rather widely separated and, as silk is used throughout for insulating purposes, the cable gives very satisfactory results in humid climates. Its openness permits it to dry out rapidly.

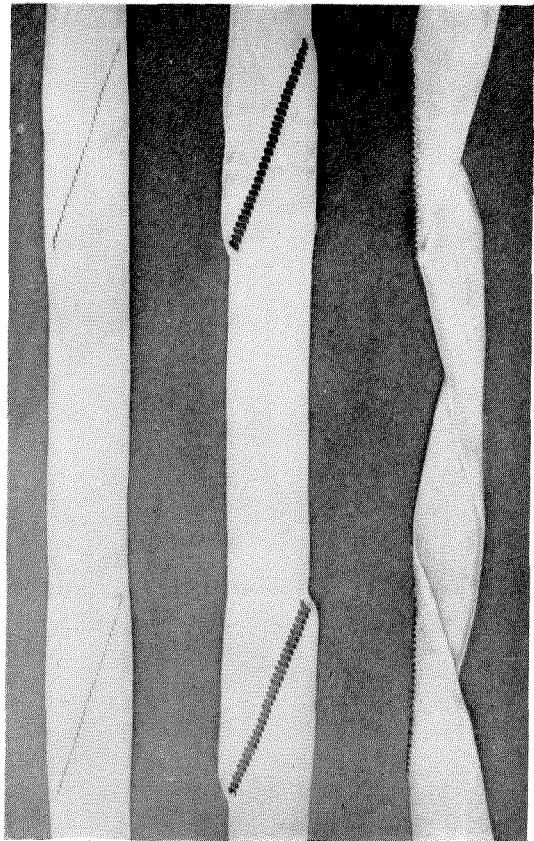

Figure 17—Ribbon Cable

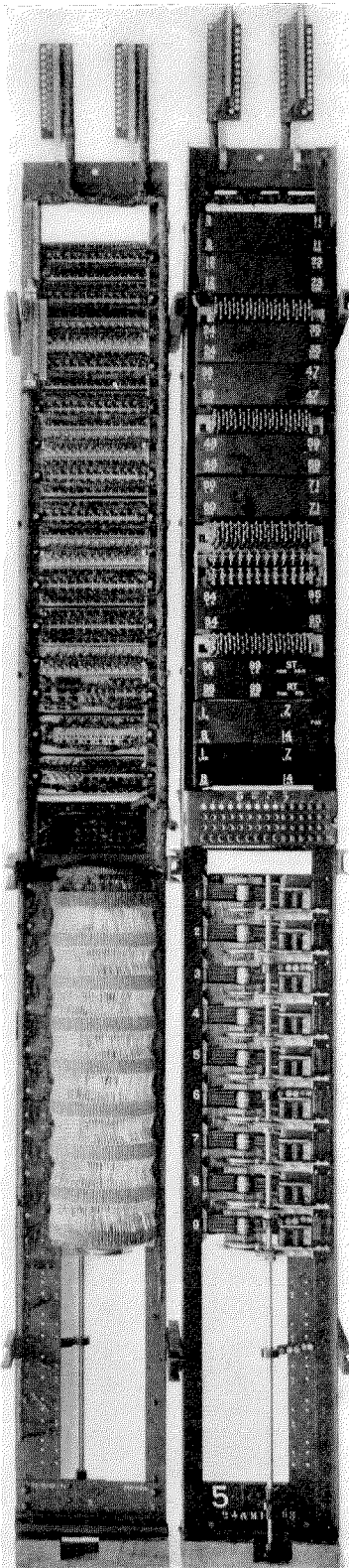

Figure 18—1st Line Finder Bay

### *Sequence Switch*

Two different types of sequence switch are in general use in Europe, both of which employ the magnet form of drive. The earlier type is known as the No. 7001 and is shown in Figure 19. As will be observed, this switch mounts verti-

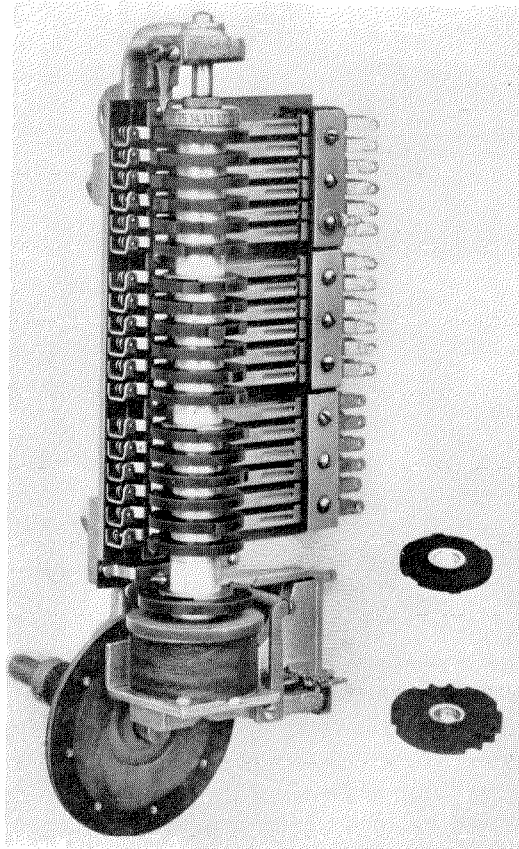

Figure 19—No. 7001 Type Sequence Switch

cally, and the various spring combinations, not unlike those of a relay, are operated by ebonite cams, the cutting and positioning of which predetermine the sequence and particular combination of circuits to be established. This type of switch afforded a maximum of 18 make-before-break operations. The later switch, used since 1920, provides for a maximum of 24 sets of quadruple springs, positioned to contact with 24 segments of metal, carried on insulating discs. As each segment or arc, which is of phosphor bronze, may be cut to contact with any, all, or none of the four springs with which it is associated at any fractional part of a revolution of

the switch, and as there are 24 sets of such springs, any desired circuit combination may be made. The possibilities of circuit design are, therefore, extended to an almost unlimited degree by this form of switch.

Both of the above described switches are driven by magnetic clutches. In the latest No. 7-A machine switching system, now being in-

tion to a minimum since the circuit combinations and connections, when once established, are maintained without further expenditure of energy in the switch itself.

Standard sequence switches are built in various sizes, from 8 to 24 cams, depending upon the requirements of the circuit. During one revolution of a sequence switch each cam

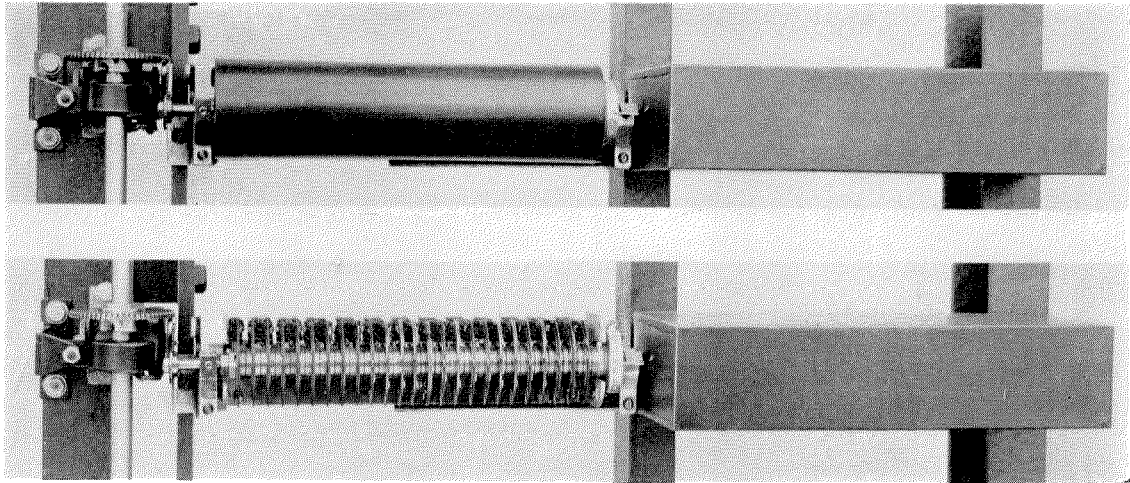

Figure 20—7011 Sequence Switch with Gear Drive

stalled in Antwerp, the flexible gear drive has been applied to the later type of sequence switch. At the same time the vertical mounting distance between centers has been reduced from 3 inches to  $2\frac{1}{2}$  inches. A dust proof cover has been added and the mounting has been modified to permit the sequence switch and associated relays to be wired and tested in the factory as a single unit. The new form of sequence switch is shown in Figure 20. In one view, the dust cover is in place; in the other, the dust cover is removed.

Space does not permit a detailed description of the operation and advantages of the sequence switch. It will suffice to say that it has been and always will continue to be a fundamental part of the "Rotary" and "Panel" systems. It permits circuit combinations which are not practicable with relays. It makes it possible to fulfill certain conditions which cannot be met in any other manner. By means of a position number disc, it allows the progress of a call to be easily followed. It reduces power consump-

tion is rotated through 18 positions, the various cams being notched to give the proper circuit combination in each position.

In this connection the Antwerp Shop has designed and built a very clever automatic fixture for notching. A blank cam is placed in a punch press, after which the operator presses a button, the cam is rotated and the punch descends once every 5 degrees or 72 times during a revolution. Whether or not the descending tool takes effect depends upon the setting of the fixture. At the end of the revolution the machine stops and the cam is replaced by another blank. The controlling fixture is removable so that when a series of cams has been punched, it may be replaced by another control fixture set up in advance. In this way a punch press may be constantly occupied. This is but one example of the high class tool work done in the Antwerp factory by Belgians. The design and the manufacture of the tools which punch the flexible discs in one operation without burr or distortion is another illustration of this high class design and workmanship.

Junction Diagram

A junction diagram is one of the best ways to show how the finders, selectors and register or sender circuits are placed and interconnected in an exchange. A typical diagram recently completed

switching capacity is arrived at as follows: The capacity of the arc of a final selector, as previously stated, and consequently of a final unit, is 200 lines. A 4th selector serves 10 groups of final selectors, so that the switching capacity

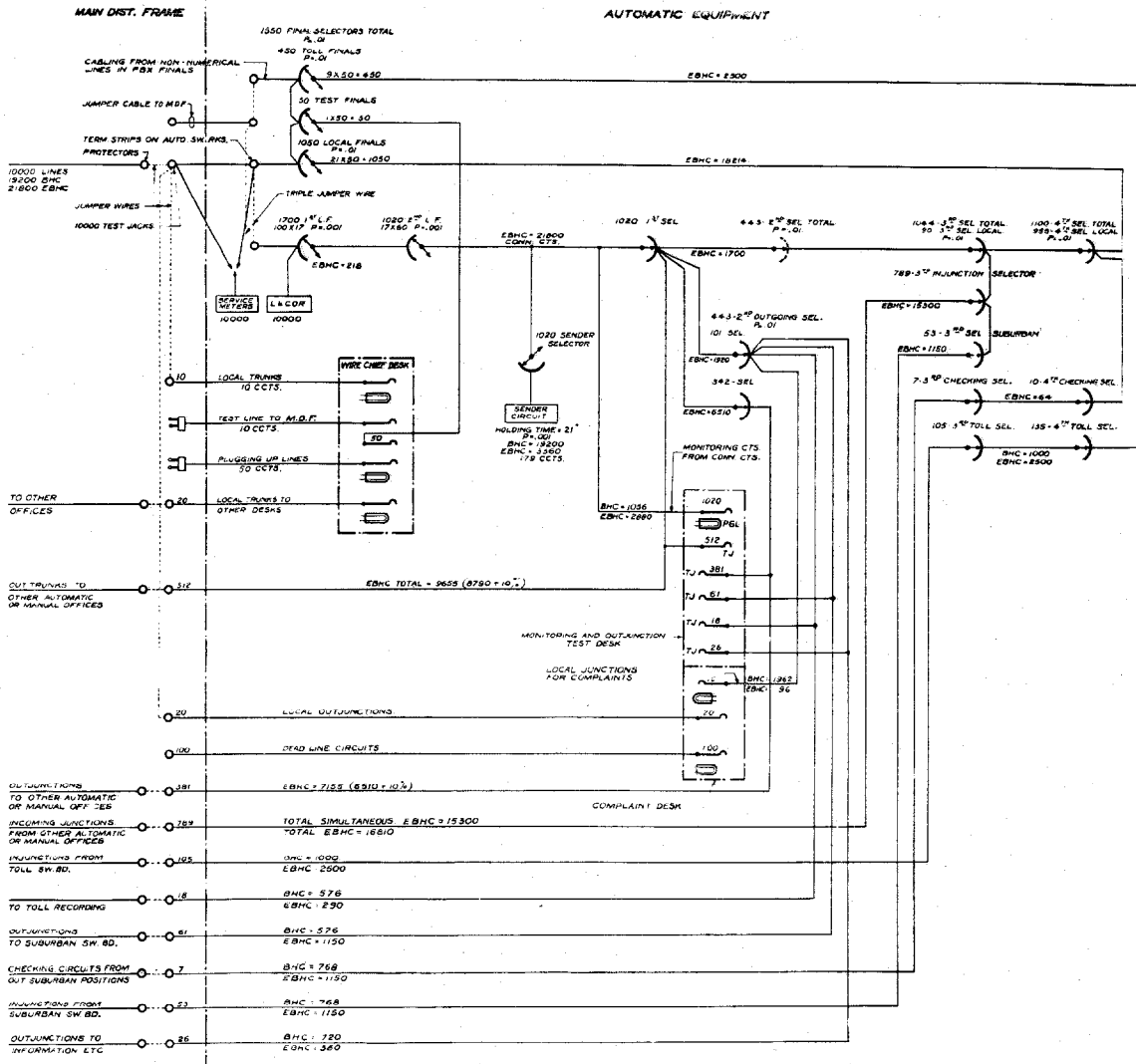

Figure 21—Junction Diagram—Typical 10,000 Line Office

for a study of a 10,000 line office in a large network is shown in Figure 21. The extent, character and distribution of the "in" and "out" traffic is shown as well as the amount of equipment required to handle the traffic on the bases indicated. This office has an ultimate switching capacity of 2,000,000 lines in 6 selections, requiring 1st, 2nd, 3rd, 4th and final selectors. The

at the 4th selector is 2,000 lines. A 3rd selector serves 10 groups of 4th selectors, so that the switching capacity at this point is 20,000 lines. A 2nd selector serves 10 groups of 3rd selectors and consequently the switching capacity here is 200,000 lines.

Finally, the 10 levels of the 1st group selectors serve 10 groups of 2nd selectors or a total of

2,000,000 lines. The initial switching capacity of the office under consideration is 560,000 lines. Two levels only of the 1st group are connected to 2nd group selectors which in this case are used for outgoing junction service alone. The remaining 8 levels of the 1st group switch go direct

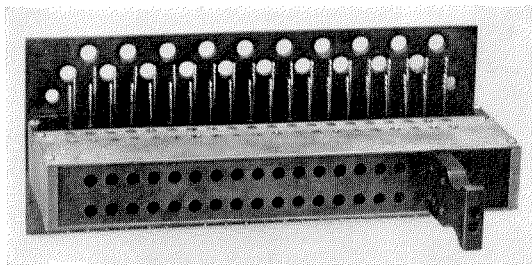

Figure 22—MDF Test Jack—Top or Jumper Side

to local 3rd selectors or to distant offices. Two levels of the 1st group switch will, therefore, each have a switching capacity of 200,000 lines while each of the remaining 8 levels will have a switching capacity of 20,000 lines each. When circumstances require it, additional groups of 2nd selectors may be added from time to time and in a distant office if desirable. Such additions merely require slight modifications in the sender circuit and do not involve any change whatsoever in the subscriber's numbers or exchange prefixes.

The incoming underground cables terminate on protectors on the line side of the main distributing frame. From this point they are cross connected to test jacks on the switchboard side of the frame. Test jacks are used where manual switching sections do not exist. Experience in Europe and elsewhere has led the Bell Telephone Manufacturing Company engineers to believe that in any automatic exchange there should be some means whereby a large number of lines may be plugged out and tested with ease, especially during periods of abnormal trouble in the outside plant. It has often been argued that test jacks are unreliable, but this is an argument which may be applied to any piece of apparatus of faulty design. The question of reliability is largely one of good design. The test jack manufactured in Antwerp, photographs of which are shown in Figures 22 and 23, has given complete satisfaction. The contact pressure is between 700 and 800 grams. The chances for trouble

are remote, as No. 1 contact metal is employed throughout for the contacts, which are extremely robust, shielded from dust and are ordinarily inaccessible except to the test plug. This test jack occupies exactly the same space and mounts in exactly the same manner as the standard Antwerp main distributing frame terminal block so that either test jack or terminal block may be mounted at will. Where manual toll switching sections are employed, as is often the case, the test jacks may be dispensed with if desired. The test jack is not combined with the protector for two reasons; first, because when separated each may have a more robust construction and, second, because the test jacks are mounted in numerical order. When testing is done from the protectors on the line side, reference to the cable records is always necessary.

In the latest No. 7-A machine switching system installations, the usual form of separate intermediate distributing frame and line relay rack have been omitted, and the newest exchange of this system now being installed in the city of

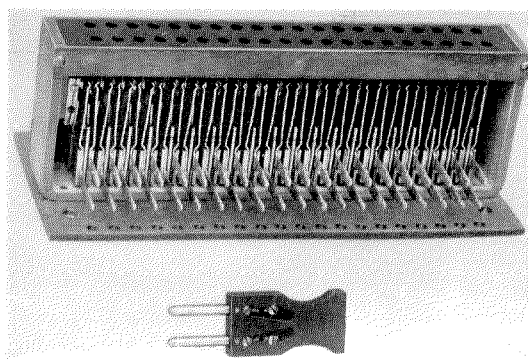

Figure 23—MDF Test Jack—Bottom or Cable Side

Antwerp has been laid out along lines differing somewhat from former accepted practices. In this exchange the main distributing frame is located advantageously on the floor directly above and at right angles to the automatic final and line finder switchracks. These racks and their associated cable runs, are shown, in progress of installation, in the three photographs, Figures 24, 25 and 26.

A hole is cut in the ceiling above each switch-rack. The 20-pair cables from the distributing frame drop through these holes into the switch-rack as shown in the photograph of the under-

side of the roof of a switchrack, Figure 26. The cables are supported on the roof of the switchrack between rows of pins, Figure 25, and to reach the terminal strips, they pass under the roof as shown in Figure 26. In Figure 27 may

The line finder bay, Figure 18, is an entirely self-contained unit. At the bottom are mounted the requisite number of line finders to handle the specified traffic. The particular bay shown in Figure 18 is equipped with 9 line finders, as the

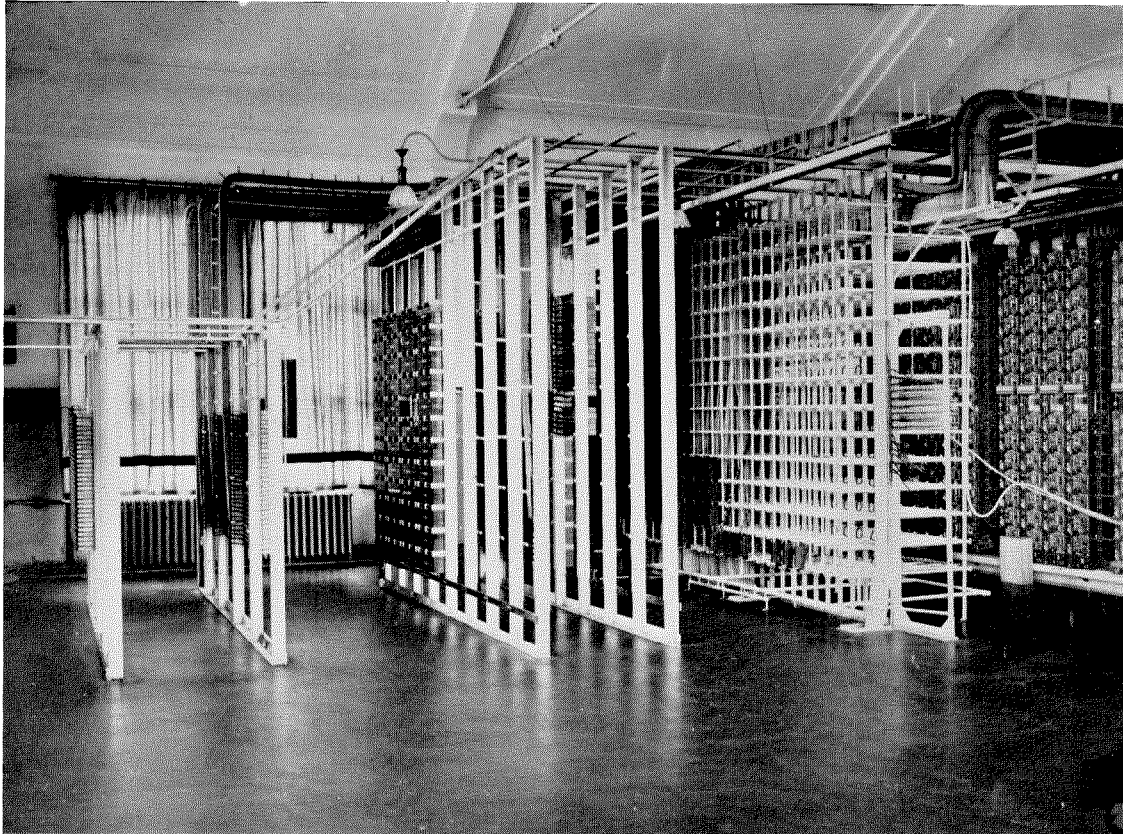

Figure 24—Service Meter Rack, Line Relay Rack, and Intermediate Distributing Frame

be seen the platforms which give access to the terminal strips on top. Cross connections are run through the jumper rings. Any finder terminal may be cross connected to any final terminal but the great majority of the cross connections will be between adjacent terminals. This arrangement reduces the amount of line cabling materially and, incidentally, installation labour and floor space as well. In this exchange, therefore, the switchboard side of the main distributing frame is cabled directly to the final terminal on the roof of the automatic switchracks. These terminal strips are permanently wired to the arcs of the final selectors and jumpered to the adjacent finder terminal strips which form part of the 1st line finder bay.

traffic to be handled in this case is not heavy. This standard bay has capacity for a maximum of 14 finders, which is sufficient to handle a total of 170 equated (two min. holding time) busy hour calls, with a delay of one in a 1000. Other bays have a greater capacity. Immediately above the finders is mounted a test key board, by means of which each switch may be individually tested at any time. Busy lamps are provided and by the closure of a common circuit may be caused to burn. In this way the number of circuits occupied in any bay may be determined at a glance. Above the test key board are mounted the first line finder circuit relays and, above these, the line and cut-off relays and test resistances for 100 subscriber lines. The com-

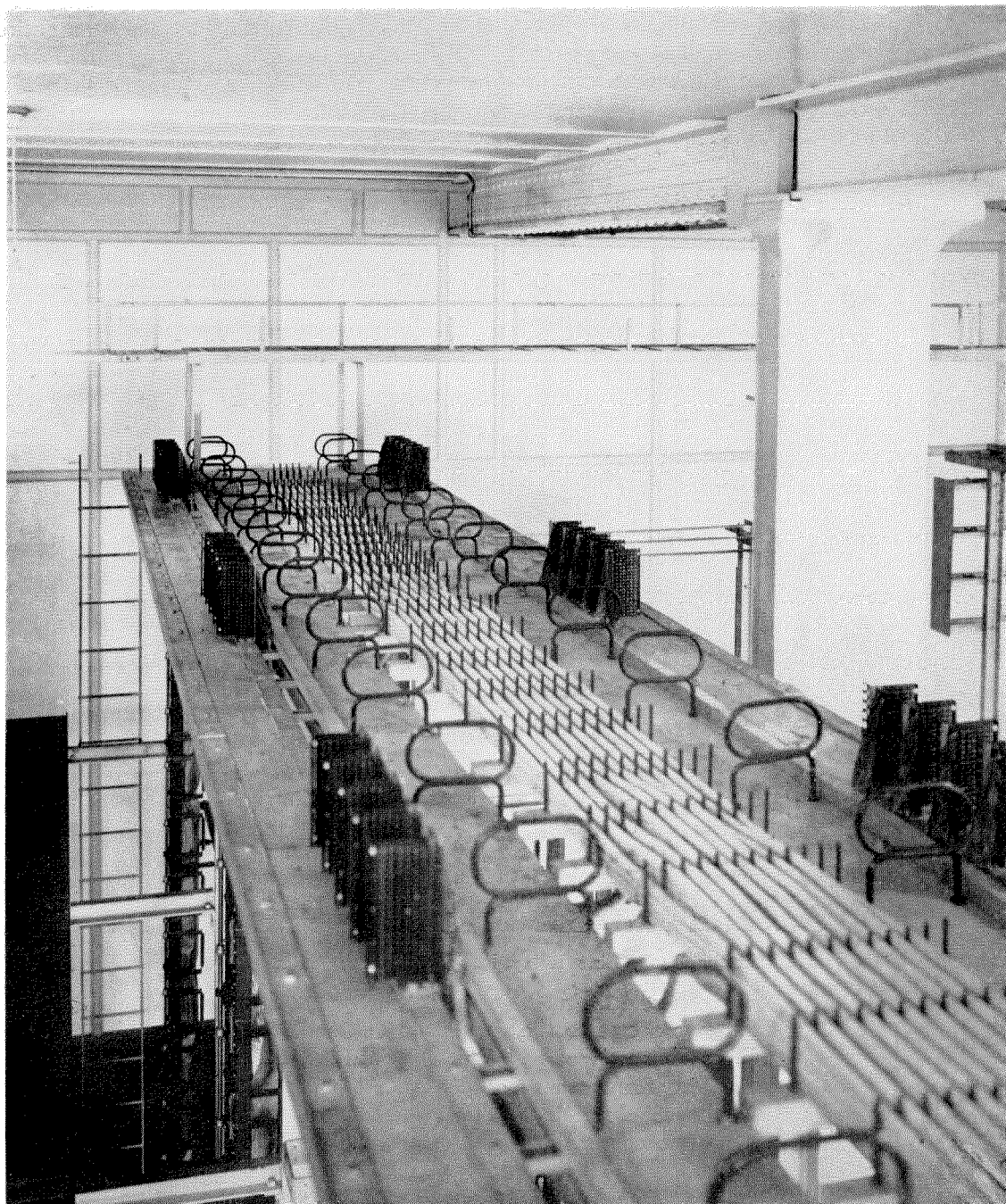

Figure 25—Top View of Finder and Final Switchrack—Antwerp Exchange

pletely assembled bay is wired to two 50 line terminal strips at the top. The whole bay is then tested in the factory before shipment. Test circuits are used whereby the operation and adjustment of all apparatus is checked and opens, crosses and short circuits, etc., located, all auto-

matically. Each switch is tested against each line. As most of the troubles are usually located when the first switch is tested, the remainder of the switches run through the automatic tests very rapidly. The bay is shipped from the factory, carefully packed and, when it arrives on the job,

it is set in position on the switchrack and then cross connected to the final terminals.

The first line finders are cabled on the job to the arcs of second finders, which form part of the

connection circuits which comprise in addition, the first group selectors and the sender selectors. Both first and second finders are of the four brush type and have capacity for 100 lines. The

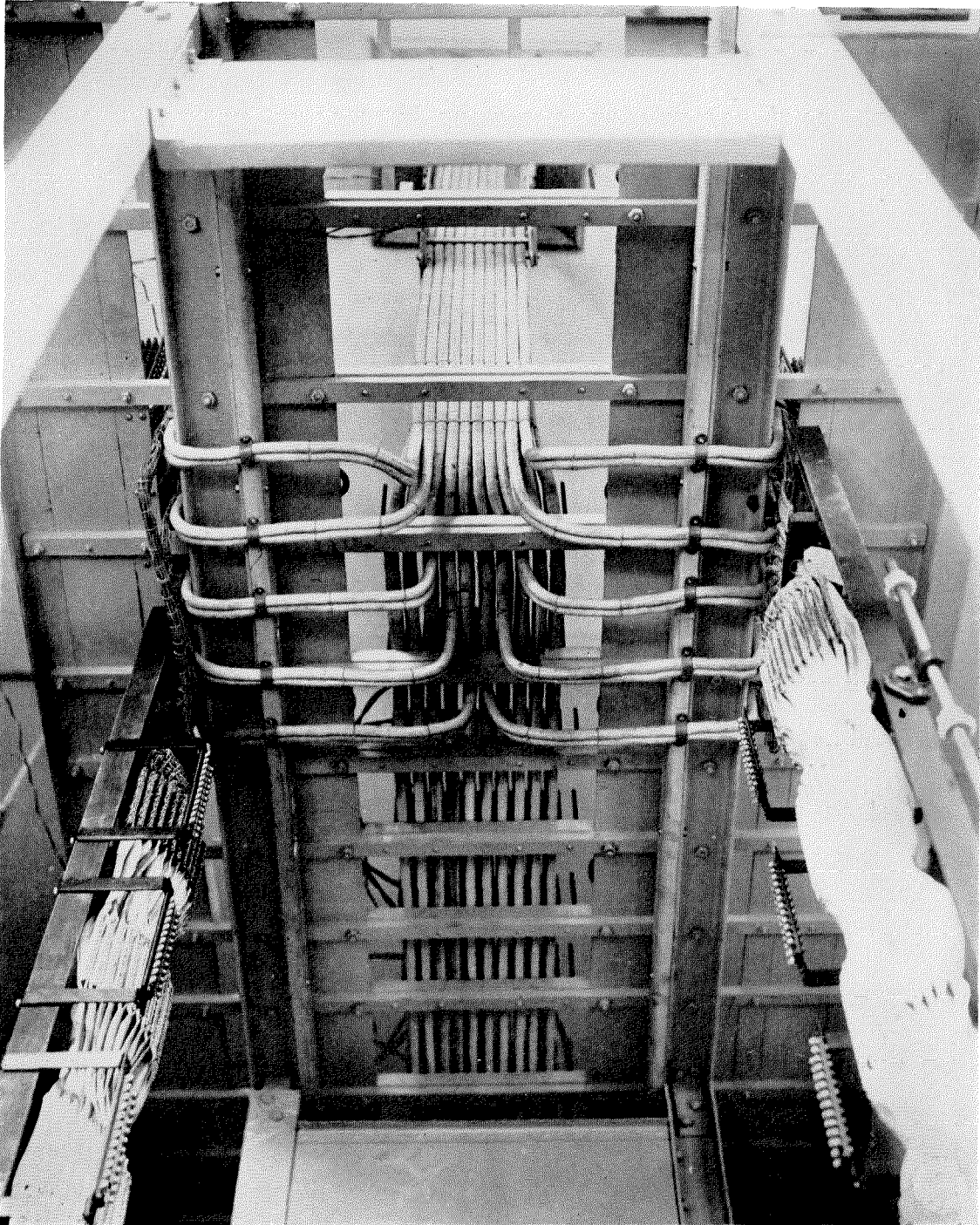

Figure 26—View of Underside of Roof of Finder and Final Switchrack—Antwerp Exchange



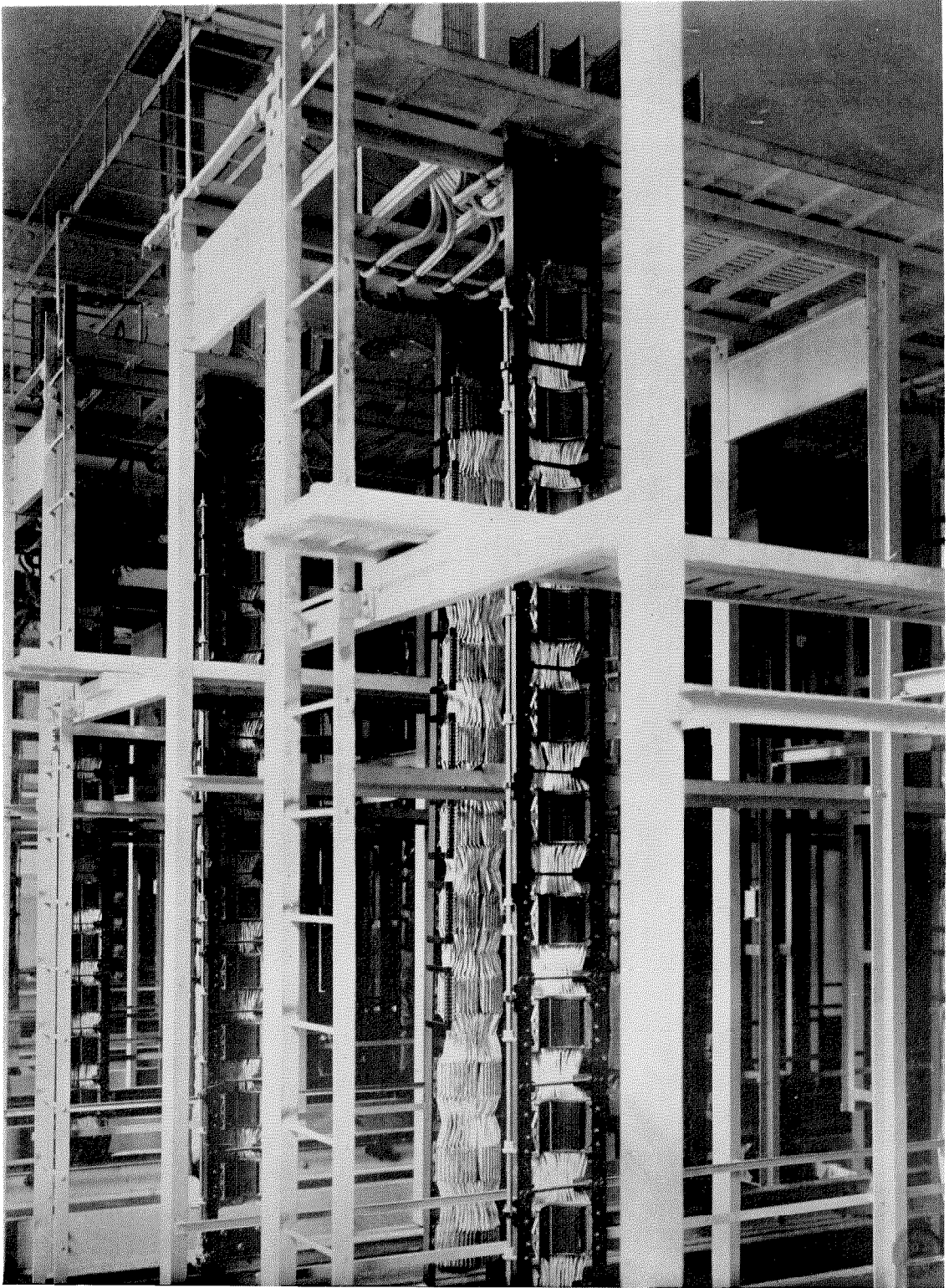

Figure 27—View of Antwerp Exchange Switchracks During Installation

sender selector has seven brushes and capacity for 50 senders so that a very large group of senders is accessible to each connection circuit.

The first selector, except in case of very light traffic, has capacity for 300 junctions, arranged in 10 groups of 30 each. Fifteen selectors of the

in reality a large distributing frame in themselves. Jumper cables and jumper wires may be placed and removed at will. Prior to the placing of terminal strips on the roof similar cross connecting facilities were established at one or both ends of all switchracks. The jumper cables in-

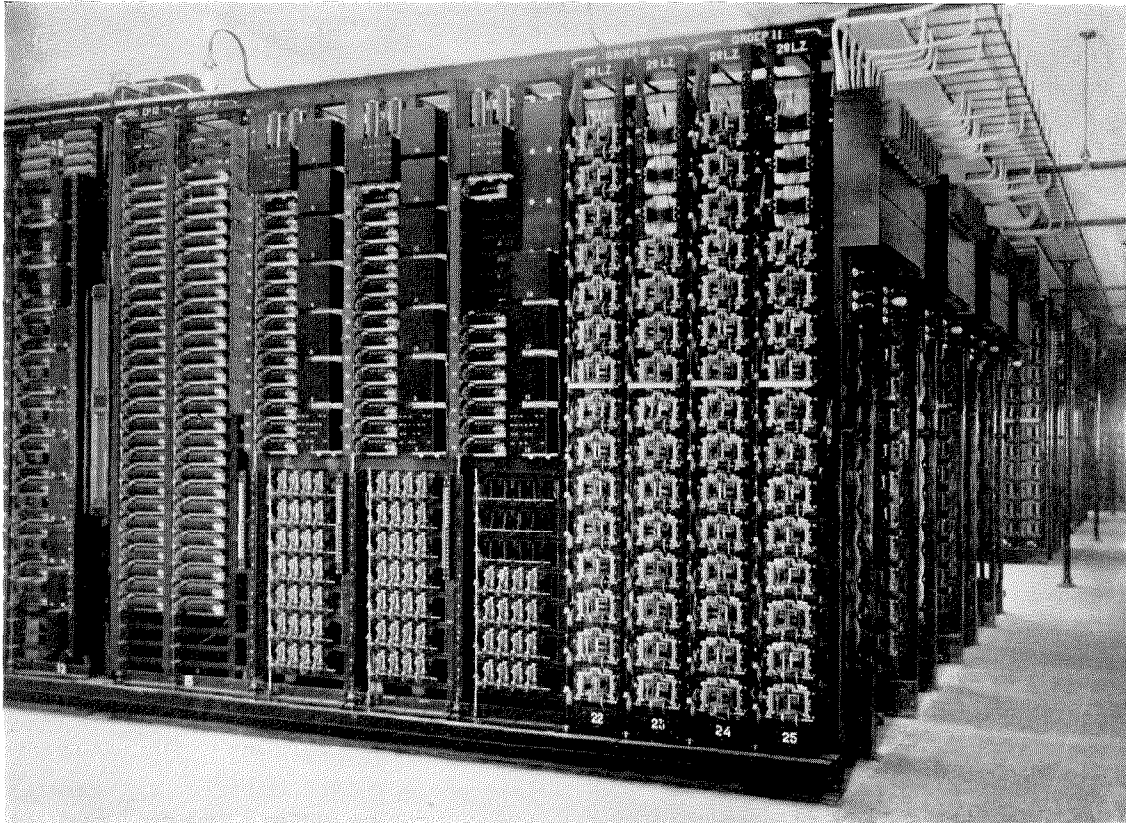

Figure 28—View of Haarlem Exchange Switchracks

new type are mounted in one vertical bay as against 11 of the old type. The bays are wired in groups to a common set of terminals on the roof of the switchrack. The groups are small enough to provide for the maximum number of multiple splits which may reasonably be expected to be required in any level. The jumper rings and pin constructions, previously described afford the means for interconnecting the various groups as traffic conditions require. Certain levels in Figure 21 are cabled to the main distributing frame for direct out junctions, other levels are cabled to out junction 2nd selectors while one level is cabled to local 3rd selectors. The tops of all the switchracks combined form

terconnecting the various groups were run in an iron rack placed directly overhead. Such an arrangement is clearly shown in Figure 28 which is a view of the main office in Haarlem. In this photograph are also shown, beginning at the right, 2nd line finders of the old type, then three bays of full automatic registers, one bay of finder selectors, fuse panels and at the extreme left a sequence switch and relay bay for 1st group selectors or connection circuits.

The out junction 2nd selectors are cabled to the main distributing frame.

The local in junction and suburban 3rd selectors are multiplied together and wired to local 4th selectors and these in turn to the local finals.

All local finals are identical as regards sequence switch and relay equipment. Any final may be used for combined main line and P.B.X. service or restricted to main line service according to whether a strap wire is or is not provided. In the PBX final arc every contact may be used for a main line or PBX junction. It is not necessary to kill a number or terminal to terminate a PBX junction group. In offices where the 3rd sector of the final arc is equipped for PBX junctions, the final may be adapted to function as a main line final over the first 19 terminal blocks or 180 lines. Upon reaching the 20th terminal block,

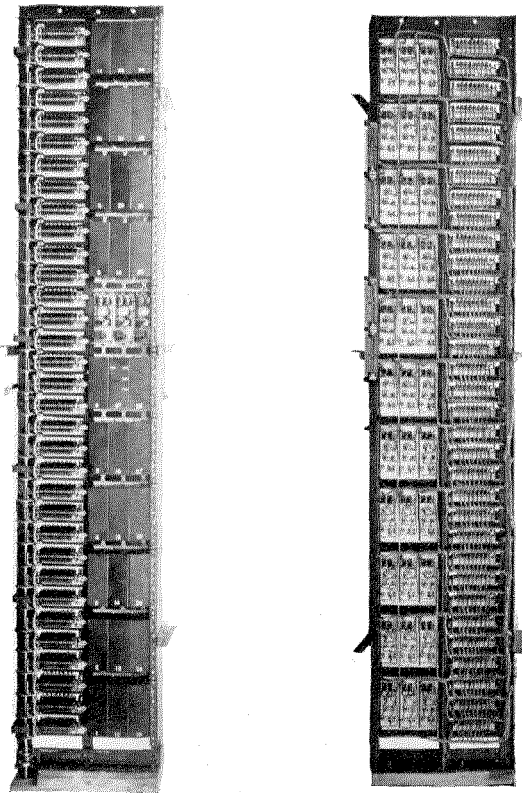

Figure 29—Final Sequence Switch and Relay Bay

the circuit is converted to PBX hunting by the opening of a contact. The switch may then select the 20th or any one of the succeeding 10 terminal blocks. A photograph of a typical final sequence switch and relay bay equipped for 33 final circuits is shown in Figure 29. This bay, like the other bays, leaves the factory fully wired, assembled and tested.

The incoming junction 3rd selectors may be used without modification to terminate junc-

tions from other automatic exchanges, from manual exchanges over semi-B positions and from manual exchanges equipped for direct out trunking from the "A" positions. Such a universal 3rd selector is of great value in manual networks during the transition period when the number of junctions from the manual offices is constantly decreasing while that from automatic offices is constantly increasing. Furthermore, the sequence switch notching is the same for all 3rd selectors. By adding a few relays, local 3rd selectors may be converted to incoming junction 3rd selectors. It is customary to leave space on the relay mounting plates for this purpose.

As toll service is entirely automatic, a separate set of toll 3rd, 4th and final selectors is provided.

A separate set of 3rd and 4th selectors is also provided for checking the numbers of the calling subscribers from the outgoing suburban positions which handle direct no delay and short haul service. The checking 4th group selectors connect with the regular local finals for checking purposes. Separate checking finals are not required.

The desk equipment for a standard No. 7-A machine switching system full automatic office comprises two desks, a wire chief's desk and a monitoring and out junction test desk combined with a complaint desk or positions. Individual information desks are not usually provided, the information service being generally centralized.

The function of the wire chief's desk is well known. It is placed close to the test jack side of the main distributing frame, and is provided with a test final circuit to each group of 200 lines so that the wire chief may make routine tests without going to the distributing frame.

The pulse of the automatic system may be felt to the monitoring and out junction test desk where the character of the service may also be observed as well as the condition of the outside plant.

All out junctions to other offices have a multiple jack and a busy key located in the face of this desk. The desk is equipped with plug-ended circuits by means of which one person may test rapidly and accurately all out junctions to the distant offices without the aid of anyone at the distant office. A junction which functions properly sends back a signal, those junctions which

fail to return the proper signal are held busy from the desk at the outgoing end. After the completion of the morning or other routine test the numbers of the defective junctions are telephoned to the switchman at the proper distant exchange or exchanges.

Each connection circuit is provided with a jack and a permanent glow (PGL) lamp, also located in the face of the desk. In the event of a grounded line, the sender circuit is automatically freed at the expiration of about 30 seconds, after which the connection circuit acts as a plugging up line and the PGL lamp flickers. The monitor may plug in and ascertain whether the fault is really due to a grounded line or to the failure of the calling party to begin or complete dialing. The act of plugging in causes the PGL to burn steadily so that, should the monitor withdraw the answering plug, he will know that the call has been answered. Should the fault fail to clear itself within ten minutes, the PGL will flash, thus notifying the attendant that the false call condition has existed for ten minutes. A switchman is then notified and the defective line plugged out. When the line circuit is opened, the connection circuit automatically restores to normal. The aforementioned signals are given by a simple power driven timing device, one of which is associated with each connection circuit and with each register. The register circuit, in addition to transferring grounded lines, also transfers any incompletely dialled call to the connection circuit after a lapse of 30 seconds from the time when the last digit was dialled. Should the register fail to release, due to a fault in selection, the timing device does not release the register but in place thereof displays an alarm signal. The timed alarm device has a long arm with a white signal at the end working over a graduated scale about ten inches long. The speed is adjusted to meet requirements. The device associated with the sender circuit begins moving when a call arrives and is restored to normal after the dialling of each digit. If a call fails to progress, the pointer moves over the entire scale in approximately 30 seconds and then closes the alarm circuit. By observing the travel of the pointer, accurate records may be taken of the time required for the different register selections. A photograph of the monitoring

and out junction test desk installed in one of the Brussels offices is shown in Figure 30.

In planning automatic offices for manual networks, it has been generally found possible to eliminate from the automatic office all temporary equipment. An examination of the junction diagram, Figure 21, will show that there is nothing in the automatic office which becomes unnecessary when the manual offices disappear. All temporary junction equipment is placed in the manual office, unless traffic considerations or conveniences or both require the placing of it elsewhere. The equipment can be placed in the automatic office, but there is no need for doing so, so far as the automatic equipment is concerned.

All junctions are full metallic and 2-wire except where secret checking is required on outgoing suburban service in which case the junctions from the automatic offices to the suburban office are 3-wire.

#### *Continuous Hunting*

Continuous hunting is one of the characteristic features of the 7-A machine switching system. The term "continuous hunting" is one used to describe the action of the selector, which, in this system, will continue to search for an idle junction or trunk until one is found or until the calling subscriber hangs up his receiver. The selector automatically provides for this by virtue of its unidirectional rotary motion, the second revolution of the switch taking place in exactly the same manner as the first.

This feature is particularly valuable in large networks during the transition period during which the automatic offices must interwork with manual offices. When trunking from one automatic office to another, all circuits are available throughout the 24 hours, but in trunking from an automatic office to a manual office the number of circuits available at the manual end depends on the number of positions occupied, which in turn depends upon the expected traffic. There are times when, for one reason or another, a call indicator junction is not immediately available. With continuous hunting the calls are merely delayed so long as the subscriber is willing to wait. This feature, due to the particular design of the selector switch, is secured

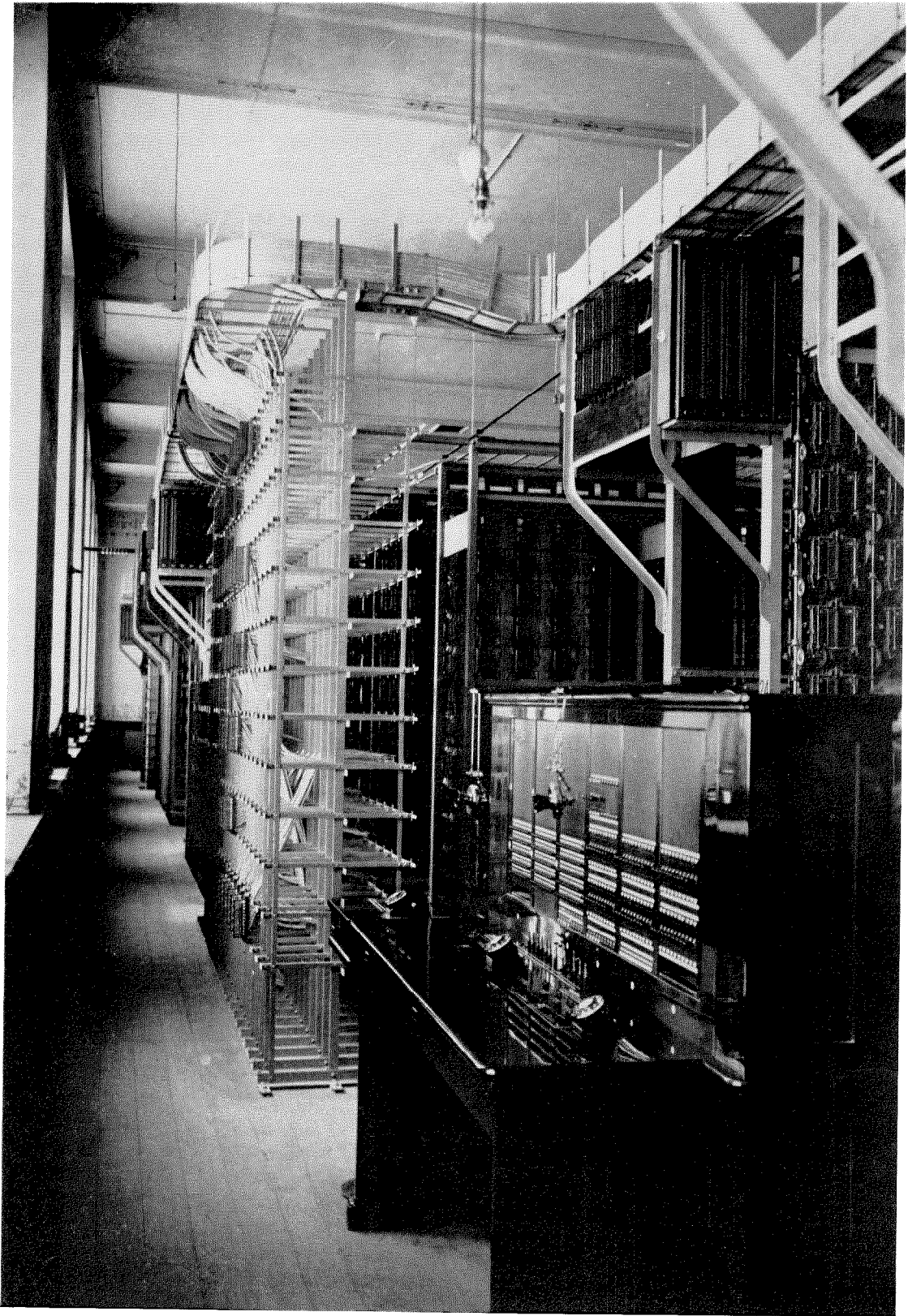

Figure 30—Monitoring and Out Junction Test Desk—Brussels

without additional apparatus or other cost in the selector and register circuits.

### *Translation*

As the final unit in the No. 7-A machine switching system is 200 lines, translation is necessary. For small networks this is done by a fixed and arbitrary pairing of certain digits, such as, for example, by connecting the first 10,000 lines in a 20,000 line exchange to the five odd levels of the first group selectors and the second 10,000 lines to the even levels of the first group selectors. In a simple network or in a single office district the sender circuit employs a series of registers which are used instead of counting relays. The register is identical in design to the early or No. 7001 type sequence switch. It operates at a very high speed and is capable of following the dial and switch impulses accurately. The sender circuits are mounted on iron bays assembled and tested in the factory. A typical bay of this type accommodating seven complete sender circuits is shown in Figure 31. At the bottom are seven sets of four registers each, sufficient for 200,000 line switching capacity. Above to the right are seven sets of relays and to the left seven pairs of controlling "in" and "out" sequence switches in addition to a test sequence switch and its relays. To the left of each set of registers is a test key and some lamps and jacks by means of which each sender circuit may be tested for receiving from both the "in" and "out" sides the maximum and minimum impulses under maximum and minimum speeds.

In large networks, the translation of office prefixes is also provided for as in the panel system, but along different lines. The two No. 7-A machine switching system installations in Copenhagen were the first offices in Europe to be equipped for office prefix translation. In such networks, translation is of vital importance from the standpoint of economy. Without it, traffic must be routed numerically; that is, a call must follow the route definitely assigned it by the digits dialled, regardless of whether the route is an economical one or not. With translation of office prefixes or their equivalent, the routing of calls between offices may be done in the most economical manner. For example, calls to nearby offices may be routed over direct trunks,

and calls to more distant offices may, if desired, be routed through one or more tandem points, merely by proper cross connection of the trans-

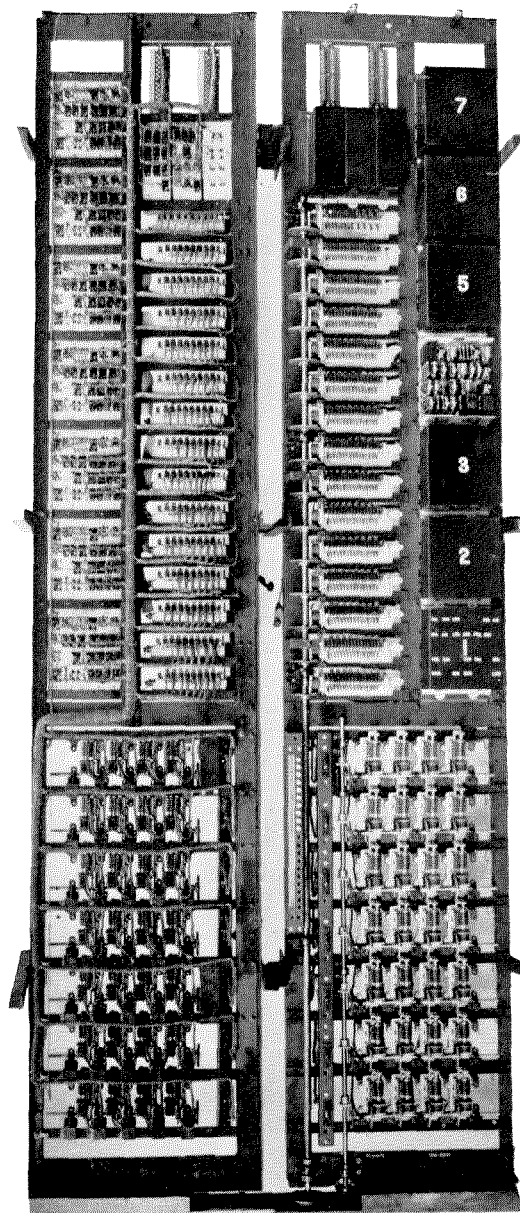

Figure 31—Sender Circuit Bay for Small Networks

lator switch points. The flexibility which the system affords in making such routing changes whenever conditions warrant, without changing the office prefix initially assigned, permits laying out an automatic network based on sound plant and traffic economies, rather than on purely numbering considerations.

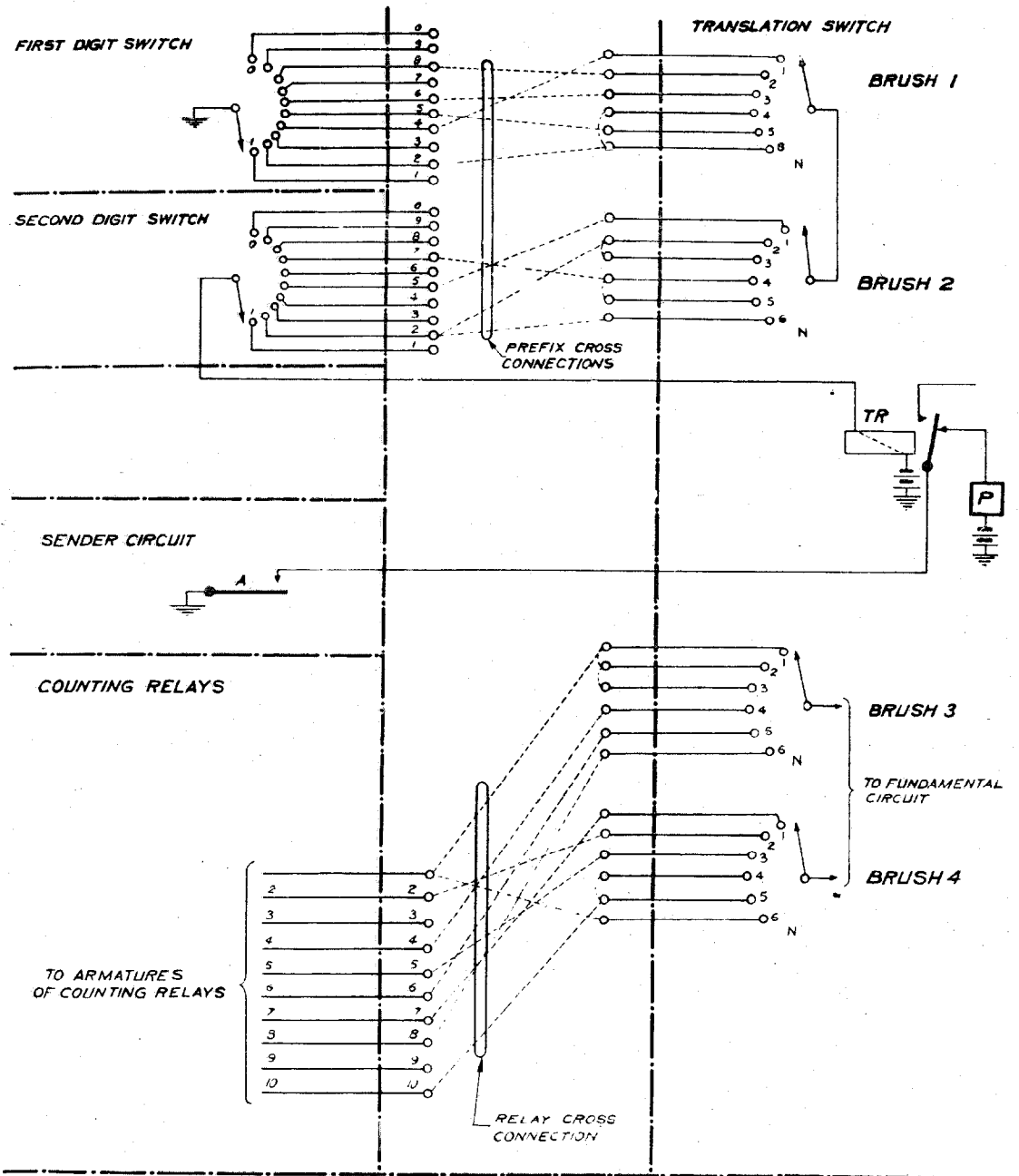

Figure 32—Office Prefix Translation Scheme

LIST OF CROSS CONNECTIONS

Position on Translator Switch	Digits Dialed	Route Selected
1	45	1- 7
2	82	1- 2
3	62	1- 5
4	27	4-10
5	57	6-10
6	22	8- 1

The general utility of the new line finder switch is illustrated by the fact that it is also used as a translator switch, see Figure 32, which illustrates diagrammatically the manner in which 2-digit translation is given. The automatic subscriber dials the first two letters of the office prefix and the two corresponding digit switches advance in accordance with the number of impulses sent in. Assume for example, that the equivalent of 82 has been dialed and that the cross connections are as shown. The first digit

switch will go to position 8 and the second to position 2. The power magnet "P" of the translator switch is energized and, as the switch rotates, brushes 1 and 2 search for a closed circuit. When position 2 is reached, a circuit is established from ground, terminal 8 of the first digit switch, brushes 1 and 2 of the translator switch, to terminal 2 of the second digit switch, and thence in series through a test relay TR to battery. TR operates and the translator switch comes to rest. Brushes 3 and 4 are cross connected to the counting relays; in this particular case brush 3 to the first counting relay and brush 4 to the second, so that while the equivalent of 82 was dialled, the equivalent of 12 will be selected. The translator switch as now used employs four brushes and 50 sets of terminals, which is sufficient for the requirements of an area containing 50 offices. It is not expected that any European network will exceed the requirements of two switches, or a total of 100 offices. The translator switch may have any number of brushes so that ample means are provided for the control of metering, transmission, etc. These additional brushes are not shown in the diagram.

#### *Dialing Tone*

Referring again to junction diagram, Figure 21, when a subscriber removes his telephone from the switchhook, the line relay operates, after which all idle line finders in the group serving the particular block of 100 lines, of which the calling subscriber forms part, hunt for the calling line. The first finder to reach the calling line seizes it and makes it busy to all other finders. The first line finder is similarly selected by a 2nd line finder, after which the associated sender searches for and seizes the first idle register. The calling subscriber now hears the dialing tone, indicating that everything is in order for dialing. Except at infrequent intervals when the exchange is heavily loaded and idle circuits are few, the dialing tone is received on an average in about one second, in other words, almost as soon as the receiver can be placed to the ear.

The No. 7-A machine switching system installed in Darlington, England, in 1914, was the first exchange to make use of the dialing tone. At that time there was some doubt as to its

practicability. Its success, however, is shown by the fact that such a tone is now generally specified for many automatic systems as being an essential guide and a real assistance to the calling subscriber.

#### *Power Plant and Power Drive*

The power plant required for a full automatic office of the No. 7-A machine switching system, while of larger capacity, is of the same general character as that required for a corresponding No. 1 common battery manual office, with, of course, the extra provision of reserve alternators or direct current generators for driving the switch rack motors, in case of failure of the commercial power source. The machines and power board in Main office, Haarlem, Holland, are shown in Figure 33. The whole plant is sufficient for a 12,000 line full automatic office and a 500 line toll board. A single set of twenty-five storage cells of 2600 ampere hours capacity and seven C.E.M.F. cells for regulation comprises the battery equipment. This plant is provided with automatic end cell regulation. The equipment for this purpose is mounted on the power board at the bottom of the second panel from the right.

The normal operating potential for the automatic apparatus is 48 volts. Of late, a demand has arisen for an all 24 volt system for use in tropical countries where electrolysis due to leakage is a serious matter, not only in the central office but also at the subscribers' stations. With the new apparatus, it is now possible to offer an all 24 volt system but this is not recommended for general use where it is not necessary, on account of the heavier currents involved.

The power consumed for power drive purposes is comparatively small. The average 10,000 line full automatic office requires from sixteen to twenty  $\frac{1}{8}$  H. P. motors, running on an average under not more than one-half load at 50% efficiency. The total power input is, therefore, between 2 and  $2\frac{1}{2}$  H. P. per 10,000 lines. Each central office is provided with a reserve battery driven motor generator set, which is automatically started when the city power fails. The generator or alternator, as the case may be, supplies the switchrack motors with power during the breakdown.

The reliability of power drive is now thoroughly established. A serious breakdown has



never occurred and stoppages due to a defective or slow speed motor are very rare. A defective motor may be quickly replaced by a reserve provided for this purpose. Sufficient spare motors are provided so that each motor

clusively. The motors run only when necessary. They do not run during conversation, when no other call is in progress and, in case of a grounded line, they are automatically stopped after the expiration of a certain length of time. Power

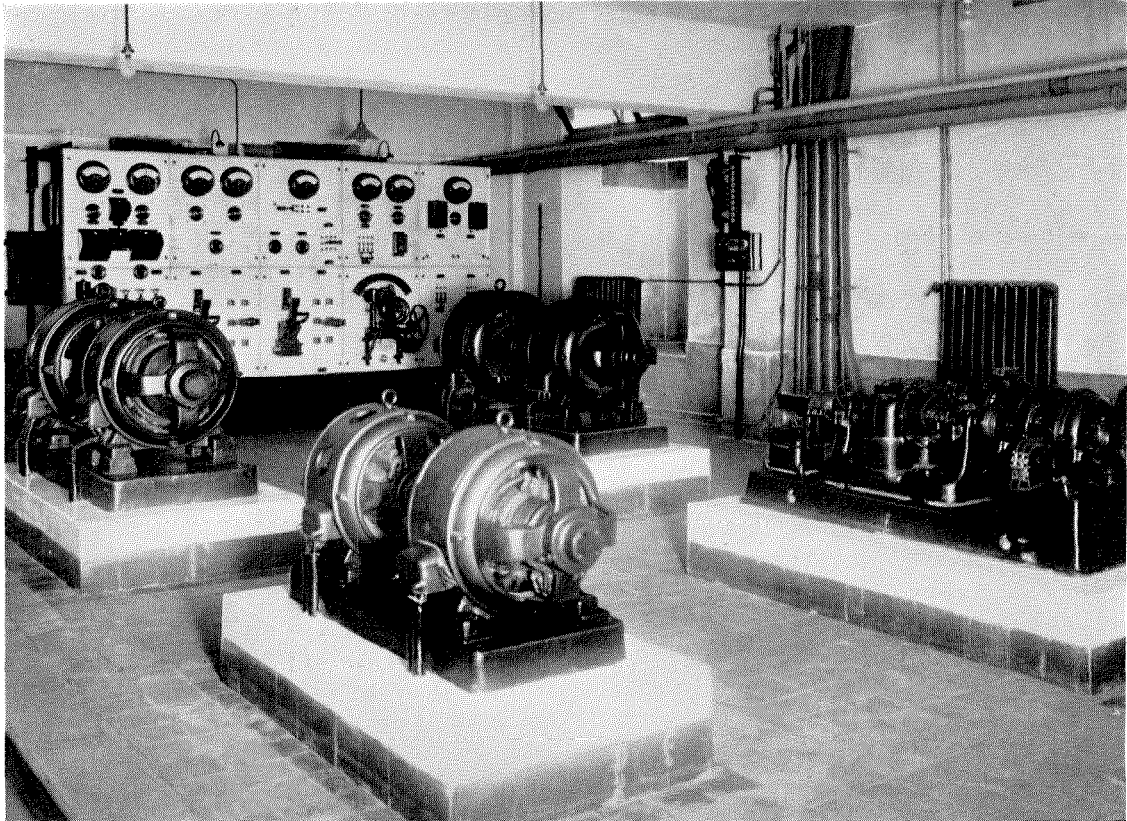

Figure 33—Power Room—Main Office—Haarlem, Holland

may be withdrawn from service once every six months and carefully overhauled. The main shafting is simple, robust and supported on ball bearings; no case of binding has as yet been recorded.

In small central offices, not provided with electric power, it is customary to drive the switchrack motor direct from the storage battery. There are four isolated exchanges in New Zealand which are so driven. When installed, two of the exchanges were equipped for 600 lines, and two for 800 lines. The entire automatic equipment in each exchange was driven by a  $\frac{1}{8}$  H. P. 48 volt D. C. motor.

In satellites and rural systems of 1000 lines or less, battery driven motors are now used ex-

drive has been and is also being applied to PBX installations from 50 lines upwards. In such cases the power of the switch motor is reduced  $\frac{1}{32}$  H. P.

#### *Transmission*

The transmission circuits vary considerably in the different offices which have so far been installed. In some offices the standard No. 25 type repeating coil is used throughout with 24 volts for local connections and 48 volts for toll connections. In other offices local connections are given over high resistance bridge impedance circuits and toll connections over repeating coil circuits, both with 48 volts. One advantage of this second method is that it permits the use of a

single potential power plant. Another advantage is that current consumption on the great majority of connections, which are local, is reduced to a minimum. The high frequency loss with the 48 volt bridged impedance circuits employed is small due to the high impedance of the coils, which are carefully balanced and tested for short circuited turns. To meet the demand of certain customers now using high resistance and very low current transmitters, 24 volt high resistance bridged impedance circuits have also been supplied.

#### *City Service*

The No. 7-A machine switching system is equally suitable for either full or semi-automatic service. As previously stated, the demand for semi-automatic service seems to have disappeared, except for special purposes. The system as now in operation provides for measured service, 2 or 4-party line service, secret or reverting, as may be required, substation meters and coin boxes of different kinds. The system is particularly safe as regards measured service. The service meter cannot be operated by any accidental short-circuiting or crossing at a terminal or other exposed contact. To operate the service meter, a potential double that of the normal voltage of the storage battery must be applied. The duration of the metering circuit is about one-half second. The closure of this circuit can only take place on successful calls unless the circuits are wired to meter all calls, unsuccessful as well as successful. In some cases, incoming calls are metered as well as outgoing calls.

The system is not only capable of serving manually attended PBX's in the ordinary way but is also capable of serving automatic PBX's equipped for automatic "out" calling.

The means previously described for handling grounded lines, false calls, incomplete dialing, etc., facilitate automatic service from the subscribers' point of view and, at the same time, afford all that is necessary for the complete and proper supervision of the inside and outside plants. The system facilitates the maintenance of dials for the reason that any normal line with the dial speed varying between 9 and 14 steps per second is within the limits of the central office apparatus.

#### *Call Indicator Trunking*

When an automatic office is introduced into a manual network, it is customary to handle the service outgoing from the automatic office to the manual office on a call indicator basis. Call indicator positions were put into service in Zurich in 1917 and since then similar positions have been installed in the Hague, Christiania, Hull, Brussels, Naples and Antwerp. A photograph of a position at Brussels is shown in Figure 34. The advantages of call indicator trunking are well known. A subscriber to a full automatic exchange is enabled at the outset to dial the full number of the wanted party in the ordinary manner. He is not required to distinguish between a call to a full automatic exchange and one to a manual exchange.

As call indicator junctions are more costly than ringdown junctions, it sometimes happens that the former cannot be proved in either on account of the short time the manual office is expected to remain in service, or on account of the condition of the manual office. Magneto operation of the manual office, however, does not prevent call indicator working. The manual offices in Zurich and Christiania are magneto and are giving very successful call indicator service.

Each call indicator position is equipped with the requisite number of junctions. In addition, each position is provided with three registers and one number indicator. When a junction is seized at the automatic office, the manual end of it selects a free register, which is then set under the control of the register at the automatic office, after which the number is displayed upon the indicator placed before the operator. As soon as a position has three calls; that is, one attended call with the number displayed on the indicator and two waiting calls, it is made busy to all other calls and, by reason of continuous hunting, the call at the automatic end is either stored or directed to some other position having less than three calls. Some of the manual offices mentioned have a very large number of call indicator positions so that the automatic distribution, which continuous hunting affords, is of a very real value from a traffic and service point of view.

### Trunking from "A" Positions

Service outgoing from manual to automatic is at the present moment very largely handled over semi-B positions, Figure 35, as indicated diagrammatically in Figure 36. The "A" operator passes the number of the wanted subscriber to

of the new 100 point finder. Referring to Figure 37, each "A" position receives a few junction jacks for outgoing service to each distant automatic office. These jacks are connected to the jack finder arcs, such finders form part of link circuits which comprise in addition to the jack

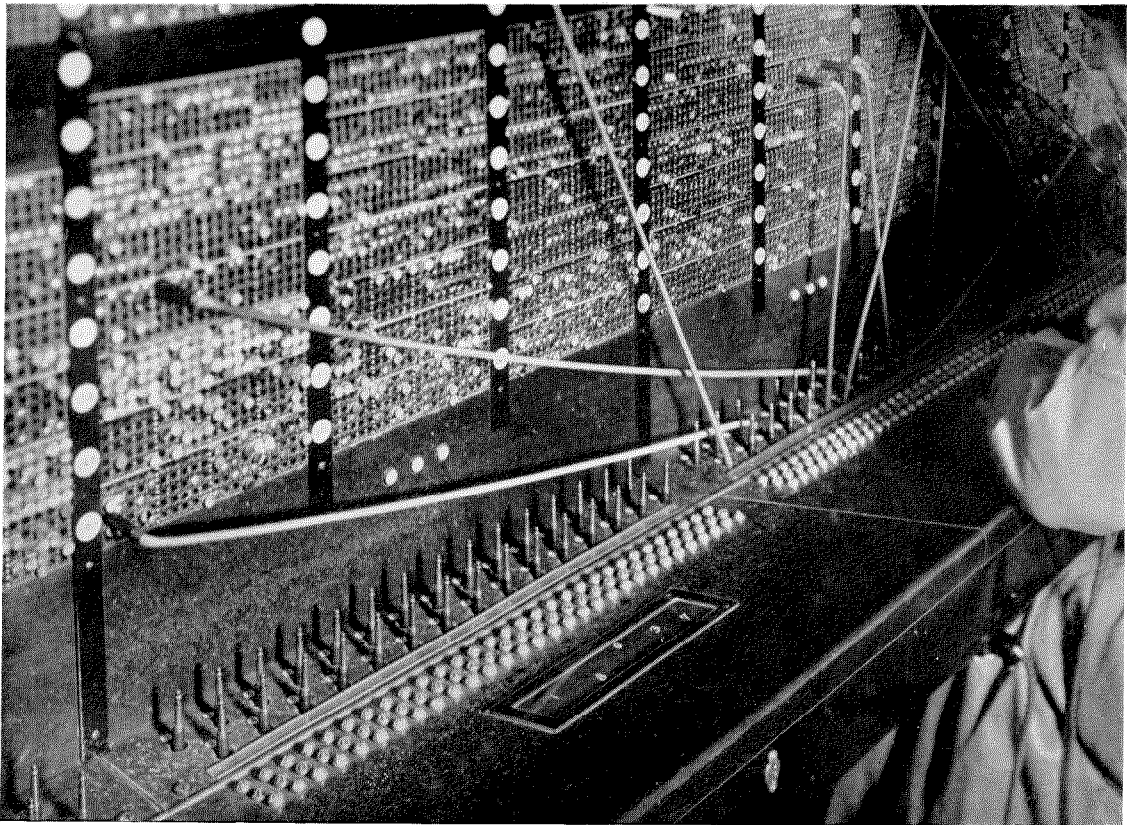

Figure 34—Call Indicator Position—Brussels

the semi-B operator whereupon the latter assigns a junction and sets up the called number on her keyset.

In Europe, order wire trunking has never been very popular and there has existed for some time a real demand for a more direct and accurate method of handling this traffic. Such equipment has been developed and the first installation of this character in Europe will be placed in service early in 1925. The system provides for direct trunking from "A" positions without a full junction multiple, the omission of the latter being made economically feasible by reason of the comparatively low cost and large capacity

finders, sender finders and junction finders. The sender circuits are common to all "A" positions and may be used with any junction to all automatic exchanges. Large junction groups are available. The method of operation is about as follows:

1. Subscriber gives "A" operator the number of wanted automatic subscriber, for example, Main 1472.
2. "A" operator inserts a calling plug into an idle Main office junction jack, located directly in front of her.
3. Pilot lamp I.G. burns, usually in less than



Figure 35—Semi-B Positions—Brussels

one second indicating to the operator that her keyset is connected to a register.

4. "A" operator repeats number of wanted subscriber and, if not challenged, depresses the

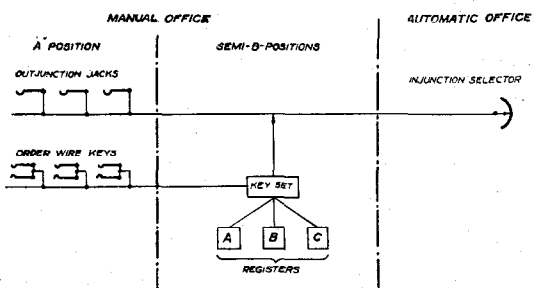

Figure 36—Order Wire Trunking

number on her keyset one digit at a time, each time forcing the proper button all the way down. The four digits may be depressed in succession as fast as the operator can work.

5. The call proceeds automatically without further aid from the operator. The junction is selected when the last digit is depressed. The

called line supervisory lamp of the "A" cord circuit burns until the called party answers.

6. The "A" operator supervises the call and meters it if necessary, just as though the call had been completed in a subscriber's multiple.

7. At the end of conversation, the subscribers hang up and give a double disconnect signal to the operator who removes plug and so releases the connection.

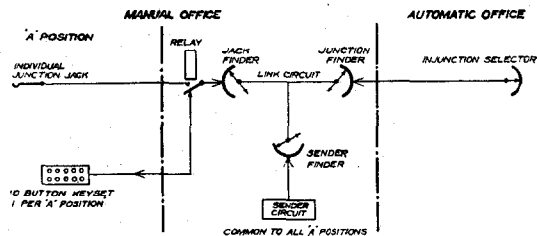

Figure 37—Direct Trunking

8. Should the called line be busy, the calling subscriber receives a tone and the operator a busy flash.

The advantages of direct trunking may be briefly stated as follows:

1. No "B" operators.
2. Fewer "A" operators and "A" positions due to:

Elimination of order wire key and associated delay.

Individual junction jacks, reducing time of selection.

No busy or check testing of jack.

Very short reach.

No repetition and checking with another operator.

Very simple operation.

Operator can plug into junction jack as soon as prefix is heard.

Full number can be written down immediately after checking number with subscriber.

After depression of keys the call proceeds automatically without further attention from the operator.

3. No possibility of double connections due to elimination of multiple jacks.

4. Fewer wrong numbers and false "busies" due to elimination of second operator and order wires.

5. No divided responsibility. Operating errors when made rest solely with "A" operator.

6. No changes required in existing "A" cord or telephone circuits.

7. Finder equipment suitable for ultimate use in an automatic office.

It should not of course be taken from the foregoing that direct trunking from "A" positions, apparently ideal from an operating point of view, can be assumed as the proper course in every case, without due study and careful consideration of each individual case. There are many networks where the short life remaining to some of the manual equipments, lack of floor space for finder, senders, etc., and other factors, will make the use of semi-B trunking to automatic offices the proper and economical course.

#### *Long Distance Service*

The requirements for toll or long distance service in the various countries and offices in Eu-

rope and elsewhere differ considerably. In certain places toll service is handled over manual toll switching sections. In other places, toll connections are established by semi-switching operators on an order wire basis. In still other places, toll service is established automatically by the toll operator. Some Telephone Administrations require means for listening in on a local connection and for forcibly breaking it down, when necessary, to establish a toll connection. Other Telephone Administrations do not break down local connections but demand toll or trunk offering facilities whereby the toll operator may listen in on a local connection but may not break it down.

All of the above mentioned requirements and many others have been successfully met by the No. 7-A machine switching system.

The first cost of a manual toll switching section is often less than the cost of corresponding full automatic equipment. Unless, however, the building quarters lend themselves to operators, or the traffic is very heavy, the annual cost of a toll switching section is often the greater.

From the standpoint of service and operation, direct automatic calling from the toll board has many advantages. It places the connection entirely under the control of the toll operator and during hours of light traffic, particularly on calls to the smaller offices, the delay otherwise encountered due to inefficient operating at the toll switching sections is avoided.

Two methods of reaching the automatic toll train from the toll board are used. The first is by means of junctions multiplied before each operator and terminating at the automatic office in incoming junction selectors. Dials on each position are associated with the toll cord by means of a dialing key or some similar arrangement. The second method is to equip each toll position with 10 button keysets after the manner previously described for "A" positions. This method, while usually somewhat more expensive as to first cost, has the advantage of not requiring any changes in the cord or telephone circuit and of affording somewhat speedier service than the dial method. The method used in each case is, of course, determined by a careful study of all the factors involved. The method of operation, using the 10 button keyset and associated equipment is as follows:

*Call to Main Line*

1. Toll operator selects an idle junction jack of the proper group and plugs into it, whereupon the key pilot lamp burns to indicate that a register is connected. The number is now depressed on the keyset as previously described for an "A" position.

2. During selection, a "progress tone" is applied to the junction towards the toll operator.

3. When the final switch advances to the wanted line, the "progress tone" disappears.

4. If the line is free, the toll final does not make it busy. The called subscriber may continue to make and receive calls.

5. If the line is "local busy" the toll operator receives a busy flash.

6. If the line is "toll busy" the toll operator receives the same busy flash and a "toll busy" tone is applied to the junction.

7. When the toll operator desires to take the called line for a connection she throws the listening key. She will then be made aware of one of the four following conditions:

- a. "Progress tone," indicating that selection is incomplete.
- b. Silence, if the line is free.
- c. Conversation, if the line is busy on a local connection.
- d. Busy tone, if the line is busy on a toll connection.

8. In the case of condition "d," the toll operator may not interfere with the established toll connection. She must, therefore, remove the plug and wait for another chance to complete the connection.

9. In case no tone or conversation is heard, the operation rings, thereby making the wanted line "toll busy," after which the bell of the wanted party rings as long as the toll operator has the ringing key thrown. The toll operator may re-ring at any time when the called line is open.

10. When the line is found "local busy," the toll operator can converse with the wanted party and offer him the toll connection.

11. When necessary, the toll operator may break down the local connection by ringing. In case the wanted subscriber has not hung up, ringing current does not pass to the line. The wanted party cannot be rung in the ear.

12. Supervision may be adapted to meet the requirements of the toll cord circuit.

*Call to PBX Junction Group*

1. The method of operation for a call to a PBX is the same as for a main line so far as free lines and "local busy" lines are concerned. The toll final hunts for a free line and comes to rest when one is found.

2. Should all lines be "local busy" the toll final comes to rest on the last junction.

3. Should all lines be busy, and the last one only "toll busy" the toll final comes to rest on the last but one junction so as not to place a waiting toll call on a PBX junction that is already "toll busy." When the last 2 lines are "toll busy," the toll final comes to rest on the preceding line, etc.

4. From the preceding paragraph, it will be noticed that the busy stop is advanced to a point beyond which there are no free or "local busy" lines. This feature is a very important one and without it automatic toll switching to PBX finals with full breakdown facilities is seriously handicapped, if not made impossible.

*Toll Recording*

The equipment for toll recording calls for no special comment except in the case of large offices requiring a considerable number of recording operators.

It is now customary in such places to provide automatic distributing facilities. The recording operators are placed at a double sided table with a belt carrier to the distributing system running down the center and available to operators on both sides. The position equipment consists of a telephone set and three or four master keys. It is so simple that a large number of positions, in excess of those ordinarily required, may be economically provided to care for rushes. A typical installation of moderate size is shown diagrammatically in Figure 38. The junctions from the automatic switchboard or manual switchboard, as the case may be, terminate on line finders. When a call arrives, it automatically selects the first free recording position. The recording operator hears a buzz to notify her of the arrival of the call. The information is obtained and written down on a ticket in the usual

way. The subscriber then hangs up and is immediately released. The position, however, remains busy until the operator finishes the ticket and places it upon the belt carrier, after which she depresses the master release key. The position is then immediately freed and another call is received if one is waiting. If the sub-

handling time, a red lamp burns. This latter lamp is multiplied on the chief operator's desk. The progress lamps appear on pedestals above the operators' positions and are, therefore, in full view of the controlling supervisors. A recording position is automatically made busy when the telephone plug is removed from the

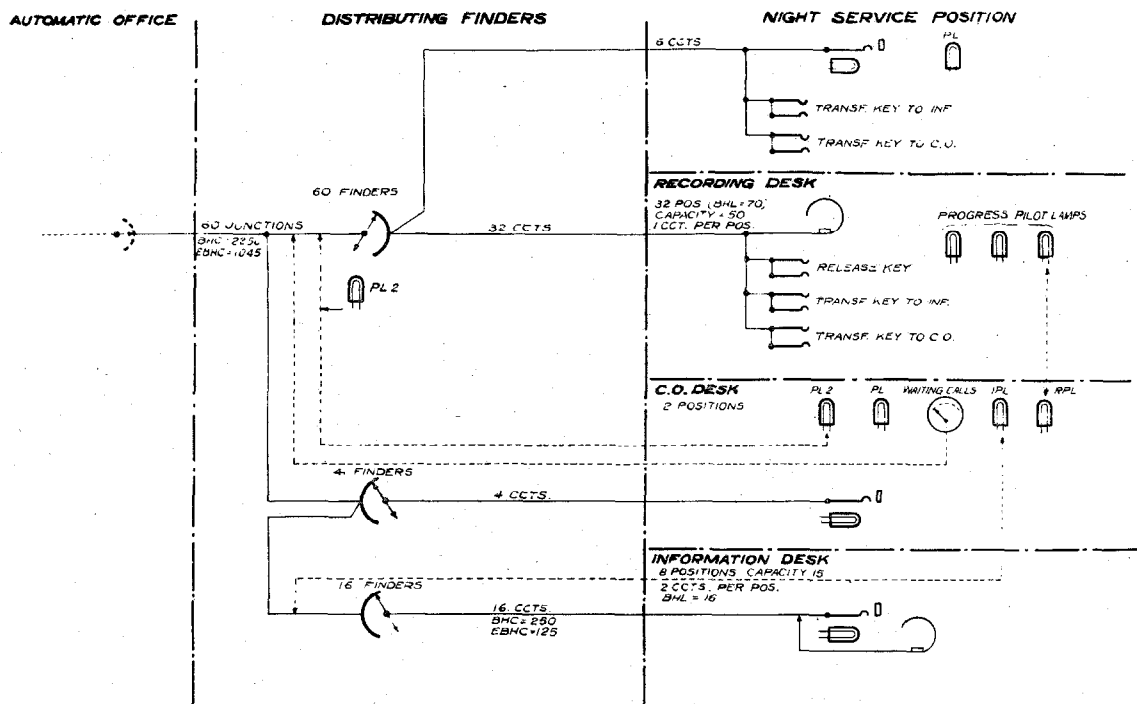

Figure 38—Diagram of Recording Junctions

scriber desires the toll information operator, or the chief operator, the call is automatically transferred by the depression of the proper master key. In no case does the recording operator have to establish a connection manually. The recording operator may free herself at any moment by depressing the release key. If the calling subscriber does not hang up, he is held on the trunk but a guard lamp is displayed so that the abnormal condition may not be overlooked or forgotten.

As the recording operators may control their load, three progress lamps are provided. The first, a white lamp, commences to burn upon the arrival of a call. At the end of 40 to 50 seconds, depending upon the average time deemed sufficient for writing out a ticket, a green lamp burns. At the end of double the estimated

jack. When all positions are vacated the service is automatically directed to the night positions on the toll board.

No position receives more than one call at a time, for the reason that any waiting call may go instantly to the first free position. As a junction finder may select any position in a maximum period of one second, there is practically no lost time between the depression of a master key and the receipt of a waiting call. In order that the chief operator may be kept posted as to the waiting calls, a milli-ammeter, specially calibrated, is mounted on her desk. This instrument indicates the number of waiting calls, thus affording the operator a very accurate indication as to whether or not the occupied positions are sufficient.

### *Suburban Service*

The development of rapid 2-number suburban business in Europe is still in a state of flux. In some cities separate suburban switchboards have been or are being installed, but in other cities suburban service is still combined with long distance service on the same switchboard. Numerous studies and investigations have been made to determine the best manner in which this sort of service may be given in connection with the No. 7-A machine switching system, including consideration of a method whereby the calling subscriber's meter operates at more or less frequent intervals, depending upon the length of the suburban junction. Such multiple metering while possible from an equipment and apparatus point of view, is open to many objections from an operating point of view, the most important one being that the public may insist on a record of such calls when the time comes for payment. Furthermore, the suburban area must form a part of and interwork with the city area, with the result that both areas are complicated and the cost is thereby increased. The question of numbering is also an important one since the suburban area must reduce the switching capacity of a given equipment for city service. In view of these restrictions the following plan has been developed and will shortly be applied to certain areas in Europe.

Separate "in" and "out" suburban positions are provided. The "in" positions may be omitted when the distant suburban exchanges are equipped to dial direct into the city area.

A city subscriber wishing a suburban connection dials a predetermined number and automatically obtains an idle suburban operator. Dis-

tribution to suburban positions follows the lines previously described for distribution to recording positions, but in this case the call terminates on a plug. The "out" suburban operator writes out a ticket recording the calling and wanted numbers, she then proceeds to obtain the wanted number without further delay. When the wanted number is obtained conversation proceeds. At the end of conversation the calling subscriber hangs up and the "out" operator then times ticket and releases the connection. The "out" operator may dial the distant suburban subscriber direct or obtain the subscriber through a distant "in" operator, according to the nature of the equipment at the distant end.

A special feature is the means provided for checking. Each "out" operator is provided with a checking circuit associated with a 10 button keyset. During the interval which elapses after calling the wanted party and before receiving his answer, the "out" operator sets up the calling subscriber's number on the keyset. This may be done very rapidly without diverting the operator's attention from the regular call. At a given signal, which appears after selection, the suburban operator momentarily depresses a common check tone key. If the check tone is heard, the proper number has been obtained. If this tone is not heard, the number given to the operator is not the calling subscriber's number. This method of operation applies to PBX lines as well as to main lines. The checking of PBX junctions is accomplished by applying the tone simultaneously or successively to all junctions in the PBX group. The checking is secret and the tone is not heard by the calling subscriber.

---



# Some Fundamental Facts Regarding Telephone Rates

By **W. S. GIFFORD**

*Executive Vice President, American Telephone and Telegraph Company*

**I**N certain parts of the United States, Bell telephone companies have recently applied to regulatory bodies for approval of new schedules of telephone rates which involve increased rates for certain groups of their subscribers. This action on the part of these telephone companies has given rise to an impression in the minds of some that the prices charged for telephone service are substantially above their pre-war level and that there is something in the nature of the telephone business which leads to ever-increasing costs of operation and hence to a continuing necessity for upward revisions of telephone rates as time goes on. This impression has been strengthened by the fact that the increases in rates now becoming effective have been deferred until the present time, when not only the general average of commodity prices, but also the rates or charges for certain public utility services in some areas, are below the peaks reached after the war. As against such an impression, what are the fundamental facts of the case?

First, as to the relation of telephone rates at the present time to pre-war rates and to general prices. According to official statistics of the U. S. Government, wholesale commodity prices at the present time average about 55% higher than in 1914, and the cost of living averages about 66% higher than before the war. But, taking Bell telephone rates throughout the country as a whole, we find that in terms of dollars they now average only 30% above the rates in 1914. The following table shows annual index numbers of cost of living and of wholesale commodity prices since 1914.

TABLE I  
Cost of Living and Wholesale Commodity Prices

	Cost of Living	Wholesale Commodity Prices	
Dec. 1914.....	100	1914.....	100
" 1915.....	102	1915.....	103
" 1916.....	115	1916.....	130
" 1917.....	138	1917.....	181
" 1918.....	169	1918.....	199
" 1919.....	194	1919.....	211
" 1920.....	195	1920.....	231
" 1921.....	169	1921.....	150
" 1922.....	165	1922.....	152
" 1923.....	168	1923.....	157
Sept. 1924.....	166	Oct. 1924.....	155

These index numbers of cost of living and of wholesale commodity prices in the United States since 1914 are based on reports of the U. S. Bureau of Labor Statistics. In the case of cost of living, costs in December, 1914, have been taken as a base and assumed to be 100; in the case of wholesale commodity prices, the average for the year 1914 has been used as a base.

The fact is, therefore, that compared with ten years ago, the dollar is worth more in the purchase of telephone service than in the purchase of commodities in general, which means, of course, that average telephone rates are lower today than they were in the pre-war period, when calculated in dollars of equal value at both dates. That telephone rates are relatively lower today than before the war is evidence that the downward trend in average telephone rates, which had been apparent for many years before the war, still continues.

But this still leaves unanswered the query in the public mind as to why telephone rates in certain areas are being raised at this time. The reason is that in these areas the prices for telephone service have not yet been adjusted as nearly as they must be to the changed price levels of labor and commodities which enter into the cost of furnishing telephone service. These telephone rates must be raised to a point more nearly in line with the increased price of other things, for telephone companies cannot absorb through operating economies all of the increase in expenses resulting from the shrinkage of the dollar.

## THREE-FIFTHS OF OPERATING EXPENSES ARE WAGES

In this connection, certain peculiar characteristics of the telephone business should be considered. For example, it is characteristic of the telephone industry that more than three-fifths of every dollar of operating expenses represent wage payments. This contrasts with a figure of 10 cents out of every dollar of operating expenses paid as wages in an "ideal" retail meat store, according to a study recently made by

the Bureau of Business Research of Northwestern University; and this figure affords an indication of the probable proportion of the wage factor in merchandising operations in general. As regards manufacturing industries, the Census of Manufactures of the United States for 1921 indicates that salaries and wages represented little, if any, more than 25% of total operating expenses of the establishments covered by the Census. As contrasted with the situation in such lines of business, a subscriber who purchases telephone service pays chiefly for labor, not for materials. There are indeed few industries in which wages count for so large a percentage of operating expenses as the telephone industry. Wages of telephone workers are very much higher than their pre-war level, as are wages in other industries. The following table shows index numbers of general wages in the United States and wages in the building trades; wages of telephone employees at the present time have increased over 1914 in substantially the same ratio.

TABLE II  
Wages in the United States

General Wages	Wages in the Building Trades
1914.....100	1914.....100
1915.....101	1915.....102
1916.....109	1916.....106
1917.....125	1917.....117
1918.....159	1918.....135
1919.....180	1919.....160
1920.....211	1920.....196
1921.....175	1921.....181
1922.....173	1922.....164
1923.....196	1923.....178
1924*.....192	1924*.....196

\*Average for first ten months of the year.

The index of general wages is based on data published by the U. S. Bureau of Labor Statistics; the building wage index through 1920 is based on U. S. Bureau of Labor Statistics data, and from 1921 through 1924, on figures compiled by the American Contractor. In each case average wages in 1914 have been taken as a base and assumed to be 100.

Another important characteristic of the telephone industry is that, unlike most commercial and industrial businesses, it has practically all of its assets in the form of plant and equipment of a relatively permanent nature and very little in the form of inventories and working capital.

In lines of business in which a large proportion of the necessary capital is invested in stocks of merchandise in process of distribution or in supplies of raw or semi-finished materials in process of manufacture, the total investment reflects rather promptly changes in the price levels of these goods and materials; and, consequently, capital charges upon the investment are also promptly readjusted and the readjustments quickly reflected in the expenses of the business. In the telephone industry, on the other hand, even an exceptional change in the market prices for labor and materials entering into plant, although immediately reflected in the cost of additional plant and equipment, does not affect that portion of the investment represented by plant installed prior to the price or wage changes, except as the older elements of plant are gradually retired from service and are replaced with plant constructed at the new price level. The effect of this situation upon the average investment per unit of telephone plant is illustrated by the following table giving index numbers which show the change since 1914 in the per station investment in Bell System telephone plant compared with the change in general building material prices over the same period, based on data published by the U. S. Bureau of Labor Statistics. In the case of telephone plant investment, the figure of December 31, 1914, has been taken as a base and assumed to be 100; in the case of building material prices, average prices in 1914 have been used as a base.

TABLE III  
Telephone Plant Investment per Station and Building Material Prices

	Telephone Plant Investment per Station	Building Material Prices
Dec. 31, 1914.....	100	1914.....100
" 1915.....	97	1915.....102
" 1916.....	95	1916.....130
" 1917.....	100	1917.....171
" 1918.....	104	1918.....187
" 1919.....	103	1919.....218
" 1920.....	108	1920.....287
" 1921.....	114	1921.....179
" 1922.....	119	1922.....183
" 1923.....	125	1923.....205
Oct. 31, 1924.....	131	1924*.....191

\*Average for first ten months of the year.

This table indicates that, whereas the general level of prices of building materials rose very sharply during the war period and now stands at

a point over 90% above its level in 1914, the increased cost of new telephone plant and equipment installed since 1914 has up to the present time been reflected in the total plant investment of the Bell System only to an extent sufficient to increase the average investment per station to 31% above 1914. As long as the average cost

#### MALADJUSTMENT IN GENERAL PRICE LEVEL

But why, it may be asked, are any commodity prices declining at this time? The answer largely lies in the fact that during the war and post-war periods many prices, unlike telephone rates, rose to a greater extent than did the aver-

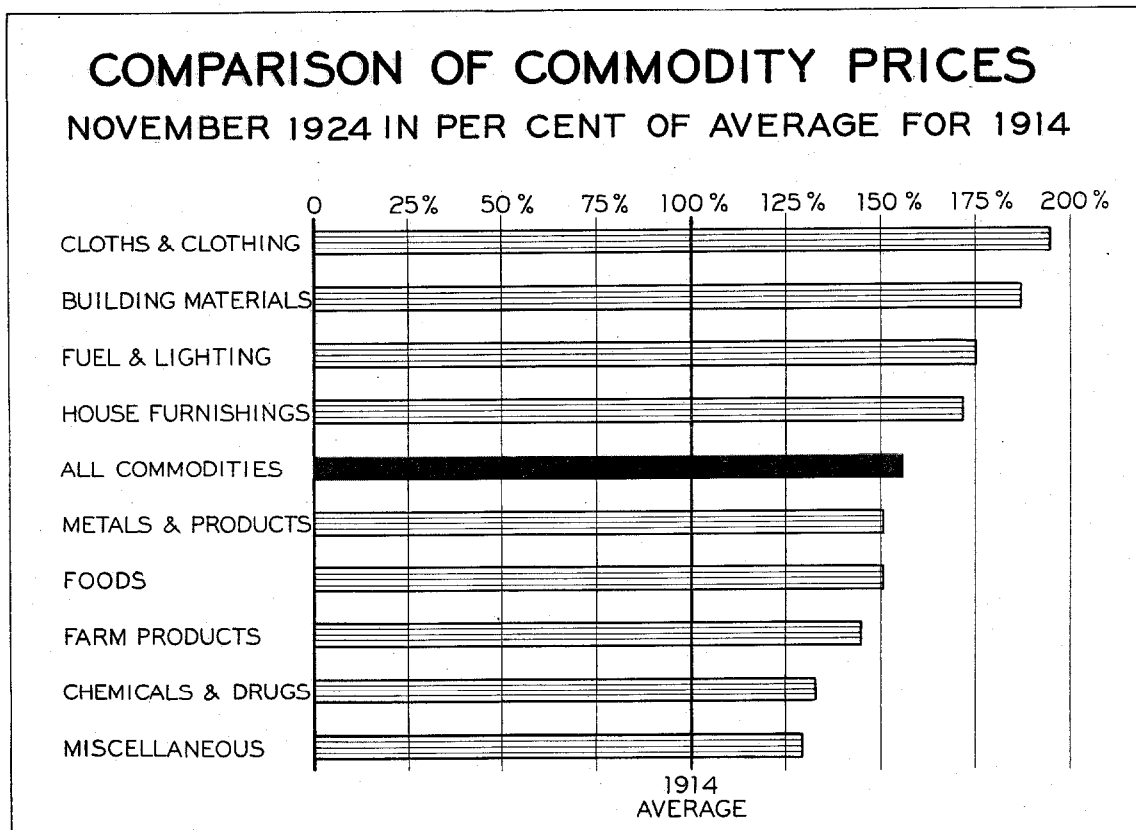

of installation of new units of plant and equipment remains higher than the average cost of units already in the plant, the average investment per unit will, of course, increase; and this will, in turn, be reflected in increases in the amount of capital charges per unit which must be met out of the revenues of the service. The table, however, shows that the effect upon the capital charges of telephone companies of the increased cost of additional plant and of replacements of plant retired from service has been gradual; and the fact that this item of telephone expenses has risen only relatively slowly is a contributing reason explaining why it had been possible for increases in telephone rates to be deferred in certain areas until the present time.

age of all prices and are still high in comparison with the general price level. Moreover, factors such as those discussed above affect costs in various lines of business in varying degrees and, through costs, also affect prices divergently. As a result of this situation, there is now a marked dispersion among individual prices relative to general price averages. The accompanying chart, showing the present relationship of the prices at wholesale of various groups of commodities to their prices in 1914, based upon statistics of the U. S. Government, affords some indication of the great maladjustment in the general price structure which exists at the present time.

Now, such maladjustment of prices obviously cannot persist for any prolonged period of time.

Price relationships which are still distorted as a result of the unequal price movements of the past ten years must eventually be restored to something approaching normal. This means, in general, that prices of commodities and services which are below the average relationship of all prices to pre-war levels will tend to rise, while prices which are above this relationship will tend to fall. The many conflicting price tendencies at the present moment give evidence that this process of general price readjustment is in progress.

#### RESTORATION OF PRICE EQUILIBRIUM

To recapitulate briefly, as a result of the war the value of the dollar has shrunk. In the process of shrinkage, normal relationships among prices of commodities and services have been distorted and are still largely out of balance. The necessary restoration of price equilibrium involves the readjustment of many prices—some upward, some downward. In the telephone business the moderate adjustment of rates necessitated by the changed value of the dollar has already been completed in many cases, but in certain areas has been deferred until the present time. This is partly a result of an effort

by the companies to offset by economies as large a part as possible of their increased expenses, and is partly due to the fact that some of the increased costs, such as those arising from the increased cost of new plant and plant replacing old plant retired from service, are not immediately reflected in full force as in the case of most other lines of business. The advances in telephone rates which have been made or are now becoming effective, then, are nothing more than a phase of the process whereby the telephone industry is adjusting itself to the new value of the dollar and consideration of the rate adjustments in comparison with general price levels indicates that these adjustments are not inconsistent with the downward trend of average Bell telephone rates which prevailed before the war.

As the war period recedes into the past, people are apt to forget that its effects upon the economic structure of the world are largely still with us. The fundamental facts regarding the bases for telephone rate changes, as outlined above, if understood by the public, should do much toward eliminating and preventing popular misconceptions as to the nature and significance of these changes.

---

# Telephone Circuits Used as an Adjunct to Radio Broadcasting

By H. S. FOLAND

*Long Lines Engineering Department, American Telephone and Telegraph Company*

and A. F. ROSE

*Department of Operation and Engineering, American Telephone and Telegraph Company*

**R**ADIO broadcasting, by which is meant the dissemination by radio of musical programs, speeches, and other matter of general interest or entertainment, has had a tremendous growth during the last five years, for, no longer than five years ago, there were practically no broadcasting stations in the United States sending out regular programs, although a certain amount of experimental work was being done at that time, while, at the present time there are over 500 such stations, of widely varying power, broadcasting programs which are becoming each day a larger factor in the life of the nation.

In its earlier stages its novelty was doubtless the reason for the almost immediate interest it aroused in the mind of the public and the excellency of program material was not of fundamental importance. Music, reproduced mechanically, lent itself readily to the problem and in many cases artists of mediocre talent sufficed to round out a then satisfactory program. As time went on, however, and the attitude inspired by novelty gave way to a more critical one the true entertainment feature became more important and a higher order of program became necessary. For a time artists and entertainers of considerable merit performing at the studio met this more exacting requirement, but there soon developed the desire to put on the air material difficult or impossible to bring to the studio itself and with this development the advantages of the use of telephone circuits in connection with radio broadcasting stations became apparent.

The technical difficulties in the way of doing this were gradually overcome so that very creditable musical programs were secured in this manner from theatres and concert halls in the same city as the broadcasting station and in addition to material of a purely entertaining character the way was opened for public participation in a great variety of events of general

interest and information. By this means the field of the broadcasting station was broadened immeasurably and the source of program material was no longer restricted to the narrow confines of the studio.

The out-of-studio pick-up of events taking place in the same locality as the broadcasting station and involving comparatively simple telephone transmission problems soon expanded to the out of town job which brought to the station more distant events with correspondingly enhanced interest to the radio audience. Perhaps naturally enough, among the first to be thus broadcast were events of an athletic nature, notably play by play descriptions of football games of the season of 1922. With this extension came more difficult transmission problems which paved the way for the broader and more comprehensive use of telephone circuits in connection with radio broadcasting which was to follow, for broadcasting stations were not long to be satisfied with the distant pick-up of events involving the transmission of speech only and the advantages of making possible the transmission of music over long telephone circuits were then foreseen.

There are many technical problems involved in the handling of distant programs. The pick-up problems are essentially the same as in the case of local programs and have been covered in the many articles in the technical press. Among these are the paper<sup>1</sup> of Green and Maxfield which was presented at a convention of the American Institute of Electrical Engineers in February 1923 and a paper<sup>2</sup> on High Quality Transmission and Reproduction of Speech and Music presented by Martin and Fletcher at the mid-winter convention of the A.I.E.E. in February 1924. Briefly it may be said that the solu-

<sup>1</sup>Public Address Systems, Green and Maxfield, *Electrical Communication*, Vol. 1, No. 4, April 1923.

<sup>2</sup>High Quality Transmission and Reproduction of Speech and Music, Martin and Fletcher, *Electrical Communication*, Vol. 2, No. 4, April 1924.

tion of these problems centers around freedom from resonance in and around transmitters and the use of amplifiers and transmitters with suitable transmission frequency characteristics. The use of telephone lines in connection with Public Address Systems has also been discussed in technical papers, notably in Martin's and Clark's paper<sup>3</sup> on the use of Public Address Systems and Telephone Lines, presented at the mid-winter convention of the A. I. E. E. in February 1923.

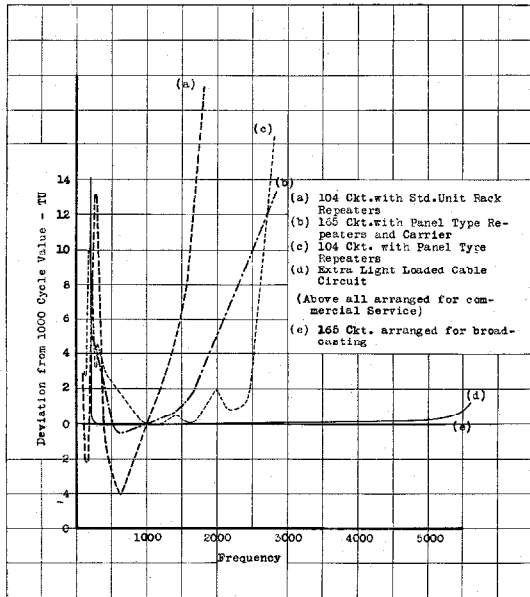

Figure 1

The problems involved in the inter-connection of a pick-up point and a radio broadcasting station by means of telephone lines are practically identical with those involved in the use of such lines in connection with Public Address Systems. These problems relate generally to the characteristics and operation of the lines themselves and the associated apparatus, particularly the intermediate telephone repeaters.

Ordinary telephone circuits to give a commercial grade of long distance transmission require a transmission band extending between approximately 300 and 2500 cycles per second. On the accompanying diagram (Fig. 1) the transmission frequency characteristic of a commercial type of telephone circuit is shown by

<sup>3</sup>Use of Public Address System with Telephone Lines, Martin and Clark, *Electrical Communication*, Vol. 1, No. 4, April 1923.

curve (a). The transmission frequency characteristics of other circuits used for ordinary telephone service are shown in curves (b) and (c). A comparison of these curves shows the better results brought about in part by certain improvements in repeaters used in the latter two circuits as compared to those used with a circuit whose characteristic is shown by curve (a).

To permit satisfactory loud speaker operation in the case of speech transmission and to provide a pleasing effect in the case of transmission of music a considerably larger range of frequencies is required. For satisfactory transmission of speech under such conditions frequencies from about 200 to 3000 cycles should be transmitted with equal attenuation, while for music a range of at least 100 to 5000 cycles is almost a necessity and an even wider band is desirable. Non-loaded open wire lines can be equalized to have a flat transmission frequency characteristic over this band and the present art covers methods of constructing repeaters so that the combination of non-loaded lines and repeaters have satisfactory characteristics from this standpoint. Curves (d) and (e) show cable and open wire circuit characteristics illustrating what can be done with present lines and repeaters. In the last two cases the characteristic shown is that of a circuit from which all equipment except that used for broadcasting purposes has been removed.

In addition to the band of frequencies to be transmitted it is important that the circuits be capable of handling fairly high energy levels since all commercial circuits are subject to certain amounts of interference from outside sources, such as adjacent telephone circuits, paralleling lines of other wire using companies and to some extent atmospheric disturbances and to aid in minimizing the effect of such interference, it is under certain special conditions found advantageous to transmit the telephone currents on circuits used for this special purpose at somewhat higher energy levels than are economically practicable for commercial operation.

The requirements mentioned above, namely the need for a broader band of frequencies and a higher energy level capacity, involve a considerable change in the commercial telephone circuits. No loading may be used on the open wire circuits, carrier channels ordinarily superposed

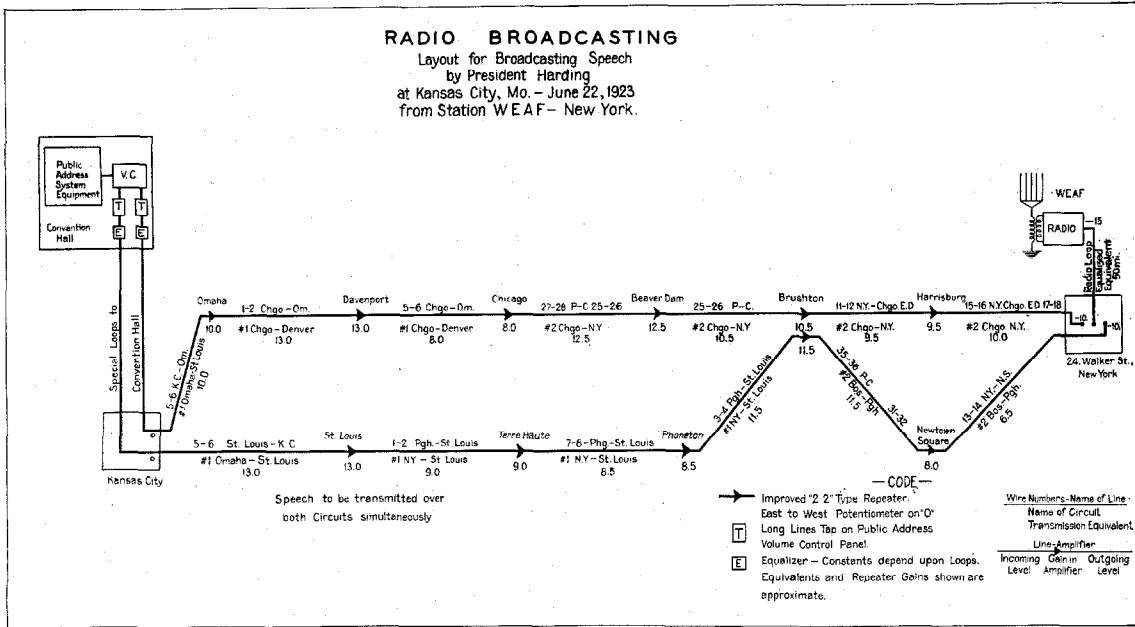

Figure 2

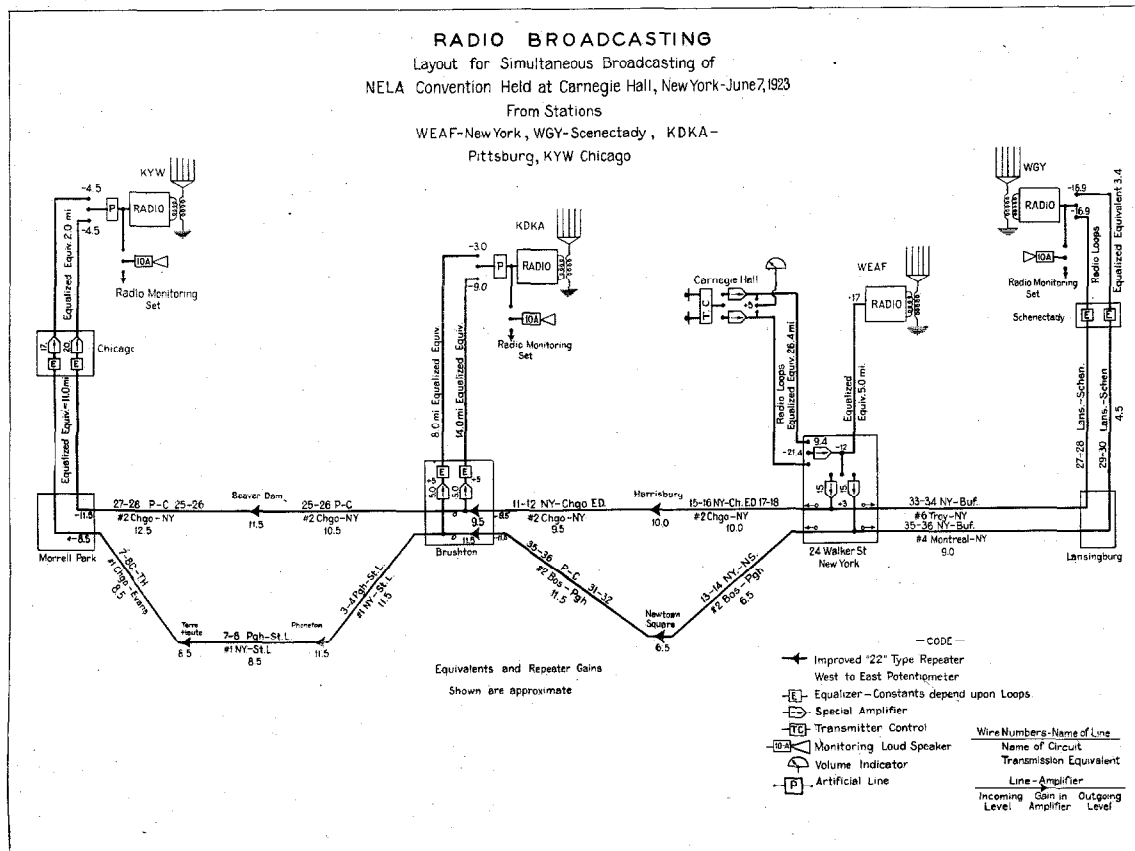

Figure 3

must be removed temporarily, equalization of the transmission frequency characteristics of the lines must be accomplished and special repeaters provided, with wide band frequency characteristics and high level capacity. These matters of design and also special attention to operation insure high quality transmission of music and speech.

In connection with the transmission of program material, several methods of connecting the radio stations with the pick-up point have been considered as an alternative to the use of wire circuits for this purpose. Radio relaying and the superposition of high frequency carrier currents on power lines have been tried with varying degrees of success. It is not the purpose of this paper to discuss this matter in any detail but many articles dealing with developments along these lines are appearing in the various technical periodicals.

The distance over which the average radio receiving set is capable of uniformly satisfactory reception is limited, by a number of factors. This might be expressed conversely by saying that the distance over which the average broadcasting station is capable of being received with uniformly satisfactory volume and quality is also limited and, therefore, when broadcasting stations separated by such distances as to insure each its own audience had been established, the need for a facility which would link together such stations upon occasion was apparent. That telephone circuits should be called upon for this purpose seems obvious. By their use complete control of the factors making for satisfactory transmission can be secured. They are adjustable with respect to volume and not only can pre-determined volume at any and all points be obtained but this can be done uniformly and consistently and, barring unavoidable accidents, can be so maintained throughout an extended performance. They are reasonably free from extraneous disturbances, especially those of an intermittent nature, while those disturbances of a more uniform character can be mitigated and in a large measure overcome. So that for consistent, wide spread distribution of broadcast material the telephone circuit operated over wires seems to be the facility which, for the present at least, is best adapted to link together the radio broadcasting stations and through

them reach simultaneously, a multitude of radio listeners. It has yet to be demonstrated that by any other means can a large number of broadcasting stations be connected together and program material be simultaneously transmitted to each station uniformly and without interruption over an extended period of time.

While, as previously mentioned, athletic events were among the earliest single station jobs with remote pick-up, these jobs were not confined to events of a purely entertaining nature. The national importance of remote pick-up was exemplified by the broadcasting of President Harding's speeches at St. Louis and Kansas City in June 1923. The accompanying diagram (Fig. 2) shows the circuit arrangement employed for the broadcasting of the Kansas City speech from which it will be seen that a Public Address System was employed at the Convention Hall in Kansas City, to which system connection was made for supplying the telephone circuits. Two telephone circuits, over separate pole lines for protection reasons, were established, transmitting in one direction only, and the President's speech was transmitted simultaneously over these circuits to the broadcasting station in New York. It should be borne in mind that on this diagram are shown only those facilities directly concerned with the transmission of the broadcasting material itself. The auxiliary telephone order circuit and the telegraph facilities employed in addition to the transmission circuits are not indicated.

From the single station job it was a logical and almost immediate step to the use of telephone circuits for connecting together radio broadcasting stations for the simultaneous broadcasting from a number of stations of events of wide spread interest. One of the first multiple station jobs was that shown on the accompanying diagram (Fig. 3) the occasion being an evening session of the National Electric Light Association held in New York, also in June 1923, and broadcast from stations in New York, Schenectady, Pittsburgh and Chicago.

In the earlier stages of this work each job was considered a special one. The transmission of speech only was attempted or, at most, speech and incidental music. Considerable time was spent in advance of the performance in setting up, testing out and adjusting the network of



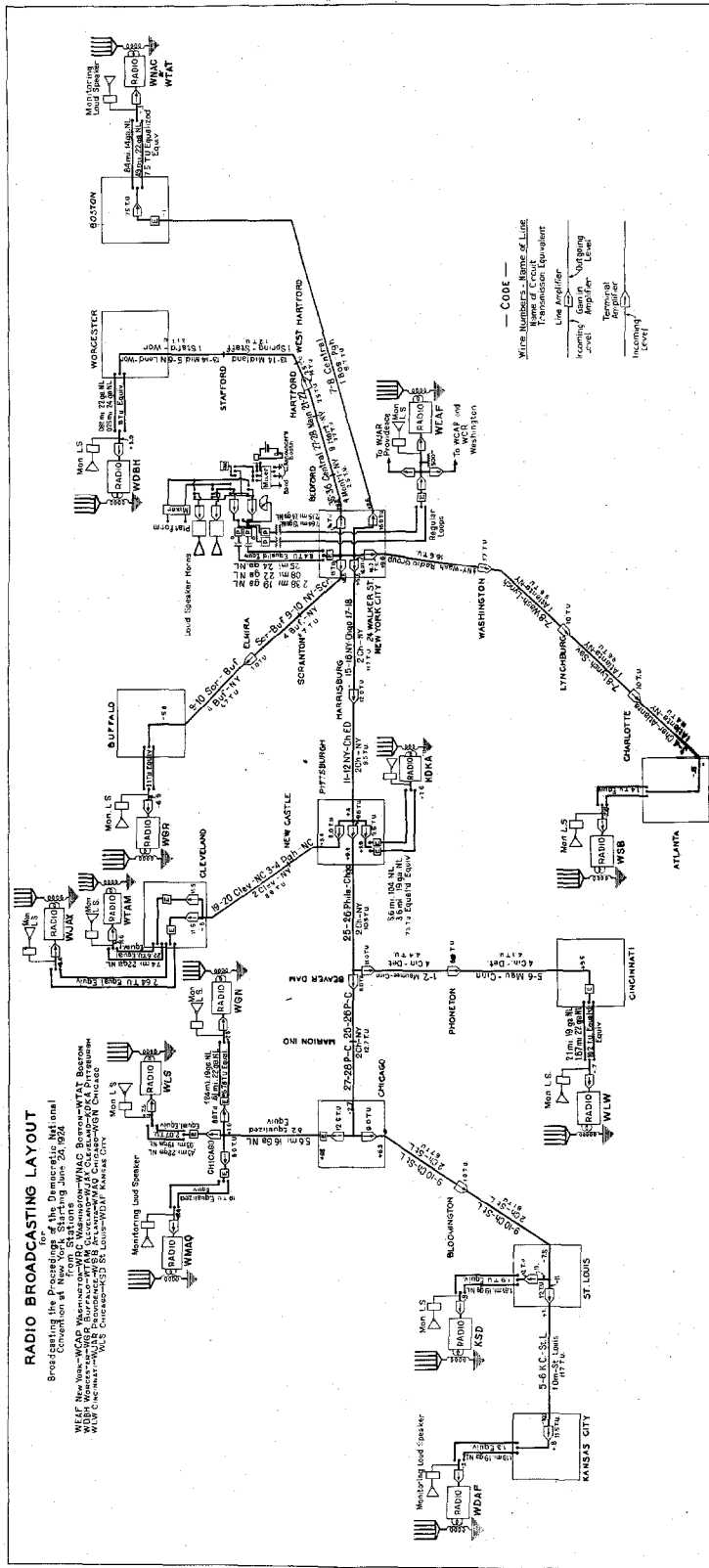

Figure 4

circuits to be employed to insure that all was in readiness and that the circuits, entirely suitable for the intelligible transmission of speech at the volume required in the receiver on a commercial telephone connection, would be satisfactory when called upon to transmit material later to be amplified many times and received by listeners whose impressions would be influenced not only by its intelligibility, but also by its naturalness, its inflections, in other words its quality, whereby the personality of the speaker was conveyed to the listener.

Early in 1924, the use of radio broadcasting stations in the coming political campaign became apparent, and may be said to have opened with the broadcasting of the proceedings of the Republican Convention in Cleveland, starting June 10 from 14 broadcasting stations and of the Democratic Convention in New York, starting June 24, from 17 stations. The accompanying diagram (Fig. 4) shows the network employed in the broadcasting of the latter convention. This diagram may be taken as typical of the larger jobs of this character and it will be noted that this was a single circuit network. By this is meant that duplicate circuits were not built up and the proceedings were not transmitted simultaneously over two networks whereby a broadcasting station could switch from a regular to an emergency circuit at will. Obviously the extensiveness and complexity of this network of circuits precluded such an arrangement but of course emergency circuits were designated and tested between the various points of flexibility in the network and plans were perfected to eliminate any avoidable delay in substituting other circuits for those shown on the diagram in the event of trouble. It will be seen from this diagram that the general plan which was followed in building up the circuit arrangement was that of a central control point from which radiated a minimum number of main circuits which might be termed the back-bone of the network and from these back-bone circuits bridged circuits were supplied by means of which the various broadcasting stations were reached with a minimum circuit mileage.

It will be seen that these branch circuits were connected to the main circuits through amplifiers which because of their one way transmission feature effectively prevented trouble on any of

the branch circuits from affecting the remainder of the network. Regular and emergency sets of pick-up equipment were provided at the convention hall connected by regular and emergency loops to the central control point which was in the telephone building at No. 24 Walker Street, New York. From this point the main circuits radiated and here the energy supplied to each of the transmitting circuits was controlled. Regular and emergency loops were provided to each broadcasting station because of the delay which would be involved in replacing these particular parts of the network in the event of trouble. Needless to say this entire system consisting of the pick-up equipment at the convention hall, the telephone circuits connecting together the broadcasting stations and the apparatus at the broadcasting stations themselves was set up well in advance of the opening of the convention and adequate tests made to insure its proper performance. As in the case of diagrams previously shown only those facilities directly involved in the transmission of the broadcasting material itself are indicated and the auxiliary system of telegraph circuits has been omitted. These telegraph facilities are a very essential adjunct to such a system of telephone circuits, since by their means the necessary communication required in connection with the building up, lining up and operation of the system is obtained. Obviously auxiliary telephone circuits whereby not only every broadcasting station connected to the system, but also every telephone station concerned could be called in and communicated with simultaneously would involve difficult signalling and transmission problems which were in a large measure avoided by the use of telegraph.

A system of circuits, such as that indicated in Figure 4, is best operated from a central control point, from which point the lining up of the system can be directed, the service at each broadcasting period started and any changes in adjustment necessary during the period of operation dictated. To accomplish this the controlling point must receive advice from each of the strategic points in the system. At the start of each broadcasting period, it is necessary that the local announcements of the various broadcasting stations be so timed that these announcements are made practically simultaneously from all the

stations and advice that these announcements have been made, that the broadcasting stations have all been connected to the transmission circuits and that each station is ready for the announcement from the remote pick-up point, must be received by the central control point, in order that service may be started smoothly and with a minimum of delay between the discon-

with one or possibly two assistants at the central control point, transmission experts and testers at strategic points, repeater attendants at each of the offices involved and telegraph operators at each of the radio stations and repeater points. Frequently it is possible to combine the functions of repeater attendants and telegraph operators but in the network shown in Figure 4 involving

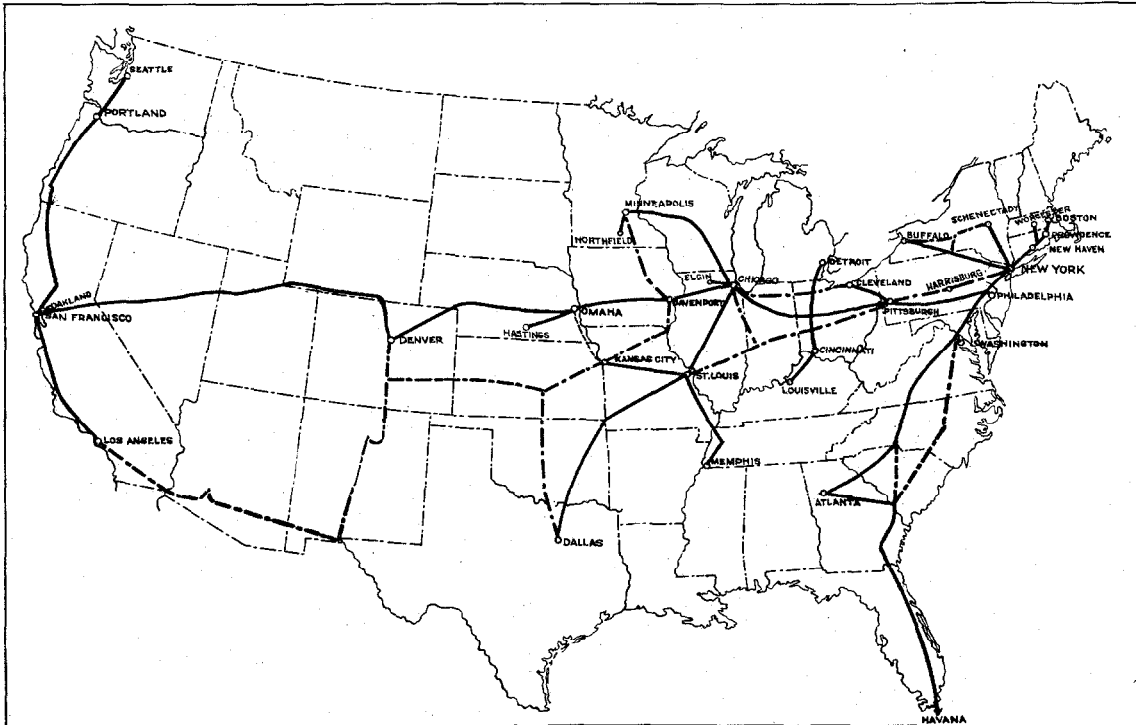

Figure 5

tinuance of the local programs and the beginning of the distant one. Fine coordination is required, in order that the interval, between the local announcements that "the next voice you will hear, will be — etc." and the beginning of the announcement from the distant point may be short and uniform at all of the broadcasting stations connected to the system. Frequent information should also be received by the central control point throughout the period of service regarding the satisfactoriness of the transmission to each of the broadcasting stations in order that, if necessary, adjustments may be made whereby improvement can be effected.

In operating such a system, therefore, a considerable personnel is involved consisting principally of the one in control of the entire system

approximately 4000 miles of circuits and 17 radio stations, this personnel totaled approximately 50 men.

One of the most comprehensive systems of telephone circuits yet established for connecting together radio broadcasting stations was that incident to the observance of the National Defense Day, September 12, 1924. This system involved the use of telephone circuits from coast to coast with a total of 18 radio broadcasting stations connected and in addition to the usual one-way transmission features, arrangements were made whereby two-way conversations between Washington and New York, Chicago, Omaha and San Francisco were held, both ends of these conversations being broadcast simultaneously from all of the stations con-

nected. Since the Defense Day demonstration there have been even a larger number of broadcasting stations connected together for the simultaneous broadcasting of speech although on these latter occasions only one-way transmission

become apparent that the use of telephone circuits for connecting together radio broadcasting stations would involve the transmission of more than speech and incidental music. At that time it was easily seen that there were considerable

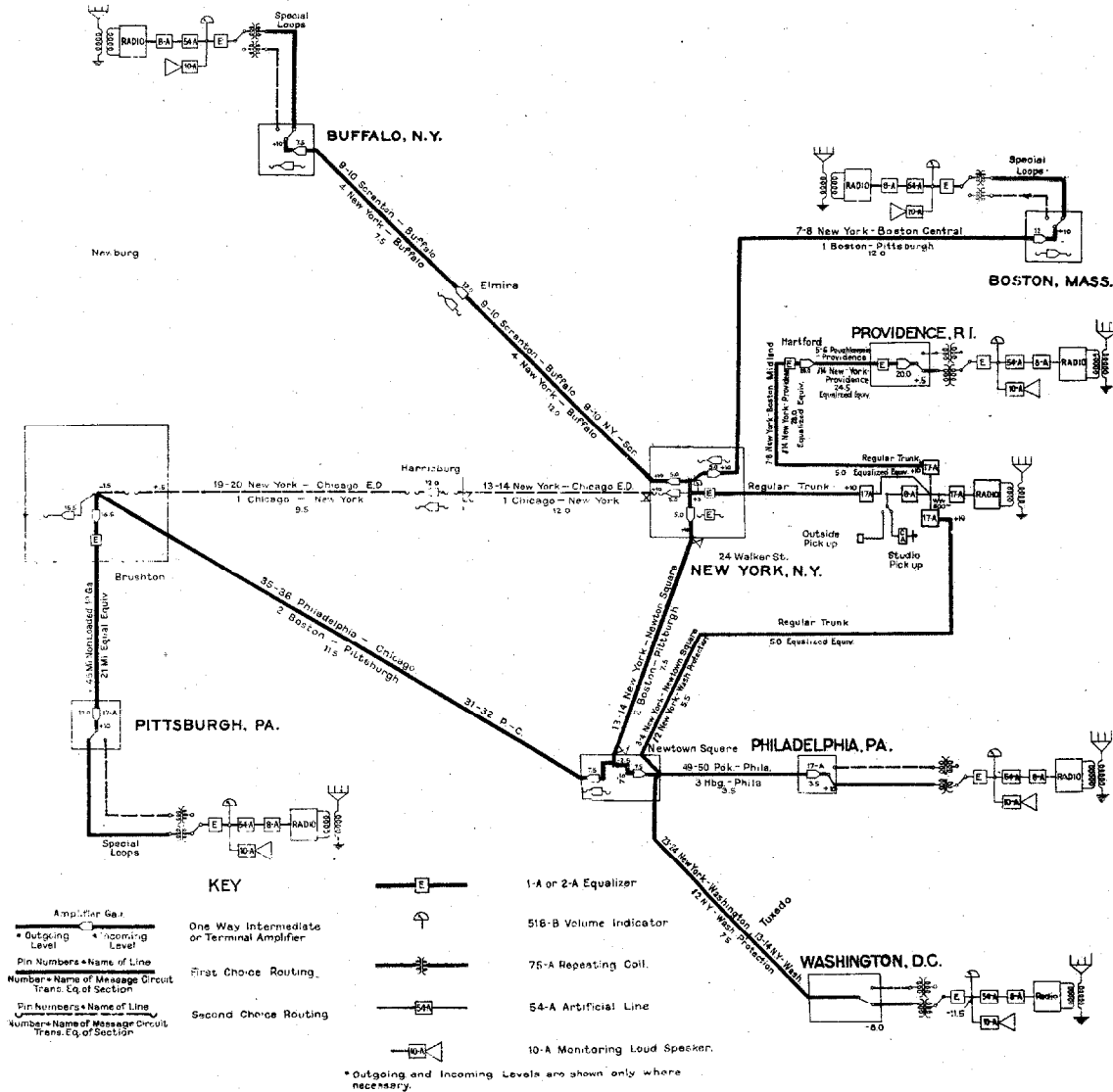

Figure 6

has been given. The accompanying diagram (Fig. 5) shows the routes which have been employed and the points which have been reached and from this diagram may be seen how nearly, by the combined use of telephone circuits and radio broadcasting stations, the voice of a speaker has reached the entire nation.

Even before the political convention it had

possibilities of a central point from which program material of all kinds, including music requiring the transmission of the broader band of frequencies, could be supplied to a number of broadcasting stations. The use of telephone circuits for this purpose has developed to a considerable extent around New York and the accompanying diagram (Fig. 6) shows a system

of circuits frequently set up whereby program material is transmitted from New York to 7 broadcasting stations.

Obviously, the frequent recurrence of this service would preclude treating each broadcasting period as a special case, selecting anew, each time, the circuits to be employed, with the accompanying scrutiny and tests necessary to insure proper operation. Consideration was therefore given to the best and most economical method of taking care of this recurring layout, with the result that certain circuits were selected and so equipped that their transmission characteristics approximate those shown on curves (d) and (e) in Figure 1.

With these circuits properly designated and equipped, the time necessary to build up, test and adjust this system is materially reduced, in part because the personnel has more complete knowledge of the special features of the facilities employed and has become more proficient in their manipulation in this special manner. The extensive preliminary tests are eliminated and definite, well thought out plans have been formulated and provisions made to handle the traffic normally routed over these facilities during the period when they are taken for this special use. Foreknowledge of and familiarity with these arrangements on the part of the operating forces, also, tends to minimize the detrimental effects of such temporary changes as are necessary in the normal circuit assignment. This is a very desirable result to accomplish, for it should be

borne in mind that the plant of the telephone company has been developed along lines suited primarily for meeting the requirements of telephone message business.

The very special character of this service and the irregular demand for it has not made it practicable as a commercial matter to provide circuits intended primarily for use as an adjunct to radio broadcasting. Taking advantage, however, of the variations in the amount of telephone traffic throughout the day and by making special arrangements to temporarily equip for this use circuits ordinarily used in the message business it has been possible to take care of a large number of requests for the provision of circuits for this use.

The extent to which this use of telephone circuits will develop is, of course, problematic at the present time, but it is conceivable that it might increase to a degree which would justify taking it into account in planning additional circuits. Under certain conditions, the relative magnitudes of peak and off-peak loads might be such that an off-peak load of radio broadcasting might help to make economical additional circuits which would be used advantageously for message service during the busy periods of the day. It is yet impracticable to predict that either the demands for this type of service or the intervals at which this demand occurs will be such as to make it a considerable factor in planning telephone facilities.

---

# The Dependence of the Loudness of a Complex Sound Upon the Energy in the Various Frequency Regions of the Sound\*

By H. FLETCHER and J. C. STEINBERG

*Engineering Department, Western Electric Company, Inc.*

## INTRODUCTION

THE interpretation of speech is dependent among other things upon the loudness with which it is received and upon the loudness of such interfering noises as are present. In general, when speech is reproduced, it suffers a certain amount of distortion, because of the inefficiency characteristic of the apparatus. In considering the interpretation of the reproduced speech it is necessary to know the effect of the distortion upon the loudness of the speech and of the interfering noises.

This paper gives the results of an investigation to determine the dependence of the loudness of a complex sound upon its frequency-energy spectrum. Energy as used here refers to the sound energy flowing into the ear, corresponding to a pressure variation at the opening of the ear canal. By means of high and low pass filter systems, the energy in any particular frequency region was removed from the complex sound. The decrease in loudness due to the removal was measured by distortionlessly attenuating the original sound until its loudness was equal to that of the filtered sound. This experimental procedure was adopted because experience has shown that the ear can judge equality of loudness much more accurately than it can judge differences in loudness. Two types of sounds were experimented with; one having a so-called continuous energy frequency spectrum and one having a spectrum consisting of discrete frequency components.

It is evident that the effect of distortion upon loudness depends upon the distribution of sound energy as perceived by the ear. Our early experiments along this line indicated that the nature of this dependence was rather complex. When dealing with speech it was found that for calculating the effective loudness loss  $\bar{a}$  in sen-

sation units<sup>1</sup> due to introducing loudness losses  $a$  at each frequency, where the value of  $a$  depends upon the frequency an empirical formula of the type

$$10^{-\bar{a}/30} = \int_0^{\infty} G(n) 10^{-a/30} dn \quad (1)$$

would represent the experimental results. From the definition of the sensation unit,<sup>2</sup> the fractional energy loss is  $10^{-a/30}$  and consequently the use of the above formula involved a summation of the cube root of the energy rather than the energy. The form of the function  $G(n)$  was obtained empirically from the experimental data and may be considered as a weighting factor. It was found that no formula involving the summation of the energy rather than the cube root of the energy was adequate.

Although the use of this formula enabled the calculation of the loudness of speech coming from various types of telephone systems, the situation was somewhat puzzling and unsatisfactory from the fundamental standpoint of trying to understand how we hear. Furthermore, it was not known whether the formula could be used for sounds other than speech.

For these reasons improved apparatus was designed and the earlier experiments repeated, using other complex sounds as well as speech. It was then found that to fit these new data different roots and weighting factors depending upon the intensity and character of the sound were required in the formula given above. Under conditions similar to those in the earlier experiments, the results were essentially the same as those originally obtained. As the work went on, it became apparent that the non-linear character of the ear transmitting mechanism was playing an important part in determining the loudness of complex tones.

<sup>1</sup> See H. Fletcher, *Jour. Frank. Inst.*, 194, 289 (Sept., 1923).

<sup>2</sup> In telephone engineering this is called a transmission unit and is usually designated by the letters T. U.

\* Published in the *Physical Review*, Vol. 24, No. 3, September, 1924.

DESCRIPTION OF METHOD AND APPARATUS

The circuit used for making the comparisons was a modification of the high quality telephone system which has been described elsewhere.<sup>3</sup> A schematic arrangement of it is shown in Figure 1. The overall response-characteristic of the system, excluding the branch containing the filters was approximately uniform. That is, the relative distribution of pressure at the

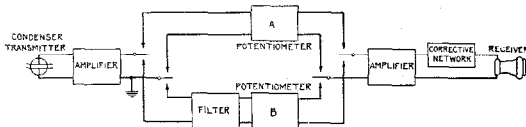

Figure 1—Circuit Used to Determine Effect of a Filter in Loudness

transmitter diaphragm did not differ appreciably from that in the ear canal when the receiver was held against the ear.

The circuit could be closed through either of the two branches, which differ only in that one contains a filter. The filter removed all audible frequency components above or below a given cut-off frequency, the remainder of the frequency range being passed without appreciable loss. By means of the potentiometer, designed as A, Fig. 1, the unmodified output of the first amplifier could be distortionlessly attenuated until the sound produced by it was judged to be equally loud to that produced by the filtered output. The potentiometer was calibrated in sensation units or the logarithm of the number of times the pressure variation in the ear canal had been decreased.

Different observers differed in their judgment as to when two complex sounds were equally loud, particularly if the sounds being compared differed widely in character. Our experience indicated that for the types of sounds employed here, the average of the potentiometer readings obtained by six or seven observers gave a sufficiently accurate value for our purpose. In what follows, it is understood that we are dealing with such an average value.

The results are given on two complex sounds which are considered typical. They are referred to as "speech" and "test tone" and have pressure spectra as shown in Figures 2A and 3.

<sup>3</sup> H. Fletcher, *Jour. Frank. Inst.* 193, 729 (June, 1922).

The pressure spectrum of speech was obtained from the average energy distribution as determined by Crandall and Mackenzie,<sup>4</sup> by taking the square roots of the average energies at 100

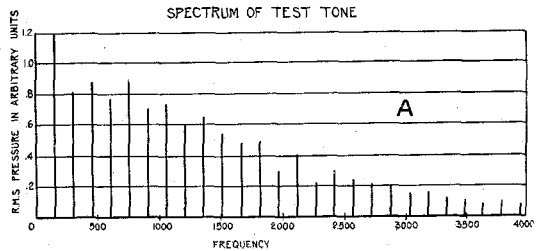

Figure 2A—Pressure-Frequency Spectrum of Test Tone of Type 3-A Audiometer

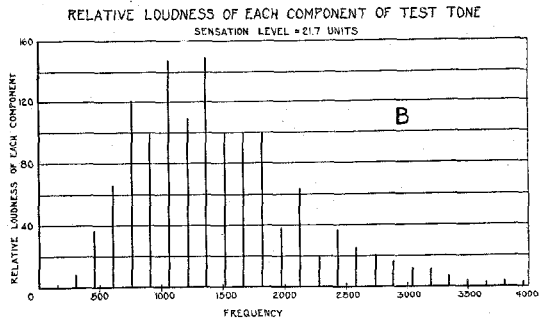

Figure 2B—Relative Loudness of Each Component of the Test Tone

cycles and its harmonics. The value given for the energy at any frequency is an average of fifty measurements made on a specimen of connected speech. The test tone was that pro-

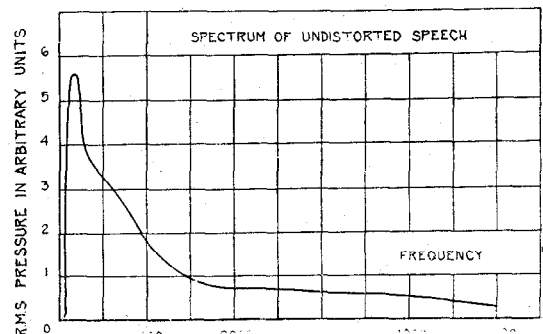

Figure 3—Pressure-Frequency Spectrum of Undistorted Connected Speech

duced by the type 3-A audiometer,<sup>5</sup> an instrument designed to make rapid tests of the degree of hearing.

<sup>4</sup> Crandall and Mackenzie, *Phys. Rev.* 19, 221 (March, 1922).

<sup>5</sup> H. Fletcher, *Volta Rev.*, Jan., 1924. (The audiometer is referred to as type 3 in this paper.)

As mentioned above, the effect of inserting the filter depends upon the intensity of the unfiltered sounds. For this reason results were obtained at various intensities. The changes in intensity were made in such a way that each component was changed the same fractional amount so that the sound spectrum in the outer

units above the threshold, or about one-fifth of the way up to the feeling point on a sensation scale. The  $x$ -axis gives the cut-off frequency of the filter. The  $y$ -axis gives the percentage of unfiltered energy equal in loudness to the filtered energy. These percentages were obtained from the average potentiometer readings for the filters. The high pass filter curve shows the observed percentages for filters that pass only frequency components above the cut-off frequency. In the case of the low pass filter curve, the filters pass only those frequency components below the cut-off frequency. For example, the point (1000, 22) means that when all frequencies above 1000 cycles are eliminated, the unfiltered sound must be reduced in intensity to 22 per cent. of its original value before it is equal in loudness to the filtered sound. It is seen that the curves intersect at approximately 50 per cent. and that the sum of their ordinates for any cut-off frequency is approximately 100 per cent.

When the intensity of the tone was increased without distortion to a greater value and the experiments repeated, the solid curves shown on Figures 5 and 6 were obtained.

It is seen that the intersection points of the two curves for these cases correspond to a much lower per cent. than 50 and are shifted toward the low frequencies. It is evident from these charts that the energy spectrum stimulating the nerve terminals is very different in the three cases even though the shapes of the waves leaving the receiver diaphragm are unchanged. In Figures 7 and 8 similar curves are given for the case of average speech.

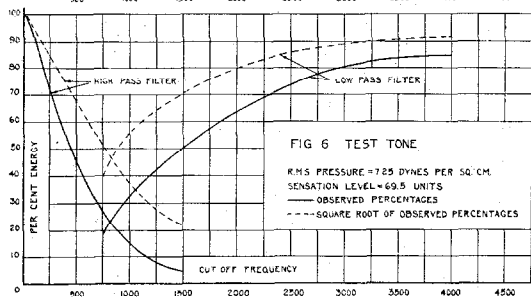
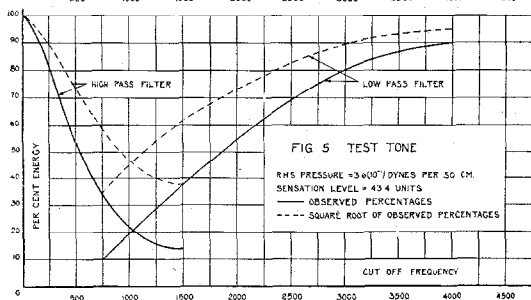
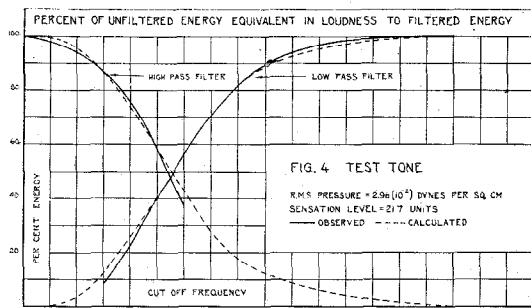

ear canal was changed only in size and not in form. The pressure is expressed in dynes per square centimeter.

### EXPERIMENTAL RESULTS

The two solid curves in Figure 4 were obtained with the test tone at an intensity corresponding to a root mean square pressure variation in the ear canal of  $2.96 \times 10^{-2}$  dynes per square centimeter. The minimum audible pressure for this tone is  $2.43 \times 10^{-3}$  dynes per square centimeter so that the level of the tone was 21.8 sensation

### FORMULATION OF AN EMPIRICAL EQUATION FOR COMPUTING LOUDNESS LOSSES

If we were to plot the percentage of the total energy passed by the filters as a function of the cut-off frequency, we would obtain curves which would intersect at 50 per cent. and the sum of whose ordinates would be 100 per cent. The curves would be the same irrespective of the absolute value of the total energy. If we plot the proper root of the observed percentages in the case of the loudness curves, we can make them intersect at 50 per cent. and it so happens that the sum of their ordinates is approximately



100 per cent. The dotted curves shown in the figures mentioned above were obtained in this way. If we desire to adopt the idea that each frequency component in the external sound wave

and equal to  $E_{k0}$  in the unattenuated range of frequencies, so that for the low pass filter

$$y_L^b = \sum_1^{k'} (W_k)^b \tag{4}$$

where  $k'$  is the unattenuated component.

Similarly for the high pass filter

$$y_H^b = \sum_{k''}^n (W_k)^b \tag{5}$$

where  $k'$  is the last unattenuated component.

For any two complementary filters

$$y_L^b + y_H^b = \sum_1^{k'} W_k^b + \sum_{k'}^n W_k^b = 1 \tag{6}$$

This equation must hold regardless of the weight factor function  $W_k$ . This means that the sum of the ordinates for the two curves for any abscissa must be unity. If this is not true, the empirical equation assumed is not adequate. Also, at the intersection point,  $y_L = y_H$ , so that

$$y^b = 1/2 \text{ or } b = \log \frac{1}{2} / \log y \tag{7}$$

which is sufficient to determine the constant  $b$ .

The exponent given on each of the charts was obtained from this equation and is seen to vary from  $1/3$  to  $1$ .

An empirical formula similar to Eq. (2) modified to fit a continuous spectrum is

$$y^b = \int_0^\infty (WE/E_0)^b dn \tag{8}$$

For the filter experiments this reduces to

$$y_L^b = \int_0^{m_1} W^b dn \text{ and } y_H^b = \int_{m_2}^\infty W^b dn \tag{9}$$

where  $m_1$  and  $m_2$  are the cut-off frequencies for low pass and high pass filters respectively.

It is seen from these equations that the weight factor can be obtained by taking the slope of either of the high or low pass filter curves. Thus for computing the loss of loudness of speech coming from a telephone receiver due to attenuating certain frequency regions, the formula

$$y^{1/3} = \int_0^\infty (WE/E_0)^{1/3} dn \tag{10}$$

can be used when the loudness is in the important intensity range used in practice. The function  $W^{1/3}$  is the slope of either of the dotted curves

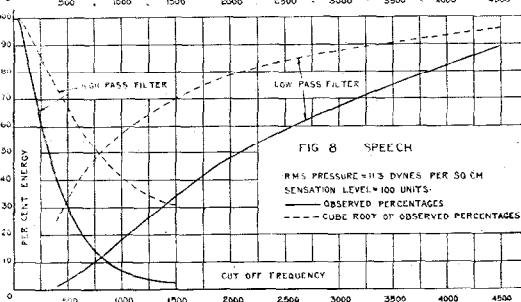
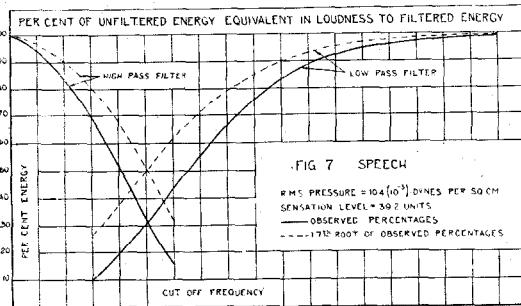

contributes an integral amount to the resultant loudness, in such a way that the component parts can be summed to give the resultant loudness, the fractional loss can be empirically represented by an equation of the type

$$y^b = \sum_{k=1}^{k=n} \frac{(W_k E_k)^b}{(E_{k0})^b} \tag{2}$$

The summation is taken over all the components.  $y$  is the fractional decrease in the undistorted sound necessary to make it sound equally loud to the distorted sound.  $E$  and  $E_0$  are the energies in each component before and after the distortion. The weight factor  $W$  and the exponential constant  $b$  can be determined from the experimental data.

For no distortion, that is, when  $E_k = E_{k0}$ ,

$$y^b = 1 = \sum_1^n W_k^b \tag{3}$$

For the filters used in these experiments  $E_k$  may be considered zero in the attenuated range

shown in Figure 8 and  $y$  is the fractional energy reduction in the undistorted speech required to make it equal in loudness to the distorted speech. This formula is equivalent to that given in Eq. (1)  $\bar{\alpha}$  and  $\alpha$  are defined by

$$y = 10^{-\bar{\alpha}/10} \text{ and } E/E_0 = 10^{-\alpha/10}.$$

This formula has an important engineering application and this discussion indicates what limitations must be imposed upon its use. It is strictly empirical in nature and applies only to speech at loudness levels in the range between 70 and 100 units.

#### COMPARISON OF OBSERVED AND CALCULATED VALUES

In order to test this formula, the loss in loudness was computed when different types of resonant networks are introduced into an otherwise distortionless system. The losses at each frequency for six different resonant systems are shown by the six curves in Figure 9. The table

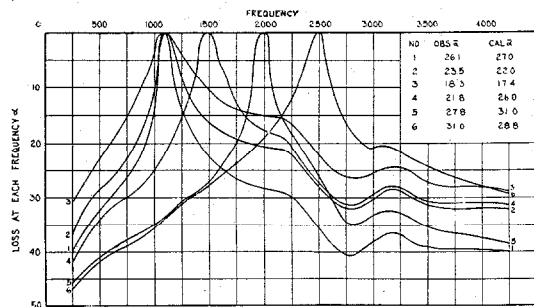

Figure 9—Loss Curves of Resonant Systems and Effective Loss in Loudness of Speech at Loudness Levels Between 70 and 100 Units

gives the calculated and observed loudness losses for these systems. The observed values are averages taken by several observers.

When the experimental measurement of the effective loss produced by such resonant networks is made at lower levels, the losses are smaller. Using the weighting factor functions derived from the experimental data for these lower levels taken with the filters, the curves on Figure 10 were calculated. The averages obtained by several observers are shown by the circles. These data were obtained with the resonant system No. 1, having the response characteristic shown in Figure 9. It is seen that the loss in sensation

units at the low intensity levels is only about one-half that at the higher levels.

#### DISCUSSION

For the case shown in Figure 4, some important conclusions concerning hearing can be drawn.

There is a great deal of evidence that the elastic members taking part in the transmission of sound to the inner ear fail to obey Hooke's

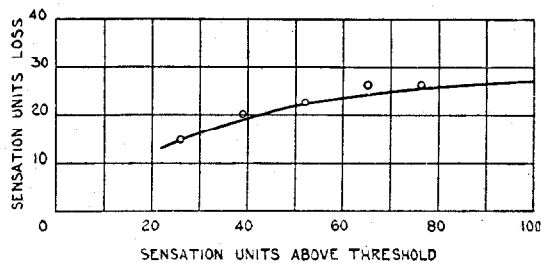

Figure 10—Effective Losses for Resonant System No. 1

law when the intensity of the sound becomes sufficiently great.<sup>6</sup> Evidence obtained in our laboratory indicates that this non-linearity begins somewhere between 20–40 sensation units above the threshold for the most useful range of frequencies. For very low frequencies, the non-linearity begins even at the lower levels. For those very near the lower pitch limit of audibility, it is probable that the non-linearity begins before the tone is audible. For most sounds below 30 sensation units the spectrum in the inner ear can be obtained from the spectrum in the outer ear by multiplying the ordinates by the relative loss produced by the ear transmitting mechanism, that is, by the relative sensitivity of the ear for various frequencies. The necessary data for doing this are available.<sup>7</sup> If this is done for the sound spectrum shown in Figure 2A the spectrum in Figure 2B is obtained. The fractional part of the energy eliminated from this inner ear spectrum by the various filter combinations is shown by the dotted lines in Figure 4. It is seen that they practically coincide with the solid lines representing the observed data. *From the agreement between these experimental and calculated curves, it is concluded that at low intensities the contribution of a small frequency region to loudness is pro-*

<sup>6</sup> R. L. Wegel and C. E. Lane, *Phys. Rev.* 23, 266 (1924).

<sup>7</sup> H. Fletcher and R. L. Wegel, *Phys. Rev.* 19, 553 (1922).

portional to the energy contained in the frequency region weighted according to the reciprocal of the minimum audible energy for that frequency region. The total loudness may be obtained by summing the contributions throughout the frequency range.

For these low intensities then, the empirical formulas (2) and (6) become,

$$y = \sum_1^n (W_k E / E_0) \text{ and } y = \int_0^\infty (W_k E / E_0) dn$$

where, now, the weighting factor  $W_k$  has a definite physical meaning, for it is the fraction of the total energy in the inner spectrum that is carried by the  $k$ th component. It can easily be computed from the sound spectrum in air.

It is probable that these same formulas will hold for all levels except those very near the threshold if  $W_k$  is given this interpretation. However, for loudness levels greater than 30 sensation units the problem of computing such an inner ear spectrum becomes very much involved and will not be discussed here.

For the present the empirical formulas given above can be used for the important case of speech. However, it is interesting to notice what is taking place qualitatively at the higher levels. When the intensity becomes great

enough, non-linear distortion occurs. The net result of the distortion is to bring into greater prominence the lower frequency regions of the sound. It is thus seen that changes in the intensity of a complex sound are accompanied not only by changes in loudness but also by changes in the character of the sensation. This undoubtedly is also true for single frequency tones, although perhaps not to such a noticeable extent. These considerations have an important application in considering the interpretation of speech at different intensities.

It has probably been noticed that when dealing with speech, loudness losses were measured by changing the intensity of speech, and that when dealing with the test tone, the losses were measured by changing the intensity of the test tone. It has also probably been realized that the losses thus measured are not directly comparable, and that we have dealt with loudness in a very specialized way. The methods were adopted because of their use in telephony and also because sufficient fundamental data were not available to formulate more general relations. These data have now been obtained, and it is expected that a paper dealing with loudness in a much more general way will soon be ready.

# Broadcasting in South Africa

By F. H. AMIS

*European Engineering Department, International Western Electric Company*

WITH the completion during 1924 of the Radio Broadcasting Station at Johannesburg there was established the first installation under the broadcasting scheme for South Africa. The history of wireless in that country begins, however, as far back as 1911 when a few experiments were carried out in radio-telegraphy for the South African Post Office. By 1914 a number of amateurs were attracted to the subject, and in 1920 a small group of investigators formed themselves into the Transvaal Radio Society. A little later, the South African Institute of Electrical Engineers formed a Wireless Section which absorbed the Transvaal Radio Society, and at about the same time the Radio Society of South Africa came into existence at Capetown and Durban.

As a result, the South African Government undertook a study of Broadcasting and devised a scheme whereby the country was to be divided into areas of about 100 miles radius for the purpose. It was realized, however, that broadcasting on a commercial basis could be carried out practically only from three points, i.e., Johannesburg, Capetown and Durban. In Johannesburg, members of the Associated Scientific and Technical Societies—a group that includes the South African Institute of Electrical Engineers, the Institute of Engineers, and the Physical, Medical and Chemical Societies—became interested.

At about this time, October, 1923, the South African Railways were endeavoring to raise funds in aid of the part that South Africa was to take in the British Empire Exhibition. It was suggested to the Railways that if they borrowed the broadcasting equipment which was already in the country, and broadcast a few concerts, a considerable amount of money could be reasonably expected in aid of their funds. The Railway authorities acquiesced, and permission was obtained from the Government to erect and use the broadcasting equipment for this purpose. The equipment was,

therefore, erected at the headquarters of the South African Railways, and during the period from December, 1923, to January, 1924, four or five concerts were broadcast. The first concert was the occasion of an introductory speech by General Smuts, at that time Prime Minister, the speech being transmitted by land-line from Roberts Heights, distant about 20 miles from the Railway Headquarters. Although the apparatus was installed in a very hurried and temporary manner and under adverse conditions, the venture proved eminently successful, for notwithstanding the fact that from the point of view of atmospheric disturbances, the South African summer is the worst season of the year, the station was "received" at points over 1,000 miles distant. As a result of the transmission of these concerts, the demand for the establishment of a regular broadcasting service considerably increased.

Shortly afterwards a license was received by the Societies, who signified their approval of the conditions enumerated therein. In effect, the broadcasters were to be made responsible to the South African Postmaster General for the maintenance of a satisfactory broadcasting service. In the conditions laid down by the Department of Posts and Telegraphs, all individuals desiring to use a radio receiving-set are required to obtain a license from that department. The charge for this license is five shillings; and the extreme penalty for using a set without being in possession of a license is a fine of £5 per day for every day such contravention is continued. In addition to the cost of the license, listeners are also required to pay a fee to the authorities operating the broadcasting-station in their area. This fee ranges from £2 per annum for a receiving-station established in an ordinary residence, to £6 per annum for a receiving-station used in a public hall for entertainment, and *pro rata* for boarding-houses, cafes, hotels, etc.

The Societies decided to go ahead with broadcasting for the Johannesburg area and, after due consideration, chose a site for the erection of the

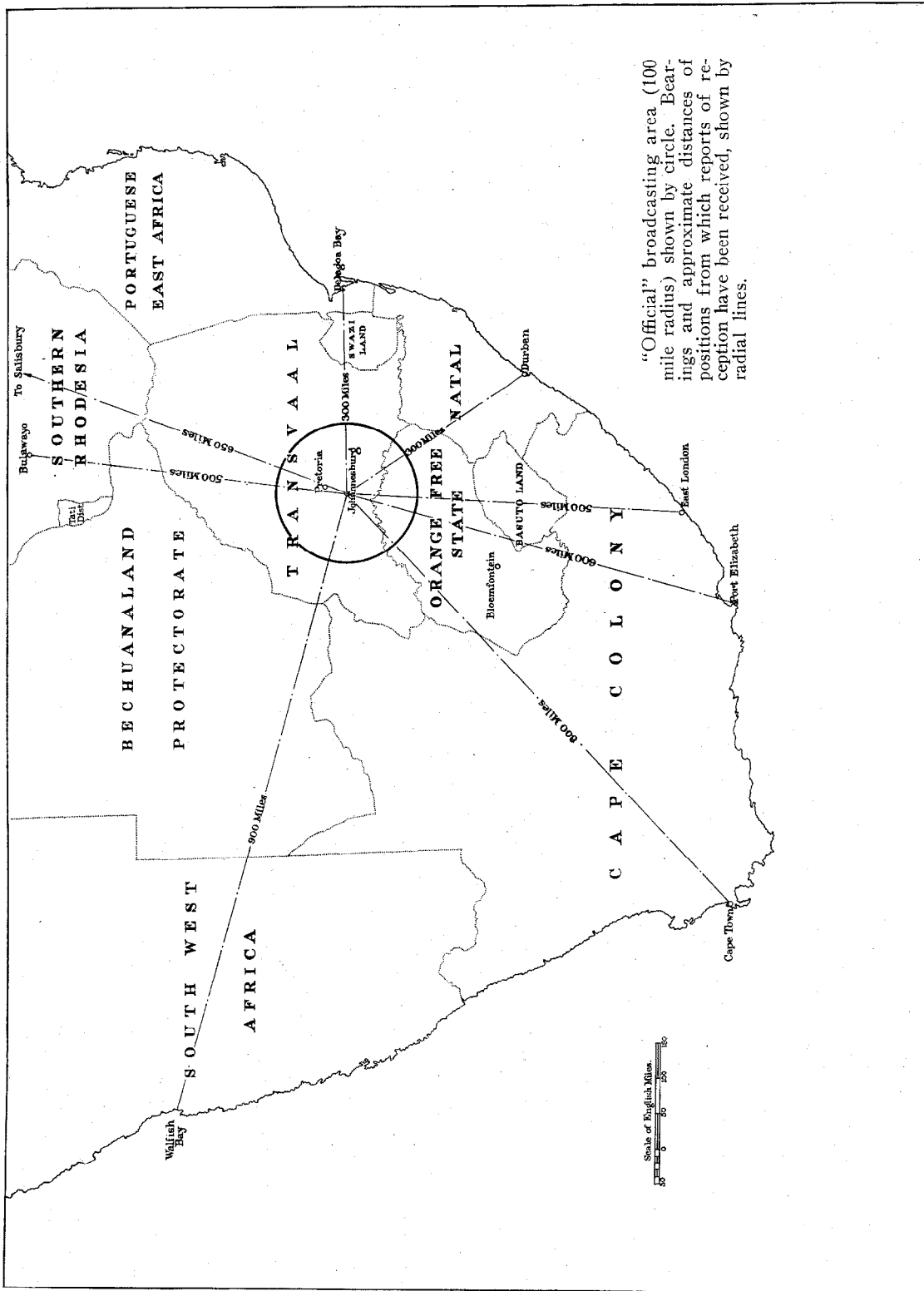

Figure 1—Radio Broadcasting in South Africa

equipment. They then formed themselves into a limited liability company under the title of "The Associated Scientific and Technical Broadcasting Company, Limited." The erection of the equipment was completed on Sunday, June 2, 1924, the first test being carried out on the following day. The station was officially opened

on July 1, 1924, by the Minister for Posts and Telegraphs; the Administrators for the Transvaal and the Orange Free State, and other distinguished South Africans being present. The opening proved extremely successful, the station receiving reports and congratulations from all parts of the Union of South Africa and Rhodesia.

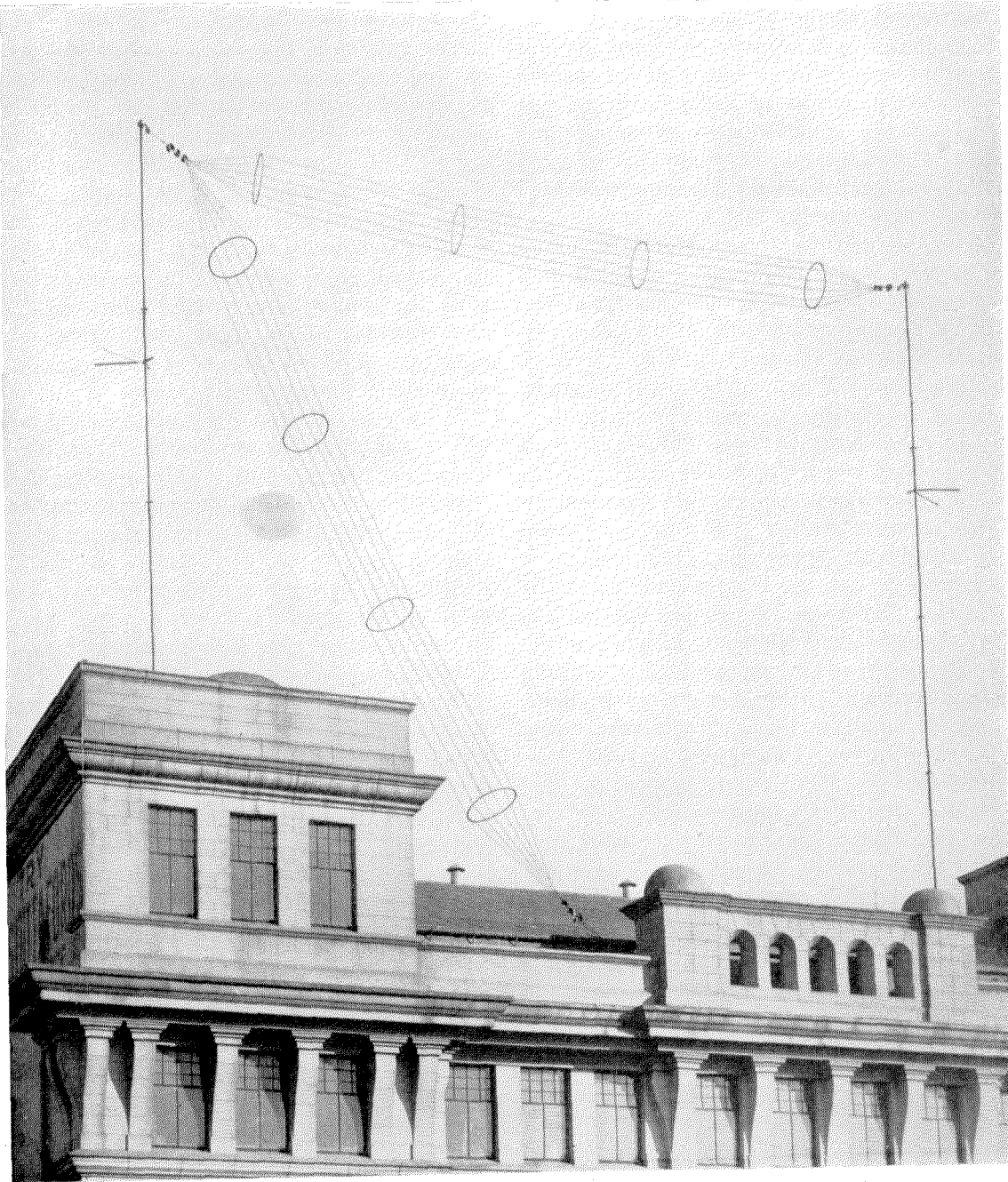

Figure 2—Radio Broadcasting Station Johannesburg—Aerial

From July 1 onwards, a regular broadcasting service has been maintained. Transmission commences at noon and is continued until 11 P.M., daily, with the usual intervals. Some idea of the radiation efficiency of the station may be obtained from the map (Figure 1) on which is indicated a number of remote points from which reports on reception have been received.

The success of the broadcasting scheme in Johannesburg can be appreciated from the fact that within two or three weeks from the opening of the station, stocks of radio receiving sets throughout the country were practically exhausted, although traders had anticipated a big demand and had obtained what they considered to be adequate supplies.

As the broadcasting equipment is identical with that installed at Birmingham for the British Broadcasting Company, as described by Mr. A. E. Thompson in his article on the "Birmingham Broadcasting Station" in Vol. 2, No. 3, January, 1924, of *ELECTRICAL COMMUNICATION*, it is unnecessary here to describe it in detail.

At Johannesburg the aerial (Figure 2) is of the cage type, consisting of six conductors of of 7-22 hard-drawn copper wire fastened to wooden hoops of section  $1\frac{1}{2}'' \times \frac{1}{2}''$  each hoop being bound with copper tape. It is erected on Stuttaford's Stores, the highest building in the town. The masts are of tubular steel of  $3\frac{1}{2}$  inches diameter diminishing to 2 inches at the top. The height of the masts is 80 feet, and the span between the antenna insulators is about 70 feet, the length of the vertical portion being of the same order. Under normal conditions, the antenna current is 10.4 to 12 amperes. The corrugated iron roof, approximately 140 feet above the street, is used as earth, copper conductors being run to various points over the roof to ensure good electrical connection. The transmitting-room is in the tower of the build-

ing seen on the left-hand side in Figure 2. This room has a floor area of approximately 20 feet square and a height of about 15 feet. Power supply is taken directly from two feeders of the municipal mains, thus providing an alternative. The leads are brought up to main switches in the transmitting room. The lead to the power panel is taken from a change-over switch and through over-load devices.

The Studio is five stories below the transmitting room, and is about 20 feet by 35 feet. On the terminal board is provided a double-pole switch, one side of which is in the microphone circuit, the other side being in circuit with a number of warning lights and signs, so that when the transmitter is put "on the air" these warning signals are displayed. In the middle of the board is a telephone in communication with the transmitting room, manager's office and reception room. The microphone transmitter is mounted on an arm movable in a vertical and horizontal direction.

It is possible that the broadcasting areas will be extended—in the case of Johannesburg, to include the whole of the Transvaal and the Orange Free State, Durban to include the whole of Natal, and Capetown to include most of Cape Colony.

Although the station at Johannesburg has only been in operation for a few months, there is already evidence that it is greatly appreciated. This is proved by the large numbers of letters received from miners, farmers and others often located at great distances from towns within the area. The special value to farmers is that market prices are transmitted to them every day, thus improving their trading position in negotiations with dealers. The cafes and tea-rooms and other refreshment establishments in Johannesburg have quickly availed themselves of the facility for entertaining their customers.

# Some Considerations Regarding Rural Telephony in the United Kingdom

By E. S. BYNG

*European Engineering Department, International Western Electric Company*

THE tardy development of the telephone in the United Kingdom has been, and is still, a matter of frequent comment. Many reasons have been advanced for the more rapid progress achieved in certain other European countries, and notably in America. A study of the telephone statistics for some of the more highly developed European countries—for example, Scandinavia and particularly Denmark—shows that considerable attention has been devoted for many years to the establishment of a satisfactory rural telephone service. On the other hand, in countries where the total telephone density is low, the need for telephone service in the rural districts has not yet been fully recognized, and the development has been confined mainly to towns. This suggests the possibility that the development of rural telephony is very closely associated with telephone progress generally.

Rural telephone service in America has been very highly developed. Farmers there consider that the telephone is essential to their business. Indeed, it might be truly stated that every well-to-do farmer has a telephone; and this has contributed in a large measure to the great development attained in rural districts. The telephone has certainly placed American farm life on a high plane of efficiency. Produce can be marketed on a new basis, and direct communication by telephone between scattered homesteads is so facilitated that the isolation and loneliness associated with country life have been largely removed. It must also be recognized that modern facilities for transport provided by the motor car have exerted a powerful influence on American conditions. It has to some extent, perhaps, counteracted the tendency of population to concentrate in cities. Those who own cars no longer find it compulsory to live in cities, or even in close proximity to a railway station. This spreading of the population has, in turn, accentuated the need for

efficient telephone service in outlying residential districts.

That which has already occurred in America is likely to take place in Europe. In fact, as already mentioned, in some European countries the same trend is apparent. Notwithstanding the progress achieved, however, the provision of telephone service in remote country districts, at a tariff which will appeal to the general public, is still a problem for which the right solution has to be found.

Numerous and more or less spasmodic attempts have been made to open up the rural telephone-service in Great Britain. During the regime of the National Telephone Company, on account of the short license under which that Company was operating, it was impracticable to develop the telephone except where there was a distinct prospect of avoiding financial loss, and accordingly the telephone did not penetrate very far into rural districts. When, in 1902, the Post Office entered the telephone field, attention was devoted to the opening up of country districts, but the limitations of its telephone system restricted its operations in this respect. It was not until after the transfer of the Company's system to the State in 1912 that conditions became favorable, and a comprehensive effort was made to stimulate the growth of rural telephony. Definite progress was made and some 450 rural exchanges were opened in 1913-1914. Unfortunately the war intervened, and nothing more could be done until after the Armistice. High costs then hindered operations in rural districts, and, in addition, the engineers were busy clearing up arrears of construction in profitable areas. Consequently it was not until 1921-1922 that there were visible signs of accelerated telephone development in the rural field.

Notwithstanding the acute after-war trade depression and the introduction of higher charges for telephone service (including a universal



message rate system) the rate of telephone development in the United Kingdom has increased since 1919. During the year 1923, when trade was at an exceptionally low ebb, the number of stations increased from 1,033,497 (1-31-23) to 1,135,226 (1-31-24)—an increase of 101,729, or approximately 10%. It is safe to say that more than half of this development was represented by residential connections, and a large proportion of these was undoubtedly in rural districts. The percentage growth in rural exchange lines was approximately 20% as compared with 8% for urban lines.

As this development occurred when trade generally was bad, it must be regarded as a good omen of the progress which may be achieved when improved facilities for telephone communication are provided, particularly in rural districts.

The number of exchanges in a country furnishes some indication as to the density of the telephone development. An exchange may serve 10 or 10,000 subscribers, therefore it is necessary to consider the total population, the number of exchanges, the number of telephones and the total area covered, in order to form an opinion as to whether the system is widely spread over the country and to determine whether the smaller and less profitable districts are not being neglected.

The cost of providing efficient telephone service in sparsely populated districts, where subscribers are invariably scattered, is necessarily higher than in urban or industrial centres, owing largely to the cost of distribution being greater. Public utility services such as water, gas, and electricity supply are frequently absent in rural districts, but even when such services are available they must necessarily cost more than in thickly populated districts, owing to the smaller demand and the heavier distribution costs.

So far as the telephone service is concerned, however, the question is one of policy. It may be argued that the telephone service is a public one, and that the more subscribers there are the more valuable and better the service becomes, as one party is dependent upon another being a telephone subscriber before he can communicate with him. In this connection telephone service may be distinguished from other

utility services, firstly because the system is entirely under the control of one authority and secondly because it is a service in which co-operation must exist. It requires one to initiate, and another to answer a call. Because the value of telephone service to the individual depends upon the number of other individuals connected to the System, and because the advantages resulting from the introduction of telephone service in rural areas are shared by subscribers to the System in other parts, it would seem that the tariff for service in rural areas should be made with reference to the tariff applying in the urban districts. In other words, since the addition of rural service creates an additional value to the System, it may be argued that to secure this additional value the tariff for rural service should be so adjusted with relation to the tariff for urban service as to foster an increase in the number of telephones in rural districts.

The cost of providing rural telephone service includes:

<i>Capital Costs.</i>	Exchange Equipment.
	Subscribers' Instruments.
	Subscribers' Lines.
	Junction Lines.
<i>Running Costs.</i>	Administration.
	Interest on capital expenditure.
	Depreciation.
	Maintenance of Plant.
	Operation and Accommodation.

Among these costs, those of operation and those associated with the provision of the essential line plant are perhaps of greater relative weight in regard to rural than to urban telephone service. They will, therefore, receive more specific attention.

#### 1.—*Manual Exchanges*

The provision of suitable accommodation and efficient operation for small manual exchanges presents serious difficulties in rural places. Premises suitable for a telephone exchange are rare, and the construction of a building specially for the purpose of housing the necessary plant is generally out of the question, owing to the high cost involved. Consequently, in many

British villages, telephone exchanges are accommodated in buildings and under conditions which make an efficient service almost impossible. Maintenance is apt to be costly, depreciation of plant is aggravated, and faults are liable to occur with abnormal frequency.

Operation is another serious problem. Suitable operators are difficult to procure; their training is costly and provision for continuity of service is expensive. Service which is at all comparable with that rendered at exchanges where unremitting attention is given at the switchboard is hardly feasible, inasmuch as the calling rate is usually comparatively low and permanent attention before the switchboard is, therefore, not justified. Night service is another difficulty. In large exchanges night service is a fairly constant quantity and deserves continuous attention. In rural exchanges night calls are few and far between; sometimes night after night passing without any calls whatever being received. Hence, where 24-hour day service is attempted, it is usual to rely upon night calling arrangements by which the operator is roused when a subscriber calls.

All these disabilities are associated with small manually operated rural exchanges, and various expedients have been considered to overcome them. In many cases switchboards are commonly installed in local Post Offices or Sub-Post Offices; then only a portion of the cost for rent, etc., is properly chargeable to the telephone service. Operating has frequently to be done by someone who has also many other duties, but this does not tend to efficiency. When local night service is not provided, arrangements are sometimes made for subscribers to pass emergency calls at night by connecting some eight subscribers through a junction line (on a party line principle) to a neighboring exchange where night service is given.

In Denmark an interesting arrangement for working small exchanges has been adopted. The requisite accommodation is provided by a local inhabitant who also undertakes the operating in return for a small fixed income, and a supplement on each subscriber. Although this arrangement has worked with a certain measure of success and has contributed to the accelerated progress made by Danish rural telephony, it has its disadvantages. The late National Telephone

Company opened a certain number of rural exchanges in Great Britain on the basis of paying the attendant £1 per line per annum for the accommodation of the equipment and the operating, but it was found impossible to carry on this arrangement, owing largely to the uncertainty of tenure. The attendant either required better terms or removed elsewhere; consequently it frequently became necessary to transfer the exchange plant to another location—always a costly operation.

For manually operated exchanges these questions have always to be considered. In consequence competent authorities in many countries are now endeavoring to replace manual by automatic switching methods in small rural exchanges.

## 2.—Automatic Systems

The introduction of rural automatic equipments presents many attractive features. As rural automatic exchanges carry no telephone operators' charges, it may be possible to provide them on a somewhat more liberal basis than in the case of manual equipments, in spite of the higher capital cost and annual charges involved. The length of individual subscriber's line will be reduced by the provision of automatic equipment situated at convenient switching centres; and as the calling rate of such lines is relatively low, a minimum number of junction circuits is required between the rural exchanges and the nearest central office.

With such an arrangement all local calls and calls to adjacent automatic rural exchanges may be effected without the intervention of an operator. Calls to the nearest central switching office or beyond (as in the case of long distance service) may be directed over junction circuits and thereafter handled manually.

In the case of isolated rural equipments, where a small percentage only of the calls is local, it may be unnecessary to provide subscribers with dials, as the action of removing the telephone from the hook can be arranged to call the operator at the nearest central office. If a local rural call is desired the operator completes the connection over a second junction line to the rural equipment, and in so doing releases the two junctions, leaving the call set up in the

rural equipment. All other calls, representing the major quantity, will be handled in the regular manner by the operator at the central office.

One of the principal difficulties met with in the design of rural automatic exchanges is the absence of electricity supply. Where such is the case the battery provided may be connected over a free junction circuit in parallel with the battery at the nearest central office, the necessary means for the automatic regulation of the voltage at the rural equipment being provided. Where local means of charging are possible the capacity of the battery should be sufficient to guarantee the service during the time—usually one week—which elapses between two successive visits of the maintenance man.

Faults occurring between visits may be signalled automatically to the nearest central office, the alarm signals being so arranged that the nature of the trouble is indicated at the controlling centre; appropriate action may then be taken.

One great advantage of automatic equipment for rural purposes is that it can be installed in a small lock-up building similar to those used for housing transformer sub-stations, requiring neither light, heat, nor permanent attendance.

### 3.—*Subscribers' Line Plant*

Constant endeavors are being made to reduce the cost of subscribers' line plant in small exchanges as well as in large ones. In small village exchanges of from, say, 10 to 30 or 40 lines overhead plant is almost invariably employed. Efforts to cheapen overhead line costs must be exercised with extreme care, or the service may be very seriously degraded by faults and interruptions which would have been avoided by more substantial construction.

It is possible that the limit to which material economies can safely be effected in overhead line construction has already been reached. There are, however, certain ways in which line costs in country districts might perhaps be lowered without introducing serious risks. Some economies which readily suggest themselves are:

- (a) The use of lighter and shorter timber for poles.

- (b) The substitution of steel "H" or "angle" section joists for poles.
- (c) The introduction of longer lengths for spans.
- (d) The omission of pole steps, pole roofs and earth wires.
- (e) The substitution of iron brackets for arms.
- (f) The omission of stays, or the use of patent types of stay rod; and the adoption of single wire instead of stranded wire.
- (g) The substitution of 60 lb. galvanized iron or copper clad steel wire for bronze.
- (h) The greater use of aerial cable (with a suitable type of terminal) for small subscribers' routes.
- (i) The adoption of covered drop wire for the last span, involving a simpler bracket arrangement at the subscribers' premises.
- (j) The joint use of electric supply poles.
- (k) The greater use of labor-saving appliances in erecting the plant.

It might be mentioned that the Post Office has recently been investigating the properties of a copper-cadmium alloy wire, and trial on a large scale is now in progress. The mechanical properties are equal to that of bronze wire, but the conductivity is very much higher, consequently it may be possible to effect some economy in using 40 lb. wire of this alloy for long subscribers and junction circuits, instead of the heavier gauge which would otherwise be necessary.

Suggested modifications in line plant construction introduced to reduce cost should be very carefully examined to ensure that the attempt to economize in construction does not seriously augment the annual charges by earlier renewals and an increase in faults, followed by heavier maintenance charges.

It has been found advantageous to supply motor cycles to linemen to assist them in the clearance of line troubles. The cost per fault may by this means be reduced, and the average duration may be shortened. In course of time it may be found economical to substitute two-seater box cars for motor cycles. Each lineman could then carry a complete kit of tools, and, in addition, an extensible ladder, which may be a great asset in country work.

#### 4.—*Exclusive Line Versus Party Line in Rural Districts*

The British Post Office is willing to entertain applications for telephone service at a special rate of £8 a year in rural areas where a minimum of eight new subscribers is situated within  $1\frac{1}{2}$  miles of a position convenient for an exchange. A certain minimum number of subscribers is, however, necessary before the establishment of an exchange becomes a remunerative proposition. Consequently the number of rural subscribers to be provided for at the outset and for the first few years is of considerable importance.

Beyond the  $1\frac{1}{2}$  mile distance a pro rata charge, depending upon the extra mileage involved, is made. Notwithstanding all possible economies in line plant, this extra charge, unless kept down to the minimum, may make rural telephony a luxury. At the same time it could be claimed that the greater the distance a subscriber lives from his neighbors, the more useful should his telephone become. It cannot, however, be expected that a telephone administration will exceed certain limits in serving an isolated applicant, especially when it is unlikely that the poles carrying his line will be utilized for subsequent subscribers, or as a junction circuit to a prospective rural exchange. Nevertheless it might be mentioned that in some Scandinavian countries the tariff is now independent of the length of line. Originally there was a charge for extra mileage, but it was recognized as an obstacle to development in country areas and was eventually abolished.

One method adopted in Great Britain for meeting this difficulty has been the establishment of "farmers lines" or "rural party lines". Where there is a sufficient number of applicants within a reasonable distance of one another, telephone facilities may be provided at a fixed charge of £4 per year with an unlimited number of local calls. In some cases this rate is insufficient to cover the working expenses of such lines, but the national importance of telephone service in agricultural communities is considered to justify the arrangement.

A rural party line is usually arranged for 10 to 12 subscribers, and a system of code-ringing is, therefore, employed. There are other types of

party line in vogue, the most common being the 2 or 4 party line, where each party can be called without disturbing the others. Some people are unwilling to share a telephone line with others, although the rental may be less; nevertheless the party line has an educational value, inasmuch as by its means the public is enabled to experience the value of telephone service. Party line facilities, therefore, may assist development in areas which perhaps could not otherwise be reached.

#### 5.—*Rural Call Offices*

The growth of rural call offices has been very rapid since the transfer of the telephone system to the Post Office in 1912. One of the first steps was to use some of the rural telegraph circuits working to the towns where a telephone exchange had been established. Where this conversion was effected telegrams were called through by telephone to nearby centres. In this way one circuit could be used for two purposes at little additional cost.

Between January, 1912, and August, 1914, over 1,000 rural call offices were brought into operation. At the present time there are some 5,500 call offices installed in telegraph offices and other places in rural districts, and the demand for these is still increasing. It is now the policy of the Post Office to open call offices wherever there is a reasonable demand and the cost will not be excessive. There is much educational value in extending the use of call offices, as they tend to popularize the telephone habit.

Mention should be made of a practice which has been highly successful in certain rural parts of America and also in some European countries. Leading citizens assumed the responsibility for local telephone development by forming joint stock companies, mutual telephone corporations, or co-operative societies. Each prospective telephone subscriber in the community took up at least one share in the company, which arranged either to construct its own lines and build its own exchange, or arranged with the telephone company to do so on agreed terms. The advantage of this method lay in the inducement to make local collective effort for the purpose of raising the number of subscribers quickly to a remunerative level. This intensive co-operative enter-

prise on the part of the public has been instrumental in bringing about the exceptional development of the telephone in the rural parts of the countries concerned.

Vigorous and sustained educational and propa-

ganda work, combined with a progressive policy, would do much to overcome the conservatism and prejudice so often displayed towards the telephone by the residents in rural districts in Great Britain.

---

# The Testing of Long Distance Telephone Cable During Installation

By W. E. MOUGEY

*European Engineering Department, International Western Electric Company*

IN view of the large amount of long distance telephone cable construction which must be undertaken in Europe in the next few years a description of the developments which have taken place in regard to the testing of telephone cables during their installation may be of interest. This description applies particularly to the methods which have been developed by the Western Electric Company and the American Telephone and Telegraph Company for the installation of loading sections of cable. The testing of loading coils during installation and the tests and requirements for completed cable systems form a wider subject which is not dealt with in this article.

The earliest telephone cables were composed of insulated conductors used as single wire grounded lines. As the lengths of cable increased, troubles from induction between the different conductors and from external sources became more serious and various methods were used in attempts to overcome these defects. Amongst the types developed were so called anti-induction cables in which each insulated conductor was surrounded with a thin metal covering.

The first important step in the design of telephone cables to avoid interference between the telephone circuits in the cable and induction from other electrical circuits was the use of all metallic circuits in place of single wire lines with ground return. By the year 1887 the use of lead covered telephone cable with twisted pairs had become the general practice.

The next development in regard to the reduction of crosstalk in lead covered telephone cable followed on the experimental work performed by Mr. J. J. Carty in New York, in 1889, in investigating the causes of crosstalk between telephone circuits. An account of this experimental work is given in the *Electrical World* for March 28th, 1891. As a result of this work Mr. Carty patented in 1890 (U. S. Patent No. 442856) among other methods, a method whereby

condensers could be connected at frequent intervals between wires of two circuits in order to balance the capacities between the wires of one circuit and the wires of the other circuit. It is interesting to note that at this early period efforts to reduce crosstalk in circuits in cables and in open wire lines made use of balancing condensers as well as other means of adjusting the capacities between these circuits.

The first commercial work of which we have record, where the crosstalk was eliminated from underground telephone cables, was in connection with the first cables drawn into the new Tremont Exchange, in Boston in 1893 and 1894. This work was performed by Mr. R. F. Hall of the Western Electric Company and followed the balancing condenser method specified in the Carty Patent. The balancing condensers, which consisted of short lengths of rubber insulated wire twisted into pairs, were joined between one wire of one circuit and one wire of the other circuit between which the crosstalk was to be eliminated. This method of balancing circuits in an ordinary paired cable by special tests during installation and by the addition of balancing condensers of suitable values was not carried further, as it was found that by improvements in manufacture the crosstalk was low enough to be satisfactory even when the cable was loaded.

By 1903, Bell Telephone engineers had devised a bridge for measuring the capacity unbalance between two circuits. The use of this bridge enabled a study to be made of the effect of different manufacturing methods on the capacity unbalances between paired circuits and as a result of this study the crosstalk in the more important cables was kept down to low values.

Pupin loading coils were first used commercially on cable circuits in 1900 and by the year 1906 this development had been carried so far that an underground loaded telephone cable composed of No. 14 and No. 16 B. & S. gauge conductors (1.63 mm and 1.29 mm), twisted into pairs, was working satisfactorily between New

York and Philadelphia a distance of about 90 miles (145 Kms.).

This development in the loading of cable circuits enabled cable to be used for much greater distances than formerly and this increased the demand for long distance toll cable. It was necessary, however, to hold the capacity unbalances between circuits to lower limits as with loaded telephone circuits any unbalances present in the cable were much more effective in producing crosstalk.

The next big development in long distance cable was in connection with the phantom circuit. By the use of the phantom principle it was possible to obtain three circuits from four wires and thus effect a great economy in the cost of long distance toll cable. This development required a change in the construction of telephone cables, two pair circuits being combined together to form a unit of four wires which is called a quad.

Experiments with quadded construction were conducted as early as 1889, and continued spasmodically until 1908, when it was realized that a comprehensive study should be begun. Some experimental work was done with the spiral four, which consists of four wires laid together and twisted, the wires diagonally opposite being used as pairs. This type of construction, which is still used for four-core gutta percha insulated submarine cable, did not seem as advantageous for paper insulated cable as the multiple twin construction, and intensive development work was decided upon for the multiple twin construction.

The multiple twin type of construction is that in which two pairs, each of which has a different twist, are laid together with a third length of twist to form a quad. Quads so formed are stranded together to form a cable.

The first successful loaded quadded telephone cable in which phantoms were obtained was manufactured at Hawthorne, Chicago, by the Western Electric Company in 1910. It was laid between Boston and Neponset, a distance of about 6 miles (10 Km.). In the following year the manufacture and installation of a loaded toll cable to extend ultimately between Washington and Boston, a distance of about 455 miles (730 Kms.), was commenced. The results on the Boston-Neponset Cable showed that on in-

dividual manufactured lengths, the capacity unbalances between circuits in different quads could be kept down to reasonably low values by the use of proper twists and by careful manufacture. Also in loading sections these unbalances could be kept to suitable values by mixing the quads at each joint so that any two quads were adjacent for as small a distance as possible. The unbalances between the three circuits within the quad, however, were high enough to have made the crosstalk on the finished cable troublesome except for special corrective measures which were taken during installation. The worst crosstalk was between the phantom and the competent side circuits, although the crosstalk between the two side circuits was also high enough to be objectionable. It is obvious that the unbalances between circuits within a quad are more serious from a crosstalk standpoint than the unbalances between circuits in adjacent quads, because the former type of unbalance is between circuits which are always adjacent throughout the whole length of the cable, while the latter type of unbalance is between circuits which can easily be separated for the greater part of the distance.

Experimental work on the Boston-Neponset Cable showed that the method of crossing conductors at splices could be applied in connection with capacity unbalance tests to reduce unbalances between circuits within the quad in a loading section length. This method of reducing the three unbalances in a quad is described in U. S. Patent No. 1064433 issued to Blackwell and Anderegg in 1913. With certain improvements and refinements, it has been able to meet the increasing severity of the requirements imposed by the increasing length of the cable circuits, and by the use of vacuum tube repeaters. It is the standard procedure of the Western Electric Company in all their long distance toll cable installations in all parts of the world.

#### REQUIREMENTS FOR A LOADING SECTION

Before beginning a detailed description of the method itself, it may be well to consider the electrical qualities which are desirable in a loading section in order that it shall form part of a complete loaded cable system giving a high quality of telephonic transmission over a long distance.

(1) The capacity unbalance between any two circuits in a loading section should be kept to a suitable low value in order to render the crosstalk in the finished cable system satisfactory. The following values which represent good practice are regularly obtained by the Western Electric Company in their installation work both in America and in Europe.

<i>Unbalance Between Circuits in the Same Quad</i>	<i>How Reduced During Installation</i>	<i>Allowable Average Values Which Represent Good Practice in Normal Cases and Where 4-Wire Circuits Are Not Used</i>
Phantom-to-Side Side-to-Side	By Test Splicing By Test Splicing	20 m.m.f. 15 m.m.f.
<i>Unbalance Between Circuits Not in the Same Quad</i>		
Phantom-to-Phantom	By mixing quads at each splice	40 m.m.f.
Phantom-to-Pair	By mixing quads at each splice	30 m.m.f.
Pair-to-Pair	By mixing quads at each splice	20 m.m.f.

In cables in which 4-wire circuits are used the unbalances between opposite-going 4-wire circuits and between 4-wire and 2-wire circuits must be limited to lower values.

(2) A circuit should have within certain limits the same mutual capacity in each loading section of a repeater section. This requirement is to permit the construction of a balancing network, for use at the repeater station, which will have the same impedance as the circuit with which it is used (and, therefore, closely balance this circuit) at all essential frequencies. If the capacity of a circuit is not uniform between successive loading sections, its impedance will vary irregularly with different frequencies, and it will become impossible to construct, at a reasonable cost, a balancing network which will have the same impedance as the line at all essential frequencies. If, however, the cable is well constructed, and installed with the necessary precautions, no trouble should be experienced from this source.

(3) If each circuit in a repeater section were to have a materially different average mutual capacity, a different balancing network would be required in each case. This would render the costs of the balancing networks excessive and would reduce the flexibility of the system; and on this account it is highly desirable that all circuits of a group in a repeater section should have as nearly as possible the same average capacity.

(4) If there is danger of severe interference from electrified traction lines or other electrical circuits carrying heavy currents, it may be helpful to balance the two legs of every circuit, both side and phantom, with respect to ground, the closeness of balance required depending upon the severity of the exposure.

(5) If the two wires of a pair differ considerably in resistance, crosstalk between the phantom and side circuit would be thereby caused and on this account the resistance unbalance of the two legs of every circuit should be limited to suitably low values in every loading section. The following values represent good practice.

Average resistance unbalance per loading section 0.15%.

Maximum resistance unbalance per loading section 0.5%.

(6) For maintenance purposes the insulation resistance of each conductor in the cable should be high.

(7) Each circuit should have the average A. C. mutual capacity and ohmic resistance for which the system is designed.

It will be seen from the above that a loading section has to fulfill a number of severe electrical requirements, and if corrective measurements had to be applied during installation to secure the balance of resistance and mutual capacity required as well as to correct crosstalk the complication and the cost of installation would be very considerably increased. Happily this usually is not the case, and with well manufactured lengths the necessary balance of resistance and the uniformity of mutual capacity can ordinarily be obtained with no tests in the field. Also be-



tween circuits in one quad and circuits in other quads, with well designed and manufactured lengths of cable, the capacity unbalances will not be sufficiently large to cause undesirable crosstalk if the quads are suitably mixed at every

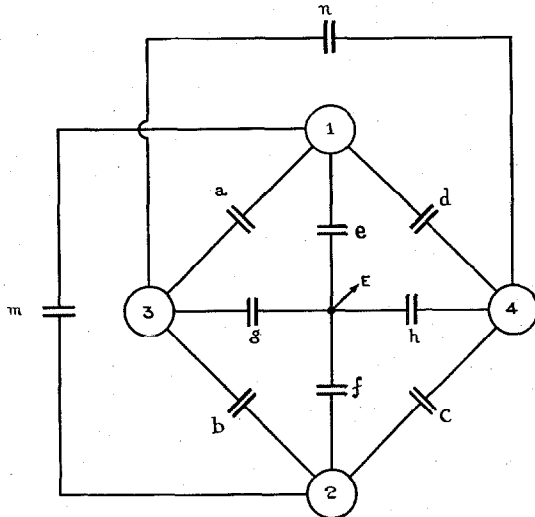

Figure 1

splice so that two quads which are adjacent on one side of the splice are not adjacent on the other side. If the quads are not mixed in this manner the cumulative effects of the juxtaposition of the same quads in successive sections is likely to lead to serious crosstalk between circuits in the two quads, particularly if the circuits are used in long repeatered lines.

The chief electrical testing during the installation, therefore, has to do with the reduction of capacity unbalance between the circuits within a quad; that is, between the phantom and each of its side circuits as well as between the side circuits. These capacity unbalances are reduced in the factory during manufacture and in the field by tests during jointing so that individual lengths of cable with low unbalances are connected together in such a manner that the desired degree of balance per loading section is obtained.

It is necessary to emphasize the importance of using only well balanced individual lengths of cable in a long distance telephone cable system. It is possible by special attention to testing and correcting methods during installation to make use of lengths which are themselves badly balanced and yet to obtain a finished cable which

will be initially fairly satisfactory. In such a cable system, however, the initial results obtained may not be permanent and the cost of maintenance will be high since the replacement of a length will in general require the rebalancing of the entire loading section, which is not necessary if the cable is well made in the beginning.

#### TYPES OF UNBALANCE

It now becomes necessary to define what is meant by the term capacity unbalance both between two physical or side circuits and between a phantom and one of its side circuits.

Side-to-Side unbalance or the unbalance between two physical circuits may be defined as that capacity which must be added or subtracted as the case may be, between one conductor of one circuit and one conductor of the other circuit in order to reduce the crosstalk between the two circuits to zero or in other words to produce balance between the two circuits. This is illustrated in figure (2) where a tone is applied to one pair (1, 2) and a receiver applied to the other pair (3, 4). In this case the side-to-side unbal-

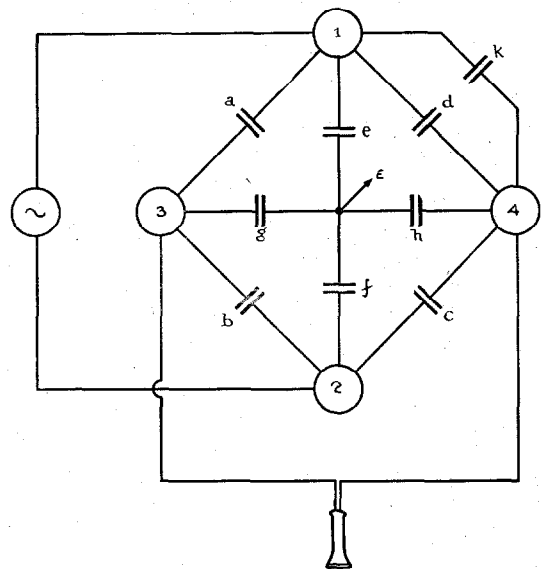

Figure 2

ance is equal to the capacity of the balancing condenser  $k$  which produces silence in the receiver. It is obvious that the value of side-to-side unbalance thus defined is liable to vary according to the conductors between which the balancing capacity is added or subtracted. Four

different values of unbalance are possible according to the above definition but for ordinarily well balanced cable in usual manufacturing lengths or in loading section lengths the differ-

If the capacities between the wires are large and their differences are small this expression simplifies to the following value as  $\frac{c}{b}$  approaches unity.

$$\text{Side-to-Side Unbalance} = (a+c) - (b+d)$$

This expression is usually employed for side-to-side unbalance.

The capacity unbalance between a phantom and one of its side circuits is defined as that capacity which must be added or subtracted, as the case may be, between either wire of the side circuit and the cable sheath in order to reduce the crosstalk between the phantom circuit and side circuit to zero. This is illustrated in Figure (5) where  $k$  is the balancing capacity which must be added between wire 2 and the cable sheath in order to produce balance, or in other words to reduce the crosstalk between the phantom (1, 2—3, 4) and the side circuit (1, 2) to zero.

It may be noted here that as defined above for both side-to-side unbalance and phantom-to-side unbalance, the capacity unbalance is subjected to approximately one-half the voltage of the disturbing circuit, and, therefore, the two definitions are comparable and other things being equal a unit of side-to-side unbalance will produce the same crosstalk as a unit of phantom-to-side unbalance.

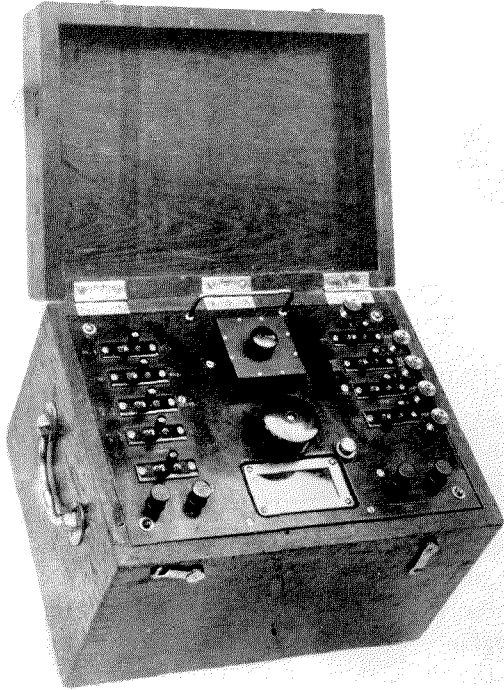

Figure 3

ences between the four possible values are negligible.

The bridge used for measuring the unbalance between two adjacent circuits is shown in Figure (3) and the diagram of this bridge is shown in Figure (4). As indicated in this diagram the rotating air condenser is so arranged that capacity is taken out of one arm of the bridge and transferred to the adjacent arm. The rotating condenser is calibrated, however, so that it reads the same value as if it varied capacity in one arm only of the bridge.

The expression for unbalance between two side circuits can be derived in a simple manner from the above definition; as the capacities to ground can practically be neglected the expression for the side-to-side unbalance as shown in Figure (2) is very accurately:

$$\text{Side-to-Side Unbalance} = k = \frac{c}{b}(a-b) + (c-d)$$

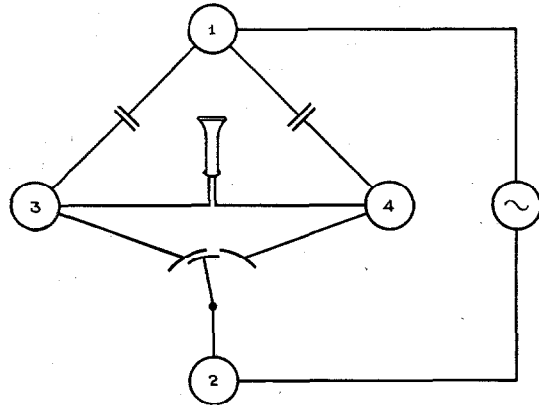

Figure 4

The same bridge is used for measuring phantom-to-side unbalance as that shown in Figure (3) for measuring side-to-side unbalance, the connections being changed by appropriate switches. The diagram of the unbalance bridge when used

for measuring phantom-to-side unbalance is shown in Figure (6). In this diagram it will be noticed that, as in the case of the bridge when arranged for side-to-side unbalance, the rotating air condenser takes the capacity out of one arm of the bridge and transfers it to the other arm; but it is calibrated to read the same values as if it

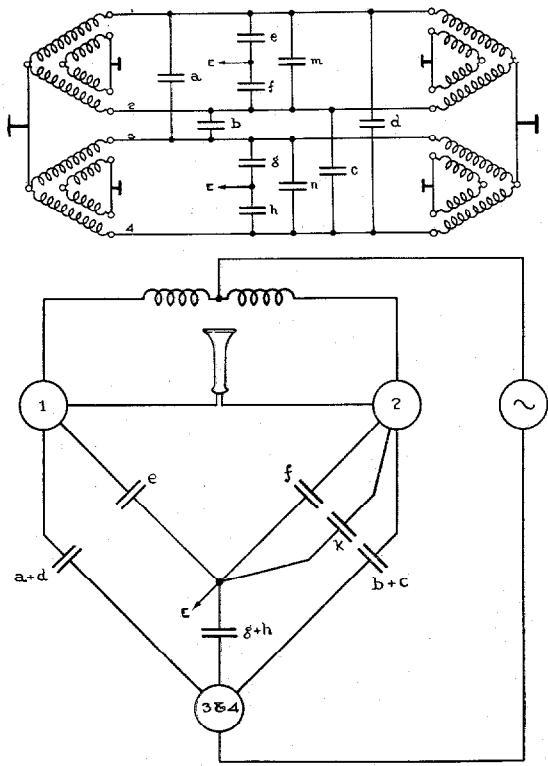

Figure 5

added or subtracted capacity from one side of the bridge only. It is evident that in the position which the rotating air condenser occupies for measuring phantom-to-side unbalance it has twice the effect of a condenser placed between ground and one wire of the side circuit whose unbalance to the phantom circuit is being measured. The readings on this unbalance bridge have, therefore, to be multiplied by two in order to obtain the true phantom-to-side unbalance as defined above.

The expression for the unbalance between the phantom and side 1-2 as shown in Figure (5) is:

$$2(a-b-c+d) + (e-f)$$

and the phantom-to-side unbalance between the phantom and side 3-4 is:

$$2(a+b-c-d) + (g-h)$$

These two formulæ are approximate in that their accuracy depends upon the degree to which the sum of the two direct capacities to ground of the first pair ( $e+f$ ) and the sum of the two direct capacities to ground of the second pair ( $g+h$ ) approach equality. For ordinary occasions the above formulæ are amply accurate.

It will be noted that for both side-to-side unbalance and phantom-to-side unbalance, an unbalance is measured directly with one setting of the bridge. This method of measuring unbalances directly offers considerable advantages from the standpoint of simplicity in comparison with other methods which are used in Europe and in which the unbalance must be calculated from the several bridge readings.

### REDUCTION OF UNBALANCES BY CROSS SPLICING

In the above equations for phantom-to-side and side-to-side unbalance the + and - signs are arbitrary, depending on which wires in the diagram are called No. 1 and No. 3. In the equation for side-to-side unbalance if the conductors of either pair are reversed the sign of the unbalance is likewise reversed. In the equation for the unbalance of the phantom to its side 1,

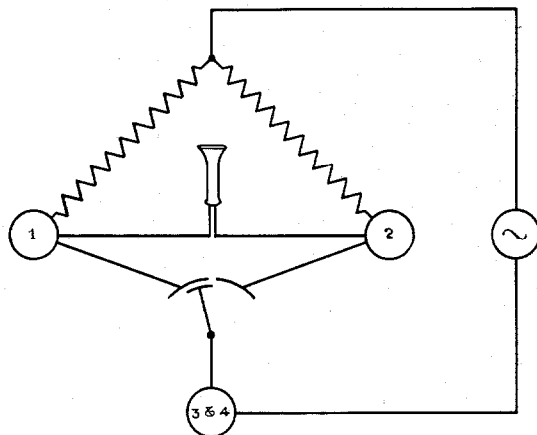

Figure 6

if the two conductors of pair (1) are interchanged the sign of the unbalance is reversed. If, therefore a quad (quad 1) in one section of cable is joined to a quad (quad 2) in an adjacent section of cable, any one of the three unbalances between the circuits in quad (2) can be made to subtract from the similar unbalance in quad (1) by joining the conductors together in an appropriate manner.

The question arises whether all three unbalances in quad (2) can be made to subtract from the similar unbalances in quad (1). A study of the equations for unbalances will show that by appropriately selecting the conductor in each pair which will be called conductor No. 1 the quads can be divided into two types. Type "A" quads are those in which the three unbalances can all be made to assume positive signs. Type "B" quads are those in which the signs of the unbalances can be reduced to two positive and one negative. If the two conductors of a pair in a type "B" quad are reversed, the signs of one of the phantom-to-side unbalances and of the side-to-side unbalance are changed so that the quad will still have two positive and one negative sign of unbalance. A type "B" quad, therefore, cannot be altered into a type "A" quad. Consideration of these two types of quads will show that in order for all three of the unbalances to subtract when two quads are joined it is necessary that a type "A" quad be joined to a type "B" quad.

In general it has been found sufficient in order to secure the desired degree of balance per loading section to make tests at three splices only. The large majority of the cables installed in America and Europe by the Western Electric Company have only had three test splices per loading section. It is sometimes necessary to make tests at seven splices, but the method is merely an extension of that used when there are three test splices.

With three test splices each loading section of cable is divided as shown below into four parts of about the same length, each of these quarter sections containing one or more manufactured lengths of cable. The usual length of a loading section is about 1830 meters and a convenient length for an average sized cable on a reel is about 230 meters, thus making eight lengths per loading section or two lengths for a quarter section. The number of lengths per loading section will vary somewhat from this average figure, depending upon local conditions.

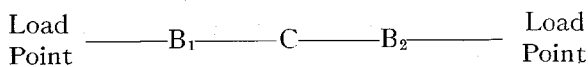

The three unbalances for each quad are measured in each direction at a "B" splice and tabulated. The tester then studies these unbal-

ances in order to determine which quad in one direction should be joined to each quad in the other direction and how the conductors in each quad should be joined in order to reduce the unbalances to the greatest extent possible. The tester usually begins with the quad which has the largest unbalance and marks it to be joined to the quad in the other direction which will give the minimum resultant unbalances. The second highest quad is then taken and the same procedure is followed until it has been decided just which quads in one direction shall be joined to the quads in the other direction and how each two quads should be connected. It is usually the practice to work on both "B" splices at the same time and in this case it is often advantageous to match unbalances at one "B" splice by values at the other "B" splice.

At the final or "C" splice the connections are made so as to reduce the unbalances to the greatest possible extent. By this means it has been found practicable on important cables to reduce the average phantom-to-side unbalance for all loading sections to 14 mmf. and the average side to side unbalance to 12 mmf. Some cables have been installed with still lower average unbalances.

It is occasionally desirable owing to special demands or to severe local conditions, as for example, the proximity of an electric traction line, to reduce other types of unbalance in the cable during test splicing in addition to phantom-to-side and side-to-side unbalance. It then becomes necessary to make more test splices per loading section in order that the new requirements can be met without increasing the phantom-to-side and side-to-side unbalances. It is usually convenient to make 7 test splices, in which case the loading section is divided into eight sections.

The four extra splices thus added are called "A" splices. It is sometimes found convenient to reduce the phantom-to-side and side-to-side unbalances to such low values by means of the "A" and "B" splices that the "C" splice can be made with little regard to the phantom-to-side and side-to-side unbalances. The other electrical unbalances such as unbalance to ground, resistance unbalances, differences in mutual capacity etc., can then be adjusted at the "C" splice. In other cases it is found more

convenient to consider the other electrical unbalances at the "A" splices only, the phantom-to-side and side-to-side unbalances being reduced at the "B" and "C" splices in the usual manner.

It is usual in test-splicing during installation to correct only the phantom-to-side and side-to-side unbalances between the circuits in a quad. As just mentioned, however, other irregularities can sometimes be corrected by cross-splicing. Amongst these may be named the following:

- (1) Differences in mutual capacity between circuits in a group.
- (2) Unbalances of side and phantom circuits to ground.
- (3) Unbalances between phantom circuits.
- (4) Resistance unbalances between conductors of side circuits.

With correctly designed and well manufactured cable it is rarely necessary to take the mutual capacities into consideration during installation. The required degree of uniformity in the mutual capacity of each circuit throughout the repeater section is usually attained by making the loading sections equal in length to each other within close limits and also making the average capacity of the loading sections equal to each other to a very narrow margin. If then the mutual capacities of the circuits in a loading section are equal to each other within close limits it is obvious that a high degree of uniformity throughout the repeater section will be attained.

In the year 1915 the American Telephone and Telegraph Company in America began the practice of reducing the differences of mutual capacity by means of so called deviation tests during the installation of the loading sections as well as reducing the ordinary unbalances. It was found that differences of mutual capacity in a loading section of both the pair and phantom circuits can be very considerably reduced. This practice was discontinued to a very large extent after a few years of experience as it was found that the cost of making the tests could not be justified by improvement effected.

The usual occasion for reducing the capacity unbalances to ground is the proximity of an electric circuit carrying a large alternating current. In order to reduce the susceptibility of

the telephone circuits to noise induced by the power circuits the two sides of each side circuit as well as each phantom circuit may be balanced to ground. It may be well to point out that if conditions demand that the side circuit be balanced to ground it is usually equally important that the phantom circuit be also balanced to ground. This process of balancing circuits to ground adds largely to the expense and complication of the installation work, and is ordinarily justified only in cases of severe exposure.

The unbalance bridge shown in Figure 3 is used to measure capacity unbalance to ground di-

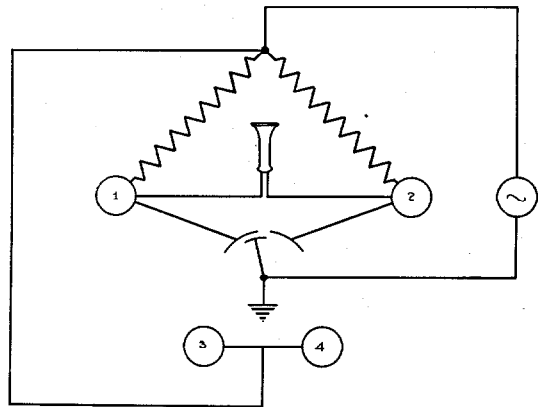

Figure 7

rectly both for the pair and phantom circuits. The circuit arrangement by which this is done is shown in Figure 7. The theory of this circuit arrangement is discussed in British Patent No. 203870, owned by the Western Electric Company.

It is not usually necessary to reduce the unbalances between the phantom circuits by special testing during installation, as these unbalances can in general be held to suitable limits by separating any two quads over as large a portion of the route as practicable. Under special circumstances, however, such for example as a cable so designed that two quads remain adjacent over the whole route, it may become necessary to make special tests to reduce the phantom to phantom unbalances. A study of the unbalance between two phantom circuits will show that the same formula holds as for side to side unbalance, a pair being taken as a conductor. It is, therefore, comparatively sim-

ple to reduce cases of high phantom-to-phantom unbalance during installation by the cross-splicing method.

If it is desired to reduce the resistance unbalances of any of the circuits during installation this can easily be done by the cross-splicing method, but in practice this is rarely necessary.

#### METHOD OF CORRECTING UNBALANCES BY ADDING CONDENSERS

It was found in America that in certain cases the crossing method of correcting capacity unbalance could not be easily applied as for instance when the cable was under water on all or the greater part of a loading section as, for example, in a river, estuary or bay crossing. In order to provide for such cases a method was devised based on the Carty patent and the theory of unbalance developed in the Blackwell and Anderegg patent, whereby the capacity unbalances were corrected by means of condensers placed at one point in the loading section. The most convenient position was usually found to be next to the loading coil. It would obviously be possible to balance the entire cable in this way; but experience has shown that the cross-splicing method, where it can be followed, is cheaper and more reliable, for the same degree of balance.

In Figure 1 the condition for no interference between two side circuits is that  $(a+c) - (b+d) = 0$  and the condition for no interference between the phantom and each side circuit is that  $2(a-b-c+d) + (e-f) = 0$  and  $2(a+b-c-d) + (g-h) = 0$ . From the above equations it will be seen that in order to correct the capacity unbalance between two side circuits it is necessary to increase either  $a+c$  or  $b+d$  as the case may be. This as shown by Mr. Carty can be done by connecting a condenser between one wire of one pair and one wire of the other pair. To correct the phantom-to-side unbalances condensers may be inserted between one wire of one pair and one wire of the other pair, as an inspection of the above formula will show, but in this position each of the 3 condensers which it would be necessary to insert would affect each of the 3 unbalances between the 3 circuits in a quad.

The preferable method and the one which is used by the Western Electric Company is to insert a condenser between one wire of the first

pair and ground, to correct the unbalance between the phantom and the first pair, and another condenser between one wire of the second pair and ground to correct the unbalance between the phantom and the second pair. An inspection of the above formulæ will show that the effect of a condenser of the proper value placed between one wire of say the first pair and ground is to increase either  $e$  or  $f$  in the formula and thus correct the unbalance between the phantom and the first pair, without interfering with the other two unbalances in the quad.

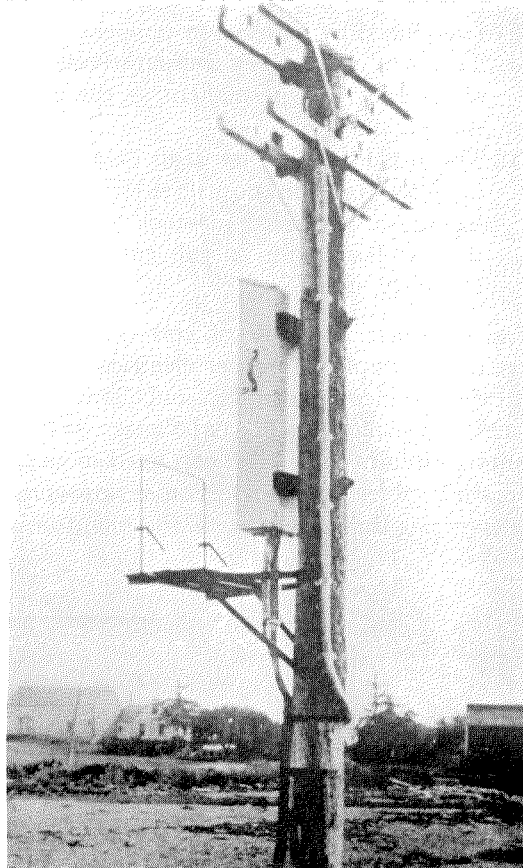

Figure 8

The first commercial application of this method was a submarine quadded cable between Eastport and Lubeck in the State of Maine, U. S. A., which was installed by the American Telephone and Telegraph Company in 1912. In order to provide the balancing condensers a short stub of small gauge cable was used. Figure 8 shows the stub cable at one end of a loading

section on this cable. The proper amount of capacity to correct any given unbalance was obtained by using a number of pairs in parallel. It was found necessary to use a grounded pair between each group of pairs used as a condenser. This type of condenser was found very suitable for this purpose for the following reasons:

- (1) Suitable steps of capacity could be obtained by choosing suitable lengths of cable stub and a suitable number of pairs.
- (2) The stub cable has the same temperature coefficient in regard to capacity as the main cable and therefore no errors are introduced by changes in temperature.
- (3) The stub cable takes comparatively little space and is as permanent as the rest of the installation.
- (4) The cable suitable for stub cable can be manufactured in comparatively long lengths and carried in stock and a convenient length for a stub cut off as the necessity arises.

The condenser method of correcting unbalances can be applied to other electrical features of a cable besides the ordinary unbalances. For example in America the unbalances between phantom circuits have been corrected in certain submarine cables by the addition of appropriate condensers at the same time as the phantom-to-

side and side-to-side unbalances were being corrected. It may be mentioned that the stub cable method of adding capacity is especially appropriate for correcting phantom-to-phantom unbalances as it is very important that balanced capacities be added between two conductors of a pair of one phantom circuit and two conductors of a pair of the other phantom circuit in order to avoid increasing the side-to-side and phantom-to-side unbalances.

It is also common practice in America to use condensers to increase the capacity of the circuits of a loading section which for some reason is shorter than the rest of the loading sections. It is of course necessary to increase to the required extent the phantom capacity as well as the side circuit capacities. This method of using condensers for obtaining uniformity of mutual capacity is described in U. S. Patent No. 1,219,760 issued in 1917 to Mills and Hoyt.

In conclusion it may be noted that all the improvements which have been made in telephone transmission such as loaded circuits, 2-wire and 4-wire repeaters, etc., have made additional demands upon the designer, manufacturer and installer of telephone cables. It is increasingly important that a cable system should be planned as a whole and that all the different interactions of the design, installing methods, and the desired final results, should be considered.

---

---

---

# *International Western Electric Company*

INCORPORATED

*Head Offices*

195 BROADWAY  
NEW YORK, U. S. A.

*European General Offices*

CONNAUGHT HOUSE  
ALDWYCH, LONDON, ENGLAND

## *Affiliated Companies*

Western Electric Company, Limited ..... *Aldwych, London, England*  
Branches: Birmingham, Cardiff, Glasgow, Leeds, Manchester, Newcastle-on-Tyne, Southampton, Dublin, Cairo, Johannesburg, Singapore.

Bell Telephone Manufacturing Company ..... *Antwerp, Belgium*  
Branches: Berne, The Hague, Brussels, Riga, Reval.

Le Materiel Telephonique ..... *Paris, France*

Telefonos Bell, S. A. .... *Madrid, Spain*

Western Electric Italiana. .... *Milan, Italy*  
Branches: Rome.

Western Electric Norsk Aktieselskap. .... *Oslo, Norway*

Vereinigte Telephon und Telegraphen Fabrik. .... *Vienna, Austria*

United Incandescent Lamps and Electrical Company, Limited  
*Budapest (Ujpest), Hungary*

Western Electric Company (Australia) Limited. .... *Sydney, Australia*  
Branches: Melbourne, Wellington.

Nippon Denki Kabushiki Kaisha. .... *Tokyo, Japan*  
Branches: Osaka, Dalny (Manchuria), Seoul (Chosen)

Sumitomo Electric Wire & Cable Works, Ltd. .... *Osaka, Japan*

China Electric Company, Limited. .... *Peking, China*  
Branches: Shanghai, Tientsin

Northern Electric Company, Limited. .... *Montreal, Canada*  
Branches: Quebec, Halifax, Toronto, London (Ontario), Hamilton, Windsor, Winnipeg, Calgary, Regina, Vancouver

Compania Western Electric Argentina. .... *Buenos Aires, Argentina*

Sales Offices and Agencies Throughout the World

To those interested in better communication the International Western Electric Company and its Affiliated Companies offer the facilities of their consulting engineering departments to aid in the solution of problems in Telephony Telegraphy and Radio.