

FILE COPY

Not to be removed from  
the offices of Electrical  
Communication.

# ELECTRICAL COMMUNICATION

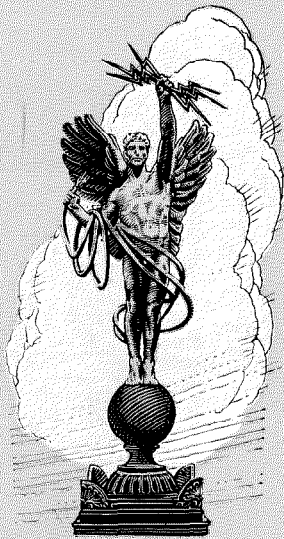

APRIL  
1924

No. 4  
VOL. 2

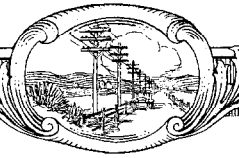

# ELECTRICAL COMMUNICATION

A Journal of Progress in the  
Telephone, Telegraph and Radio Art

## EDITORIAL BOARD

F. B. Jewett

E. B. Craft

F. Gill

J. L. McQuarrie

G. E. Pingree

P. K. Condict

J. F. Rhame, Editor

Published Quarterly by the

**INTERNATIONAL WESTERN ELECTRIC COMPANY**  
INCORPORATED

195 BROADWAY, NEW YORK, N. Y., U. S. A.

Charles G. DuBois, President

George C. Pratt, Secretary

J. W. Johnston, Treasurer

*Subscription \$1.50 per year; single copies 50 cents*

---

Volume II

APRIL, 1924

Number 4

---

## CONTENTS

- THE STOCKHOLM-GOTHENBURG TELEPHONE CABLE..... 203  
*By E. Ekeberg*
- PERMALLOY, A NEW MAGNETIC MATERIAL OF VERY HIGH  
PERMEABILITY..... 226  
*By H. D. Arnold and G. W. Elmen*
- PERMALLOY LOADED CABLE..... 232  
*By F. B. Jewett*
- THE NEW SHISAKAJIMA SUBMARINE CABLE..... 235  
*By K. Kawakami and K. Shimizu*
- HIGH QUALITY TRANSMISSION AND REPRODUCTION OF  
SPEECH AND MUSIC..... 238  
*By W. H. Martin and H. Fletcher*
- RADIO TELEPHONE SIGNALING—LOW FREQUENCY SYSTEM . . 250  
*By C. S. Demarest, M. L. Almquist and L. M. Clement*
- TELEPHONE TRANSFORMERS..... 262  
*By W. L. Casper*

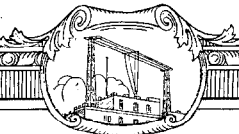

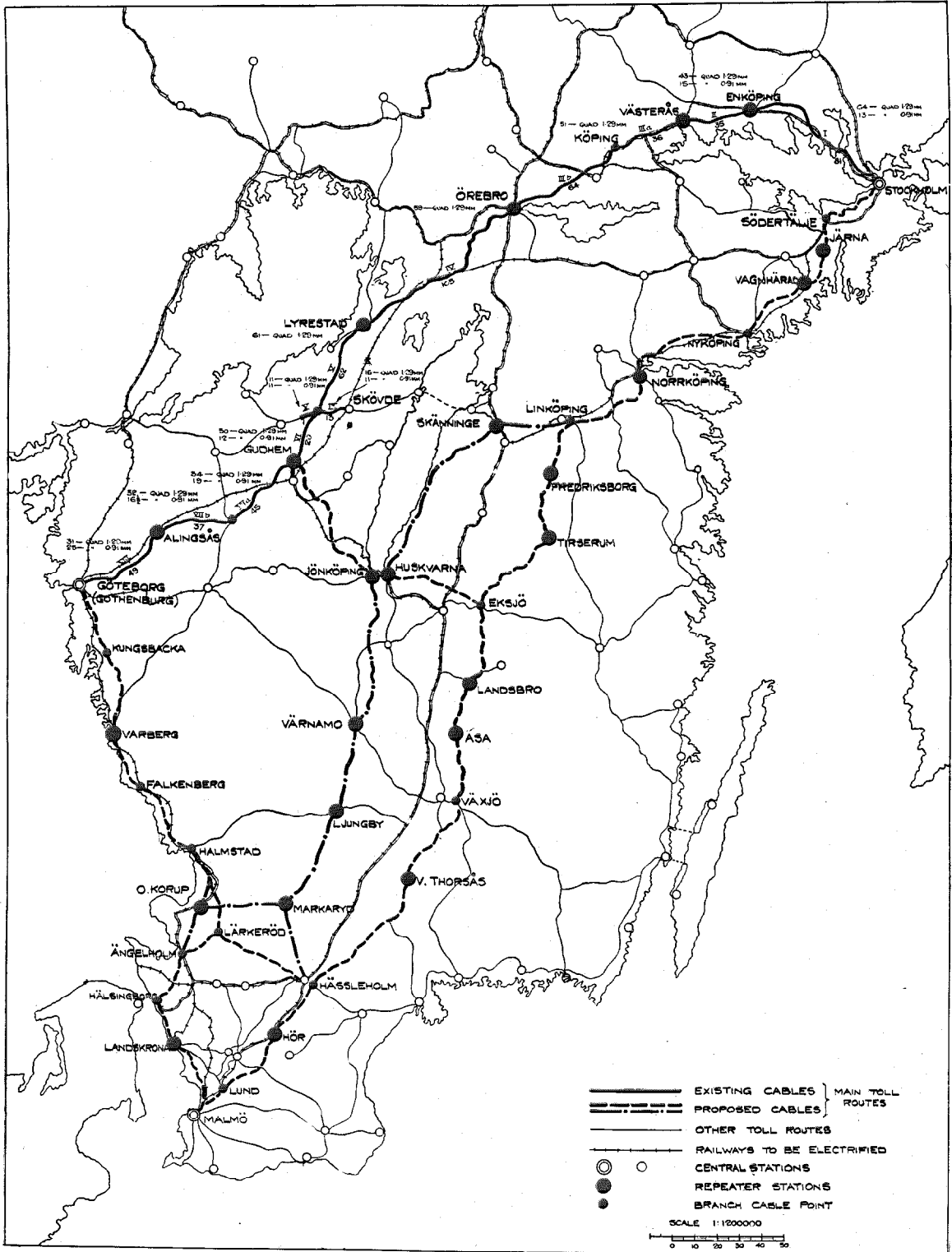

TELEPHONE CABLES IN SWEDEN

# The Stockholm-Gothenburg Telephone Cable\*

By E. EKEBERG

*Telephone Director, Royal Swedish Telegraph Administration*

LATE in the Summer of 1876, some friends of Graham Bell were experimenting, at his home, with his ingenious invention—the telephone. They tried to speak through a conductor, formed by his guests holding each other by the hands, and as this experiment was successful, although the resistance was greater than in a transatlantic cable, the optimistic inventor hoped soon to be able to invite New York business men to talk to their friends in London. This problem, however, has up to the present time defied every attempt.

Graham Bell and telephone engineers all over the world who have succeeded him have found sufficient difficulties to overcome to produce good results even on shorter lengths of long distance telephone lines. When iron wire had been replaced by copper wire and the diameter of the latter had been increased and the apparatus improved, the real difficulties arose. When the diameter was increased over about 5 mm., the cost was very great and out of all proportion to the improvement obtained. Cables presented even greater difficulties. Even with 3 mm. conductors the talking distance obtainable was only one-fifth of that of an open wire line with the same size conductor, and there was, apparently, no possibility of changing the conditions.

## LOADING

In the late eighties, Oliver Heaviside studied the laws for the telephone currents in a scientific manner. He showed that the sending current  $i_0$  is attenuated according to the law of geometrical progression, and having traversed a distance,  $l$ , will be:

$$i_l = i_0 e^{-\beta l}$$

where  $\beta$  is the attenuation constant. In a 1,000 km. line, consisting of 3 mm. copper conductors,  $\beta l$  is equal to approximately 4, so that only 1/55 of the sending current arrives

at the receiving end. In order to obtain the same current at the receiving end of a 2,000 kilometer line, the sending end current would have to be increased 55 times, which hitherto has not been possible.

The complete equation for the attenuation constant is:

$$\beta = \frac{1}{\sqrt{2}} \sqrt{\sqrt{(r^2 + \omega^2 l^2)(a^2 + \omega^2 c^2)} + ar - \omega^2 lc}$$

$\beta$  depends upon the conductor resistance  $r$ , the inductance  $l$ , the capacity  $c$ , leakance  $a$ , and the frequency  $n$  ( $\omega$  is equal to  $2\pi n$ ).

It can also be shown, that the impedance of a long line, at a given frequency, will not exceed a certain value even if the length of the line is further increased.

This impedance

$$Z = \sqrt{\frac{r^2 + \omega^2 l^2}{a^2 + \omega^2 c^2}}$$

is called the characteristic impedance and determines the sending current for a given voltage. The extent, to which the current diminishes, is determined by the attenuation constant.

It will be seen that the value of  $\beta$  is dependent upon the frequency. For ideal speech transmission, it is necessary that the electromagnetic waves contain the same fundamental and the same number of harmonics as the sound waves which strike the diaphragm of the sending end microphone. Since the attenuation is dependent upon the frequency, it may happen that certain harmonics are lost or are unequally attenuated. This will cause a change in the quality of the speech, and the speech may be rendered unintelligible, although the strength of the current is sufficient. This condition, which is called distortion, is much in evidence in cables, which have a considerable amount of resistance and capacity, but little self-induction and leakance.

\* Presented before the Congress in Gothenburg and published in the Swedish Telegraph Administration's technical bulletin No. 6-8A, 1923.



### 3<sup>M</sup>/<sub>M</sub> COPPER OPEN WIRE LINES

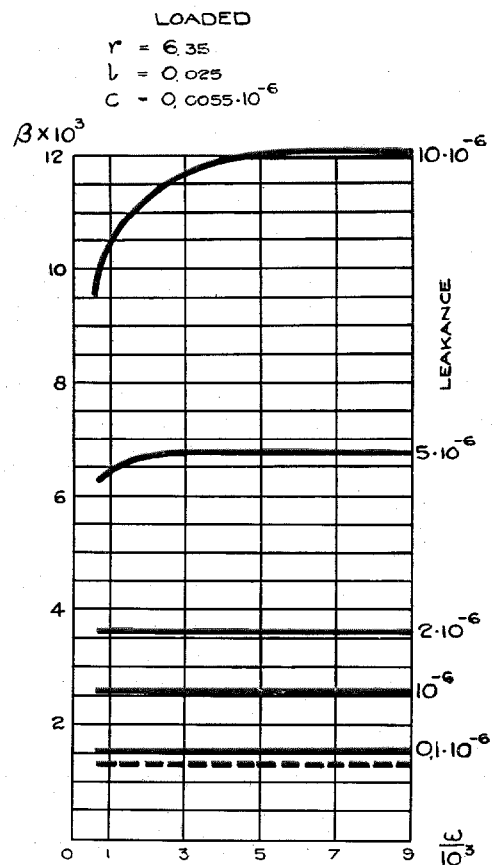
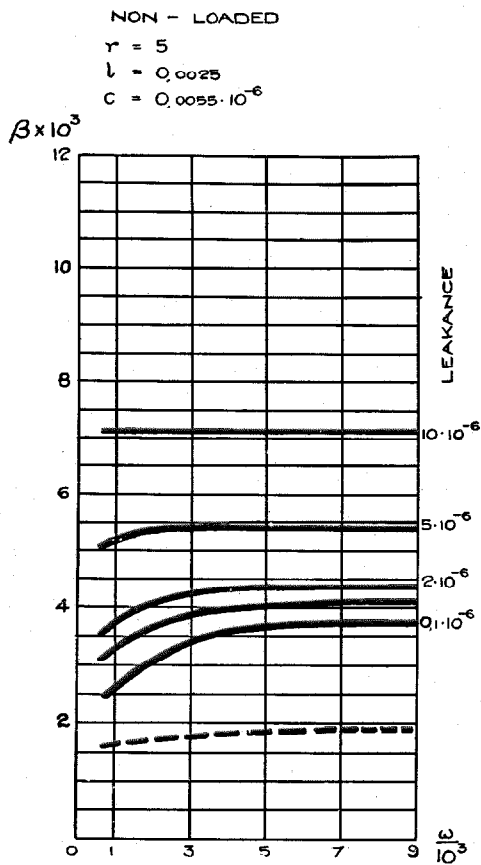

Figure 1a—Attenuation Curves

For cables, the attenuation can be approximately expressed by the formula

$$\beta = \sqrt{\frac{\omega r c}{2}}$$

For open wire lines, consisting of 3 or 4 mm. copper conductors, the attenuation can be fairly accurately expressed by the formula

$$\beta = \frac{\sqrt{cl}}{2} \left( \frac{r}{l} + \frac{a}{c} \right)$$

This is a distortionless formula as the frequency factor  $\omega$  does not appear in it.

In the design of a telephone transmission system, it is always important that the attenuation constant should be independent of the frequency. Heaviside showed this could be obtained if one could construct a telephone line

with its electrical constants in the following relationships:

$$\frac{r}{l} = \frac{a}{c}$$

In order to approach this ideal transmission line, it is necessary to increase the self-induction ( $l$ ) by artificial means.

There are two methods of accomplishing this. In the so-called Krarup cable, fine iron wire is wound, spirally, around the conductors. In the second method, suggested by Pupin, the inductance is increased by means of loading coils, inserted at definite points. In order to get a homogeneous line, at least 7 coils per wavelength are necessary at a frequency of 1,000 p.p.s. The effect of an increase in the self-induction in open wire lines and in cables is clearly shown in Figures 1a and 1b respectively. An open wire line of 3 mm. copper conductors

has inherently a fairly horizontal curve for  $\beta$  at different frequencies, which means good articulation. When loaded, we get a straight horizontal line, which, under good insulation conditions ( $a=1 \times 10^{-6}$  mho) lies much lower than the non-loaded line. If the insulation

value, which causes a considerable decrease in the current. The loading was, however, very successful, partly by saving copper, since, for instance, a 3 mm. line could be made equal to a 4 mm. line, but chiefly because of the possibility of using cables for greater distances such as Boston-New York, 390 km. with copper conductors 2.58 and 1.82 mm., and Berlin-Rhineland with 3 mm. conductors. The latter cable has by means of loading become superior to the usual 3 mm. copper open wire line.

Submarine cables can now also be adapted for telephone communication over comparatively long distances. The submarine telephone cable from the mainland of Sweden to Gotland, as well as the loaded telephone cable between Sweden and Germany, and others, have been made realities through the work of Heaviside. Without Heaviside's work also, the Stockholm-Gothenburg cable could not have been brought into effect for economical reasons, even if telephone repeaters had been available.

For a complete solution of the difficult problem of long distance telephony, it was necessary to arrange matters so that the attenuated energy in long telephone lines could be renewed at periodic intervals. For a long time, however, the solution of this problem was regarded as impossible.

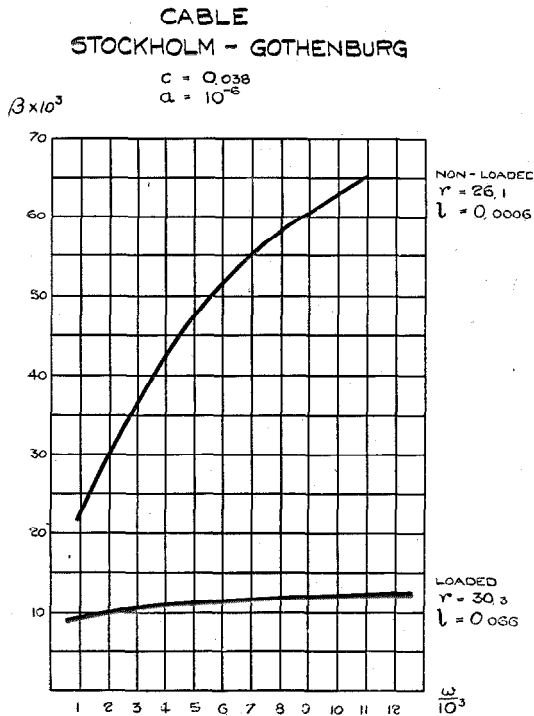

Figure 1b—Attenuation Curves

drops to 200,000 ohms per km. ( $a=5 \times 10^{-6}$  mho) a loaded line will be inferior to a non-loaded line.

In cables the improvement by loading is very marked. The  $\beta$  curve for the Stockholm-Gothenburg cable, as it comes from the factory, rises very rapidly for increasing  $\omega$ . This means that the high harmonics will vanish, and the speech will be considerably distorted. By loading, the  $\beta$  curve is practically transformed into a straight horizontal line, considerably lower than for the non-loaded cable.

The use of loading did not greatly increase the distances, over which telephone transmission was possible over open wire lines, since the non-loaded lines give good articulation and it is impossible to add inductance coils without, at the same time, increasing the resistance. The characteristic impedance of the line is also increased to as much as three times its initial

#### TELEPHONE REPEATERS

It was in America, where the Bell Company had adopted as its ideal that inhabitants all over the United States should be able to talk to each other by means of the telephone, that the need for telephone repeaters became most urgent. The telephone line between New York and San Francisco could not have been put into operation, as it was in January, 1915, without some means for the amplification of speech currents. It is known that the Americans had for some time been experimenting with several mechanical types of repeaters but none of these devices was successful. The solution finally arrived at is based on an entirely different principle.

The Vacuum tube, shown in Figure 2, is to external appearances very much like an ordinary electric lamp, but has actually three electrodes; the plate, the grid and the filament. Figure 3 shows the principle of the circuit with

which the vacuum tube is associated for the one way amplification of telephone currents. The filament current, from the "A" Battery, is

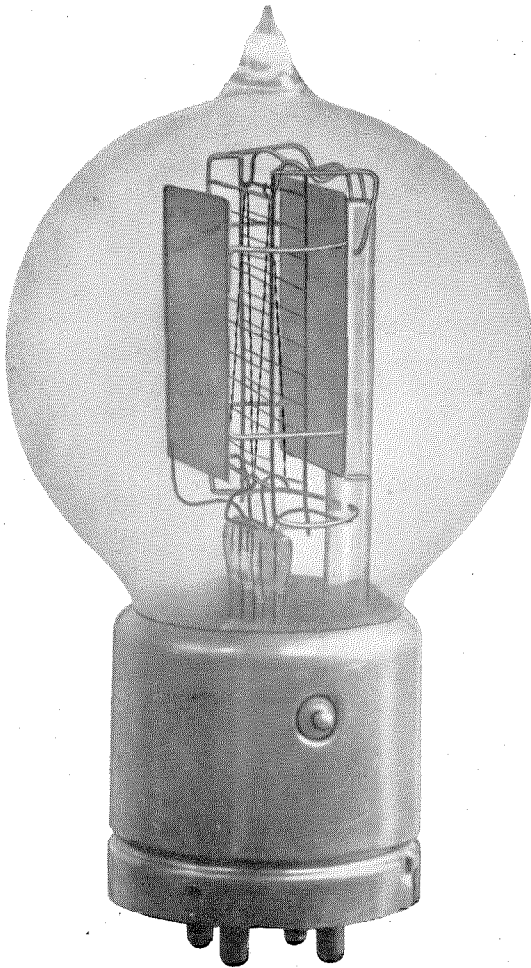

Figure 2—Vacuum Tube

about 1.25 amp. Between the filament and the plate is connected a battery of 130 volts, the positive end being connected to the plate

through a retardation coil. The filament, when heated, emits electrons, which tend to be absorbed by the positive plate, the loss in positive electricity of the plate being restored by the 130 volt battery. A current thus flows from the filament to the plate in the external circuit, as long as the plate is bombarded by the electrons within the tube.

The thermionic emission from conductors coated with certain oxides is very much greater than that of pure metals. The filaments of the vacuum tubes used in the repeaters of the Stockholm-Gothenburg cable system are of this "coated" type, and emit sufficient electrons when operated at a dull red heat. The production of sufficient electron emission at a low filament temperature ensures long life for the tubes, and renders their operation more economical.

On its way to the plate the electron flow will be influenced by any charges that may exist upon the grid. In the repeater circuit the grid is given, by means of the "C" battery a permanent negative potential of 9 volts in respect to the negative end of the filament. Any variation in this grid voltage will produce a proportional change in the plate current. The attenuated telephone currents coming in from the East line set up a voltage in the potentiometer, which is so arranged that all or any part of this voltage can be applied to the input transformer, thus controlling the gain given by the repeater. The input transformer steps up the voltage from the potentiometer and applies it in series with the "C" Battery to the grid.

No appreciable input energy is required to operate the vacuum tube as used in telephone repeater circuits, consequently the input trans-

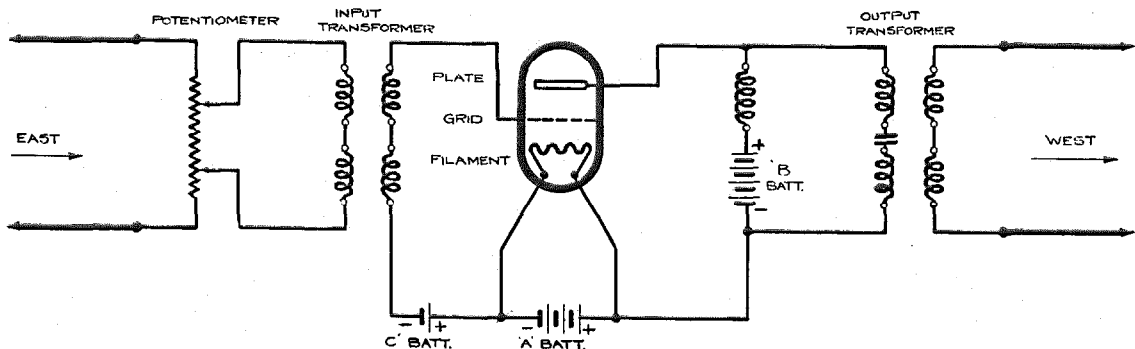

Figure 3—The Principle of Amplification

former is merely a voltage changing device, and the ratio of its windings determines the gain given by the repeater, that is the relation between the input and the output powers.

The amplified speech currents pass through the output transformer to the West line. The circuit under consideration (Figure 3) permits of operation only in this one direction, and to

tion, individually tested out for each line or each group of line. The output transformer has two further windings, connected to the plate circuit of the West line, and from the middle points of the line windings of the output transformer No. 1 a connection is made to East input transformer and the grid circuit of the East tube. In the above mentioned connection

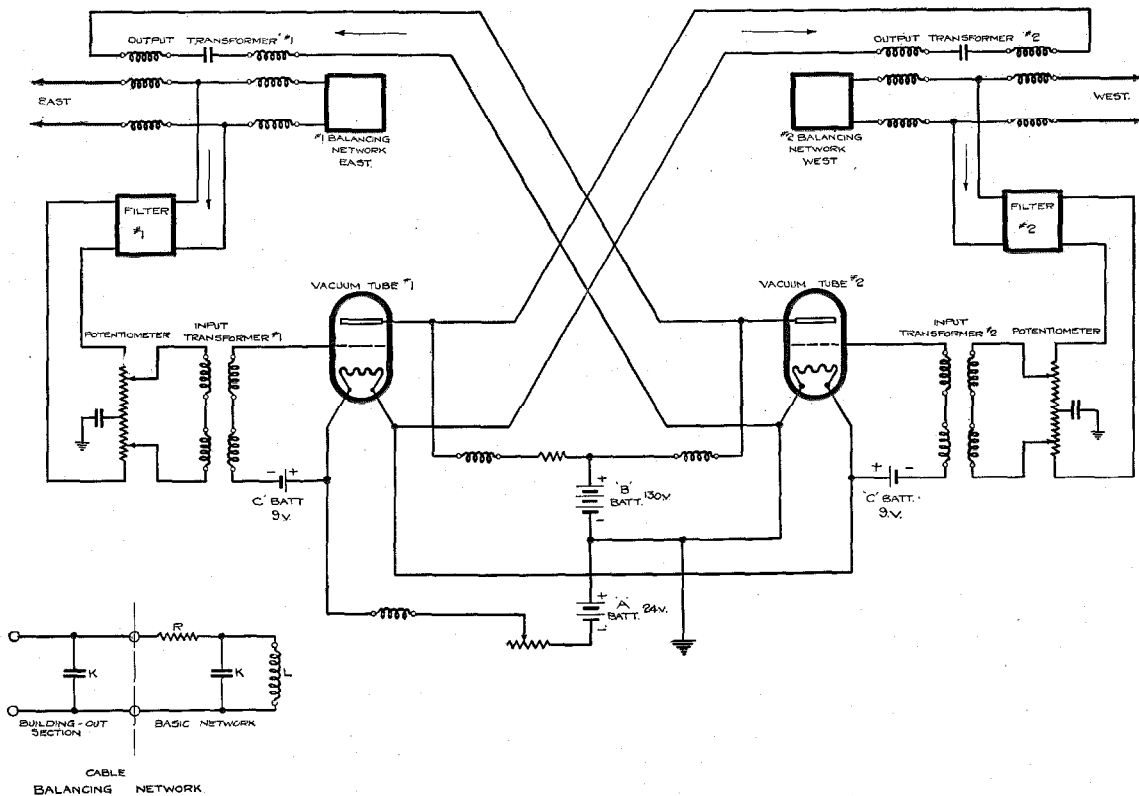

Figure 4—22-Type Repeater

enable two way telephone transmission, a balanced arrangement is used. Figure 4 shows such a circuit employing two tubes, one for transmission in each direction. This is known as the 22-type repeater.

The East line is connected through the windings of the output transformer to the East network, consisting of an artificial line with a characteristic as near as possible to that of the line, for all frequencies within the speech range that the repeater is designed to amplify. This artificial line consists partly of a basic network, which is the same for lines of a similar type and construction, and partly of a building out sec-

tion, there are inserted a filter which cuts out too high and too low frequencies, and a potentiometer to control the amplification. The repeater arrangement for the West line is symmetrical with that for the East line. The two lines need not necessarily have identical characteristics, but the networks must be in accordance with the associated lines.

The attenuated current arriving from the East line is divided owing to the action of the output transformer, between the output circuit of tube 2, and the input circuit of tube 1. That part of the incoming energy in the output circuit of tube 2 is lost. The telephone currents built

up in the plate circuit of tube 1 go through the output transformer 2 to the West line. If the West line is perfectly balanced by network No. 2 no current can return to amplifier No. 2, but the current is divided equally between the West line and the West network. It will be seen that current from West goes through similarly, and it is thus possible to talk in both directions. If there should be a small unbalance between the West line and its balancing network, even for a certain frequency only, a part of the current will return to the grid circuit in tube No. 2. Here it will be amplified and go out through the East line, and might under certain conditions cause echo phenomena. If the East line is not well balanced, we get a returning current in the grid circuit in tube No. 1, etc. This will, if the gain of the repeater is sufficiently high, cause a singing which will disturb the transmission.

It will be seen from the above that the efficiency of the repeater will largely depend upon to what extent the network is made to simulate the line, and to render this possible, the electrical constants of the cable must be uniform and should not vary from time to time. It will also be realized how important it is that the loading of the circuits should be carefully done, so that a sufficient number of loading coils should fall within even the shortest wavelengths, and that coils should all be alike and their resistance and self-inductance should not vary, due to any external influence or measuring currents, imposed on the circuit. The insulation, capacity and resistance of the cable should also remain constant. When the distances between repeater stations are very great, the difference in resistance, which is caused by changes in temperature from Summer to Winter, may cause variations in the circuit, which necessitate automatic regulating devices.

#### TOLL CABLES IN SWEDEN—GENERAL CONSIDERATIONS

The above mentioned theoretical and practical investigations regarding telephone transmission were concluded during the war, and before the end of the war, in America, if not elsewhere, repeaters were in use in telephone lines. That meant for long distance telephony a greater step forward than ever before. The

time was now ripe to consider the use of long distance cables in Sweden, thus rendering the telephone service immune from the effects of snow storms. This new method of constructing the lines was also much appreciated from the point of view, that as the toll lines steadily increased, it was difficult and costly to maintain and extend the long distance plant. The Telegraph Administration therefore appointed, in January, 1918, a committee to study the question of constructing a cable network for toll lines in Sweden.

The committee investigated the number of telephone calls per day in the years 1905-1915 on the lines carrying the heaviest traffic and worked out an average factor for the increase per year. By applying this factor and taking the year of 1917 as starting point they calculated, approximately, the traffic figures for 1931. The Stockholm-Gothenburg cable was expected to be finished in 1921 and be sufficient for 10 years. To calculate the necessary number of circuits in order to meet the public demand for quick telephone service, it was necessary to fix a service standard which involved a reasonable waiting time, and which would reduce the express calls to the smallest possible number. Up to that time it was considered that one circuit ought to carry 3,000 calls a month (equal to 4,000 periods), but with this number, ordinary calls were practically excluded during business hours. If 2,100 calls per month per circuit were allowed, about 78% would be put through within 5 minutes, while the express calls would be reduced to 1%. But under these conditions the circuits would be only utilized to one-half their capacity, so that under normal conditions, the telephone rates would have to be increased in order to pay the annual costs of construction. The committee finally assumed 2,500 calls per month. The Western Electric Company, who eventually supplied the cable, pointed out in the tender, that this number was more than twice that used in America.

Regarding the type of construction to be adopted, an aerial cable would offer certain advantages, such as less cable length, as the route might be chosen across country, also it would be protected against acid corrosion and electrolysis, which might affect an underground cable. The maintenance, however, would be



expensive, and it was feared that the cable would be open to damage; it was considered also that difficulties would be encountered in connection with very large aerial cables. Taking into account the greater reliability and the immunity against interference from power lines, as well as the experiences of certain Swedish concerns with their cables laid along roads, the committee arrived at the conclusion that the underground system should be employed, particularly as it also would save right-of-way costs and the need for expropriations.

Regarding the routes, only the main lines would be considered at first, namely: Stockholm-Gothenburg and Stockholm-Malmö, and in both cases it was essential to find the route, over which the cable would be most useful for the traffic between intermediate stations. Owing to the great number of circuits required, it was impossible to start with a common cable from Stockholm. It was evident that, from the beginning, there would be one Gothenburg cable and one Malmö cable. It followed, from this reasoning, that a cable for the middle and western parts of Sweden, ought to be laid north of Lake Mälaren, via the industrial centre, Västerås to Örebro, and from there to Gothenburg (that is practically the same route as used for the first telegraph and the first open wire telephone line, Stockholm-to-Gothenburg). By the linking up of the cable with the important traffic centre to Örebro, the traffic of the whole northern district with the capital and with Gothenburg was secured, and the traffic from Gothenburg to Gävle, Falun and Norrland, together with the traffic from Stockholm to Värmland and Norway, would benefit to a considerable extent by the cable. With regard to the section Örebro-Gothenburg, it was first thought, that the cable should touch the important junction points Skövde and Falköping, but on the advice of the contractors that this might cause interference, it was removed from the railway and laid via Varnhem and Gudhem, and branch cables from these two points were made to serve Skövde and Falköping.

For the southern cable, Södertälje, Nyköping, Norrköping, and Linköping, naturally formed suitable intermediate stations. For the route south of the last named town two alternatives have been proposed. The cable should pass

through either Jönköping, Värnamo, and Markaryd, or alternatively over Eksjö and Växjö. The proposal also contemplated a tie-cable from Falköping (Gudhem) to Jönköping, to be eventually extended to Eksjö. For the traffic between the West and East of Sweden, we should, by means of this tie-cable, get a suitable spare connection in case of faults between Stockholm and Falköping or Stockholm and Eksjö. (The cable along the western coast on the map was not included in the committee's conclusion, but has been added later as a suggested arrangement.)

Upon considering the committee's report, the Telegraph Administration found that it was not economical to continue the erecting of several new open wire pole lines along the railway on hired or expropriated ground, particularly as the solution of long distance telephony by means of cables had been found. (A photograph of the existing pole lines is shown in Figure 5.) Due to the considerable first-cost of cable construction, it was decided that the new long distance system should be constructed successively, and should be started where the greatest difficulties had been experienced with the open wire lines. Toward the end of 1919, the Telegraph Administration therefore asked for authority to carry out one part of the proposal, namely: the cable Stockholm-Gothenburg. One important reason was that the electrification of the railroad between these cities would necessitate the removal of the open wire lines. The bill was introduced in Parliament the 16th of January, 1920. The Government considered that it would have been better to discuss the cable in connection with the electrification, but eventually found that certain conditions pointed to an early decision.

The Government were convinced that an extension of the telephone lines to an extent at least double that at present, was unavoidable in the districts where the cable would be laid. As this was not economically possible by extension of the open wire lines, they decided to recommend that the cable should be authorized even if the question of railway electrification was postponed. The 6th of March, 1920, the bill was approved by both the upper and lower Houses of Parliament.

The cost was estimated as follows:

Cable	10,035,000 Swedish Kronor
Installation	2,625,000
Joining	350,000
Loading	2,920,000
Repeaters	1,050,000
Test arrangements	225,000
Repeater Stations	900,000
Freights, etc.	925,000
Customs	405,000
Miscellaneous	565,000
Total cost	20,000,000 Kronor

of which 6,000,000 were assumed to be covered by the value of the old copper wire lines and 4,000,000 to be written off the maintenance.

Through this parliamentary decision, Sweden became the first country in Europe to obtain a completely up to date cable of the magnitude here considered, and it must be regarded as a

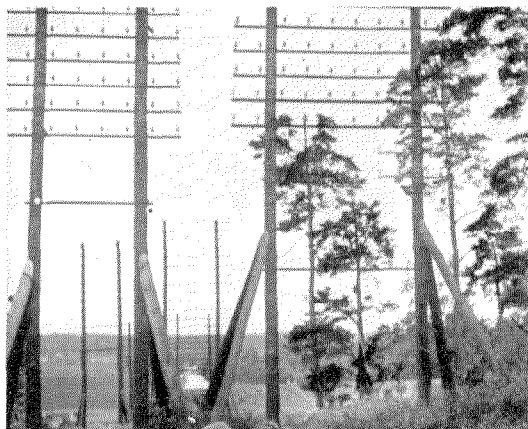

Figure 5—Open Wire Line—Stockholm-Gothenburg

great advantage that the contract was given to the Western Electric Company, who had the widest experience on the subject, not only through scientific experiments carried on for years with repeaters, but also from practical cable installations in America.

#### DESCRIPTION OF THE CABLE

The cable, which contains two sizes of paper insulated conductors, is lead covered but not armoured. Contrary to the practice in open wire line construction, where two pairs form the opposite corners of a square, the two wires forming a cable pair are twisted together with a definite length of lay, and two pairs having different lengths of twist are then again twisted

into a 4-wire unit or quad. Each 4-wire unit represents three telephone circuits, because a duplex (or phantom) circuit is derived from the two physical (or side) circuits. To make this possible, extreme care in the manufacture and jointing of the cable is necessary, the two side circuits being made identical in their electrical characteristics in order to eliminate crosstalk.

It was decided that the attenuation length between any two terminating stations should not exceed  $\beta l = 1.4$ , and for circuits, extended by open wire line (for instance Gothenburg-Sundsvall), the attenuation length in the cable should not exceed  $\beta l = 0.9$ . In this connection there are three determining factors: (1) the amount of copper, (2) the added self-inductance, and (3) the number of repeaters to be used.

The different firms tendering were, in a general way, at liberty to specify these figures. The diameters of the conductors were fixed by the Administration to be: 1.29 mm. and 0.91 mm. The self-inductance should be increased to 66 milli-henrys per km. for the side circuits and to 40 milli-henrys per km. for phantom-circuits. The repeater stations were to be located at Enköping, Västerås, Örebro, Lyrestad, Gudhem and Alingsås. The direct current resistance was guaranteed not to exceed 27 and 54 ohms per loop kilometer for the 1.29 mm. and the 0.91 mm. conductors respectively. The mutual capacity per kilometer between two conductors of a pair should not exceed 0.045 microfarad, and that between two pairs (i.e., a phantom) 0.070 microfarad; the insulation resistance of one wire with all the others and the lead sheath connected to earth should not, after one minute's electrification, fall below 350 megohms per kilometer. The loading coils to be inserted in a duplex cable with repeaters, must be of great magnetic stability, and the Western Electric Company guaranteed that a direct current of 2 amperes would not alter the inductance, permanently, more than 5%, the inductance being that as measured using 1 milli-ampere at 1,800 cycles per second.

The inductance, measured with 2 milli-amperes at 1,800 cycles should be within 174–181 milli-henrys for the side circuit coils and within 105–109 milli-henrys for phantom circuit coils; the effective resistance, using that measuring current, should not exceed 20.7 and 8.0 ohms,

respectively, and the direct current resistance per line winding 4.3 and 2.2 ohms, respectively. The difference in resistance between the two windings of a coil is limited to 0.1 ohm for the phantom and 0.2 for side circuits, and the difference in inductance must not exceed 0.5% and 0.25% between the windings of phantom and side circuit coils, respectively. To ensure that the coils in regard to this, as well as to magnetic leakage, were of the highest possible grade, it was guaranteed that the crosstalk due to the loading coils should not exceed an attenuation length  $\beta l = 9$ .

For the loaded circuits it was guaranteed that the attenuation constant should not exceed the following values:

Size of Conductor	Attenuation per Kilometer	
	Phantom	Side
1.29 mm.....	0.0107	0.0130
0.91 mm.....	0.0203	0.0243

The two-way repeaters employed can be adjusted so that the transmission gain corresponds to an attenuation of  $\beta l = 1.65 - 1.95$ , depending upon the balance obtainable. Gains

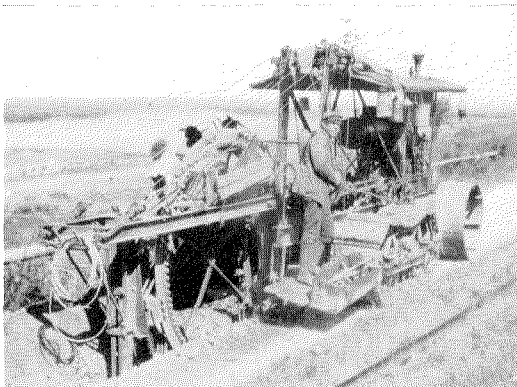

Figure 6—Buckeye Digging Machine

of this magnitude are, however, seldom required. For the distance Stockholm-Gothenburg, where the total attenuation for a side circuit is about 6.9, an average of 1.4 for the four repeaters is sufficient to reduce the total attenuation to 1.3. In the repeater stations, the repeaters are permanently assigned to definite circuits, and these

circuits are used according to traffic demands. Stockholm, Gothenburg, Örebro, and some other stations are equipped with cord circuit repeaters, by means of which the cable circuits

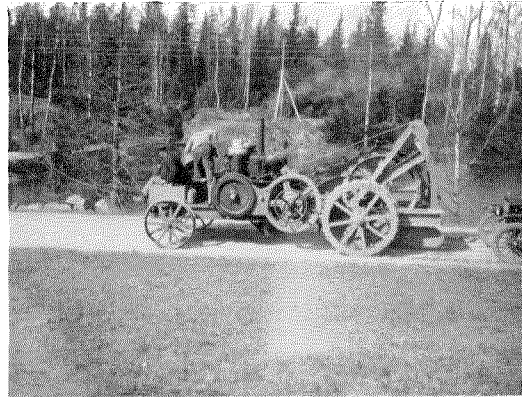

Figure 7—Hässleholm Digging Machine

are connected to the open wire lines requiring special amplification.

It has been decided in general not to take out circuits between the repeater stations. This has, however, been necessary at Ljung, at the crossing of the Borås-Herrljunga Railway, where circuits are diverted to Borås and at Varnhem, between Gudhem and Lyrestad for the circuits to Skara and Skövde and also in Köping.

#### INSTALLING THE CABLE

The installing of the cable was started in Gothenburg early in the Spring, 1921, and



Figure 8—Cable Laying

Örebro was nearly reached when the frost made the digging impossible. In 1922 the outside work was stopped due to a strike, but the time

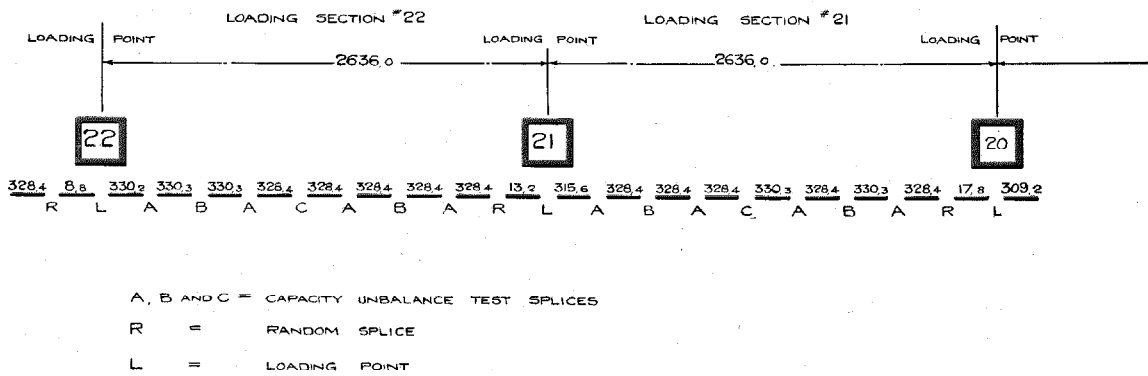
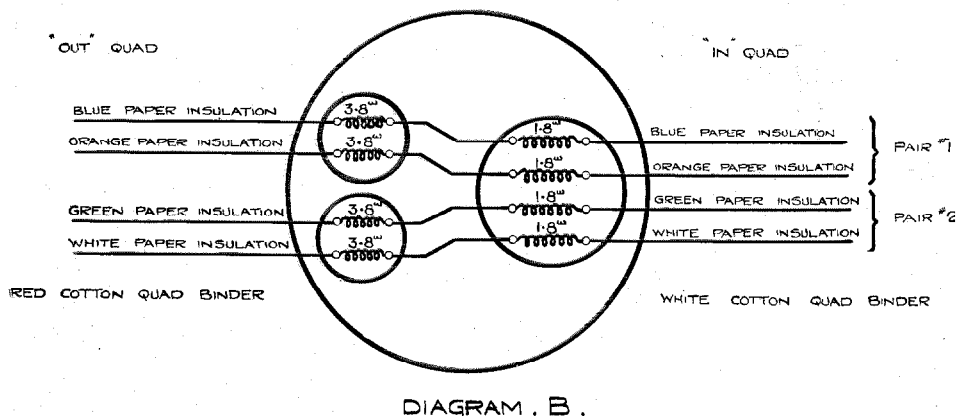
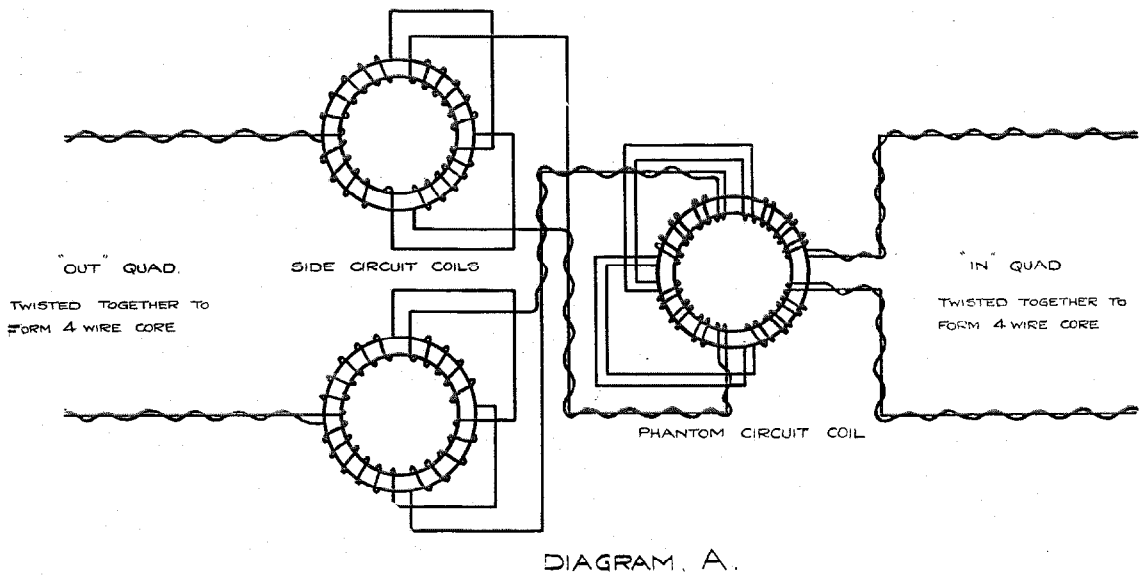

Figure 9—Splicing Plan



NOTE:- FIGURES GIVE NOMINAL D.C. RESISTANCE OF 583A. AND 584A. LOADING COILS

Figure 10—Loading Unit Connections

was spent in equipping the repeater stations and getting the cable through the towns, so that in August, 1923, it was possible to test through, and talk from Stockholm to Gothenburg. As mentioned before the cable is mainly laid in the road and generally at a depth of 0.6 metre, without armouring, but protected by a creosoted wood trough. The trenching was done partly by hand and partly by machines of Swedish and American construction (see Figures 6 and 7). The cable was shipped from America on drums in lengths of about 300 to 330 metres and was carried on motor lorries from the nearest railway station to the place where it would be laid. The actual laying of the cable was done from motor trucks (Figure 8), but in some cases, where the territorial conditions were difficult to overcome, the cable was carried by a gang of men and laid in its place.

The spacing of the loading coils must be exact. Between Lyrestad and Gudhem, for example, the distance between loading coils is 2,636 metres, and the average spacing for the whole cable does not differ materially from that figure. The last loading section near a repeater station was adjusted to its exact theoretical value, where occasion demanded, by placing the cable in a loop before it entered the station. There are (as shown in Figure 9) usually 8 cable lengths per loading section.

The jointing is carried out by first making all the "A" joints, then the "B" joints, and finally the "C" joint. When the cable is opened for jointing, the ends are impregnated with paraffin (heated to  $190^{\circ}\text{C}$ ), in such a way that the wax first is poured over the lead sheaths near to the end and then over the free ends. No paraffin plugs are, however, used. At each splice the capacity unbalances between the circuits in each quad are measured first in each direction and the figures recorded; the quads are then jointed so as to reduce, as much as possible, the unbalances between the circuits. At a "C" joint, the unbalances in the sections are practically equalized, the unbalances being reduced from about 200 micro-micro-farads to 30 micro-micro-farads.

There are 3 loading coils per quad, as shown in Figure 10, and these units of 3 coils are mounted in cast iron cases (Figures 11 and 12), which stand on a concrete base.

The joints are protected by a concrete box. In the first period of construction, all of the coils are not installed. As shown in Figure 12 there is room for a third loading pot to be inserted later.

For further testing to ensure that the circuits as far as completed are satisfactory for repeater

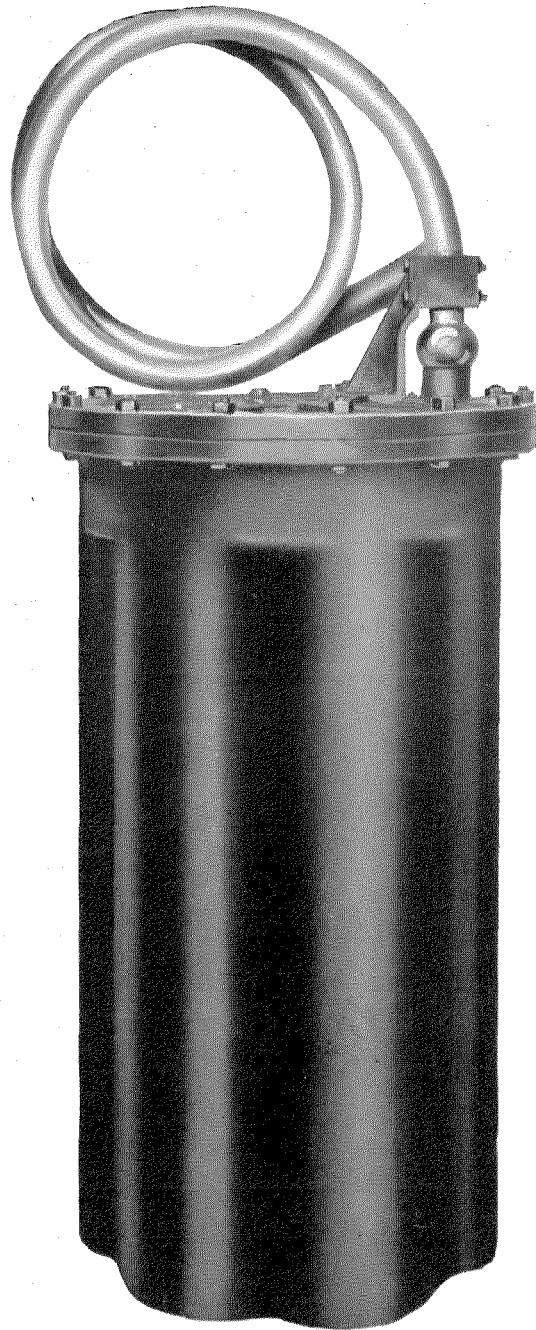

Figure 11—Loading Coil Case



operation, every fourth loading point is not at first connected into the cable (see Figure 14). These points are known as Test Load Points.

centre of the repeater section as practicable. The procedure is as follows: The first measurement made is that of the capacity of the ap-

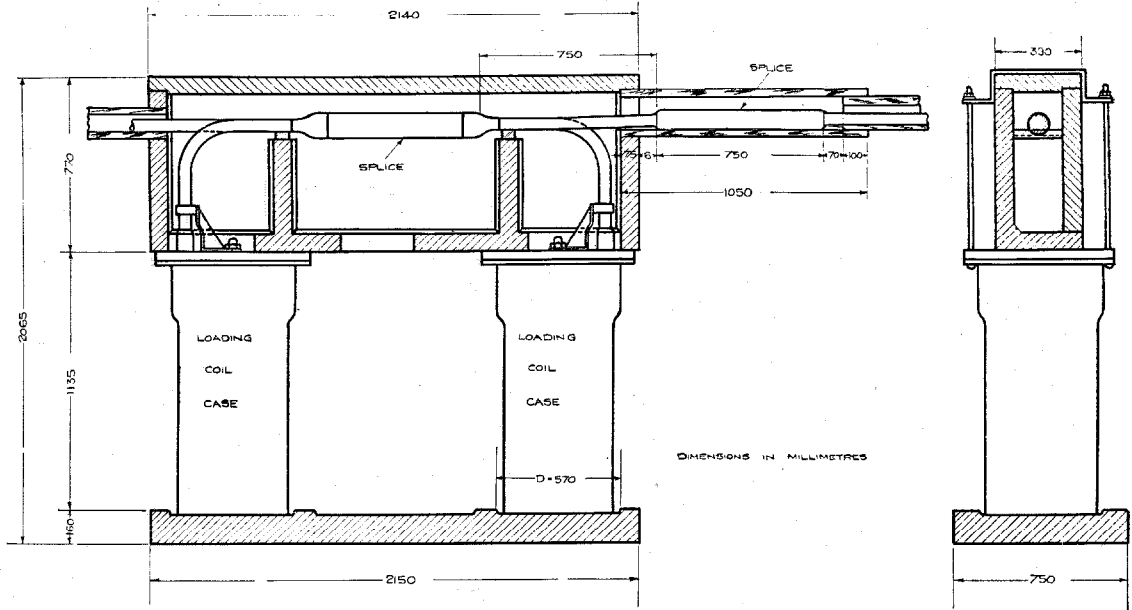

Figure 12—Loading Coil Cases Installed

Measurements are made separately from each end of a repeater section, through successive test load points to a common point as near the

proximately half loading section adjacent to the repeater station, the first loading coil not being connected in. If the measurements are from Station A (see Figure 14) loading point 1 is then connected in and tests are made over the 4 loading section lengths thus connected in. When these tests prove satisfactory, the next length is connected in and the tests repeated. This procedure is followed until the mid-point in the repeater section is reached. The tests consist of direct current measurements of the difference in resistance between the wires of a pair, conductor loop resistance and insulation resistance. The characteristic impedance of the circuits is measured with alternating current, at frequency intervals between 300–2,100 cycles. The curve shown in Figure 15 gives a typical representation of line conditions.

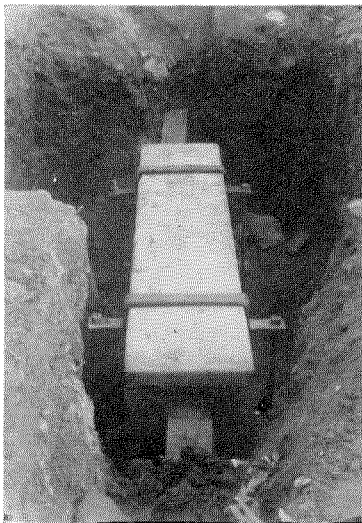

Figure 13—Concrete Cover for Loading Coil Cases

In Figure 15 the curves are very good up to about 1,800 cycles, i.e.,  $\omega = 10,000$ , and from this it will be seen, that the cable is free from faults and is homogeneous, thus permitting a good

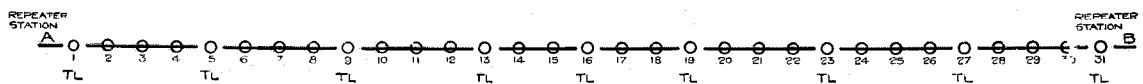

Figure 14—Scheme for Testing

degree of balance to be obtained. Above 1,800 cycles the irregularity of the curve is unimportant since the filter associated with the

repeater circuit does not permit the passing of frequencies above this value.

As a complete impedance test requires a considerable time, this is not applied to more than a few circuits. For that reason all of the loaded circuits were tested for their degree of balance with a two-tube repeater, as shown in Figure 16 which indicates the scheme for 21-circuit testing. This figure shows the circuit of a special repeater that was arranged in portable form in a manner to facilitate testing. This repeater had the same essential characteristics as the station repeaters.

In the normal condition of a repeater, speech currents coming from  $L_1$  are amplified in the East tube and are transferred to  $L_2$  and  $N_2$  through the output transformer  $U_2$ . If  $L_2$  is not equal to the balance circuit  $N_2$  for any frequency we get current in the potentiometer  $PO_2$ , which amplified in the West tube goes through  $U_1$  and thus gets transferred to  $L_1$  and  $N_1$ . If the latter are not equal we get a current through  $PO_1$  and so on, and the repeater sings (gives rise to oscillation in the repeater circuit). This oscillation will start even without foreign current, if sufficient unbalance is present. In the 21-circuit test, the circuits are in turn connected to  $L_1$  and their balancing networks are connected to  $N_1$ . Terminals  $L_2$  of the other output transformer are then short circuited and

R = RESISTANCE COMPONENT  
X = REACTANCE COMPONENT

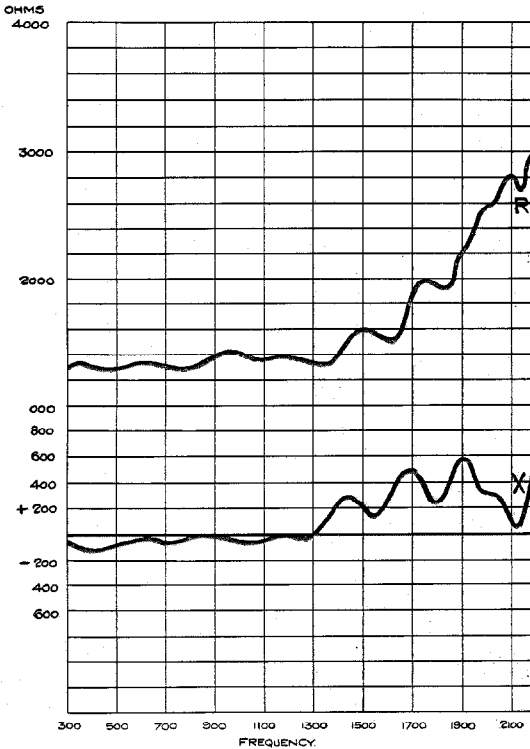

Figure 15—Impedance Curve for Cable Side Circuit

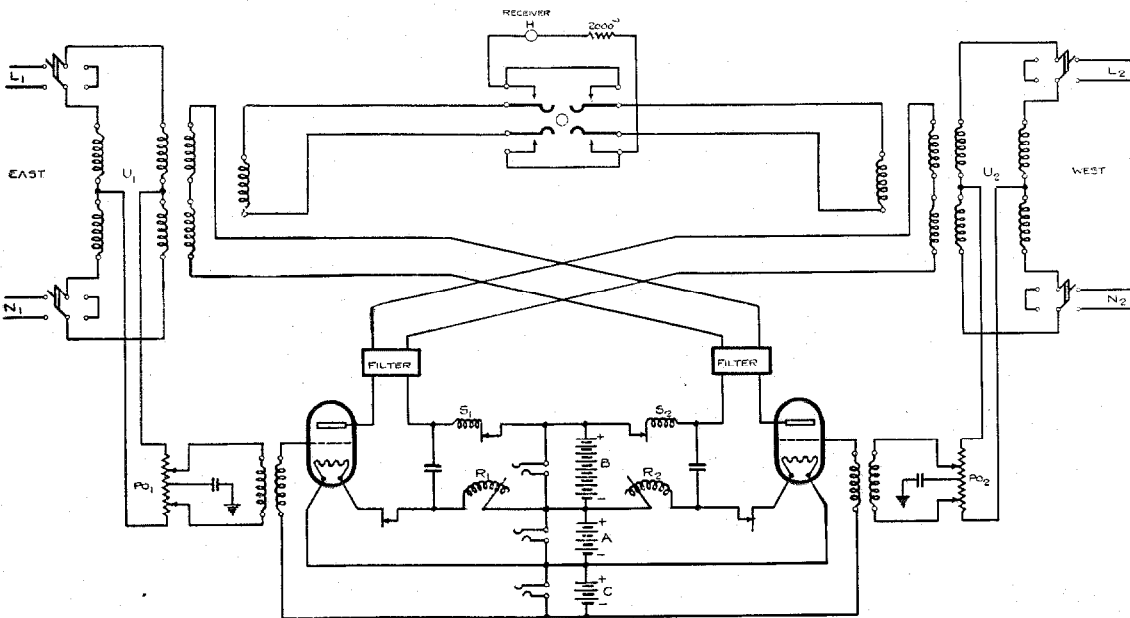

Figure 16—Portable Repeater for 21-Circuit Test

its network terminals  $N_2$  opened. This is arbitrarily termed positive poling. This connecting of the terminals renders the output transformer a simple inequality repeating coil connecting the output of one tube to the input of the other. The amplification is then increased until singing is heard in the telephone  $H$ . The open and short conditions are then interchanged (called negative poling) and the singing test repeated. The gain at which the repeater first commences to sing is taken as a measure of the balance between the line and its balancing network, that is to say, an expression for the line's homogeneity. Two different values of singing point will be found for the positive and negative polings. The singing depends upon having a favorable poling in the circuit, and the lower of the two values is taken as the correct one.

The potentiometers which resemble rheostats (see Figure 19) have 9 different steps, the highest giving an amplification which at 800 cycles equals 22.5 miles of standard cable, corresponding to a  $\beta l$  of  $22.5 \times 0.109 = 2.45$ . Each step corresponds to a difference in gain of 2 miles. In the 21-circuit test the settings of both potentiometers are alternately raised until singing occurs. The total loss in the circuit then equals the total gain, and the actual singing point of the line under test against its balancing network is equal to the sum of the potentiometer settings, expressed in standard miles, plus 6 miles. Upon the completion of a whole repeater section, further tests were made from each end,

the 21-circuit tests on this occasion being made particularly for determining the best combination for balancing the circuits.

Following these preliminary tests, extensive and searching tests were carried out by the Administration engineers for the final approval

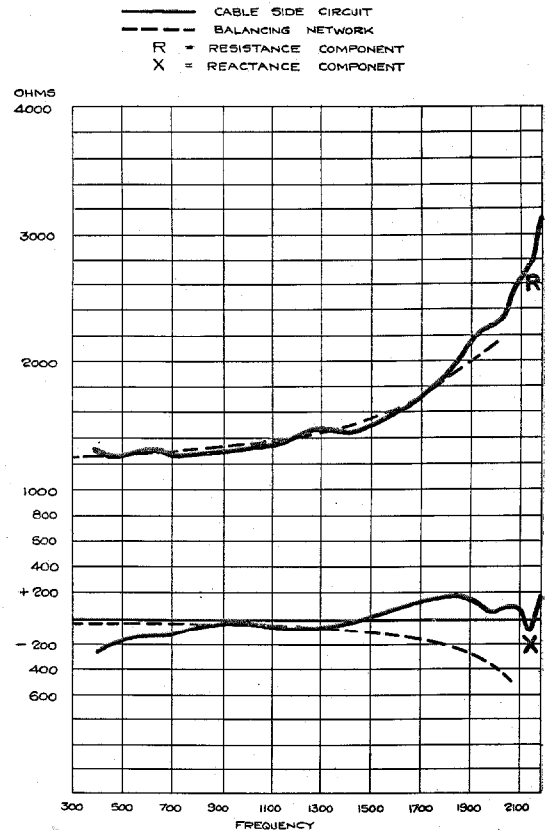

Figure 17—Impedance Curve for Cable Side Circuit

TABLE I

Section VIII Gothenburg = Alingsas	Frequency of Measuring current	Values measured				Values guaranteed			
		1.29 mm.		0.91 mm.		1.29 mm.		0.91 mm.	
		Side	Phantom	Side	Phantom	Side	Phantom	Side	Phantom
Resistance per km. non-loaded	0	25.2	12.6	50.6	25.4	27	13.5	54	27
Resistance per km. loaded....	0	28.9	14.5	54.5	27.3	31.8	15.9	58.8	29.4
Insulation in megohms, non-loaded.....	0	2000				350			
Insulation in megohms, loaded	0	1900							
Capacity, microfarads per km.	0	0.038	0.06	0.036	0.06	0.045	0.070	0.045	0.070
Attenuation constant $\beta \cdot 10^8$ for loaded circuits.....	480	11.8	8.75	20.19	17.44				
	1000	12.6	9.87	21.64	18.17	13.0	10.7	24.3	20.3
	1500	14.0	11.12	23.00	19.04				
Characteristic Impedance loaded circuits, $Z$ .....	800	1386	765	1401	840				
Phase Angle.....		-0°50'	-1°16'	-3°59'	-2°37'				

of the repeater section. These acceptance tests involved first insulation measurements with direct current, the measurement of the difference in resistance between the wires of the pairs, and measurements of conductor loop resistance. In section VI, where the loaded side circuits had an ohmic resistance of 2,893 ohms, the average difference between wires of pairs was 0.34 ohm. The 21-circuit test was later applied to all circuits. Furthermore, impedance measurements were carried out (see Figure 17) and also tests for attenuation constant and crosstalk (see Table I).

Figure 17 shows the degree of uniformity obtainable between the cable circuits (full line curves), and the simple balancing circuit in accordance with Figure 4 (dotted curves).

The minimum  $\beta l$  values obtained by crosstalk measurements between the circuits in the same quad are shown in Table II:

The crosstalk between circuits in different quads was found to be  $\beta l = 8.3$  to 9.0 (minimum values).

#### THE REPEATER STATIONS

In Gothenburg and Stockholm the repeater stations were installed in existing buildings but the other stations had to be built specially. Figure 18 is a photograph of the typical repeater station at Enköping.

The circuit arrangements of these stations are very convenient though at first they may appear a little complicated. Figure 21 illustrates the connecting arrangements employed at a repeater station where a line is equipped with a repeater. It will be seen that there are copious facilities for cross connecting at the Combined Distribution Frame (C.D.F.) where all wiring is made to terminal blocks. At the Toll Test Board, and Repeater Jack Panel, con-

nections are made through jacks which render the lines and their equipment readily accessible for testing purposes, and when necessary, make it possible by loose connecting cords and plugs, to carry out any temporary changes in the disposition of the lines and their equipment.

Incoming lines are connected first to lightning arresters and fuses (protectors) mounted on the combined distributing frame, and then proceed to the Toll Test Board. The Toll Test Board is equipped with voltmeters and Wheatstone



Figure 18—Enköping Repeater Station

Bridges, and provides means for the making of all forms of direct current tests on the lines. Connections are extended from the Toll Test Board through the combined distributing frame again, and then through a transformer to the repeater rack. Connections are also similarly established from the repeater rack to the balancing circuits. With each repeater are two signaling relay arrangements, one for the east and one for the west line, which are employed for relaying the 135 cycle ringing current round the repeater. The 150-D type relays which are responsive to the ringing current, are wired through a special test board which pro-

TABLE II

$L_1 = \text{Side 1}$ $L_2 = \text{Side 2}$ $D = \text{Phantom}$	$n = 500$			$n = 1000$			$n = 1500$		
	$L_1 - L_2$	$L_1 - D$	$L_2 - D$	$L_1 - L_2$	$L_1 - D$	$L_2 - D$	$L_1 - L_2$	$L_1 - D$	$L_2 - D$
$\beta l$ loaded . . . . .	9.5	8.3	8.5	9.0	7.8	8.0	8.3	7.5	7.5
$\beta l$ unloaded . . . . .	11.0	8.5	8.5	11.0	8.3	8.5	12.0	8.2	8.3

$L_1$  and  $L_2 = \text{Side circuits. } D = \text{Phantom circuit.}$

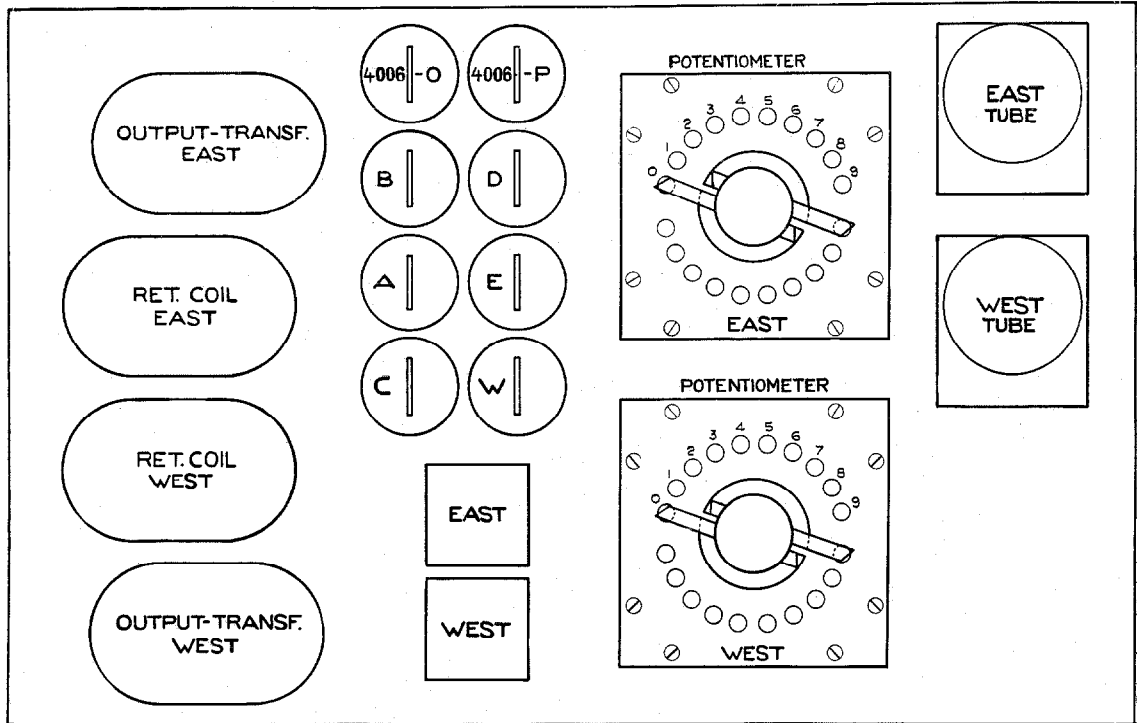

Figure 19—Front View of Repeater Unit

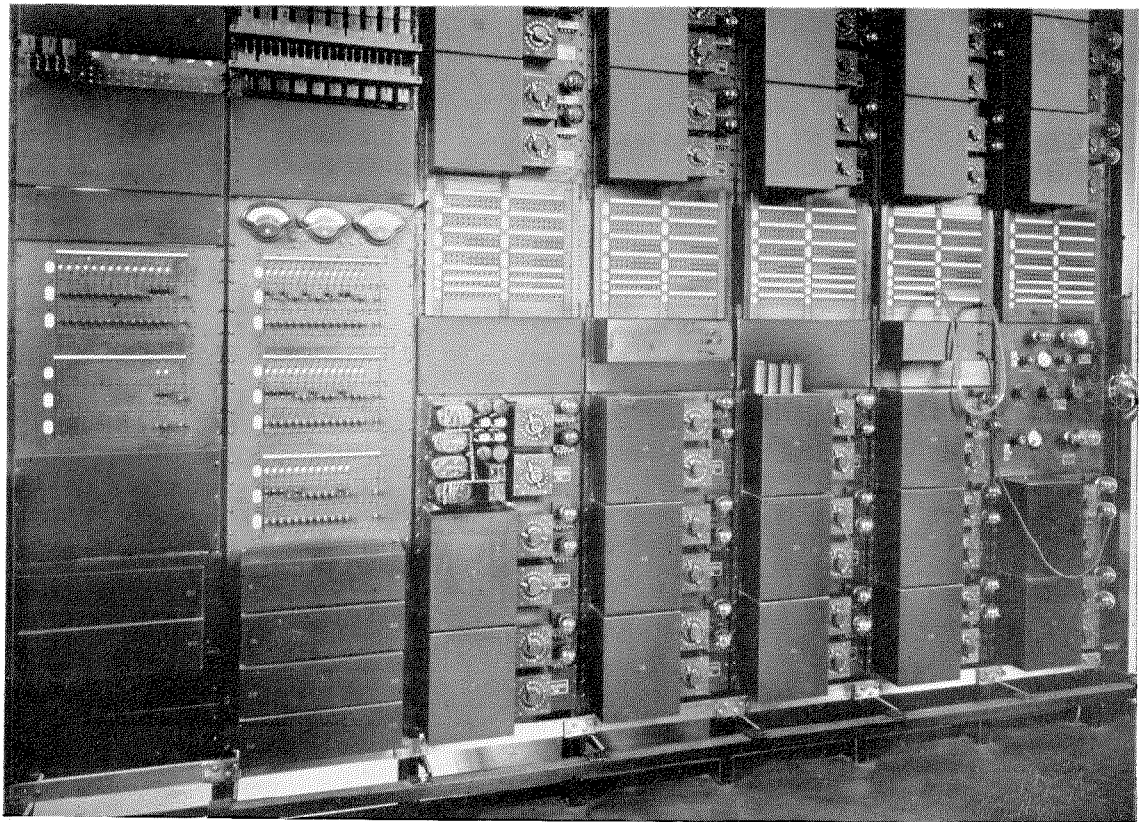

Figure 20—Repeater Rack



vides means for their testing and for the substitution of spare relays during this testing.

Figure 20 shows the arrangement on the repeater racks. On the left hand side can be seen

measuring the amplification). A view of a repeater unit with the protecting cover removed is shown on Figure 19 and the following pieces of apparatus can be seen, counting from the top

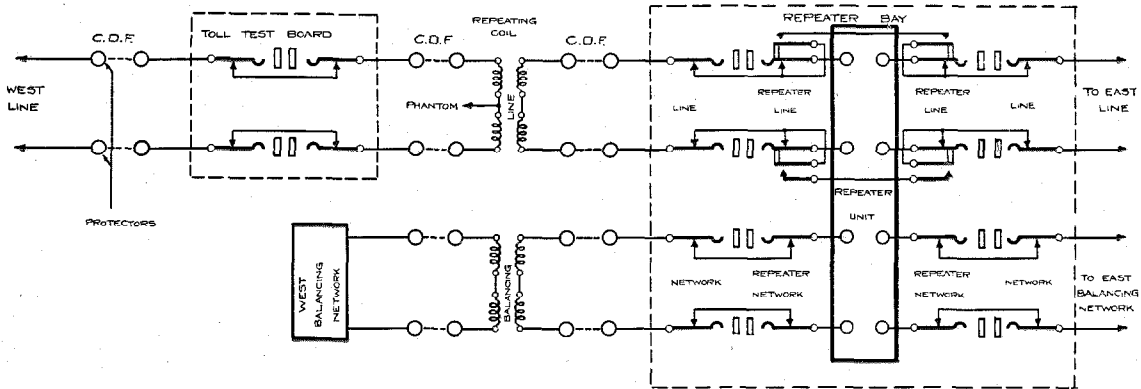

Figure 21—Through Cable Circuit

the measuring instruments and the switching keys, with which the voltage and current in all circuits for the repeaters can easily be read. Following the measuring and switching panels are the repeater bays in succession, each having 7 two-way repeaters and test jack panels (with exception of one, which only has 6 repeaters but which includes the necessary equipment for

left hand corner, downwards: output transformer East, retard coil in East plate circuit, the same for the West plate circuit and output transformer West; in second row we have: the relays 4006 O, B, A and C (see Figure 22); in third row: the relays 4006 P, D, E and W, together with the condensers in East and West output transformers. Then, outside the cover,

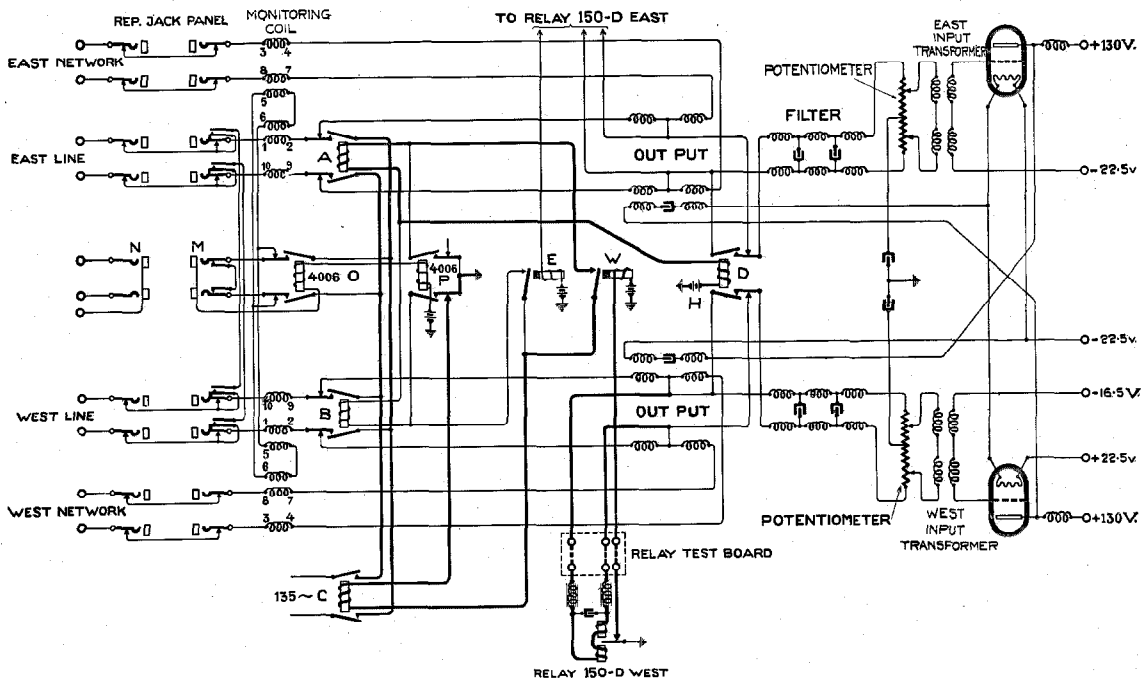

Figure 22—22-Type Repeater with Signaling Arrangements

the two potentiometers, and on the outer right hand side the two repeater tubes for lines East and West. The two filters are mounted on the back of the same plate.

The jack panels on each rack are divided in two panels. Each jack contains one wire so that a double plug is necessary to connect to a line. The 10 jacks on the top of the left panel are the line jacks for 5 cable circuits East, the 10 jacks on the top of the right panel are for the corresponding network circuits. The second jack strip from the top in left panel

line jacks of the other line by means of connecting cords.

Figure 22 shows the diagram for a repeater. The circuits for the speech currents are in accordance with the diagram Figure 4, and the description already given. The signaling arrangement is as follows: Current of 135-cycle frequency comes from West and operates relay 150-D West, the armature of which can follow the quick vibrations. This causes the opening of the ordinarily closed circuit through the slow-acting relay *W*, whose armature falls back but

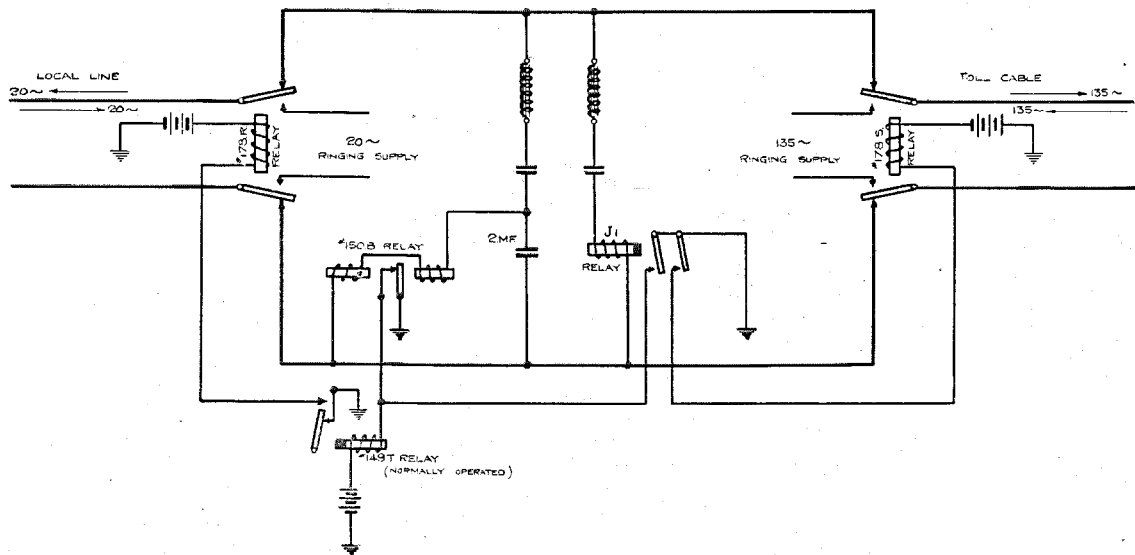

Figure 23—Composite Ringer

contains the jacks for the 5 cable circuits West, and the corresponding networks are connected to the jacks on the right-hand side panel. The third and fourth jack strips (see Figure 22) contain the repeater jacks for the same 5 cable circuits (West and East) and corresponding network jacks. The corresponding jacks for the remaining two repeaters on the same bay are located on the 5th, 6th, 7th and 8th jack strips in the same order as mentioned above. In the ninth strip, on both right and left panel, are arranged jacks marked "Monitor," so that the attendant may plug in and listen to the operation of any repeater. The bottom strip contains a series of jacks multiplied on the Toll Test Board and along the Repeater Bay. The repeater circuit can be transferred from its associated line to another line, by connecting between the repeater jacks of one line and the

does not again operate as long as the signaling period lasts. With relay *W* non-operated a circuit is closed, which provides current to relays *A*, *C* and *D*, from battery *H*. 135 cycle ringing current now passes relays *A* and *C* and out to East line, and at the same time the input circuit is short circuited by relay *D*.

In the Swedish telephone systems to which the cable circuits are connected, signals are transmitted over the talking circuits by means of alternating current of approximately 20 cycles per second. The Stockholm-Gothenburg cable system operates on 135 cycle ringing current, and arrangements are provided at the cable terminals of each circuit so that 20 cycle ringing current received at either terminal causes 20 cycle current to be delivered to the circuit connected at the other terminal. The transforming between the 20 cycle and 135 cycle

current is accomplished by means of a "composite ringer," the principle of which is shown in Figure 23.

These ringers are connected between each of the local station's lines and those of the main cable. The two relays  $J_1$  and 150-B are tuned

means of a connecting cord this circuit can be connected to the monitoring jacks ( $M$ ) of any repeater circuit so that the repeater attendant can talk or monitor. A repeater cut out key is provided, which, when operated disconnects the repeater to which the telephone circuit is

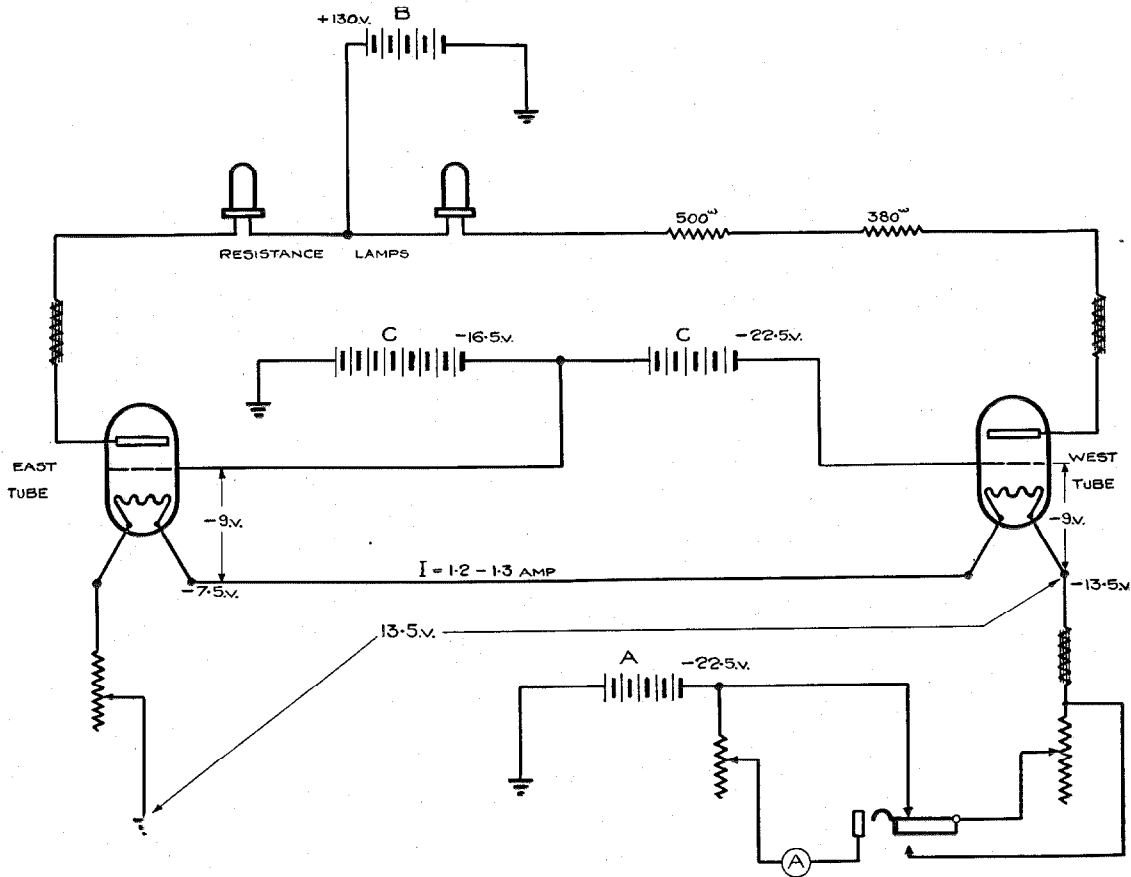

Figure 24—Battery Connections

for 20 and 135 cycles, respectively. Current of 20 cycles coming from the local station operates  $J_1$ , which sends current through 178-S, this relay sending current of 135 cycles to the cable circuit.  $J_1$  sends also current through 149-T, in case the 150-B should be operated by the 20 cycles thus opening the circuit normally closed through the 149-T.

The ringing current (135 cycle) from the cable causes 150-B to vibrate, 149-T disconnects, 178-R is operated and sends 20 cycle current to the calling relay in the local station.

Associated with a group of repeater circuits is a telephone and signaling circuit connected to the jacks designated as  $N$  on Figure 22. By

connected, from the toll line and closes the toll line circuit through the office without the repeater. Keys are also provided for the purpose of ringing, talking, and monitoring on the circuit. Monitoring is accomplished by means of the monitoring coil associated with each output transformer. Normally this coil is short circuited and causes practically no loss in the circuit. When the attendant is monitoring on the circuit the loss occasioned is very small.

The battery control panel at the left hand end of the repeater rack (see Figure 20) provides keys for switching the "A," "B" and "C" Batteries on or off from the repeaters. It is also equipped with ammeters and voltmeters and is

arranged for the rapid inspection of the filament and plate currents and for the checking of all battery voltages.

Figure 24 illustrates the method of battery arrangements and shows the values of current and voltages to be obtained.

The amplification given by the different tubes can also be easily examined by means of the apparatus, shown in Figure 20 on the

forms part of a circuit containing the repeater whose gain is to be measured, and the other being contained in a reference circuit. An amplifier-detector combination amplifies the voltages across these resistances and then rectifies them so as to obtain a deflection on the direct current galvanometer. The circuits are so designed that when equal voltages are produced across the terminals of the two resistances equal

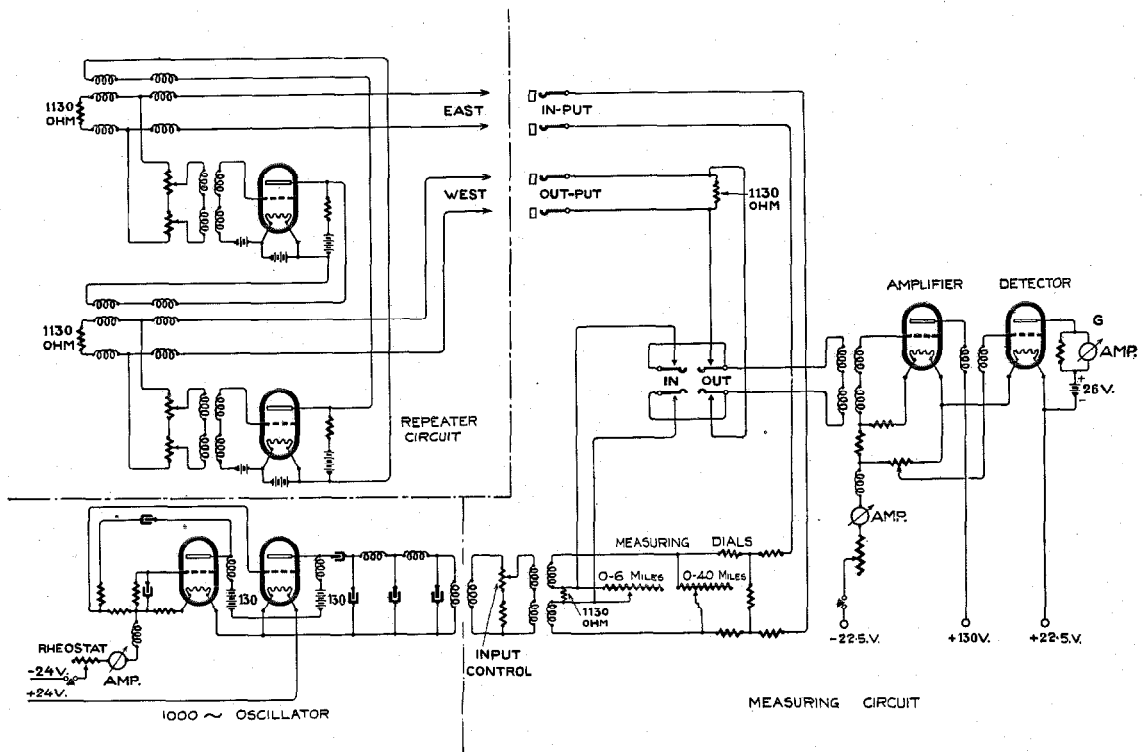

Figure 25—Measurement of Repeater Gain

extreme right immediately under the jack strips. A line schematic of this apparatus is given in Figure 25. In the middle of the apparatus panel to the extreme left is the "Input Control" and in line with this a rheostat for 0.5 to 6.0 S.M. and a rheostat for 5 to 40 S.M. Furthest to the right on the same panel is the switch key "In—Out." In the panel over this are the rectifying tubes and the meter *G*. The bottom panel contains the oscillator for the measuring current of 1,000 cycles and rheostat for controlling the filament current.

Measurements of gain are made by comparing the voltages across the two 1,130 ohm resistances in the measuring circuit, one of which

deflections will be produced on the galvanometer, and the gain of the repeater is read directly from the dials controlling the variable shunts. With this apparatus the gains of repeaters can be measured to within a few tenths of a standard mile. For routine testing in the repeater station, measurements of repeater gain are made at 1,000 cycles from the associated oscillator. The measuring circuits are, however, independent of frequency, since they are composed entirely of resistances, so that gains can, if required, be measured at any telephone frequency.

The actual method of measuring the amplification is as follows: For the repeater to be mea-

sured the balancing networks are cut out and replaced by 1,130 ohm resistances; the repeater jacks for the East line (see Figure 22) are connected by cords to the input jacks of the measuring circuit, and the West repeater jacks to the output jacks of the measuring circuit. The potentiometer of the West repeater is set on zero so as to short circuit the primary winding in the input transformer. The potentiometer for East tube is on the setting for which the amplification is to be measured. The oscillator

than 10 miles. By means of the 5-mile and 0.5 mile rheostats and the "Input Control," the deflection is regulated until it is 50 degrees in both positions of the key. The effective amplification in standard miles is then the sum of the readings of the two rheostats.

#### POWER SUPPLY

The power arrangements in the different repeater stations are relatively large. In

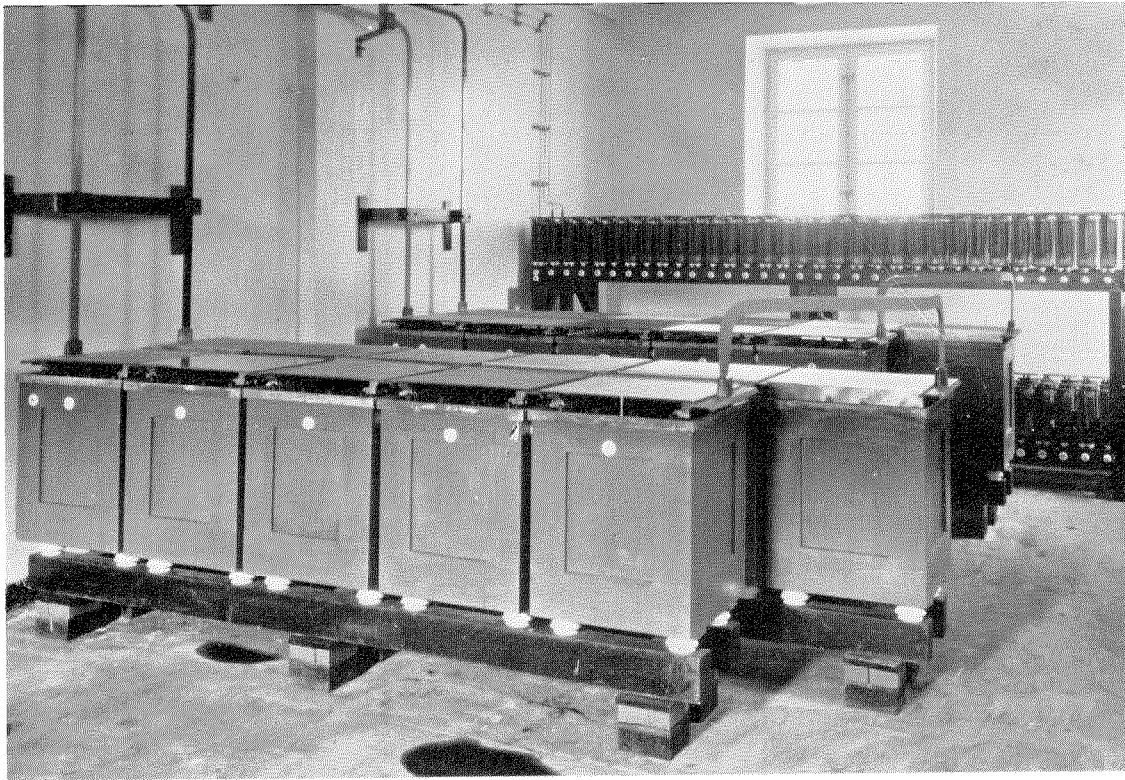

Figure 26—Battery Room

giving alternating current of 1,000 cycles is switched on and the filament current regulated.

The rheostat, calibrated to 5 miles for each step, is set at a value believed to be correct, for instance, 10 miles. The key "In—Out" is switched to "In" and the setting is changed on the potentiometer "Input Control" until the deflection of the galvanometer *G* is 50. The key is switched over to "Out" position and the deflection is read. If this is larger or smaller than 50, the amplification is smaller or larger

Alingsås, for instance, two "A" batteries are located, each with 11 cells and about 2,000 ampere hours, which may be increased to a maximum of 3,500 ampere hours. Figure 26 is a photograph of a typical battery room. For charging, a direct coupled motor-generator set is installed giving about 600 amperes. This generator may also be driven by a Diesel motor (see Figure 27) in case of power failure. If necessary, a special generator, constructed for this purpose, giving 225 amps. may be added



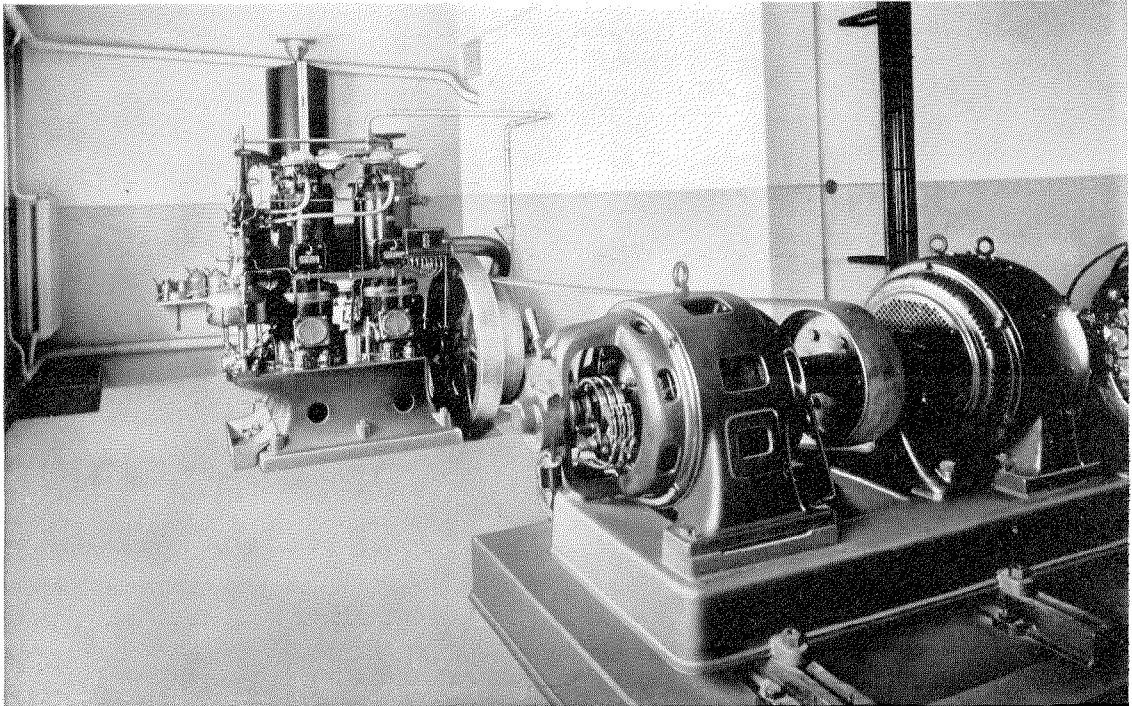

Figure 27—Alingsås Machine Room. Motor Generators and Reserve Diesel Motor

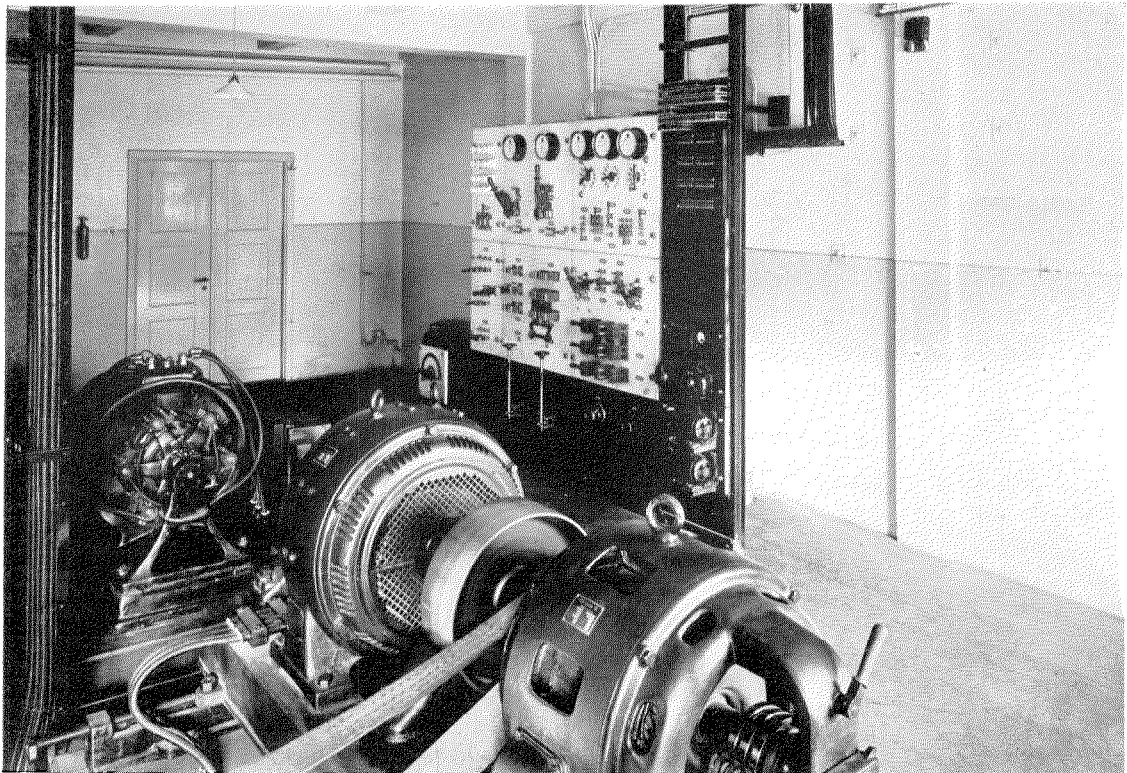

Figure 28—Machine Room Alingsås. Motor Generators and Power Board

to the battery (see Figure 28). Each 22-type repeater takes about 1.25 amperes for about 22.5 volts. Two 130 volt "B" batteries of about 100 ampere hours, for supplying the plate voltages are located in each station. The plate

repeater circuit for the obtaining of the correct currents and voltages.

In conclusion, I have given, in Figure 29, a diagram showing the distribution of the circuits in the main cable. Repeaters are indicated by

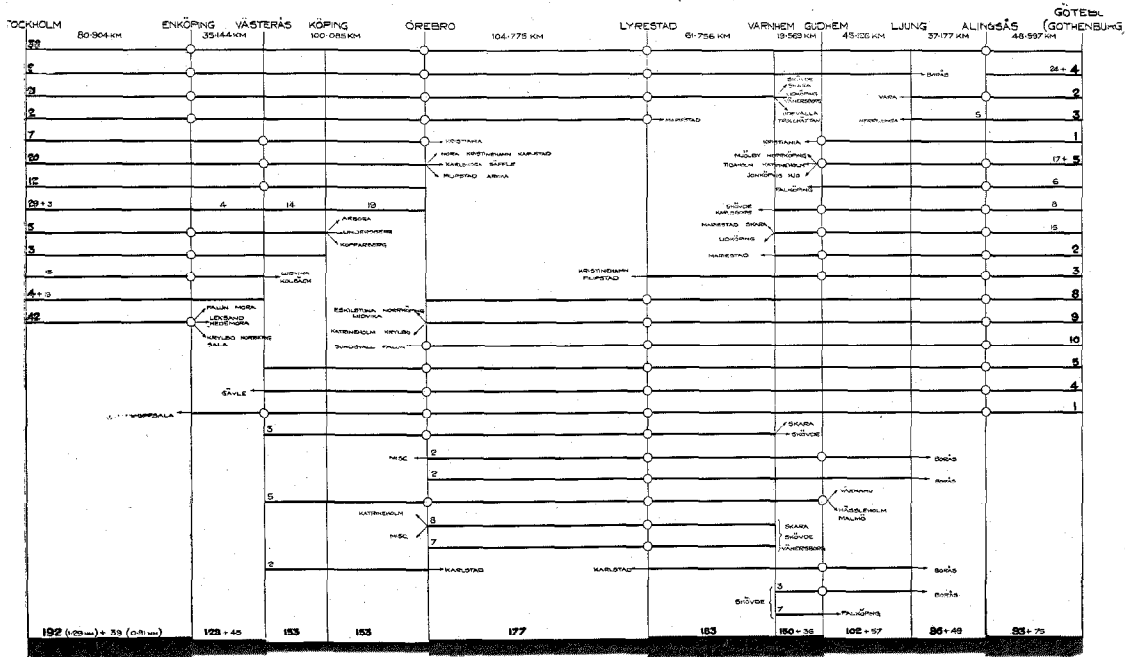

Figure 29

current is small, not exceeding 0.016 ampere for one two-way repeater. The "C" battery which supplies the grid voltages has a total voltage of about 22.5 volts with 3 to 4 ampere hour capacity. It has not been considered necessary to supply a spare "C" battery.

As previously mentioned Figure 24 shows the method of connecting the batteries to the re-

peaters, for instance, taking the Stockholm-Göteborg circuits, repeaters are shown in Enköping, Örebro, Lyrestad and Alingsås. The wide black band at the bottom of this figure represents the circuits, both physical and phantom, existing in each repeater section. The total length of circuits, physical and phantom, in the whole cable, is 82,000 kilometers of 1.29 mm. and 11,500 kilometers of 0.91 mm. conductors.

# Permalloy, A New Magnetic Material of Very High Permeability

By H. D. ARNOLD and G. W. ELMEN

*Engineering Department, Western Electric Company, Incorporated*

*Synopsis:* The magnetic alloy described in this paper is a composition of about 78.5% nickel and 21.5% iron and at magnetizing fields in the neighborhood of .04 gauss and with proper treatment has a permeability running as high as 90,000. This is about 200 times as great as the permeability of the best iron for these low magnetizing fields. This high permeability is attendant upon proper heat treatment and also upon other factors among which is freedom from elastic strain. The presence of other elements than iron or nickel and specially carbon, reduces the permeability, but slight variations in heat treatment produce large changes compared with those due to small quantities of impurities.

So far as discovered, other physical properties show no peculiarities at the composition which brings out the remarkable magnetic properties of permalloy. The equilibrium diagram, electric conductivity, crystal structure, mean spacing between adjacent atom centers and density are among the physical properties which have been studied.

To the engineer in electrical communication the development of permalloy is very significant. It assures a revolutionary change in submarine cable construction and operation and promises equally important advances in other fields.—EDITOR.

SOME time ago it was discovered in the Bell System laboratory that certain nickel-iron alloys, when properly heat-treated, possess remarkable magnetic properties.<sup>1</sup> These properties are developed in alloys which contain more than 30 per cent of nickel and which have the face-centered cubic arrangement characteristic of nickel crystals, rather than the body-centered structure characteristic of iron. The entire range above 30 per cent nickel exhibits these properties to some degree and offers new possibilities to those interested in magnetic materials. The most startling results, however, are obtained with alloys of approximately 80 per cent nickel and 20 per cent iron, whose permeabilities at small field strengths are many times greater than any hitherto known. To alloys of this approximate composition we have given the name "permalloy." The development of permalloy has assured us a revolutionary change in submarine cable construction and operation, and promises equally important advances in other fields of usefulness. It also presents questions of great interest to the scientist, and emphasizes again the meagreness of our

fundamental information about ferromagnetism. The present paper is intended to give a general discussion of the preparation and testing of permalloy, with sufficient detail to indicate its unusual characteristics. Detailed statements of numerical results are reserved for publication in separate articles dealing with specific properties.<sup>2</sup>

In making permalloy we use the purest commercial nickel and Armco iron. Our samples for laboratory study are prepared by melting these metals in a silica crucible, using a Northrup high-frequency induction furnace. The particular furnace which we use will conveniently melt a charge of about six pounds. An analysis typical of the resulting billets is as follows:

Ni	78.23
Fe	21.35
C	.04
Si	.03
P	trace
S	.035
Mu	.22
Co	.37
Cu	.10

The presence of other elements than nickel and iron is of course to be expected after any practical method of preparation. To determine their effects, samples were prepared in which the usual impurities were present in various proportions. It was found that their presence does effect the permeability of the alloys and that carbon is especially harmful. Since, however, the variations produced by slight changes in heat-treatment are very large compared with those due to small quantities of impurities we have found it unnecessary for most purposes to require higher purity than that indicated in the analysis above given.

In our laboratory studies we have made it a practice to reduce the billets through the forms

<sup>1</sup> British Patent No. 188,688.

<sup>2</sup> L. W. McKeehan, The Crystal Structure of Iron-Nickel Alloys, *Phys. Rev.* (2), 21, (1923).

of rod and wire to tape 3.2 mm. wide and 0.15 mm. thick. Accordingly test samples are available in a variety of forms and conditions. Thin narrow tape is particularly adapted to use in experiments involving heat-treatment, since it possesses a high ratio of area to volume and is easy to manipulate. Fortunately the entire nickel-iron series can be mechanically worked if sufficient care is exercised and we have thus been able to use samples of the same size, shape, and mechanical condition in all measurements upon which we have based comparisons between alloys. This practice has also made possible strictly comparable micrographic studies throughout the series.

Permeability is the magnetic characteristic of permalloy in which we first became interested and we have used its numerical value as an index in establishing the effects of mechanical and thermal treatments. Most of the measurements have been made in a ring permeameter of special design. The ring sample is prepared by winding twenty or more turns of tape around a disk about three inches in diameter. The disk is then removed leaving the material in the form of a spirally laminated ring with a rectangular cross-section approximately 3.2 mm. by 6 mm. A single massive copper conductor is linked with this ring, and constitutes also the secondary of a transformer whose primary winding forms one arm of an inductance bridge. From the bridge measurements, and the dimensions of the ring the permeability of the latter may readily be computed. For most of the measurements 112-cycle alternating current has been employed, permitting the use of telephone receivers in adjusting the balance of the bridge. The ring is sufficiently well laminated so that no serious troubles are introduced at this frequency by eddy currents. This fact was verified by making a number of permeability determinations at alternating current frequencies both above and below that chosen for routine use, and also by comparing the results of ring permeameter tests with those of ballistic tests on specially wound ring samples. The bridge method is particularly well adapted to the measurement of permeability in very weak magnetic fields since amplifiers may readily be used to increase the delicacy of the bridge adjustment to almost any degree desired. As a

matter of convenience we have usually included in our test program measurements with fields of 0.002, 0.003, and 0.010 gauss, and on the graph of permeability against magnetizing field strength the straight line through these points has been extended to field strength zero. We have called the permeability read from the graph at this point the "initial permeability" of the sample.

The form of permeameter used is especially adapted to making measurements quickly and with minimum handling of the sample, since it makes use of but a single magnetizing turn. The ring is laid on suitable insulating supports in an annular copper trough, and placing the copper cover on this trough completes the electrical circuit. In a modified instrument, the "hot permeameter," provided with a heating device, permeabilities may be measured from liquid air temperatures up to about 1000°C. without altering the position of the sample.

The heat-treatment of permalloy is of the utmost importance. To develop its maximum initial permeability it must be cooled not only through the proper temperature ranges, but also at the proper rates. It is obvious that only a small part of any sample can be given the most favorable treatment, since the interior portions of the sample cool at rates which are dependent upon the geometrical configuration and thermal properties of the material and are only indirectly under the control of the experimenter. For these reasons each shape and size of sample will have its own best heat-treatment and it is obviously difficult to establish the correct heat-treatment for a small element of volume, characteristic of permalloy as a material. By the use of thin tape, however, we secure fairly uniform treatment of the whole volume so long as the cooling is not too rapid, and fortunately the best cooling rate is not much different from the normal cooling rate of the tape in the open air. It has been found that temperature changes below 300°C. have very little effect upon the resultant properties of permalloy, but the rate of cooling from just above the magnetic transformation temperature down to about 300°C. is a controlling factor. By a long series of experiments a heat-treatment has been established which is especially well adapted to the permalloy test rings already described. They are first heated at

about 900°C. for an hour and allowed to cool slowly, being protected from oxidation throughout these processes. They are then reheated to 600°C., quickly removed from the furnace and laid upon a copper plate which is at room temperature.

Not only does each size and shape of sample require its own special heat-treatment, but samples differing only in composition also differ in their most suitable heat-treatments. In our investigation of the nickel-iron series we have not, however, attempted to determine the best heat-treatment for ring samples of each of the many alloys studied. By careful exploration we

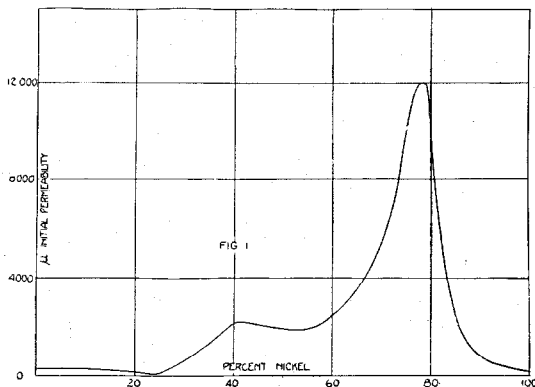

Figure 1

located the region about 80 per cent nickel, 20 per cent iron as the one promising the highest initial permeability and established the best heat-treatment for this composition. Keeping this treatment unchanged we then relocated the best composition, finding it to be at about 78.5 per cent nickel, 21.5 per cent iron. There is a maximum temperature in the equilibrium diagram for this binary at about 70 per cent nickel,<sup>3</sup> and it was natural to suspect that the maximum in initial permeability which we had found at 78.5 nickel might be displaced to 70 nickel by proper treatment. The 70 per cent nickel alloy was accordingly subjected to a great variety of heat-treatments, but no method was found capable of producing in it an initial permeability as high as that readily obtainable in the 78.5 per cent nickel alloy.

Figure 1 shows the general way in which initial permeability has been found to vary throughout the nickel-iron series when the heat-

treatment determined as best for the 80 per cent nickel alloy is used. It is obvious from what has been said above that too much weight must not be given to the actual values recorded at any composition. Had the best heat-treatment been determined for each sample the curve might have been altered considerably in detail, particularly outside the permalloy range. We believe, however, that its general form is approximately correct. Alloys were made at 5 per cent steps throughout the range except in the vicinity of 80 per cent nickel where a great number of slightly different compositions were investigated. The chemical analysis, rather than the intended composition, was used in every case, although the difference was never considerable.

The largest value of initial permeability for permalloy at room temperature which we have so far found in the ring permeameter is about

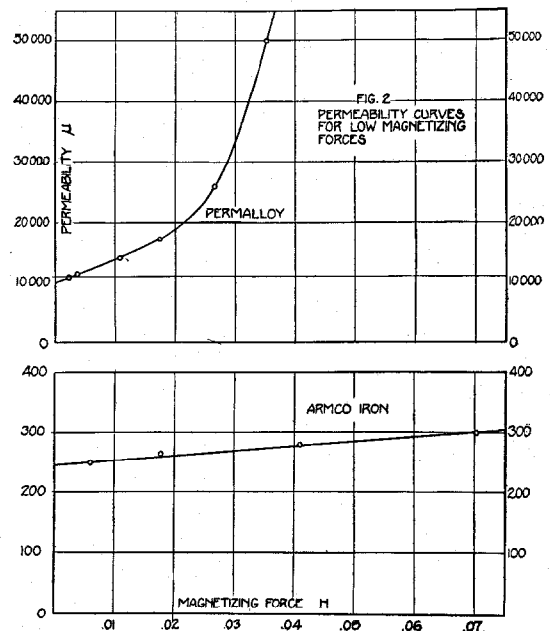

Figure 2

13,000, more than 30 times the corresponding value for the best soft iron. How extraordinary this is may be appreciated by considering that this material, although it has a saturation value of magnetic intensity comparable with that of iron, approaches magnetic saturation in the earth's field. Unusual caution must therefore

<sup>3</sup> Bureau of Standards Circular No. 58, April 4, 1916.

be exercised in measuring the properties of permalloy to protect the sample from the influence of stray magnetic fields. Figure 2 shows, to different scales, the values of initial permeability in similar ring samples of permalloy and of annealed armco iron, and small portions of the corresponding  $\mu$ -H curves from which these were obtained.

We have measured the magnetization of permalloy at saturation and find that it is not sensitive to heat-treatment. The saturation values of magnetization per gramatom are

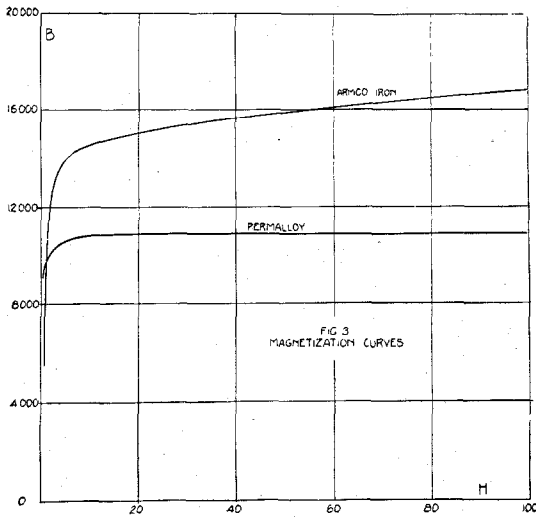

Figure 3

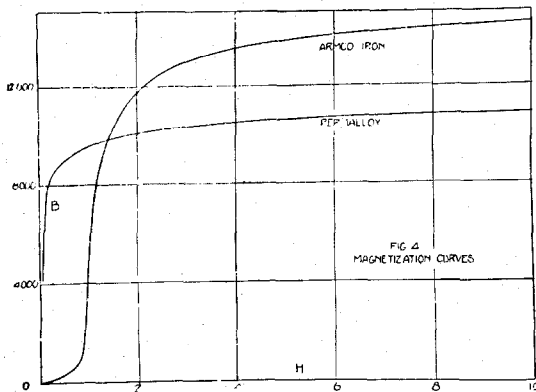

Figure 4

known to vary almost linearly with composition throughout the nickel-iron series, from 222 for iron to 59 for nickel.<sup>4</sup> The value 84 which we have found for the 78.5 per cent nickel alloy is therefore not abnormal.

<sup>4</sup> P. Weiss, Faraday Society Trans. 8, 149-156 (1912).

The magnetic characteristics of heat-treated ring samples of the same alloy have also been determined through a wider range of field strengths by ballistic methods. Figures 3, 4, and 5 show B-H curves for such a sample of permalloy and for a sample of annealed armco iron. From Figure 5 is apparent the enormous susceptibility of the former material in the weak fields so

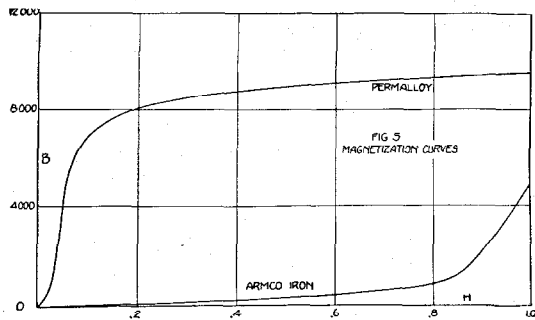

Figure 5

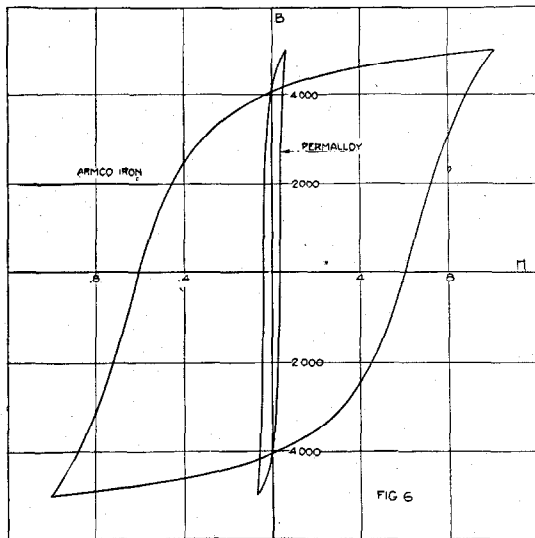

Figure 6

important in communication engineering. Figure 6 shows for the same two materials hysteresis loops carried to a maximum induction of 5,000 maxwells. The area of the permalloy loop is only one-sixteenth that of the loop for soft iron. Figure 7 shows the  $\mu$ -B curves for these materials. The maximum permeability here shown  $\mu = 87,000$ , which is not exceptionally high for permalloy largely exceeds the highest values

obtainable in silicon steel<sup>5</sup> and of course occurs at a much lower flux density.

Early in the investigations it was found that heat-treated permalloy is sensitive to strain, and the routine measurements were so conducted as to avoid this disturbing effect. Separate investigations of the effects of strain upon perme-

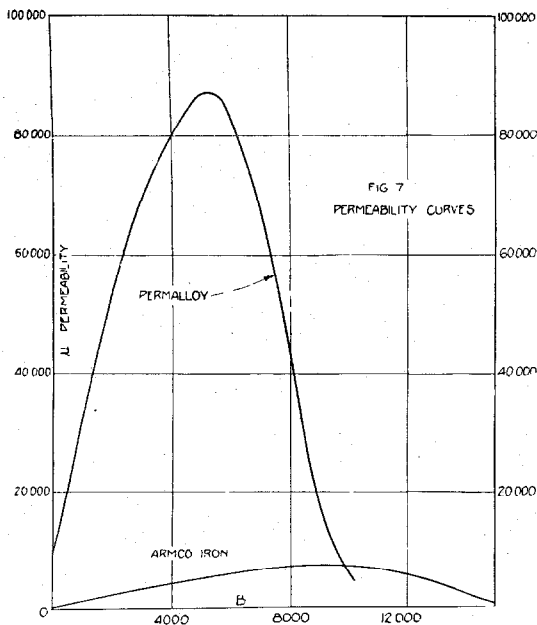

Figure 7

ability and electrical conductivity in straight samples, and of the converse effects of magnetization upon dimensions and conductivity were also undertaken. While these studies are not yet complete it can be stated that all these effects are large in comparison with the corresponding effects in hitherto available magnetic materials. So long as the elastic limit of the material is not exceeded the effects due to strain are reproducible and disappear when the strain is relieved. The effects of magnetization, however, show the expected hysteretic properties. As an example of the magnitude of the effects producible it may be stated that between its value in the unstrained condition and about one-tenth that value the initial permeability of a heat-treated strip of certain of these materials can, by the mere variation of strain, be

adjusted to any value we may for the moment desire. The range through which the conductivity can similarly be adjusted by strain is much narrower, the maximum reduction being about 2 per cent, which, however, is a large effect compared with that found in other metals.

The effect of magnetization in reducing conductivity is as much as 2 per cent for fields of the order of one gauss. This makes it easy, for example, to measure the earth's magnetic field to within about 1 per cent by finding the strength of the opposing field necessary to give a permalloy strip its maximum conductivity. It will be noted that the conductivity change which we have mentioned as attainable by magnetization is the same as that attainable by elastic strain. This is no mere coincidence, for we find that the maximum change due to either cause alone is not further increased by superposition of the other, although the effects of small tensions and magnetizing fields are additive. This suggests, of course, that both causes ultimately produce the same change in the mechanism responsible for conduction.

Since the effect of tension upon permeability is in some of these cases so marked it seemed surprising that the only reported study<sup>6</sup> of the converse effect, that is of magnetostriction, indicated a zero value within the permalloy range. It appeared advisable therefore to study the magnetostriction of the series of alloys here available. Preliminary results indicate that under usual conditions of experiment, heat-treated 78.5 per cent nickel alloy exhibits larger magnetostriction than does iron.

With the remarkable ferromagnetic behavior of permalloy in mind one naturally looks for analogous peculiarities in its other properties. As has been shown, however, the equilibrium diagram does not point accurately to the composition exhibiting highest initial permeability. The conductivity curve is even less indicative of a peculiarity at this point, its minimum lying at about 35 per cent nickel. The crystal structure is that of nickel and its type does not change until the nickel content is made less than 35 per cent. Even the mean spacing between adjacent atom-centers, and with it the density, varies

<sup>5</sup> T. D. Yensen, U. S. Patent 1,358,810.

<sup>6</sup> K. Honda and K. Kido, Tohoku Univ. Sci. Rep., 9, 221-232, (1920). It should be noted, however, that their alloys had received different treatments than ours.

continuously throughout the entire range. Our experience in working these alloys also indicates that the series has no mechanical peculiarities at or near 80 per cent nickel. Not only do these characteristics indicate no abnormality as the nickel content is increased beyond 70 per cent, but, what is more surprising they are little affected by the heat-treatments which so profoundly change the magnetic properties. So far as has been determined, therefore, it is only in connection with its magnetic properties that permalloy is unusual.

To the engineer the discovery of permalloy means the realization of plans long impossible of accomplishment for lack of a suitable material. For the scientist the principal interest in these materials may well lie in the large response

of their magnetic properties to simple external controls. Without alteration of composition these properties may be adjusted through extraordinary ranges by strain, by magnetization, or by heat-treatment. This allows a more definite study of the way in which these factors are related to magnetic properties than has been possible with materials hitherto available in which their effects are comparatively small and may be associated with complicated and irreversible changes in other properties. The behavior of permalloy demonstrates that ferromagnetism is associated with material structure in a different way than are the ordinary physical and chemical properties and its extreme sensitiveness to control gives us a powerful method for use in magnetic investigations.

---



# Permalloy Loaded Cable

By F. B. JEWETT

*Vice-President, International Western Electric Company*

**T**HE invention of a new alloy called "permalloy" and the "permalloy loaded cable" is possibly the most important development in the whole history of cable construction since the first transoceanic cable was laid. It has unusual significance for it is the first radical change in cable construction in more than fifty years. It is expected that cables of the new type will have a traffic capacity four times that of existing cables of the same size.

The new invention may mean the construction and laying of direct cables of a length hitherto impossible on account of cost or limits of traffic capacity. In fact, the possibilities of the new cable from a traffic carrying standpoint seem to be such that direct cables could be laid over much longer routes than there is any commercial necessity for.

While this new cable using permalloy does not forecast the replacement of any existing means of transoceanic communication, the fact that it offers a very large increase in traffic capacity over long distances will undoubtedly result in a realignment of the fields of various kinds of world communication. Its introduction will tend to clarify the situation regarding the dividing line between the real fields of radio and cable in transoceanic communication.

The new cable makes use of inductive loading with the magnetic alloy, permalloy, developed by the engineers of the Western Electric Company in the Bell System Laboratories. The first cable of the new type has been ordered by the Western Union Telegraph Company, to be laid between New York and the Azores where it will connect with another new cable running to Italy. This will provide greatly improved telegraph service to the South of Europe.

Ever since the first successful transatlantic cable of 1858, cables have been of essentially the same type, though through the intervening years the size has been gradually increased until in the most recent long cable 1,100 pounds of copper per mile have been used. In contrast to developments in other electrical arts, submarine cables have been slowly and conserva-

tively developed, this course being to some degree necessitated by the great expense and risk involved in cable undertakings.

The feature of the new cable is inductive loading by the newly developed magnetic alloy. The idea of loading is not new and may be very simply explained. Signals are transmitted over cables and wires as in radio by waves, but instead of spreading out in all directions as do waves from a wireless antenna the waves over a wire or cable are confined to one path with the consequent advantages of secrecy and a saving of power. However, there is one important difficulty in sending waves over a long submarine cable of the ordinary type. The wave is started out as a strong current impulse or a steep wave front, but as it proceeds along the cable it flattens out so that instead of reaching the other end all at once it comes in as a long slowly rising electric current, and if a rapid succession of such waves are sent they spread into each other or overlap to such a degree that their identity is lost. The effect of loading the cable is to prevent the wave front from spreading out.

"Loading" the cable means simply giving it more inductance. Inductance opposes the building up of an electric current in a circuit but once it has been established tends to keep that current flowing. This is just the action required to keep up the wave front of a signal on a cable. The inductance opposes the rise of current until the full force of the wave is felt, then when the current is flowing it aids it in continuing to flow and thus helps push the wave along. Thus with a loaded cable the wave does not spread out as in the present non-loaded cables but reaches the distant end with its energy concentrated in one blow and without having got lost in the crowd of other signals along the way. This permits sending the dots and dashes which make the telegraph signals in more rapid succession, and consequently more letters and words can be transmitted in a given time. On this account the "speed" of the cable is said to be greater.

This does not, however, mean that the signals travel faster on the loaded cable in miles per minute. In fact they travel more slowly since the inductive loading while holding up the wave front tends to retard their progress along the cable. In the case of the New York-Azores cable it will take three-tenths of a second for signals to get from one end to the other, but they will be following each other in such rapid

Heaviside, an Englishman who first conceived the idea, and Pupin and Krarup, each of whom proposed a method for its application. Professor Pupin of Columbia University proposed the insertion of inductance coils at intervals along the line. This method has been applied to long telephone lines on land, but it is not applicable to ocean cables on account of the mechanical difficulties involved. Krarup, a Danish en-

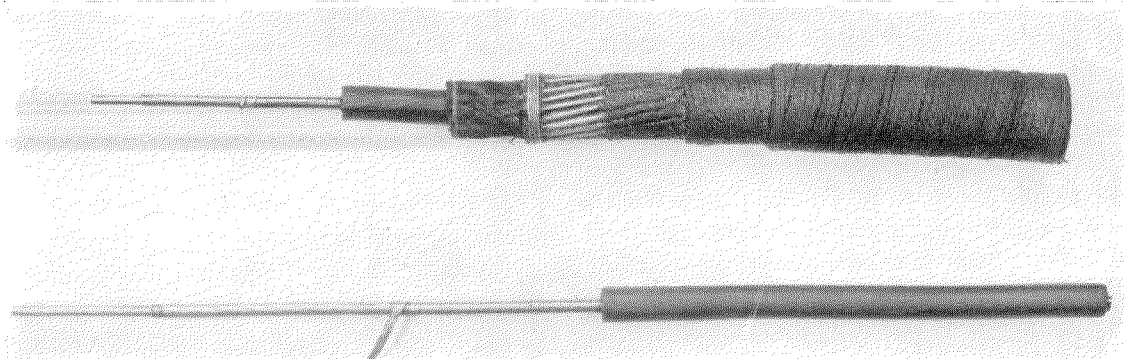

Permalloy Loaded Type Cable

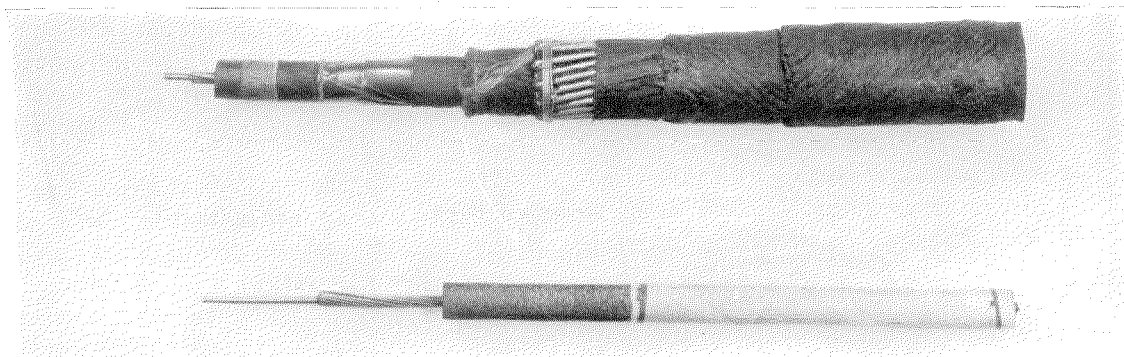

Old Type Cable

succession that it will take six automatic type-writing machines to handle the volume of traffic flowing over the cable when operated at maximum speed.

Although the fundamental principles of loading have been studied extensively for many years and many inventors have considered its application to ocean cables, it has become practicable for long ocean telegraph cables only recently by virtue of the peculiar properties of "Permalloy." In the mind of the engineer three names are associated with the inductive loading of long lines and cables. These are

Heaviside, an Englishman who first conceived the idea, and Pupin and Krarup, each of whom proposed a method for its application. Professor Pupin of Columbia University proposed the insertion of inductance coils at intervals along the line. This method has been applied to long telephone lines on land, but it is not applicable to ocean cables on account of the mechanical difficulties involved. Krarup, a Danish en-

gineer, proposed wrapping an iron wire around the copper wire which carries the current. The new cable is loaded continuously, corresponding in this respect to the method of Krarup, but the properties of the new loading material, "Permalloy," are widely different from those of the material used by Krarup, namely iron. In construction the new cable is surprisingly like the old. It differs from it only in having a thin permalloy tape wrapped around the copper wire beneath the gutta-percha insulation. Though the tape is only six-thousandths of an inch thick it strengthens the magnetic field in

the region where it lies by more than 2,000 times. The same amount of iron would not produce one-tenth the effect. In fact, if an iron tape were used in place of the permalloy the loss occasioned by its use would more than offset the gain, and this is the reason that telegraph cables have never been loaded.

"Permalloy" was not found by any single experiment, nor was it reached as a result of a dreamer's brilliant idea. It was not even found by merely mixing its component parts, nickel and iron, together in different proportions and picking out the best. Special methods of testing had to be developed to detect the properties being sought for and then the effect of heating to high temperature and cooling at various rates had to be tried with all of a wide variety of mixtures before the best was found. Then hundreds of sections of cable conductor were tested and after several years of this patient work the desired result as far as could be ascertained from laboratory tests, was finally achieved.

Since there are no submarine cable manufacturers in America, arrangements had to be made for an English concern to make the first cable of the new type. The Telegraph Construction and Maintenance Company of London, long preeminent in this field, undertook the manufacture with the advice and assistance of engineers of the Western Electric Company who supplied the permalloy tape for the cable.

Most of the electrical tests in the laboratory had been made upon pieces of cable not over 300 feet in length. A cable such as that between New York and the Azores is over 2,000 miles in length, and its cost is several millions of dollars. It was not satisfactory on the basis of the laboratory results alone to put through a project such as the cable from New York to

the Azores. It was accordingly decided to make an experiment of laying a trial section of cable, 120 miles in length, in the full depth of water which is met in mid-ocean.

Bermuda was selected as a suitable place for making the test, partly because of its accessibility to New York and partly because the deep water near shore permitted a very severe test and it was desired to make the test as severe as possible. On September 14 the Western Union Cable Ship, *Lord Kelvin*, sailed from London with the 120 miles of cable aboard and after a delay of a few days occasioned by a West Indian hurricane the cable was successfully laid off the south coast of Bermuda on October thirteenth.

To test the cable both ends had to be available to the operators, and it was therefore laid as a loop, most of it being in water more than two and one-half miles deep. Several weeks were required to make the tests which would prove the cable to be what the engineers had predicted. When the word of the successful result reached the Western Union Telegraph Company, orders were given to the manufacturing company to go ahead at once to make a cable of 2,300 miles to reach from the Hammels station at New York to Fayal in the Azores Islands.

This cable is such a radical departure and offers such a great advance over the present art that it is too early to predict what its effect on world communication will be. Its possibilities in the Pacific are even more interesting than in the Atlantic on account of the present need for increased communication there. But there is one comforting thought about improvements in communication. They always react to the benefit of the public and always in the direction of better understanding and peace among men.

---

# The New Shisakajima Submarine Cable

By K. KAWAKAMI and K. SHIMIZU

*Engineers, Sumitomo Electric Wire & Cable Works, Ltd.*

**I**N the Autumn of 1922, a submarine power cable thirteen miles in length was laid between the town of Niihama and Shisaka Island. This cable is one of the longest of its type that has yet been installed and it is interesting to note that it is entirely of Japanese design and manufacture and was installed by Japanese engineers.

The Shisakajima, or Shisaka Island, is located in the Inland Sea, famous for its beautiful scenery, midway between the coast town of Niihama on Shikoku and the coast city of Onomichi on the mainland of Japan. Prior to its lease by the Sumitomo Goshi-Kaisha and the erection there of the Company's copper smelter and refinery, Shisakajima was used only as a loading place for fishing boats.

The Sumitomo Goshi-Kaisha has owned from olden times a copper mining concession in the Besshi, some miles inland from Niihama; the ore from this mine being transported to Shisakajima for smelting and refining. In this smelting and refining process, approximately 1,000 K.W. of electric power is required and prior to the installation of the cable this power was generated on the island by the use of coal. As the hydro-electric development at the Besshi mine provided a surplus of power, which could be generated at a much lower cost than at the coal burning plant at the smelter, a study was undertaken of the possibility of transmitting this hydro-electric power from the Besshi to Shisakajima.

The questions which confronted the Sumitomo people were, whether power could be transmitted through a submarine cable of this length with full assurance as to continuity of service; if a suitable cable could be manufactured and installed which would have a satisfactory working efficiency; and whether with the depth of water to be encountered—maximum 170 feet—the pressure would be sufficient in the event of puncture for the water to seriously damage a considerable section. After long consideration, it was decided to go ahead with the work and a contract for the cable was placed with the

Sumitomo Electric Wire & Cable Works, Ltd., of Osaka, in April, 1922. Manufacture was completed in August, installation begun in October and the final test completed on November 29, 1922. The cable has been in service since this date and has given complete satisfaction.

Power is generated at the Hadeba hydro-electric station at 3,450 volts, 30 cycles. The pressure is then stepped up to 18,165 volts and transmitted by an aerial cable—3 phase, 3 wire system—to the Niihama station, a distance of 6.5 miles; at which point the pressure is reduced

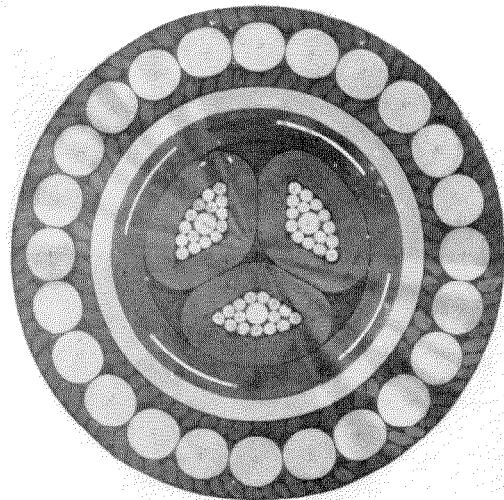

Figure 1

to 11,000 volts and transmitted by three aerial cables of No. 0 B&S gauge to the Isoura switch station, located near the shore of Shikoku Island. This switch station serves to connect the aerial and submarine cables, a similar arrangement being adopted at the landing on Shisaka Island whence power is carried over aerial wires to the plant, the pressure being reduced to 3,300 volts, at which voltage the power is used for service.

The cable is of the 3-core paper insulated, lead covered and galvanized iron wire armoured type; a cross-sectional view being shown in Fig. 1. The conductor is composed of annealed copper wires stranded into sector form, insulated

with manila paper, three cores laid up circular with wormings of jute yarn and further insulated with manila paper. The core is further wrapped with thin strips of copper laid side by side with proper clearance between and further insulated with manila paper. The core is dried under vacuum, impregnated, lead covered, jute served and armoured with galvanized iron wires and finally served overall with jute yarn.

the insulated pairs with the three insulated power conductors, which makes the diameter of the cable unduly large, particularly so with the sector shaped conductors. Furthermore, the insulation on the telephone conductors must be comparatively heavy so as to avoid breakdown of the insulation, and this also makes the diameter of the cable greater. The present type of cable is far more economical, easier to

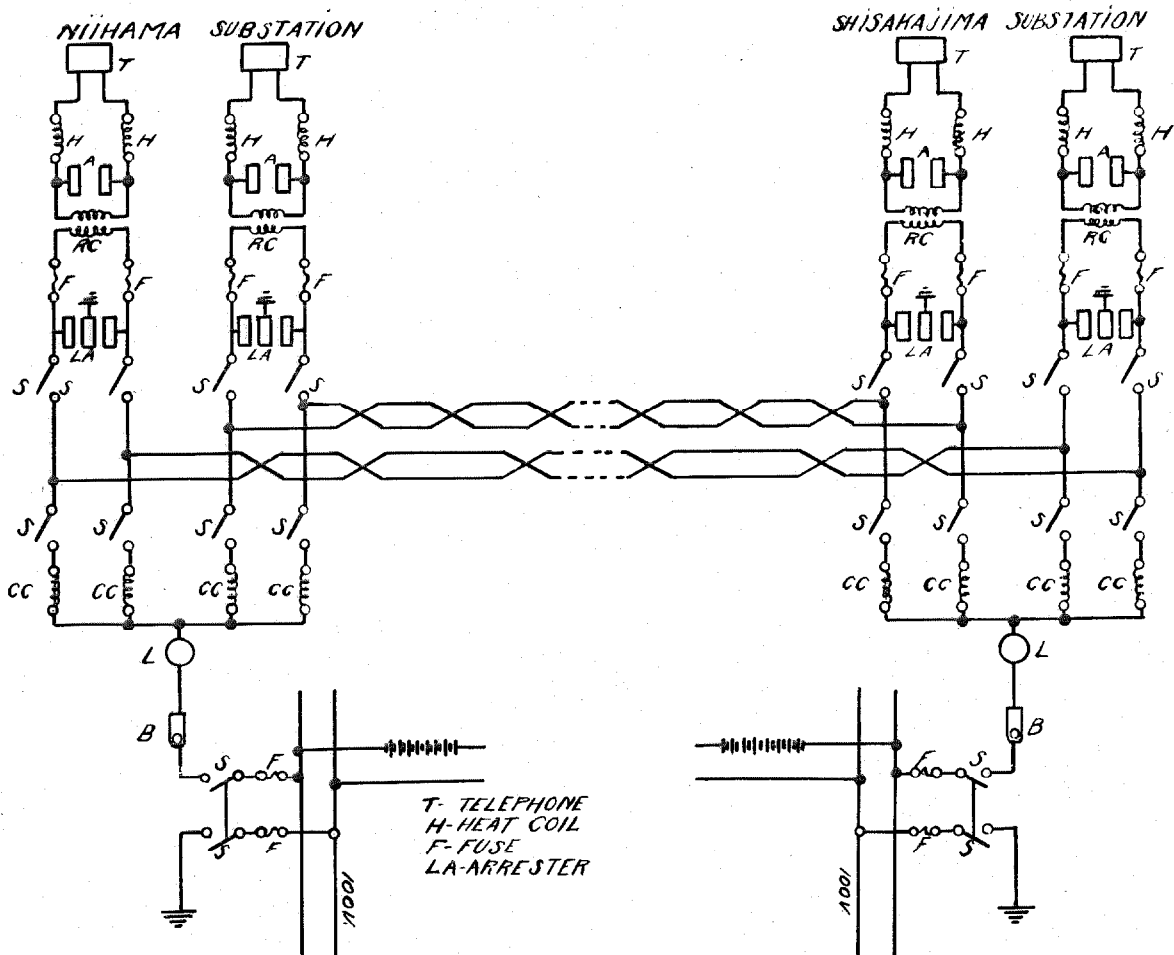

Figure 2

The peculiar feature of the construction of the cable is that under the lead sheath there are four strips of copper wound spirally around the cable core. These copper strips, in addition to serving as a protective device for the cable, are utilized to form two telephone circuits; an application which in so far as we know has not previously been made. The ordinary method of inserting telephone circuits in a power cable is to lay up

handle and is less liable to damage during transportation and laying.

In the case of a paper insulated submarine power cable, the use of protective copper strips is almost imperative. If the cable is damaged, the seawater will penetrate into the insulation very quickly and it will take a longer time to repair the cable than in the case of the ordinary underground cable. Cable faults, especially a

fault between the lead sheath and insulation, must be detected before the cable breaks down or the water reaches the conductors. This can be done with the present scheme; the copper strips also being used to advantage for purposes of detecting any fault in lead sheath or joints during the process of laying the cable. Fig. 2 shows the method of connection of the copper tapes to the signalling and testing equipment at the two switch stations. The action of the copper tapes as a protective device is such that, when a fault occurs in the cable, the copper tape is earthed at that point and the circuit which the copper forms is closed, causing the current to flow through "B" and "L" and give an alarm.

The cable was manufactured in continuous lengths of 3,000 feet at the factory and all of the pieces joined together into two lots before shipment, one section measuring 33,000 feet long and the other 36,000 feet. One section was laid from the beach of Niihama in the direction of Shisakajima and the other from Shisakajima towards Niihama, the joining of these two sections being made at the middle of the sea. In joining, the copper conductors from each end were first connected, then each conductor was lapped with impregnated paper, all were enclosed in a lead sleeve and the joint was filled with insulating compound. Jute was placed

over the sleeve and the wire armour was lapped overall to make the joints mechanically strong.

The following physical and electrical properties of the cable are of interest:

Sectional area of each conductor. . . . .	100,000 circ. mils.
Construction of conductor. . . . .	19/.0725"
Thickness of insulation between conductors. . . . .	.350"
Thickness of lead sheath. . . . .	.130"
Thickness of jute bedding. . . . .	.100"
Number and diameter of galvanized iron wires. . . . .	24 x .300"
Thickness of jute serving. . . . .	.100"
Size of copper tape. . . . .	1/2" x .013"
Approximate overall diameter. . . . .	3.0"
Weight per 1,000 feet. . . . .	6.3 tons
Normal working voltage. . . . .	11,000 volts (Neutral point of system earthed)
Factory test each 3,000 ft. length	
Between conductors. . . . .	33,000 volts a.c.—15 minutes
Between conductors and lead sheath, 28,000 volts a.c.—15 minutes	
Tests after installation	
Between conductors. . . . .	16,500 volts a.c.—10 minutes
Between conductors and lead sheath, 13,500 volts a.c.—10 minutes	
Measurements at 72° F.	
Insulation resistance, between one core and other two cores connected to sheath. . . . .	6.9 megohms
Copper tapes and lead sheath. . . . .	1.8 megohms
Capacity, between the core and other two cores connected to sheath. . . . .	4.4 mfd.
Between three cores and sheath. . . . .	7.9 mfd.
Between tapes and sheath. . . . .	11.0 mfd.
Between two copper tapes. . . . .	5.5 mfd.
Copper resistance main conductor. . . . .	7.65 ohms

# High Quality Transmission and Reproduction of Speech and Music\*

By W. H. MARTIN

*Department of Development and Research, American Telephone and Telegraph Company  
and*

H. FLETCHER

*Engineering Department, Western Electric Company, Incorporated.*

*Review of the Subject:* Radio broadcasting has drawn attention to the problems involved in obtaining high quality in systems for the electrical transmission and reproduction of sound. This paper gives the general requirements for such systems, discusses briefly the factors to be considered in design and operation and indicates to what extent the desired results can be obtained with the means now available.

THE primary function of telephone circuits, as normally used in commercial service, is the electrical transmission and reproduction of speech sounds. In considering the operation of such a system, the reproduced sounds are referred to as having two properties, intelligibility and naturalness. While these two properties are not by any means unrelated and are both of importance in all sound reproducing systems, the first is naturally the more important in a commercial communication system. In broadcasting and public address systems, the communication function is supplemented by the function of entertainment and the property of naturalness, therefore, increases in importance in the reproduced speech. Furthermore, the use of music with such systems imposes, in general, more severe requirements upon them because of the wide range of frequencies and intensities required for proper appreciation.

In this paper the fundamental requirements for a system for faithfully transmitting and reproducing sound are outlined, and their applications considered, particularly in connection with broadcasting and the use of loud speakers.

In any system for the electrical transmission and reproduction of sound there are three essential elements: A means for converting sound into electrical energy, usually called the telephone transmitter or microphone; a means for converting electrical energy into sound,

usually called the telephone receiver; and means for transmitting the electrical energy from the transmitter to the receiver.

In the operation of such a system, there are three general requirements which it is desirable that the reproduced sounds should meet: First, that they be at about the same loudness as people are accustomed to hearing the original sounds; second, that they be free from appreciable distortion, that is, that the character of the reproduced sounds be so close to that of the original sounds that the ear cannot distinguish between them; and third, that they be free from extraneous sounds. The degree to which these requirements of loudness, freedom from distortion and noise are met is the measure of the quality of the system.

The discussion in this paper will be directed primarily to the second of the above requirements, that is, the matter of obtaining accurate transmission and reproduction of the original sounds, and the requirements of loudness and noise will be considered only in so far as they have a bearing on the principal discussion. In this connection, it may be noted, that with the development of practically distortionless amplifiers, it is possible to compensate for the losses in volume incurred in transmission and in the conversions between sound and electrical energy, and thus obtain any degree of loudness desired. The problems of eliminating noise, however, are in many cases difficult, but are too extensive to be within the scope of this paper.

## DISTORTION

The sounds which comprise speech and music involve, as is well known, complicated pressure variations. For any small interval, of time, these pressure variations may be resolved into a series of component sinusoidal waves. As the speech or music proceeds, however, the

\* Presented at the Midwinter Convention of the A. I. E. E., Philadelphia, Pa., February 4-8, 1924, and published in the March issue of the *Journal*, Vol. XLIII, No. 3.

amplitude, the frequency and the phase of these components change. The transmission and reproduction of such sounds may be conveniently considered as a matter of transmitting and reproducing the several component waves.

For a system to be ideal from a quality standpoint, these components must be reproduced unchanged, and no new components introduced. Experience has shown that changes in phase such as are usually obtained, produce no effects which are noticeable by the ear. Also, as discussed later, all the amplitudes may be diminished or increased uniformly through an appreciable range before the quality is affected.

The requirements then for no noticeable distortion in a sound-reproducing system may be stated as follows:

1. The reproduced sounds shall have the relative intensities of the component frequencies the same as the original sound.
2. The reproduced sounds shall not contain any components of frequencies not present in the original sound.

Failure to meet the requirement set up in (1) is referred to as "frequency distortion." This results when a system has different transmission efficiencies for the different frequencies.

Failure to meet the requirement set up in (2) is referred to as "non-linear distortion." This results when the relation between the output and input powers is not independent of the magnitude of the input power. Distortion of this type may be obtained from the iron cores of transformers or other coils, from vacuum tubes, from carbon transmitters and from diaphragms or other vibrating mechanical parts. All of these have a load characteristic which generally has a practically linear relation between output and input when operated below certain energy limits, but which shows a non-linear relation between output and input when the input power exceeds these limits. Operation over the non-linear part of such a characteristic results, in addition to changing the intensity relations of the components of the original sounds, in the setting up of components of frequencies which may be different from those of the components in the impressed wave.

Another important factor in the reproduction of sounds which is not generally appreciated is

that apparent distortion is obtained if the loudness of the reproduced sounds is materially outside of the range in which the listeners are accustomed to hearing the original sounds. Recent work<sup>1</sup> in hearing has shown that the transmission mechanism of the ear is non-linear in its response even at loudness levels commonly used in speech and music. From this it is seen that the interpretation of complex sounds by the ear is partly accomplished by the "subjective" frequencies introduced by the ear itself. Due to this non-linear characteristic of the ear, when the intensities of reproduced sounds are materially different from those of the original sounds, there is an apparent distortion.

With these requirements in mind, consideration will now be given to the extent to which they can be met with the means and methods now available. In this connection, three electrical transmitting and reproducing systems will be discussed, a high quality telephone circuit, the public address system and the broadcasting system. The first two and the elements used in them have been previously described in some detail. A brief description of them will be given here, however, to show their similarity with the third, which will be discussed more comprehensively, and also to indicate to some extent the evolution of high quality reproducing means. It will be noted that the successful design, maintenance and operation of any high quality system depends upon the development of methods of measuring its operational characteristics, such as the relation between input and output energies over a range of frequencies and intensities.

#### HIGH QUALITY TELEPHONE REFERENCE SYSTEM

A number of years ago a telephone circuit was set up in the Bell System Laboratories in which use was made of the various available means to eliminate distortion as much as possible. This was used as a reference circuit in a comprehensive investigation of the effects on the intelligibility of reproduced speech sounds, of variations in the volume of the reproduced sounds, of various types and amounts of distortion

<sup>1</sup> Physical Measurements of Audition and Their Bearing on the Theory of Hearing, H. Fletcher, *Jour. Franklin Inst.*, September, 1923.



and of various amounts and kinds of extraneous noise.<sup>2</sup> This system and the variation of its efficiency with frequency are shown in Figures 1 and 2.<sup>3</sup> It has also negligible noise and non-linear distortion for the sound powers that it is designed to handle, that is, those corresponding to talking in the normal way over a telephone circuit.

With this system, the fundamental vowel and consonant sounds used in speech are reproduced so well that when a series of such sounds are impressed upon the system 99 per cent are cor-

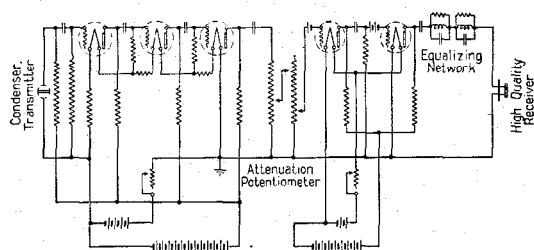

Figure 1—Circuit of High Quality Telephone Reference System

rectly understood. This recognition is for the condition when these sounds are combined into meaningless monosyllables, which makes the test much more severe than for these sounds as ordinarily used in conversation where the context aids in the recognition. The degree of recognition obtained with this system is within a few tenths per cent as good as that obtained by direct hearing. This circuit, therefore, from the standpoint of intelligibility of speech is practically perfect.

This high quality circuit made use of several important developments. First is the condenser transmitter which gives a practically distortionless conversion from sound to electrical energy. This transmitter, which has been previously described,<sup>4</sup> uses a thin metal diaphragm, tightly stretched and placed close to a heavy metal plate. The diaphragm and the heavy plate form an electric condenser and the air film

<sup>2</sup>The Nature of Speech and its Interpretation, H. Fletcher, *Electrical Communication*, Vol. I, No. 1

<sup>3</sup>The "transmission units" used in Fig. 2 and elsewhere in this paper are a logarithmic function of power ratio. The number of transmission units,  $N$ , corresponding to the ratio of two amounts of power  $P_1$  and  $P_2$ , is given by the relation  $N = 10 \log_{10} P_1/P_2$ . The power ratio corresponding to  $N$  units is therefore  $10^{N/10}$  (1).

<sup>4</sup>Wente, *Phys. Rev.*, June 1917 and May 1922. Crandall, *Phys. Rev.*, June 1918.

between the two serves to damp the vibration of the diaphragm.

Second is the design of vacuum tube amplifiers which are distortionless over a wide range of frequencies and loads. The design of such amplifiers will be discussed in a future paper, so will not be described here, other than to show later some amplifier frequency characteristics which have been obtained.

Third is a telephone receiver having small distortion. For this a permanent magnet type of receiver was used in which the principle of damping the diaphragm by an air film was employed in a manner similar to that described above for the condenser transmitter.

Fourth is the use of a network of impedances designed to introduce into the circuit the distortion which compensated for any distortion in the system which it was not practicable to

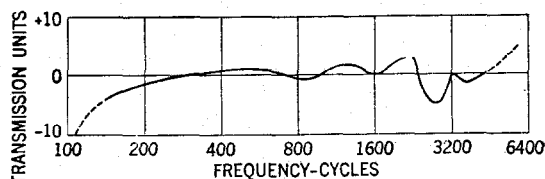

Figure 2—Frequency Response Characteristic of High Quality Telephone Reference System

eliminate in the several parts. In this circuit this compensation was needed primarily to take care of residual distortion in the receiver.

#### PUBLIC ADDRESS SYSTEM

The public address system and its applications were described in two papers presented before this Institute in February, 1923,<sup>5</sup> and as already noted will be referred to only briefly here. In the public address system which was used at the presidential inauguration in March, 1921, the condenser transmitter and high quality amplifiers were used to obtain good quality. In November, 1921, this public address system was used with the toll lines to transmit the Armistice Day Service at Arlington, Va. to New York and to San Francisco. At this time use was made of a new design of high quality

<sup>5</sup>Public Address Systems, Green and Maxfield, *Electrical Communication*, Vol. I, No. 4.

Use of Public Address Systems with Telephone Lines, Martin and Clark, *Electrical Communication*, Vol. I, No. 4.

transmitter, the double carbon button transmitter employing the stretched damped diaphragm of the condenser type. At this time also corrective distortion networks were employed to compensate for the distortion of the non-loaded cable circuits which were used to connect to the toll lines. The "volume indicator" for showing the power carried by the amplifiers was also used on this occasion in order to keep them from being overloaded and causing non-linear distortion. This volume indicator, as described in the papers referred to, consists of a vacuum tube amplifier-rectifier operating a quick acting ammeter. In both these loud speaker applications, extensive use was made of single-frequency measuring apparatus for determining the efficiency of the various parts of the system over a wide range of frequencies.

#### BROADCASTING SYSTEM

When radio broadcasting started its phenomenal development, this high quality apparatus and the associated testing methods found new applications. It will be noted that the public address and the broadcasting systems are very similar, the main difference being the use of radio in the latter as a convenient means of reaching a large number of receiving stations from one transmitting station.

In Figure 3 are indicated the essential elements of a radio broadcasting system. In this system,  $M$  is the microphone or means for converting from sound to electrical energy,  $A_1$  is the amplifier used to increase the output of the microphone before transmitting it over the wire connection  $L_1$  to the broadcasting station. The amplifier  $A_2$  and the radio transmitter  $RT$  increase and transform the energy into that which is put upon the antenna. At each of the receiving stations, there are required, in general, a radio receiver  $RR$  for converting the received radio frequency currents into audio frequency currents, an amplifier, and a telephone receiver, either of the type held to the ear or of the loud speaker type.

In regard to the wire line  $L_1$  to the broadcasting station, it should be noted that while much of the material to be broadcast is at present specially produced in a studio closely

associated with the broadcasting station, a large and probably increasing proportion of the broadcasting material is produced at points at some distance from the station. In this latter class come (1) material which is not given primarily for broadcasting, such as concerts and speeches for some local audience, (2) material given in a studio located at a point convenient to the artists or speakers, but remote from the broadcasting station and (3) announcements of the progress of athletic games or other sporting events which are made from the place where the games are held.

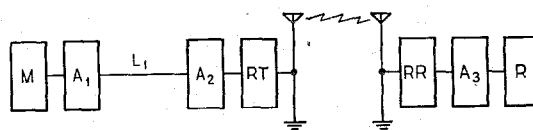

Figure 3—Schematic Diagram of Radio Broadcasting System

#### BROADCASTING MATERIAL

The material used for broadcasting consists in general of speech or music. Speech sounds are extremely complex in their nature and involve frequencies from about one hundred cycles to above six thousand. The first two charts in Figure 4 show the sound spectra for the sung vowels "ah" and "ā." When these and the other vowels are spoken they are modulated both in pitch and volume from this steady state, the particular manner of starting or stopping them determining the so-called stop consonants<sup>6</sup>. The unvoiced fricative consonants, "s", "f" and "th", have their sound spectra in the upper frequency regions between 4000 and 10,000. In general most of the energy is carried by the vowel sounds and at frequencies below 1000 cycles, but the fine modulations of the vowels which produce the stop consonants and also the production of the fricative consonants involve frequencies mostly above 1000 cycles. For this reason it is well to bear in mind that the importance of any frequency region for carrying the energy in speech is quite different from that for carrying the intelligibility. On Figure 5 are shown two

<sup>6</sup>The Nature of Speech and its Interpretation, H. Fletcher, *Electrical Communication*, Vol. 1, No. 1.

curves which contrast this difference.<sup>7</sup> The curve for intelligibility does not directly take into account the naturalness of the sounds. It is found, for example, that while a system, which transmits only the frequency range from 500 to 2000 cycles, reproduces speech which can be easily understood, it leaves much to be

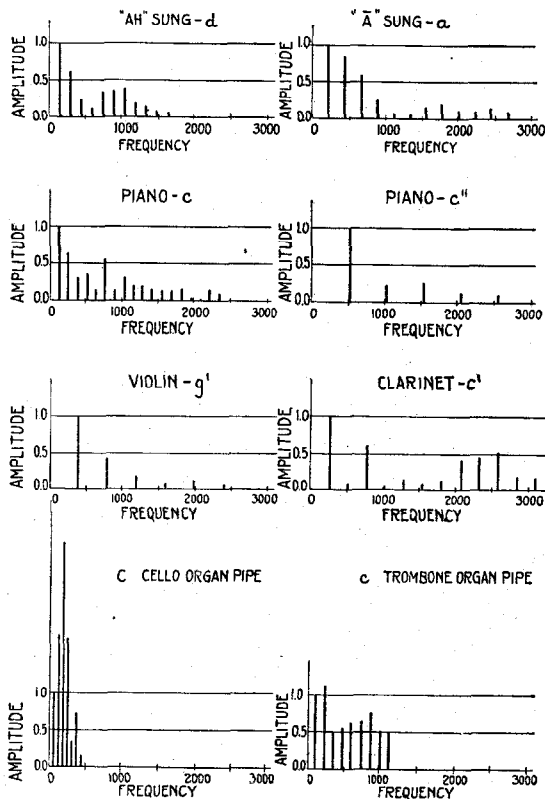

Figure 4—Sound Spectra of Typical Musical Tones

desired from the standpoint of naturalness. In broadcasting, a broader frequency range is desirable because of the importance of naturalness. Results can be obtained for speech which are good for intelligibility and fairly good for naturalness with a frequency range from about 100 to 3000 cycles, although appreciable improvement is obtained by the extension of the upper end of the range.

The various types of vocal and instrumental music, solo, choral and orchestral, have widely varying characteristics, with fundamental tones as low as 16 cycles and harmonics above 10,000

<sup>7</sup> Curve for energy distribution given in Analysis of the Energy Distribution of Speech, Crandall and MacKenzie, *Phys. Rev.*, XIX, No. 3. Curve for Intelligibility derived from data given in paper mentioned in Note 6.

cycles. The breadth of this range makes its proper handling in a reproducing system extremely difficult, particularly when the large energy of some of the low notes such as used in the pipe organ are taken into account. Figure 4 gives also charts showing the sound spectra for some typical musical instruments when they are sounded at the pitches indicated. It is very difficult to obtain any quantitative measurements of the importance of the various frequency regions for properly transmitting music, but it has been found that with a frequency range of from about 50 to 5000 cycles good reproduction can be given for most kinds of music. In this connection it may be pointed out that the pitch of musical tones of very low pitch is carried to the ear mainly by the harmonics rather than by the fundamental.<sup>8</sup> For example, with a system not reproducing any frequencies below 100 cycles, the pitch is preserved for notes even as low as 30 cycles. The musical quality is marred, however, when the lower frequencies are not present.

Another important characteristic of speech and music is the intensity range. For speech the range of the average power is of the order of 1000 to 1. In music, such as that given by a symphony orchestra, the corresponding range may be as great as 100,000 to 1. These ranges have an important bearing on the load capacity required for the parts of the broadcasting system as will be brought out later.

#### PICK-UP OF MATERIAL

In picking up material for broadcasting, that is, in getting the sound energy into electrical energy, the general requirement would seem to be to get to the high quality microphone the sounds in the form in which a skilled listener would wish to hear them if he were free to choose his location with respect to the source of these sounds. In this respect, the skilled listener would be largely governed by hearing the sounds under the accustomed conditions with all undesirable noises, echoes and abnormal reverberations removed. In considering the pick-up of material for broadcasting it should be noted, however, that it corresponds to listen-

<sup>8</sup> Physical Criteria for Determining the Pitch of a Musical Tone, H. Fletcher, *Physical Review*, September 1923.

ing with one ear, that is, the binaural sense of direction which is normally obtained in hearing the sounds directly, is lacking. With binaural audition, it is possible to concentrate on one sound source and to disregard somewhat the effect of other sounds coming from different directions or distances. Because of the monaural character of broadcasting it is necessary, therefore, to go even further in reducing noises and reverberation at the transmitter than would be the case for an observer using two ears at the same location.

In picking up sounds, undesirable effects which may be classed as distortion, may be obtained by having either too much or too little reverberation or, where the sounds come from several sources, such as in the case of a quartet or an orchestra, by not having the proper relation between the intensities of the sounds which reach the transmitter from the several sources. Since most speeches and musical selections are given indoors, a certain amount of reverberation is generally present. Because of this customary condition, music particularly, without reverberation, such as is obtained in a heavily padded room, sounds "dead." Too much reverberation, on the other hand, causes one tone to drag over into a succeeding one and tends to blur the sounds. In some tests carried out by Prof. W. C. Sabine with rooms in which the reverberation was varied it was found that a group of musicians consistently selected a particular reverberation condition as being most desirable for the piano.<sup>9</sup>

Much of the material that is broadcast is given in a special studio where it is possible to control the conditions. The studio can be placed in a quiet location, it can be treated with absorbing material to give the proper amount of reverberation and the speaker, singers, or musicians can be placed with respect to the microphone so as to obtain the desired balance between the direct sounds and the reverberation and also between the sounds from the several sources where more than one source is used. With the large number of variables involved, it is not as yet possible, however, to give general rules governing all of them.

In regard to the matter of equipping such a

room with sound absorbing material, it is seemingly a common mistake to cover as completely as possible the ceiling, walls and floor of a studio with such material. Such a room in addition to making the music sound "dead," makes it difficult and in some cases impossible for a singer or violinist to keep on the key because they are accustomed to get the pitch of one note from the reverberation of the preceding note. In one studio of about 20 by 30 feet, in which a large amount of experimental work was done to get a suitable reverberation for music, the final arrangement is a hardwood floor with a few rugs, the walls hung with monks cloth and about two-thirds of the ceiling covered with one inch hair felt. The reverberation can be increased when desired by taking up rugs or pulling back some of the wall hangings. In such a room for speaking, however, undesirable reverberation is obtained if the speaker is more than about four feet from the microphone. In connection with the statement regarding the effect of the monaural character of broadcasting on the requirement for the placing of the microphone, it is of interest to note that the reverberation time for this studio, using Sabine's method and coefficients, was somewhat less than that found to be desirable in his tests which were referred to.

There is an increasing demand in broadcasting for the use of material which is not being given specifically for broadcasting, such as a speech by some well-known person or a concert by a symphony orchestra. In such cases it is not usually possible to change the acoustics, so that the problem becomes one of getting the best location for the microphones.

For a speech, the problem is generally not difficult as the microphone can usually be located within about three feet of the speaker so as not to restrict unduly his usual movements. For a symphony orchestra of 75 to 100 pieces the problem presents some difficulties. It is desirable to get the transmitter far enough away from the orchestra so that the paths from it to all the pieces of the orchestra are about equal, in order to get proper balance between the parts, and at the same time, not to be so far away from the orchestra that the incidental noises of the audience are loud compared to the music. Good results have been

<sup>9</sup> Collected Papers on Acoustics, Harvard Univ. Press page 75.

obtained under these conditions by suspending the transmitter from the ceiling of the concert hall over a point on the floor about thirty to fifty feet from the orchestra and about ten to twenty feet from the ceiling. This brings it over the audience, but far enough away so that noises from it are not bothersome and far enough away from the orchestra to get a good

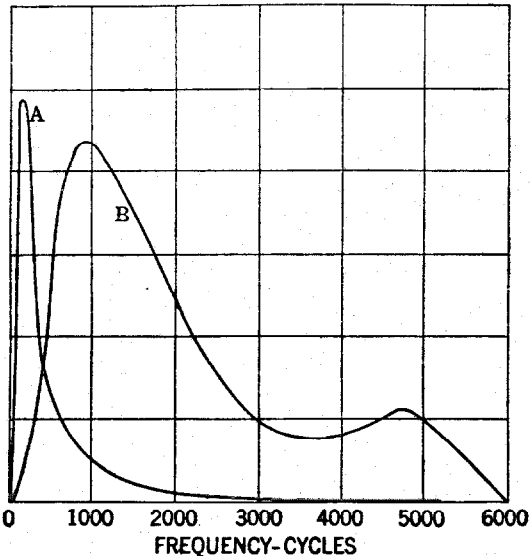

Figure 5—Frequency Characteristics of Speech  
Curve A—Energy distribution  
Curve B—Relative importance for intelligibility

balance between the parts. Also this permits the sound striking the transmitter through reverberation to be sufficiently appreciable as compared to the direct sound. This reverberation gives the impression of the orchestra playing in a concert hall, which, of course, is the natural condition. The scheme of using several transmitters distributed throughout the orchestra, in order to pick up the different parts, is in general undesirable because of the lack of reverberation and the difficulty of getting proper balance between the parts.

#### TRANSMITTERS

Two transmitters or microphones of the air-damped, stretched-diaphragm type have been extensively used for broadcasting, the condenser type and the carbon button type.

The frequency response characteristics of present models of these two types of transmitters

are shown in Figure 6, that designated *A* being for the carbon and that designated *B* for the condenser type. Both of these have already been described elsewhere and will not need further consideration here. It should be noted that the condenser type can be designed to have a frequency characteristic of almost any degree of flatness desired. Material improvements have been made recently on the carbon type. One of these is the use of a light metal diaphragm by means of which the electrical output for a given sound input has been increased about ten times. A second important improvement in the carbon type has been a change in the acoustic spaces associated with diaphragm to reduce the distortion. The advantage of the carbon type of transmitter is that it requires two stages of amplification less than the condenser type and approaches it closely from the standpoint of freedom from distortion. As a result of the small diaphragm motions used in this transmitter the carbon button is worked far below the saturation point.

#### TRANSMISSION TO BROADCASTING STATION

When material is picked up at a point remote from the broadcasting station, care must be used to avoid distortion in getting it to the station. When, as is usually the case, the point

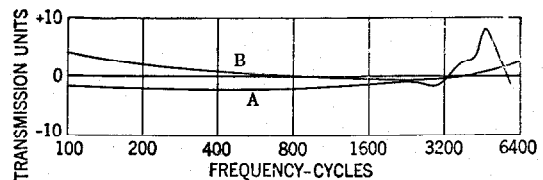

Figure 6—Frequency Response Characteristics of High Quality Transmitters

Curve A—Stretched diaphragm double carbon button transmitter  
Curve B—Stretched diaphragm condenser transmitter

where the material is given and the broadcasting station are in the same city, it is generally possible to get non-loaded telephone cable circuits between the two points. By the use of corrective distortion networks or "attenuation equalizers" with such circuits, uniform transmission efficiency over the desired frequency range, can be obtained even though the circuits themselves may have considerable distortion.<sup>10</sup>

<sup>10</sup> Use of Public Address System with Telephone Lines, Martin and Clark. *Electrical Communication*, Vol. I, No. 4.

With these equalizers it is possible to equalize such circuits so that the variations of efficiency over the frequency range from the average value are less than one transmission unit.

The high quality transmitters which are used to pick up the material to be broadcast have energy outputs which are so low as to require amplification before they are transmitted to the broadcasting station in order to over-ride extraneous noises which may be encountered. Such amplifiers, in addition to having uniform efficiency for a broad frequency range, must also be capable of giving a large range of amplification and of handling without distortion a wide range of power in order to take account of the variations in the volume of sounds which are impressed upon the transmitter. In picking up speeches, for example, different amplifications may be required for the different loudness of the voices of the speakers. In making a speech, an orator often intentionally changes the loudness of his voice for emphasis. The amplification must be such as to permit low parts to be heard satisfactorily and also the amplifier must be capable of handling the loud parts without overloading. The amplification can be reduced for the loud parts to reduce the power handled, but the power output cannot be kept constant without spoiling entirely the emphasis effects desired by the speaker. In music, the volume of sound varies frequently and over a large range.

Considering this matter from the standpoint of the operator of a radio receiving set, it is desired first, that when the volume of the original sound is at its low point the reproduced sound should be loud enough to override static and other radio frequency interference, incidental noises in his set and room noise at his set. With this condition satisfactorily met, it is desired that the receiving set be capable of handling the maximum volumes of sound without overloading. The sets now available are capable of handling in the order of about a hundredth of this range and to make them handle this larger range would at present be practically prohibitive from a cost standpoint. The same requirement imposed upon the radio transmitter at the broadcasting station would also increase its cost by a large factor. The circuits used between the point where the

material is picked up and the broadcasting stations also impose restrictions on this volume range. The lower limit to the power placed upon such circuits is set by the extraneous noise which may exist upon them due to induction from other circuits. The upper limit to the power on the circuit is determined by two factors, one, the capacity of the amplifiers which may be used and the other, the interference which this circuit would cause in other telephone circuits which are in the same cables with it. These circuit requirements, in general, limit the power range which can be satisfactorily handled to a range of about 1000 to 1. From the standpoint of the circuits alone, this range could be increased by special measures which, however, it might not always be practicable to apply.

These conditions, therefore, make it highly desirable to control the volume range given out by the amplifier associated with the transmitter. Some of this control could be exercised at other points in the system, but it is obviously desirable to have it all take place at one point and keep the rest of the system fixed. For this purpose the amplifier associated with the transmitter is equipped with a means for giving a quickly adjustable amplification. To make these adjustments correctly, it is necessary for the operator of the amplifier to know what power is being delivered by it. Use is made here of the "volume indicator," which is bridged across the output of the transmitter amplifier and the amplification of the volume indicator varied by means of a calibrated potentiometer until a standard deflection is obtained. The amplification required to get this deflection is then a measure of the output of the transmitter amplifier. This is supplemented by a monitoring loud-speaking receiver bridged across the circuit at the same point. By the aid of these, the operator can check the operation of the transmitter and its associated amplifier and keep the volume of electrical power delivered to the broadcasting station between certain prescribed limits which are far enough apart to give suitable expression to the music or speech. When the sounds striking the transmitter become too loud, the gain of the transmitter amplifier is reduced and when these sounds become too low, the amplification is

increased, these changes being made gradually in order to avoid noticeable abrupt shifts in volume. The limits between which the electrical power is kept, are those which have been found experimentally to avoid overloading any part of the broadcasting system and to keep above any extraneous noises in the system.

This adjustment of the gain of the transmitter amplifier to keep the power delivered to the broadcasting set within certain prescribed limits is required also when the pickup of the broadcasting material is in a studio at the broadcasting station.

BROADCASTING STATION

In the radio broadcasting transmitter the incoming electrical power is generally amplified before being used to modulate the radio frequency carrier. In this transmitter, the frequency and volume range requirements, discussed for amplifiers, also apply. The amplification obtained in this part of the system should generally be fixed and all necessary adjustments during operation made in the amplifier associated with the microphone. The following discussion of the broadcasting station is from the standpoint of operation, as the apparatus itself has been described in another paper.<sup>11</sup>

*Operating Requirements.* With a fixed setting of the radio transmitter, it is important to determine the maximum power which can be introduced into it without causing noticeable overloading. To do this, there are required a means for indicating power such as a volume indicator, a high quality radio receiving set, a high quality loud speaker and high quality amplifier for operating it and some skilled observers. With the loud speaker, first determine for speech and several kinds of music, the maximum power which can be delivered by the microphone amplifier before overloading is detected. Then with the amplifier connected to the radio transmitter and with the radio receiving set, high quality amplifier and loud speaker, determine what power input into the radio transmitter causes overloading. If this is less than has been previously determined

as the overloading point of the microphone amplifier, the overloading is in the radio transmitter. The station should then be operated so that the power delivered to the radio transmitter never exceeds this amount.

As a check on the operation of the station, a monitoring system such as the following should be used constantly. In this system a loud speaker and associated amplifier are connected either directly to the output of the microphone amplifier or to the output of a high quality radio receiving set. In these two connections the reproduced speech or music should sound the same and neither should show any signs of overloading.

This matter of guarding against overloading has been stressed so much because it is a common source of poor quality in broadcasting. Furthermore, it is often a defect in operation rather than in apparatus and as such, constant care is required to avoid it.

Another important factor in good broadcasting is insuring that the system and all its parts maintain their good quality. For this purpose, periodic tests should be made of the complete system with single-frequency currents over the range to be transmitted. For these

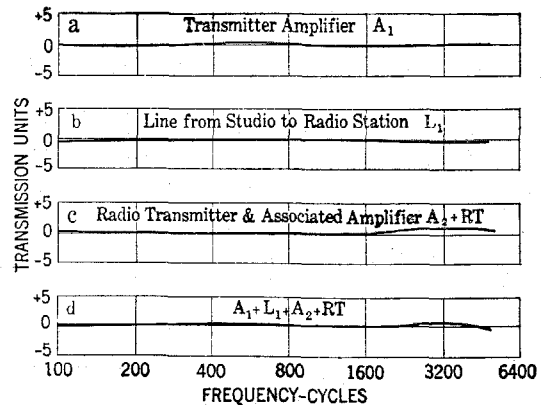

Figure 7—Frequency Response Characteristics of Radio Broadcasting Station

tests the microphone can be replaced by a source of known amount of current and a measurement made of the electrical output of the high quality monitoring radio receiver. For such tests, use can be made of a "dummy" antenna, if it is not possible or desirable to go out "on the air."

<sup>11</sup> Transmitting Equipment for Radio Telephone Broadcasting, E. L. Nelson. Presented I. R. E. Jan. 16, 1924.

It is with the use of a testing system such as outlined that it is possible to find out wherein the system falls down and either change the design of various parts of the system or avoid imposing upon the system conditions for which it gives poor quality. By following this method it is possible to get the distortion between the sounds striking the microphone and the energy radiated from the antenna below the amount detectable by the ear.

*Frequency Characteristics.* The curves of Figure 7 indicate what can be done in obtaining good quality in broadcasting. These curves are for station WEAJ in New York City where the studio and the broadcasting station are in different buildings, the two being connected by a cable circuit about a mile and a half long. Curve *a* is for the microphone amplifier ( $A_1$  in Figure 3), curve *b* for the equalized line between the studio and station ( $L_1$ , in Figure 3) and curve *c* for the radio transmitter and associated amplifier ( $RT$  and  $A_2$  in Figure 3). Curve *d* is for the system from electrical power of audio frequency leaving the microphone to power from the antenna at radio frequencies. The curve for complete operation of the broadcasting system from sound in the studio to radio frequency power in the air can be obtained by combining curve *d* with the microphone curve from Figure 5. Curve *d* shows the station as it is now operated. The small variations from the horizontal line can, of course, be eliminated, if worth while, by the use of an attenuation equalizer.

#### RECEIVING STATION

The apparatus at the receiving station of a radio broadcasting system is required to perform three and preferably four functions. The three are selectivity, conversion of electrical energy from radio to audio frequency and conversion from electrical energy to sound. The fourth is amplification. The first two, selectivity and detection, are the essential functions of a radio receiving set. While it is not within the scope or purpose of this paper to discuss in detail various types of radio receiving sets, some general discussion will be given of the functions of the set in so far as they affect quality. Similar consideration will

also be given to the other functions of the receiving station apparatus.

*Amplification.* The function of amplification is desirable and often necessary in order to bring the energy received by the antenna up to a point where it can produce sounds loud enough to be easily heard. This is particularly the case where loud-speaking telephones are used to perform the third function. While it is a relatively simple matter to provide amplification without distortion, it is in performing this function that serious distortion is now introduced at many receiving stations, particularly when the amplification is in the audio frequency range or when it is obtained by regeneration. The provision of amplification without distortion is largely a matter of proper design, based on a knowledge of the characteristics of the tubes used and means for coupling stages together. A common offender in audio frequency amplifiers is the transformer, although with proper design it can be made to function satisfactorily.<sup>12</sup>

*Selectivity.* In performing the function of selecting the radio wave which it is desired to receive and discarding others, there is a conflict between the degree of selectivity, or sharpness of tuning, and width of the frequency band for the reproduced sounds. If this band width for the reproduced sounds is to be 5000 cycles and both side bands of the radio carrier are to be received, obviously all other waves within a band width of 10,000 cycles will also be received. Further, because it is not possible with the resonant type of selective means to let through without distortion this 10,000 cycle band and at the same time cut off absolutely all other waves near the edges of this band, the set will respond to a wider range of frequencies.

There are, generally speaking, two types of selective means used in radio receiving sets, one a circuit containing one or more adjustable resonant elements and the other a circuit having a fixed selective element with adjustable means for converting the received radio waves into waves of frequencies which will pass through the selective element. With the first type of selectivity, which includes the selectivity obtained with regeneration, the

<sup>12</sup> Telephone Transformers, W. L. Casper. *Electrical Communication*, Vol. II, No. 4.



distortion of the reproduced sounds is obviously not fixed but will vary with the sharpness of tuning used. With the second type of set, the selectivity is fixed in the design and involves, therefore, a predetermined compromise between distortion of reproduced sounds and degree of selectivity. Figure 8 illustrates quantitatively what this compromise entails and also the range of distortion which may be obtained with a set of the variable selectivity type. Curve *A* shows the characteristic for one stage of audio frequency amplification in a particular receiving set, which is seen to cause appreciable distortion only at the low frequencies. As the distortion caused by radio tuning affects only the higher audio frequencies, curve *A* corresponds to a set with no radio selectivity. Curves *B*, *C* and *D* indicate the effect of in-

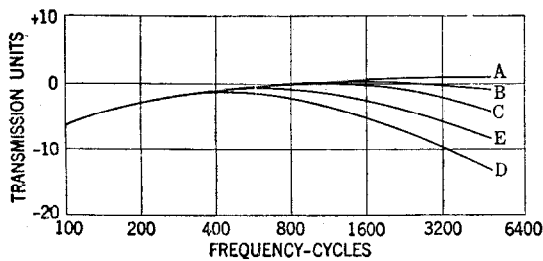

Figure 8—Variation of Audio Frequency Response Characteristics of Radio Receiving Sets with Different Degrees of Selectivity

Selectivity expressed in terms of attenuation for radio frequency 10,000 cycles from frequency for which set is tuned.

Curve A—	Attenuation	0	transmission units
Curve B—	"	10	" "
Curve C—	"	20	" "
Curve D—	"	40	" "
Curve E—	Radio set with fixed selectivity.		

creasing degrees of radio selectivity. These three degrees of selectivity are such that if there is an interfering signal having the same intensity in the ether as the signal being received, but having its carrier frequency 10,000 cycles higher or lower, it will produce an audio signal at the output of the set 10, 20 and 40 transmission units respectively lower than the level of the signal being received. In other words a receiving set having the characteristic *B* which is very desirable from the quality standpoint will be much less selective against interference than one having the higher distortion characteristic *D*. As an example of a practical compromise, curve *E* shows the

characteristic of a set of the fixed selectivity type which was designed for general all around use in receiving both local and long distance broadcasting. In this set a frequency 10,000 cycles higher or lower than the frequency to which the set is tuned suffers a loss of 34 transmission units.

The fixed selectivity type of set has some advantage in that its operation is definite and is less likely to give poor quality due to improper operation. The operation of this type of set can be materially improved by employing for the fixed selective element a band pass filter. Such a filter has the advantage that the characteristic of the transmitted range can be made practically flat for any desired band width and to present a large attenuation for frequencies outside the band. For example, with a well designed filter of this type, the characteristic of the transmitted audio frequency band can be made practically flat up to 5000 cycles and the discrimination against other signals can be made even greater than that given above for curve *D*. This type of selectivity employing a band pass filter was used in the receiving sets of the Catalina Island radio telephone system.<sup>13</sup>

*Conversion from Radio to Audio Frequency.* In converting the electrical energy obtained from the antenna from radio to audio frequency, there is in general no difficulty from the standpoint of distortion provided the "detector" for making this conversion is worked below saturation.

*Conversion from Electrical Power to Sound.* The conversion from electrical power to sound may be accomplished either by the head type telephone receiver or by a loud-speaking telephone, the latter being obviously more desirable for this purpose.

In Figure 9 is shown the frequency response characteristic of a good type of commercial head receiver when held to ear in the usual manner. It will be noted that this introduces appreciable distortion. A material reduction in this distortion can be obtained with the type of damped receiver used in the high

<sup>13</sup> The Avalon-Los Angeles Radio Toll Circuit, Clement, Ryan and Martin, *Jour. I. R. E.*, December, 1921.

quality telephone system described in the first part of the paper. The characteristic of such a damped receiver is shown also in Figure 9.

In Figure 10, Curve A gives the frequency response curve for one of the best types of commercial loud speaker. This also introduces considerable distortion, being particularly weak at the lower end of the frequency range. This deficiency while not so serious for speech, is easily noticeable for music. In this figure are

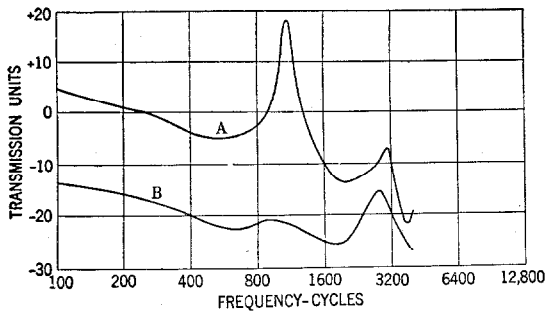

Figure 9—Frequency Response Characteristics of Telephone Receivers

Curve A—Commercial type  
Curve B—Specially damped receiver

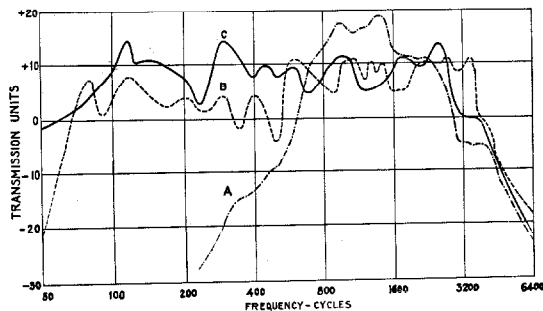

Figure 10—Frequency Response Characteristic of Loud Speaking Receiver

Curve A—Commercial type  
Curves B and C—Experimental models.

given also two curves showing the response characteristic of laboratory models of loud speakers. These are of interest since the means for converting from electrical power to sound are the most serious source of distortion in a system for transmitting and reproducing sounds, and the reproduction given by these models is markedly superior to that obtained with the commercially available apparatus, and indicates the future possibilities of broadcasting.

## CONCLUSION

From this consideration of systems for the electrical transmission and reproduction of sound, it has been shown that it is practicable to get almost perfect electrical transmission over a broad band of frequencies from the terminals of the pick-up transmitter to the radio transmitter and from there out into the air. With the condenser transmitter and proper associated amplifiers the conversion from sound striking the diaphragm to electrical energy can also be made without appreciable distortion. With a properly designed and operated broadcasting station, therefore, high quality material can be delivered to the receiving stations.

At present the commercial radio receiving sets and the means for converting from electrical energy to sound now generally available can not fully utilize this high quality material. These receiving and reproducing means can, however, be materially improved. The problem now is to make such improvements available in such a form that their cost will not make their use prohibitive. As yet the commercial production of apparatus incorporating such improvements is in the future.

In view of the distortion which exists at the present receiving stations, the question may arise as to the justification for going as far as has been indicated in the other part of the system. The fact is that with the reproducing means now available, material deviations from the frequency characteristics which have been given for the other parts of the system are detectable and the effect of non-linear distortion readily noticed. In a broadcasting system where one element is used for converting from sound to electrical energy and for distributing this energy to a large number of elements for reconverting it into sound, the expense of getting good results in this one element is not prohibitive and, taking into account the whole system, relatively small.

In broadcasting, the novelty of the system was undoubtedly a large factor in its rapid growth and development. Those who make use of the system are, however, becoming more critical of the service which it renders and the quality of reproduction will be of increasing importance in the future.

# Radio Telephone Signaling\*

## Low-Frequency System

By CHARLES S. DEMAREST, MILTON L. ALMQUIST

*Department of Development and Research, American Telephone and Telegraph Company*

LEWIS M. CLEMENT

*Engineering Department, Western Electric Company, Incorporated*

*Review of the Subject.* A signaling system is described which serves to extend to the field of radio telephony the same sort of calling facilities as are now available in wire telephony. By its means the radio attendants or subscribers are enabled to signal each other without requiring that the called party should have to listen with a receiver. The system is intercommunicating with a capacity for a large number of stations on one wave length. It has a range of operation extending as far as a radio channel suitable for the commercial transmission of speech can be reliably maintained, and offers a very satisfactory degree of freedom from interference. Furthermore, it employs simple, standard types of telephone apparatus. Some possible fields of usefulness of the system, its outstanding characteristics, and the apparatus which it employs are described.

### INTRODUCTION

IN any system of communication, it is desirable that means be provided whereby an attendant or subscriber may be called without requiring that he should have to listen on a particular line. In wire telephone systems, as is well known, means are provided whereby the central office operator may ring a subscriber's bell. In addition, signaling equipment is provided which permits calling the attention of the central office operator at either station on a line to a particular circuit, without requiring her to listen on that circuit. Thus, it is possible for the operator, after she has established the desired connections between certain circuits, to give her attention to others.

The need of such independent signaling facilities for radio systems has not in the past been an important factor, on account of the fact that licensed operators have been required by law to stand watch at all transmitting stations. However, in certain of the various commercial applications of radio telephony which are now being considered, it is undoubtedly true that the licensed operators on continuous watch could be dispensed with, without detriment to the public

safety and, in these instances, signaling facilities would be a distinct advantage.

To anticipate these needs, the development of signaling arrangements suited to practical use with radio systems has been undertaken and much progress has been made. The problem involves the difficulty that the communication channel provided by radio may be less easily maintained in a stable condition than a wire channel. However, it is now felt that it will be practicable to provide signaling facilities adapted to any type of radio telephone service for which a channel suitable for the commercial transmission of speech can be reliably maintained. This will be of considerable advantage, it is thought, in the commercial development of such service.

One promising possibility for the use of this signaling system would seem to be in the field of marine radio telephony. In ship-to-shore radio telephony automatic signaling would serve to lessen the radio operator's duties. Undoubtedly, there would be considerable operating advantage, from a commercial standpoint, in placing the ship-to-shore radio telephone service on the same signaling basis as wire lines. This might be expected to become particularly important if the volume of such radio telephone traffic became large.

Among other commercial applications of radio telephony in which signaling facilities are expected to prove advantageous, might be mentioned the point-to-point service, as a means of communication between points not reached by wire systems. In the United States there has not, thus far, been much field for the commercial application of point-to-point radio telephone systems. However, where conditions do not favor the installation of wire lines point-to-point radio systems may be expected to find application.

\* Presented at the Midwinter Convention of the A. I. E. E., Philadelphia, Pa., February 4-8, 1924, and published in the March issue of the *Journal*, Vol. XLIII, No. 3.

## DESCRIPTION OF BASIC SYSTEM

The experimental work has indicated that a low-frequency signaling system employing a mechanically tuned alternating-current receiving relay is well adapted to operation in connection with radio systems. Such an arrangement has been shown to be both highly selective and sensitive. These qualities result in giving a very satisfactory degree of freedom from interference, while at the same time the signaling

signal is produced by applying an alternating current of a particular frequency to the radio transmitter in the same manner as the speech currents are applied. Modulation of the radio carrier wave at the signaling frequency results. In this particular system, the signaling current frequency employed is 135 cycles.

At the receiving end the radio carrier wave, modulated by the signaling current, is detected in the radio receiver in the usual manner. The

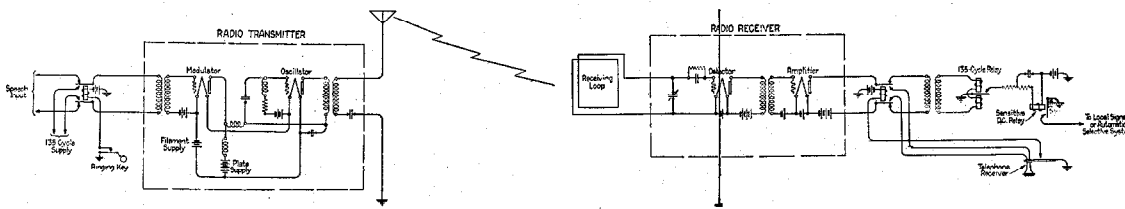

Figure 1—Simplified Diagram of Basic System for 135-Cycle Signaling

energy level required is so low as to permit operation directly from a radio set employing the smallest available types of vacuum tubes.

With such a system, standard types of apparatus may be employed for the signaling equipment, which is not expensive as compared with the cost of the remainder of the radio equipment. Furthermore, the ordinary types of radio transmitting and receiving circuits may be used, without modification.

In testing the system over short distances a simple radio transmitter was used, employing one modulating and one oscillating tube, each of the so-called *E* type. This transmitter had an output capacity of about 5 watts at wave lengths between 200 and 450 meters.

Any type of radio receiver which is suitable for receiving speech over the particular radio system employed may be used. In the tests, one having two stages of radio-frequency amplification, a detector and one stage of audio-frequency amplification, all of which utilized the small *N* type vacuum tubes, was employed. The signal-receiving apparatus was operated either from the detector tube or the audio-frequency amplifier, depending upon the signaling range desired.

Figure 1 shows this scheme in its most simple form which may be made to serve as the basis for a variety of systems, suited to different purposes. As seen in this figure, the outgoing

output of the detector thus includes a component similar to the signaling current originally sent into the radio transmitter at the outgoing end.

This received signaling current is sent into an alternating-current relay of a type particularly adapted to the purpose, which serves to close a sensitive direct-current relay in a local circuit. This combination of relays acts as a mechanical rectifier.

Figure 2 represents very roughly the form of

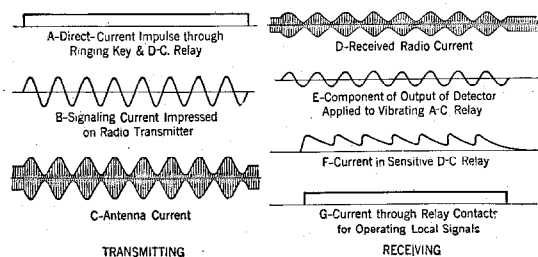

Figure 2—Form of Transmitted and Received Signaling Currents in Operation of Basic System

the signaling currents at the various stages in the process of operation of the basic system. In this figure, the operation at the transmitting end is shown at *A*, *B* and *C*, while that at the receiving end is shown at *D*, *E*, *F*, and *G*. Such a graphical representation of these currents cannot, of course, be made accurate in a quantitative

sense, but it permits visualizing the character of the signal at different steps in the process of operation.

At *A* in this figure is shown the direct-current impulse through the sending key and direct-current signal-transmitting relay, which occurs when the key is closed.

The operation of the signal transmitting relay, which occurs when the sending key is closed, supplies 135-cycle current to the radio transmitter as shown at *B*.

The modulation of the radio carrier wave by the 135-cycle current results in antenna current of the form shown at *C*. This consists of the radio frequency current varying in amplitude at a rate dependent upon the frequency of the impressed signaling current.

The form of the incoming current in the antenna or loop at the radio receiving station, as shown at *D*, is the same as that of the transmitted antenna current previously shown at *C*, but is of course greatly attenuated.

This radio-frequency current, varying in amplitude at a rate dependent upon the modulating frequency of 135 cycles, is impressed upon the detector in the radio receiver. The detector functions in the usual manner, giving as one of the components of its output, 135-cycle current as shown at *E*. This is similar in form to the signaling current originally sent into the transmitter, as shown at *B*.

The 135-cycle component of the detector output is sent into the alternating-current relay and causes its mechanically tuned reed to vibrate at a corresponding rate. The vibration of the reed closes the local circuit through its contacts and the sensitive direct-current relay intermittently. This results in a uni-directional pulsating current through the sensitive direct-current relay, as shown at *F*, and holds the latter closed.

The sensitive direct-current relay, thus operated through the contacts of the vibrating reed, serves to close the circuit through a secondary relay suited to operate directly the local signal. The form of the current at this point, as shown at *G*, corresponds closely to the original signal-transmitting impulse through the sending key and direct-current relay, as shown at *A*. The operation of the secondary direct-current relay in this manner constitutes the conclusion of the final step in the functioning of the basic

signaling system. Subsequent steps depend upon the type of signaling facilities desired, as will be described later.

#### OPERATION OF ALTERNATING-CURRENT RELAY

The reliability and range of operation of this system are due in a large measure to the characteristics of the particular type of alternating-current relay used. This relay is unusually sensitive, as it will operate on as little power as 30 microwatts corresponding to a current of about 0.25 milliamperere. The selectivity of the relay is such that a 4 per cent change in the frequency of the signaling current necessitates doubling the current to give equally effective operation of the relay.

Figure 3 shows the arrangement employed in

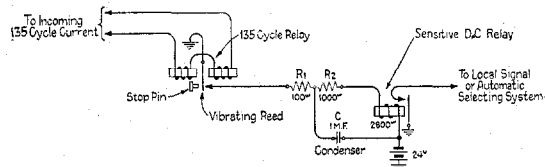

Figure 3—Secondary Circuit of 135-Cycle Relay

associating the vibrating reed relay with the local circuit. It is seen from this diagram that the vibrating reed intermittently closes a circuit associated with a sensitive direct-current relay in such a way that the latter is held closed. The direct-current relay is held operated without vibration, as long as the reed of the a-c. relay is vibrating at the frequency of the signaling current.

The action of this particular local circuit is such that effective operation of the a-c. relay may be obtained with a very small 135-cycle current. The condenser connected in parallel with the sensitive direct-current relay and the resistance in series with the condenser are so chosen in value that the condenser will take an effective charge from the local battery in a short period of time. Thus, but a small amount of work is required to be done in the form of contact pressure by the vibrating reed to charge the condenser to the degree necessary to operate the sensitive direct-current relay by discharging through the winding of the latter.

The curves shown in Figure 4 indicate approximately the relation between the condenser

voltage and contact current over a period of time corresponding to one cycle, that is  $1/135$  of a second. From these curves it is seen that the contacts need be closed for only a small

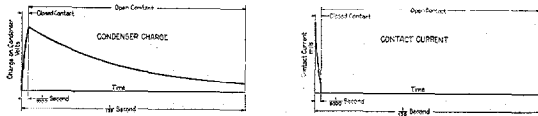

Figure 4—Characteristic Curves Showing Operation of Secondary Circuit of 135-Cycle Relay

fraction of the cycle. Thus, little energy need be expended to effect the operation of the local relay.

Figure 5 is a typical curve showing the performance of the relay in relation to the frequency of the signaling current under average conditions of adjustment. The mechanical tuning of the reed is largely responsible for its selectivity. The reed is adjusted so that the natural period corresponds closely to the frequency of the signaling current. It is thus very selective and is relatively free from the ordinary sources of electrical interference such as those caused by telegraph signals, static, voice currents, etc.

Figure 6 shows the general structure of the relay. The relay is provided with plug connections so that it may be inserted in the circuit or removed from it readily, without requiring soldering of connections. Thus, it is convenient

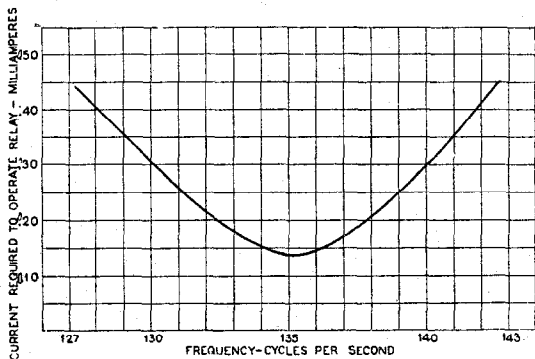

Figure 5—Typical Curve Showing Frequency Characteristics of 135-Cycle Relay Under Average Conditions of Adjustment

to make necessary adjustments of the relay separate from the circuit with which it may be associated in service. The relay is well protected from interference due to mechanical vibration by padding in the mounting. This elimi-

nates rigid mechanical connection between the relay and its external support, thereby preventing loss of energy. A stop-pin is also provided which prevents undue vibration of the reed due to transient impulses or excessive currents.

### SIGNALING CURRENT FREQUENCY

The signaling current frequency used in the practical application of this system, as previously mentioned, has been 135 cycles. This has had the advantage of being a frequency which is low enough to be relatively free from the various kinds of interference experienced in

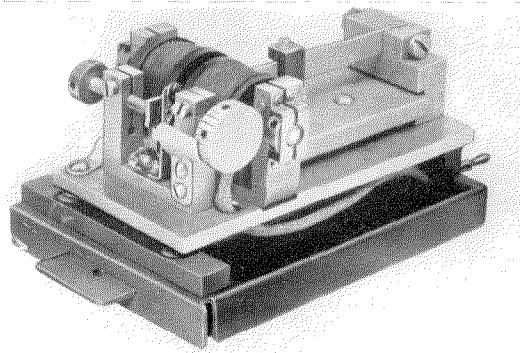

Figure 6—Structure of 135-Cycle Relay

radio systems and at the same time permit the use of simple and reliable apparatus. The fundamental features of the system, however, are such as to permit its being adapted to use with other low frequencies, if such should be desired.

The inherent advantages in the use of a frequency well below the ordinary voice range for telephone signaling, may be readily made effective in a radio telephone system, since there is ordinarily nothing in such a system to discriminate against the lower frequencies. In fact, as far as the radio characteristics of the system are concerned, what difference there may be is in favor of the lower frequencies, because of the close approach of the modulated carrier wave in this case to the carrier frequency itself. While this factor may not be practically important with the short-wave systems now commonly used in radio telephony, it is more likely to be of account with longer waves.

The high degree of freedom from interference

which is obtained with this system is in a measure due to the use of a frequency as low as 135 cycles for signaling. This is particularly true with respect to the interference caused by spark and I. C. W. telegraph. The tones from these sources, being within the audible range, are likely to interfere with any system tuned to a normal voice frequency. 135 cycles, however, being well below these frequencies, permits the effective use of both electrical and mechanical tuning in the signal-receiving apparatus to discriminate against interfering currents. This point was well demonstrated in the signaling tests in which it was found that radio telegraph signals similar to those from an I. C. W. or spark transmitter would cause the received speech to become unintelligible when the energy level of the interference was only 20 or 30 per cent of that required to cause the signaling system to fail.

Another advantage in low-frequency signaling occurs when the signaling apparatus is desired to be bridged across the talking circuit. In this case greater efficiency results in the use of 135-cycle signaling, by reason of the fact that it is possible with this low frequency to pass a large proportion of the received signaling energy into the signaling circuit. If a much higher signaling frequency were used, such that it occupied a more important part of the speech range, an undesirable loss might be caused by an efficient signaling circuit.

#### 135-CYCLE SUPPLY

The highly selective signal-receiving apparatus which is used in this system permits a greater sensitivity in reception when the outgoing signaling currents are kept closely to the desired frequency. This has been accomplished prac-

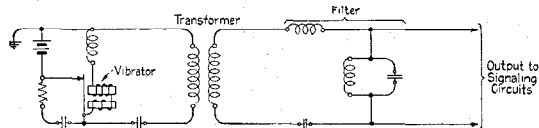

Figure 7—135-Cycle Interrupter Circuit—Simplified Diagram

tically by the development of a 135-cycle interrupter capable of maintaining close regulation and an output of good wave form.

Figure 7 shows the circuit arrangement of the

interrupter which has been developed for commercial use. This employs a tuned vibrating reed actuated by an electromagnet when direct current is applied. The contacts on the reed being in series with the battery circuit, vibration of the reed is effected in the manner of an ordinary buzzer. The actuating circuit of the vibrator is bridged by the primary side of a transformer in series with a condenser, the secondary side of the transformer being connected to a filter for suppressing harmonics in the output.

Figure 8 shows the structure of the vibrator for the interrupter. Since the output frequency of the interrupter for a given applied voltage

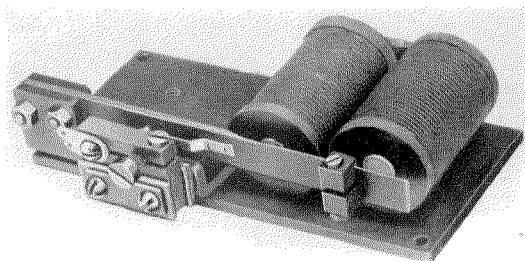

Figure 8—Structure of Vibrator for Interrupter

depends upon the natural period of the reed, means are provided for closely adjusting the latter. It will be noted that this consists of a weight, the position of which along the reed is adjustable. This weight is used in making the initial adjustment of the vibrator to give 135 cycles at the normal battery voltage, but variations in adjustment are not required in subsequent operation of the interrupter.

This matter of frequency regulation is a most important one in the performance of the interrupter. As shown in Figure 9, the frequency of the output may vary several cycles for a variation in the applied voltage of 20 to 28 volts. This voltage variation represents the maximum which might be expected to occur with an 11-cell storage battery operated on a charge and discharge basis, without any regulating device. If the battery voltage is maintained within closer limits than 20 to 28 volts, as may be accomplished by various means, it is seen from the curve in Figure 9 that correspondingly closer regulation of the output frequency may be obtained. For example, if duplicate

batteries of adequate capacity are available, the applied voltage may be kept within limits such that the output frequency will vary only about one cycle.

Figure 10 combines the voltage-frequency curve for the interrupter and the frequency-

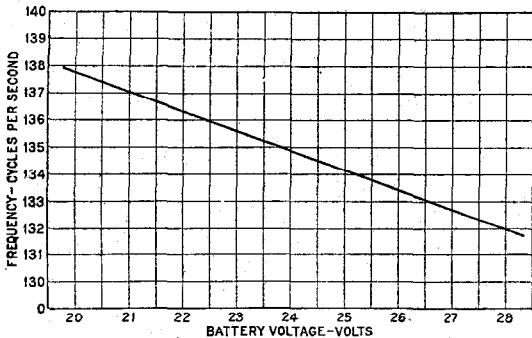

Figure 9—Typical Curve Showing Relation Between Frequency of Output and Applied Voltage for 135-Cycle Interrupter

current characteristic of the relay to indicate directly how variations in the voltage applied to the interrupter and the consequent changes in output frequency may, under average conditions, affect the current requirements of the receiving relay. By keeping the battery voltage within fairly close limits, reliable operation on smaller currents may be depended upon. Where desired, advantage may be taken of the closer

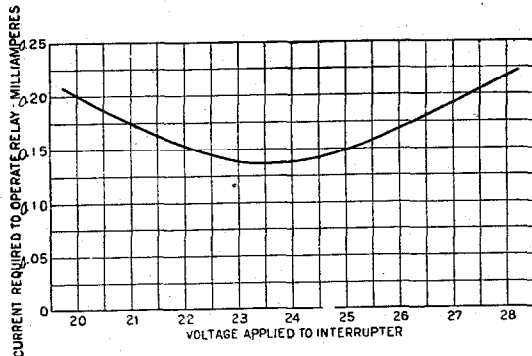

Figure 10—Typical Curve Showing Effect of Change in Frequency Due to Variation in Voltage Applied to 135-Cycle Interrupter on Current Required to Operate 135-Cycle Relay Under Average Conditions of Adjustment

frequency regulation obtained in this manner to secure greater signaling range.

The maximum output capacity of this interrupter is about three-fourths of a watt. The output voltage varies from about 25 volts

at no-load, to 20 volts when the load is 35 milliamperes and 12 volts for a load of 60 milliamperes.

In certain of the signaling tests over short distances, a simplified form of the above interrupter was used. Under the testing conditions in this case, a smaller 135-cycle output was sufficient for the purpose and it was possible to reduce the size of the filter for the interrupter and to operate it with a 6-volt battery instead of a 24-volt battery.

#### AUTOMATIC SELECTIVE SIGNALING SYSTEM

This signaling system may be adapted readily to automatic selective operation, whereby any one out of a number of stations on the same wave length may be signaled individually, or all may be signaled simultaneously. This form of the system is expected to be particularly useful in

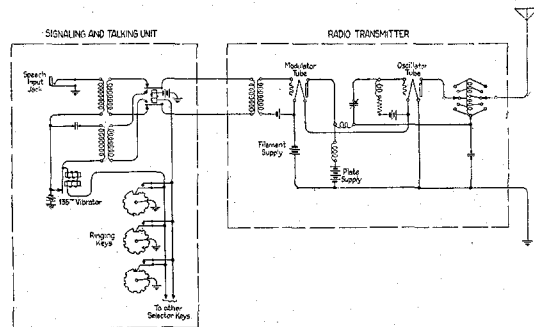

Figure 11—135-Cycle Selective Signaling System—Circuit Arrangement of Transmitting Apparatus

radio telephony, since a number of intercommunicating stations may often be involved as in the marine and point-to-point services. The illustrations which follow will give a picture of a typical arrangement of the automatic selective system.

From Figure 11 the operation of the circuit at the transmitting end is seen to be as follows: The signaling key for the station which it is desired to call is operated and serves to produce a series of direct-current impulses in the form of a code corresponding to that assigned to the called station. For example, if a certain station is desired whose code signal is 8-5-4, a series of direct-current impulses suitable to indicate this number are sent out. These direct-current impulses operate at first a direct-current signal-transmitting relay which connects to the radio



transmitter corresponding impulses of 135-cycle current, in such a manner as to modulate the outgoing carrier wave with current of this frequency in a coded series of impulses each similar to the single impulse described in connection with the basic system.

As shown in Figure 12, at the receiving end the radio receiver serves to detect the 135-cycle

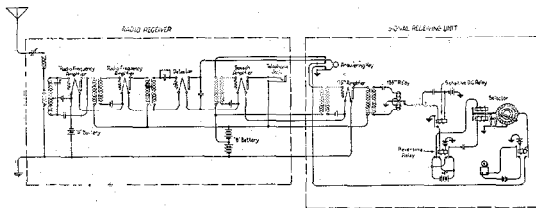

Figure 12—135-Cycle Selective Signaling System—Circuit Arrangement of Receiving Apparatus

signals in the manner described in connection with the basic system, and these signals are sent into the alternating-current relay which operates in accordance with the code originally transmitted. This causes the sensitive direct-current relay to operate in accordance with the code and to produce in a local circuit direct-current impulses corresponding to the original impulses sent out at the transmitting end. These impulses then serve to operate a reversing relay which reserves the potential applied to a condenser in series with a stepping mechanism known as the selector, such that when the proper combination of impulses is received, the mechanism closes a circuit arranged to operate the desired local signal.

The functioning of the selective system may

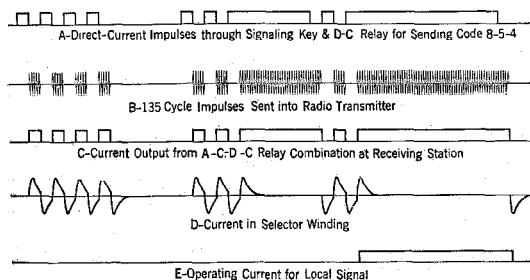

Figure 13—Form of Transmitted and Received Currents in Operation of Selective Signaling System

be followed in greater detail, by considering the form which the signal takes at various stages. Figure 13 shows graphically the general form of the signaling currents in the successive steps

necessary to transmit a typical code signal, such as 8-5-4.

The form of the original code signal, as applied by means of the sending key to the winding of the direct-current signal-transmitting relay, is shown at *A*. It is seen from this that the number of impulses sent is equal to each of the numbers in the code, either the making or breaking of the current (and consequently either the closing or opening of the signal-transmitting relay) counting as one impulse. This is due to the use of reversals in the final receiving operation, as will be explained later.

Each time the signal-transmitting relay is closed by the direct current applied through the sending key, 135-cycle current is supplied through the contacts of this relay to the radio transmitter, thus the signaling currents impressed on the radio transmitter for the code signal 8-5-4 are as shown at *B*.

These coded impulses of 135-cycle current serve to modulate the transmitted radio wave so that the antenna current is similar to that previously shown for the basic system, excepting that the 135-cycle modulation of the carrier is interrupted in accordance with the code.

The incoming current at the receiving station is similar in form to the transmitted antenna current.

The component of the detector output which is useful in transmitting the signal consists in 135-cycle impulses which are similar in form to those sent into the radio transmitter, as previously shown at *B*.

The operation of the alternating-current relay, as previously explained, serves to operate the sensitive direct-current relay in accordance with the transmitted code. The contacts of this relay close and open the circuit through the reversing relay. The current in the winding of the reversing relay is as shown at *C*.

The reversing relay reverses the potential applied to the condenser in series with the selector winding. The selector is arranged so that it operates on the charge and discharge of this condenser. The operation of this relay reverses the battery connections to the condenser and selector, causing the condenser to discharge and charge to the opposite polarity whenever the relay picks up or releases, and it is this charging current which operates the

selector. These reversals take place in accordance with the original code and produce a current in the selector winding as shown at *D*. When the proper code is transmitted, the selector closes a local circuit causing direct current, as shown at *E*, to operate a signal. The final impulse of the series of impulses shown at *D* causes the selector to release and return to normal.

The apparatus employed in this typical arrangement of the system is of a type which has been used in connection with railway dispatching systems and is consequently available in a reliable commercial form. The selecting apparatus consists of the code sending key and the receiving selector mechanism.

Figure 14 shows the structure of one type of sending key used for this purpose. This key is

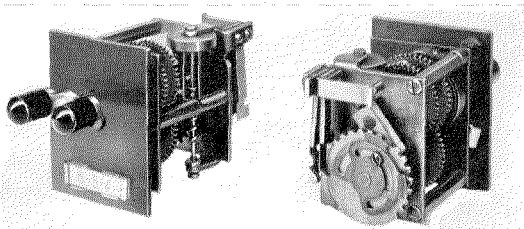

Figure 14—Code Sending Key for Particular Station

set to give the desired code for a particular station. Thus, at the sending end it is necessary to have a separate sending key for each station to be signaled.

Figure 15 shows the structure of a master sending key. This is arranged so that it may be adjusted by the operator to send out any desired code in the system. Thus, where this type of key is used but one is required at the sending end for signaling all stations.

Figure 16 shows the structure of the receiving selector mechanism with the cover removed. This piece of apparatus consists essentially of a polar relay with a ratchet attachment so arranged that successive operations of the relay, at the proper speed, cause the stepping around of a contact wheel. Stop-pins are provided at certain points to prevent the contact wheel from returning to its normal position when the regular sequence of stepping is interrupted at these points. Any interruption of the regular sequence of stepping when the contact wheel is

at any other point causes it to release. When the contact wheel has operated over 17 steps a contact is made which operates a signal. Thus, it is seen that to operate the selector so as to



Figure 15—Master Code Sending Key

give a signal, the direct-current pulses must occur in the proper sequence and the pauses between the groups of pulses must occur at points where stop-pins are located.

The apparatus which has been described is arranged so that as many as 78 stations on one

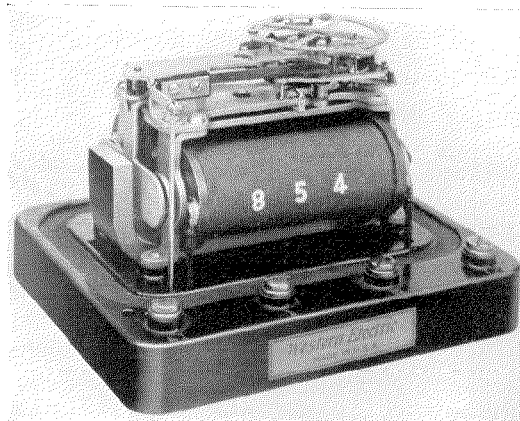

Figure 16—Receiving Selector Mechanism

wave length may be signaled separately. The same apparatus can also be arranged so that at each one of the 78 stations, four separate supplementary stations can be individually signaled.

For example, if a marine radio telephone system is involved, any one of four stations on each of 78 boats could be signaled separately. With a further slight modification in the apparatus, the same system is capable of being extended to permit the separate signaling of any one out of more than 200 stations. In each of these cases it is also possible to signal all of the stations simultaneously, when desired.

Figure 17 shows how a system like that which has just been described may be arranged for two-way operation. This embodies a duplication at both ends of the features of the one-way system. With such an arrangement, any one station of a number operating on a given wave length may signal any other station in the same system, without calling in stations not desired.

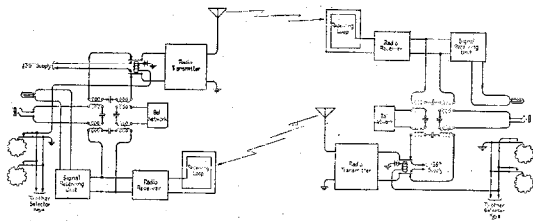

Figure 17—Simplified Diagram of Two-Way Radio System Arranged for Automatic Selective Signaling

Such a system might be used, for example, between ships equipped with radio telephone systems or between the ships and the shore, where signaling any one of several shore stations might be desired. It might also be used for intercommunication between a number of fixed stations in a point-to-point system.

#### FORM AND ASSEMBLY OF EQUIPMENT

In the possible uses of this signaling system which have been mentioned as likely to have the most immediate commercial application, the signaling apparatus is a part of the radio attendant's equipment rather than the telephone subscriber's apparatus. The apparatus chosen for the purpose is, therefore, in a form which is well suited to central station use, although it has no features which would prevent its being used conveniently at a subscriber's station if the service required it.

In assembling the signaling equipment a uniform panel arrangement has been developed,

with the idea that the various units might be used interchangeably in meeting the requirements of different types of installations. To this end, all apparatus has been mounted on

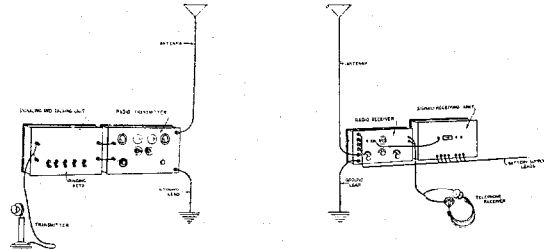

Figure 18—135-Cycle Selective Signaling System—Typical Arrangement of Apparatus for One-Way Operation

panels of a uniform length of 19 inches. The height of the different panels has varied according to the amount of apparatus in each unit, but this vertical dimension has in each case been a whole multiple of the basic dimension of  $1\frac{3}{4}$  inches.

By this means it is possible to mount the units in any desired manner. If, for example, it is desired to locate the radio and signaling apparatus on a desk or table, each equipment unit constitutes the front panel of a separate box. Figure 18 shows the various units required to make up a complete one-way system mounted in this manner.

Figure 19 shows in more detail the signaling

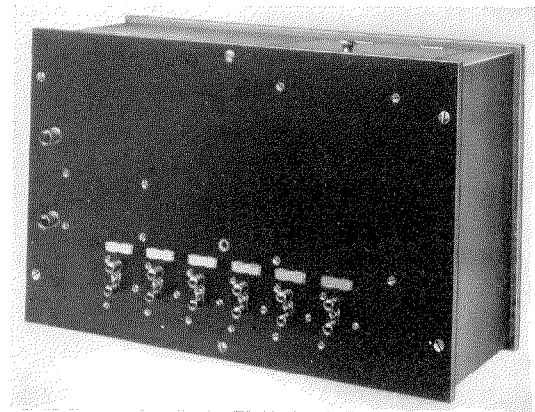

Figure 19—Signaling and Talking Unit

and talking unit of this group. This unit includes the sending keys, a simplified form of 135-cycle interrupter suited to use with the experimental set, and a six-volt dry cell battery

for operating the interrupter and signal-transmitting relay. It also includes an induction coil and talking battery for use with a telephone transmitter.

Figure 20 shows a separate 135-cycle interrupter unit which also employs the standard panel assembly. Removable covers are pro-

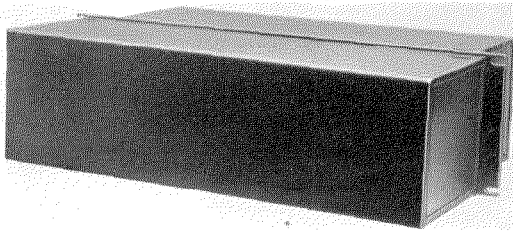

Figure 20—Assembly of 135-Cycle Interrupter

vided on both the front and back of the panel to protect the apparatus from mechanical injury. This interrupter is of a type adapted to commercial use with radio transmitters of various forms and output capacities. It employs the circuit arrangement previously described in the section on "135-cycle Supply."

Figure 21 shows an experimental radio transmitter unit of the type which was used in making

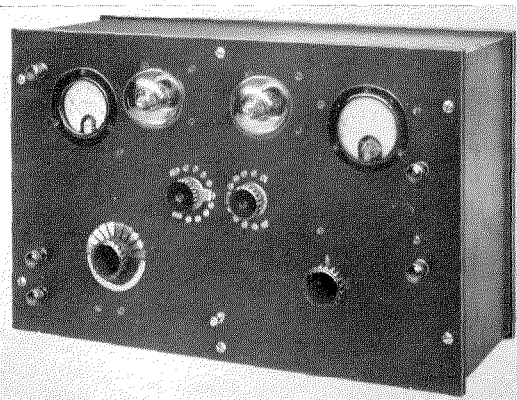

Figure 21—Experimental Radio Transmitter Unit

certain of the signaling tests over short distances. As explained in the section describing the basic system, this transmitter has an output of about 5 watts at 200 to 450 meters.

Figure 22 shows the assembly of one of the radio receiver units used in the tests. This is of the radio frequency amplifier type employing *N* tubes, such as would be employed in a commercial installation.

Figure 23 shows the signal-receiving unit for

automatic selective signaling. This includes the alternating-current relay, the selector mechanism and the necessary associated relays to respond to the incoming signal when connected

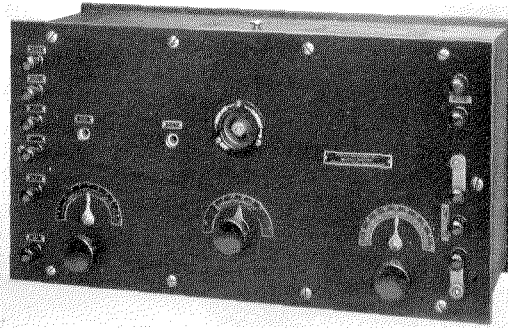

Figure 22—Radio Receiver Unit

to the detector tube of an ordinary radio receiver. This unit also includes an *N* tube amplifier for use when it is desired to secure the maximum signaling range. In this unit, terminals are provided on the rear of the panel in addition to the binding posts on the front, so that when the panel is removed from the box, rear wiring can be used if desired.

If it is desired to associate several panels together in one cabinet, each panel is detached from the box and mounted on the vertical

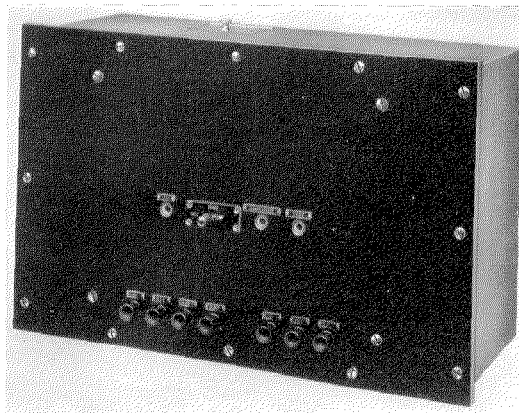

Figure 23—Signal Receiving Unit

supports which are provided in the standard cabinets. Figure 24 shows the experimental radio transmitter together with the signaling and talking unit assembled in one of these standard cabinets which are designed to house equipment of any type mounted on standard

panels. Figure 25 shows the radio receiver and signal-receiving unit in a similar cabinet.

In some cases it may be desirable to mount the radio receiving apparatus, signal-receiving

In this case, the radio transmitter is not included with the receiving apparatus, as it is assumed that in a commercial installation it may be of a larger and more powerful type than the experi-

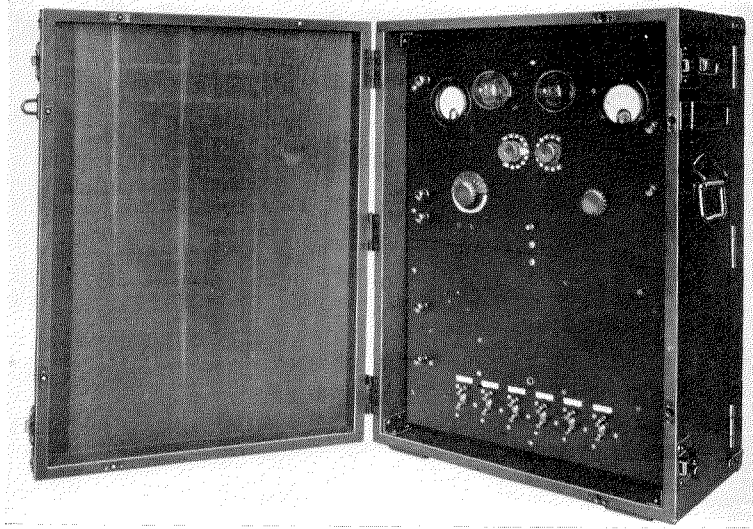

Figure 24—Assembly of Experimental Radio Transmitter with Signaling and Talking Unit in Cabinet

unit, signaling and talking unit and other associated apparatus together on one rack, without employing cabinets. Figure 26 shows how this might be accomplished, the various

mental one previously shown for purposes of illustration. The 135-cycle interrupter is also shown as a separate unit, since such a separate interrupter may be required if the output of a

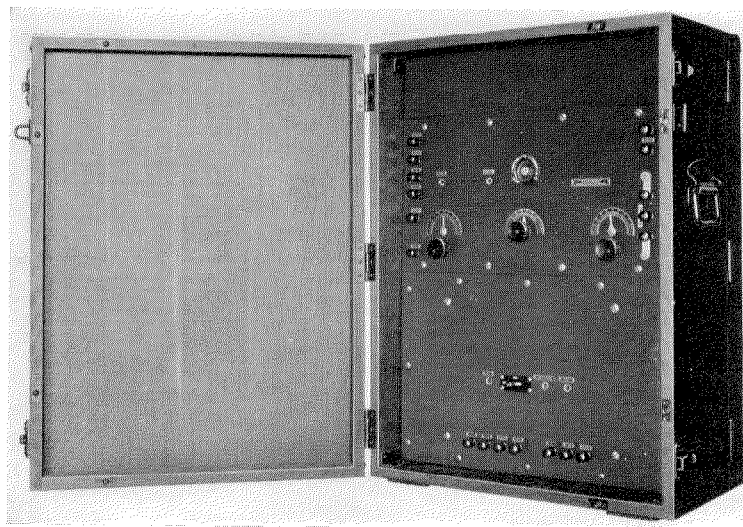

Figure 25—Assembly of Radio Receiver and Signal Receiving Unit in Cabinet

panels of standard length being assembled on a standard rack suited to mount many different types of units employing this type of design.

small interrupter of the type which was included in the signaling and talking unit for convenience in the experimental work, is insufficient.

## REVIEW OF SYSTEM CHARACTERISTICS

In considering the application to radio telephony of the signaling system which has been described, it is of interest to review certain of its outstanding characteristics. These may be briefly summarized as follows:

(1) The selectivity of the signaling system is such that interference of the kinds ordinarily experienced in radio telephony will make speech unintelligible before it will cause the signaling system to fail. Due to this high degree of selectivity, the signaling apparatus will operate if the radio system is adjusted so as to permit commercial transmission of speech, when the field strength is as low as it is desirable to use for the latter. With the types of radio apparatus which have been described, reliable operation of the signaling system has been secured with a field strength as low as 100 microvolts per meter.

(2) The sensitivity of the signal-receiving apparatus is such that the energy output obtainable from the smallest available types of vacuum tubes is more than sufficient to operate it satisfactorily. The type *N* vacuum tube can give an output of several hundred microwatts when operated as an amplifier, while the sensitive 135-cycle relay used in this signaling system will operate with as little as 30 microwatts.

(3) The system readily permits automatic selective signaling, whereby any one station out of a number on the same wave length may be signaled separately, as well as being adapted to use where only one sending and one receiving station are concerned. Seventy-eight stations on one wave length may be signaled separately with the apparatus which has been described while by employing other apparatus of a similar type which is at present available, over 200 stations may be signaled separately. The system is also adapted to permit the simultaneous signaling of all of the stations which may be included in the system on one wave length.

(4) The form and arrangement of the signaling apparatus are practically independent of the type of radio service, the power capacity of the radio system and the wave length used. It is applicable to ordinary radio transmitters and receivers without requiring modification of the radio equipment, and at the same time is simple in form and not high in cost as compared with the remainder of the radio equipment.

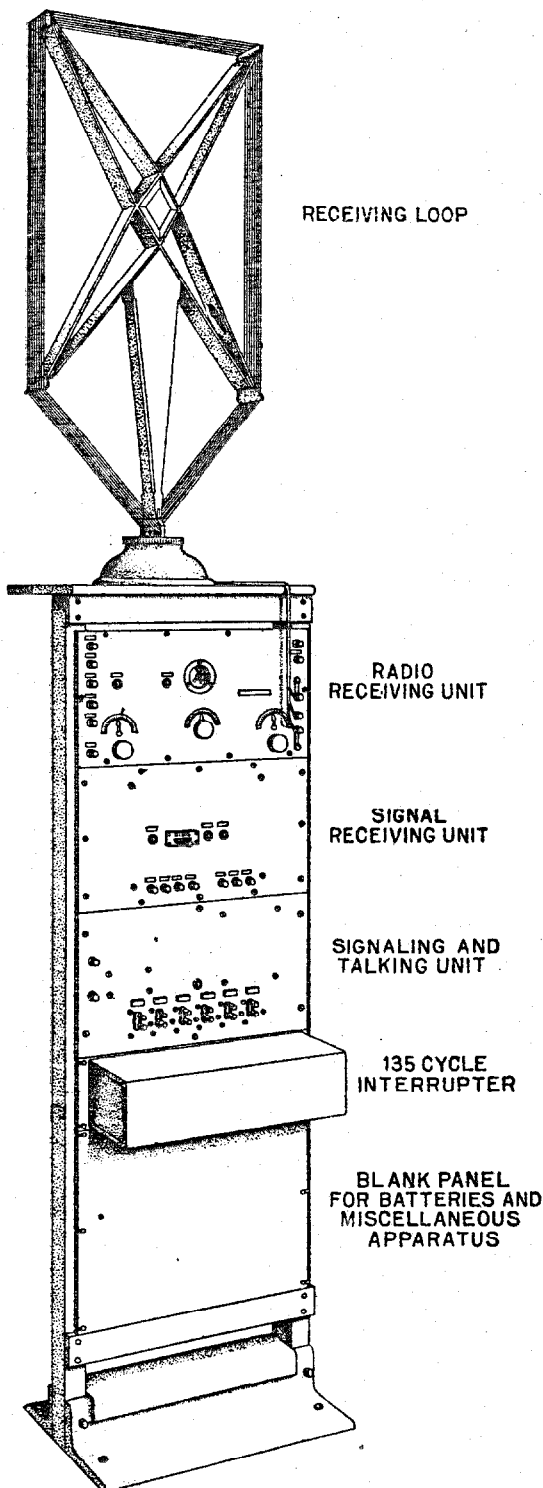

Figure 26—Typical Assembly Arrangement for Panel Mounted Radio Receiving and Signaling Apparatus on Standard Rack

# Telephone Transformers\*

By W. L. CASPER

*Engineering Department, Western Electric Company, Incorporated*

*Review of the Subject.* In the communication art transformers are used to transfer inductively the energy of speech currents from one electric circuit to another. In addition to this primary function which must be efficiently performed without distorting the speech significance of the transmitted energy, there is a variety of secondary functions such as making possible the super-position of phantom circuits on ordinary telephone circuits, discriminating between speech and telegraph or signaling frequencies, isolating circuits carrying direct current, and preventing inductive interference between adjacent circuits.

A discussion is presented of the frequency range over which telephone transformers must operate efficiently in transferring energy between two circuits and the three most common limiting impedance combinations of these circuits, namely, both circuits resistances, one circuit a resistance and the other a positive reactance and one circuit a resistance and the other a negative reactance. The efficiency with which energy is transmitted is measured by comparison with an ideal transformer which is one which introduces no losses and has the best ratio to connect the two circuits. In studying its action the transformer is replaced by its equivalent T network which affords a ready means of analyzing its losses. The variation of the transformer losses with frequency is discussed for the three above mentioned combinations of circuit impedances and characteristic curves are shown for transformers of different mutual impedances. Characteristics are also given showing the operation of the input transformer into the vacuum tube as the mutual impedance and the transformer ratio are varied. The circuit conditions of the input transformer represent a common special case of the third combination of circuit impedances.

The mechanical construction of various transformers is shown, namely, that of the ordinary battery supply repeating coil, of the telephone induction coil, and of three more recent types of transformers used principally in various vacuum tube circuits such as telephone repeaters, carrier frequency and radio circuits. These transformers are all constructed so as to give the desired accuracy of speech transmission under their particular circuit conditions. The climatic conditions present in the widely distributed telephone plant have been carefully considered and the transformers designed to maintain their initial efficiency over a long period of years.

## INTRODUCTION

THE transformers used in the telephone plant are required to transmit speech or signaling currents from one electrical circuit to another in such a way as to obtain maximum transfer of power. They differ in their required action from power transformers in two main respects. They have to transmit milliwatts efficiently instead of kilowatts and must operate efficiently under a variety of conditions

of voltage, frequency, etc., instead of under single fixed conditions. These various requirements of operation make it necessary in designing a telephone transformer to proportion it differently from a power transformer.

The requirements of circuits in which telephone transformers are used make it necessary to consider their efficiency in detail over a wide range of frequency and at the same time make sure in each particular case that they have characteristics apart from this efficiency which will enable the circuits to function properly. Such other characteristics, one or more of which may be required of a transformer, are:

1. The efficient transmission of telephone currents while carrying super-posed direct current as in the cord circuit battery supply repeating coil.
2. A high degree of impedance balance between the windings in order: (1) to avoid unbalancing the circuit and rendering it subject to noise or cross-talk troubles; (2) to limit cross-talk in closely associated circuits as in the case of the phantom circuit repeating coil in which the balance required is very precise, the two phantom circuit windings being balanced to about 0.01 per cent; or (3) to prevent sustained oscillations or singing in a two-way telephone repeater as in the case of the repeater output transformer.
3. High efficiency as a low-frequency power transformer, for example, at  $16\frac{2}{3}$ -cycle signaling frequency, as well as high efficiency as a telephone speech frequency transformer.
4. Low efficiency as a power transformer at the frequencies of interruption of direct current used in Morse telegraph as well as high efficiency as an audio frequency transformer. This low power efficiency is necessary in order to reduce troubles, such as, noise interference, false operation of relays and acoustic shock when the same lines are used for both telephone and telegraph.
5. Impedance transformation closely approximating that obtained with an ideal transformer as in the line transformers in circuits in which

\* Presented at the Midwinter Convention of the A. I. E. E., Philadelphia, Pa., February 4-8, 1924, and published in the March issue of the *Journal*, Vol. XLIII, No. 3.



two-way telephone repeaters are employed. By impedance transformation is meant the modification of the line or network impedances when viewed through the transformer.

6. Impedance transformation for a pair of transformers alike over the transmitted audio frequency range for use as the line and network transformers in two-way repeater operation.

7. Stable impedance transformation even when having been subject to large magnetizing forces as in the line transformers in two-way telephone repeater circuits in order to maintain the required balance between line and network under all conditions of service.

8. Minimum production of harmonics due to the magnetization characteristics of the iron which would cause interference in the normal transmission frequency range, as in the line transformers on circuits which are used for the transmission of Morse telegraph in addition to speech.

9. To isolate conductively one portion of a circuit from another as in transformers used to connect grounded to metallic lines or to isolate subscriber sets from the telephone lines which parallel high-tension power lines and which may therefore be exposed to large inductive disturbances.

10. To maintain the usual conductive isolation and furnish a path to ground for longitudinal currents as may be obtained with a transformer with a shield between primary and secondary windings. By a longitudinal current is meant one which flows along a circuit and returns by some path exterior to that circuit.

As the primary function of the telephone transformer is to transmit telephonic speech efficiently, this paper will be limited to this part of the subject, although the complexity of the telephone plant rarely permits a transformer to be free from the necessity of meeting one or more secondary requirements such as those mentioned above. Two winding transformers only will be discussed.

#### FREQUENCY REQUIREMENTS

In the ordinary telephone circuit a range of frequency of about 200 to 2500 cycles is allotted to the transmission of speech, both of these limits varying somewhat with the type of circuit.

In the case of long distance lines in which it is desirable to utilize the circuits to the best economic advantage, the frequency range below 3000 cycles is allotted to speech, signaling and telegraph and above that frequency to the transmission of carrier telegraph and telephone. A transformer used for the transmission of speech currents is required to operate efficiently over the entire range of frequency transmitted.

With the present intensive use of the telephone lines, transformers may be required to transmit low-frequency signaling of  $16\frac{2}{3}$  or 20 cycles, composite ringing of 135 cycles, speech from 200 to 3000 cycles and carrier from 3000 to 30,000 cycles. This carrier frequency is divided into a number of frequency channels which are used for separate telegraph or telephone circuits. A carrier range from 3000 to 10,000 is generally used for telegraph while with carrier telephone a frequency range from 6000 to 30,000 is used.<sup>1</sup> In certain radio telephone circuits transformers are required to operate at frequencies of the order of 50,000 to 100,000 cycles and in radio frequency amplifiers at approximately 1,000,000 cycles. Telephone transformers may be required to operate at any one of these frequencies or frequency bands or they may be required to transmit efficiently two or more of them. Illustrations of this are the ordinary phantom circuit repeating coil which transmits low-frequency ( $16\frac{2}{3}$  cycles) signaling and composite ringing (135 cycles) as well as speech, and the transformers which connect the Key West-Havana cable to the shore lines and which are designed to transmit carrier telegraph up to about 6000 cycles as well as ordinary telephonic speech.

In radio transmitters used for broadcasting and in Public Address Systems<sup>2</sup> where it is desired to transmit music and to reproduce accurately the exact quality of the speaker's voice, it is necessary that any transformers in the circuit operate efficiently at frequencies at least as low as 50 cycles and as high as 5000 cycles.<sup>3</sup>

<sup>1</sup> Colpitts and Blackwell: "Carrier-Current Telephony and Telegraphy," *TRANS. A. I. E. E.*, Vol. XL, page 301.

<sup>2</sup> Green and Maxfield: "Public Address Systems," *Electrical Communication*, Vol. I, No. 4

<sup>3</sup> Fletcher: "The Nature of Speech and Its Interpretation," *Electrical Communication*, Vol. I, No. 1.

Martin and Fletcher: "High Quality Reproduction of Speech and Music," *Electrical Communication*, Vol. II, No. 4.



In the following the operation of transformers over the voice range of frequencies only will be discussed but it is to be noted that the principles involved apply to transformers for carrier and radio frequencies as well.

#### IMPEDANCE REQUIREMENTS

Another important factor in determining the design and operation of the transformer are the impedances of the circuits which the transformer connects. The circuit impedances, which are the impedances as measured from the place where the transformer is to be located, may be but a few ohms in magnitude or may be several megohms. They may also vary appreciably in magnitude or phase angle over the frequency range.

The circuit impedances met in the telephone plant are seldom either substantially pure resistances or reactances over the entire frequency range and in considering the action of a transformer between two such circuits at any frequency the actual impedances of the circuits at that frequency must be employed. It is impossible to discuss all possible combinations of circuit impedances here. However, with a knowledge of the action of transformers between three limiting combinations of circuit impedances an indication will be given of their operation under all conditions of importance. These three limiting impedance conditions are:

1. Sending and receiving end impedances both resistances.
2. Sending end impedance a resistance, and receiving end impedance a positive reactance.
3. Sending end impedance a resistance, and receiving end impedance a negative reactance.

It is, of course, to be understood that the sending and receiving end impedances may be interchanged. There are, in addition, three other possible limiting circuit impedance conditions—the sending and receiving end impedances both positive or negative reactances and the sending end impedance a positive reactance and the receiving end impedance a negative reactance. These three impedance conditions are less usual than the first three and it is felt to be unnecessary here to discuss in detail the action of telephone transformers in circuits of this type.

#### TRANSFORMER EFFICIENCY

The telephone transformer is generally used for transmission in both directions and the usual definition in power work for the primary as the winding which receives the energy from the supply circuit does not hold. The terms primary and secondary are therefore used simply to distinguish between the two windings without regard to the energy flow.

It can be shown that maximum power may be delivered from one circuit to another if the impedances of the circuits are equal in magnitude and opposite in phase, that is, if the resistances are equal and if the reactances annul each other. Maximum power may be delivered from one circuit to another in which the reactances annul each other and in which the resistances are not equal provided an ideal or perfect transformer of proper ratio is used to connect the circuit resistances. In the ordinary case it is not possible to annul the reactances over the entire frequency range to be transmitted and no attempt is therefore made to modify them. Under these conditions transformers are used to connect the two circuit impedances and without annulling reactances the greatest amount of power will be delivered by connecting these impedances by means of an ideal transformer of the best ratio.

By an ideal transformer is meant one which neither dissipates nor stores energy. Such a transformer has infinite primary and secondary self-impedances, infinite mutual impedance, unity coupling factor or zero leakage impedances, and zero d-c. resistances. An ideal transformer for any given circuit condition also has the best ratio to connect the circuit impedances.

It may be stated that when the circuit reactances are not annulled by the addition of reactances of the opposite sign, it is possible to deliver more power to the load impedance at certain frequencies by the use of an actual than by an ideal transformer as the transformer impedances may tend to annul the circuit reactances.

It has long been customary in dealing mathematically with a transformer to use in its place some equivalent network such as a  $\pi$  or a  $T$  network.<sup>4</sup> The use of an equivalent  $T$  network

<sup>4</sup> Campbell: "Cissoidal Oscillation" TRANS. A. I. E. E., Vol. XXX, Part 2, page 873.

changes a coupled circuit into a simple circuit in such a way as to make it easier to see the effect of changes of the transformer constants on the transmission of the circuit. The equivalent  $T$  network of a two-winding transformer is shown in Figure 1 in which the junction point of the three arms is considered not accessible and in which  $P$ ,  $S$  and  $M$  are respectively, the primary, secondary and mutual impedances.

The series arms  $a$  and  $b$  of the  $T$  network consist respectively of the differences of the primary and mutual impedances and the

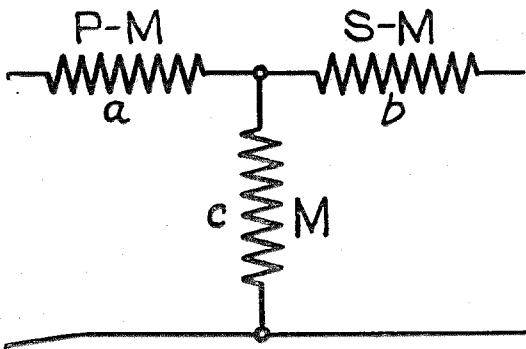

Figure 1

secondary and mutual impedances. The equivalent  $T$  network of the transformer is sometimes shown having series arms  $P + M$  and  $S + M$  and shunt arm  $-M$ . These two  $T$ 's may be derived from the transformer impedances depending on whether the secondary is connected to give a received current in one direction or the other. The  $T$  shown here is the most convenient for ordinary considerations. Considering for the present a unity ratio transformer, the arm  $a$  will contain the d-c. resistance of the primary and the arm  $b$  the d-c. resistance of the secondary. In addition, the leakage impedance will be divided between them. Whether the leakage impedance should properly be considered principally in the arm  $a$  or principally in the arm  $b$  or divided equally between them depends on the relative location of the primary and secondary windings. However, in the ordinary case the coupling factor is so near unity and the leakage impedance is so small in comparison with the primary, mutual and secondary impedances that practically no error is introduced if it is assumed to be divided equally between them.

The shunt arm  $c$  of the equivalent  $T$  network contains the mutual impedance  $M$ . This mutual impedance equals  $K \sqrt{P_0 S_0}$  where  $P_0$  and  $S_0$  are the primary and secondary impedances less their respective d-c. resistances, and where  $K$  is the coupling factor. The coupling factor  $K$  has a phase angle in actual transformers but where the coupling factor is nearly unity the angle may usually be disregarded. The mutual impedance is a complex quantity as are also the primary and secondary impedances of all usual transformers. As the mutual impedance is dependent on  $P_0$  and  $S_0$ , any factors which enter into  $P_0$  and  $S_0$  will also enter into  $M$ . The reactance components of these impedances depend on the number and distribution of turns in the windings and the dimensions and permeability of the core. The resistance component is made up of an effective resistance due to hysteresis, eddy current and dielectric losses.

The distributed or lumped capacities of the windings are best considered in their effective values. These effective capacities may be regarded as shunted across the primary or secondary of the transformer or may be considered as located across  $M$  of the arm  $c$  of the equivalent  $T$  of the transformer. If this effective capacity is considered in shunt with  $M$  and combined in it, both the resistance and the

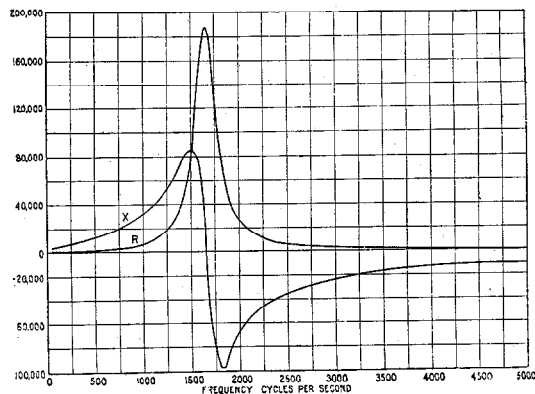

Figure 2—Mutual Impedance  $M$  of a Phantom Circuit Repeating Coil

X Effective reactance—ohms  
R Effective resistance—ohms

reactance of  $M$  will have components due to the effect of this capacity. The effective resistance and effective reactance of  $M$  will then go through the usual curves for parallel resonance

as shown in Figure 2 for a typical phantom circuit repeating coil.

One other factor frequently enters into the determination of the effective value of  $M$  as well as  $P_0$  and  $S_0$ . In some circuits, in order to economize on the amount of apparatus necessary, a direct current is allowed to flow through the primary or secondary windings of the transformer. This causes a uni-directional magnetizing force in the core in addition to the a-c. magnetizing force of the speech current. This d-c. magnetization causes a decrease in  $M$  from the initial value or value with no d-c. magnetization, depending upon the strength of this magnetization and the reluctance of the magnetic circuit.

The series arms of the equivalent  $T$  of the unity ratio transformer are thus impedances consisting of the d-c. resistances and the leakage impedances and are usually relatively small compared with the circuit impedances while the shunt arm is the mutual impedance which is usually large compared with the circuit impedances. The simplicity of the equivalent  $T$  network of the unity ratio transformer is very useful and convenient in studying the effect of the transformer in producing losses. With an inequality ratio transformer, however, the arms  $a$  and  $b$  which equal  $P-M$  and  $S-M$ , respectively, do not appear as small impedances. For instance, if  $P$  is larger than  $S$ ,  $P-M$  will be a large positive impedance and  $S-M$  will be a large negative impedance and the  $T$  network has no decided advantage, from a mathematical standpoint over the ordinary transformer network.

Figure 3 shows a transformer operating between the sending end impedance  $Z_1$  and

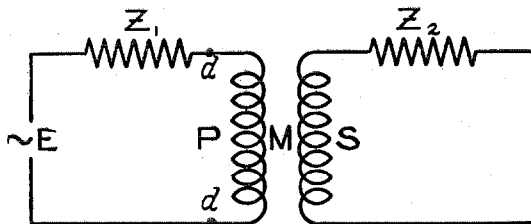

Figure 3

receiving end impedance  $Z_2$ .  $Z_2$  may be considered less than  $Z_1$ . The actual sending and receiving circuits in telephone work are usually quite complex, each consisting of numerous

series and shunt elements. According to Thévenin's theorem<sup>5</sup> any electromotive force acting through any circuit no matter how complex will produce the same current in any receiving impedance as will some other electromotive force bearing a definite relation to the first electromotive force and acting directly in series with the impedance which would be obtained by a measurement of the circuit looking away from the terminals from which the receiving circuit has been disconnected. From this theorem it may be shown that the complex sending and receiving circuits may be replaced respectively by simple series impedances  $Z_1$  and  $Z_2$  which are the impedances of the complex sending and receiving circuits looking away from the place where it is desired to join them, and a transformer or any other structure studied between these impedances will act identically as if connected between the more complex actual circuits.

If the transformer shown in Figure 3 were the ideal transformer to connect the circuit impedances  $Z_1$  and  $Z_2$ , the best impedance ratio could be found as follows: The current received through the impedance  $Z_2$  is

$$I = \frac{E M}{(Z_1 + P)(Z_2 + S) - M^2}$$

But since in the ideal transformer  $P$ ,  $S$  and  $M$  are infinite pure reactances and the coupling factor is unity and  $M = \sqrt{P S}$

$$I = \frac{E M}{Z_1 S + Z_2 P}$$

This expression may be shown to be a maximum when the ratio  $P/S$  is equal to the absolute magnitude of  $Z_1/Z_2$ .

A transformer designed for the circuit of Figure 3 should, therefore, have an impedance ratio  $R = P/S = Z_1/Z_2$ . With an ideal transformer of such a ratio the impedance at  $d, d$  looking toward the receiving end with the sending end open at  $d, d$  will equal  $Z_1$ . Such an impedance characteristic as measured with an actual inequality ratio transformer having an impedance ratio of 1:2.66 and a receiving end impedance  $Z_2$  of 2000 ohms non-inductive resist-

<sup>5</sup> Comptes Rendus for 1883, Vol. XCVII, page 159.

ance is shown as  $R+jX$  in Figure 4. The corresponding characteristic for an ideal transformer of the same ratio is shown as  $R^1$ . These characteristics show that an actual transformer in transforming or modifying the circuit impedance adds both a resistance and a reactance

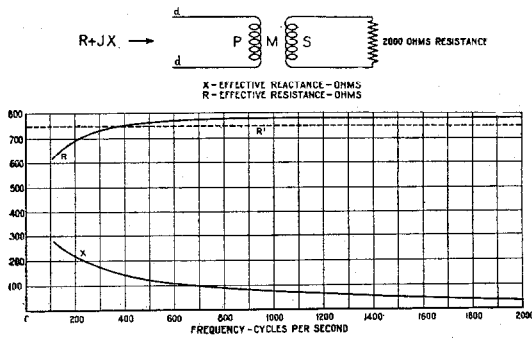

Figure 4—Impedance Measured at  $d-d$  Ratio of Impedances  $P:S = 1:2.66$

component to the value of the circuit impedance divided by the transformer impedance ratio except at low frequencies where the transformer has a considerable shunting effect on the circuit impedance as explained later on, and where the resistance falls below the value obtained with an ideal transformer and the reactance is increased over its value at higher frequencies.

It may be stated that under certain circuit conditions it is quite important that the transformer give a transformation of the circuit impedance which is nearly ideal in order to limit the impedance irregularity introduced in the line.

For analysis or design work involving inequality ratio transformers the circuit of Figure 3 may be reduced to a circuit in which the impedances  $Z_1$  and  $Z_2$  have the same absolute magnitude and the equivalent  $T$  network of the transformer may be reduced to an equivalent  $T$  of an equivalent unity ratio transformer. In this way the disadvantages of the equivalent  $T$  network of the inequality ratio transformer are avoided. This transformation is made by multiplying the circuit impedance  $Z_2$  and the secondary impedance  $S$  by the impedance ratio  $R$  and multiplying the mutual impedance  $M$  of the transformer by  $\sqrt{R}$  as shown in Figure 5. As  $P_0 = M\sqrt{R}/K$ ,  $P - M\sqrt{R}$  will be a small positive quantity, and as  $S_0 = M/K\sqrt{R}$ ,

$SR - M\sqrt{R}$  will be a small positive quantity.  $M\sqrt{R}$  will be a large positive quantity. This treatment of the transformer presupposes that  $P_0$  and  $S_0$  have the same phase angle. This is not necessarily precise in the case of all transformers but will hold with sufficient accuracy for the usual type of iron core transformers.

The series arms  $a$  and  $b$  and the shunt arm  $c$  of the equivalent unity ratio  $T$  network consist respectively of the d-c. resistances of the primary and secondary plus the leakage impedance, and the mutual impedance, all reduced to terms of the sending end impedance  $Z_1$ . In this transformation a circuit such as is shown in Figure 3 is changed to an equivalent circuit as shown in Figure 5. This equivalent circuit gives a received current which is less than the received current of the circuit of Figure 3 by the factor  $I/\sqrt{R}$  but the received power is the same in each case. This equivalent  $T$  of the equivalent unity ratio transformer consisting of relatively small impedances in series with the circuit and a relatively high impedance as a shunt across the circuit, furnishes an easy means of studying the losses produced by a transformer.

The telephone engineer as well as the power engineer is concerned with the delivery of power. In power work the efficiency of a device is usually expressed in per cent as the ratio of the power delivered to the power supplied or the watts output divided by the watts input. In telephone work it is customary to consider the losses caused by the device rather than its efficiency. These losses are determined by the change in received power caused by the insertion of the device in the circuit. They are expressed in terms of the attenuation of a length (in miles) of standard cable ( $M. S. C.$ ). This unit is such that if two currents  $I_1$  and  $I_2$  flow through the same impedance (load) delivering powers  $W_1$  and  $W_2$  respectively, the number of miles corresponding to the current or power ratios is given by the relation  $M S C = 21.12 \log_{10} I_1 / I_2 = 10.56 \log_{10} W_1 / W_2$ . It can be shown from the above that for small losses a change in current ratio of 1 per cent corresponds approximately to 0.1 mile of standard cable.

In inserting an ideal transformer of best ratio between two circuits of different impedance an increased current is obtained through the

receiving end impedance and a transmission gain is effected. If an actual transformer were used in place of the ideal transformer a somewhat lesser gain would usually be obtained due to the losses of the transformer. The transformer loss is determined by the ratio of the received current with the transformer in circuit to the received current with the ideal transformer in circuit.

It is to be noted that the above mentioned ratio of received currents which is used as the basis of the transmission loss of the telephone transformer takes no account of the phase angle of the load impedance and bears no direct relation to the ratio of the power output to the power input. There is, therefore, no very simple relation between the miles loss and the power efficiency. For example, a telephone transformer might have equally low losses when operating into a pure reactance as when operating into a resistance, whereas, the power efficiency approaches zero when the phase angle of the load approaches 90 deg. When operating into a resistance load the current ratio of the telephone transformer approaches the square root of the power efficiency for very efficient transformers.

### TRANSFORMER OPERATING BETWEEN RESISTANCES

From the circuit of Figure 5, it can easily be seen that provided the circuit impedances approximate resistances, the smaller  $P - M\sqrt{R}$  and  $SR - M\sqrt{R}$  are and the larger  $M\sqrt{R}$  is, the smaller will be the loss caused by the transformer. The speech current used in most telephone circuits is so minute that the permeability of the transformer cores remains at approximately its initial value regardless of what winding is placed on the transformer. An increase in the mutual impedance will lower the shunt losses, but will also cause an increase in the series losses, as there will be an increase in the d-c. resistance and the leakage impedance in practically the same ratio as the increase in the mutual impedance. If the capacity in the transformer windings is neglected, it will be noted that both the series and shunt arms of the transformer  $T$  contain components of impedances which increase with the frequency and that at zero frequency the shunt loss will be

infinitely great and at infinite frequency the series loss will be infinitely great while at intermediate frequencies these losses will be finite. It is, therefore, evident that for a given transformer there will be some frequency at which the transformer operates with minimum losses, and that for operation at a given frequency there is a value of mutual impedance for any given transformer structure at which the losses are a minimum.

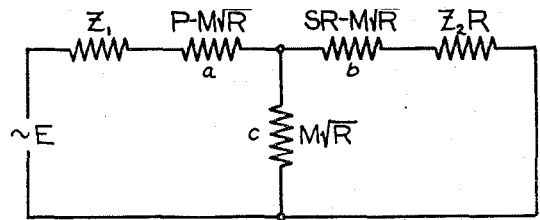

Figure 5

The transformer of Figure 5 when operating between non-inductive resistance impedances will produce a loss-frequency characteristic, as shown in Figure 6, in which the various curves are for a fixed circuit condition and for several different windings or values of mutual impedance. In

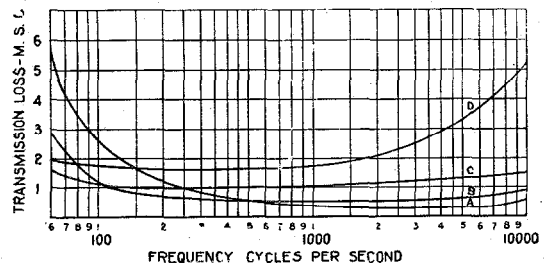

Figure 6—Transformer Operating Between Resistances

Sending end resistance 6000 ohms  
Receiving end resistance 2000 ohms

Transformer	$\frac{M\sqrt{R}}{Z_1}$ at 1000 cycles
A	5
B	10
C	20
D	40

these characteristics the d-c. resistance of the winding produces a loss which is practically independent of frequency. There is an increase in loss at the lower part of the frequency range due to the increased shunting effect of  $M\sqrt{R}$  at the lower frequencies. This loss decreases as the frequency increases. Although in any actual case the departure of the angle of  $M\sqrt{R}$

from 90 deg. may cause an appreciable part of the shunting loss it is usually possible to obtain greater reduction in loss by increasing the absolute magnitude of this impedance than by increasing the phase angle. If the transformer has sufficient capacity in and between the windings to affect appreciably this impedance, it may also affect the loss due to it. In some transformers, the effective capacity may be large enough to cause resonance within the frequency range which is transmitted efficiently. This would cause  $M\sqrt{R}$  to have a maximum value at the resonance frequency, and the loss due to the shunt arm would go through a minimum value at this frequency. If the capacity is large enough to produce this resonance near the lower end of the transmitted frequency range, its effect at the higher frequencies in decreasing the magnitude of  $M\sqrt{R}$  might be sufficient to cause an appreciable loss at these frequencies.

The magnitude of the leakage impedances, which, together with the d-c. resistance, make up the series arms of the  $T$ , also tends to increase the loss at the upper frequencies, as this impedance increases with the frequency. In cases where both the leakage and the capacity are high, the effect of one may to some extent tend to lessen the loss produced by the other at some frequencies.

It is to be noted that as the leakage impedance generally consists of a larger reactance than effective resistance, this impedance has far less effect in determining the value of received current through  $Z_2$  when the circuit impedances are resistances than does the d-c. resistance.

In the design of telephone transformers to operate with little distortion between resistance impedances, it follows that the transformer impedance ratio is determined as the ratio of the circuit impedances between which the transformer operates, the loss at the lower frequencies is determined principally by the impedance of the shunt arm of the  $T$  network,  $M\sqrt{R}$ , and the loss at the higher frequencies is determined principally by the leakage impedance and the effective capacity. The d-c. resistance adds a loss which is practically constant over the frequency range.

The determination of the windings of such a transformer would be made as follows, assuming

for the present that the transformer construction has already been decided upon. The impedance ratio of the transformer is calculated as the ratio of the circuit impedances. Using this ratio, the winding is calculated, choosing such sizes of wire as will make the ratio of d-c. resistance of primary and secondary the same as the impedance ratio, and will completely fill the winding space with an allowance for commercial variations in the winding space, dimensions, wire diameter, winding and insulation. As the transformer dimensions and core permeability (initial or low magnetic density value) are known, the inductance for a given number of turns may be calculated as proportional to the square of the turns or from a trial winding the relation between impedance and number of turns may be obtained. The coupling factor and effective capacity are best obtained by a trial design using the arrangement of winding which is expected to be used in the final design. All the information for determining equivalent  $T$  networks is thus available.

The loss curves for different values of mutual impedance may be predetermined from these equivalent networks and the desired winding chosen from these characteristics. Such a series of curves for a transformer operating between resistance impedances is shown in Figure 6. In the table in this figure is shown the ratio of the shunt arm,  $M\sqrt{R}$ , of the equivalent  $T$  network of the equivalent unity ratio transformer at 1000 cycles, to the sending end impedance  $Z_1$ .

Figure 7 shows the transmission loss charac-

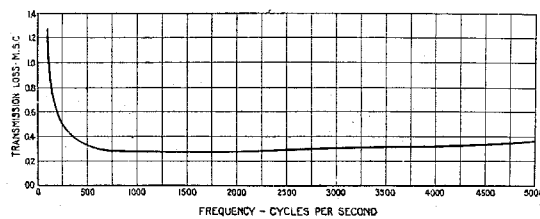

Figure 7—Transmission Loss Characteristic of Phantom Circuit Repeating Coil Operating Between 1830-ohm Resistance Lines

teristic of a phantom circuit repeating coil operating between non-inductive resistance lines of 1830 ohms. The mutual impedance-frequency characteristic of this repeating coil was shown in Figure 2 from which it may be noted that the

reactance component of this impedance is negative above a frequency of 1700 cycles per second. Although above this frequency the mutual impedance decreases, its magnitude is so great as compared with that of the line impedance that the loss due to it is practically negligible at a frequency of 5000 cycles per second.

TRANSFORMER OPERATING BETWEEN A RESISTANCE AND A POSITIVE REACTANCE

The case of a transformer operating into a pure positive reactance is, of course, hypothetical and no energy would be delivered unless the reactance had a resistance associated with it. In any actual case, there is always a resistance component to this impedance, but for this discussion it is assumed that the resistance component is practically zero.

In this circuit condition we have one impedance which is independent of the frequency and another which is directly proportional to the frequency. By properly choosing the transformer ratio it is possible to match the circuit impedances at any particular frequency and deliver maximum energy at this frequency. At

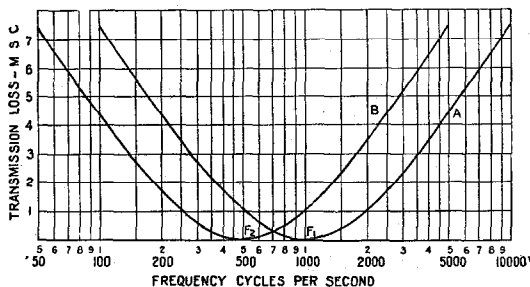

Figure 8—Transformer Connecting a Resistance to a Positive Resistance  
 "A" and "B" ideal transformers of Impedance ratio  $R/X$  at frequency " $F_1$ " and " $F_2$ " respectively.

other frequencies there would be a transmission loss due to this failure to match impedances, and it follows that even with an ideal transformer, it is not possible to obtain uniform efficiency over a range of frequency, and that by selecting the proper ratio, maximum efficiency may be obtained at any desired frequency.

Figure 8, curve A, shows the transmission loss, in miles due to the introduction of an ideal transformer of fixed ratio between the sending end resistance  $Z_1$  and the receiving end reactance  $Z_2$ . This transformer serves to match these

impedances at the frequency  $F_1$  and the curve shows the loss above what would be obtained if the impedances were matched at any other frequency. Curve B is a similar characteristic for an ideal transformer, matching impedances at frequency  $F_2$ .

Figure 5 may be considered to represent the equivalent unity ratio circuit ( $Z_2$  being less than  $Z_1$ ) with the  $T$  network of the equivalent unity ratio transformer in the circuit. If, for the present the effect of capacity in the mutual impedance is neglected, the losses produced by the components of the series arms of the transformer operating under these circuit conditions, that is the d-c. resistance and the leakage reactance, are approximately of equal importance.

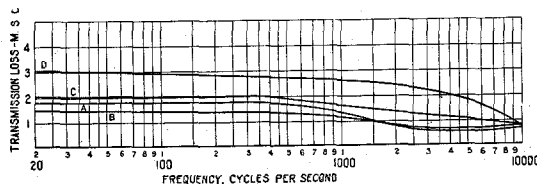

Figure 9—Transformers Operating Between a Resistance and a Positive Reactance

Transmission loss above that of an ideal transformer of the same ratio. Sending end impedance  $Z_1 = 6000$  ohms. Receiving end impedance  $Z_2 = (R + jL)\omega$  ohms =  $20 + j2000$  ohms at 1000 cycles. Transformer impedance ratio = 3:1

	$\frac{M \sqrt{R}}{Z_1}$ at 1000 cycles
Transformer A	5
B	10
C	20
D	40

The d-c. resistance causes a loss which is finite at low frequencies and decreases to zero at infinite frequency while the leakage reactance causes a loss which is finite at infinite frequency and reduces to zero at zero frequency. The mutual impedance produces a loss which is infinite at zero frequency and decreases to a relatively small finite value at infinite frequency.

If the mutual impedance contains a capacity component, a reduction of loss may be produced at certain frequencies due to resonance of the capacity reactance with the mutual, leakage and receiving end reactances. This may even give a gain over the characteristic of the ideal transformer for a limited frequency range, but above the resonant frequency an increased loss is produced which approaches infinity.

Characteristics A, B, C and D of Figure 9 show measurements of actual transformers having different values of mutual impedance and

the proper ratio to match impedances at 1000 cycles. The transmission losses shown are the losses of the actual transformers compared with the corresponding ideal transformer of the same ratio. The ideal transformer, itself, has a loss characteristic causing distortion which varies with the frequency as shown in Figure 8. The ratio of  $M\sqrt{R}:Z_1$  at 1000 cycles is shown in the table. These transformers are the same as those shown in Figure 6 as operating between resistances. The losses at the upper frequencies are reduced somewhat by the winding capacity. It may be noticed that of the transformers whose characteristics are shown in Figure 9, transformer *B* introduces minimum loss.

In designing a transformer to connect a resistance to a positive reactance, the impedance ratio of the transformer is determined as the ratio of the circuit impedances at the frequency at which it is desired to deliver maximum power. The choice of best mutual impedance may be made by assuming windings of different impedance and predetermining their loss characteristics as has been described under transformers working between resistances.

#### TRANSFORMER OPERATING BETWEEN A RESISTANCE AND A NEGATIVE REACTANCE

Where a transformer operates between a resistance and a negative reactance, a condition exists where one impedance is independent of and the other is a function of the frequency, although in this case the reactance varies inversely with the frequency. Here again in order to deliver power it is necessary to assume that the receiving end impedance has a small resistance component. The transformer ratio may be made to match these impedances at any frequency, delivering maximum energy, but causing an increasing loss above and below this frequency. The loss characteristic of such a transformer is shown in Figure 10 which gives the increase in transmission loss of the ideal transformer of fixed ratio over the ideal transformer of the actual ratio of the circuit impedances at all frequencies.

Referring to Figure 5 and considering  $Z_2$  a negative reactance, there are two frequencies at which resonance takes place. At the first frequency parallel resonance occurs between the

impedance  $M\sqrt{R}$  and  $Z_2 R$  and at the second, series resonance occurs between the leakage reactance components of  $P - M\sqrt{R}$  and  $S R - M\sqrt{R}$  and the receiving circuit impedance  $Z_2 R$ . The d-c. resistance causes a loss which, in general, is finite at zero frequency and becomes zero at infinite frequency. The leakage

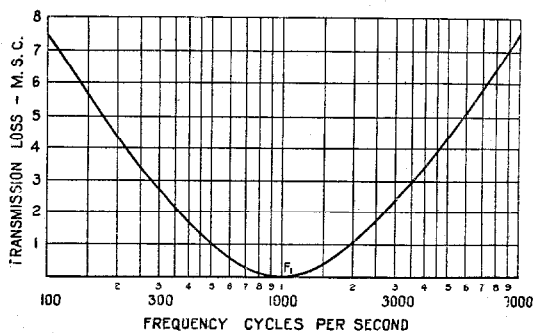

Figure 10—Transformer Connecting a Resistance to a Negative Reactance  
Ideal transformer of impedance ratio  $R/X$  at frequency " $F_1$ " = 1000 cycles

reactance produces a loss which, in general, increases from zero at zero frequency to infinity at infinite frequency going through a minimum, however, and in some cases causing a gain over the ideal transformer at the second resonance frequency. The mutual impedance, in general, produces a loss which decreases from infinity at zero frequency to a finite value at infinite frequency going through a minimum, however, at the first resonance frequency and possibly even causing a gain over the ideal transformer at this frequency.

#### INPUT TRANSFORMER

The usual case of a transformer operating under these circuit conditions is the input transformer of the vacuum tube amplifier, the vacuum tube approximating a condenser in its grid-filament impedance.

With the receiving end impedance an ordinary capacity of constant phase angle, it is necessary in order to deliver uniform power over a range of frequency to match impedances at all frequencies or supply a voltage which decreases inversely as the square root of the frequency. In a vacuum tube amplifier, when the output or plate-filament current is proportional to the input or grid-filament voltage, uniform



output power will be delivered at varying frequency provided the input voltage is kept constant. When operating into a vacuum tube, therefore, it is not required to match the circuit impedances at all frequencies to limit distortion. An ideal input transformer of fixed ratio will tend to cause the vacuum tube to deliver uniform power over a range of frequency but only throughout that part of the frequency range in which it can maintain constant voltage across the grid-filament impedance.

The receiving end circuit impedance  $Z_2$  is usually larger than  $Z_1$ . The equivalent unity ratio circuit and the equivalent  $T$  network of the equivalent unity ratio transformer are, therefore, obtained by dividing  $S$  and  $Z_2$  by  $R$  and  $M$  by  $\sqrt{R}$  instead of multiplying as in Figure 5. Such an equivalent unity ratio circuit is shown in Figure 11.

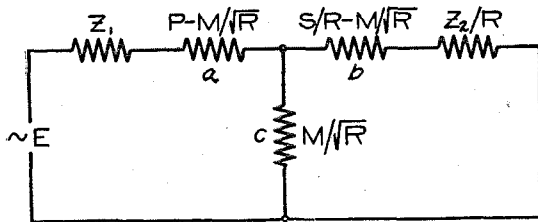

Figure 11

In considering the losses introduced in the circuit by the input transformer it is not convenient to compare the received current through the actual transformer with that of the ideal transformer of either variable or fixed ratio as neither ideal transformer delivers uniform input voltage to the vacuum tube at all frequencies or causes the amplifier to deliver uniform power. A more satisfactory basis of comparison, particularly for input transformers of different ratios which are intended for the same circuit conditions, is obtained by comparing the ratio of the potential produced across the grid-filament impedance  $Z_2$  (see Figure 3) to the potential  $E$  impressed on the circuit. This ratio gives the amount of effective amplification produced in the amplifier by the input transformer.

The losses of the input transformer have the same general frequency variations as the losses of the transformer operating into an ordinary negative reactance except that at the first

resonance frequency the losses produced by the mutual impedance  $M / \sqrt{R}$  of the input transformer may be zero but never negative. It is to be noted that the d-c. resistance of the secondary produces zero loss at zero frequency while the loss due to the d-c. resistance of the primary is finite.

Input transformers designed for audio frequencies operate into the high negative reactance of the vacuum tube and therefore the secondary and mutual impedances are necessarily of large magnitude. The capacity of the transformer windings under these conditions becomes of considerable importance and even when limited by careful design usually causes parallel resonance in the arm  $c$  of the transformer network in the transmitted frequency range. The same is the case with input transformers designed for carrier frequency operation although the impedances involved are usually not so large. Above this resonant frequency both the arm  $c$  and the impedance  $Z_2/R$  are negative reactances and their impedances tend to be annulled by the leakage reactance of the arms  $a$  and  $b$ . The combined effect of the leakage reactances of these arms produces resonance with the transformer and tube capacities which may increase the transformer amplification characteristic even above the value given by the ratio of secondary to primary turns.

Amplification characteristics produced by transformers of different ratio operating from a sending end impedance of 20,000 ohms into a 216-A vacuum tube are shown in Figure 12. It will be noted that as the impedance ratio of the transformer is lowered, the amplification characteristic flattens out and the frequency distortion is reduced. In the characteristics of some of the lower ratio transformers, a gain in amplification above the ratio of turns of the transformer may be noted at the higher frequencies.

It is to be noted that in the circuit of Figure 11,  $a$  and  $b$  are positive reactances while at the high frequencies  $c$  and  $Z_2/R$  are negative reactances and the circuit approximates a low pass filter. As a filter, it has a cut-off frequency above which it tends to limit transmission and the amplification characteristic falls off quite rapidly.

The d-c. resistance of the primary is of more importance than the d-c. resistance of the secondary. In the well-proportioned input transformer, the value of the arm *c* particularly at the resonance frequency becomes very large as

For an audio-frequency input transformer of a given ratio, the losses or the departure from full amplification depend at low frequencies, principally on the value of the mutual impedance, while at high frequencies the effective

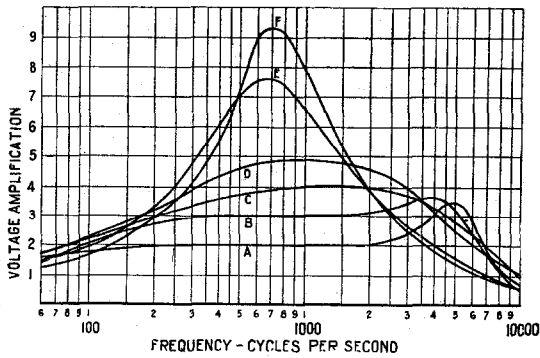

Figure 12—Voltage Amplification Characteristics of Input Transformers of Various Turns Ratios Operating from 20,000 Ohms Resistance into a 216-A Vacuum Tube

Coils	Turns Ratio
A	1:2
B	1:3
C	1:4
D	1:5
E	1:8
F	1:10

compared with the sum of the impedance  $Z_1$  and the impedance of the arm *a* and at these frequencies the transformer gives practically the amplification represented by the ratio of secondary to primary turns. However, at the lower frequency range, where the impedance of the arm *c* becomes more nearly equal to the sum of the impedances of  $Z_1$  and the arm *a*, the d-c. resistance of the primary produces a loss in amplification. The d-c. resistance of the primary is, therefore, a factor in the distortion at the lower frequencies.

For the rapid analysis of an input transformer, it is customary to consider the d-c. resistance of *P* as added directly to  $Z_1$  to form  $Z_0$ ; to consider the total leakage reactance,  $+jX_L$ , located entirely in the arm *a*; to neglect the d-c. resistance of *S*; to combine the capacity of the vacuum tube and effective capacity of the transformer as determined as located across *S* to form the reactance  $-jX_c$  and to consider the mutual impedance *M* as the impedance due to the transformer windings exclusive of capacity. Such a circuit as shown in Figure 13, approximates the actual circuit conditions quite closely in the ordinary case and is useful in design work.

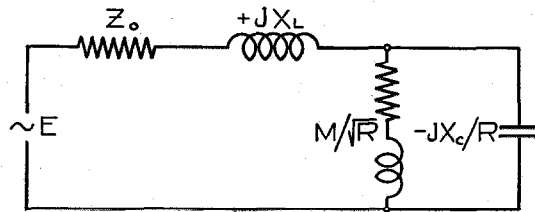

Figure 13

capacity of the tube plus that of the transformer has a considerable influence. As the mutual impedance is a function of the number of turns, while the capacity is practically independent of the number of turns, it follows that, in general, for an input transformer operating over a wide band of frequencies, the higher the mutual impedance, the wider will be the transmitted frequency band.

Figure 14 shows the variation in amplification

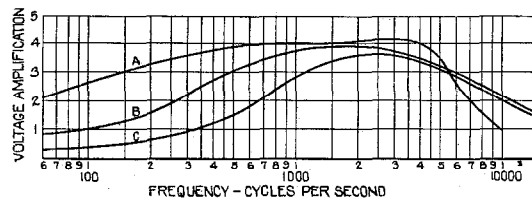

Figure 14—Voltage Amplification of Input Transformers of Different Mutual Impedances

Impedance ratio of 1:16 and operating from 15,000 ohms resistance into a 216-A vacuum tube

Transformer	Ratio $\frac{M \sqrt{R}}{15,000}$ at 1000 cycles
A	1:1
B	1:4
C	1:10

obtained with input transformers of the same ratio but of different mutual impedances operating between a resistance of 15,000 ohms and a 216-A vacuum tube. It will be noted that as the mutual impedance is increased the width of the transmitted frequency band is increased and the mid-band frequency is lowered. The upper slope of the frequency characteristic is determined principally by the leakage reactance of the transformer and the transformer and vacuum tube capacities. In transformer *C* the leakage reactance is so proportioned that resonance with

this capacity extends the flat portion of the amplification characteristic upward in the frequency range. The lower slope of the characteristic is determined principally by the mutual impedance of the transformer.

This advantage of high mutual impedance explains the use of No. 40 and No. 44 A. w. g. enameled wire for the secondaries in most audio frequency input transformers, as giving the highest impedance secondary windings that can be commercially applied with different methods of winding. With the gage of wire and the secondary impedance thus determined, the possible amplification characteristic will depend on the transformer ratio. With a number of predetermined characteristics of different ratio transformers prepared as shown in Figure 12, the required windings for the input transformer may be determined to give a desirable compromise between the amplification and the transmission distortion permissible.

From the standpoint of minimum distortion, it should be mentioned that it is desirable to use vacuum tubes of low plate-filament impedance in the amplifier, particularly if this can be done without sacrificing the tube amplification factor. The effect on the input transformer characteristic of operating it from tubes of different plate circuit impedance is shown in Figure 15.

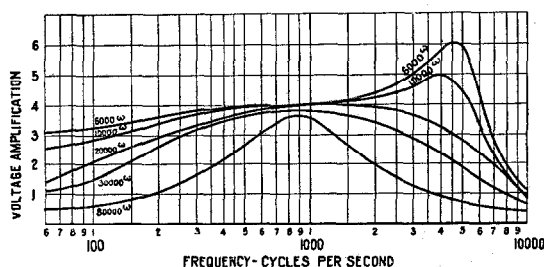

Figure 15—Voltage Amplification Characteristics of an Input Transformer of Impedance Ratio 1:16 Operating from Various Resistances into a 216-A Vacuum Tube

In the earlier telephone repeaters,<sup>6</sup> a resistance was shunted across the secondary of the input transformer and the grid-filament impedance of the vacuum tube. This resistance was of sufficiently low magnitude to determine the impedance into which the input transformer operated and the transformer was given the

<sup>6</sup> Gherardi and Jewett: "Telephone Repeaters," TRANS. A. I. E. E., Vol. XXXVIII, part 2, page 1287.

proper impedance ratio to match this impedance with the impedance from which the transformer was operated. This resistance served to aid in obtaining a flat amplification characteristic and to fix the impedance measured on the primary of the transformer with the secondary connected in circuit. An impedance characteristic was produced as shown in Figure 4 instead of the characteristic of the type shown in Figure 2, which represents simply a transformer with appreciable effective capacity in the windings. Later on an improvement was made by shunting the primary of the input transformer with a

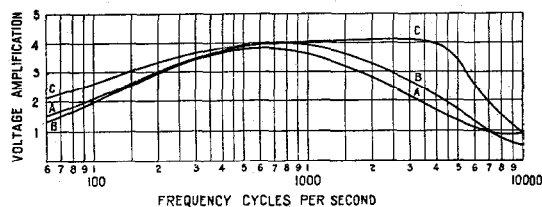

Figure 16—Voltage Amplification of Input Transformers Under Different Circuit Conditions

Curve	Transformer Impedance Ratio	Resistance Across Low Side	Resistance Across High Side
A	1:64	$\infty$	$64 \times 15,000$
B	1:64	15,000	$\infty$
C	1:16	$\infty$	$\infty$

resistance of a value equal to the resistance formerly used across the secondary divided by the transformer impedance ratio. It will be noted that in the first case, the transformer operates into a circuit which is principally a resistance while in the second case, it operates into a capacity. Measured amplification characteristics of an input transformer operating under both circuit conditions are shown in Figure 16 which gives, in addition, the characteristic of an input transformer of the same size and construction designed to give the same value of amplification as in the first two cases but without the shunting resistance. The superiority of the latter type of circuit in giving a uniform amplification characteristic is easily seen. This last circuit connection does not have an input impedance characteristic which is practically independent of frequency and it is, therefore, more limited in its uses.

#### TRANSFORMER CONSTRUCTION

The type of transformer most used in the telephone plant is a toroidal core transformer

The d-c. resistance of the primary is of more importance than the d-c. resistance of the secondary. In the well-proportioned input transformer, the value of the arm *c* particularly at the resonance frequency becomes very large as

For an audio-frequency input transformer of a given ratio, the losses or the departure from full amplification, depend at low frequencies, principally on the value of the mutual impedance; while at high frequencies the effective

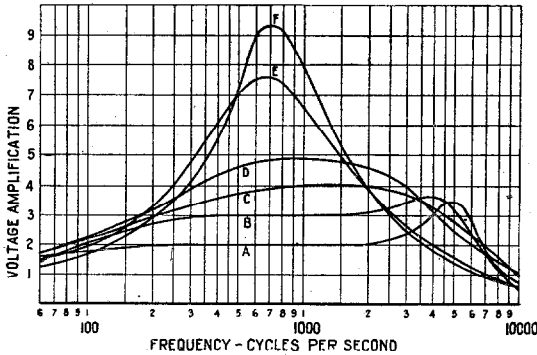

Figure 12—Voltage Amplification Characteristics of Input Transformers of Various Turns Ratios Operating from 20,000 Ohms Resistance into a 216-A Vacuum Tube

Coils	Turns Ratio
A	1:2
B	1:3
C	1:4
D	1:5
E	1:8
F	1:10

compared with the sum of the impedance  $Z_1$  and the impedance of the arm *a* and at these frequencies the transformer gives practically the amplification represented by the ratio of secondary to primary turns. However, at the lower frequency range, where the impedance of the arm *c* becomes more nearly equal to the sum of the impedances of  $Z_1$  and the arm *a*, the d-c. resistance of the primary produces a loss in amplification. The d-c. resistance of the primary is, therefore, a factor in the distortion at the lower frequencies.

For the rapid analysis of an input transformer, it is customary to consider the d-c. resistance of *P* as added directly to  $Z_1$  to form  $Z_0$ ; to consider the total leakage reactance,  $+jX_1$ , located entirely in the arm *a*; to neglect the d-c. resistance of *S*; to combine the capacity of the vacuum tube and effective capacity of the transformer as determined as located across *S* to form the reactance  $-jX_c$  and to consider the mutual impedance *M* as the impedance due to the transformer windings exclusive of capacity. Such a circuit as shown in Figure 13, approximates the actual circuit conditions quite closely in the ordinary case and is useful in design work.

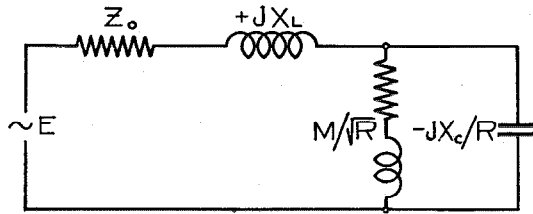

Figure 13

capacity of the tube plus that of the transformer has a considerable influence. As the mutual impedance is a function of the number of turns, while the capacity is practically independent of the number of turns, it follows that, in general, for an input transformer operating over a wide band of frequencies, the higher the mutual impedance, the wider will be the transmitted frequency band.

Figure 14 shows the variation in amplification

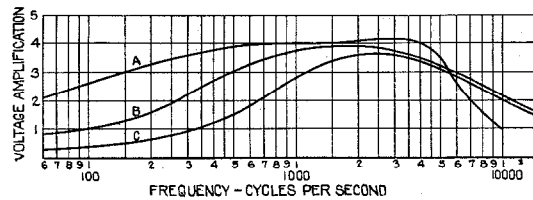

Figure 14—Voltage Amplification of Input Transformers of Different Mutual Impedances

Impedance ratio of 1:16 and operating from 15,000 ohms resistance into a 216-A vacuum tube

Transformer	Ratio $\frac{M \sqrt{R}}{15,000}$ at 1000 cycles
A	1:1
B	1:4
C	1:10

obtained with input transformers of the same ratio but of different mutual impedances operating between a resistance of 15,000 ohms and a 216-A vacuum tube. It will be noted that as the mutual impedance is increased the width of the transmitted frequency band is increased and the mid-band frequency is lowered. The upper slope of the frequency characteristic is determined principally by the leakage reactance of the transformer and the transformer and vacuum tube capacities. In transformer C the leakage reactance is so proportioned that resonance with

this capacity extends the flat portion of the amplification characteristic upward in the frequency range. The lower slope of the characteristic is determined principally by the mutual impedance of the transformer.

This advantage of high mutual impedance explains the use of No. 40 and No. 44 A. w. g. enameled wire for the secondaries in most audio frequency input transformers, as giving the highest impedance secondary windings that can be commercially applied with different methods of winding. With the gage of wire and the secondary impedance thus determined, the possible amplification characteristic will depend on the transformer ratio. With a number of predetermined characteristics of different ratio transformers prepared as shown in Figure 12, the required windings for the input transformer may be determined to give a desirable compromise between the amplification and the transmission distortion permissible.

From the standpoint of minimum distortion, it should be mentioned that it is desirable to use vacuum tubes of low plate-filament impedance in the amplifier, particularly if this can be done without sacrificing the tube amplification factor. The effect on the input transformer characteristic of operating it from tubes of different plate circuit impedance is shown in Figure 15.

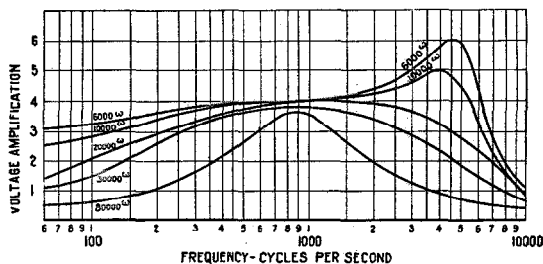

Figure 15—Voltage Amplification Characteristics of an Input Transformer of Impedance Ratio 1:16 Operating from Various Resistances into a 216-A Vacuum Tube

In the earlier telephone repeaters,<sup>6</sup> a resistance was shunted across the secondary of the input transformer and the grid-filament impedance of the vacuum tube. This resistance was of sufficiently low magnitude to determine the impedance into which the input transformer operated and the transformer was given the

<sup>6</sup> Gherardi and Jewett: "Telephone Repeaters," TRANS. A. I. E. E., Vol. XXXVIII, part 2, page 1287.

proper impedance ratio to match this impedance with the impedance from which the transformer was operated. This resistance served to aid in obtaining a flat amplification characteristic and to fix the impedance measured on the primary of the transformer with the secondary connected in circuit. An impedance characteristic was produced as shown in Figure 4 instead of the characteristic of the type shown in Figure 2, which represents simply a transformer with appreciable effective capacity in the windings. Later on an improvement was made by shunting the primary of the input transformer with a

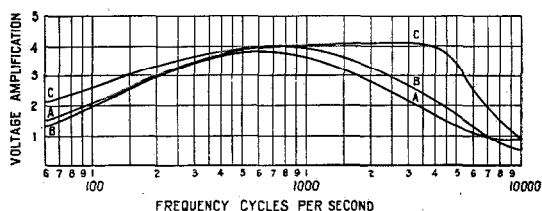

Figure 16—Voltage Amplification of Input Transformers Under Different Circuit Conditions

Curve	Transformer Impedance Ratio	Resistance Across Low Side	Resistance Across High Side
A	1:64	$\infty$	$64 \times 15,000$
B	1:64	15,000	$\infty$
C	1:16	$\infty$	$\infty$

resistance of a value equal to the resistance formerly used across the secondary divided by the transformer impedance ratio. It will be noted that in the first case, the transformer operates into a circuit which is principally a resistance while in the second case, it operates into a capacity. Measured amplification characteristics of an input transformer operating under both circuit conditions are shown in Figure 16 which gives, in addition, the characteristic of an input transformer of the same size and construction designed to give the same value of amplification as in the first two cases but without the shunting resistance. The superiority of the latter type of circuit in giving a uniform amplification characteristic is easily seen. This last circuit connection does not have an input impedance characteristic which is practically independent of frequency and it is, therefore, more limited in its uses.

### TRANSFORMER CONSTRUCTION

The type of transformer most used in the telephone plant is a toroidal core transformer

usually called a repeating coil. This type of transformer has a ring-shaped core of soft magnetic iron wire or silicon steel laminations completely covered with the primary winding over which is applied the secondary winding. Such a transformer, when the dimensions are properly proportioned and the winding is applied

removed from the front coil to show the construction.

The telephone induction coil used in all subscribers sets is an open magnetic circuit core type transformer. The impedance and frequency requirements of the circuit in which this form of transformer is used are not severe and the

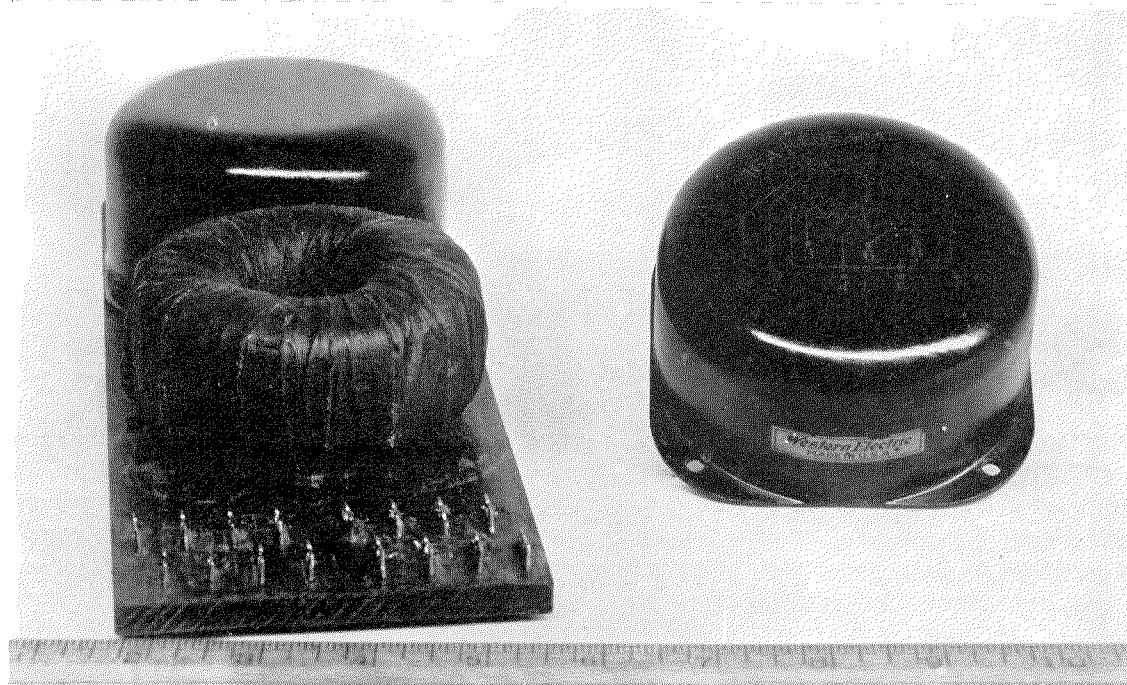

Figure 17—Toroidal Repeating Coil

so as practically to fill the central hole in the core, is a very efficient structure. The symmetrical distribution of winding limits the stray field, thus preventing cross-talk trouble in neighboring circuits. The cost of winding has been reduced to a low value by the development of a winding machine in which a circular shuttle threading through the center of the core is used to hold the wire which is wound on the core by a motor-driven annular part of the machine. The windings are accessible and permit of easy adjustment. This type of transformer is used in telephone installations where the impedances of the circuits in which the transformer is operated are less than 20,000 ohms and where the frequency is relatively low. The usual type of mounting of two repeating coils on a common base is shown in Figure 17. The case has been

value of the transmission is relatively low due to the fact that any one transformer is used a relatively small part of the time and only for conversations from a single station. This, together with the fact that the transformer must be designed to operate with direct current through the windings and stray magnetic field is of no particular disadvantage permits the use of this relatively inefficient type of transformer shown in Figure 18. It is to be noted that in this transformer the winding is located about the center portion of the core only as in this location the highest ratio of inductance to d-c. resistance is obtained giving maximum efficiency.

For portable test sets, considerably lighter and smaller types of transformer than are generally used in the telephone plant are required. Trans-

former *A* of Figure 19 shows the type of transformer used in sets such as the S. C. R. 72 amplifier developed for the Signal Corps of the United States Army. This amplifier set was intended to operate on 1000-cycle telegraph

The type of transformer shown as *B* in Figure 19 is also of shell type construction and is used in portable telephone field test sets and weighs 12 ounces.

One of the latest designs of shell type trans-

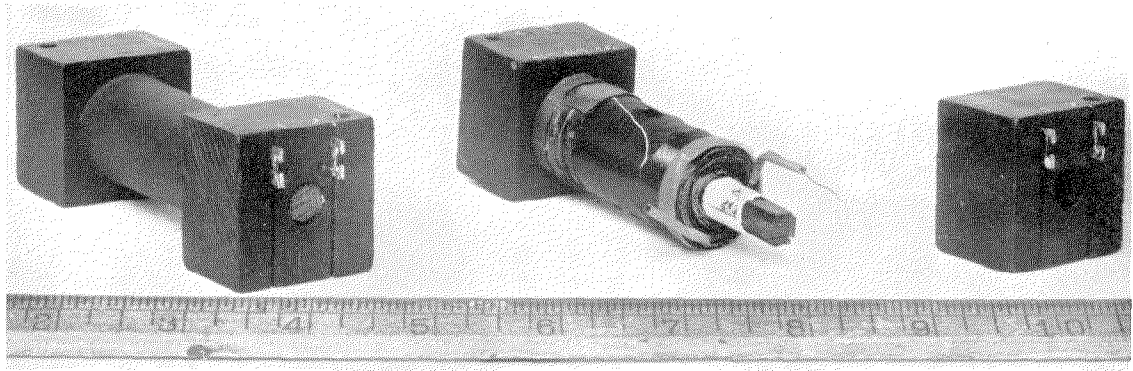

Figure 18—Telephone Induction Coil

signals transmitted through the ground. The transformers used in this set were required to operate efficiently only in the neighborhood of 1000 cycles and transmission at other frequencies was sacrificed to obtain maximum amplification at this frequency. An amplification characteristic of the input transformer of this set is given in Figure 20. This type of transformer was widely used in both Signal Corps and Navy radio transmitting and receiving sets throughout the war and weighed about two pounds.

former and the one which was used for most of the experimental characteristics given herein is shown in Figure 21. The construction of this input transformer, the No. 224 type, is such that winding and assembly can be readily accomplished and repair easily effected if necessary. The winding space and the core have been proportioned to obtain minimum cost of manufacture. The core consists of *I* and *E* shape laminations riveted together to form an *I* and *E* part which butt together forming the core.

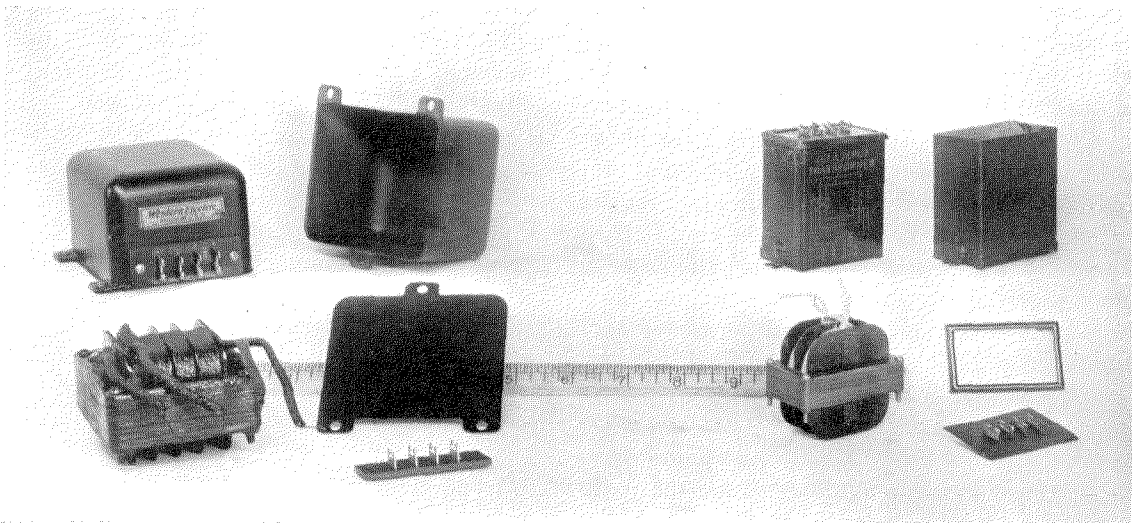

Figure 19—Shell Type Transformers

The winding is placed on a spool which fits over the central limb of the *E*. The two core parts are held together by means of two brackets which are held in place by four machine screws. The terminals are arranged on insulated mount-

transformer having spool windings as it permits the use of a winding of small effective capacity.

The size of the transformer is governed by three factors, the amount of space available, the cost permissible and the ratio of inductance d-c. resistance which is required to give the desired freedom from transmission loss.

In the windings of telephone transformers, cotton or cotton and enamel is used for the insulation of the heavier gages of wire while for the smaller gages, enamel or enamel and silk is used. The gage sizes used range from No. 18 A. w. g. or heavier to No. 44. In input transformers, the d-c. resistance of the secondary winding usually causes an inappreciable loss and it is, therefore, desirable to have it take up as little space as possible and the smallest size of wire which can be used with the different commercial methods of winding is employed. The quality of the enamel insulation generally used for this

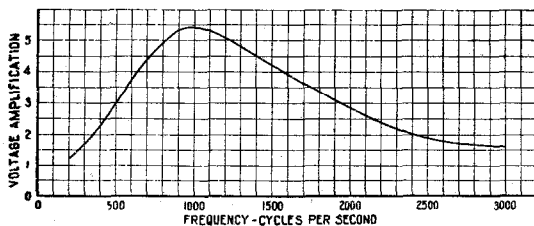
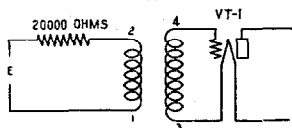

Figure 20—Amplification Characteristic, 201-A Input Transformer

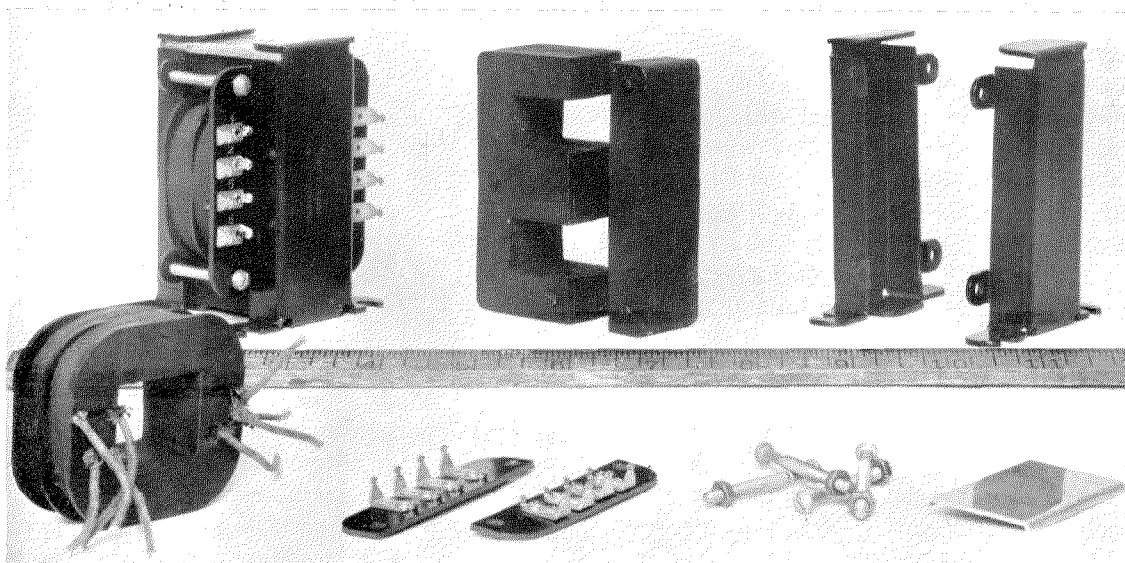

Figure 21—224-Type Input Transformer

ing plates held under the screws of the mounting bracket and serving as mechanical protection to the lead wires.

It may be noted that whereas the form of toroidal repeating coils is core type, that of the transformers employing spool windings is shell type. The core type is used for the toroidal repeating coils as it permits ready adjustment of the windings and the shell type is used in the

winding is a determining factor in the minimum size of winding which can be used. With the best enamel, it is possible to wind No. 40 A. w. g. wire with little or no interleaving paper and with little special machinery, and have the resulting windings reasonably free from short circuits. However, with inferior enamel, it is necessary to use a covering of silk in addition to the enamel, or to use interleaving paper between each two



layers of the winding. This extra insulation, needless to say, causes a considerable increase in the space taken up by the winding, which is undesirable.

In transformers in which the effective capacity is an important factor, it is frequently necessary to apply the winding in such a way as to reduce the capacity to a minimum. The effective capacity depends on the size of the transformer winding, more care being required to reduce it to a reasonable value in a large than in a small transformer. The capacity of the winding may be conveniently considered as composed of four parts, part one being the sum of the capacities between each two adjacent turns all connected in series from one terminal of the winding to the other, part two the sum of the capacities between adjacent layers in series, part three the capacities between adjacent winding sections in series and part four due to the capacities between the winding and any other metal or other windings in the neighborhood. These capacities may be considered in effective values as connected across the winding terminals. Of these component capacities, the first may usually be neglected entirely, as it consists of a large number of small capacities in series, this number being only slightly less than the total number of turns. The fourth part is usually the most important as it seldom consists of more than two capacities in series. The second and third parts of the effective capacity are of importance depending on the number of sections and layers and the capacity between adjacent ones. In high ratio transformers, it is usually sufficiently accurate to consider the lower impedance winding as an equi-potential plate and to consider the capacities with regard to the high impedance winding only.

The effect of inter-winding capacities in affecting transmission is given in Figure 22. This figure shows how sometimes these capacities may be connected between approximately equal potential points in the circuit and thus lessen the effective capacity of the winding. The transformer on which these characteristics were taken is the same as that shown in Figures 19 and 20. Characteristic *A* represents the normal connection of windings with the interwinding capacity *C* located between the parts of the circuit *a* and *e* in which it is effectively across

one half the impedance of the primary, 1-2. Characteristic *B* shows the amplification obtained with the secondary winding, 3-4, reversed, terminal 3 being connected to the grid of the vacuum tube instead of the filament. In this case the capacity *C* is across the entire secondary impedance in addition to one-half the primary impedance, the combined impedance being approximately 200 times the impedance under

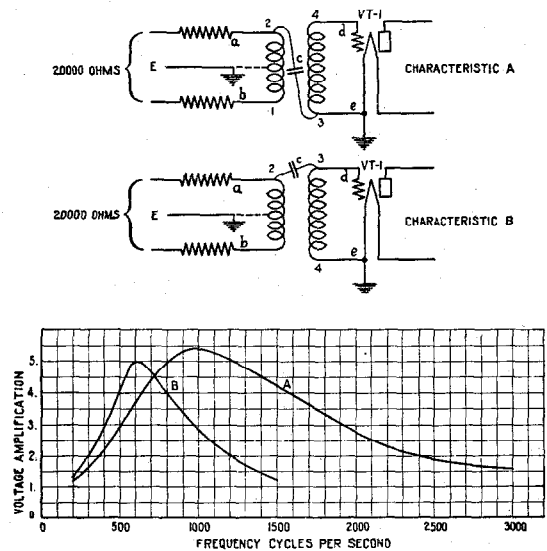

Figure 22—Transformer Amplification Characteristics with Different Winding Connections

the circuit connection *A*. The effect of this inter-winding capacity being connected across points of widely different potential in the circuit in lowering the frequency of the amplification peak is clearly shown.

Transformers are subjected in service to conditions of temperature and humidity which vary greatly. Conditions in exchanges in the tropics and in certain sets for outdoor use are particularly severe while in some other locations there is but little chance of trouble. Under conditions of humidity electrolytic corrosion will take place provided salts which might form an electrolyte on the addition of moisture are present in the completed windings. Corrosion will be accelerated in circuits in which there is a direct-current potential between some point in the winding and another neighboring metallic part. It frequently causes the windings of the transformer to open-circuit particularly when

they are wound with the smaller gages of wire. It is rather difficult to obtain materials which are free from slight amounts of salts and to keep the transformer winding free from them during the operations incident to manufacture. Perspiration from the operator's hands or the use of soldering salts are common causes of corrosion. To reduce this trouble the windings are imbedded in a moisture resisting compound of oils or waxes which is in itself chemically inert. The moisture-proofing process is usually effected under vacuum after a baking period. The advantages of a carefully worked out moisture-proofing treatment in prolonging the useful life of transformers is so great that it has been universally

adopted in all carefully designed transformers. In the foregoing, the transformer has been treated from the standpoint of the transmission of telephone currents and those features have been presented which appeared to the writer to be of special interest and usefulness to those interested in its application to this problem. In conclusion, the writer wishes to acknowledge his indebtedness to Mr. Thomas Shaw of the American Telephone and Telegraph Company and to Mr. K. S. Johnson of the Western Electric Company, Inc., with whom he has been associated for a number of years on the general problem of telephone transmission and in the application of the principles described herein.

---

---

---

# *International Western Electric Company*

INCORPORATED

*Head Offices*

195 BROADWAY  
NEW YORK, U. S. A.

*European General Offices*

CONNAUGHT HOUSE  
ALDWYCH, LONDON, ENGLAND

## *Affiliated Companies*

- Western Electric Company, Limited ..... *Aldwych, London, England*  
Branches: Birmingham, Cardiff, Glasgow, Leeds, Manchester, Newcastle-on-Tyne, Dublin, Cairo, Johannesburg, Singapore.
- Bell Telephone Manufacturing Company ..... *Antwerp, Belgium*  
Branches: Bernc, The Hague, Brussels, Riga, Reval.
- Le Materiel Telephonique ..... *Paris, France*
- Telefonos Bell, S. A. .... *Madrid, Spain*
- Western Electric Italiana ..... *Milan, Italy*  
Branches: Rome.
- Western Electric Norsk Aktieselskap ..... *Christiania, Norway*
- Vereinigte Telephon und Telegraphen Fabrik ..... *Vienna, Austria*
- United Incandescent Lamps and Electrical Company, Limited  
*Budapest (Ujpest), Hungary*
- Western Electric Company (Australia) Limited ..... *Sydney, Australia*  
Branches: Melbourne, Wellington.
- Nippon Denki Kabushiki Kaisha ..... *Tokyo, Japan*  
Branches: Osaka, Dalny (Manchuria), Seoul (Chosen)
- Sumitomo Electric Wire & Cable Works, Ltd. .... *Osaka, Japan*
- China Electric Company, Limited ..... *Peking, China*  
Branches: Shanghai, Tientsin
- Northern Electric Company, Limited ..... *Montreal, Canada*  
Branches: Quebec, Halifax, Toronto, London (Ontario), Hamilton, Windsor, Winnipeg, Calgary, Regina, Vancouver
- Compania Western Electric Argentina ..... *Buenos Aires, Argentina*
- International Western Electric Company ..... *Rio de Janeiro, Brazil*

Sales Offices and Agencies Throughout the World

To those interested in better communication the International Western Electric Company and its Affiliated Companies offer the facilities of their consulting engineering departments to aid in the solution of problems in Telephony, Telegraphy and Radio.